

Technical Information

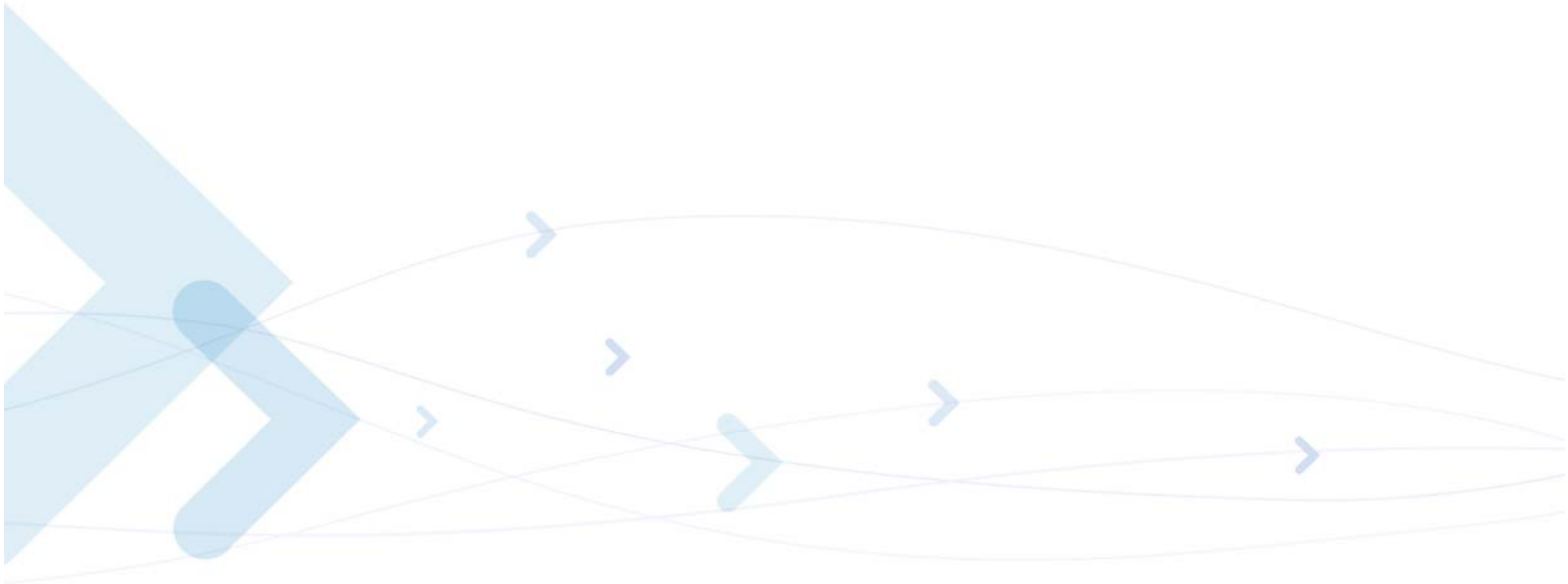

Motorola G24-L and G24-LC Developer's Guide

AT Commands Reference Manual

SPECIFICATIONS SUBJECT TO CHANGE WITHOUT NOTICE

Notice

While reasonable efforts have been made to assure the accuracy of this document, Motorola, Inc. assumes no liability resulting from any inaccuracies or omissions in this document, or from use of the information obtained herein. The information in this document has been carefully checked and is believed to be entirely reliable. However, no responsibility is assumed for inaccuracies or omissions. Motorola, Inc. reserves the right to make changes to any products described herein and reserves the right to revise this document and to make changes from time to time in content hereof with no obligation to notify any person of revisions or changes. Motorola, Inc. does not assume any liability arising out of the application or use of any product, software, or circuit described herein; neither does it convey license under its patent rights or the rights of others.

It is possible that this publication may contain references to, or information about Motorola products (machines and programs), programming, or services that are not announced in your country. Such references or information must not be construed to mean that Motorola intends to announce such Motorola products, programming, or services in your country.

Copyrights

This instruction manual, and the Motorola products described in this instruction manual may be, include or describe copyrighted Motorola material, such as computer programs stored in semiconductor memories or other media. Laws in the United States and other countries preserve for Motorola and its licensors certain exclusive rights for copyrighted material, including the exclusive right to copy, reproduce in any form, distribute and make derivative works of the copyrighted material. Accordingly, any copyrighted material of Motorola and its licensors contained herein or in the Motorola products described in this instruction manual may not be copied, reproduced, distributed, merged or modified in any manner without the express written permission of Motorola. Furthermore, the purchase of Motorola products shall not be deemed to grant either directly or by implication, estoppel, or otherwise, any license under the copyrights, patents or patent applications of Motorola, as arises by operation of law in the sale of a product.

Computer Software Copyrights

The Motorola and 3rd Party supplied Software (SW) products described in this instruction manual may include copyrighted Motorola and other 3rd Party supplied computer programs stored in semiconductor memories or other media. Laws in the United States and other countries preserve for Motorola and other 3rd Party supplied SW certain exclusive rights for copyrighted computer programs, including the exclusive right to copy or reproduce in any form the copyrighted computer program. Accordingly, any copyrighted Motorola or other 3rd Party supplied SW computer programs contained in the Motorola products described in this instruction manual may not be copied (reverse engineered) or reproduced in any manner without the express written permission of Motorola or the 3rd Party SW supplier. Furthermore, the purchase of Motorola products shall not be deemed to grant either directly or by implication, estoppel, or otherwise, any license under the copyrights, patents or patent applications of Motorola or other 3rd Party supplied SW, except for the normal non-exclusive, royalty free license to use that arises by operation of law in the sale of a product.

VENDOR COPYRIGHT

Apache Software Foundation - Copyright 2004-2005 All Rights Reserved

Usage and Disclosure Restrictions

License Agreements

The software described in this document is the property of Motorola, Inc. and its licensors. It is furnished by express license agreement only and may be used only in accordance with the terms of such an agreement.

Copyrighted Materials

Software and documentation are copyrighted materials. Making unauthorized copies is prohibited by law. No part of the software or documentation may be reproduced, transmitted, transcribed, stored in a retrieval system, or translated into any language or computer language, in any form or by any means, without prior written permission of Motorola, Inc.

High Risk Materials

Components, units, or third-party products used in the product described herein are NOT fault-tolerant and are NOT designed, manufactured, or intended for use as on-line control equipment in the following hazardous environments requiring fail-safe controls: the operation of Nuclear Facilities, Aircraft Navigation or Aircraft Communication Systems, Air Traffic Control, Life Support, or Weapons Systems (High Risk Activities"). Motorola and its supplier(s) specifically disclaim any expressed or implied warranty of fitness for such High Risk Activities.

Trademarks



MOTOROLA and the Stylized M Logo are registered in the US Patent & Trademark Office. All other product or service names are the property of their respective owners.

©Copyright 2007 Motorola, Inc.

REV052604

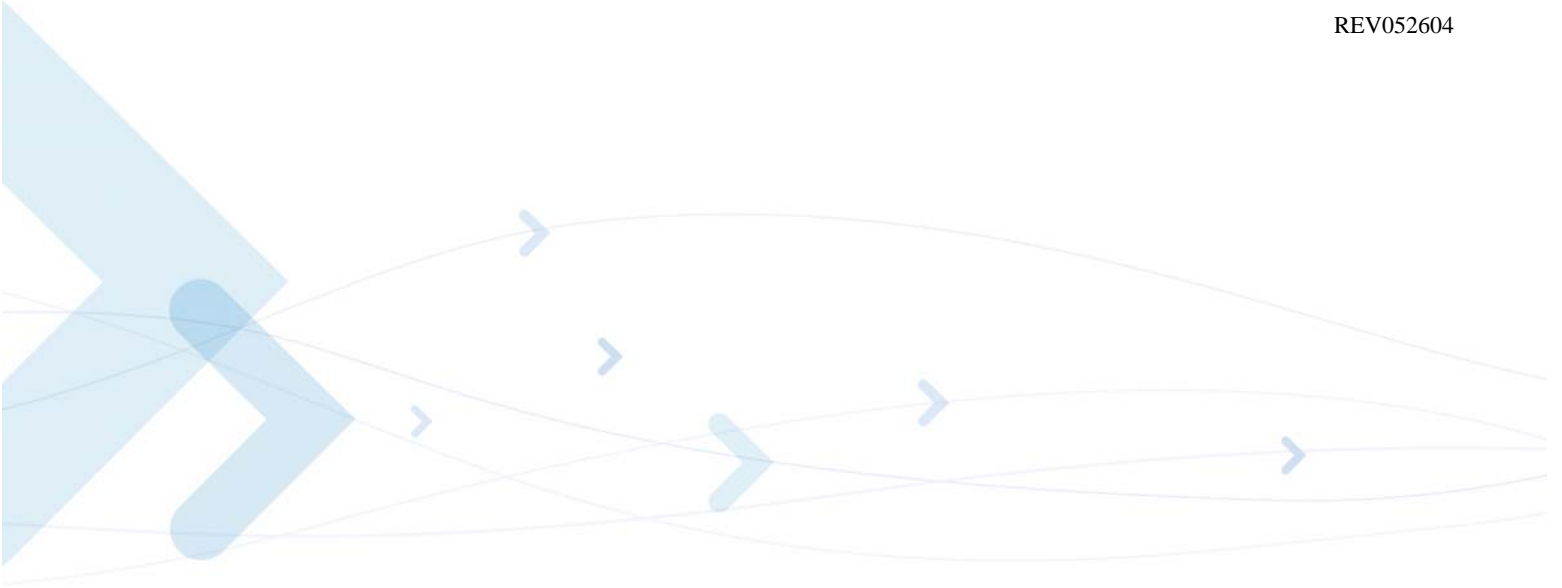

Manual Scope	xvii
Target Audience	xvii
Manual Organization	xvii
Applicable Documents	xviii
Contact Us	xviii
Text Conventions	xviii
Manual Banner Definitionsxix
Field Servicexix
General Safetyxix
Caring for the Environmentxxi
Limitation of Liabilityxxii
Warranty Notificationxxiii
How to Get Warranty Service?xxiii
Claimingxxiv
Conditionsxxiv
What is Not Covered by the Warrantyxxv
Installed Dataxxv
Out of Warranty Repairsxxv
Revision Historyxxvi
Chapter 1: Product Features	1-1
Connectivity Interface	1-1
GPRS Operation	1-1
Overview	1-1
Features and Benefits	1-1
Technical Description (GPRS – Class B Operation)	1-1
CSD Operation	1-2
Overview	1-2
Features and Benefits	1-2
Technical Description	1-2
Improved OEM Features	1-3
SIM Application Toolkit (STK)	1-3
Overview	1-3
Features and Benefits	1-3
Technical Description	1-3
Profile Download	1-3
Data Transfer into the SIM	1-3
Set up Idle Mode Text	1-4
Menu Selection	1-4
Call Control by SIM	1-4

TCP/UDP IP Connection	1-5
Overview	1-5
TCP/IP	1-5
UDP/IP	1-6
Features and Benefits	1-7
Technical Description	1-8
Audio	1-8
Overview	1-8
Features and Benefits	1-8
Technical Description	1-9
Short Message Service (SMS)	1-11
Overview	1-11
Features	1-11
Technical Description	1-12
Character Sets	1-13
ASCII Character Set Management	1-13
GSM Character Set Management	1-13
UCS2 Character Set Management	1-13
UTF-8 Character Set Management	1-13
8859-1 Character Set Management	1-14
AT Commands Summary	1-15
Chapter 2: Introduction to AT Commands	2-1
AT Commands Overview	2-1
General Symbols Used in AT Commands Description	2-1
General System Abbreviations	2-2
AT Commands Protocol	2-2
AT Commands Structure	2-3
Command Structure	2-3
Results Code Structure	2-4
Response and Indications Structure	2-4
AT Commands Protocol & Structure Configuration	2-5
Command Token Types	2-6
Basic Syntax Command Format	2-6
S-parameters	2-6
Extended Syntax Command Format	2-6
Command Argument Types	2-7
Numeric Constants	2-7
String Constants	2-7
Command Mode Types	2-7
Parameter Set Command Syntax	2-7
Parameter Read Command Syntax	2-7
Parameter Test Command Syntax	2-7
Values	2-8
Range of Values	2-8
Compound Range of Values	2-8
Aborting Commands	2-8
Chapter 3: AT Commands Reference	3-1
Modem ID	3-1

Subscriber Unit Identity	3-1
+CGMI, +GMI, +FMI, Request Manufacturer ID	3-1
+CGMM, +GMM, +FMM, Request Model ID	3-2
+CGMR, +GMR, +FMR, Request Revision	3-3
+CGSN, +GSN, Request Product Serial Number Identification	3-3
+CSCS, Select Terminal Character Set	3-4
+CIMI, Request IMSI	3-5
+CFSN, Read Manufacturing Serial Number	3-5
I, Request Identification Information	3-6
+CNUM, Request MSISDN(s)	3-6
\$, List of All Available AT Commands	3-7
+CLAC, List of All Available AT Commands	3-8
Capability Reporting	3-8
Call Control	3-9
Managing a CSD (Data) Call	3-9
Simple Dialing	3-9
Switching From Data Mode to Command Mode	3-10
Hanging Up	3-10
Dialing to an Electronic Telephone Service	3-10
Receiving a Data Call	3-10
Call Control AT Commands	3-11
D, Dial Command	3-11
D>, Direct Dialing from Phone Books	3-12
DL, Dial Last Number	3-14
H, Hang-up Call	3-15
A, Answer Incoming Call	3-17
+CRC, Cellular Result Codes and RING, +CRING - Incoming Call Indication	3-17
+CLIP, Calling Line Identification	3-19
+CCWA, Call Waiting Command	3-21
+CHLD, Call Related Supplementary Services Command	3-23
+CCFC, Call Forwarding Number and Conditions	3-27
+CLIR, Calling Line Identification Restriction	3-29
+CBST, Select Bearer Service Type	3-31
O, Return to Online Data State	3-33
&Q, Asynchronous Mode	3-33
+CHUP, Hang Up Call	3-34
+CSNS, Single Numbering Call Scheme	3-34
+MDC, Selection of Desired Message to Be Displayed Upon Connection of a Voice Call	3-36
+CTFR1, Divert an Incoming Call When User Busy	3-37
+MVC, Motorola Vocoders Configuration	3-38
Call Status Messages	3-39
+CPAS, Phone Activity Status	3-39
+CLCC, List Current Calls	3-40
+MCST, Call Status Messages	3-42
Call Advice of Charge Commands	3-44
+CAOC, Advice of Charge	3-44
+CACM, Accumulated Call Meter	3-46
+CAMM, Accumulated Call Meter Maximum	3-47
+CPUC, Price per Unit and Currency Table	3-48
+CR, Service Reporting Control	3-49

Supplementary Services	3-50
+CSSN, Supplementary Service Notifications	3-50
+CUSD, Unstructured Supplementary Service Data	3-53
+COLP, Connected Line Identification Presentation	3-56
+MTTY, Motorola TTY Configuration	3-57
Phone Books and Clock	3-60
Directory Access Commands	3-60
+CPBS, Select Phone Book Memory	3-60
+CPBR, Read Phone Book Entries	3-61
+CPBF, Find Phone Book Entries	3-63
+CPBW, Write Phone Book Entry	3-64
+CSVN, Set Voice Mail Server	3-66
+MDSI, Motorola Deactivate SIM Card Indication	3-67
+MCSN, Motorola Change Subscriber Number	3-69
System Date and Time Access Commands	3-73
+CCLK, Read/Set System Date and Time	3-73
SMS	3-75
SMS Commands	3-75
+CSMS, Select Message Service.	3-75
+CPMS, Preferred Message Storage	3-76
+CMGF, Message Format	3-77
+CSCA, Service Center Address	3-78
+CSMP, Set Text Mode Parameters.	3-79
+CSDH, Show Text Mode Parameters	3-81
+CNMI, New Message Indications to Terminal	3-82
+CNMA, New Message Acknowledgment	3-84
+CMTI, Unsolicited Response (New SMS-DELIVER Receipt Indication)	3-86
+CMT, Unsolicited Response (New SMS-DELIVER Receipt).	3-86
+CDSI, Unsolicited Response (New SMS-STATUS-REPORT Indication)	3-88
+CDS, Unsolicited Response (New SMS-STATUS-REPORT Receipt).	3-88
+CMGL, +MMGL, List Messages	3-89
+CMGR, +MMGR, Read Message	3-94
+MMAR, Motorola Mark As Read	3-101
+CMSS, Send Message From Storage	3-101
+CMGW, Write Message to Memory	3-103
+CMGD, Delete Message	3-108
+CGSMS, Select Service for MO SMS Messages.	3-109
+CMGS, Send SM to Network.	3-110
+MCSAT, Motorola Control SMS Alert Tone.	3-111
DCS handling	3-113
Network	3-117
Network Commands	3-117
+CSQ, Signal Strength	3-117
+CRLP, Radio Link Protocol	3-118
+CREG, Network Registration Status	3-119
+CGREG, GPRS Network Registration	3-121
+COPS, Operator Selection	3-122
+CPOL, Preferred Operators	3-125
+MFS, Motorola Frequency of Search	3-126
Hardware Information	3-129

Hardware Information Commands	3-129
+CBC, Battery Charger Connection	3-129
+MBC, Battery Charger	3-130
+CBAUD, Baud Rate Regulation	3-132
+IPR, Local Terminal/G24-L Serial Port Rate	3-133
+MTDTR, DTR Line Test Command	3-134
+MTCTS, CTS Line Test Command	3-135
&K, RTS/CTS Flow Control	3-135
&C, Circuit 109 Behavior	3-136
&D, Circuit 108 Behavior	3-138
+MCWAKE, GPRS Coverage	3-139
+MGGIND, GSM/GPRS Service Indicator	3-140
+CFUN, Shut Down Phone Functionality	3-141
+ICF, DTE-DCE Character Framing	3-142
ATS97, Antenna Diagnostic	3-143
+MRST, Perform Hard Reset	3-143
+MIOC, Motorola I/O Configure	3-144
+MIOD, Motorola I/O Define	3-147
+MMAD, Query and Monitor ADC Value	3-149
+MPCMC, Continuous PCM Clock	3-153
Audio	3-155
Scope	3-155
Audio Setup	3-156
Basic Audio Setup	3-157
Advanced Audio Setup	3-157
General Audio Commands	3-158
Basic Audio Setup Commands	3-158
+CRSL, Call Ringer Level	3-158
+CLVL, Loudspeaker Volume	3-159
+CMUT, Mute/Unmute Currently Active Microphone Path	3-160
S94, Sidetone Effect	3-161
S96, Echo Canceling	3-162
Advanced Audio Setup Commands	3-163
+MAPATH, Audio Path	3-163
+MAVOL, Volume Setting	3-166
+MAMUT, Input Devices Mute	3-168
+MAFEAT, Features Selection	3-169
General Audio Commands	3-170
+MADIGITAL, Analog/Digital Audio Switching	3-170
+CALM, Alert Sound Mode	3-171
+MMICG, Microphone Gain Value	3-172
+CRTT, Ring Type Selection	3-173
+VTD, Tone Duration	3-175
+VTS, Command-Specific Tone Duration	3-176
Access	3-177
Access Control Commands	3-177
A/, Repeat Last Command	3-177
AT, Check AT Communication	3-177
+CPIN, Enter PIN for Unlocking SIM Card or Enter PUK for Unblocking SIM Card	3-177
+EPIN, Enter SIM PIN2 to Verify PIN2 Indicator	3-181
+TPIN, Query Number of Remaining SIM PIN/PUK Entering Attempts	3-182
+CPWD, Change Password	3-183
+CLCK, Facility Lock	3-184
+EMPC, Unlocking or Locking Subsidy Code	3-187

Modem Configuration and Profile	3-190
Modem Register Commands	3-190
V, G24-L Response Format	3-190
Q, Result Code Suppression	3-191
E, Command Echo	3-192
X, Result Code Selection and Call Progress Monitoring Control	3-193
S, Bit Map Registers	3-194
\S, Show the Status of the Commands and S-registers in Effect	3-197
\G, Software Control	3-197
\J, Terminal Auto Rate	3-197
\N, Link Type	3-197
+CBAND, Change Radio Band	3-197
?, Return the Value of the Last Updated S-register	3-198
&F, Set to Factory Defined Configuration	3-198
Z, Reset to Default Configuration	3-199
Sleep Mode Commands	3-199
Sleep Mode AT Commands	3-200
Sleep Mode HW Signals	3-200
S24, Set Number of Seconds Delay Before G24-L Enters Sleep Mode	3-202
S102, Set Delay Before Sending Data to the Terminal	3-203
S100, Set Minimum Time for Terminal to Fall into Sleep Mode	3-204
+MSCTS, Enable/Disable CTS During Wakeup Period	3-205
Error Handling Commands	3-206
+CMEE, Report Mobile Equipment Error	3-206
+CEER, Extended Error Report	3-213
UI (User Interface)	3-216
+CRSM, Restricted SIM Access	3-216
&V, View Configuration	3-221
&W, Store User Profile	3-222
&Y, Default User Profile	3-224
+CMER, Mobile Equipment Event Reporting	3-225
+CLAN, ME Language	3-225
+CIND, Indicator Control	3-227
Unsolicited UI Status Messages	3-229
+CIEV, Indicator Event Reporting	3-229
GPRS	3-230
GPRS Functionality	3-230
GPRS Commands	3-230
+CGCLASS, GPRS Mobile Station Class	3-231
+CGDCONT, Define PDP Context	3-232
+CGQMIN, Quality of Service Profile (Min Acceptable)	3-234
+CGQREQ, Quality of Service Profile (Requested)	3-236
+CGATT, GPRS Attach or Detach	3-237
+CGPADDR, Show PDP Address	3-238
+MGEER, GPRS Extended Error Report	3-240
D*99, Request GPRS Service "D"	3-242
+CGPRS, GPRS Coverage	3-244
+CGACT, PDP Context Activate or Deactivate	3-245

STK	3-246
STK Mechanisms	3-247
+MTKR, Profile Download	3-247
+MTKE, Motorola ToolKit Enable	3-257
+MTKP, Motorola ToolKit Proactive (Unsolicited Indication)	3-258
+MTKM, Motorola ToolKit Menu	3-272
+MTKM, Motorola ToolKit Menu (Response)	3-273
+MTKC, Motorola ToolKit Call Control	3-274
+MTKA, Motorola Toolkit Acknowledge	3-274
TCP/IP	3-276
+MIPCALL, Create a Wireless Link	3-276
+MIPOPEN, Open a Socket (UDP or TCP)	3-277
+MIPODM, Open a Socket (UDP or TCP) in Online Data Mode	3-279
+MIPCLOSE, Close a Socket	3-282
+MIPSETS, Set Size for Automatic Push	3-283
+MIPSEND, Send Data	3-284
+MIPPUSH, Push Data into Protocol Stack	3-285
+MIPFLUSH, Flush Data from Buffers	3-286
+MIPRUDP, Receive Data from UDP Protocol Stack	3-287
+MIPRTCP, Receive Data from TCP Protocol Stack	3-287
+MIPSTAT, Status Report	3-288
MIPXOFF, Flow Control - Xoff	3-288
MIPXON, Flow Control - Xon	3-289
MIPCONF - Configure Internal TCP/IP stack	3-289
+MPING, Start Ping Execution (ICMP Protocol)	3-292
+MPINGSTAT, Status Update for +MPING Execution	3-296
+MSDNS, Set DNS IP Address	3-299
+MIPCFE, Control Filtering Feature for Incoming TCP Connection	3-301
NOP - Compatible	3-304
IGNORED (Compatible Only) Commands	3-304
Chapter 4: Using the Commands	4-1
Setting Up the G24-L (Power On and Initial Actions)	4-1
Recommended G24-L Initialization after Powerup	4-3
RS232 Lines Setup	4-4
Test G24-L Communication	4-5
Basic Configuration	4-5
SIM Card Status	4-7
G24-L Network Connection	4-8
Terminal Synchronization	4-9
SMS	4-10
Managing Stored Messages in the G24-L Memory	4-10
Setting the Notification Indication for Incoming Messages (Using AT+CNMI)	4-11
Another Possible Option for Setting the CNMI Notification Indication	4-11
Setting TEXT Mode Parameters (Using AT+CMGW and AT+CMGS)	4-11
Writing, Saving and Sending Messages (Using AT+CMGW and AT+CMSS)	4-12
Sending Messages (Using AT+CMGS)	4-13
Deleting Messages (Using AT+CMGD)	4-13
Call Control	4-14
Dialing Using ATD	4-14
Direct Dialing from Phone Book	4-15
Dialing the Last Number Example	4-16

Voice Call Manipulations	4-16
Call Waiting	4-16
Call Forwarding	4-16
Conference Call	4-17
Data Call	4-18
Switching Modes (Data Mode/Command Mode)	4-18
GPRS	4-19
Establishing GPRS PDP Context	4-19
Activating a Saved Profile in G24-L	4-19
Two Ways to Activate PDP Context	4-19
Changing the Character Set	4-21
Sleep Mode	4-22
STK	4-23
Display Text/Display Idle Mode Text	4-23
Get Inkey	4-23
Get Input	4-24
Play Tone	4-24
Set Up Menu	4-25
Select Item	4-25
Send SMS	4-25
Set Up Call	4-26
Call Control	4-26
Send DTMF	4-27
Launch Browser	4-27
Setup Event List	4-28
TCP/IP	4-29
TCP Data Transfer Example	4-29
Multi-point Data Transfer Example	4-29
Xoff and Xon Example	4-30
Error in Reopening a Valid Socket	4-31
Audio	4-32
Scenarios for Setting Up Handset Mode or Handsfree Mode	4-32
Handset Mode	4-32
Handsfree Mode	4-32
Chapter 5: Tools	5-1
Tools Overview	5-1
Appendix A: Reference Tables	A-1
AT Commands Alphabetical Summary	A-1
Character Set Table CS1: (GSM -> UCS-2)	A-17
Character Set Table CS2: (ASCII <-> UTF-8)	A-21
Character Set Table CS3: (UCS-2 <-> UTF-8)	A-21
Character Set Table CS6: (UCS-2 Full table)	A-21
Character Set Table CS7: (ASCII table)	A-22

1-1	System Overview	1-5
1-2	Sidetone	1-9
1-3	Echo Suppression	1-9
2-1	AT Commands Protocol	2-2
2-2	Basic Structure of a Command Line.	2-3
2-3	Response to a Command Line	2-4
2-4	Flow and Structure Configuration Commands.	2-5
3-1	TTY Hardware Configuration	3-59
3-2	Audio Modes	3-156
3-3	Basic Audio Setup	3-157
3-4	Advanced Audio Setup.	3-157
3-5	Analog/Digital Switching	3-158
3-6	Audio Paths.	3-164
3-7	G24-L Audio Gain	3-166
3-8	SIM States.	3-178
3-9	Wakeup-In Line	3-201
3-10	Wake up Outline.	3-201
3-11	Sleep Mode when S24 > 0	3-202
3-12	G24-L Lines when S24 > 0.	3-202
3-13	SIM Toolkit	3-246
3-14	Communication During DTMF Command	3-264
3-15	Communication During Launch Browser Command.	3-265
3-16	CIDR Scheme.	3-301
4-1	Phone State Transactions	4-1
4-2	Detailed Phone State Transactions	4-2
4-3	Recommended G24-L Initialization Workflow	4-3
4-4	RS232 Lines Setup	4-4
4-5	Test G24-L Communication.	4-5
4-6	Basic Configuration	4-5
4-7	SIM Card Status	4-7
4-8	G24-L Network Connection	4-8
4-9	Terminal Synchronization	4-9
4-10	Call States	4-14
4-11	Sleep Mode when S24 > 0	4-22
4-12	Display Text	4-23
4-13	Get Inkey	4-23
4-14	Get Input.	4-24
4-15	Play Tone	4-24
4-16	Set Up Menu.	4-25
4-17	Select Item	4-25
4-18	Send SMS	4-25
4-19	Set Up Call	4-26
4-20	Call Control	4-26
4-21	Send DTMF	4-27

List of Figures

4-22	Launch Browser	4-27
4-23	Setup Event List	4-28
4-24	Handset or Handsfree Setup	4-32

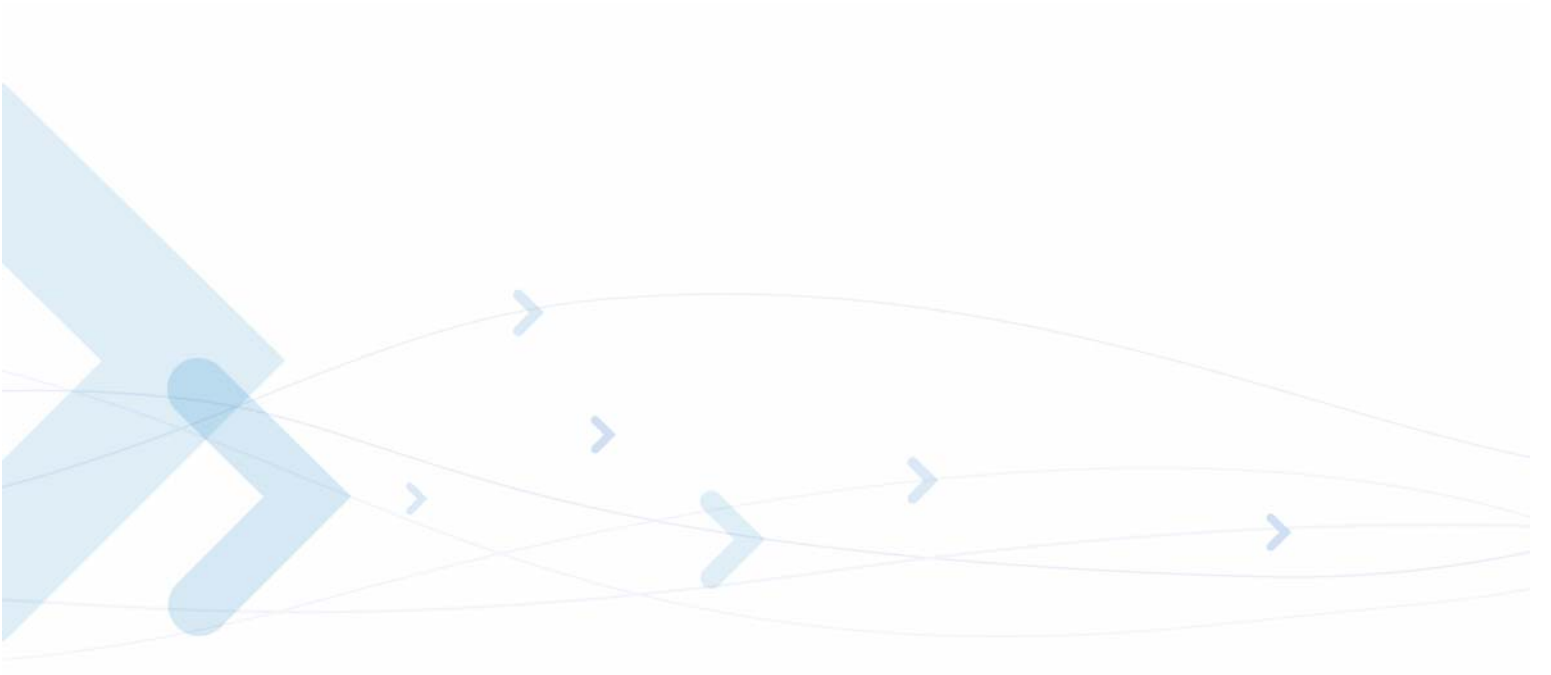

1-1	AT Commands	1-15
3-1	+CGSN, +GSN Parameters	3-3
3-2	+CSCS Parameters	3-4
3-3	+CNUM Parameters	3-7
3-4	D Parameters	3-12
3-5	D> Parameters	3-13
3-6	DL Parameters	3-14
3-7	+CRC Parameters	3-18
3-8	+CLIP Parameters	3-20
3-9	+CCWA Parameters	3-22
3-10	+CHLD Parameters	3-24
3-11	+CHLD Actions According to Call State and Operation	3-25
3-12	+CCFC Parameters	3-28
3-13	+CLIR Parameters	3-30
3-14	+CBST Parameters	3-32
3-15	+CSNS Parameters	3-35
3-16	Mapping Table (V.34)	3-36
3-17	+MVC Parameters	3-38
3-18	+CPAS Parameters	3-39
3-19	+CLCC Parameters	3-41
3-20	+MCST Parameters	3-43
3-21	+CAOC Parameters	3-44
3-22	+CACM Parameters	3-46
3-23	+CMM Parameters	3-47
3-24	+CPUC Parameters	3-48
3-25	+CR Parameters	3-49
3-26	+CSSN Parameters	3-51
3-27	+CSSI Notification Values	3-51
3-28	+CSSU Notification Values	3-51
3-29	+CUSD Parameters	3-53
3-30	CUSD Termination Cause Table Index	3-54
3-31	+COLP Parameters	3-57
3-32	+MTTY Parameters	3-58
3-33	+CPBS Parameters	3-61
3-34	+CPBR Parameters	3-62
3-35	+CPBF Parameters	3-64
3-36	+CPBW Parameters	3-65
3-37	+CSVM Parameters	3-67
3-38	+MDSI Parameters	3-68
3-39	+MCSN Parameters	3-71
3-40	+CCLK Parameters	3-74
3-41	+CSMS Parameters	3-75
3-42	+CPMS Parameters	3-77
3-43	+CMGF Parameters	3-77
3-44	+CSCA Input Characters and Hexadecimal Values	3-78

3-45	+CSCA Parameters	3-79
3-46	+CSMP Parameters	3-80
3-47	VP Relative Format (In Integer Format).	3-80
3-48	+CSDH Parameters	3-82
3-49	+CNMI Parameters	3-83
3-50	+CMTI Parameters	3-86
3-51	+CMT Parameters	3-87
3-52	+CDSI Parameters.	3-88
3-53	+CDS Parameters	3-89
3-54	+CGML/+MMGL Parameters	3-92
3-55	+CMGR/+MMGR Parameters	3-95
3-56	Layout of SMS-DELIVER in PDU Mode (according to GSM03.40)	3-96
3-57	<fo> for SMS-DELIVER Message.	3-97
3-58	Layout of SMS-STATUS-REPORT in PDU Mode (according to GSM03.40).	3-97
3-59	<fo> for SMS-STATUS-REPORT Message	3-99
3-60	<TP-PI> for SMS-STATUS-REPORT Message	3-99
3-61	+MMAR Parameters	3-101
3-62	+CMSS Parameters	3-102
3-63	+CMGW Parameters.	3-103
3-64	Layout of SMS-SUBMIT in PDU Mode: (according to GSM03.40).	3-104
3-65	Layout of SMS-COMMAND in PDU Mode: (according to GSM03.40).	3-104
3-66	<fo> for SMS-SUBMIT Message.	3-105
3-67	<fo> for SMS-COMMAND Message.	3-106
3-68	+CMGD Parameters	3-108
3-69	+CGSMS Parameters	3-109
3-70	+CMGS Parameters	3-110
3-71	+MCSAT Parameters	3-111
3-72	<dcs> field and +CSCS settings conversion when writing SM	3-113
3-73	<dcs> field and +CSCS settings conversion when reading SM	3-114
3-74	+CSQ Parameters	3-117
3-75	+CRLP Parameters	3-118
3-76	+CREG Parameters	3-119
3-77	+CGREG Parameters	3-121
3-78	+COPS Parameters	3-124
3-79	+CPOL Parameters	3-126
3-80	+MFS Parameters	3-128
3-81	+CBC Parameters	3-129
3-82	+MBC Parameters.	3-131
3-83	Battery Level Parameters	3-131
3-84	+CBAUD Parameters	3-132
3-85	+IPR Parameters	3-134
3-86	+MTDTR Parameters	3-135
3-87	&K Parameters	3-136
3-88	&C Parameters	3-137
3-89	&D Parameters	3-138
3-90	+MCWAKE Parameters	3-139
3-91	+MGGIND Parameters	3-140
3-92	+CFUN Parameters	3-141
3-93	+ICF Parameters	3-142
3-94	ATS97 Parameters	3-143
3-95	+MIOC Parameters	3-145
3-96	+MIOD Parameters	3-148
3-97	Keypad GPIOs	3-148
3-98	+MMAD Parameters.	3-151

3-99	+MPCMC Parameters	3-154
3-100	Basic and Advanced Audio Modes Comparison	3-156
3-101	+CRSL Parameters	3-159
3-102	+CLVL Parameters	3-160
3-103	+CMUT Parameters	3-160
3-104	ATS94 and ATS96 Behavior	3-161
3-105	S94 Parameters	3-162
3-106	ATS96 and ATS94 Behavior	3-162
3-107	S96 Parameters	3-163
3-108	+MAPATH Parameters	3-165
3-109	+MAVOL Parameters	3-167
3-110	MAMUT Parameters	3-168
3-111	MAFEAT Parameters	3-169
3-112	+MADIGITAL Parameters	3-170
3-113	+CALM Parameters	3-171
3-114	+MMICG Parameters	3-172
3-115	+CRTT Parameters	3-173
3-116	Ring Tone Types Available	3-174
3-117	+VTD Parameters	3-175
3-118	+VTS Parameters	3-176
3-119	SIM Card Errors	3-178
3-120	+CPIN Parameters	3-179
3-121	+EPIN Parameters	3-181
3-122	+TPIN Parameters	3-182
3-123	+CPWD Parameters	3-183
3-124	+CLCK Parameters	3-185
3-125	+EMPC Parameters	3-188
3-126	Effects of Parameter Settings	3-190
3-127	V Parameters	3-191
3-128	Qn Parameters	3-192
3-129	En Parameters	3-192
3-130	X Parameters	3-193
3-131	S2 Parameters	3-196
3-132	S12 Parameters	3-197
3-133	&F Parameters	3-198
3-134	Z Parameters	3-199
3-135	S24 Parameters	3-203
3-136	S102 Parameters	3-204
3-137	Command parameters	3-205
3-138	+MSCTS Parameters	3-206
3-139	+CMEE Parameters	3-207
3-140	+CME Errors	3-208
3-141	+CMS Errors	3-210
3-142	+STK Errors	3-211
3-143	+CEER Parameters	3-214
3-144	+CRSM Parameters	3-217
3-145	&W Parameters	3-222
3-146	Profile Parameters	3-222
3-147	&Y Parameters	3-224
3-148	+CMER Parameters	3-225
3-149	+CLAN Parameters	3-226
3-150	+CIND Parameters	3-227
3-151	+CIEV Parameters	3-229
3-152	+CGCLASS Parameters	3-231

3-153	+CGDCONT Parameters	3-233
3-154	+CGQMIN Parameters	3-235
3-155	+CGQREQ Parameters	3-237
3-156	+CGATT Parameters	3-238
3-157	+CGADDR Parameters	3-239
3-158	+MGEER Parameters	3-241
3-159	D*99 Parameters	3-243
3-160	+CGPRS Parameters	3-244
3-161	+CGACT Parameters	3-245
3-162	STK Mechanisms	3-247
3-163	+MTKR Parameters	3-248
3-164	Profile Structure – Byte 1 (Download)	3-248
3-165	Profile Structure – Byte 2 (Other)	3-249
3-166	Profile Structure – Byte 3 (Proactive SIM)	3-249
3-167	Profile Structure – Byte 4 (Proactive SIM)	3-250
3-168	Profile Structure – Byte 5 (Event driven information)	3-250
3-169	Profile Structure – Byte 6 (Event driven information extensions)	3-250
3-170	Profile Structure – Byte 7 (Multiple card proactive commands)	3-251
3-171	Profile Structure – Byte 8 (Proactive SIM)	3-251
3-172	Profile Structure – Byte 9 (Proactive SIM)	3-252
3-173	Profile Structure – Byte 10 (Soft keys support)	3-252
3-174	Profile Structure – Byte 11 (Soft keys information)	3-253
3-175	Profile Structure – Byte 12 (Bearer independent protocol proactive commands – class "e")	3-253
3-176	Profile Structure – Byte 13 (Bearer independent protocol supported bearers – class "e")	3-254
3-177	Profile Structure – Byte 14 (Screen height)	3-254
3-178	Profile Structure – Byte 15 (Screen width)	3-255
3-179	Profile Structure – Byte 16 (Screen effects)	3-255
3-180	Profile Structure – Byte 17 (Bearer independent protocol supported transport interface – class "e")	3-255
3-181	Profile Structure – Byte 18 (Reserved)	3-256
3-182	Profile Structure – Byte 19 (Reserved for TIA/EIA-136 facilities)	3-256
3-183	+MTKE Parameters	3-257
3-184	+MTKP Field Descriptions	3-258
3-185	+MTKP Parameters of MTKP Field Description	3-259
3-186	+MTKP Set Command Parameters	3-262
3-187	+MTKP Parameters – Response Code 26	3-265
3-188	Current Event Types	3-266
3-189	Set Event List Parameters	3-267
3-190	Sample Language Codes	3-268
3-191	+MTKM Parameters	3-272
3-192	+MTKM Unsolicited Identification Parameters	3-273
3-193	+MTKC Parameters	3-274
3-194	+MTKA Parameters	3-275
3-195	+MIPCALL Parameters	3-277
3-196	+MIPOPEN Parameters	3-278
3-197	+MIPODM Parameters	3-281
3-198	+MIPCLOSE Parameters	3-282
3-199	+MIPSETS Parameters	3-283
3-200	+MIPSEND Parameters	3-284
3-201	+MIPPUSH Parameters	3-286
3-202	+MIPFLUSH Parameters	3-286
3-203	+MIPRUDP Parameters	3-287
3-204	+MIPRTCP Parameters	3-288
3-205	+MIPSTAT Parameters	3-288

3-206	+MIPCONF Parameters	3-290
3-207	+MPING Command Parameters.	3-293
3-208	+MPING Unsolicited Response Parameters.	3-295
3-209	+MPINGSTAT Unsolicited Response Parameters.	3-297
3-210	+MSDNS Parameters	3-299
3-211	+MIPCFF Parameters	3-302
3-212	Filtering Error Codes and Status.	3-303
A-1	AT Commands (Alphabetical)	A-1

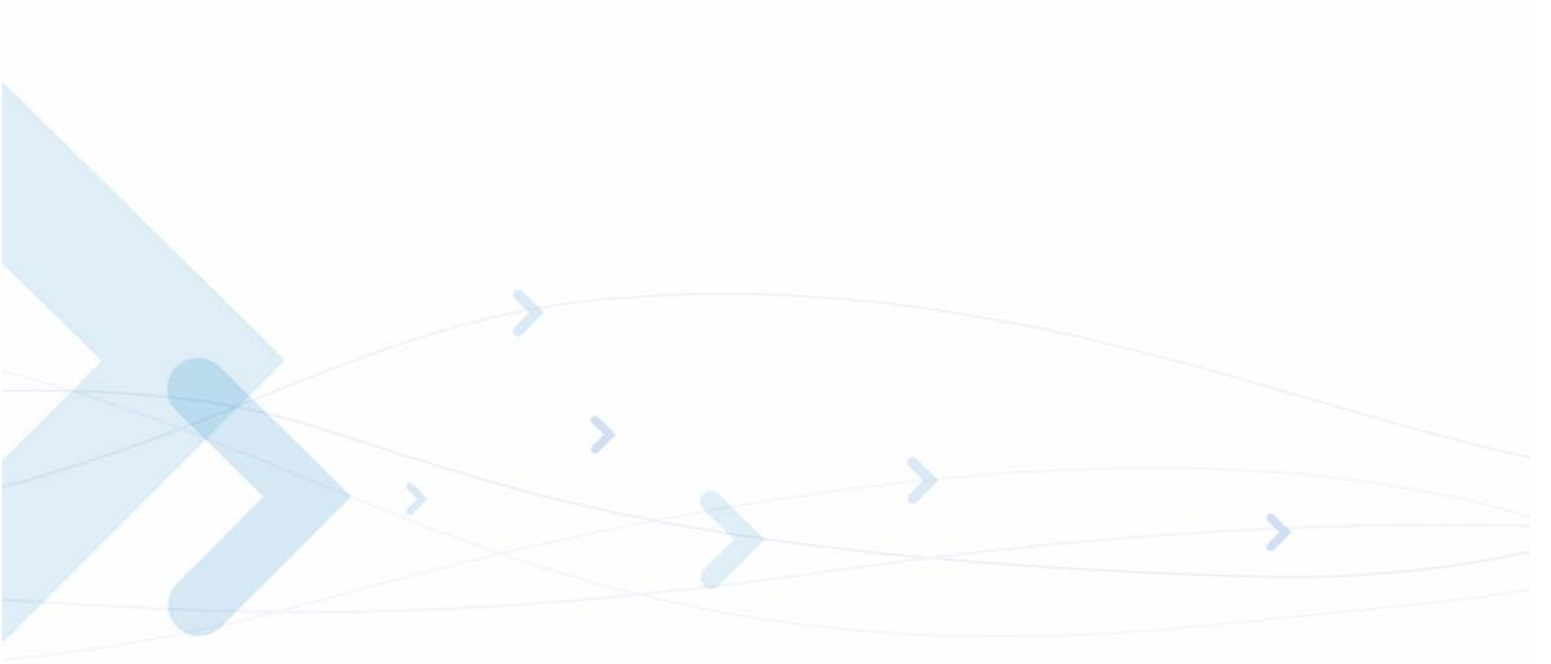

Preface

Note: All references to G24-L also apply to G24-LC, except where otherwise noted.

Manual Scope

This manual introduces the G24-L AT commands, and describes how software developers can use these commands to communicate with the G24-L device, and to create software applications that communicate with the G24-L using these commands.

Note: The integrator should read the corresponding SW release notes for the G24-L version he is using to get information about differences from this manual.

Target Audience

This manual is intended for software developers who communicate with the G24-L device using the AT commands, and create applications to communicate with the G24-L device using the AT commands.

Manual Organization

This manual contains the following chapters:

- “[Preface](#)” provides a scope for this manual, document convention, safety instructions and a liability notification.
- “[Chapter 1: Product Features](#)” introduces the new product features and provides a list of the AT commands.
- “[Chapter 2: Introduction to AT Commands](#)” provides an introduction to the AT commands, and includes a general explanation of the command’s format and usage. It also describes supported character sets and error handling.
- “[Chapter 3: AT Commands Reference](#)” provides a reference to all available AT commands, including examples, where relevant.
- “[Chapter 4: Using the Commands](#)” provides scenarios and examples for implementing various G24-L functionality, including G24-L setup and connectivity, SMS, call control, data calls, GPRS, Sleep mode, audio, STK and TCP/IP.
- “[Chapter 5: Tools](#)” describes the the G24-L drivers and application flashing tool.
- “[Appendix A: Reference Tables](#)” provides conversions between different character sets. It also provides an alphabetical list of all the AT commands.

Applicable Documents

- G24-L Module Hardware Description – 6802984C05
- G24-L Developer’s Kit – 6802984C10

Contact Us

We at Motorola want to make this guide as helpful as possible. Keep us informed of your comments and suggestions for improvements.

For general contact, technical support, report documentation errors and to order manuals, use this email address:

M2M.CustomerCare@motorola.com

Motorola appreciates feedback from the users of our information.

Text Conventions

The following special paragraphs are used in this guide to point out information that must be read. This information may be set-off from the surrounding text, but is always preceded by a bold title in capital letters:

Note

Note: Presents additional, helpful, noncritical information that you can use.

Warning

Warning: Presents information to warn you of a potentially hazardous situation in which there is a possibility of personal injury.

Important

Important: Presents information to help you avoid an undesirable situation or provides additional information to help you understand a topic or concept.

Caution

Caution: Presents information to identify a situation in which damage to software, stored data, or equipment could occur, thus avoiding the damage.

Manual Banner Definitions

A banner text in the page footer under the book title (for example, **Preliminary** or **FOA**) indicates that some information contained in the manual is not yet approved for general customer use.

Field Service

For Field Service requests, use this email address:

n2csfs01@motorola.com

General Safety

Remember! . . . safety depends on you!

The following general safety precautions must be observed during all phases of operation, service, and repair of the equipment described in this manual. Failure to comply with these precautions or with specific warnings elsewhere in this manual violates safety standards of design, manufacture, and intended use of the equipment. Motorola, Inc. assumes no liability for the customer's failure to comply with these requirements. The safety precautions listed below represent warnings of certain dangers of which we are aware. You, as the user of this product, should follow these warnings and all other safety precautions necessary for the safe operation of the equipment in your operating environment.

Ground the instrument

To minimize shock hazard, the equipment chassis and enclosure must be connected to an electrical ground. If the equipment is supplied with a three-conductor AC power cable, the power cable must be either plugged into an approved three-contact electrical outlet or used with a three-contact to two-contact adapter. The three-contact to two-contact adapter must have the grounding wire (green) firmly connected to an electrical ground (safety ground) at the power outlet. The power jack and mating plug of the power cable must meet International Electrotechnical Commission (IEC) safety standards.

Note: Refer to "*Grounding Guideline for Cellular Radio Installations*"—Motorola part no. 68P081150E62.

Do not operate in an explosive atmosphere

Do not operate the equipment in the presence of flammable gases or fumes. Operation of any electrical equipment in such an environment constitutes a definite safety hazard.

Do not service or adjust alone

Do not attempt internal service or adjustment unless another person, capable of rendering first aid is present.

Keep away from live circuits

Operating personnel must:

- not remove equipment covers. Only Factory Authorized Service Personnel or other qualified maintenance personnel may remove equipment covers for internal subassembly, or component replacement, or any internal adjustment
- not replace components with power cable connected. Under certain conditions, dangerous voltages may exist even with the power cable removed
- always disconnect power and discharge circuits before touching them





Do not substitute parts or modify equipment

Because of the danger of introducing additional hazards, do not install substitute parts or perform any unauthorized modification of equipment. Contact Motorola Warranty and Repair for service and repair to ensure that safety features are maintained.

Batteries

Batteries can cause property damage and/or bodily injury such as burns if a conductive material such as jewelry, keys, or beaded chains touch exposed terminals. The conductive material may complete an electrical circuit (short circuit) and become quite hot. Exercise care in handling any charged battery, particularly when placing it inside a pocket, purse, or other container with metal objects. **Use only Motorola original batteries and chargers.**

Your battery may contain symbols, defined as follows:

Symbol	Definition
	Important safety information will follow.
	Your battery or phone should not be disposed of in a fire.
	Your battery or phone may require recycling in accordance with local laws. Contact your local regulatory authorities for more information.
	Your battery or phone should not be thrown in the trash.
	Your phone contains an internal lithium ion battery.

Dangerous procedure warnings

Warnings, such as the example below, precede potentially dangerous procedures throughout this manual. Instructions contained in the warnings must be followed. You should also employ all other safety precautions that you deem necessary for the operation of the equipment in your operating environment.

Warning example:

Warning: Dangerous voltages, capable of causing death, are present in this equipment. Use extreme caution when handling, testing, and adjusting.

Caring for the Environment

The following information is provided to enable regulatory compliance with the European Union (EU) Directive [2002/96/EC Waste Electrical and Electronic Equipment \(WEEE\)](#) when using Motorola equipment in EU countries.

Disposal of Motorola equipment in EU countries



Please do not dispose of Motorola equipment in landfill sites.

In the EU, Motorola in conjunction with a recycling partner will ensure that equipment is collected and recycled according to the requirements of EU environmental law.

Please contact the Customer Network Resolution Center (CNRC) for assistance. The 24 hour telephone numbers are listed at

<http://mynetworksupport.motorola.com>

Select **Customer Network Resolution Center contact information**.

Alternatively if you do not have access to CNRC or the internet, contact the Local Motorola Office.

Disposal of Motorola equipment in non-EU countries

In non-EU countries, dispose of Motorola Networks equipment in accordance with national and regional regulations.

RoHS Compliance

The G24-L/LC product meets the European Union directive for RoHS compliance.

The RoHS compliance is subject to a declaration of conformity that may be viewed upon request.

CMM Compliance

The disclosure table and symbols below are provided in accordance with Section 5 & 6 of the People's Republic of China's "Electronic Industry Marking Standard for Control of Pollution Caused by Electronic Information Products". The disclosure table and symbols shown below cover the electronic information product (EIP) supplied.

部件名称	有毒有害物质或元素					
	铅 (Pb)	汞 (Hg)	镉 (Cd)	六价铬 (Cr6+)	多溴联苯 (PBB)	多溴二苯醚 (PBDE)
o: 表示该有毒有害物质在该部件所有均质材料中的含量均在SJ/T 11363-2006标准规定的限量要求以下。 x: 表示该有毒有害物质至少在该部件的某一均质材料中的含量超出SJ/T 11363-2006标准规定的限量要求。						
Cellular Phone	x	o	o	o	o	o
Battery	x	o	o	o	o	o
Accessories	x	o	o	o	o	o

The two symbols shown below indicate the product is recyclable and the number denotes the Environmental Friendly Use Period for the EIP indicated above it.

Transceiver module & Accessories
Except Battery



Battery



Limitation of Liability

The Products are not designed, intended, or authorized for use as components in systems intended for surgical implant into the body; in other applications intended to support or sustain life; for the planning, construction, maintenance, operation or use of any nuclear facility; for the flight, navigation, communication of aircraft or ground support equipment; or in any other application in which the failure of the Product could create a situation where personal injury or death may occur. If CUSTOMER should use any Product or provide any Product to a third party for any such use, CUSTOMER hereby agrees that MOTOROLA is not liable, in whole or in part, for any claims or damages arising from such use, and further agrees to indemnify and hold MOTOROLA harmless from any claim, loss, cost or damage arising from such use.

EXCEPT AS SPECIFICALLY STATED ABOVE, THE PRODUCTS ARE PROVIDED "AS IS" AND MOTOROLA MAKES NO OTHER WARRANTIES EXPRESS, IMPLIED, STATUTORY, OR OTHERWISE REGARDING THE PRODUCTS. MOTOROLA SPECIFICALLY DISCLAIMS ANY IMPLIED WARRANTIES OF MERCHANTABILITY AND FITNESS FOR A PARTICULAR PURPOSE, OR ARISING FROM A COURSE OF DEALING OR USAGE OF TRADE.

Under no circumstances shall MOTOROLA be liable to CUSTOMER or any other party for any costs, lost revenue or profits or for any other special, incidental or consequential damages, even if

MOTOROLA has been informed of such potential loss or damage. And in no event shall MOTOROLA's liability to CUSTOMER for damages of any nature exceed the total purchase price CUSTOMER paid for the Product at issue in the dispute, except direct damages resulting from patent and/or copyright infringement, which shall be governed by the "INDEMNITY" Section of this Agreement.

The preceding states MOTOROLA's entire liability for MOTOROLA's breach or failure to perform under any provision of this Agreement.

Warranty Notification

Motorola guarantees to you, the original purchaser, the OEM module and accessories which you have purchased from an authorized Motorola dealer (the "Products"), to be in conformance with the applicable Motorola specifications current at the time of manufacture for a term of [1] year from date of purchase of the Product(s) (Warranty Term).

You must inform Motorola of the lack of conformity to the applicable specifications of any of the Products within a period of two (2) months from the date on which you detect a defect in material, workmanship or lack of conformity and in any event within a term not to exceed the Warranty Term, and must immediately submit the Product for service to Motorola's Authorized Repair or Service Center. Motorola shall not be bound by Product related statements not directly made by Motorola nor any warranty obligations applicable to the seller.

A list of the Motorola Call Center numbers is enclosed with this Product.

During the Warranty term, Motorola will, at its discretion and without extra charge, as your exclusive remedy, repair or replace your Product which does not comply with this warranty; or failing this, to reimburse the price of the Product but reduced to take into account the use you have had of the Product since it was delivered. This warranty will expire at the end of the Warranty Term.

This is the complete and exclusive warranty for a Motorola OEM module and accessories and in lieu of all other warranties, terms and conditions, whether express or implied.

Where you purchase the product other than as a consumer, Motorola disclaims all other warranties, terms and conditions express or implied, such as fitness for purpose and satisfactory quality.

In no event shall Motorola be liable for damages nor loss of data in excess of the purchase price nor for any incidental special or consequential damages* arising out of the use or inability to use the Product, to the full extent such may be disclaimed by law.

This Warranty does not affect any statutory rights that you may have if you are a consumer, such as a warranty of satisfactory quality and fit for the purpose for which products of the same type are normally used under normal use and service, nor any rights against the seller of the Products arising from your purchase and sales contract.

(*including without limitation loss of use, loss of time, loss of data, inconvenience, commercial loss, lost profits or savings.

How to Get Warranty Service?

In most cases the authorized Motorola dealer which sold and/or installed your Motorola OEM module and original accessories will honor a warranty claim and/or provide warranty service. Alternatively, for further information on how to get warranty service please contact either the

customer service department of your service provider or Motorola's call Center at n2csfs01@motorola.com.

Claiming

In order to claim the warranty service you must return the OEM module and/or accessories in question to Motorola's Authorized Repair or Service Center in the original configuration and packaging as supplied by Motorola. Please avoid leaving any supplementary items like SIM cards. The Product should also be accompanied by a label with your name, address, and telephone number; name of operator and a description of the problem.

In order to be eligible to receive warranty service, you must present your receipt of purchase or a comparable substitute proof of purchase bearing the date of purchase. The phone should also clearly display the original compatible electronic serial number (IMEI) and mechanic serial number [MSN]. Such information is contained with the Product.

You must ensure that all and any repairs or servicing is handled at all times by a Motorola Authorized Service Center in accordance with the Motorola Service requirements.

In some cases, you may be requested to provide additional information concerning the maintenance of the Products by Motorola Authorized Service Centers only, therefore it is important to keep a record of any previous repairs, and make them available if questions arise concerning maintenance.

Conditions

This warranty will not apply if the type or serial numbers on the Product has been altered, deleted, duplicated, removed, or made illegible. Motorola reserves the right to refuse free-of-charge warranty service if the requested documentation can not be presented or if the information is incomplete, illegible or incompatible with the factory records.

Repair, at Motorola's option, may include reflashing of software, the replacement of parts or boards with functionally equivalent, reconditioned or new parts or boards. Replaced parts, accessories, batteries, or boards are warranted for the balance of the original warranty time period. The Warranty Term will not be extended. All original accessories, batteries, parts, and OEM module equipment that have been replaced shall become the property of Motorola. Motorola does not warrant the installation, maintenance or service of the products, accessories, batteries or parts.

Motorola will not be responsible in any way for problems or damage caused by any ancillary equipment not furnished by Motorola which is attached to or used in connection with the Products, or for operation of Motorola equipment with any ancillary equipment and all such equipment is expressly excluded from this warranty.

When the Product is used in conjunction with ancillary or peripheral equipment not supplied by Motorola, Motorola does not warrant the operation of the Product/peripheral combination and Motorola will not honor any warranty claim where the Product is used in such a combination and it is determined by Motorola that there is no fault with the Product. Motorola specifically disclaims any responsibility for any damage, whether or not to Motorola equipment, caused in any way by the use of the OEM module, accessories, software applications and peripherals (specific examples include, but are not limited to: batteries, chargers, adapters, and power supplies) when such accessories, software applications and peripherals are not manufactured and supplied by Motorola.

What is Not Covered by the Warranty

This warranty is not valid if the defects are due to damage, misuse, tampering, neglect or lack of care and in case of alterations or repair carried out by unauthorized persons.

The following are examples of defects or damage not covered by this product warranty

1. Defects or damage resulting from use of the Product in other than its normal and customary manner.
2. Defects or damage from misuse, access to incompatible sources, accident or neglect.
3. Defects or damage from improper testing, operation, maintenance, installation, adjustment, unauthorized software applications or any alteration or modification of any kind.
4. Breakage or damage to antennas unless caused directly by defects in material or workmanship.
5. Products disassembled or repaired other than by Motorola in such a manner as to adversely affect performance or prevent adequate inspection and testing to verify any warranty claim.
6. Defects or damage due to range, coverage, availability, grade of service, or operation of the cellular system by the cellular operator.
7. Defects or damage due to moist, liquid or spills of food.
8. Control unit coil cords in the Product that are stretched or have the modular tab broken.
9. All plastic surfaces and all other externally exposed parts that are scratched or damaged due to customer normal use.

Depending on operating conditions and your usage habits, wear and tear might take place of components including mechanical problems related to Product housing, paint, assembly, sub-assemblies, displays and keyboards and any accessories which are not part of the Product's in-box configuration. The rectification of faults generated through wear and tear and the use of consumable items like batteries beyond their Optimum Performance Time as indicated in the product manual is considered to be your responsibility and therefore Motorola will not provide the free Warranty repair service for these items.

Installed Data

Please make and retain a note of all data you have inserted into your product. For example names, addresses, phone numbers, user and access codes, notes etc. before submitting your product for a warranty service as such data may be deleted or erased as part of the repair or service process.

Please note if you have downloaded material onto your product, for example ring tones, ring tunes, screensavers, wallpaper, games, etc. These may be deleted or erased as part of the repair process or testing process. Motorola shall not be responsible for such matters. The repair or testing process should not affect any such material that was installed by Motorola on your product as a standard feature.

Out of Warranty Repairs

If you request Motorola to repair your product any time after the warranty term or where this warranty does not apply due to the nature of the defect or fault, then Motorola may in its discretion carry out such repairs subject to you paying Motorola its fees for such a repair or it may refer you to an authorized third party to carry out such repairs.

Revision History

Manual Number

6802983C95-C

Manual Title

G24-L Developer's Guide: G24-L AT Commands Reference Manual

Version Information

The following table lists the manual version, date of version, and remarks about the version.

Revision History

Version	Date Issue	Remarks
A	September 25, 2007	Initial Release
B	January 15, 2008	Major update that include the following features: TCP/IP and STK capabilities.
C	April 15, 2008	AT Commands added: +MIPODM, +MTKA, +MTTY AT Command updated: +MMAD

Chapter 1: Product Features

Connectivity Interface

The user can establish two types of connections in order to establish an AT command session with the G24-L:

- RS232 connection
- USB connection

The user can use either RS232 or USB connections, but not both simultaneously.

GPRS Operation

Overview

The GPRS allows the service subscriber to send and receive data in an end-to-end packet-transfer mode, without utilizing network resources in circuit-switched mode.

Features and Benefits

GPRS enables the cost-effective and efficient use of network resources for packet mode data applications:

- Always connected.
- No setup time before data transmission.
- Cost change based on current data communication (not time based).

Technical Description (GPRS – Class B Operation)

The G24-L is attached to both GPRS and other GSM services, but can only operate one set of services at a time (GPRS or CSD).

The G24-L can activate a GPRS context and at the same time be alerted for an incoming CSD call.

This functionality is available on the G24-L single serial line by following the steps below:

1. While in GPRS, listen to the RI signal (RS232) for an incoming CSD call ring.

2. Upon being interrupted by the RI signal, drop the DTR line to switch to command mode (depending on the previous DTR configuration: AT&D).
3. Answer the call (suspending the GPRS session).
4. At the end of the call, pull the DTR to resume the GPRS session.

CSD Operation

Overview

GSM CSD bearer service, the most widely used data service, provides non-transparent (error correction and flow control) data rate of 9.6 kbit/s.

Data transfer over Circuit Switched Data (CSD) is possible. Once the connection is established, data can be transferred to and from the remote side.

The user should take the CSD call setup time into account.

Network operators charge the user for the call time regardless of data usage.

Features and Benefits

CSD operation enables the terminal to perform a data transfer over a circuit switched link.

It enables the user to:

- Connect to a remote modem without any Internet network involvement.
- Own a real IP address and enable its access by connecting to an external ISP.

The following are examples of standard CSD call uses:

- Connecting an Internet Service Provider (ISP).
- Remotely accessing corporate Intranet via Remote Access Server (RAS).
- User specific protocol, where the user defines both the remote and local sides.

Technical Description

GSM network operators typically support the non-transparent CSD bearer service through a modem interworking function. This means that a G24-L initiates a data call and the network routes the call to the modem interworking function, which is located at the Mobile Switching Center (MSC) of the GSM network. The modem interworking function then dials the number supplied by the mobile station.

This is different from voice calls, where the GSM network itself routes the call, often to another mobile station on the same network. The GSM network does not route data calls - it dials the requested number on behalf of the mobile station and leaves the routing to the external wireline telephone network. The main reason for this is that the GSM network has information about what the user wants to do with the data call. For example, the user may be contacting his or her Internet Service Provider (ISP) to send email or dialing the corporate Intranet to set up a virtual private network (VPN) connection to retrieve confidential customer information from a company database.

Improved OEM Features

G24-L contains the following new and improved features:

- SIM Application Toolkit (STK)
- TCP/IP support
- Audio (digital and analog) - path, gain and algorithm
- User-defined profiles

For a full list of G24-L features, refer to the G24-L Module Hardware Description manual.

SIM Application Toolkit (STK)

Overview

The SIM Toolkit (STK, also known as the SIM Application Toolkit or SAT) is a set of applications operated by the network provider (usually the module's SIM provider). If the STK is supported and enabled on the mobile side, specific data can be obtained via menu browsing.

Features and Benefits

The G24-L STK enables the terminal to obtain information via menus created by the provider, for example, "local news" or "weather info". These menus are provider dependent. Enabling the STK allows the provider to perform other actions regarding call control, SMS etc.

Technical Description

The STK supports the specific mechanism(s) that SIM applications require to interact and operate with the G24-L. Using this mechanism, the SIM can notify the terminal, via the G24-L, that a specific action is requested. A full list of supported actions is listed in the Proactive SIM section. For more information regarding the STK mechanism, refer to the GSM 11.11 [20], GSM 11.14 ETSI standards.

Profile Download

Profile downloading provides a mechanism for the G24-L to transmit information describing its capabilities to the SIM. During the early, profile download phase of the protocol, the G24-L negotiates and confirms its ability to support the capabilities requested by the STK.

Data Transfer into the SIM

STK data transfer uses the short message service (SMS) as a transfer layer.

Set up Idle Mode Text

The proactive SIM mechanism enables the SIM to initiate actions to be handled by the G24-L. Using this service, the SIM can inform the G24-L that it has information pending for action. The SIM can issue a variety of protocol commands through this mechanism, for example:

- Displaying text
- Sending a short message
- Setting up a voice call to a number held by the SIM
- Setting up a data call to a number whose bearer capabilities are held by the SIM
- Sending an SS control or USSD string
- Playing a tone
- Initiating a dialogue with the user (get inkey, get input)
- Providing local information from the G24-L to the SIM
- Profile download
- Send DTMF
- Set up idle text mode
- Launch browser
- Set up event list

Menu Selection

The SIM supplies a set of possible menu entries via a proactive SIM command. The menu selection mechanism is used to transfer the SIM application menu item selected by the user to the SIM and then via SMS to the provider.

Call Control by SIM

When this service is activated by the SIM, all dialed digit strings, supplementary service control strings and USSD strings are first passed to the SIM before the G24-L sets up the call, the supplementary service operation or the USSD operation. The SIM has the ability to allow, disable or modify the call. The STK has the ability to replace a call request, a supplementary service operation or a USSD operation with another call, for example, a call request by the G24-L can be diverted to a different destination.

TCP/UDP IP Connection

Overview

The network capabilities are achieved by using different layers of connections. Every layer of connections provides basic connections to the layer above it. The higher the layer is, the more capabilities it can provide.

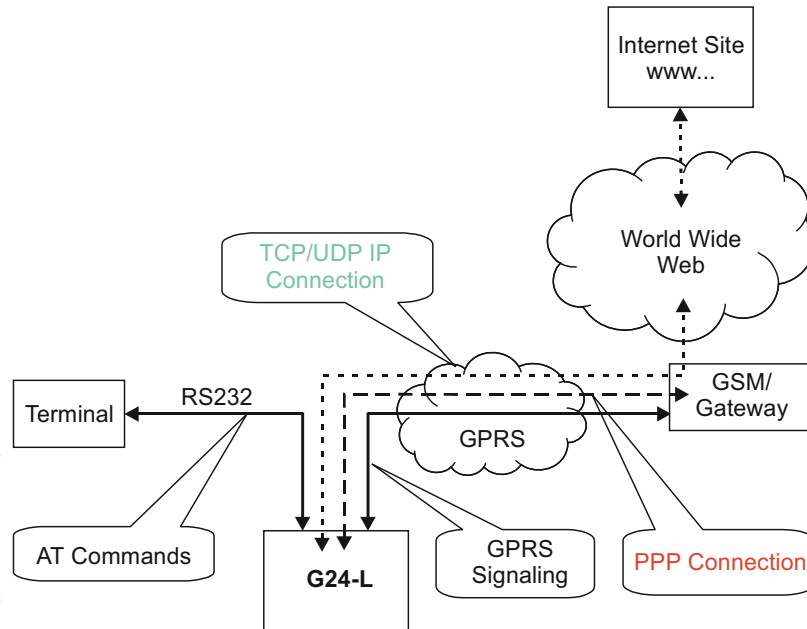

Figure 1-1: System Overview

The three layers of connections are:

- Physical links
- Point-to-point links
- TCP/UDP links

TCP/IP

When establishing the TCP/IP connection the G24-L can only be the "initiator". The TCP/IP feature enables the G24-L to be a wireless end point for a TCP/IP socket.

Note: The TCP protocol use the value TTL (Time to live) = 64.

Creating TCP/IP Connections

Connection from the G24-L to the Web

The following occurs when creating a TCP/IP connection from the G24-L to the Web:

1. The G24-L connects to the GPRS network and receives an IP address (using the +MIPCALL command).

2. The G24-L opens a TCP/IP stack as one of its "sockets" (it must know the target's IP address and port number).
3. Once the connection is established, data is transferred freely in both directions (upload and download).

Connection with another G24-L using the "GPRS Manager"

The following occurs when creating a TCP/IP connection with another G24-L using the "GPRS Manager":

1. The OEM on the target side (server) uses the "GPRS Manager" application. When using this application the TCP/IP is external to the OEM. (External TCP stack is used).
2. The target side activates the "server application" (The term "server application" means an application that has the ability to listen on a given IP address and port number).
3. After connecting to the GPRS network, the "server" sends its IP address to the G24-L using an alternative connection (for example, CSD, SMS and so on).
4. The server application listens on a known port, waiting for G24-L to connect.
5. The G24-L connects to the same GPRS network as the server, and receives an IP address (using the +MIPCALL command).
6. The G24-L initiates a TCP/IP connection with the listening "server". (It knows the IP address and port number of the server).
7. Once the server is connected, the TCP/IP connection is created and data can be transferred freely in both directions (upload and download).

UDP/IP

The set of AT commands created for the TCP/IP connection is used for the UDP/IP connection as well. Therefore, UDP/IP must open a UDP stack using the MIPOPEN AT command. The connection created does not change any concept regarding the UDP/IP known protocol (which is connectionless), this is just an easy way for the terminal to specify to the G24-L which of the four possible stacks should be used.

When establishing the UDP/IP connection, the G24-L is both the "initiator" and the "listener".

Creating UDP/IP Connections

Connection with another G24

The following occurs during a UDP/IP connection with another G24:

1. Side A:
 - The G24-L connects to the GPRS network and receives an IP address (using the +MIPCALL command).
 - The G24-L opens a UDP/IP stack as one of its "sockets" (using the +MIPOPEN and selecting the protocol UDP).
2. Side B:
 - The G24-L connects to the GPRS network and receives an IP address (using the +MIPCALL command).
 - The G24-L opens a UDP/IP stack as one of its "sockets" (using the +MIPOPEN and selecting the protocol UDP).

3. Side A and B previously agree on a port number, and exchange their given IP addresses via other means of connection (SMS, CSD, Voice, DB and so on).
4. The G24-L sends and receives data to and from the targeted site as it knows the IP address and port number of the target.
5. Sending (accumulating) data is done using the +MIPSEND command.
6. Actual send is done using the +MIPPUSH command, by specifying the IP address and port number of the destination.

Note: Every +MIPPUSH sets the destination IP address and destination port number for the current and future transactions. These values are used for the next push if not explicitly overwritten.

Connection from the G24-L (client/server) to WEB (client/server)

The following occurs when creating a UDP/IP connection from the G24-L (client/server) to WEB (client/server):

1. Client side:
 - The G24-L client connects to the GPRS network and receives an IP address (using the +MIPCALL command).
 - The G24-L opens a UDP/IP stack as one of its "sockets" (using the +MIPOPEN and selecting the protocol UDP).
2. The G24-L sends data to the Website, as the Web site's IP address is known and is public, and the port number is previously agreed upon.
3. Sending (accumulating) data is done by the +MIPSEND command.
4. Actual send is done by the +MIPPUSH command by specifying the Website IP address and Website port number.
5. Server side:
 - After receiving the first packet from the client, the server knows the IP address and port number of the G24-L.
 - The IP address and port number for the specific mobile G24-L should be saved in the DB.

Note: Every +MIPPUSH sets the destination IP address and destination port number for the current and future transactions. These values are used for the next push if not explicitly overwritten.

Features and Benefits

The TCP/UDP IP feature provides the terminal with the following benefits:

- Up to four simultaneous protocol connections.
- Ability to pass data via the protocol stack using AT commands (command mode). This relieves the terminal from switching the RS232 to "binary mode" and back to "command mode".
- Ability to use UDP and TCP simultaneously.
- No need for protocol support from the terminal - only data sending and receiving.
- Reduced memory utilization. The G24-L manages the protocol stack and therefore saves terminal memory.
- Ability to receive the incoming TCP connections.
- Ability to accept IP connections only if the IP belongs to a defined IP white list.

Technical Description

Figure 1-1, “System Overview,” on page 1-5 displays the system overview which comprises the following links and layers:

Physical layer links:

- The terminal is connected to the G24-L using a physical RS-232 connection.
- The G24-L is connected to the GGSN using a GPRS link.
- The GGSN is connected to the Internet via some sort of physical connection (usually telephone or cable).

Point-to-point layer links:

- AT command protocol is used to transfer data between the terminal and the G24-L.
- After authentication, the G24-L is linked to the GGSN using PPP protocol.
- The GGSN is connected to its Internet service provider using some protocol.

TCP / UDP layer:

- The G24-L can transfer data with the WEB using either TCP/IP or UDP/IP protocols.
- The protocol stacks in the terminal or in the OEM must be managed when using TCP/IP or UDP/IP protocols. The G24-L software can manage these stacks internally. This enables the G24-L to relieve the terminal from the job of managing these protocols.

Note: Currently, the embedded TCP/IP feature may be used only for mobile-initiated connections. The embedded TCP/IP feature cannot listen on a port for incoming connections.

Audio

Overview

The audio (digital and analog) feature in the G24-L module involves three main issues: path (routes the current input and output devices), gain (volume management) and algorithm. For more information, refer to “Audio” on page 3-155.

Features and Benefits

The following algorithm related features are provided:

Sidetone

Sidetone reduces the microphone audio input that is routed to the selected speaker so that the person speaking can hear himself or herself talking. This creates a slight echo because the speaker

sound then gets picked up again by the microphone and is again routed to the speaker, and so on. Echo suppress is designed to take care of this echo.

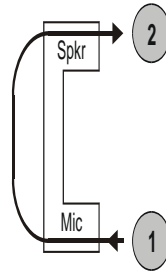

Figure 1-2: Sidetone

Echo Suppression

Echo suppression suppresses a large amount of the output sound picked up by the input device (cancels all echoes).

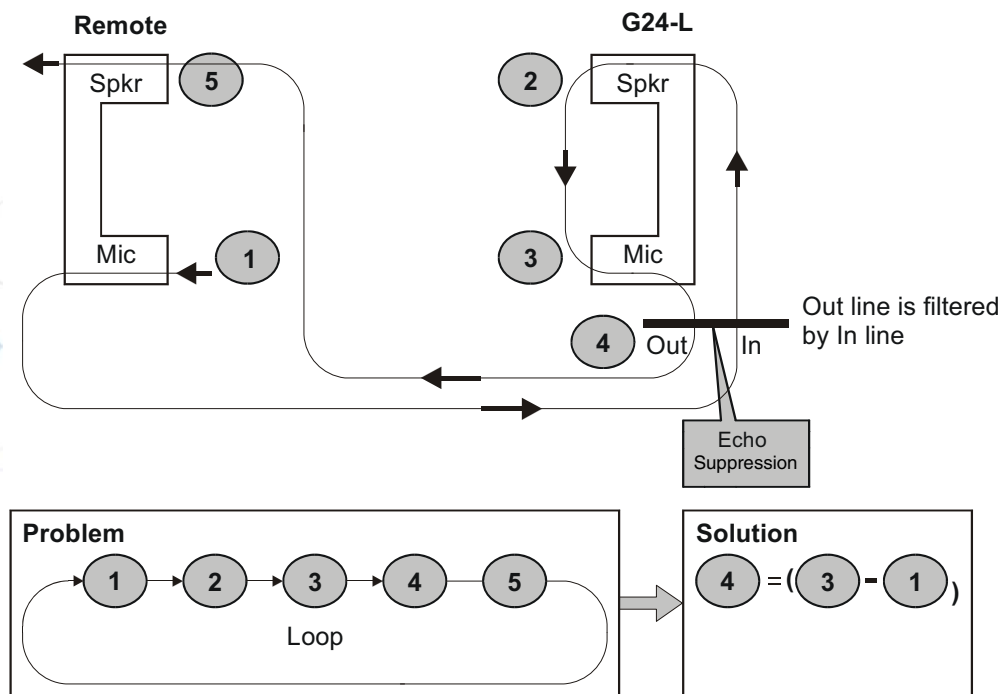

Figure 1-3: Echo Suppression

Noise Suppress

Noise suppression improves audio quality in all modes by suppressing environment noise from being picked up by the input device.

Technical Description

The path features provide full control over the navigation of the audio in the product.

The gain features provide full control over the volume levels of the different output accessories and tones.

The algorithm provides full control over activation/deactivation of audio quality features such as echo canceling and noise suppression.

The user can access these features by means of AT commands. These are described later in this document.

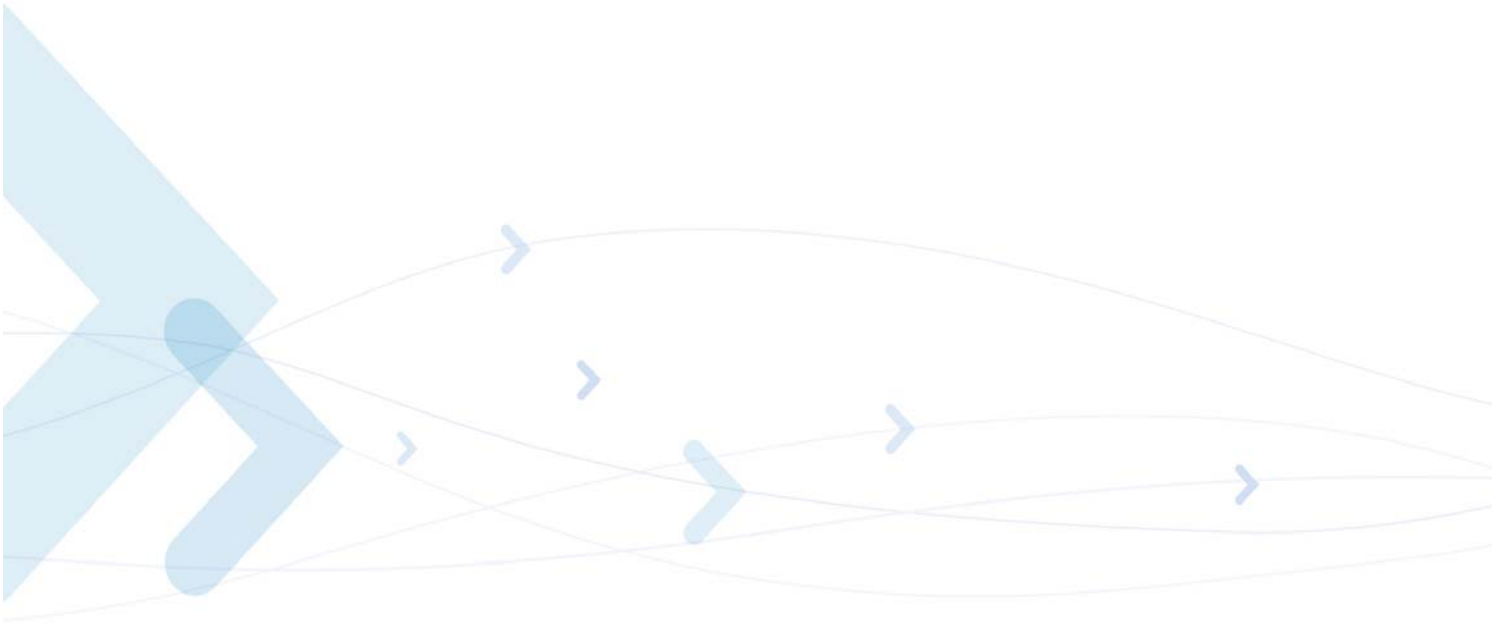

Short Message Service (SMS)

Overview

The SMS feature provides means for SMS messages handling and the reporting of SMS reception events.

G24-L SMS implementation is based on the GSM 07.05 specification.

Features

The SMS, as defined within the GSM 900/1800/1900 digital mobile phone standard:

- A single short message can be up to 160 characters of ASCII text in length (7-bit coded). Message text can comprise words, numbers or an alphanumeric combination.
- Short messages can be written and displayed in various coding schemes, including ASCII and UCS2.
- Reception of an incoming message can invoke an indication to the terminal. This feature is configurable using the command AT+CNMI. Short messages received during data calls are not indicated.
- Short messages can be sent and received simultaneously with GSM voice, data and fax calls.
- Cell broadcast messages can also be selected and received on the G24-L. The G24-L enables registration to specific broadcast channels.

Technical Description

The G24-L memory for incoming short messages is SIM-dependent. A new incoming message is saved in the first free memory location, from index 1, according to the SIM card.

The G24-L memory can contain up to 73 outgoing and CB messages. A new outgoing message is saved in the next free memory location, from index 101 up to index 352.

SMS Type	SMS Index	Max Number of SMS
Incoming messages	1	SIM-dependent
	2	
	...	
	20	
Outgoing and CB messages	21	250
	22	
	...	
	270	

Character Sets

The following includes the references to various tables that provide conversions between the different character sets.

- CS1 - GSM to UCS2.
- CS2 - ASCII to/from UTF8.
- CS3 - UCS2 to/from UTF8.

For the full content of a specific conversion table, refer to Appendix A, Character Set Tables.

ASCII Character Set Management

The ASCII character set is a standard seven-bit code that was proposed by ANSI in 1963, and finalized in 1968. ASCII was established to achieve compatibility between various types of data processing equipment.

GSM Character Set Management

In G24-L, the GSM character set is defined as octant stream. This means that text is displayed not as GSM characters but in the hex values of these characters.

UCS2 Character Set Management

UCS2 is the first officially standardized coded character set, eventually to include the characters of all the written languages in the world, as well as all mathematical and other symbols.

Unicode can be characterized as the (restricted) 2-octet form of UCS2 on (the most general) implementation level 3, with the addition of a more precise specification of the bi-directional behavior of characters, as used in the Arabic and Hebrew scripts.

The 65,536 positions in the 2-octet form of UCS2 are divided into 256 rows with 256 cells in each. The first octet of a character representation denotes the row number, the second the cell number. The first row (row 0) contains exactly the same characters as ISO/IEC 8859-1. The first 128 characters are thus the ASCII characters. The octet representing an ISO/IEC 8859-1 character is easily transformed to the representation in UCS2 by placing a 0 octet in front of it. UCS2 includes the same control characters as ISO/IEC 8859 (also in row 0).

UTF-8 Character Set Management

UTF-8 provides compact, efficient Unicode encoding. The encoding distributes a Unicode code value's bit pattern across one, two, three, or even four bytes. This encoding is a multi-byte encoding.

UTF-8 encodes ASCII in a single byte, meaning that languages using Latin-based scripts can be represented with only 1.1 bytes per character on average.

UTF-8 is useful for legacy systems that want Unicode support because developers do not have to drastically modify text processing code. Code that assumes single-byte code units typically does not fail completely when provided UTF-8 text instead of ASCII or even Latin-1.

Unlike some legacy encoding, UTF-8 is easy to parse. So-called lead and trail bytes are easily distinguished. Moving forwards or backwards in a text string is easier in UTF-8 than in many other multi-byte encoding.

The codes in the first half of the first row in Character Set Table CS2 (UTF-8 <-> ASCII) are replaced in this transformation format by their ASCII codes, which are octets in the range between 00h and 7F. The other UCS2 codes are transformed to between two and six octets in the range between 80h and FF. Text containing only characters in Character Set Table CS3 (UTF-8 <-> UCS-2) is transformed to the same octet sequence, irrespective of whether it was coded with UCS-2.

8859-1 Character Set Management

ISO-8859-1 is an 8 bit character set - a major improvement over the plain 7 bit US-ASCII.

Characters 0 to 127 are always identical with US-ASCII and the positions 128 to 159 hold some less used control characters. Positions 160 to 255 hold language-specific characters.

ISO-8859-1 covers most West European languages, such as French (fr), Spanish (es), Catalan (ca), Basque (eu), Portuguese (pt), Italian (it), Albanian (sq), Rhaeto-Romanic (rm), Dutch (nl), German (de), Danish (da), Swedish (sv), Norwegian (no), Finnish (fi), Faroese (fo), Icelandic (is), Irish (ga), Scottish (gd) and English (en). Afrikaans (af) and Swahili (sw) are also included, extending coverage to much of Africa.

AT Commands Summary

The following list contains a summary of all the G24-L AT commands sorted by functionality.

Table 1-1: AT Commands

AT Command	Description	Page
Modem ID		
Subscriber Unit Identity		
+CGMI	This command displays manufacturer identification.	Page 3-1
+GMI	This command displays manufacturer identification.	Page 3-1
+FMI	This command displays manufacturer identification.	Page 3-1
+CGMM	This command displays the model identification.	Page 3-2
+GMM	This command displays the model identification.	Page 3-2
+FMM	This command displays the model identification.	Page 3-2
+CGMR	This command displays the revision identification.	Page 3-3
+GMR	This command displays the revision identification.	Page 3-3
+FMR	This command displays the revision identification.	Page 3-3
+CGSN	This command displays the product serial number identification.	Page 3-3
+GSN	This command requests the product serial number identification.	Page 3-3
+CSCS	This command selects the G24-L character set.	Page 3-4
+CIMI	This command displays the International Mobile Subscriber Identity number.	Page 3-5
+CFSN	This command is used to query the manufacturing serial number.	Page 3-5
I	This command displays various G24-L information items.	Page 3-6
+CNUM	This command displays up to five strings of text information that identify the G24-L.	Page 3-6
\$	This command displays a list of all the AT commands supported by the G24-L.	Page 3-7
+CLAC	This command displays a list of all the AT commands supported by the G24-L.	Page 3-8
Call Control		
Call Control Commands		
D	This command places a voice call on the current network, when issued from an accessory device.	Page 3-11
D>	This command places a voice/fax/data call on the current network by dialing directly from the G24-L phone book.	Page 3-12

Table 1-1: AT Commands (Cont.)

AT Command	Description	Page
DL	This command places a voice call to the last number dialed.	Page 3-14
H	This command hangs up, or terminates a particular call.	Page 3-15
A	This command answers an incoming call, placing the G24-L into the appropriate mode, as indicated by the RING message.	Page 3-17
+CRC	This command controls whether to present the extended format of the incoming call indication.	Page 3-17
RING	This unsolicited event is received when an incoming call (voice, data or fax) is indicated by the cellular network.	Page 3-17
+CRING	This unsolicited event indicates the type of incoming call.	Page 3-17
+CLIP	This command controls the Calling Line Identity (CLI) presentation to the terminal when there is an incoming call.	Page 3-19
+CCWA	This command controls the Call Waiting supplementary service, including settings and querying of the network by the G24-L.	Page 3-21
+CHLD	This command controls the Call Hold and Multiparty Conversation supplementary services.	Page 3-23
+CCFC	This command controls the call-forwarding supplementary service.	Page 3-27
+CLIR	This command enables/disables the sending of caller ID information to the called party, for an outgoing call.	Page 3-29
+CBST	This command handles the selection of the bearer service and the connection element to be used when data calls are originated.	Page 3-31
O	This command returns a phone to the Online Data mode and issues a CONNECT or CONNECT <text> result code.	Page 3-33
&Q	This command selects the asynchronous mode, and has no effect.	Page 3-33
+CHUP	This command causes the G24-L to hang up the current GSM call.	Page 3-34
+CSNS	This command handles the selection of the bearer or teleservice to be used when a mobile terminated single numbering scheme call is established.	Page 3-34
+MDC	This command enables you to select the desired messages to be displayed upon connection of a voice call with a remote party.	Page 3-36
+CTFR1	This command terminates an incoming call and diverts the caller to the number previously defined in CCFC, or to a voice mail if one exists for the subscriber.	Page 3-37
+MVC	This AT command is used to choose and configure the priority order of the supported voice codecs (vocoders).	Page 3-38
+MTTY	This command is used to enable/disable the TTY (Tele Typewriter) support in the G24-L.	Page 3-57
Call Status Messages		
+CPAS	This command displays the current activity status of the G24-L, for example, call in progress, or ringing.	Page 3-39

Table 1-1: AT Commands (Cont.)

AT Command	Description	Page
+CLCC	This command displays a list of all current G24-L calls and their statuses, and also enables/disables the unsolicited indication of the call list.	Page 3-40
+MCST	This command displays the current state of the call processing, and also enables/disables the unsolicited indication of any change in the call processing state.	Page 3-42
Call Advice of Charge Messages		
+CAOC	This command displays information about the cost of calls.	Page 3-44
+CACM	This command resets the Advice of Charge accumulated call meter value in the SIM file, EFACM.	Page 3-46
+CAMP	This command sets the Advice of Charge accumulated call meter maximum value in the SIM file, EFACMmax.	Page 3-47
+CPUC	This command sets the parameters of the Advice of Charge-related price per unit and currency table found in the SIM file, EFPUCT.	Page 3-48
+CR	This command controls whether or not the extended format of an outgoing call is displayed or not.	Page 3-49
Supplementary Services		
+CSSN	This command handles the enabling and disabling of supplementary service-related, network-initiated, notifications.	Page 3-50
+CUSD	This command allows control of Unstructured Supplementary Service Data (USSD), according to GSM 02.90.	Page 3-53
+COLP	This command refers to the GSM supplementary service COLP, Connected Line Identification Presentation, which enables a calling subscriber to get the connected line identity (COL) of the called party after setting up a mobile-originated call.	Page 3-56
Phone Books and Clock		
Directory Access Commands		
+CPBS	This command handles the selection of the memory to be used for reading and writing entries in G24-Ls that contain more than one phone book memory.	Page 3-60
+CPBR	This command recalls phone book entries from a specific entry number, or from a range of entries.	Page 3-61
+CPBF	This command searches the currently active phone book for a particular entry, by name.	Page 3-63
+CPBW	This command stores a new entry in the phone book, or deletes an existing entry from the phone book.	Page 3-64
+CSVM	This command handles the selection of the number to the voice mail server.	Page 3-66
+MDSI	This command enables unsolicited reporting of indications of SIM deactivation and invalidation.	Page 3-67
+MCSN	This command sets EFmsisdn in the SIM.	Page 3-69

Table 1-1: AT Commands (Cont.)

AT Command	Description	Page
System Date and Time Access Commands		
+CCLK	This command reads/sets the G24-L's current date and time settings.	Page 3-73
SMS		
SMS Commands		
+CSMS	This command handles the selection of the SMS message service type.	Page 3-75
+CPMS	This command handles the selection of the preferred storage area for messages.	Page 3-76
+CMGF	This command handles the selection of message formats.	Page 3-77
+CSCA	This command handles the selection of the SCA and the TOSCA.	Page 3-78
+CSMP	This command sets the Text Module parameters.	Page 3-79
+CSDH	This command shows the Text Mode parameters.	Page 3-81
+CNMI	This command sends an unsolicited indication when a new SMS message is received by the G24-L.	Page 3-82
+CNMA	This command acknowledges the receipt of a +CMT response.	Page 3-84
+CMTI	This unsolicited message, including the SMS message index, is sent upon the arrival of an SMS message.	Page 3-86
+CMT	This unsolicited message displays the received SMS-DELIVER message.	Page 3-86
+CDSI	This unsolicited message indicates that a new SMS-STATUS-REPORT message was received, and is stored in location <index>.	Page 3-88
+CDS	This unsolicited message displays the received SMS-DELIVER message.	Page 3-88
+CMGL	This command displays a list of SMS messages stored in the G24-L memory.	Page 3-89
+MMGL	This command displays a list of SMS messages stored in the G24-L memory.	Page 3-89
+CMGR	This command reads selected SMS messages from the G24-L memory.	Page 3-94
+MMGR	This command reads selected SMS messages from the G24-L memory.	Page 3-94
+MMAR	This command changes the status of an SMS message in the G24-L memory from "REC UNREAD" to "REC READ".	Page 3-101
+CMSS	This command selects and sends pre-stored messages from the message storage.	Page 3-101
+CMGW	This command writes and saves messages in the G24-L memory.	Page 3-103
+CMGD	This command deletes messages from the G24-L memory.	Page 3-108

Table 1-1: AT Commands (Cont.)

AT Command	Description	Page
+CGSMS	This command handles the selection of the service or service preference used by the G24-L to send mobile-originated SMS messages.	Page 3-109
+CMGS	This command sends an SM from the G24-L to the network.	Page 3-110
+MCSAT	This command enables/disables/exercises SMS alert tone for an arriving SMS.	Page 3-111
Network		
Network Commands		
+CSQ	This command displays the signal strength received by the G24-L.	Page 3-117
+CRLP	This command displays the Radio Link Protocol parameters.	Page 3-118
+CREG	This command enables/disables the network status registration unsolicited result code.	Page 3-119
+CGREG	This command enables/disables the GPRS network status registration unsolicited result code.	Page 3-121
+COPS	This command enables accessing the network registration information, as well as select and register the GSM network operator.	Page 3-122
+CPOL	This command is used to edit the list of preferred operators located in the SIM card.	Page 3-125
+MFS	This command is used to determine how long the G24-L waits before attempting to re-register after a registration attempt has failed and the G24-L is not registered.	Page 3-126
Hardware Information		
Hardware Information Commands		
+CBC	This command queries the battery charger connection.	Page 3-129
+MBC	This command allows the battery charger to be managed (start, stop or automatic manage) and get indication for the battery level (solicited or unsolicited reports).	Page 3-130
+CBAUD	This command sets the baud rate.	Page 3-132
+IPR	This command is responsible for setting and saving the request baud rate.	Page 3-133
+MTDTR	This command checks and displays the physical current status of the DTR pin of the RS232.	Page 3-134
+MTCTS	This command sets the CTS pin of the RS232 to not active (high), waits one second and then sets the CTS to active (low).	Page 3-135
&K	This command configures the RTS/CTS flow control.	Page 3-135
&C	This command determines how the state of the DCD line relates to the detection of the received line signal from the distant end.	Page 3-136

Table 1-1: AT Commands (Cont.)

AT Command	Description	Page
&D	This command determines how the G24-L responds when the DTR (Data Terminal Ready) status is changed from ON to OFF during the online data state.	Page 3-138
+MCWAKE	This command displays reports on the status of the GPRS/GSM coverage.	Page 3-139
+MGGIND	This command configures the service indicator on pin 49 of the 70 pin connector to be GPRS or GSM.	Page 3-140
+CFUN	This command shuts down the phone functionality of smart phones and PDAs with phone capabilities.	Page 3-141
+ICF	This command determines the local serial port start/stop (asynchronous) character framing used by the DCE when accepting DTE commands and transmitting information text and result codes.	Page 3-142
S97	This command indicates whether an antenna is physically connected to the G24-L RF connector.	Page 3-143
+MRST	This command enables customer software to perform a hard reset to the G24-L unit.	Page 3-143
+MIOC	This command defines the G24-L 8 GPIO pins data value.	Page 3-144
+MIOD	This command defines the G24-L 8 GPIO pins configuration.	Page 3-147
+MMAD	This command reads and monitors digital value from a specified ADC.	Page 3-149
+MPCMC	This command defines whether the PCM clock is generated continuously or not, when module is in digital audio mode.	Page 3-153
Audio		
Basic Audio Setup Commands		
+CRSL	This command handles the selection of the incoming call ringer and alert tone (SMS) sound level on the alert speaker of the G24-L.	Page 3-158
+CLVL	This command sets the volume of the internal loudspeaker (which also affects the key feedback tone) of the G24-L.	Page 3-159
+CMUT	This command mutes/unmutes the currently active microphone path by overriding the current mute state.	Page 3-160
S94	This S-parameter represents the Boolean status, On/Off, of the sidetone feature.	Page 3-161
S96	This S-parameter represents the Boolean status, On/Off, of the echo cancelling feature in the handsfree.	Page 3-162
Advanced Audio Setup Commands		
+MAPATH	This command sets/requests the active input accessory, and the output accessory for each feature.	Page 3-163
+MAVOL	This command determines a volume setting for a particular feature in a particular accessory.	Page 3-166

Table 1-1: AT Commands (Cont.)

AT Command	Description	Page
+MAMUT	This command controls the muting/unmuting of all input paths (MIC, HDST_MIC, DIGITAL_RX).	Page 3-168
+MAFEAT	This command controls the various algorithm features, such as sidetone, echo cancel and noise suppress.	Page 3-169
General Audio Commands		
+MADIGITAL	This command switches between analog and digital audio modes.	Page 3-170
+CALM	This command handles the selection of the G24-L's alert sound mode.	Page 3-171
+MMICG	This command handles the selection of microphone gain values.	Page 3-172
+CRTT	This command plays one cycle of a ring tone, stops the cycle in the middle, and sets the ring tone to be used.	Page 3-173
+VTD	This command handles the selection of tone duration.	Page 3-175
+VTS	This command transmits a string of DTMF tones when a voice call is active.	Page 3-176
Access		
Access Control Commands		
A/	This command repeats the last command entered on the terminal.	Page 3-177
AT	This command checks the AT communication and only returns OK.	Page 3-177
+CPIN	This command is only relevant for phones that use SIM cards. It unlocks the SIM card when the proper SIM PIN is provided, and unblocks the SIM card when the proper SIM PUK is provided.	Page 3-177
+EPIN	This command is only relevant for phones that use SIM cards. It verifies the PIN2 indicator.	Page 3-181
+TPIN	This command queries the number of remaining SIM PIN/PUK entering attempts.	Page 3-182
+CPWD	This command sets a new password for the facility lock.	Page 3-183
+CLCK	This command locks, unlocks or interrogates a G24-L or a network facility <fac>.	Page 3-184
+EMPC	This command unlocks or resets the first PLMN of the inserted SIM.	Page 3-187
Modem Configuration and Profile		
Modem Register Commands		
V	This command determines the response format of the data adapter and the contents of the header and trailer transmitted with the result codes and information responses.	Page 3-190
Q	This command determines whether to output/suppress the result codes.	Page 3-191

Table 1-1: AT Commands (Cont.)

AT Command	Description	Page
E	This command defines whether the G24-L echoes the characters received from the user, (whether input characters are echoed to output).	Page 3-192
X	This command defines the data adaptor response set, and the CONNECT result code format.	Page 3-193
Sn	This command reads/writes values of the S-registers, and includes registers 1-49, 94, 96 (Audio) and 102 (Sleep mode).	Page 3-194
\S	This command displays the status of selected commands and S-registers.	Page 3-197
\G	This command sets the use of the software flow control.	Page 3-197
\J	This command adjusts the terminal auto rate.	Page 3-197
\N	This command displays the type of link.	Page 3-197
+CBAND	This command is supported for backward compatibility only, and has no effect.	Page 3-197
?	This command displays the most recently updated value stored in the S-register.	Page 3-198
&F	This command restores the factory default configuration profile.	Page 3-198
Z	This command resets the default configuration.	Page 3-199
Sleep Mode Commands		
S24	This S-parameter activates/disables the Sleep mode. If the parameter value is greater than 0, it represent the number of seconds till the G24-L enters sleep mode.	Page 3-202
S102	This S-register sets the value of the delay before sending the data to the terminal.	Page 3-203
+MSCTS	This command defines the behavior of the CTS line when the G24-L is in Sleep mode.	Page 3-205
Error Handling Commands		
+CMEE	This command enables/disables the use of result code +CME ERROR: <err> as an indication of an error relating to the functionality of the G24-L.	Page 3-206
+CEER	This command returns an extended error report containing one or more lines of information text, determined by the manufacturer, providing the reasons for the call-clearing errors.	Page 3-213
User Interface		
+CRSM	This command provides limited access to the Elementary Files on the SIM.	Page 3-216
&V	This command displays the current active configuration and stored user profiles.	Page 3-221
&W	This command stores the user profile.	Page 3-222

Table 1-1: AT Commands (Cont.)

AT Command	Description	Page
&Y	This command displays the default user profile.	Page 3-224
+CMER	This command enables an external accessory to receive key press information from the G24-L's internal keypad.	Page 3-225
+CLAN	This command handles the selection of language in the ME.	Page 3-225
+CIND	This command is used to query the status of various ME indicators.	Page 3-227
Unsolicited UI Status Messages		
+CIEV	An unsolicited indication regarding various phone indications that is sent to the DTE when the <ind> parameter of the +CMER command is set to 1.	Page 3-229
GPRS		
GPRS Commands		
+CGCLASS	This command sets the GPRS mobile station class.	Page 3-231
+CGDCONT	This command specifies the PDP (Packet Data Protocol) context.	Page 3-232
+CGQMIN	This command sets the minimum acceptable quality of service profile.	Page 3-234
+CGQREQ	This command displays the requested quality of service profile.	Page 3-236
+CGATT	This command attaches the G24-L to the GPRS network.	Page 3-237
+CGPADDR	This command reads the allocated PDP addresses for the specified context identifiers.	Page 3-238
+MGEER	This command returns the PDP context activation reject cause.	Page 3-240
D*99	This command enables the ME to perform the actions necessary for establishing communication between the terminal and the external PDN.	Page 3-242
+CGPRS	This command indicates whether there is GPRS coverage.	Page 3-244
+CGACT	This command activates/deactivates the PDP Context.	Page 3-237
STK Commands		
+MTKR	This command displays the profile that is downloaded from the G24-L to the SIM during the SIM initialization process.	Page 3-247
+MTKE	This command enables/disables the SIM ToolKit functionalities.	Page 3-257
+MTKP	This is both a command and an unsolicited event. The command responds to an unsolicited event.	Page 3-258
+MTKM	This is both a command and an unsolicited event. The command selects items from the menu.	Page 3-272
+MTKC	This unsolicited event notifies the terminal when supplementary services, SMS Control or Call Control are modified.	Page 3-274
+MTKA	This command sends acknowledge response from the user (TE) to the STK.	Page 3-274

Table 1-1: AT Commands (Cont.)

AT Command	Description	Page
TCP/IP Commands		
+MIPCALL	This command creates a wireless PPP connection with the GGSN, and returns a valid dynamic IP for the G24-L.	Page 3-276
+MIPOPEN	This command causes the G24-L to initialize a new socket and open a connection with a remote side.	Page 3-277
+MIPODM	This command causes the G24-L to initialize a new socket in Online Data Mode and open a connection with a remote side.	Page 3-279
+MIPCLOSE	This command causes the G24-L to free the socket accumulating buffer and disconnect the G24-L from a remote side.	Page 3-282
+MIPSETS	This command causes the G24-L to set a watermark in the accumulating buffer. When the watermark is reached, data is pushed from the accumulating buffer into the protocol stack.	Page 3-283
+MIPSEND	This command causes the G24-L to transmit the data that the terminal provides, using an existing protocol stack.	Page 3-284
+MIPPUSH	This command causes the G24-L to push the data accumulated in its accumulating buffers into the protocol stack.	Page 3-285
+MIPFLUSH	This command causes the G24-L to flush (delete) data accumulated in its accumulating buffers.	Page 3-286
+MIPRUDP	This unsolicited event is sent to the terminal when data is received from the UDP protocol stack.	Page 3-287
+MIPRTCP	This unsolicited event is sent to the terminal when data is received from the TCP protocol stack.	Page 3-287
+MIPSTAT	This unsolicited event is sent to the terminal indicating a change in link status.	Page 3-288
+MIPXOFF	This unsolicited event is sent to the terminal to stop sending data.	Page 3-288
+MIPXON	This unsolicited event is sent to the terminal when the G24-L has free memory in the accumulating buffer.	Page 3-289
+MIPCONF	Configure Internal TCP/IP stack.	Page 3-289
+MPING	This command will allow verifying IP connectivity to another remote machine (computer) by sending one or more Internet Control Message Protocol (ICMP) Echo Request messages.	Page 3-289
+MPINGSTAT	This is the unsolicited response that the G24-L sends to the terminal to inform of ping execution status update and provide summary statistics of ping request when ping request execution is completed.	Page 3-296
+MSDNS	This command sets/reads DNS IP address for each socket.	Page 3-299
+MIPCFF	This command sets the Filtering List..	Page 3-301
NOP Compatible		
Ignored (Compatible Only) Commands		
%C	This command is supported for backward compatibility only, and has no effect.	Page 3-304

Table 1-1: AT Commands (Cont.)

AT Command	Description	Page
&G	This command is supported for backward compatibility only, and has no effect.	Page 3-304
&J	This command is supported for backward compatibility only, and has no effect.	Page 3-304
&L	This command is supported for backward compatibility only, and has no effect.	Page 3-304
&M	This command is supported for backward compatibility only, and has no effect.	Page 3-304
&P	This command is supported for backward compatibility only, and has no effect.	Page 3-304
&Q	This command is supported for backward compatibility only, and has no effect.	Page 3-304
&R	This command is supported for backward compatibility only, and has no effect.	Page 3-304
&S	This command is supported for backward compatibility only, and has no effect.	Page 3-304
&T	This command is supported for backward compatibility only, and has no effect.	Page 3-304
\B	This command is supported for backward compatibility only, and has no effect.	Page 3-304
\A	This command is supported for backward compatibility only, and has no effect.	Page 3-304
\K	This command is supported for backward compatibility only, and has no effect.	Page 3-304
F	This command is supported for backward compatibility only, and has no effect.	Page 3-304
L	This command is supported for backward compatibility only, and has no effect.	Page 3-304
M	This command is supported for backward compatibility only, and has no effect.	Page 3-304
N	This command is supported for backward compatibility only, and has no effect.	Page 3-304
P	This command is supported for backward compatibility only, and has no effect.	Page 3-304
T	This command is supported for backward compatibility only, and has no effect.	Page 3-304
Y	This command is supported for backward compatibility only, and has no effect.	Page 3-304

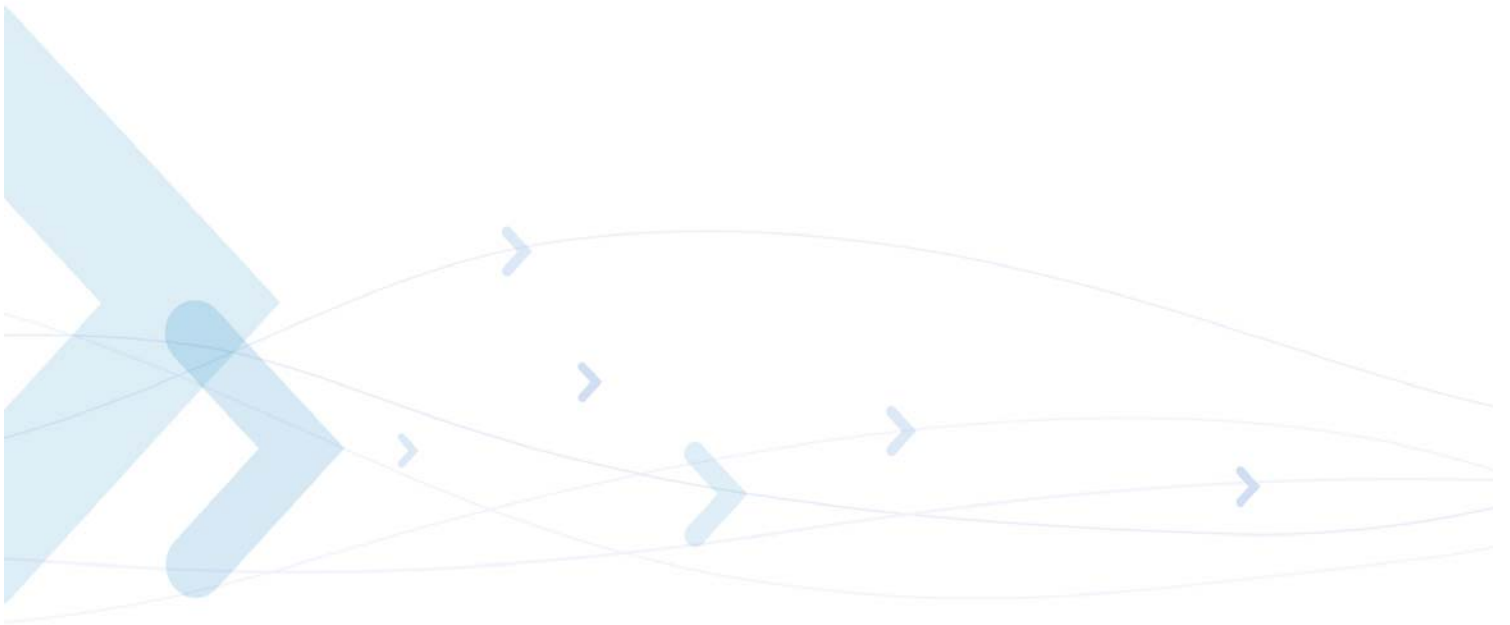

Chapter 2: Introduction to AT Commands

AT Commands Overview

AT commands are sets of commands used for communication with the G24-L cellular modem.

AT commands are comprised of assemblies of ASCII characters which start with the "AT" prefix (except the commands A/ and +++). The AT prefix is derived from the word Attention, which asks the modem to pay attention to the current request (command).

AT commands are used to request services from the G24-L cellular modem, such as:

- Call services: dial, answer and hang up
- Cellular utilities: send/receive SMS
- Modem profiles: Auto Answer
- Cellular Network queries: GSM signal quality

General Symbols Used in AT Commands Description

The following syntax definitions apply in this chapter:

Syntax	Definition
<CR>	Carriage return character, specified by the value of the S3-register.
<LF>	Line-feed character, specified by the value of the S4-register.
<...>	Name enclosed in angle brackets is a syntax element. The brackets themselves do not appear in the command line.
[...]	Optional sub-parameter of a command or an optional part of terminal information response, enclosed in square brackets. The brackets themselves do not appear in the command line. When the sub-parameter is not provided in the parameter type commands, the new value equals its previous value. In action type commands, the action should be performed on the basis of the recommended default setting of the sub-parameter.
//	Denotes a comment, and should not be included in the command.

General System Abbreviations

The basic system configuration contains a modem and a terminal.

The G24-L is the modem and may be referred to as the DCE, the phone, the mobile or the radio.

The terminal may be referred to as the DTE or the TE.

AT Commands Protocol

The figure below shows a general messaging sequence of AT commands protocol between the terminal and the G24-L.

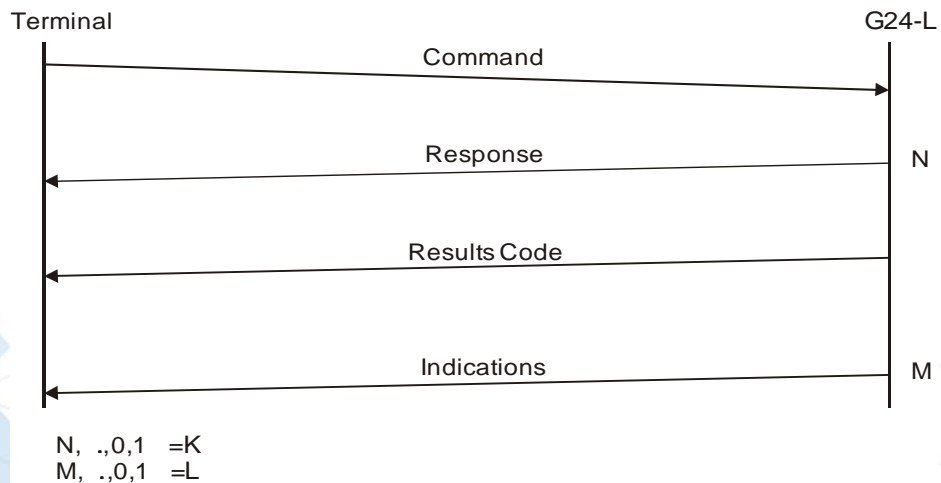

Figure 2-1: AT Commands Protocol

The AT commands interface is basically a Modem Services Upon Request.

Communication (almost) always begins from the terminal side. This means that any service should be requested from the terminal. Thus a request is called a "command".

Each command must be answered by a "results code" from the G24-L. The results code reports the command status to the terminal.

Some commands may include several "Response" requests (between 0 to K) to send data back to the terminal.

Some commands may initiate a mode in which, when specified events are generated in the G24-L, "Indicator" messages are sent asynchronously. Indicators can be between 0 to L.

The G24-L can echo characters received from the terminal (commands) back to the terminal.

AT Commands Structure

Command Structure

An AT command line may contain one or more commands. Delimiters are used to separate the commands from each other, according to the following structure:

Prefix	Command1	Delimiter	Command2	Delimiter	...	CommandN	Suffix
--------	----------	-----------	----------	-----------	-----	----------	--------

Each AT command has the "AT" prefix string.

Each AT command has the suffix <CR>.

The delimiter is either a semicolon ";" or none, meaning space (basic commands).

Each AT command has the following structure:

Token	Mode	Arguments
-------	------	-----------

The following figure outlines the basic structure of an AT command line:

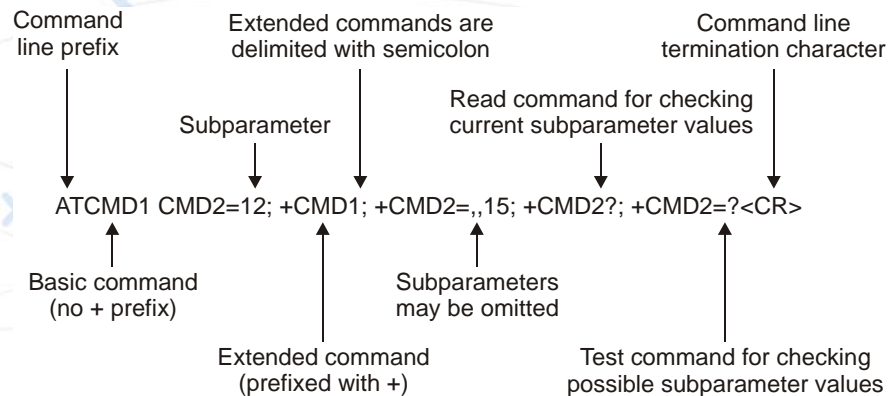

Figure 2-2: Basic Structure of a Command Line

The following rules must be observed when issuing a command line to the modem:

- Every command line must begin with the letters AT.
- Several commands can be concatenated as one line, as long as the total line does not exceed 140 characters with semicolon characters.
- Characters:

Spaces are ignored. You can leave spaces between each command and between characters of a command. You can also include punctuation in telephone numbers, and type commands in either UPPERCASE or lowercase. For example, the following commands are identical:

ATDT8005551234 < Enter > or

atdt (800) 555-1234 < Enter >

Backspace <S5> character is allowed.

- To cancel a dialing command in progress, send any ASCII character to the modem.
- To execute the command line, send the <CR> ASCII character.

Results Code Structure

When a command is issued, the G24-L responds with a message, called a "Result Code", which tells the terminal the result of the command that was requested. Result codes can indicate, for example, the execution status of the command or the remote modem connection status.

Result codes can be represented either as numerical codes or as verbose responses. By default, the G24-L responds with verbose response codes.

The result code has the following structure:

Prefix	Code	Suffix
--------	------	--------

where:

The results code prefix is <CR><LF>.

The results code suffix is <CR><LF>.

Response and Indications Structure

The following is the information response and indications structure:

Token	Separator	Arguments
-------	-----------	-----------

where:

The separator is ":".

The following is an example of Response and Results code:

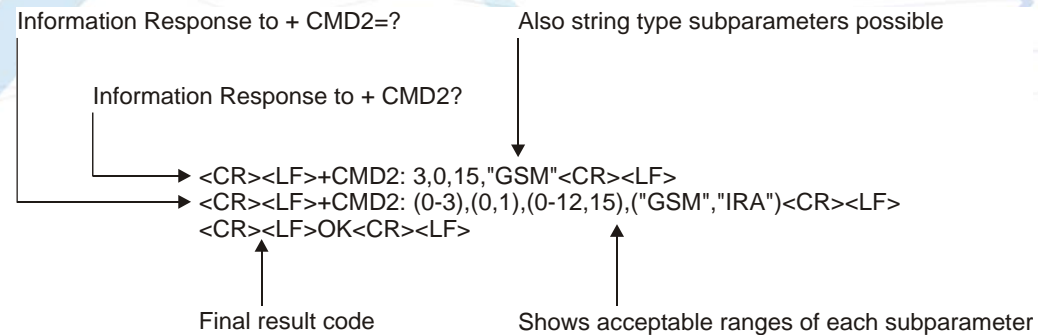

Figure 2-3: Response to a Command Line

If verbose responses are enabled (using the command V1) and all the commands in a command line have been performed successfully, the result code <CR><LF>OK<CR><LF> is sent from the G24-L to the terminal. If numeric responses are enabled (using the command V0), the result code 0<CR> is sent instead.

If verbose responses are enabled (using the command V1) and sub-parameter values of a command are not accepted by the G24-L (or if the command itself is invalid or cannot be performed for any reason), the result code <CR><LF>ERROR<CR><LF> is sent to the terminal and no subsequent commands in the command line are processed. If the numeric responses are enabled (using the command V0), the result code 4<CR> is sent instead. The ERROR (or 4) response may be replaced by +CME ERROR: <err> when the command was not processed due to an error related to G24-L operation.

AT Commands Protocol & Structure Configuration

The AT commands message flow and structure may be configured by the terminal.

The G24-L can be configured not to follow a command with an echo and/or results code. It can be configured to transmit the results code in either of two ways: Verbose or Numeric. This (and other) configurations can be set using the following commands:

Command	Description
S3=[<value>]	Command line termination character (default setting 0x13).
S4=[<value>]	Response formatting character (default 0x10).
S5=[<value>]	Command line editing character (default 0x 8).
E[<value>]	Command echo (default 0, meaning the G24-L does not echo commands).
Q[<value>]	Result code suppression (default 0, meaning the G24-L transmits result codes).
V[<value>]	G24-L response format (default 1, meaning verbose format).
X[<value>]	Defines CONNECT result code format.

The figure below shows the flow and structure configuration commands:

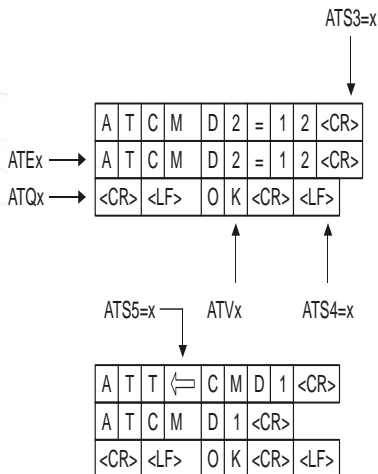

Figure 2-4: Flow and Structure Configuration Commands

Command Token Types

Basic Syntax Command Format

The format of Basic Syntax commands (except for the D and S commands) is:

<command>[**<number>**]

where:

<command> is either a single character, or the "&" character (IA5 2/6) followed by a single character.

Characters used in **<command>** are taken from the set of alphabetic characters.

<number> may be a string of one or more characters from "0" through "9" representing a decimal integer value.

S-parameters

Commands that begin with the letter S constitute a special group of parameters known as "S-parameters". These differ from other commands in important respects:

- The number following the S indicates the "parameter number" being referenced. If the number is not recognized as a valid parameter number, an ERROR result code is issued.
- Immediately following this number, either a "?" or "=" character (IA5 3/15 or 3/13, respectively) appears:

"?" is used to read the current value of the indicated S-parameter.

"=" is used to set the S-parameter to a new value. "<parameter_number>"

"<parameter_number" = [<value>]

If the "=" is used, the new value to be stored in the S-parameter is specified in decimal form following the "=".

Extended Syntax Command Format

Both actions and parameters have names, which are used in the related commands. Names always begin with the character "+" (IA5 2/11). Following the "+", from one to sixteen (16) additional characters appear in the command name.

All (GSM) cellular commands have the prefix "+C".

All Fax commands have the prefix "+F".

All General modem commands have the prefix "+G".

Most Motorola propriety commands have the prefix "+M".

Command Argument Types

<value> consists of either a numeric constant or a string constant.

<compound_value> consist of several **<value>** parameters separated by commas.

Example of **compound_value**: **<value1>,<value2>,...,<valueN>**

Numeric Constants

Numeric constants are expressed in decimal, hexadecimal, or binary form. In the G24-L, the definition of each command specifies which form is used for values associated with that command.

String Constants

String constants consist of a sequence of characters, bounded at the beginning and end by the double-quote character (").

Command Mode Types

Parameter Set Command Syntax

The terminal may store a value or values in a parameter by using the SET command.

The parameter definition indicates, for each value, whether the specification of that value is mandatory or optional. For optional values, the definition indicates the assumed (default) value if none is specified. The assumed value may be either a previous value (that is, the value of an omitted sub-parameter retains its previous value), or a fixed value (for example, the value of an omitted sub-parameter is assumed to be zero). Generally, the default value for numeric parameters is 0, and the default value for string parameters is "" (empty string).

The following syntax are used for:

- Actions that have no sub-parameters: **+<name>**
- Parameters that accept a single value: **+<name>=<value>**
- Parameters that accept more than one value: **+<name>=<compound_value>**

Parameter Read Command Syntax

The terminal can determine the current value or values stored in a parameter by using the following syntax: **+<name>?**

Parameter Test Command Syntax

The terminal can test whether a parameter is implemented in the G24-L, and determine the supported values, by using the following syntax: **+<name>=?**

Values

Range of Values

When the action accepts a single numeric sub-parameter, or the parameter accepts only one numeric value, the set of supported values may be presented in the information text as an ordered list of values.

The following are some examples of value range indications:

Value Range	Description
(0)	Only the value 0 is supported.
(1,2,3)	The values 1, 2, and 3 are supported.
(1-3)	The values 1 through 3 are supported.
(0,4,5,6,9,11,12)	The several listed values are supported.
(0,4-6,9,11-12)	An alternative expression of the above list.

Compound Range of Values

When the action accepts more than one sub-parameter, or the parameter accepts more than one value, the set of supported values may be presented as a list of the parenthetically enclosed value range strings (described above), separated by commas.

For example, the information text in response to testing an action that accepts three sub-parameters, and supports various ranges for each of them, could appear as follows:

(0),(1-3),(0,4-6,9,11-12)

Aborting Commands

Some action commands that require time to execute may be aborted while in progress. This is explicitly noted in the description of the command. Aborting a command is accomplished by transmitting any character from the terminal to the G24-L. A single character is sufficient to abort the command in progress. To ensure that the aborting character is recognized by the G24-L, it should be sent at the same rate as the preceding command line. The G24-L may ignore characters sent at other rates. When an aborting event is recognized by the G24-L, it terminates the command in progress and returns an appropriate result code to the terminal, as specified for the particular command.

When a command is aborted, this does not mean that its operation is reversed. In the case of some network commands, when the abort signal is detected by the G24-L, although the command is aborted following G24-L-network negotiation, the operation might be fully completed, partially completed or not executed at all.

Chapter 3: AT Commands Reference

Modem ID

Subscriber Unit Identity

These commands allow the user to query the type of device that is attached, the technology used in the device, as well as basic operating information about the device.

+CGMI, +GMI, +FMI, Request Manufacturer ID

These commands display manufacturer identification. The G24-L outputs a string containing manufacturer identification information, indicating that this is a Motorola device.

Command	Response/Action
AT+CGMI	+CGMI: "Motorola"
AT+GMI	+CGMI: "Motorola"
AT+FMI	+CGMI: "Motorola"

Example

```
AT+CGMI
+CGMI: "Motorola"
OK
AT+GMI
+CGMI: "Motorola"
OK
AT+FMI
+FMI: "Motorola"
```

+CGMM, +GMM, +FMM, Request Model ID

These commands request the model identification. The G24-L outputs a string containing information about the specific model, including a list of the supported technology used, and the particular model number.

Command	Response/Action
AT+CGMM	+CGMM: <list of supported technologies>,<model>
AT+GMM	+GMM: <list of supported technologies>,<model>
AT+FMM	+FMM: <list of supported technologies>,<model>

Example

```
AT+CGMM
+CGMM: "GSM900","GSM1800","GSM1900","GSM850","MODEL=G24-L"
OK
```

The following table shows the+CGMM string parameters.

String	Description
"GSM900"	GSM at 900 MHz
"GSM1800"	GSM at 1800 MHz
"GSM1900"	GSM at 1900 MHz (North American PCS)
"GSM850"	GSM at 850 MHz

+CGMR, +GMR, +FMR, Request Revision

These commands request the revision identification. The G24-L outputs a string containing the revision identification information of the software version contained within the device.

Command	Response/Action
AT+CGMR	+CGMR: <revision>
AT+GMR	+GMR: <revision>
AT+FMR	+FMR: <revision>

Example

```
AT+CGMR
+CGMR: "G24-L SW 4-0.210-000"
AT+GMR
+GMR: "G24-L SW 4-0.210-000"
AT+FMR
+FMR: "G24-L SW 4-0.210-000"
```

+CGSN, +GSN, Request Product Serial Number Identification

This command displays the product serial number identification IMEI (International Mobile Equipment Identification). It can be used even when the SIM card is not inserted.

Command	Response/Action
AT+CGSN AT+CGSN?	+CGSN: <sn>
+GSN +GSN?	+GSN: <sn>

The following table shows the +CGSN, +GSN parameters.

Table 3-1: +CGSN, +GSN Parameters

<Parameter>	Description
<sn>	The IMEI (International Mobile Station Equipment Identity) number is comprised of 15 digits, as specified by GSM 03.03 [3]. IMEI numbers are composed of the following elements, all in decimal digits: Type Approval Code (TAC) - 6 digits Serial Number (SNR) - 6 digits Spare digit - 1 digit The TAC and SNR are protected against unauthorized changes.

Example

```

AT+CGSN?
+CGSN: "004400013805666"
OK
AT+GSN
+GSN: "004400013805666"
OK

```

+CSCS, Select Terminal Character Set

This command selects the G24-L character set. The G24-L supports the following character sets: GSM, UCS2, UTF8, 8859-1 and ASCII.

The default value, set upon system initialization or when omitting <chset> in set command, is ASCII.

Command Type	Syntax	Response/Action
Set	+CSCS=[<chset>]	OK or: +CMS ERROR: <err>
Read	AT+CSCS?	+CSCS: <selected character set>
Test	AT+CSCS=?	+CSCS: (<supported character sets>)

The following table shows the +CSCS parameter optional values.

Table 3-2: +CSCS Parameters

<chset>	Character Set	Input/Output Format
"ASCII"	ASCII (0x00 - 0x7F)	Quoted string. (For example, "AB" equals two 8-bit characters with decimal values 65, 66.)
"GSM"	GSM default alphabet (GSM 03.38 subclause 6.2.1)	HEX representation.
"UCS2"	Unicode (ISO/IEC 10646 [32])	HEX representation. (For example, 00410042 equals two 16-bit characters with decimal values 65, 66.)
"UTF8"	8-bit Unicode (ISO 10646 transformation format)	HEX representation.
"8859-1"	LATIN (ISO 8859-1)	Quoted string.

Example

```

AT+CSCS=?

```

```

+CSCS: ("8859-1","ASCII","GSM","UCS2","UTF8")
OK
AT+CSCS?
+CSCS: "ASCII"
OK
AT+CPBS = "ME"
AT+CPBW=1,"8475763000",129,"Lin Zhao"
OK
AT+CSCS="UCS2"
OK
AT+CPBR=1
+CPBR: 1,"8475763000",129,004C006E006E0020005A00680061006F
OK
AT+CSCS="ASCII"
OK
AT+CPBR=1
+CPBR: 1,"8475763000",129,"Lin Zhao"
OK

```

+CIMI, Request IMSI

This command displays the International Mobile Subscriber Identity number.

Command	Response/Action
AT+CIMI AT+CIMI?	+CIMI: <imsi> or: +CME ERROR: <err>

Example

```

AT+CIMI
+CIMI: 314566320021400

```

+CFSN, Read Manufacturing Serial Number

This command is used to query the manufacturing serial number.

Command	Response/Action
AT+CFSN?	+CFSN: <Motorola Serial Number>

Example

```

AT+CFSN?
+CFSN: "GLMMA000000069"

```

OK

I, Request Identification Information

This command displays various G24-L information items.

Command	Response/Action
ATIn	<information item n> or: +CMS ERROR: <err>

The following table shows the information items that are supported by the G24-L.

ATIn	Description	Output
1	ROM checksum	"000"
3	Reports Product Title	Motorola GSM Module
5	Reports Software Architecture	N5
7	Reports Product Description	<current module type>
8	Reports Software Version	<current software revision>
9	Reports Flex Version	<current flex version>

Example

```

ATi7
G24-L OEM Module
OK
ATi8
G24-L SW 4-0.210-000
OK
ATi9
G24-L FLEX 0.210-000
OK

```

+CNUM, Request MSISDN(s)

This command displays up to five strings of text information that identify the G24-L. The output string contains double quotes.

On platforms supporting MSISDN numbers, the string(s) returned are the MSISDN numbers and their associated data.

On platforms not supporting MSISDN numbers, this command returns the current phone number of the G24-L.

Read Command

Command	Response/Action
+CNUM (MSISDN supported)	+CNUM: [<MSISDN1 string>,<MSISDN1>,<MSISDN1 type> [+CNUM: [<MSISDN2 string>,<MSISDN2>,<MSISDN2 type>] [...]]
+CNUM (MSISDN not supported)	+CNUM: <phone_number>

The following table shows the +CNUM parameters.

Table 3-3: +CNUM Parameters

<Parameter>	Description
<MSISDN type>	Phone number type 129 Use for local call 145 Use "+" for international access code 128 Unknown

Example

```

AT+CNUM?
+CNUM: "David","035558278",129
AT+CNUM //MSISDNs supported
+CNUM: "PHONENUM1","2173848500",129
+CNUM: "PHONENUM2","2173848501",129
+CNUM: "PHONENUM3","2173848502",129
+CNUM: "", "", 0
+CNUM: "", "", 0
AT+CNUM //MSISDNs not supported
+CNUM: "Motomix","2233445",129
+CNUM: "", "", 0
+CNUM: "", "", 0
+CNUM: "", "", 0

```

\$, List of All Available AT Commands

This command displays a list of all the AT commands supported by the G24-L.

Command	Response/Action
AT\$	List of available AT commands

+CLAC, List of All Available AT Commands

Command	Syntax	Response/Action	Remarks
Execute	+CLAC	List of available AT commands	The Execute command displays a list of all the AT commands supported by the G24-L.

Example

```
AT+CLAC
$
%C
&C
&D
:
:
:
:
\A
\S
OK
```

Capability Reporting

This set of commands enables a user to determine G24-L's protocol level. It also enables other support provided by the G24-L, such as information about the currently implemented protocol version (used to detect older G24-Ls that may not support all commands), as well as determining which optional commands are implemented in a particular G24-L software load.

Call Control

Managing a CSD (Data) Call

The G24-L working modes can be divided into two modes of operation.

- **Data Mode:** In this mode, once the G24-L has established a link with the remote modem, it does not respond to any data passing through it (except for the Escape Sequence search). The G24-L becomes a non-transparent link, connecting the terminal with the remote side.
- **Command Mode:** In this mode, the G24-L responds to the AT commands issued by the terminal. This is the default working mode.

Note: It is possible to switch between the operating modes.

The Terminal mode allows you to instruct the modem to dial a remote modem by issuing the Dial command followed by the phone number. You can also include dial string modifiers in your command line to give the modem additional instructions. The following dial modifiers are available on most modems:

- ", "- Pause

Simple Dialing

In order to instruct the modem to dial a remote modem from an ordinary tone-dialing telephone line, enter the Dial command followed by the phone number. For example, type the following command:

```
ATD 876-5555 <Enter>
```

Note: If you receive characters which were sent, you can disable this with using the Echo command (ATE0 <Enter>).

After issuing the Dial command, and if the remote modem answers the call, the two modems send high-pitched carrier tones to one another which establish the transmission speed and other parameters for the data connection. This process is called negotiation.

After the negotiation process, the message, "OK" followed by the connection speed, is received.

If the other phone line is busy, the message "NO CARRIER" is received.

If the other modem does not answer, the message "NO CARRIER" is received.

Once a connection has been established, the modem is ready to immediately begin transmitting and receiving data. This may vary from sending messages to each other, sending or receiving files, logging on to an information service, or any other data communication task you wish to perform.

Switching From Data Mode to Command Mode

To switch the connection from Data mode to Command mode, send the Escape Sequence command (+++).

If the modem responds with "OK" to the Escape command, the modem is in Command mode and the dial connection is still active, and you can use the AT command set.

The Character '+'

The character '+' in the Escape Sequence pattern can be changed using the S2 S-register. Refer to "S, Bit Map Registers", page 3-194.

Escape is detected only by the G24-L and not by the remote side. The remote side stays in the Data mode.

Hanging Up

If you are using a communications program, use the "Hang up" or "Disconnect" AT command in the program to disconnect the call.

When using computers in the "Dumb Terminal mode", return to the Command mode by typing the Escape Sequence, +++, and then hang up by typing the Hang up command as follows:

```
ATH <Enter>
```

If the G24-L responds with "OK", the dial connection is closed.

Dialing to an Electronic Telephone Service

When you dial to an electronic telephone service such as telephone banking, you must typically instruct the modem to dial a number, then to wait for call establishment, and then send the password for entering the banking account. A typical command line might look like this:

```
ATD876-5555,123456; <Enter>
```

The modem dials the number, then pauses to wait for the call connection (the comma in the command line causes the pause).

You can also create a longer pause by including several commas in a row in the command line, and then send the password to the service.

Receiving a Data Call

```
ATA <Enter>
```

This command instructs the modem to be the "answering modem". Either party may be the answering or the originating modem, but both parties cannot be the same modem at the same time.

You hear the modem handshake and see the result code "CONNECT".

Note: Outgoing Voice Call during CSD Call, when switching to Command mode.

If using Dial Command to make Outgoing Voice Call, currently active CSD Call is dropped and the new Voice Call is generated.

Call Control AT Commands

D, Dial Command

This command places a DATA/VOICE call on the current network.

The default call type is a data call (CSD).

There must be an explicit request in order to make a VOICE call.

If a DATA call was originated and answered by the remote side, a "OK" notification is sent to the terminal from the G24-L, and it moves to the online Data state.

For more information about call failure, use the AT+CEER command, described in [“+CEER, Extended Error Report”](#) on page 3-213.

Note: If there is an active voice call and the terminal sends another ATD voice call command to the G24-L, the active call is put on hold and the new number is called.

Command	Response/Action
ATD<number>[;]	VOICE CALL: 1st response - Voice call place begins OK 2nd response - Voice call connected: OK DATA: 2nd response only - Data call connected CONNECT When MO call fails: 1. Connection Failure - NO CARRIER or BUSY or NO ANSWER 2. General Failure - ERROR 3. Security reason (such as SIM not present) - OPERATION NOT ALLOWED 4. Unknown reason - UNKNOWN CALLING ERROR

The following table shows the D parameters.

Table 3-4: D Parameters

<Parameter>	Description
<number>	Valid phone digits are: 0 1 2 3 4 5 6 7 8 9 * # + and , The following characters are ignored: A B C D - () / and <space>. The comma <, > digit: When dialing a voice call, digits until the comma are considered addressing information (phone number). Any digits after the comma are sent as DTMF tones after the voice call is connected. More than one comma causes a pause in sending the tones. When dialing a data/fax call, the comma digit is ignored, and all other digits before and after the comma are considered addressing information (phone number). The plus <+ > digit: Indicates that the international access code exists in the number.
semicolon (;)	When given after <number string>, a voice call is originated to the given address, otherwise a data call is originated.

Note: ATDP, ATDT, AT*D, <T>, <P> and <*> are ignored. The command is handled as ATD. Initiating a GPRS connection is done through ATD*99#, as described in [“D*99, Request GPRS Service “D””](#) on page 3-242.

Example

```

atd44345678; //VOICE call (with semicolon)
OK
OK
atd44345678 //DATA call (without semicolon)
...
CONNECT //Move to online Data state
    
```

D>, Direct Dialing from Phone Books

This command places a FAX/DATA/VOICE call on the current network by dialing directly from the G24-L phone book.

- Notes:**
- "+CME ERROR: not found" is returned when no match is found in an existing phone book.
 - FD phone book supports the (?) wild card character. Telephone numbers containing this character cannot be dialed directly from the phone book.
 - "+CME ERROR: Invalid index" is returned when entry <n> is out of the requested Phonebook range.
 - When SM phonebook is searched and the given entry value is of the ME phonebook, ME phonebook will be searched as well (result code would be the same as if MT phonebook was searched).

The following table shows a detailed description for the D> commands.

Command	Detailed Description
D><alpha>[:;]	Originates a call to a phone number with the corresponding alphanumeric field <alpha>. The Current Phone Book (Set by +CPBS) is searched for the entry that begins with the alphanumeric pattern <alpha>.
D>mem<n>[:;]	Originates a call to a phone number in memory (phone book) mem and stored in entry location <n>. Available memories may be queried with Select Phone Book Storage Test command +CPBS=?. Note: This command does not change the used memory set.
D><n>[:;]	Originates a call to a phone number from entry location <n> in the Current Phone Book (Set by +CPBS).

Note: Current used memory (phone book) set/read is done through the memory command +CPBS=/+CPBS? respectively.

The following table shows the D> parameters.

Table 3-5: D> Parameters

<Parameter>	Description
<"alpha">	String type value, which should be equal to an alphanumeric field in a phone book entry. The used character set should be the one selected with Select Terminal Character Set +CSCS. <alpha> is case-sensitive, and should be placed in quotes ("alpha").
<n>	This parameter is also called "speed dial location". It is an integer type memory location. <n> should be in the range of locations available in the memory used.
<mem>	This parameter is not case-sensitive.

Example

```
AT+CPBS="me"           //Phone flash memory
OK
AT+CSCS="ASCII"       //ASCII characters
OK
AT+CPBW=1,"035659090",129,"VoiceMail"
OK
AT+CPBR=1
+CPBR: 001,"035659090",129,"VoiceMail"
OK
atd>"VoiceMail";     //Phonebook by name
OK
OK
ath
NO CARRIER
OK
```

```

atd>1; //Speed dial from phonebook
OK
OK
ath
NO CARRIER
OK
atd>1 //Speed dial from phonebook
+CME ERROR: //Invalid characters in dial string
atd>"Motorola Internal"
+CME ERROR: //Invalid characters in dial string
    
```

For more examples, refer to [“Call Control” on page 4-14](#) and [“Data Call” on page 4-18](#).

DL, Dial Last Number

The DL command places a data/voice call to the last number dialed. The call progress information (success/failure) is reported in the same way as for the Dial command. (Refer to [“D, Dial Command”, page 3-11](#)).

Command	Detailed Description
ATDL[;]	Initial Response - Last Number retrieved: ATDL: "DIAL DIGITS" 2nd response - Data/Fax call connected CONNECT 1st response - Voice call placement begins OK 2nd response - Voice call connected OK

The following table shows the DL parameters.

Table 3-6: DL Parameters

<Parameter>	Description
semicolon (;)	If the semicolon (;) is given, a voice call is originated to the last dialed number. If the semicolon (;) is not given, a Fax/Data call is originated. Note: The last dialed call type is irrelevant to the DL command.

Note: When ATDL is issued after a dialed number with comma digit:

- ATDL; (Voice) dials the exact number that was last dialed, including the DTMF tones sent.
- ATDL (Data/Fax) dials the addressing information only (comma and tones are discarded).
- If ATDL is sent before any Dial command was issued (mainly after Power On, when the last number is an empty field), the G24-L will return NO CARRIER, as mentioned in the ITU V.25-ter standard.

Example

```

atdl //Last called number is "035658278"
ATDL: "035658278"
OK //DATA call
atdl;
ATDL: "035658278"
OK
OK //VOICE call
atdl //Last called number is "035658278,123,78;"
ATDL: "035658278"
CONNECT //DATA call
atdl; //Last called number is "035658278,123,78"
ATDL: "035658278p123p78"
OK
OK //VOICE call
1 2 3 //Sent as DTMF tones
... //Pause
7 8 //Sent as DTMF tones

```

H, Hang-up Call

This command hangs up a call. The G24-L terminates the call whether it is a data or voice call, and whether it is an incoming, originating, waiting, or connected call.

A NO CARRIER message is returned to the terminal before the regular OK approval.

Note: To terminate (hang-up) a MO data/fax call while call is placed: Any character sent from the terminal to the G24-L causes the Data/Fax call termination, and NO CARRIER is sent from the G24-L to the terminal.

To terminate a held Voice call or to terminate a call out of a MTPY call, refer to [“+CHLD, Call Related Supplementary Services Command” on page 3-23](#).

The following table shows the call states of the H command.

Call State	Response/Action
IDLE	Error 3 ("operation not allowed")
Single Active	Call released
MTPY Active	Call released (all calls)
Incoming call (RING)	Call released

Call State	Response/Action
Single Active and Waiting Call	Single Active released (waiting not affected)
MTPY Active and Waiting Call	MTPY Active released (waiting not affected)
Single Held or MTPY Held	Error 3
Single (or MTPY) Active and Single (or MTPY) Held	Single (or MTPY) Active released
Held (Single or MTPY) and Waiting Call	Waiting call released
Single (or MTPY) Active and Single (or MTPY) Held & Waiting call	Single (or MTPY) Active released

Example

```

RING //Incoming call
RING //Incoming call
ath //Hang-up incoming call
NO CARRIER
OK //Incoming call has been terminated - user determined user busy
RING
ata
OK //Voice call connected
ath //Hang-up connected call
NO CARRIER
OK //Active call has been hung-up - terminated
(... Active multi party call, with 3 numbers ...)
ath
NO CARRIER
NO CARRIER
NO CARRIER
OK
atd035659260;
OK
ath //Terminate MO voice call while placed
NO CARRIER
OK
Example - Hanging up a data call:
atd035659260
CONNECT //Data call connected - Online Data mode
...
+++ //ESC Sequence is sent from the terminal to the G24-L
OK //The G24-L is in Command mode
ath //Terminate Data call
NO CARRIER
OK
    
```

A, Answer Incoming Call

This command answers an incoming VOICE/DATA/FAX call after a RING/+CRING indication is sent to the terminal.

If the incoming call is answered (connected), the G24-L sends a CONNECT notification to the terminal.

If the MT call fails, the possible notifications are:

- NO CARRIER - Connection Failure
- ERROR - General Failure

Note: A waiting call (an incoming call while a call is in progress) is announced by +CCWA rather than RING. A waiting call can be answered only if it is a voice call. The waiting voice call should be answered using the ATA command, which will put the active call on hold and will connect the waiting call, making it the active call. This ATA action is the same action as AT+CHLD=2.

Example

Example - Answering a voice call:

```
AT+CRC=1
```

```
+CRING: VOICE
```

```
+CRING: VOICE
```

```
ata
```

```
OK
```

```
//VOICE call connected - G24-L is in Command mode
```

```
ath
```

```
NO CARRIER
```

```
OK
```

Example - Answering a data call:

```
+CRING: REL ASYNC
```

```
+CRING: REL ASYNC
```

```
ata
```

```
...
```

```
//Connecting (dots are not displayed)
```

```
OK
```

```
//DATA call connected - G24-L is in Online Data mode
```

Note: In a CSD call, call release is not valid during the phase of call negotiation (from OK until connect call).

+CRC, Cellular Result Codes and RING, +CRING - Incoming Call Indication

This command controls whether or not to present the extended format of an incoming call indication. The RING/+CRING indication is sent from the G24-L to the terminal when the G24-L is alerted by an incoming call from the network. Once this indication is sent, information is available on the calling line via +CLIP. When +CRC is disabled, the indication is RING, and when +CRC is enabled, the indication is +CRING.

Command Type	Syntax	Response/Action	Remarks
Set	+CRC=[<n>]	OK	The Set command enables/disables the extended format of an incoming call indication. When enabled, an incoming call is indicated to the terminal with an unsolicited result code +CRING:<type> instead of the normal RING.
Read	+CRC?	+CRC: <n> OK	The Read command queries the current settings for the cellular result code.
Test	+CRC=?	+CRC: (list of supported <n>s)	The Test command returns the possible <n> values.

RING/+CRING Indication

+CRING: <type>
or:
RING

The following table shows the +CRC parameters.

Table 3-7: +CRC Parameters

<Parameter>	Description
<n>	0 Extended format disabled 1 Extended format enabled The default value is 0.
<type> ASYNCCSD REL ASYNCCSD FAX VOICE ALT	Type of incoming call: asynchronous transparent asynchronous non-transparent Fax class 1 Normal voice Fax/voice

Example

```
AT+CRC?
+CRC: 0
OK
AT+CRC=?
+CRC: (0-1)
OK
```

Example - RING/+CRING indication

```
(..Incoming Data Call..)
RING
RING
```

```

RING
AT+CRC=1 //Enable extended ring format
OK
+CRING: REL ASYNC
+CRING: REL ASYNC
ath
AT+CRC=1
OK //Mobile fax call terminated (multi-numbered scheme) from PSTN
fax machine
+CRING: ALT Voice/Fax
NO CARRIER
OK

```

+CLIP, Calling Line Identification

This command controls the Calling Line Identity (CLI) presentation indication to the terminal when an incoming call is detected by the G24-L.

This command allows the user to query the provisioning status of the CLI by the network and by the G24-L. The command also allows the user to enable/disable the CLI presentation by the G24-L to the terminal.

The +CLIP indication information varies depending on what is provided by the network and what information is stored in the G24-L phone book.

Command Type	Syntax	Response/Action	Remarks
Set	AT+CLIP=<n>	OK +CME ERROR: <err>	The Set command enables or disables the presentation of the CLI indication from the G24-L to the terminal. Note: The Set command does not address the network.
Read	AT+CLIP?	+CLIP: <n>, <m> OK	The Read command returns the +CLIP enable/disable state in the G24-L as well as in the network provisioning state of the CLI presentation.
Test			The Test command returns the Set command options (0,1).

+CLIP Indication

When the CLI presentation indication is enabled by the G24-L (<n>=1), this unsolicited indication is sent to the terminal after the RING indication.

```
+CLIP:<number>,<type>[,<subaddr>,<satype>[[<alpha>][,<CLI validity>]]]
```

The following table shows the +CLIP parameters.

Table 3-8: +CLIP Parameters

<Parameter>	Description
<n>	Enables/disables the CLI presentation indication after the ring indication: 0 Disable CLI presentation 1 Enable CLI presentation The default is 0.
<m>	Shows the subscriber CLIP service status in the network: 0 CLIP not provisioned 1 CLIP provisioned 2 Unknown (for example, no network and so on)
<"number">	Calling line number. The number format is specified by <type>.
<type>	Type of address octet in integer format: 145 Default when the dialing string includes the international access code character "+". 129 Default when making a local call. 128 Type of number is unknown (usually the output when the number itself is unknown).
<subaddr>	NULL, field not used (String type subaddress of format specified by <satype>)
<satype>	Field not used. Value is always 128 (unknown) - type of sub address octet in integer format.
<"alpha">	Name of the calling party (if provided by the network or if the number is found in the G24-L phone books).
<CLI validity>	The Validity of the Calling Line Identity presentation: 0 CLI valid. 1 CLI has been withheld by the originator. 2 CLI is not available due to networking problems or limitations of the originating network.

Example

```

AT+CLIP=?
+CLIP: (0,1) //CLI presentation is disabled by the G24-L (0) and is enabled by the
network (1)
OK
AT+CLIP=1
OK
Example +CLIP indication:
(...incoming call...)
RING
+CLIP: "2173845400",129,,128,"Doe John",0
Example +CLIP indication with restricted CLI:
AT+CRCL=1
OK
(...incoming call..., caller restricted the CLI presentation (used AT+CLIR)...)
+CRING: VOICE
+CLIP: "",128,,128,"",1

```

+CCWA, Call Waiting Command

This command controls the Call Waiting supplementary service, including the settings and the queries of the G24-L and the network. When the Call Waiting indication is enabled by the G24-L and there is a waiting call, a +CCWA: indication is sent from the G24-L to the terminal.

Note: The G24-L supports only one of the services at a time: Voice, Data or Fax. Multiparty is a voice-only functionality.

A CCWA indication is sent to the terminal only during a voice call-waiting event. A CCWA indication is not sent for a fax/data call during in a voice session.

Action	Syntax	Response	Remarks
Set	+CCWA=[<n>[, <mode>[,<class>]]]	OK If <mode>=2 and the command succeeds: +CCWA: <status>,<class1> [<CR><LF>+CCWA: <status>,<class2> [...]] OK	The Set command enables/disables the Call-Waiting indication in the G24-L and in the network. Activation, deactivation and status query are supported. Note: When the <mode> parameter is set to 2 (network query), the <n> parameter is ignored. This means that no enable/disable action is performed while querying the network.
Read	+CCWA?	+CCWA: <n> OK	The Read command returns the enable/disable status of the call waiting indication in the G24-L (<n>).
Test	+CCWA=?	+CCWA: (list of supported <n>s)	The Test command returns <n> values supported by the G24-L as a compound value.

+CCWA Indication

When a call-waiting indication is enabled by the G24-L (<n>=1), the following unsolicited indication is sent to the terminal from the G24-L:

+CCWA:<number>,<type>,<class>,[<alpha>],[<CLI validity>]

The following table shows the +CCWA parameters.

Table 3-9: +CCWA Parameters

<Parameter>	Description
<n>	Enables/disables the call waiting indication to the terminal by the G24-L. 0 - Disable 1 - Enable The default is 0.
<mode>	Call waiting service request to the network. When the <mode> parameter is not given, the network is not interrogated. 0 - Disable 1 - Enable 2 - Query status
<class>	Sum of integers each representing a class of information. 1 - Voice (telephony) 2 - Data (refers to all bearer services) 4 - Fax (facsimile services) The default value is 7.
<"number">	Calling line number. The number format is specified by <type>.
<type>	Type of address octet in integer format: 145 - Default when the dialing string includes the international access code character "+". 129 - Default when making a local call. 128 - Type of number is unknown (usually the output when the number itself is unknown)
<status>	Call waiting support by the network (output for <mode>=2). 0 - Not active 1 - Active
<"alpha">	Name of the calling party (if provided by the network or if the number is found in the G24-L phone books).
<CLI validity>	The Validity of the Calling Line Identity presentation: 0 - CLI valid. 1 - CLI has been withheld by the originator. 2 - CLI is not available due to networking problems or limitations of the originating network.

Note: When the parameter <mode> is 2 (Query status), the first parameter is ignored and the third parameter is always treated as class = 7.

Example

```
AT+CCWA=1           //Enable call waiting on G24-L
OK
AT+CCWA=?
+CCWA: (0,1)
OK
AT+CCWA?
+CCWA: 1
```

```

OK
Examples of +CCWA set command - network interrogation
AT+CCWA=1,2           //Class parameter is considered as 7
+CCWA: 1,1           //Call waiting is active for class 1, voice
+CCWA: 2,0           //Call waiting is not active for class 2, data
+CCWA: 4,0           //Call waiting is not active for class 4, fax
OK
AT+CCWA=1,2,2         //Class parameter is 2
+CCWA: 2,0           //Call waiting is not active for class 2, data
+CCWA: 4,0           //Call waiting is not active for class 4, fax
OK
AT+CCWA=1,1
OK                     //Enable the call waiting feature in the network, and in the G24-L
Example +CCWA indication
atd9311234567;        //Originate a voice call
OK
OK                     //Voice call connected
(...conversation...)
(... call waiting indication received by the G24-L ...)
+CCWA: "+358317654321",145,1,"Bob"
+CCWA: "+358317654321",145,1,"Bob"
AT+CHLD=0             //Release the waiting call
OK
NO CARRIER
AT+CRC=1              //RING indication is not relevant to CCWA indication
OK
(...waiting call..., caller restricted to its CLI presentation (used AT+CLIR)...)
+CCWA: "",128,1,"",1 //CLI is restricted, but call type recognized as voice
+CCWA: "",128,1,"",1

```

+CHLD, Call Related Supplementary Services Command

This command controls the Call Hold and Multiparty Conversation services. This command manipulates voice calls only.

Set Command

The Set command allows the control of the following call related services:

- Call HOLD: A call can be temporarily disconnected from the G24-L, but the connection is retained by the network.
- MTPY (Multi party) Conversation: Conference calls.

The network does not reserve more than one traffic channel for a mobile station, therefore the G24-L can have only one call on hold at a time.

Note: Only voice calls can be put on HOLD.

A precondition for the multi-party service is that the G24-L is in control of one active call and one call on hold. In this situation, the G24-L can request the network to begin the MTPY (Multi Party) service. Once a MTPY call is active, remote parties may be added, disconnected or separated (removed from the MTPY call, but remain connected to the served mobile subscriber). The maximum number of remote parties is 5.

In this command, the term CALL refers to a single or MTPY call.

A single Active call is considered a MTPY call with one call index numbered as 1.

Command	Response/Action
+CHLD=<n>	If the call is terminated: OK (approve request was submitted) NO CARRIER If the call state is changed (link, split, from active to hold, and so on): OK (approve request was done) If the call is terminated and another call is answered: OK (approve request was submitted) NO CARRIER OK (call answered and is now connected)

Command Type	Syntax	Response/Action	Remarks
Test	+CHLD=?	+CHLD: (list of supported <n>s) OK	The Test command returns <n> values supported by the G24-L to the terminal

The following table shows the +CHLD parameters.

Table 3-10: +CHLD Parameters

<Parameter>	Description
<n>	Call hold operation: 0 - Releases all held calls OR Sets User Determined User Busy for a waiting call 1 - Releases all active calls and accepts the held or waiting call 1x - Release specific call x, where x is the serial number of a call participating in an active MTPY call. 2 - Places all active calls on hold and accepts the held or waiting call 2x - In the case of an active MTPY call, places all active calls on hold, except for call x. Call x remains active. 3 - Adds a held call to the conversation - MTPY Note: "Held calls" or "active calls" means a held or active single or MTPY call. There cannot be two or more different held/active single/MTPY calls.

The following table shows the +CHLD actions according to state and operation:

Table 3-11: +CHLD Actions According to Call State and Operation

Call State	CHLD <operation>					
	0 -Release Held Call	1 - Release Active Call, Accept Held Call	1x - Release Active/Held Call x from MTPY Call	2 - Switch Between Held and Active Call	2x - Active MTPY Call to Hold, Except for Call x	3 - Add Held Call to Active Call
IDLE	Error 3					
Single Active Call	Error 3.	Releases active call.	If x=1, releases active call, otherwise error 22.	Puts active call on hold.	Error 3.	Error 3.
MTPY Active Call	Error 3.	Releases active call.	Releases specific active call x. If x does not exist, then error 22.	Puts active call on hold.	Split. If call x does not exist, then error 22.	Error 3.
Incoming Call (RING)	Error 3.					
Single Active Call and Waiting Call	Releases waiting call.	Releases active call, accepts waiting call.	Releases specific active call x. If x does not exist, then error 22.	Puts active call on hold, accepts waiting call.	Error 3.	Error 3.
MTPY Active Call and Waiting Call	Releases waiting call.	Releases active call, accepts waiting call.	Releases specific active call x. If x does not exist, then error 22.	Puts active call on hold and accepts waiting call.	Split. If x does not exist, then error 22.	Error 3.
Single Held Call	Releases held call.	Accepts held call.	Releases held call.	Accepts held call.	Error 3.	Error 3.
MTPY Held Call	Releases held call.	Accepts held call.	Releases specific call x. If x does not exist, then error 22.	Accepts held call.	Error 3.	Error 3.
Single (or MTPY) Active Call and Single (or MTPY) Held Call	Releases held call.	Releases active call and accepts held call.	Releases specific active call x. If x does not exist, then error 22.	Switches.	Error 3.	Makes a conference call.

Table 3-11: +CHLD Actions According to Call State and Operation (Cont.)

Call State	CHLD <operation>					
	0 -Release Held Call	1 - Release Active Call, Accept Held Call	1x - Release Active/Held Call x from MTPY Call	2 - Switch Between Held and Active Call	2x - Active MTPY Call to Hold, Except for Call x	3 - Add Held Call to Active Call
Held (Single or MTPY) Call and Waiting Call	Releases waiting call.	Accepts waiting call.	Error 3.	Accepts waiting call.	Error 3.	Error 3.
Single (or MTPY) Active Call and Single (or MTPY) Held and Waiting Call	Releases waiting call.	Releases active call, and accepts waiting call.	Releases specific active call x. If x does not exist, then error 22.	Error 3 (too many calls on hold).	Error 3.	Makes a conference call. Waiting call is not touched.
Split: Places the active MTPY call on hold, except for a specific call x. Switch: Places the active call on hold and accepts the Held call Error 3: "Operation not allowed" Error 22: "Not found"						

Example

```

AT+CHLD=?
+CHLD: (0,1,1x,2,2x,3)
OK
AT+CCWA=1 //Enable call waiting
OK
atd9311234567; //Originate a voice call
OK
OK
(...conversation...)
+CCWA: "+358317654321",145,1,"Bob" //Awaiting call alerts
AT+CHLD=2 //Put first call on hold and answer the second call
OK
(...conversation...)
AT+CHLD=3 //Add the held call to the conversation
OK
(...MTPY conversation...)
AT+CHLD=22 //Split: Place the MO active call on hold, MT call remains active
OK
AT+CHLD=0 //Release the held call
OK
NO CARRIER
ath //Release the active call
NO CARRIER
OK
atd9311234567; //Originate a voice call
OK
    
```

```

OK
+CCWA: "055728386",129,1,"",0 //Waiting call alerts
AT+CHLD=1 //Release the active call, accept the waiting call
OK
NO CARRIER //Active 9311234567 was released
OK //Waiting 055728386 was answered

```

+CCFC, Call Forwarding Number and Conditions

This command enables control of the call-forwarding supplementary service. Registration, erasure, activation, deactivation, and status query are supported.

Command Type	Syntax	Response/Action	Remarks
Set	+CCFC=<reason>,<mode> [,<number>[,<type>[,<class> [,<subaddr>[,<satype>[,<time>]]]]]]	<p>If the command succeeds:</p> <p>+CCFC: <status>,<class1>[,<number>,<type> [,<subaddr>,<satype>[,<time>]]][<CR><LF></p> <p>+CCFC: <status>,<class2>[,<number>,<type> [,<subaddr>,<satype>[,<time>]]][...]</p> <p>+CCFC: (list of supported <reason>s)</p>	The Set command instructs the G24-L which call forwarding settings to request from network. The Set command, in query mode, interrogates the network about the subscriber current call forwarding status.
Test	+CCFC=?	+CCFC:<reason> OK	The Test command returns <reason> values supported by the G24-L to the terminal.

The following table shows the +CCFC parameters.

Table 3-12: +CCFC Parameters

<Parameter>	Description
<reason>	0 - Unconditional 1 - Mobile busy 2 - No reply 3 - Not reachable 4 - All call forwarding 5 - All conditional call forwarding
<mode>	0 - Disable 1 - Enable 2 - Query status 3 - Registration 4 - Erasure
<"number">	Calling line number. The number format is specified by <type>.
<type>	Type of address octet in integer format-. 145 Default when dialing string includes international access code character "+". 129 Default when making a local call.
<subaddr>	NULL, field not used (String type subaddress of format specified by <satype>).
<satype>	Field not used. Value is always 128 (unknown) - type of sub address octet in integer format.
<class>	The sum of integers each representing a class of information. 1 - Voice 2 - Data - refers to all bearer services. 4 - Fax The default value is 7.
<time>	1-30 - The number of seconds to wait before calls are forwarded, when "no reply" is enabled or queried. The default value is 20. Note: The parameter must be a multiple of 5, for example, 5, 10, 15 and so on. If not, the modulo of 5 will be ignored.
<status>	0 - Not active 1 - Active

Note: A forward-to phone <number> (and the optional fields <type>, <subaddr> and <satype>) are tied to a <reason> and a <class>. This means that there can be a different <number> for the same <reason> because of a different <class>. When registering without mentioning a <class>, <class>=7 is selected.

A <number> field is mandatory when registering (<mode>=3) and it is irrelevant (ignored) in all other <mode>s.

Example

```

AT+CCFC=?
+CCFC: (0-5)
OK
AT+CCFC=0,3,"01256316830",129,1
OK
AT+CCFC=1,3,"0545658278",129,1 //Register UC forward-to of all classes.
OK
AT+CCFC=1,1 //Activate UC forward-to of all classes.
OK
AT+CCFC=1,2 //Interrogate reason not-reachable of all classes.
+CCFC: 1,1,"+97254151200",145
+CCFC: 0,2,"",0
+CCFC: 0,4,"",0
OK //For <reason>=3, forward only voice calls is activated.
AT+CCFC=4,2 //Interrogate reason all-call-forwarding for all classes.
+CME ERROR: no network service //Interrogation of <reason>=30 is not supported by network.
AT+CCFC=2,3,"+972545658278"
OK
AT+CCFC=2,0 //Disable call-forwarding for reason no-reply of all classes.
OK
AT+CCFC=2,2
+CCFC: 0,1,"+972545658278",145,,25
+CCFC: 0,2,"+972545658278",145,,25
+CCFC: 0,4,"+972545658278",145,,25
OK

```

+CLIR, Calling Line Identification Restriction

This command instructs the G24-L to query, enable or disable the presentation of the CLI (calling line ID) of a MO call to the called party. The restriction of the CLI (disable presentation) is dependent both on the G24-L and on the network.

The network enables three possible provisions of CLIR:

- Not provisioned (CLIR Off - presentation allowed)
- Provisioned permanently
- Provisioned with Temporary mode

The provision is fixed and cannot be changed by an AT command.

Temporary Mode:

Temporary mode can be in one of two states:

- A - Presentation restricted (CLIR On) as default.
- B - Presentation allowed (CLIR Off) as default. A subscriber to Temporary mode always has a default subscription to state A or B. Temporary-mode provisioning means that the terminal can request the G24-L to switch the default mode from A to B, and vice versa.

Note: When a service is in state A, and the terminal wants to enable the CLI presentation (turn CLIR off) for a single call, it can do so using the ATD command. This does not change the Temporary mode state. This can also be done when the service is in state B and the terminal wants to disable the CLI presentation (turn CLIR on) for a single call.

Command Type	Syntax	Response/Action	Remarks
Set	+CLIR=<n>	OK	The Set command instructs the G24-L to enable/disable CLI restriction for all MO calls.
Read	+CLIR?	+CLIR:<n>,<m> OK	The Read command returns the current setting of CLIR on the network <m> and on the G24-L <n>.
Test	+CLIR=?	+CLIR: (list of supported <n>s)	The Test command returns <n> values supported by the G24-L.

The following table shows the +CLIR parameters.

Table 3-13: +CLIR Parameters

<Parameter>	Description
<n>	Adjustment for outgoing calls 0 - Presentation indicator is used according to the subscription of the CLIR service 1 - CLIR invocation 2 - CLIR suppression The default is 2.
<m>	Subscriber CLIR service status in the network 0 - CLIR not provisioned 1 - CLIR provisioned in permanent mode 2 - Unknown (for example, no network and so on) 3 - CLIR Temporary mode presentation restricted (can be the default) 4 - CLIR Temporary mode presentation allowed (can be the default)

Example

```

AT+CLIR=?
+CLIR: (0,1,2)
OK
AT+CLIR?
+CLIR: 1,4
AT+CLIR=2
OK
atd054565195;           //MO voice call
OK
(... calling ...)
(... a G24-L that has 054565195 SIM and is CLIP enabled will receive the following on the terminal:
RING
+CLIP: "",128,,128,"",1
    
```

```

RING
+CLIP: "",128,,128,"",1)
ath
NO CARRIER
OK
AT+CLIR=0
OK
atd054565195;           //MO voice call
OK
(... calling ...)
(... a G24-L that has 054565195 SIM and is CLIP enabled will receive the following on the terminal:
RING
+CLIP: "054565006",129,,128,"",0
RING
+CLIP: "054565006",129,,128,"",0 ...)
ath
NO CARRIER
OK

```

+CBST, Select Bearer Service Type

This command sets the GSM bearer service (data circuit duplex asynchronous and synchronous). It chooses one of the bearer services, the data rate of the service (actually the modulation when modem IWFs are used), and enables or disables the Radio Link Protocol.

Command Type	Syntax	Response/Action	Remarks
Set	AT+CBST=[<speed>,<name>[,<ce>]]	OK +CME ERROR: <err>	<p>The Set command selects the bearer service <name> with data rate <speed> and the connection element <ce> to be used when data calls are originated (refer to GSM 02.02). Values may also be used during mobile terminated data call setup, especially in the case of single numbering scheme calls.</p> <p>Note: For incoming calls, the bearer service will be taken automatically from incoming parameters and not according to the CBST Set command.</p> <p>The G24-L does not change the output, but for incoming calls, the phone works in automatic mode.</p>

Command Type	Syntax	Response/Action	Remarks
Read	AT+CBST?	+CBST: <speed>,<name>,<ce> OK	
Test	AT+CBST=?	+CBST: (list of supported <speed>s),(list of supported <name>s),(list of supported <ce>s) OK	The Test command returns values supported by the MA as compound values.

The following table shows the +CBST parameters.

Table 3-14: +CBST Parameters

<Parameter>	Description
<speed>	0 - Auto-bauding (automatic selection of the speed; this setting is possible in case of 3.1 kHz modem and non-transparent service) 6 - 4800 bps (V.32) 7 - 9600 bps (V.32) 14 - 14400 bps (V.34) 68 - 2400 bps (V.110 or X.31 flag stuffing) 70 - 4800 bps (V.110 or X.31 flag stuffing) 71 - 9600 bps (V.110 or X.31 flag stuffing) 75 - 14400 bps (V.110 or X.31 flag stuffing) The default value is 7. Note: Currently the G24-L supports: 2 baud rates: 4800 and 9600 bps 2 protocols: V.110 and V.32
<name>	0 - Data circuit asynchronous (UDI or 3.1 kHz modem) 1 - Data circuit synchronous (UDI or 3.1 kHz modem) The default value is 0.
<ce>	0 - Transparent (Reserved for future implementation) 1 - Non-transparent (default)

Example

```

AT+CBST=?
+CBST: (000,004,006,007,014,068,070,071,075),(000-001),(000-003)
OK
AT+CBST?
+CBST: 007,000,001
OK
AT+CBST=6
OK
AT+CBST?
+CBST: 006,000,001
OK
    
```

O, Return to Online Data State

This command returns the G24-L from the Command mode to the Online Data mode and issues a CONNECT or CONNECT <text> result code.

After dialing or answering (atd/ata commands and connect), the phone enters the Online Data mode where it is able to transfer data, but not to enter AT commands.

The ESC command +++, transfers the phone to the Command mode (able to input AT commands, while preserving the Data call). The O command returns the phone to the fully Online Data mode (as it was before using the ESC command).

Note: The escape character '+' can be changed using the S2-register.

The time delay between consecutive escape characters is configured using the S12-register.

Command Type	Syntax	Response/Action
Execute	ATO	CONNECT +CME ERROR: <err> If phone is not in Data Call NO CARRIER: If connection is not successfully resumed.

Example

```

ATD035684072           //Calling a remote modem - data call
CONNECT                //G24-L is in Data mode
                        //Escaping back to Command mode using the +++ sequence

OK
AT                     //G24-L is in Command mode
OK
ATO                     //Returning to Data mode
CONNECT

```

&Q, Asynchronous Mode

This command selects the asynchronous mode, and has no effect.

Qn	Description
Q0	Normal asynchronous operation (no error correction)
Q5	Error corrected operation (default)
Q6	Normal asynchronous operation (no error correction)

+CHUP, Hang Up Call

This command causes the G24-L to hang up the current GSM call.

Command Type	Syntax	Response/Action	Remarks
Set	+CHUP	OK +CME ERROR <err>	The Set command hangs up the current GSM call.

+CSNS, Single Numbering Call Scheme

This command handles the selection of the bearer or teleservice to be used when a mobile terminated single numbering scheme call is established. If the calling party specifies the required bearer capability, this capability is used for the call setup attempt. If the calling party does not specify the required bearer capability (for example, because the call originated in the PSTN), the network attempts to determine it, as described below.

Some cellular networks use a multi-numbering scheme, where several mobile station ISDN numbers, or MSISDNs, are associated with one IMSI in order to define the bearer capability by the MSISDN. Each MSISDN is used for a different bearer capability. If the network uses a multi-numbering scheme and the calling party has not specified the required bearer capability, then the network uses the bearer capability associated with the called party MSISDN.

However, some networks omit the bearer capability associated with the called party MSISDN, when this MSISDN is associated with voice service and the calling party has not specified the required bearer capability (for example, because the call originated in the PSTN). In these cases, the +CSNS command is used to select the desired bearer or teleservice for a single-numbering scheme, in which one MSISDN is associated with each IMSI. The +CSNS command has a default mode, so is not mandatory to set it.

If the network uses a single-numbering scheme and the calling party has not specified the required service, then the network omits the bearer capability information.

Command Type	Syntax	Response/Action	Remarks
Set	+CSNS=<mode>[,<repeated>]	OK +CME ERROR: <err>	The Set command selects the bearer or teleservice to be use when a mobile-terminated single numbering scheme call is established.
Read	+CSNS?	+CSNS: <mode>	The Read command displays the currently active CSNS mode.
Test	+CSNS =?	+CSNS: (list of supported mode>s), <repeated>	The Test command displays the list of supported CSNS modes.

The following table shows the AT+CSNS parameters.

Table 3-15: +CSNS Parameters

<Parameter>	Description
<mode>	CSNS mode: 0 - Voice (default) 2 - Fax (TS 62) 4 - Data
<repeated>	Defines for how long to save the new setting: 0 One shot (new setting is not saved) 1 CSNS mode is saved until new +CSNS set command is issued or next power cycle, whichever occurs first. 2 CSNS mode is saved until new +CSNS set command is issued. The CSNS mode will be stored in non-volatile memory and will be effective after power cycle.

Note: Any mobile-terminated call lacking bearer capability information is handled according to the current CSNS setting.

When <mode> is set to data service, the parameter values set with the +CBST command are used (Refer to “+CBST, Select Bearer Service Type” on page 3-31). If the +CBST parameter is set to a value that is not applicable to single numbering calls, the G24-L maps the value to the matching one, according to the Mapping Table (Table 3-16).

The <mode> selected in conjunction with <repeated> value '2' setting replaces <mode> setting in MS non-volatile memory of the bearer or teleservice to be used when mobile terminated single numbering scheme call is established. Selected <mode> is effective until new CSNS set command is issued. After power cycle, <mode> setting in MS non-volatile memory returns to be effective (<mode> selected in conjunction with <repeated> value '2' or default <mode>).

If CSNS set command is issued in conjunction with <repeated> value '0' (one shot), then selected <mode> is effective until any call indication is received (RING, CRING, CLCC, and so on). Afterwards, <mode> stored in MS non-volatile memory, returns to be effective.

If CSNS set command is issued in conjunction with <repeated> value '1', then selected CSNS <mode> is effective until new CSNS set command is issued or until next power cycle.

If CSNS set command is issued without parameter <repeated>, the value of repeated is assumed to be '0'.

The only +CBST parameter that needs mapping for mobile terminated calls is <speed>, as described in the table below. The V.110 protocol is replaced by the analog protocol regardless of the +CBST setting. All other parameters are set by the +CBST command.

Table 3-16: Mapping Table (V.34)

+CBST setting	Mapped value for mobile terminated call
0	autobauding
4	2400 bps (V.22bis)
6	4800 bps (V.32)
7	9600 bps (V.32)
14	14400 bps (V.34)
68	2400 bps (V.110 or X.31 flag stuffing)
70	4800 bps (V.110 or X.31 flag stuffing)
71	9600 bps (V.110 or X.31 flag stuffing)
75	14400 bps (V.110 or X.31 flag stuffing)

Note: CSNS has read-only access to CBST data.

+MDC, Selection of Desired Message to Be Displayed Upon Connection of a Voice Call

This AT command enables you to select the desired messages to be displayed upon connection of a voice call with a remote party. The OK and CONNECT messages are available.

Command Type	Syntax	Response/Action	Remarks
Set	+MDC=<mode>	OK or: ERROR	The Set command selects which of the supported messages will be displayed upon connection of a voice call. <mode> Command Parameters: 0 - Display OK on voice call connection 1 - Display CONNECT on voice call connection Default Values: Power Up - As previously saved in NVM FLEX bit 0 - Before Set command is first used
Read	+MDC?	++MDC: <mode> OK	The Read command should return the current selection of <mode>.
Test	+MDC=?	+MDC: (list of supported <mode>s) OK	The Test command returns the possible <mode> values.

Example

```

AT+MDC=?
+MDC: (0-1)
OK
AT+MDC=1
OK
ATD<number>;
OK
CONNECT
AT+MDC?
+MDC: 1
OK
AT+MDC=0
OK
ATD<number>;
OK
OK
AT+MDC?
+MDC: 0
OK

```

+CTFR1, Divert an Incoming Call When User Busy

This command terminates an incoming call and diverts the caller to the number previously defined in CCFC, or to a voice mail if one exists for the subscriber. This is done by sending a user-defined User Busy message to the network.

Command Type	Syntax	Response/Action	Remarks
Set	+CTFR1	OK and NO CARRIER or: +CME ERROR: <err>	The Set command will hand up (terminate) the incoming call, causing the network to divert the incoming call to the number that was set by the CCFC command for "User Busy", or the voice mail, if one exists for the subscriber

Example

```

RING //Incoming call indication
AT+CTFR1
OK
NO CARRIER
AT+CTFR1 //When an active call exists and another call is waiting
OK
NO CARRIER
AT+CTFR1 //When there is no incoming call or waiting call
+CME ERROR: operation not allowed

```

+MVC, Motorola Vocoders Configuration

This AT command is used to choose and configure the priority order of the supported voice codecs (vocoders).

Changes take effect after restart.

Command Type	Syntax	Response/Action	Remarks
Set	AT+MVC=<n>[,<p1>[,<p2>[,<p3>[,<p4>[,<p5>]]]]	OK or: +CME ERROR: <err>	The command will save new vocoders configuration or restore the default configuration, only after module restart.
Read	AT+MVC?	+MVC: <p1>[,<p2>[,<p3>[,<p4>[,<p5>]]]] OK or: +CME ERROR: <err>	The command will read the current vocoders values.
Test	AT+MVC=?	+MVC: (0,1),(1-5),(1-5),(1-5),(1-5) OK	The command shall return the list of supported <n>,<p1>,<p2>,<p3>,<p4>,<p5> values.

The following table shows the +MVC parameters.

Table 3-17: +MVC Parameters

<Parameter>	Description
<n>	0 Restore default vocoder configuration. 1 Set vocoders and their priority order.
<p1>,<p2>,<p3>,<p4>,<p5>	1 GSM full rate speech version 1. 2 GSM half rate speech version 1. 3 GSM full rate speech version 2 (EFR). 4 GSM full rate speech version 3 (AMR Full Rate). 5 GSM half rate speech version 3 (AMR Half Rate).

Example

```

AT+MVC=0
OK
AT+MVC=1,1,2,3
OK
// Restart

AT+MVC?
+MVC: 1,2,3
OK
AT+MVC=?
+MVC: (0,1),(1-5),(1-5),(1-5),(1-5),(1-5)
OK
    
```

Call Status Messages

+CPAS, Phone Activity Status

This command displays the current activity status of the G24-L, for example, call in progress, or ringing.

Command Type	Syntax	Response/Action	Remarks
Execute/Read	AT+CPAS AT+CPAS?	+CPAS: <pas> OK or: +CME ERROR: <err>	The Execute and Read commands return the activity status <pas> of the G24-L. They can be used to interrogate the G24-L.
Test	AT+CPAS=?	+CPAS: (list of supported <pas>s) OK or: +CME ERROR: <err>	

The following table shows the +CPAS parameters.

Table 3-18: +CPAS Parameters

<Parameter>	Description
<pas>	0 - Ready - The G24-L allows commands from the terminal 2 - Unknown - The G24-L is not guaranteed to respond to instructions 3 - Ringing (MT calls) - The G24-L is ready for commands from the terminal, but the ringer is active 4 - Call in progress - The G24-L is ready for commands from the terminal, but a call is in progress

Example

```

AT+CPAS
+CPAS: 0
OK
AT+CPAS=?
+CPAS: (0,2-4)
OK
AT+CPAS?
+CPAS: 4
OK
AT+CPAS //Voice call active state
+CPAS: 4
OK

```

+CLCC, List Current Calls

This command displays a list of all current G24-L calls and their statuses, and also enables/disables the unsolicited indication of the call list. (If no calls are received, no information response is sent to the terminal).

If the command succeeds but no calls are available, no information response is sent to the terminal.

The maximum number of simultaneous multiparty calls is 5+1 (5 in active group and 1 on hold).

Command Type	Syntax	Response/Action	Remarks
Set	AT+CLCC=<state>	OK or: +CME ERROR: <err>	The Set command enables/disables unsolicited indications.
Execute	AT+CLCC	+CLCC: <idx>,<dir>,<call state>,<mode>,<empty>[,<number>,<type>,<alpha>] [<CR><LF>+ CLCC: <idx>,<dir>,<call state>,<mode>,<empty>[,<number>,<type>,<alpha>] [...]] OK	The Execute command enables the receiving of data about current calls.
Read	AT+CLCC?	+CLCC: <state> OK or: +CME ERROR <err>	The Read command returns the call status.
Test	AT+CLCC=?	+CLCC: (List of supported <state>s) OK or: +CME ERROR <err>	

The following table shows the +CLCC parameters.

Table 3-19: +CLCC Parameters

<Parameter>	Description
<state>	0 Disable CLCC unsolicited indication 1 Enable CLCC unsolicited indication The default value is 0.
<idx>	Integer type, call identification number
<dir>	0 Mobile originated call (MO) 1 Mobile terminated call (MT)
<call state>	The state of the call 0 Active 1 Held 2 Dialing (MO call) 3 Alerting (MO call) 4 Incoming (MT call) 5 Waiting (MT call) 6 Released
<mode>	Bearer/Teleservice 0 Voice Call 1 Data 2 Fax
<mpty>	Multiparty status 0 Call is not part of a multiparty call 1 Call is one of multiparty call parties
<number>	Phone number in the format specified by <type>. Contains a string of up to 32 characters.
<type>	Phone number display format. Type of address octet in integer format (refer to GSM 04.08 [8] subclause 10.5.4.7) 129 Local number 145 International number with access character +
<alpha>	Text representation of the phone book entry. String type alphanumeric representation of <number> corresponding to the entry found in the phone book. Contains a string of up to 20 characters.

Note: When a mobile-originated call is routed to PSTN (PABX), no ALERT indication is prompted.

Example

```
AT+CLCC=?
+CLCC: (0,1)
OK
AT+CLCC
+CLCC: 1,0,0,0,0,"01256316830",129,"Shmuel"
OK
AT+CLCC?
```

```

+CLCC: 0
OK
AT+CLCC=1 //Example with unsolicited indication
OK
ATD055490698;
OK
+CLCC: 1,0,2,0,0,"055490698",129,"Alpha"
+CLCC: 1,0,3,0,0,"055490698",129," Alpha "
OK
+CLCC: 1,0,0,0,0,"055490698",129," Alpha "
ATH
NO CARRIER
OK
+CLCC: 1,0,6,0,0,"055490698",129," Alpha
    
```

+MCST, Call Status Messages

This command displays the current state of the call processing, and also enables/disables the unsolicited indication of any change in the call processing state.

Command Type	Syntax	Response/Action	Remarks
Set	+MCST=<n>	OK or: +CME ERROR: <err>	The Set command Enables/disables the unsolicited call status messages.
Read	+MCST?	+MCST: <state> OK	The Read command returns the current call processing state.

+MCST Indication

When a change in call state occurs and the +MCST is set to n=1 the G24-L will give the following indication:

```
+MCST: <state>
```

+MCST Parameters

The following table shows the +MCST parameters.

Table 3-20: +MCST Parameters

<Parameter>	Description
<n>	0 - Disable MCST unsolicited indication 1 - Enable MCST unsolicited indication
<state>	1 - Idle call state 2 - Single incoming call 3 - Single call active 4 - Multi-party call active 5 - Single call held 6 - Multi-party call held 7 - Dual call (fully connected active call and held call) 8 - Dual multi-party call active 9 - Dual multi-party call held 10 - Single active call plus call waiting 11 - Multi-party call active plus call waiting 12 - Single call held plus call waiting 13 - Multi-party call held plus call waiting 14 - Dual calls plus call waiting 15 - Dual multi-party calls active plus call waiting 16 - Dual multi-party calls held plus call waiting 17 - Call control busy 64 - Calling 68 - No Service 69 - No Redial 72 - Security Fail

Example

```

AT+MCST?
+MCST:                // <idle>
AT+MCST=1
OK
atd035684423;
+MCST: 17
OK
+MCST: 17
+MCST: 255
OK
+MCST: 3
+MCST: 17
NO CARRIER
+MCST: 1

```

Call Advice of Charge Commands

This set of commands enables GSM operators to offer Advice of Charge (AoC) services that calculate call charges. These charges are expressed in terms of home units.

+CAOC, Advice of Charge

This command displays information about the cost of calls. If supported, this command also activates/deactivates unsolicited event reporting of the CCM (Current Call Meter) information.

The unsolicited report +CCCM:<ccm> is sent when the CCM value changes, but not more than once every 10 seconds.

Note: The CCM value depends on the network properties (charge for MO or/and MT calls).

There are two states in which the command can be activated:

- In IDLE state - returns the last call cost.
- In a voice/data state - returns the accumulated cost, including the current call.

Command Type	Syntax	Response/Action	Remarks
Set	+CAOC[=<mode>]	OK or: [+CAOC:<ccm>] or: +CME ERROR:<err>	The Set command returns the CCM value from the G24-L, or activates/deactivates unsolicited reports.
Read	+CAOC? +CAOC	+CAOC: <mode> OK OK or: [+CAOC: <ccm>] or: +CME ERROR: <err>	The Read command returns the current CAOC mode.
Test	+CAOC=?	+CAOC: (list of supported <mode>s) OK	The Test command returns the supported mode values.

The following table shows the +CAOC parameters.

Table 3-21: +CAOC Parameters

<Parameter>	Description
<mode>	0 Queries the CCM value 1 Deactivates unsolicited reporting of the CCM value 2 Activates unsolicited reporting of the CCM value

Note: <CCM>: String type value representing three bytes of the current call meter value in hexadecimal format (for example, "00001E" indicates decimal value 30).

Example

Example with prepaid SIM card with 56700.00L prepaid before the test.

```

AT
OK
AT+CAOC=2
OK
atd+97254565190;
OK
OK
+CCCM: "000000"
+CCCM: "000006"
AT+CAOC
+CAOC: "000009"
OK
+CCCM: "00000e"
+CCCM: "000016"
AT+CAOC
+CAOC: "00001d"
OK
+CCCM: "00001e"
+CCCM: "000027"
AT+CAOC=0
+CAOC: "00002d"
OK
AT+CAOC=2
OK
+CCCM: "00003d"
AT+CAOC
+CAOC: "00003f"
OK
+CCCM: "000046"
AT
+CCCM: "00004e"
+CAOC
+CAOC: "00004f"
OK
+CCCM: "000056"
AT+CAOC
+CAOC: "00005d"
OK
+CCCM: "00005e"
NO CARRIER
AT+CAOC
+CAOC: "000066"
OK
//567 (prepaid SIM value) - 102 (price per call unit by provider) x 66 (call units) = 465 left in prepaid SIM
OK

```

There is now 46500.00L prepaid remaining on the SIM card.

Note: The above example shows first time activation of the AOC feature using the G24-L. Therefore, the accumulated cost is equal to the current call cost.

+CACM, Accumulated Call Meter

This command resets the Advice of Charge accumulated call meter value in the SIM file, EFACM. ACM contains the total number of home units for both the current call and preceding calls.

Command Type	Syntax	Response/Action	Remarks
Set	+CACM=<passwd>	OK +CME ERROR: <err>	The Set command resets the accumulated call meter value. SIM PIN2 is required.
Read	+CACM?	+CACM: <acm> +CME ERROR: <err>	The Read command displays the current value of ACM.
Test	+CACM=?	OK	The Test command indicates whether the +CACM command is functioning.

The following table shows the +CACM parameters.

Table 3-22: +CACM Parameters

<Parameter>	Description
<passwd>	SIM PIN2 password Maximum string length is 8 characters. If this value is exceeded, the command terminates in an error. If PIN2 is incorrect, "+CME ERROR: incorrect password" is displayed.
<acm>	Accumulated call meter maximum value (similar to CCM; Refer to "+CAOC, Advice of Charge", page 3-44). The default is 0. <ccm> String type; three bytes of the current call meter value in hexadecimal format (for example, 00001E indicates a decimal value of 30). Value is given in home units; bytes are similarly coded as the ACMmax value in the SIM.

Example

```
AT+CACM=?
OK
AT+CACM?
+CACM:"000000"
OK
AT+CACM="2222"
OK
```

+CAMM, Accumulated Call Meter Maximum

This command sets the Advice of Charge accumulated call meter maximum value in the SIM file, EFACMmax. ACMmax contains the maximum number of home units the subscriber is able to consume. When the ACM (Refer to “+CACM, Accumulated Call Meter”, page 3-46) reaches ACMmax, additional calls (mobile-originated and mobile-terminated calls that incur charges) are prohibited, except for emergency calls. Refer to GSM 02.24.

Command Type	Syntax	Response/Action	Remarks
Set	+CAMM=[<acmmax>,<passwd>]	OK +CME ERROR: <err>	The Set command sets the accumulated call meter maximum value. SIM PIN2 is required. The value that is set remains after a power cycle. Note: This command is activated if Advice of Charge is supported by the network.
Read	+CAMM?	+CAMM: <acmmax> +CME ERROR: <err>	The Read command displays the current value of ACMmax.
Test	+CAMM=?	OK	The Test command indicates whether the +CAMM command is functioning.

The following table shows the +CAMM parameters.

Table 3-23: +CAMM Parameters

<Parameter>	Description
<acmmax>	Accumulated call meter maximum value (similar to CCM; Refer to “+CAOC, Advice of Charge”, page 3-44) <ccm> String type; three bytes of the current call meter value in hexadecimal format (for example, 00001E indicates a decimal value of 30). Value is given in home units; bytes are similarly coded as the ACMmax value in the SIM. Range is from 00001 to FFFFFFF. 0 Disables ACMmax (default)
<passwd>	SIM PIN2 password Maximum string length is 8 characters. If this value is exceeded, the command terminates in an error. If PIN2 is incorrect, "+CME ERROR: incorrect password" is displayed.

Example

```
AT+CAMM=?
OK
AT+CAMM="FFFFFF","2222"
OK
AT+CAMM?
+CAMM: "FFFFFF"
OK
```

+CPUC, Price per Unit and Currency Table

This command sets the parameters of the Advice of Charge-related price per unit and currency table found in the SIM file, EFPUCT. PUCT information is used to convert the home units (used in +CAOC, +CACM and +CAMM) into currency units.

Command Type	Syntax	Response/Action	Remarks
Set	+CPUC=<currency>,<ppu>,<passwd>	OK +CME ERROR: <err>	The Set command sets the price per unit and the currency table. SIM PIN2 is required. The new value is retained after a power cycle.
Read	+CPUC?	+CPUC: <currency>,<ppu> +CME ERROR: <err>	The Read command displays the current price per unit and currency table.
Test	+CPUC=?	OK	The Test command indicates whether the +CPUC command is functioning.

The following table shows the +CPUC parameters.

Table 3-24: +CPUC Parameters

<Parameter>	Description
<currency>	Currency code character set (3 characters) defined by +CSCS command. (Refer to “+CSCS, Select Terminal Character Set”, page 3-4.) If the string begins with an alphanumeric character, it may be entered with or without quotation marks, for example, "GBP", "DEM".
<ppu>	Price per unit A dot is used as a decimal separator (precision of 1/1000; 15 digit maximum), for example, "2.667". [See notes below]
<passwd>	SIM PIN2 password Maximum string length is 8 characters. If this value is exceeded, the command terminates in an error. If PIN2 is incorrect, "+CME ERROR: incorrect password" is displayed.

Example

```
AT+CPUC=?
OK
AT+CPUC="GBP","0.125","2222"
OK
AT+CPUC?
+CPUC: "GBP","0.125"
OK
```

Note: If <ppu> contains a dot, a maximum of three digits may appear after the dot, otherwise an error is generated. For example, if <ppu>=0.61, the Read command displays 0.610. <ppu>=1.2345 terminates in an error.

If <ppu> does not contain a dot, the number is divided by 1000. For example, if <ppu>=1, the Read command displays 0.001.

Due to storage constraints, the <ppu> value is limited to a range of 0 to 4095. Values beyond this range may result in rounding errors. For example, if <ppu>=4095, the Read command displays 4.095. However, if <ppu>=4096, the Read command displays 4.090 (the last digit is replaced by 0). If <ppu>=456789, the Read command displays 456.000.

+CR, Service Reporting Control

This command controls whether or not the extended format of an outgoing call is displayed or not. The +CR indication is sent from the G24-L to the terminal whenever a data call is initiated by the G24-L.

Command Type	Syntax	Response/Action	Remarks
Set	+CR=[<mode>]	OK	The Set command enables/disables the extended format of an outgoing data call. When enabled, the outgoing data call is indicated to the terminal through the unsolicited result code +CR:<serv>. When the command is disabled, no +CR is sent to the terminal.
Read	+CR?	+CR:<mode>	The Read command displays the current service reporting control setting.
Test	+CR=?	+CR:<mode>	The Test command displays the list of supported CR modes.

The following table shows the +CR parameters.

Table 3-25: +CR Parameters

<Parameter>	Description
<mode>	0 Extended format disabled (default) 1 Extended format enabled
<serv>	Type of outgoing data calls: ASYNC - Asynchronous transparent SYNC - Synchronous transparent REL ASYNC - Asynchronous non-transparent REL SYNC - Synchronous non-transparent

Example

```
AT+CR=1           //Enable reporting
OK
ATD1234567890
+CR: REL ASYNC
```

Supplementary Services

This set of commands enables control over supplementary service notifications, including Structured and Unstructured Supplementary Service Data (USSD) data.

+CSSN, Supplementary Service Notifications

This command handles the enabling and disabling of supplementary service-related, network-initiated, notifications.

Command Type	Syntax	Response/Action	Remarks
Set	+CSSN=[<n>[,<m>]]	OK +CME ERROR: <err>	<p>The Set command enables/disables the display of notification result codes to the TE.</p> <p>When <n>=1 and a supplementary service notification is received after a mobile-originated call setup, the +CSSI: notification is sent to the TE before any other mobile-originated call setup result codes. When several different notifications are received from the network, each of them receives its own +CSSI result code.</p> <p>When <m>=1 and a supplementary service notification is received during a mobile-terminated call setup or during a call, or when a forward check supplementary service notification is received, the unsolicited result code +CSSU: is sent to the TE. In case of a mobile-terminated call setup, a CSSU is sent after every +CLIP result code (“+CLIP, Calling Line Identification” on page 3-19). When several different events are received from the network, each of them receives its own +CSSU result code.</p> <p>Note: The values for <n> and <m> are not saved after power cycle.</p>
Read	+CSSN?	+CSSN: <n>,<m>	The Read command displays the current supplementary service notification setting.
Test	+CSSN=?	+CSSN: (0-1), (0-1)	The Test command displays the list of supported CSSN values.

The following table shows the +CSSN parameters.

Table 3-26: +CSSN Parameters

<Parameter>	Description
<n>	Sets/displays the +CSSI result code presentation status. This value must be specified. 0 Disable (default) 1 Enable
<m>	Sets/displays the +CSSU result code presentation status. This value is optional, but cannot be specified without <n>. 0 Disable (default) 1 Enable

Table 3-27: +CSSI Notification Values

Value	Description	G24-L Support
0	Unconditional call forwarding is active	Yes
1	Some conditional call forwarding is active	Yes
2	Call has been forwarded	Yes
3	Call is waiting	Yes (GSM only)
4	CUG call (<index> is present)	Yes
5	Outgoing calls are barred	Yes
6	Incoming calls are barred	Yes
7	CLIR suppression rejected	Yes
8	Call has been deflected	No

Table 3-28: +CSSU Notification Values

Value	Description	G24-L Support
0	This is a forwarded call (mobile-terminated call setup).	Yes
1	CUG call (<index> is present; mobile-terminated call setup).	Yes
2	Call has been put on hold (during a voice call)	Yes
3	Call has been retrieved (during a voice call)	Yes
4	Multiparty call has been entered (during a voice call)	Yes

Table 3-28: +CSSU Notification Values (Cont.)

Value	Description	G24-L Support
5	Call on hold has been released (during a voice call; not a supplementary service notification)	Yes
6	Forward check supplementary service message received (can be received at any time)	Yes
7	Call is being connected with the remote party in an alerted state using an explicit call transfer operation (during a voice call).	Yes
8	Call has been connected with the other remote party using an explicit call transfer operation (during a voice call or during mobile-terminated call setup). Number and subaddress parameters may be present: <number>String type phone number of format defined by <type> <type>Type of address octet in integer format (refer to GSM 04.08 [8], subclause 10.5.4.7) <subaddr>String type subaddress of format defined by <satype> <satype>Type of subaddress octet in integer format (refer to GSM 04.08 [8], subclause 10.5.4.8)	Yes
9	Deflected call (mobile-terminated call setup)	No

Example

```

AT+CSSN=?                // test command
+CSSN: (0-1),(0-1)
OK
AT+CSSN=0,0              // disable both options
OK
AT+CSSN=1,0              // set n value as enabled, m disabled
OK
AT+CSSN?
+CSSN: 1,0               // display the current n & m values
OK
+CSSI: 1                 // displayed after mobile originated call setup of call forward and n
                           enable
+CSSU: 2                 //displayed when a call has been placed on hold (during the call) using
                           the +CHLD AT command and m enable

```

+CUSD, Unstructured Supplementary Service Data

This command allows control of Unstructured Supplementary Service Data (USSD), according to GSM 02.90. Mobile-initiated operations are supported.

Command Type	Syntax	Response/Action	Remarks
Set	+CUSD=<n>[,<str>]	OK +CME ERROR: <err>	The Set command enables/disables the display of the following unsolicited result code, +CUSD: <m>[,<str>] (the USSD response from the network), to the TE. The new value is not retained after a power cycle.
Read	+CUSD?	+CUSD: <n> +CME ERROR: <err>	The Read command displays the current value of <n>.
Test	+CUSD=?	+CUSD: (list of supported <n>s) +CME ERROR: <err>	The Test command displays the supported values of <n>.

The following table shows the +CUSD parameters.

Table 3-29: +CUSD Parameters

<Parameter>	Description
<n>	Sets/displays the result code presentation status of the G24-L. 0 Disable (default) 1 Enable 2 Cancel session
<str>	A USSD string that, when included, causes a mobile-initiated USSD string or response USSD string to be sent to the network. The response USSD string is returned in a subsequent unsolicited +CUSD result code. <str> starts with either "*" or "#". The maximum length is 200 characters, based on +CSCS. When <str> is not included, the network is not queried.
<m>	Whether further user action is required. 0 No further user action required (either network-initiated USSD-Notify, or no further information needed after a mobile-initiated operation) 1 Further user action required (either network-initiated USSD-Request, or further information needed after a mobile-initiated operation) 2 USSD terminated by the network (the reason for the termination is indicated by the index, as described in Table Note .) 3 Other local client has responded 4 Operation not supported 5 Network time out

Example

```

AT+CUSD=?
+CUSD: (0,1,2)
OK
AT+CUSD=1,"*#100#"OK
+CUSD: 2,26 //Response of the command <m>=2, reason = 26 (SIGNALING
ERROR)
AT+CUSD?
+CUSD: 1
OK
    
```

Note: When the mobile-initiated operation is successful, the MS is implemented according to the required version. It waits for the USSD response from the network and then sends it to the TE before the final result code.

Table 3-30: CUSD Termination Cause Table Index

Termination Cause	Index
NO_CAUSE	0
CC_BUSY	1
PARAMETER_ERROR	2
INVALID_NUMBER	3
OUTGOING_CALL_BARRED	4
TOO_MANY_CALLS_ON_HOLD	5
NORMAL	6
DROPPED	10
NETWORK	12
INVALID_CALL_ID	13
NORMAL_CLEARING	14
TOO_MANY_ACTIVE_CALLS	16
UNASSIGNED_NUMBER	17
NO_ROUTE_TO_DEST	18
RESOURCE_UNAVAILABLE	19
CALL_BARRED	20
USER_BUSY	21
NO_ANSWER	22
CALL_REJECTED	23
NUMBER_CHANGED	24
DEST_OUT_OF_ORDER	25
SIGNALING_ERROR	26
NETWORK_ERROR	27

Table 3-30: CUSD Termination Cause Table Index (Cont.)

Termination Cause	Index
NETWORK_BUSY	28
NOT_SUBSCRIBED	29
SERVICE_UNAVAILABLE	31
SERVICE_NOT_SUPPORTED	32
PREPAY_LIMIT_REACHED	33
INCOMPATIBLE_DEST	35
ACCESS_DENIED	43
FEATURE_NOT_AVAILABLE	45
WRONG_CALL_STATE	46
SIGNALING_TIMEOUT	47
MAX_MPTY_PARTICIPANTS_EXCEEDED	48
SYSTEM_FAILURE	49
DATA_MISSING	50
BASIC_SERVICE_NOT_PROVISIONED	51
ILLEGAL_SS_OPERATION	52
SS_INCOMPATIBILITY	53
SS_NOT_AVAILABLE	54
SS_SUBSCRIPTION_VIOLATION	55
INCORRECT_PASSWORD	56
TOO_MANY_PASSWORD_ATTEMPTS	57
PASSWORD_REGISTRATION_FAILURE	58
ILLEGAL_EQUIPMENT	59
UNKNOWN_SUBSCRIBER	60
ILLEGAL_SUBSCRIBER	61
ABSENT_SUBSCRIBER	62
USSD_BUSY	63
CANNOT_TRANSFER_MPTY_CALL	65
BUSY_WITH_UNANSWERED_CALL	66
UNANSWERED_CALL_PENDING	68
USSD_CANCELED	69
PRE_EMPTION	70
OPERATION_NOT_ALLOWED	71
NO_FREE_BEARER_AVAILABLE	72

Table 3-30: CUSD Termination Cause Table Index (Cont.)

Termination Cause	Index
NBR_SN_EXCEEDED	73
NBR_USER_EXCEEDED	74
Call Control by SIM Causes	
NOT_ALLOWED_BY_CC	75
MODIFIED_TO_SS_BY_CC	76
MODIFIED_TO_CALL_BY_CC	77
CALL_MODIFIED_BY_CC	78
App. Cause	
FDN_FAILURE	90

+COLP, Connected Line Identification Presentation

This command relates to the GSM supplementary service called COLP (Connected Line Identification Presentation), which enables a calling subscriber to obtain the connected line identity (COL) of the called party after setting up a mobile-originated call with the G24-L. For example, after setting up a mobile-originated call to one number that is forwarded to another number, the calling party will see the number of that third party.

When this command is enabled (and the called subscriber permits it), the following intermediate result code is returned:

+COLP: <number>,<type>[,<subaddr>,<satype>[,<alpha>]].

Note: This command is activated when COLP is supported by the network.

Command Type	Syntax	Response/Action	Remarks
Set	+COLP=<n>	OK +CME ERROR: <err>	The Set command enables/disables the display of the COL at the TE on the G24-L. It has no effect on the execution of the COLR supplementary service on the network. The value set by this command is not retained after a power cycle.
Read	+COLP?	+COLP: <n>,<m> +CME ERROR: <err>	The Read command displays the status of <n>. It also initiates a query of the COLP service provision status and displays <m>.
Test	+COLP=?	+COLP: (list of supported <n>s) +CME ERROR: <err>	The Test command displays the supported values of <n>.

The following table shows the +COLP parameters.

Table 3-31: +COLP Parameters

<Parameter>	Description
<n>	Sets/displays the result code presentation status of the G24-L. 0 Disable (default) 1 Enable
<m>	Displays the subscriber's COLP service status in the network. 0 COLP not provisioned 1 COLP provisioned 2 Unknown (for example, no network, and so on)
<number>	Sets the phone number, using the format specified by <type>.
<type>	Sets the address octet type in integer format (refer to GSM 04.08 [8] subclause 10.5.4.7). 129 Unknown 145 International (used when dialing string includes "+" international access code character)
<subaddr>	Sets the subaddress, using the format specified by <satype>.
<satype>	Sets the address octet type in integer format (refer to GSM 04.08 [8] subclause 10.5.4.8).
<alpha>	An optional, string-type, alphanumeric representation of <number> corresponding to the entry found in the phonebook. The character set is defined by +CSCS (Refer to "+CSCS, Select Terminal Character Set", page 3-4).

Example

```
AT+COLP=0
OK
AT+COLP=2
+CME ERROR: Numeric parameter out of bounds
```

+MTTY, Motorola TTY Configuration

This AT command is used to enable or disable TTY (Tele Typewriter) support in G24-L modules.

Note: Tele-typewriter or Teletype, a typewriter with an electronic communication. TTY is an electronic device for text communication via a telephone line, used when one or more of the parties have hearing or speech difficulties.

Command Type	Syntax	Response/Action	Remarks
Set	AT+MTTY=<n>	OK or: +CME ERROR: <err>	The SET command is used for setting the current TTY mode.
Read	AT+MTTY?	+ MTTY : <n> OK or: +CME ERROR: <err>	The READ command returns the current TTY mode <n>.
Test	AT+MTTY=?	+MTTY : (0-3) OK or: +CME ERROR: <err>	The Test command returns the possible value's range.

The following table shows the +MTTY parameters.

Table 3-32: +MTTY Parameters

<Parameter>	Description
<n>	<p>0 Normal voice mode.</p> <p>1 Full TTY mode (both uplink and downlink support TTY data; used when both side parties are deaf).</p> <p>2 VCO mode (Voice Carry Over- uplink is voice active downlink is TTY).</p> <p>3 HCO mode (Hearing Carry Over-downlink is voice active uplink is TTY).</p> <p>The default value:</p> <ul style="list-style-type: none"> On Power Up - as previously saved in FLEX bytes. Before set command is first used, mode is set to Normal voice mode.

Notes:

VCO: Voice Carry Over is intended for people who cannot hear but are able to speak clearly. During a VCO relay call, the Deaf or Hard-of-Hearing caller speaks directly to the person they are conversing with. When that person responds, a Communication Assistant (CA) will type back exactly what is said and it will appear on the screen of your TTY or VCO phone.

HCO: Hearing Carry Over allows Speech Disabled callers who can hear well on the telephone to listen directly to the person they are talking with. The Speech Disabled Relay user types his or her part of the conversation on a TTY. A Communication Assistant (CA) then speaks the typed conversation, word for word, to the standard telephone user.

Figure 3-1 shows the TTY hardware configuration.

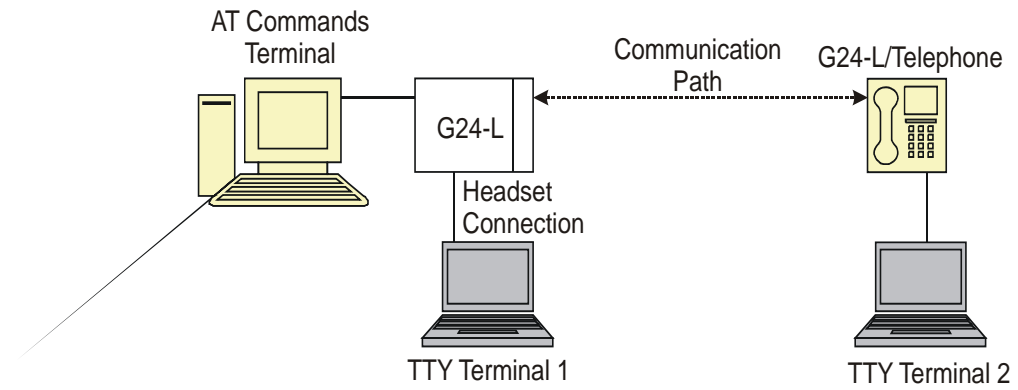

Note: TTY terminal 1 is connected to G24-L via headset connector.

Figure 3-1: TTY Hardware Configuration

Example

```
AT+MTTY=?
+MTTY: (0-3)
OK
```

```
AT+MTTY=1
OK
```

```
AT+MTTY?
+MTTY: 1
OK
```

Phone Books and Clock

Directory Access Commands

This set of commands enables read/write access to the phone book contained within the G24-L, including both the numeric and the alpha information contained in the location. The presentation is according to GSM 07.07.

In some cases, it may be possible to use these commands to access the dialed and received call stacks. However, as these phone books cannot be edited, the +CPBW command does not work on them.

+CPBS, Select Phone Book Memory

This command handles the selection of the memory to be used for reading and writing entries in the G24-L's phone books' memory. (When there is a separate storage on the SIM card and in the G24-L's internal EEPROM).

Command Type	Syntax	Response/Action	Remarks
Set	AT+CPBS=<storage> [,<pin2>] <pin2> is optional while <storage> = "FD" only	OK or: +CME ERROR: <err>	The Set command selects the phone book memory storage which is to be used by other phone book commands.
Read	+CPBS?	+CPBS: <storage>[,<used>,<total>]	The Read command returns the currently selected phone book memory, number of used entries and total number of entries in the phone book memory.
Test	+CPBS=?	+CPBS: (list of supported <storage>s) OK	Test command returns the supported storages as a compound value.

Note: Read format of +CPBS joins RC and MC, therefore the united list will be prompted.

The following table shows the +CPBS parameters.

Table 3-33: +CPBS Parameters

<Parameter>	Description
<storage>	List of supported phone books and their storage IDs AD Abbreviated dialing numbers. DC ME dialed calls list (+CPBW is not applicable for this storage). EN SIM emergency numbers (+CPBW is not applicable for this storage). FD SIM Fixed dialing phone book. MC G24-L missed (unanswered received) calls list (+CPBW may not be applicable for this storage). ME G24-L phone book. MT Combined G24-L and SIM phone book. ON SIM own numbers (MSISDNs) list (reading this storage is also available through +CNUM). QD Quick dial phone book. RC G24-L received calls list (+CPBW may not be applicable for this storage). SD Service dialing numbers. SM SIM phone book. The default phone book is AD.
<pin2>	Pin2 password, 4-8 chars.
<used>	Integer type value indicating the number of used locations in the selected memory.
<total>	Integer type value indicating the total number of entries in the selected phone book memory.

Example

```
AT+CPBS=?
AT+CPBS: ("ME","SM","MT","ON","DC","MC","RC","EN","AD","QD","SD","FD")
OK
```

```
AT+CPBS="SM"
OK
AT+CPBS?
+CPBS: "SM",74,160
OK
```

```
AT+CPBS="MT"
OK
AT+CPBS?
+CPBS: "SM",74,660
OK
```

+CPBR, Read Phone Book Entries

This command recalls phone book entries from a specific entry number or from a range of entries. If only one entry is specified, and that entry is empty, OK is returned. If a range of entries is

requested, all entries that contain data within that range are returned. If a listing fails in a G24-L error, +CME ERROR: <err> is returned.

This command can also be used to obtain information about the number of entries and the maximum size of a phone number and alpha tag fields in the phone book.

This command acts on the currently active phone book, as selected with the +CPBS command (Refer to “+CPBS, Select Phone Book Memory”, page 3-60).

Command Type	Syntax	Response/Action	Remarks
Set	+CPBR=<index1> [<i>,<index2></i>]	[+CPBR: <index1>,<number>,<type>,<text> <CR><LF> +CPBR: <index2>,<number>,<type>,<text>] OK or: +CME ERROR: <err>	The Set command returns phone book entries.
Test	+CPBR=?	+CPBR: (list of supported <index>s),[<nlength>], [<tlength>] OK	The Test command returns the entry range supported by the current storage as a compound value and the maximum lengths of the <number> and <text> fields.

The following table shows the +CPBR parameters.

Table 3-34: +CPBR Parameters

<Parameter>	Description
<index1> <index2>	Index for a given phone book entry
<number>	Phone number of a given entry
<type>	The address type of a phone number 129 Use for local call 145 Use “+” for international access code 128 Unknown "128" is used to represent an email address or a mailing list. In this case, <ph_type> can be used to further differentiate between the two.
<text>	Text identifier for a phone book entry, according to the character set as specified by command +CSCS.
<nlength>	The maximum number of digits in the <number>.
<tlength>	The maximum number of characters in the <text> entry

Example

```

At+cpbs="ME"
OK
At+cpbr=?
+CPBR: (1-100,40,24)
OK
At+cpbr=1
OK
At+cpbr=1,3           //There is nothing written in entry 1,2,3
OK
At+cpbs="MT"
OK
At+cpbr=?
+CPBR: (1-350,40,24)
OK
At+cpbr=1,3
OK
At+cpbr=1,350
+CPBR: 101,"+97252999080",145,"Voice Mail"
OK

```

+CPBF, Find Phone Book Entries

This execution command enables the user to search for a particular entry, by name, in the currently active phone book. If no matching entry is found, the command returns OK. If multiple matches are found, all are returned.

Command Type	Syntax	Response/Action
Set	+CPBF=<findtext>	[+CPBF: <index1>,<number>,<type>,<text>[[...] <CR><LF> +CBPF: <index2>,<number>,<type>,<text>]] OK or: +CME ERROR: <err>
Test	AT+CPBF=?	+CPBF: [<nlength>],[<tlength>] OK

The following table shows the +CPBF parameters.

Table 3-35: +CPBF Parameters

<Parameter>	Description
<findtext>	Case-sensitive text substring (even of one letter) to search for, according to the character set specified by the +CSCS command.
<index1> <index2>	Index for a given phone book entry
<number>	Phone number of a given entry
<type>	The address type of a phone number 129 Use for local call 145 Use "+" for international access code 128 Unknown Note: "128" is used to represent an email address or a mailing list. In this case, <ph_type> can be used to further differentiate between the two.
<text>	Text identifier for a phone book entry that starts with the substring <findtext>, according to the character set as specified by command +CSCS. In case the <findtext> is not empty the entries will be sorted by name.

Example

```

AT+CPBS="MT"           //Selecting phone book
OK
AT+CPBF="k"           //Searching for "k" and not finding it
OK
AT+CPBF="Voice"       //Searching for string "Voice" and finding Voice Mail
+CPBF: 101,"+97252999080",145,"Voice Mail"
OK
AT+CPBF=""           //Searching for everything in phone book, and finding all entries
+CPBF: 2,"8475767800",129,"Moto Voicemail"
+CPBF: 101,"+97252999080",145,"Voice Mail"
OK
AT+CPBF="Moto"
+CPBF: 2,"8475767800",129,"Moto Voicemail"

```

+CPBW, Write Phone Book Entry

This command enables the user to store a new entry in the phone book, or edit/delete an existing entry from the phone book. A particular entry in the phone book can be stored, or the next available entry is used.

This command writes the entry in the currently active phone book, selected with the +CPBS command (Refer to ["+CPBS, Select Phone Book Memory"](#), page 3-60).

The entry is selected by <index>, the phone number is entered into the <number> field and text associated with the number is entered into the <text> field. If these fields are omitted, the phone book entry is deleted. If the <index> field is omitted, but a number is entered in the <number> field, the phone number is entered into the first available entry in the phone book. If the <index>

field already exists in the PB, the new record will update the old one. If the writing fails in a G24-L error, +CME ERROR: <err> is returned.

Note: The "FD" phone book supports single wild card characters (?) and prefixes of a number in the telephone number field. In cases of fixed dialing, these entries in the "FD" phone book define a group of permitted numbers.

Call indications related to a fixed dialing entry containing wild cards or only a prefix of a number do not display any <alpha> identifier.

Command Type	Syntax	Response/Action	Remarks
Set	AT+CPBW=[<index>],[<number>][,<type>[,<text>]]	OK or: +CME ERROR: <err>	
Test	AT+CPBW=?	+CPBW: (list of supported <index>s),[<nlength>], (list of supported <type>s),[<tlength>] OK	This command queries the allowable command field and sizes.

The following table shows the +CPBW parameters.

Table 3-36: +CPBW Parameters

<Parameter>	Description
<index>	Index for a given phone book entry
<number>	Phone number of a given entry
<type>	The address type of a phone number 129 Use for local call 145 Use "+" for international access code 128 Unknown Note: "128" is used to represent an email address or a mailing list. In this case, <ph_type> can be used to further differentiate between the two.
<text>	Text identifier for a phone book entry, according to the character set as specified by command +CSCS.
<nlength>	The maximum size of a phone number, in digits. There is a limited number of PB records that can be stored with this length. The number of "long" PB records depends on the size of the SIM card EXT1 extension file. If the extension file is full, an attempt to store a new record with more than 20 digits returns an error.
<tlength>	The maximum number of characters in the <text> entry. This applies to GSM standard characters only. Non-GSM standard character sets and extended GSM characters require additional space in storage. In some cases, when using such characters the text cannot be stored. In this case, the G24-L returns a "text string too long"error.

Example

```

AT+CBPS="MT"
OK
AT+CPBW=?
+CPBW: (1-750),40,(129,145),16
OK

AT+CPBW=1,"0546123456",129,"AAA"
OK
AT+CPBR=1
+CPBR: 1,"0546123456",129,"AAA"

AT+CPBW=1,"0546123456",129,"BBB"
OK
AT+CPBR=1
+CPBR: 1,"0546123456",129,"BBB"
    
```

+CSVM, Set Voice Mail Server

This command handles the selection of the number to the voice mail server. The new value should also remain after power cycle.

Command Type	Syntax	Response/Action	Remarks
Set	+CSVM=<mode> [<,<number>[,<type>]]	OK +CME ERROR: <err>	The Set command sets the number to the voice mail server.
Read	+CSVM?	+CSVM:<mode>,<number>,<type> +CME ERROR: <err>	The Read command displays the currently selected voice mail number and status (enabled or disabled).
Test	+CSVM=?	+CSVM: (list of supported <mode>s), (list of supported <type>s) +CME ERROR: <err>	The Test command displays the list of supported <mode>s and <type>s.

The following table shows the +CSVM parameters.

Table 3-37: +CSVM Parameters

<Parameter>	Description
<mode>	0 Disables the voice mail number (default) 1 Enables the voice mail number
<number>	Voice mail number in string. String can be of up to 32 characters long, starting with a digit, or "+". Other allowed characters are digits only (0..9).
<type>	Address octet type. 129 ISDN/telephony marketing plan; national/international number unknown 145 ISDN/telephony numbering plan; international number When the dialing string includes the international access code character (+), the default is 145. Otherwise, the default <type> is 129.

Note: If <mode> is set to 0, <number> and <type> are ignored. If <mode> is set to 1, <number> is mandatory.

Example

```

AT+CSVM=?
+CSVM: (0,1),(129,145)
OK
AT+CSVM=1,"+972555123456","145"
OK
AT+CSVM?
+CSVM: 1,"972555123456",145
OK

```

+MDSI, Motorola Deactivate SIM Card Indication

This command enables unsolicited reporting of indications of SIM deactivation and invalidation. The indications include the cause for deactivation and invalidation.

This command is a basic command, which means the G24-L module should accept the command and act according to received parameters regardless of SIM presence and phone lock state.

Command Type	Syntax	Response/Action	Remarks
Set	+MDSI=<mode>	When mode is 1 and SIM was invalidated or deactivated: [+MDSI: <type>, <cause>, <type text>, <cause text>] OK +CME ERROR: <err>	The following is the available mode values for the Set command. <mode> = 1 - Defines that unsolicited +MDSI messages will be sent to the DTE. If the SIM card was invalidated or deactivated, the current status will be sent to the DTE. <mode> = 0 - No unsolicited message is sent to the DTE.
Read	+MDSI?	+MDSI: <mode> OK +CME ERROR: <err>	The Read command queries the current settings for <mode>
Test	+MDSI=?	+MDSI: (list of supported <mode>s) OK +CME ERROR: <err>	The Test command returns the possible <mode> values.

The following table shows the +MDSI parameters.

Table 3-38: +MDSI Parameters

<Parameter>	Description
<mode>	0 Unsolicited indications off 1 Unsolicited indications on
<type>, <type text>	0 "DEACTIVATE". SIM deactivate request was sent with <cause> 1 "GSM". Invalidate SIM for GSM services was sent with <cause> 2 "GPRS". Invalidate SIM for GPRS services was sent with <cause>
<cause>, <cause text>	<cause> and <cause text> related to <type> = 0 ("DEACTIVATE"): 1 "Bad SIM" <cause> and <cause text> related to <type> = 1 ("GSM") and <type> = 2 ("GPRS"): 0 "No reject cause" 2 "IMSI unknown in HLR" 3 "Illegal MS" 4 "IMSI unknown in VLR" 6 "Illegal ME" 7 "GPRS service not allowed" 8 "GPRS and non-GPRS services not allowed" 9 "MS identity cannot be derived by the network" 11 "PLMN not allowed" 12 "Location area not allowed" 13 "Roaming not allowed in this location area" 14 "GPRS services not allowed in this PLMN" 240 "Location update failure" 241 "Combined LU failure" 242 "Authentication and ciphering reject" 243 "Authentication reject" 244 "Attach failure"

Example

```

AT+MDSI?
+MDSI: 0
OK
AT+MDSI=?
+MDSI: (000,001)
OK
AT+MDSI=1
OK
//Until now there was no deactivation or invalidation of SIM card.

AT+MDSI?
+MDSI: 1
OK
//SIM card does not support GPRS
+MDSI: 2, 7, "GPRS", "GPRS services not allowed"
//Insert a SIM card that is no longer subscribed

AT+CPIN="1764"
OK
AT+COPS=0
OK
//Unsolicited messages
+MDSI: 1, 2, "GSM", "IMSI unknown in HLR"
+MDSI: 0, 1, "DEACTIVATE", "Bad SIM"
// Insert a good SIM card, and roam to a network that doesn't have a
GPRS roaming agreement.
//Unsolicited messages
+MDSI: 2, 14, "GPRS", "GPRS services not allowed in this PLMN"
AT+CGATT?
+CGATT: 0
OK

```

+MCSN, Motorola Change Subscriber Number

This AT command sets EFmsisdn in the SIM. The setting is placed in the given <index>, using <number> and <alpha> as the values to be set.

Additionally, when setting the number in a specific storage space, the <mode> parameter defines whether that <number> and corresponding <alpha> should be presented after entering the correct PIN number.

After entering the correct PIN number, the last <index>, whose <mode> was set to 1, is sent to the DTE. This indication is unsolicited and appears when SIM information is ready.

Note: At any given time, only one <index> or no <index> can have <mode> = 1. Therefore, setting <mode> = 1 for one of the supported <index>es implicitly means that all other <index>es have <mode> = 0.

Set Command

The Set command sets EFmsisdn in the SIM. The setting is placed in the given <index>, using <number> and <alpha> as the values to be set.

If only the <mode> value is given, then the Set command is interpreted as follows:

- <mode> = 0 - Do not show any number on next +CPIN insertion command
- <mode> = 1 - Default <index> (equals 1) is set to <mode> = 1

If only a pair of <mode> and <index> values are given, then the Set command is interpreted as follows:

- <mode> = 0, <index> = any valid indexSet mode for given index to 0
- <mode> = 1, <index> = any valid indexSet mode for given index to 1

If only <mode>, <index> and <number> values are given, then the Set command is interpreted as follows:

- Store in <index> of EFmsisdn in the SIM, the <number>. Since no <alpha> was given, corresponding <alpha> will be identical to the <alpha> already stored in this <index>. Also store the <mode> value for this <index>.

If all parameters are given, then the Set command is interpreted as follows:

- Store in <index> of EFmsisdn in the SIM, the <number> and corresponding <alpha>. In case an empty string was given as the <alpha> parameter, the corresponding <alpha> will be an empty string. Also store the <mode> value for this <index>.

Note: Only the last <index> whose mode was set to 1 will be sent to the DTE.

Command Type	Syntax	Response/Action	Remarks
Set	+MCSN=<mode> [<i>,<index>[,<number>[,<alpha>]]</i>]	OK or: +CME ERROR: <err>	See above
Read	+MCSN?	+MCSN: <index> OK or: +CME ERROR: <err>	The Read command queries the current settings for the <index> of the storage place in which the <mode> is equal to 1. If no index has its <mode> set to 1, then the response <index> will be equal to 0.
Test	+MCSN=?	+MCSN: (list of supported <mode>s),(list of supported <index>es) OK or: +CME ERROR: <err>	The Test command returns the possible <mode> and <index> values.

The following table shows the +MCSN parameters.

Table 3-39: +MCSN Parameters

<Parameter>	Description
<mode>	<p>This value defines whether <number> and corresponding <alpha> tag are presented after entering a correct PIN number.</p> <p>0 Do not show <number> and <alpha> in <index> after entering correct PIN number</p> <p>1 Show <number> and <alpha> in <index> after entering correct PIN number</p> <p>The default value is 0 (before MCSN has been set for the first time).</p>
<index>	<p>An integer value between 1 and 5 representing the storage place in EFmsisdn in the SIM.</p> <p>1 - 5 Index of the storage place</p> <p>The default value is 1.</p> <p>The number of records in EFmsisdn is SIM-dependent and can be less than 5.</p>
<number>	<p>Phone number to set in the phonebook. The string type representing the phone number is written within double quotes.</p> <p>Valid input characters are: 0-9 and + (at start only)</p> <p>The number of digits the <number> parameter is built of can vary from a minimum of 0 to a maximum of 20 digits.</p>
<alpha>	<p>Text related to <number>. The string type text associated with the phone number is written within double quotes.</p> <p>The character set used for text is the one selected by the command Select TE Character Set (AT+CSCS).</p> <p>The number of characters comprising the <alpha> parameter can vary from a minimum of 0 to a maximum of 14.</p>

Example

```

AT+CNUM                               // Reading EFmsisdn from the SIM
+CNUM: "", "", 0
+CNUM: "", "", 0
+CNUM: "", "", 0
+CNUM: "", "", 0
+CNUM: "", "", 0
OK
AT+MCSN=1,1,"054444444","VOICE"// Setting record 1 in EFmsisdn in the SIM
// Enable unsolicited indication
OK
AT+MCSN=0,2,"039999999","OFFICE"// Setting record 2 in EFmsisdn in the SIM
OK
AT+MCSN=0,3,"1111","PIN1"           // Setting record 3 in EFmsisdn in the SIM
OK
AT+MCSN=0,4,"8523","PIN2"           // Setting record 4 in EFmsisdn in the SIM
OK
AT+CNUM                               // Reading EFmsisdn from the SIM
+CNUM: "VOICE","054444444",129
+CNUM: "OFFICE","039999999",129
+CNUM: "PIN1","1111",129

```

```
+CNUM: "PIN2","8523",129
+CNUM: "", "", 0
OK
AT+MCSN?
+MCSN: 1
OK
// Restart Phone
AT+CPIN="1111"
OK
// Unsolicited information of record 1 in EFmsisdn in the SIM
+MCSN: "VOICE","05444444"
AT+MCSN=0 // Disable unsolicited indication
OK
// Restart Phone
AT+CPIN="1111"
OK
AT+MCSN=0,3,"ada"
ERROR
AT+MCSN=0,3,"3456346" // Update the <number> of record 3 same <alpha>
OK
AT+CNUM // Reading EFmsisdn from the SIM
+CNUM: "VOICE","05444444",129
+CNUM: "OFFICE","03999999",129
+CNUM: "PIN1","3456346",129
+CNUM: "PIN2","8523",129
+CNUM: "", "", 0
OK
AT+MCSN=0,3,"" // Resetting record 3 in EFmsisdn in the SIM
OK
AT+CNUM // Reading EFmsisdn from the SIM
+CNUM: "VOICE","05444444",129
+CNUM: "OFFICE","03999999",129
+CNUM: "", "", 0
+CNUM: "PIN2","8523",129
+CNUM: "", "", 0
OK
```

System Date and Time Access Commands

+CCLK, Read/Set System Date and Time

This command reads and sets the G24-L current date, time and time zone.

Command Type	Syntax	Response/Action	Remarks
Set	+CCLK=<time>	OK or: +CME ERROR: <err>	The Set command sets the date, time and time zone of the system clock. Note: Set Command sets user defined system clock values and saves them in the NVM memory. These saved values are kept after power-cycle as well.
Read	+CCLK?	+CCLK: <time> OK or: +CME ERROR: <err>	The Read command returns the current date, time and time zone setting. By default, <time> will represent the network updated time. If the user has used the Set command once, then <time> will represent the Set command setting. Note: If network operator does not support System Clock Update Message, the initial date, time and time zone, displayed by CCLK Read Command could be invalid (user's responsibility to set date, time and time zone by CCLK Set Command). Note: See Execute Command for how-to enable back network update time.
Test	+CCLK=?	+CCLK (list of supported <time>s) OK or: +CME ERROR: <err>	The Test command returns valid parameters for the +CCLK Set command.
Execute	+CCLK	OK or: +CME ERROR: <err>	The Execute command causes system clock to be overridden by network System Clock value immediately. Note: CCLK Read command will represent the network update time after CCLK Execute command. This value will be represented after power-cycle as well.

The following table shows the +CCLK parameters.

Table 3-40: +CCLK Parameters

<Parameter>	Description
<time>	ASCII string of format: yy/MM/dd,hh:mm:ss±zz or yy/MM/dd,hh:mm:ss yy - 2-digit year [2000-2069] MM - 2-digit month [01-12] dd - 2-digit day of month [00-31] hh - 2-digit hour [00-23] mm - 2-digit minute [00-59] ss - 2-digit seconds [00-59] zz - (optional) time zone offset from GMT, in quarter-hours [-47...+48]. If this value is not specified, the time zone offset will be 0.

Example

```

AT+CCLK=?
+CCLK: "88/12/31, 23:59:59, (-47-+48)"
OK
AT+CCLK="01/01/01, 01:01:01-08"
OK
AT+CCLK?
+CCLK: "01/01/01, 01:01:01-08"
OK
AT+CCLK="02/02/02, 02:02:02"
OK
Power cycling...
AT+CCLK?
+CCLK: "02/02/02, 02:02:02+00"
OK
AT+CCLK="03/03/03, 03:03:03+50"
+CME ERROR: Numeric parameter out of bounds
AT+CCLK
OK
AT+CCLK?
+CCLK: "05/10/27,16:52:31+08"
Power cycling...
AT+CCLK?
+CCLK: "05/10/27,16:52:50+08"
OK

```

SMS

SMS Commands

G24-L supports SMS PDU and SMS TEXT mode according to ETSI specifications 07.05 & 3.40. Cell Broadcast message is not supported yet by the G24-L.

+CSMS, Select Message Service.

This command handles the selection of the messaging service. It returns the types of messages that are supported by the G24-L.

Command Type	Syntax	Response/Action	Remarks
Set	+CSMS=<service>	+CSMS: <mt>,<mo>,<bm> or: +CMS ERROR: <err>	The Set command sets the type of service and returns the types of messages supported by the G24-L.
Read	+CSMS?	+CSMS: <service>,<mt>,<mo>, <bm>	The Read command returns the supported message types along with the current service setting.
Test	+CSMS=?	+CSMS: <service>	The Test command returns a list of all the services supported by the terminal.

The following table shows the +CSMS parameters.

Table 3-41: +CSMS Parameters

<Parameter>	Description
<service>	Integer that defines the type of service 1-127 Not supported 128 Supported (manufacturer-specific)
<mt>	Mobile terminated messages 0 Not supported by the G24-L 1 Supported by the G24-L
<mo>	Mobile originated messages 0 Not supported by the G24-L 1 Supported by the G24-L
<bm>	Reserved for future implementation.

Note: Only the 128 (manufacturer-specific) messaging service is supported by the G24-L. The service is supported for all messaging types (mobile terminated, mobile originated and broadcast).

Example

```

AT+CSMS=128
+CSMS: 001,001,001
OK
AT+CSMS?
+CSMS: 128,001,001,001
OK
AT+CSMS=?
+CSMS: (128)
OK

```

+CPMS, Preferred Message Storage

This command handles the selection of the preferred message storage area. The message storage area is divided into three parts, mem1, mem2 and mem3.

Command Type	Syntax	Response/Action	Remarks
Set	+CPMS=<mem1>[,<mem2>[,<mem3>]]	+CPMS: <used1>,<total1>,<used2>,<total2>,<used3>,<total3> OK or: +CMS ERROR: <err>	The Set command sets the memory storage.
Read	+CPMS?	+CPMS: <mem1>,<used1>,<total1>,<mem2>,<used2>,<total2>,<mem3>,<used3>,<total3> OK or: +CMS ERROR: <err>	The Read command displays the selected memory storage type for the three memory areas.
Test	+CPMS=?	+CPMS: (list of supported <mem1>s),(list of supported <mem2>s),(list of supported <mem3>s) OK +CMS ERROR: <err>	The Test command lists the supported memory storage for <mem1>, <mem2> and <mem3>.

The following table shows the +CPMS parameters.

Table 3-42: +CPMS Parameters

<Parameter>	Description
<mem1>	Memory from which messages are read and deleted. Supported values are: "MT","SM","ME","BM". The default value at power-up is "MT".
<mem2>	Memory to which writing operation is made. Supported value is: "ME". The default value at power-up is "ME".
<mem3>	Memory to which received SMS are stored (unless forwarded directly to TE). Supported value is: "SM". The default value at power-up is "SM".
"BM"	Reserved for future implementation
"ME"	ME message storage
"MT"	All storages
"SM"	SIM message storage

+CMGF, Message Format

This command is a basic command. The Set command handles the selection of the message format used with send, list, read and write commands, as well as the format of unsolicited result codes resulting from message receipts. The G24-L supports both PDU mode (where entire TP data units are used) and text mode (where the body of the message and its headers are given as separate parameters).

Command Type	Syntax	Response/Action	Remarks
Set	+CMGF=<mode>	OK or: +CMS ERROR: <err>	The Set command sets the message format to use.
Read	+CMGF?	+CMGF:<mode>	The Read command displays the current message format.
Test	+CMGF=?	+CMGF:(list of supported <mode>s)	The Test command lists all the supported message formats.

The following table shows the +CMGF parameters.

Table 3-43: +CMGF Parameters

<Parameter>	Description
<mode>	Message format: 0 PDU mode (default) 1 Text mode

Example

```

AT+CMGF=1
OK
AT+CMGF?
+CMGF: 1
OK
AT+CMGF=?
+CMGF: (0,1)
OK

```

+CSCA, Service Center Address

This command handles the selection of the SCA and the TOSCA. The SCA is the phone number of the SC (Service Center). The TOSCA can be 129 (local) or 145 (international), where 129 is the default value. The TOSCA parameter of the Set command is optional, and can be omitted. If the SCA parameter of the Set command is prefixed by the "+" character, it indicates that TOSCA is 145.

The following table shows the +CSCA input characters and their hexadecimal values.

Table 3-44: +CSCA Input Characters and Hexadecimal Values

Character	Description	Hexadecimal
+	International, allowed at start only	0x2B
0-9	Digits	0x30 0x31 0x32 0x33 0x34 0x35 0x36 0x37 0x38 0x39
* #	Instructions	0x2A 0x23
/ - () blank A B C D	Other characters, allowed and ignored, not saved	0x2F 0x2D 0x28 0x29 0x20 0x41 0x42 0x43 0x44
,	Pause control, ignored, not saved	0x2C
;	Allowed at end of number, ignored, not saved	0x3B

Command Type	Syntax	Response/Action	Remarks
Set	+CSCA=<sca>[,<tosca>]	OK or: +CMS ERROR: <err>	The Set command sets the service center address.
Read	+CSCA?	+CSCA: <sca>,<tosca>	
Test			The Test command for +CSCA is not defined by ETSI, and therefore is not supported by the G24-L. The G24-L returns an error.

The following table shows the +CSCA parameters.

Table 3-45: +CSCA Parameters

<Parameter>	Description
<sca>	Service Center Address
<tosca>	Type of Service Center Address is the current address format setting

Example

```
AT+CSCA="4252833433"
OK
AT+CSCA?
+CSCA: "4252833433",129
OK
```

+CSMP, Set Text Mode Parameters

This command is a basic command and is used to select values for additional parameters needed when SM is sent to the network or placed in storage when TEXT mode is selected.

Command Type	Syntax	Response/Action	Remarks
Set	+CSMP=[<fo>[,<vp>[,<pid>[,<des>]]]]	OK or: +CMS ERROR: <err>	The set command selects values for additional parameters needed when SM is sent to the network or placed in storage when text format message mode is selected.

Command Type	Syntax	Response/Action	Remarks
Read	AT+CSMP?	+CSMP: <fo>,<vp>,<pid>,<dcs> OK or: +CMS ERROR: <err>	The read command returns the current parameters value.
Test	AT+ CSMP =?	OK or: +CMS ERROR: <err>	The test command just returns OK.

The following table shows the +CSMP parameters.

Table 3-46: +CSMP Parameters

<Parameter>	Description
<fo>	first octet of GSM 03.40. in integer format. For details see +CMGW definitions. The default value at power-up is 17 (Message type is: SMS-SUBMIT and relative VP format).
<vp>	Validity Period. depending on SMS-SUBMIT <fo>, TP-Validity-Period-Format bits setting. Either in integer format (see Table 3-47) or in time-string format ("yy/MM/dd,hh:mm:ss±zz"). If there is no correlation between the VPF and the VP value. an error message will be returned.
<pid>	Protocol-Identifier. The one octet information element by which the SM-TL either refers to the higher layer protocol being used, or indicates interworking with a certain type of telematic device. "0 - no interworking, SME-to-SME protocol (default) "Any value between 0-255 will be accepted. The SC may reject messages with a TP-Protocol-Identifier containing a reserved value or one, which is not supported.
<dcs>	One octet of Data Coding Scheme, indicates the data coding scheme of the DATA, and may indicate a message class. NOTE: For DCS expanded information, see "DCS handling" on page 3-113. default alphabet: 00xx00xx, 111100xx, 1101xxxx 8 bit data: 00xx01xx, 111101xx UCS2: 00xx10xx, 1110xxxx reserved: 00xx11xx, 0100xxxx-1011xxxx The default value at power-up is 0 - Default alphabet.

Table 3-47: VP Relative Format (In Integer Format)

<Parameter>	Description
0 to 143	(TP-VP + 1) x 5 minutes (i.e. 5 minutes intervals up to 12 hours)
144 to 167	12 hours + ((TP-VP - 143) x 30 minutes)

Table 3-47: VP Relative Format (In Integer Format) (Cont.)

<Parameter>	Description
168 to 196	(TP-VP - 166) x 1 day
197 to 255	(TP-VP - 192) x 1 week

Example

```

AT+CSMP?
+CSMP: 17,167,0,0          (default values for SMS-SUBMIT)
OK
AT+CSMP= 1,256,0,0
+CMS ERROR: numeric parameter out of bounds
AT+CSMP=29,"04/11/04,09:48:36+08"
OK
AT+CSMP=?
OK
AT+CSDH=1
OK
AT+CMGF=1
OK
AT+CMGW="0544565034"
> ABC (^Z)
+CMGW: 160
OK
AT+CMGR=160
+CMGR: "STO UNSENT","0544565034",,81,29,0,0,"04/11/04,09:48:36+08","+97254120032",145,3
ABC
OK

```

+CSDH, Show Text Mode Parameters

This command controls whether detailed header information is shown in text mode result codes.

Command Type	Syntax	Response/Action	Remarks
Set	+CSDH=[<show>]	OK or: +CMS ERROR: <err>	The set command controls whether detailed header information is shown in text mode result codes.
Read	AT+CSDH?	+CSDH: (list of supported <show>s) OK or: +CMS ERROR: <err>	The read command returns the current <show> parameter value.

The following table shows the +CSDH parameters.

Table 3-48: +CSDH Parameters

<Parameter>	Description
<show>	0 - Means do not show header values defined in commands +CSCA and +CSMP (<sca>, <tosca>, <fo>, <vp>, <pid> and <dcs>) nor <length>, <toda> or <tooa> in +CMT, +CMGL, +CMGR result codes for SMS- DELIVERs and SMS-SUBMITs in text mode; for SMS-COMMANDs in +CMGR result code, do not show <pid>, <mn>, <da>, <toda>, <length> or <cdata> (default). 1 - Means show the values in result codes.

Example

```

AT+CSDH=?
+CSDH:(0,1)
OK
AT+CSDH?
+CSDH: 0
OK
AT+CMGR=160 // SMS-SUBMIT
+CMGR: "STO UNSENT","0544565034",
ABC
OK
AT+CSDH=1
OK
AT+CMGR=160
+CMGR: "STO UNSENT","0544565034",,81,29,0,,"04/11/04,09:48:36+08",,"+97254120032",145,3
ABC
OK

```

+CNMI, New Message Indications to Terminal

This command handles enabling of unsolicited notifications to the terminal when an SM is received by the G24-L.

After sending an unsolicited response to the TE, the G24-L will expect a +CNMA (new message acknowledgement) from the TE within a predefined timeout of 60 seconds. The G24-L will not send another unsolicited response to the TE before the previous one is acknowledged. If acknowledged within the timeout, the new SM is not saved in the message storage. If not, the new SM is saved in the message storage and +CNMI parameters are set to 0.

Command Type	Syntax	Response/Action
Set	+CNMI=[<mode> [,<mt>[,<bm> [,<ds>[,<bfr>]]]]]	OK or: +CMS ERROR: <err>

Command Type	Syntax	Response/Action
Read	+CNMI?	+CNMI:<mode>,<mt>,<bm>,<ds>,<bfr>
Test	+CNMI=?	+CNMI: (list of supported <mode>s), (list of supported <mt>s), (list of supported <bm>s), (list of supported <ds>s), (list of supported <bfr>s)

The following table shows the +CNMI parameters.

Table 3-49: +CNMI Parameters

<Parameter>	Description
<mode>	0 Buffer unsolicited result codes (default). 3 Forward unsolicited result codes directly to the terminal
<mt>	0 No SMS-DELIVER indications are routed to the terminal (default) 1 If SMS-DELIVER is stored in the G24-L, the memory location indication is routed to the terminal using the unsolicited result code: +CMTI: <mem>,<index> 2 SMS-DELIVER is routed directly to the terminal
<bm>	Reserved for future implementation.
<ds>	0 No SMS-STATUS-REPORT indications are routed to the terminal (default) 1 SMS-STATUS-REPORT is routed directly to the terminal 2 If SMS-STATUS-REPORT is stored in the G24-L, the memory location indication is routed to the terminal using the unsolicited result code: +CDSI: <mem>,<index>
<bfr>	0 No SMS-STATUS reports are buffered.

Example

```

AT+CNMI=?
+CNMI: (0,3),(0-2),(0,2),(0-2),(0)
OK
AT+CNMI?
+CNMI: 0,0,0,0
OK
AT+CNMI=3,1
OK
AT+CMSS=142,"0544565034" // send to myself
+CMSS: 72
OK
+CMTI: "SM",15
AT+CNMI=,2
OK
AT+CSDH=1
OK
AT+CMSS=142,"054565034" // send to myself
+CMSS: 73
OK

```

```

+CMT: "+972544565034" ,,"04/11/04,09:48:36+08",145,4,0,0,"+97254120032",145,3
ABC
AT+CSMP=49 /*Set first octet to status report - see status report parameters in CMGW*/
OK
AT+CSMP?
+CSMP: 49,167,0,0
OK
AT+CNMI=,,,1
OK
AT+CNMI?
+CNMI: 0,0,0,1,0
OK
AT+CNMI=0,0,0,1,0
OK
AT+CMGS="0524680592"
> HELLO
+CMGS: 168
OK
+CDS: 6,168,"+972524680592",145,"05/08/02,15:20:12+08","05/08/02,15:20:14+08",0
AT+CNMI=0,0,0,2
OK
AT+CMSS=296
+CMSS: 185
OK
+CDSI: "SM",6

```

+CNMA, New Message Acknowledgment

This command acknowledges the receipt of a +CMT and +CDS response from the terminal to the G24-L. A +CMT response receipt confirms the correct reception of a new SMS-DELIVER message, which was routed directly to the terminal. A +CDS response receipt confirms the correct reception of a new SMS-STATUS-REPORT message, which was routed directly to the terminal.

When the G24-L sends a +CDS response to the terminal, it waits a predefined timeout of 60 seconds for the +CNMA acknowledgment. The G24-L will not send another +CDS result code to the terminal before the previous one is acknowledged, or the timeout expires.

When the G24-L sends a +CMT response to the terminal, it waits a predefined timeout of 60 seconds for the +CNMA acknowledgment. The G24-L will not send another +CMT result code to the terminal before the previous one is acknowledged, or the timeout expires.

Upon receipt of the +CNMA command, the G24-L sends RP-ACK to the network. The acknowledged SM will not be saved in message storage.

If the G24-L does not receive acknowledgment within the required time, it sends RP-ERROR to the network. The G24-L automatically disables routing to the terminal by setting both <mt> and <ds> values of +CNMI to zero. The unacknowledged SM is saved in message storage.

If the command is executed but no acknowledgment is expected, or some other G24-L related error occurs, the final result code `+CMS ERROR: <err>` is returned.

Command Type	Syntax	Response/Action	Remarks
Set	AT+CNMA	OK or: +CMS ERROR: <err>	
Read			The Read command for +CNMA is not defined by ETSI, and therefore is not supported by the G24-L. The G24-L returns an error.
Test			The Test command for +CNMA is not defined by ETSI, and therefore is not supported by the G24-L. The G24-L returns an error.

Example

```

AT+CNMI=3,2
OK
AT+CMSS=142,"054565132" // send to myself
+CMSS: 74
OK
+CMT: "+97254565132",,"03/04/09,17:14:33+08"
new message text
AT+CNMA
OK
AT+CNMI?
+CNMI: 3,2,0,0
OK
AT+CNMI=0,0,0,1
OK
AT+CSMP=49
OK
AT+CSMP?
+CSMP: 49,167,0,0
OK
AT+CNMI?
+CNMI: 0,0,0,1,0
OK
AT+CMSS=295
+CMSS: 184
OK
+CDS: 6,184,"+972524680592",145,"05/08/02,17:19:23+08","05/08/02,17:19:24+08",0
AT+CNMA
OK
AT+CNMI?
+CNMI: 0,0,0,1,0
OK

```

+CMTI, Unsolicited Response (New SMS-DELIVER Receipt Indication)

The +CMTI unsolicited response is sent to the TE upon receipt of a new SMS-DELIVER SM, if the +CNMI parameter <mt> is set to 1. Refer to “+CNMI, New Message Indications to Terminal” on page 3-82.

This unsolicited message indicates that a new SMS-DELIVER message was received, and is stored in location <index>:

+CMTI: <mem>,<index>

The following table shows the +CMTI parameters.

Table 3-50: +CMTI Parameters

<Parameter>	Description
<mem>	Message memory space. "SM" - SIM memory storage.
<index>	Location of the new message.

Example

```
AT+CNMI=3,1
OK
AT+CMGS=18 //send to myself
> 079179521201009511000c917952428650290004AA0441424344
+CMTI: 69
OK
+CMTI: "SM",4
```

+CMT, Unsolicited Response (New SMS-DELIVER Receipt)

The +CMT unsolicited response is sent to the TE upon receipt of a new SMS-DELIVER SM if the +CNMI parameter <mt> is set to 2. Refer to “+CNMI, New Message Indications to Terminal” on page 3-82.

This unsolicited message displays the received SMS-DELIVER message:

In text mode: (+CMGF=1):

+CMT: <oa>,<scs>[,<tooa>,<fo>,<pid>,<dcs>,<sca>,<tosca>,<length>] <CR><LF><data>

(about parameters in italics, refer command Show Text Mode Parameters +CSDH).

In PDU mode: (+CMGF=0):

+CMT: [<alpha>],<length><CR><LF><pdu>

The following table shows the +CMT parameters.

Table 3-51: +CMT Parameters

<Parameter>	Description
<oa>	Message origination address.
<scts>	Service center time stamp.
<todoa>	Type of origination address.
<fo>	First octet of the SM.
<pid>	Protocol Identifier.
<dcs>	Data Coding Scheme.
<sca>	Service Center Address.
<tosca>	Type of Service Center Address.
<data>	Message contents.
<alpha>	Alpha ID of message.
<length>	In PDU mode: Size of message, in octets, excluding SMSC data. In TEXT mode: number of characters included in the <data>
<pdu>	Message header and contents in PDU mode format. See description in "+CMGR, +MMGR, Read Message" on page 3-94.

After sending a +CMT unsolicited response to the TE, the G-LITE will expect a +CNMA (new message acknowledgement) from the TE within a predefined timeout of 60 seconds. The G-LITE will not send another +CMT and +CDS/CDSI unsolicited responses to the TE before the previous SMS was one is acknowledged. If the +CMT is acknowledged within the timeout, the new SM is not saved in the message storage. If the +CMT is not acknowledged and the timeout has expired, the new SM is saved in the message storage and +CNMI parameter <mt> and <ds> are set to 0.

Example

```

AT+CNMI=,2
OK
AT+CSDH=1
OK
AT+CMSS=142,"054565034" // send to myself
+CMSS: 74
OK
+CMT: "+972544565034",,"04/11/04,09:48:36+08",145,4,0,0,"+97254120032",145,3
ABC
AT+CNMA
OK
AT+CMGF=0
OK
AT+CMGS=18 // send to myself
> 079179521201009511000c917952446505430004AA0441424344
+CMGS: 70
OK
+CMT: ,23
0791795212010095040C917952446505430004502032115430800441424344

```

+CDSI, Unsolicited Response (New SMS-STATUS-REPORT Indication)

The +CDSI unsolicited response is sent to the TE upon receipt of a new SMS-STATUS-REPORT SM, if the +CNMI parameter <ds> is set to '2'. For further information, refer to ["+CNMI, New Message Indications to Terminal"](#) on page 3-82.

This unsolicited message indicates that a new SMS-STATUS-REPORT message was received, and is stored in location <index>.

Unsolicited Response

+CDSI: <mem>,<index>

The following table shows the +CDSI parameters.

Table 3-52: +CDSI Parameters

<Parameter>	Description
<mem>	Message memory space. "SM" - SIM memory storage.
<index>	Location of the new message.

Example

```
AT+CMGF=1
OK
AT+CSMP=49 /*Set Message type to Status Report, see +CMGW*/
OK
AT+CSMP?
+CSMP: 49,167,0,0
OK
AT+CNMI=0,0,0,2
OK
AT+CMGS="052468000"
> Hello
+CMGS: 188
OK
+CDSI: "SM",14
```

+CDS, Unsolicited Response (New SMS-STATUS-REPORT Receipt)

The +CDS unsolicited response is sent to the TE upon receipt of a new mobile-terminated SM if the +CNMI parameter <ds> is set to '1'. For further information, refer to ["+CNMI, New Message Indications to Terminal"](#) on page 3-82.

This unsolicited message displays the received SMS-DELIVER message.

Unsolicited Response

In text mode: (+CMGF=1):

+CDS: <fo>,<mr>,<ra>,<tora>,<secs>,<dt>,<st><CR><LF>

In PDU mode: (+CMGF=0):

+CDS: <length><CR><LF><pdu>

The following table shows the +CDS parameters.

Table 3-53: +CDS Parameters

<Parameter>	Description
<fo>	First octet of the SM
<mr>	Message Reference
<ra>	Message Recipient address
<tora>	Type of Recipient address
<scts>	Service center time stamp
<dt>	Discharge-Time
<st>	Status

After sending a +CDS unsolicited response to the TE, the G24-L will expect a +CNMA (new message acknowledgement) from the TE within a predefined timeout of 60 seconds. The G24-L will not send another +CDS unsolicited response to the TE before the previous one is acknowledged. If the +CDS is acknowledged within the timeout, the new SM is not saved in the message storage. If the +CDS is not acknowledged and the timeout has expired, the new SM is saved in the message storage and +CNMI parameter <ds> is set to '0'.

Example

```

AT+CMGF=1
OK
AT+CSMP=49
OK
AT+CSMP?
+CSMP: 49,167,0,0
OK
AT+CNMI=0,0,0,1
OK
AT+CMGS="052468000"
> Hello
+CMGS: 187
OK
+CDS: 6,187,"+97252468000",145,"05/08/03,08:56:34+08","05/08/03,08:56:34+08",70
AT+CNMA
OK

```

+CMGL, +MMGL, List Messages

These commands display a list of all SMs with the status value <stat>, from the G24-L message storage <mem1> (selected using the +CPMS command). The command returns a series of responses, one per message, each containing the message index, status, and data. If the status of a

message is "RECEIVED UNREAD", execution of the +CMGL command changes the status of the message to "RECEIVED READ".

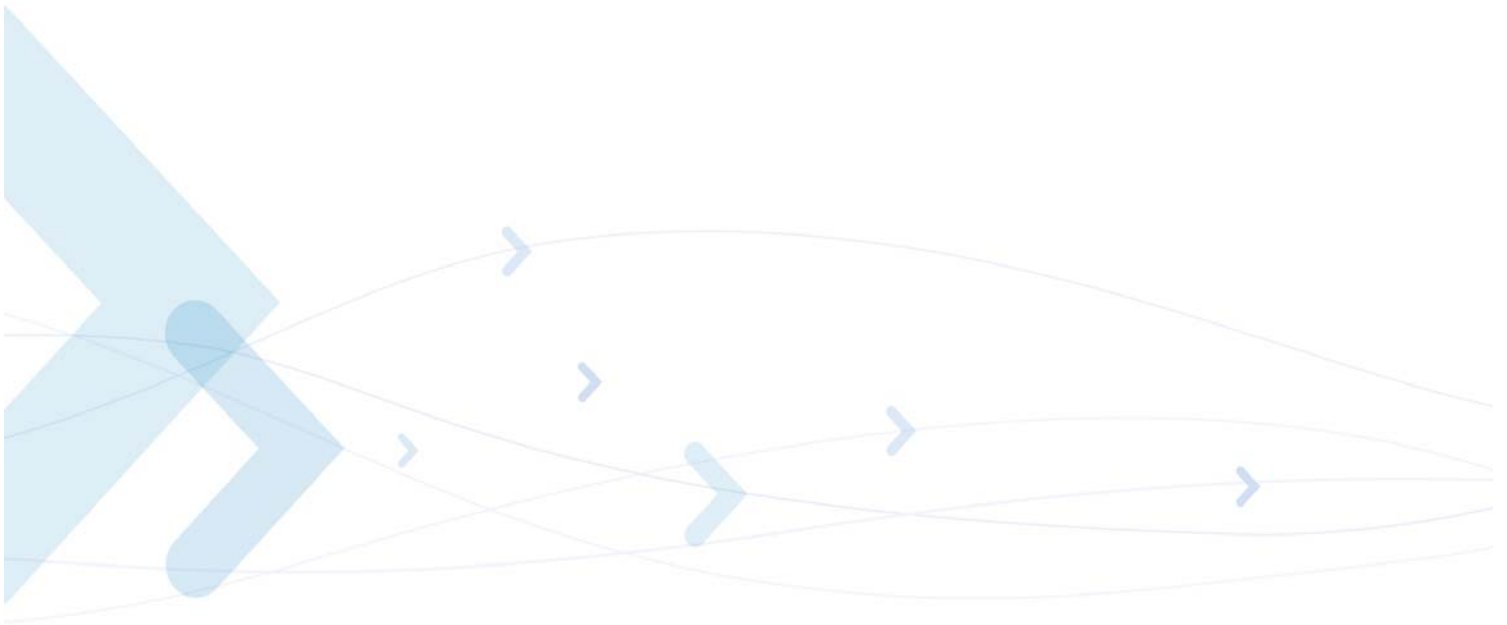

The +MMGL command does not change the message status. In addition, +MMGL includes a <stat> selection that can be used to query the G24-L for a list of message headers without attendant message data.

Command Type	Syntax	Response/Action	Remarks
Set	+CMGL [=<stat>] or +MMGL [=<stat>]	<p>If text mode (+CMGF=1) command execution is successful and SMS-SUBMITs and/or SMS-DELIVERs:</p> <p>+CMGL: <index>,<stat>,<oa/da>,,[<scts>] [,<tooa/toda>,<length>]<CR><LF><data>[<CR><LF>] +CMGL: <index>,<stat>,<da/oa>,,[<scts>] [,<tooa/toda>,<length>]<CR><LF><data>[...]]</p> <p>The parameters <tooa/toda>,<length> refer command shows the Text Mode Parameters +CSDH and will be shown according to +CSDH settings.</p> <p>If text mode (+CMGF=1) command execution is successful and SMS-COMMANDs:</p> <p>+CMGL: <index>,<stat>,<fo>,<ct>[<CR><LF>+CMGL: <index>,<stat>,<fo>,<ct>[...]]</p> <p>If text mode (+CMGF=1), command execution is successful and CBM storage:</p> <p>+CMGL: <index>,<stat>,<sn>,<mid>,<page>,<pages><CR><LF><data>[<CR><LF>] +CMGL: <index>,<stat>,<sn>,<mid>,<page>,<pages> <CR><LF><data>[...]]</p> <p>If text mode (+CMGF=1) command execution is successful and SMS-STATUS_REPORTs:</p> <p>+CMGL: <index>,<stat>,<fo>,<mr>,[<ra>],[<tora>],[<scts>,<dt>,<st>[<CR><LF>] +CMGL: <index>,<stat>,<fo>,<mr>,[<ra>],[<tora>],[<scts>,<dt>,<st>[...]]</p> <p>In PDU mode (+CMGF=0):</p> <p>+CMGL: <index>,<stat>,[<alpha>],<length><CR><LF>< pdu>[<CR><LF>] +CMGL: <index>,<stat>,[<alpha>],<length><CR><LF> <pdu>[...]]</p> <p>Or</p> <p>+CMS ERROR: <err></p>	
Test	+CMGL=? +MMGL=?	+CMGL: (list of supported <stat>s) +MMGL: (list of supported <stat>s)	The Test command lists all the supported <stats>

The following table shows the +CGML/+MMGL parameters.

Table 3-54: +CGML/+MMGL Parameters

<Parameter>	Description																					
<index>	1-352 Index of message in storage.																					
<stat>	Status of message in memory: <table border="1" data-bbox="503 504 1266 850"> <thead> <tr> <th data-bbox="503 504 649 556">PDU mode</th> <th data-bbox="649 504 885 556">Text mode</th> <th data-bbox="885 504 1266 556">Description</th> </tr> </thead> <tbody> <tr> <td data-bbox="503 556 649 609">0</td> <td data-bbox="649 556 885 609">"REC UNREAD"</td> <td data-bbox="885 556 1266 609">Received unread messages (default)</td> </tr> <tr> <td data-bbox="503 609 649 661">1</td> <td data-bbox="649 609 885 661">"REC READ"</td> <td data-bbox="885 609 1266 661">Received read messages</td> </tr> <tr> <td data-bbox="503 661 649 714">2</td> <td data-bbox="649 661 885 714">"STO UNSENT"</td> <td data-bbox="885 661 1266 714">Stored unsent messages</td> </tr> <tr> <td data-bbox="503 714 649 766">3</td> <td data-bbox="649 714 885 766">"STO SENT"</td> <td data-bbox="885 714 1266 766">Stored sent message</td> </tr> <tr> <td data-bbox="503 766 649 819">4</td> <td data-bbox="649 766 885 819">"ALL"</td> <td data-bbox="885 766 1266 819">All messages</td> </tr> <tr> <td data-bbox="503 819 649 850">5</td> <td data-bbox="649 819 885 850">"HEADER ONLY"</td> <td data-bbox="885 819 1266 850">Header only (applies to +MMGL only)</td> </tr> </tbody> </table>	PDU mode	Text mode	Description	0	"REC UNREAD"	Received unread messages (default)	1	"REC READ"	Received read messages	2	"STO UNSENT"	Stored unsent messages	3	"STO SENT"	Stored sent message	4	"ALL"	All messages	5	"HEADER ONLY"	Header only (applies to +MMGL only)
PDU mode	Text mode	Description																				
0	"REC UNREAD"	Received unread messages (default)																				
1	"REC READ"	Received read messages																				
2	"STO UNSENT"	Stored unsent messages																				
3	"STO SENT"	Stored sent message																				
4	"ALL"	All messages																				
5	"HEADER ONLY"	Header only (applies to +MMGL only)																				
<oa/da>	Original/destination address.																					
<data>	Message contents in text mode.																					
<length>	In PDU mode: Size of message, in octets, excluding SMSC data. In TEXT mode: Number of characters included in <data>.																					
<pdu>	Message header and contents in PDU mode format. See description in "+CMGR, +MMGR, Read Message" on page 3-94.																					
<todo/toda>	Type of origination address / destination address																					
<fo>	First octet of the SM																					
<mr>	Message reference																					
<ra>	Recipient-Address																					
<tora>	Type Of Recipient-Address																					
<scst>	Service center time stamp																					
<ct>	Command type																					
<sn>	Message serial number																					
<mid>	Message ID																					
<page>	Current page number																					
<pages>	Total number of pages																					
<dt>	Discharge-Time																					
<st>	Status																					

Example

```

AT+CMGL=?
+CMGL: ("REC UNREAD","REC READ","STO UNSENT","STO SENT","ALL")
OK
AT+MMGL=?
+MMGL: ("REC UNREAD","REC READ","STO UNSENT","STO SENT","ALL","HEADER ONLY")
OK
AT+CPMS="SM" // read messages from SIM.
+CPMS: 2,20,11,61,2,20
OK
AT+MMGL // read "rec-unread" messages without changing message stat
+MMGL: 1,"REC UNREAD","+972544565034",,"05/01/01,09:21:22+08"
message text
OK
AT+CMGL // read "rec-unread" messages with changing message stat
+CMGL: 1,"REC UNREAD","+972544565034",,"05/01/01,09:21:22+08"
message text
OK
AT+CMGL
OK // the message stat was changed. No "rec-unread" messages.
AT+CPMS="ME"
+CPMS: 11,61,11,61,2,20
OK
AT+CMGL="sto sent"
+CMGL: 142,"STO SENT","054565034",,
message text
OK
AT+CSDH=1
OK
AT+CMGL="STO SENT"
+CMGL: 142,"STO SENT","054565034",,,81,<message length>
message text
OK
AT+CMGS=18 //send to myself
> 079179521201009511000c917952446505430004AA0441424344
+CMGS: 68
OK
AT+CPMS="sm" // change to SIM to read the incoming messages
+CPMS: 2,20,11,61,2,20
OK
AT+MMGL
+MMGL: 2,0,,23
0791795212010095040C917952446505430004502032114340800441424344
OK

```

+CMGR, +MMGR, Read Message

These commands handle the reading of SMS. The command displays the message in location <index> of the preferred message storage <mem1> (selected using the +CPMS command). If the status of the message is "RECEIVED UNREAD", the +CMGR command changes the status to "RECEIVED READ". The +MMGR command does not change the message status.

Command Type	Syntax	Response/Action	Remarks
Set	+CMGR=<index> or +MMGR=<index >	<p>If text mode (+CMGF=1) command execution is successful and SMS-DELIVER: +CMGR: <stat>,<oa>,[<alpha>],<scts> [,<tooa>,<fo>,<pid>,<dcs>,<sca>,<tosca>,<length>] <CR><LF><data></p> <p>If text mode (+CMGF=1) command execution is successful and SMS-SUBMIT: +CMGR: <stat>,<da>,[<alpha>] [,<toda>,<fo>,<pid>,<dcs>,[<vp>],<sca>,<tosca> ,<length>] <CR><LF><data></p> <p>If text mode (+CMGF=1) command execution is successful and SMS-COMMAND: +CMGR: <stat>,<fo>,<ct> [,<pid>,[<mn>],[<da>],[<toda>],<length>] <CR><LF><data></p> <p>If text mode (+CMGF=1) command execution is successful and CBM storage: +CMGR: <stat>,<sn>,<mid>,<dcs>,<page>,<pages> <CR><LF><data></p> <p>If text mode (+CMGF=1) command execution is successful and SMS-STATUS-REPORT: +CMGR: <stat>,<fo>,<mr>,[<ra>],[<tora>],<scts>,<dt>,<st></p> <p>If PDU mode (+CMGF=0) and command execution is successful: +CMGR: <stat>,[<alpha>],<length> <CR><LF><pdu></p> <p>otherwise: +CMS ERROR: <err></p>	The Set command reads the SM located at <index> in the G24-L message storage and displays it.

The following table shows the +CMGR/MMGR parameters.

Table 3-55: +CMGR/+MMGR Parameters

<Parameter>	Description																		
<index>	1-352 Index in storage of the message. to be retrieved.																		
<stat>	Status of message in memory: <table border="1" data-bbox="597 506 1365 806"> <thead> <tr> <th>PDU mode</th> <th>Text mode</th> <th>Description</th> </tr> </thead> <tbody> <tr> <td>0</td> <td>“REC UNREAD”</td> <td>Received unread messages (default)</td> </tr> <tr> <td>1</td> <td>“REC READ”</td> <td>Received read messages</td> </tr> <tr> <td>2</td> <td>“STO UNSENT”</td> <td>Stored unsent messages</td> </tr> <tr> <td>3</td> <td>“STO SENT”</td> <td>Stored sent message</td> </tr> <tr> <td>4</td> <td>“ALL”</td> <td>All messages</td> </tr> </tbody> </table>	PDU mode	Text mode	Description	0	“REC UNREAD”	Received unread messages (default)	1	“REC READ”	Received read messages	2	“STO UNSENT”	Stored unsent messages	3	“STO SENT”	Stored sent message	4	“ALL”	All messages
PDU mode	Text mode	Description																	
0	“REC UNREAD”	Received unread messages (default)																	
1	“REC READ”	Received read messages																	
2	“STO UNSENT”	Stored unsent messages																	
3	“STO SENT”	Stored sent message																	
4	“ALL”	All messages																	
<alpha>	Alpha ID of message (not present).																		
<length>	In PDU mode: Size of message, in octets, excluding SMSC data. In TEXT mode: Number of characters included in <data>.																		
<pdu>	Message header and contents in PDU mode format. See description in the tables below.																		
<oa/da>	Original/destination address.																		
<data>	Message contents in text mode.																		
<todo/toda>	Type of origination address / destination address																		
<fo>	First octet of the SM																		
<pid>	Protocol Identifier																		
<dcsc>	Data Coding Scheme																		
<sca>	Service Center Address																		
<tosca>	Type of Service Center Address																		
<vp>	Validity Period. Either in integer format (see Table 3-46) or in time-string format ("yy/MM/dd,hh:mm:ss±zz").																		
<mr>	Message reference																		
<scst>	Service center time stamp																		
<ct>	Command type																		
<sn>	Message serial number																		
<mn>	Message Number																		
<cdata>	Command-Data																		
<mid>	Message ID																		
<page>	Current page number																		

Table 3-55: +CMGR/+MMGR Parameters (Cont.)

<Parameter>	Description
<pages>	Total number of pages
<mr>	Message Reference
<ra>	Message Recipient address
<tora>	Type of Recipient address
<scts>	Service center time stamp
<dt>	Discharge-Time
<st>	Status

Table 3-56: Layout of SMS-DELIVER in PDU Mode (according to GSM03.40)

Reference	Description	Length
<sca>	Service Center address: 1 BYTE: length (number of followed octets). Mandatory 1 BYTE: <tosca> - value between 128-255	1, 3-12 BYTES (When length is 1, length BYTE = 0)
<fo>	First Octet. See Table 3-57 .	1 BYTE
<TP-OA>	Originating address formatted according to the formatting rules of address fields.	2-12 BYTES
<TP-PID>	Protocol-Identifier. Values between 0-255.	1 BYTE
<TP-DCS>	Data Coding Scheme. Values between 0-255.	1 BYTE
<TP-SCTS>	The TP-Service-Center-Time-Stamp field is given in semi-octet representation, and represents the local time as described in GSM03.40	7 BYTE
<TP-UDL>	User data length	1 BYTE
<TP-UD>	User data	0-140 BYTES

Note: Any unused bits will be set to zero and will be ignored by the receiving entity.

Table 3-57: <fo> for SMS-DELIVER Message

Bit/s	Reference	Description
0-1	Message-Type-Indicator	Parameter describing the message type. 0 0 SMS-DELIVER (in the direction SC to MS)
2	TP-More-Message-To-Send	Parameter indicating whether or not more messages are waiting to the MS in the SC. 0 More messages are waiting for the MS in this SC 1 No more messages are waiting for the MS in this SC
5	TP-Status-Report-Indication	Parameter indicating if a status report is requested by the MS 0 A status report is not requested 1 A status report is requested
6	TP-User-Data-Header-Indicator	Parameter indicating whether or not a status report will be returned to the SME. 0 A status report will not be returned to the SME 1 A status report will be returned to the SME
7	TP-Reply-Path	Parameter indicating that Reply Path is set or not. 0 TP-Reply-Path parameter is not set 1 TP-Reply-Path parameter is set

Table 3-58: Layout of SMS-STATUS-REPORT in PDU Mode (according to GSM03.40)

Reference	Description	Length
<sca>	Mandatory: Service Center address: 1 BYTE: length (number of followed octets) Mandatory: 1 BYTE: <tosca> - value between 128-255	1, 3-12 BYTES (When length is 1, length BYTE = 0)
<fo>	Mandatory: First Octet. See Table 3-59 .	1 BYTE
<mr>	Mandatory: Message Reference number, which identifying the previously submitted SMS-SUBMIT or SMS-COMMAND	1 BYTE

Table 3-58: Layout of SMS-STATUS-REPORT in PDU Mode (according to GSM03.40) (Cont.)

Reference	Description	Length
<TP-RA>	Mandatory: Recipient address formatted according to the formatting rules of address fields.	2-12 BYTES
<TP-SCTS>	Mandatory: The TP-Service-Center-Time-Stamp field is given in semi-octet representation, and represents the local time as described in GSM03.40	7 BYTE
<TP-DT>	Mandatory: Discharge-Time of <TP-ST>, is given in semi-octet representation, and represents the local time as described in GSM03.40	7 BYTES
<TP-ST>	Mandatory: Status of the MO message	1 BYTE
<TP-PI>	Optional: Parameter indicating the presence of any of the optional parameters which follow. See Table 3-59 .	1 BYTE
<TP-PID>	Optional: Protocol-Identifier. Values between 0-255.	1 BYTE
<TP-DCS>	Optional: Data Coding Scheme. Values between 0-255.	1 BYTE
<TP-UDL>	Optional: User data length	1 BYTE
<TP-UD>	Optional: User data	131 BYTES

- Notes:**
- Any unused bits will be set to zero by the sending entity and will be ignored by the receiving entity.
 - The maximum guaranteed length of TP-UD is 131 octets. In order to achieve the maximum octet of 143, the TP-RA field must have a length of two octets and TP-PID and TP-DCS must not be present.
 - TP-PI is Mandatory if any of the optional parameters following TP-PI is present, otherwise optional.

Table 3-59: <fo> for SMS-STATUS-REPORT Message

Bit/s	Reference	Description
0-1	Mandatory: Message-Type-Indicator	Parameter describing the message type. 1 0 SMS-STATUS-REPORT (in the direction SC to MS)
2	Mandatory: TP-More-Message-To-Send	Parameter indicating whether or not more messages are waiting to the MS in the SC. 0 More messages are waiting for the MS in this SC 1 No more messages are waiting for the MS in this SC
5	Mandatory: TP-Status-Report-Qualifier	Parameter indicating whether the previously submitted TPDU was an SMS-SUBMIT or an SMS-COMMAND: 0 The SMS-STATUS-REPORT is the result of a SMS-SUBMIT. 1 The SMS-STATUS-REPORT is the result of an SMS-COMMAND
6	Optional: TP-User-Data-Header-Indicator	Parameter indicating whether or not a status report will be returned to the SME. 0 A status report will not be returned to the SME 1 A status report will be returned to the SME

Table 3-60: <TP-PI> for SMS-STATUS-REPORT Message

Bit/s	Description
0	0 TP-PID not presence 1 TP-PID not presence
1	0 TP-DCS not presence 1 TP-DCS presence
2	0 TP-UDL not presence 1 TP-UDL presence
3-7	Reserved

Note: Reserved bits are ignored.

Example

```

AT+CPMS?
+CPMS: "ME",5,59,"ME",5,59,"SM",5,20
OK
AT+CMGR=1
+CMS ERROR: invalid index
AT+CMGR=142
+CMGR: "STO SENT","054565034",
message text
OK
AT+CSDH=1
OK
AT+CMGR=142
+CMGR: "STO SENT","054565034",,129,25,0,0,"05/04/03,21:22:23+08","+97254120032",145,<message
length>
message text
OK
AT+CMGW=18
> 079179521201009511000c917952428650290004AA0441424344
+CMGW: 143
OK
AT+CMGR=143
+CMGR: 2,,23
0791795212010095040C917952428650290004502032110201800441424344
OK
AT+CPMS="SM" // change to SM to read SMS-DELIVER messages.
+CPMS: 2,20,11,61,2,20
OK
AT+CMGR=1
+CMGR: "REC READ","+972544565034",,"05/02/23,11:20:10+08",145,4,0,4,"+97254120032",145,4
41424344
OK
AT+CMGF=0
OK
AT+CMGR=1
+CMGR: 0,,23
0791 07917952140230F2040C917952446505430004502032110201800441424344
OK
AT+CMGR=14
+CMGR: 0,,25
079179521201009506BC0B917952428600F0508030807512805080308075128046
// SMS-STATUS-REPORT message in PDU mode

OK
AT+CMGF=1
OK
AT+CMGR=14 // SMS-STATUS-REPORT message in Text mode
+CMGR: "REC READ",6,188,"+97252468000",145,"05/08/03,08:57:21+08",,"05/08/03,08:5
7:21+08",70
OK

```

+MMAR, Motorola Mark As Read

This command handles changing the <stat> attribute of an SM in the G24-L memory location <index>, preferred message storage <mem1>, from "REC UNREAD" to "REC READ". (<mem1> is selected using the +CPMS command.) If the status change fails, +CMS ERROR: <err> is returned.

Command Type	Syntax	Response/Action	Remarks
Set	+MMAR=<index>	OK or: +CMS ERROR: <err>	
Read			The Read command for +MMAR is not defined, and therefore is not supported by the G24-L. The G24-L returns an error.
Test			The Test command for +MMAR is not defined, and therefore is not supported by the G24-L. The G24-L returns an error.

The following table shows the +MMAR parameters.

Table 3-61: +MMAR Parameters

<Parameter>	Description
<index>	Index of the message to be marked as read, in the SMS memory.

Example

```
AT+MMGR=1
+MMGR: "REC UNREAD", "+972544565034", "04/11/04,09:48:36+08"
message text
OK
AT+MMAR=1
OK
AT+MMGR=1
+MMGR: "REC READ", "+972544565034", "04/11/04,09:48:36+08"
message text
OK
```

+CMSS, Send Message From Storage

This command sends a pre-stored message, written previously using the +CMGW command. The <da>, <tda> parameters are optional. If a DA is given, the message is sent to that address.

Otherwise the message is sent to the DA it was stored with (if any was entered). If no DA is found, an error occurs.

When the given index is an incoming message index the header settings will be as follows:

- <first-octet> will be SMS-SUBMIT and VPF - relative.
- The TP-RP and TP-UDHI settings will be taken from the incoming message's first octet.
- <vp> - will be set to the default value -167 - as defined in 03.40.
- <sca>, <tosca>, <pid> and <dc> will be set according the incoming message parameters.
- If <da> and/or < toda> are not given by the command, the <oa> and <tooa> will be set instead.

Command Type	Syntax	Response/Action	Remarks
Set	+CMSS=<index>[,<da>[,< toda>]]	+CMSS: <mr> or: +CMS ERROR: <err>	The Set command sends a message from storage to the network.

The following table shows the +CMSS parameters.

Table 3-62: +CMSS Parameters

<Parameter>	Description
<index>	1-352 Index in storage of the message to be sent.
<da>	Destination address in quoted string. This field contains a single phone number.
< toda>	Type of DA. Value between 128-255 (according to GSM 03.40, 9.1.2.5). If this field is not given and first character of <da> is '+', < toda> will be 145, otherwise 129.
<mr>	Sent message reference number.

Example

```
AT+CMSS=7
+CMSS: 12
OK
AT+CMSS=7,"054565132",129
+CMSS: 13
OK
```

Note: Any character sent by TE to G24-L before G24-L has reported a result of AT+CMSS operation, will abort AT+CMSS command execution. However, if SMS was already sent to network and sending operation was successful, the result of operation "+CMSS <mr>" will be reported by G24-L. If after aborting AT+CMSS command execution and before result of operation was reported by G24-L, a second AT+CMSS command is executed, then the result of the second AT+CMSS operation only will be reported by G24-L.

+CMGW, Write Message to Memory

This command is used to write and save a message to <mem2>. The message is saved in memory, and the message index is displayed to the user.

By default, messages are saved with the status of "STO UNSENT", but status "STO SENT" can be applied using the <stat> parameter.

In TEXT mode, the header parameters will be set according to CSMP settings.

Command Type	Syntax	Response/Action	Remarks
Set	If text mode (+CMGF=1): +CMGW[=<da>[,<toda>[,<stat>]]]<CR> text is entered <ctrl-Z/ESC> if PDU mode (+CMGF=0): +CMGW=<length>[,<stat>]<CR> PDU is given <ctrl-Z/ESC>	+CMGW: <index> or: +CMS ERROR: <err>	The Set command writes a message and stores it.

The following table shows the +CMGW parameters.

Table 3-63: +CMGW Parameters

<Parameter>	Description
<da>	Destination address in quoted string. This field contains a single phone number.
<toda>	Type of DA. Value between 128-255 (according to GSM 03.40, 9.1.2.5). If this field is not given and first character of <da> is '+', <toda> will be 145, otherwise 129.
<stat>	Status of new message In text mode: "STO UNSENT" (default) or "STO SENT" In PDU mode: 2 (default) or 3
<length>	Size of message in PDU mode format, in octets, excluding SMSC data.
<index>	1-352 Index in storage of the stored message.
<PDU>	Message header and contents in PDU mode format. See description in the tables below.

Table 3-64: Layout of SMS-SUBMIT in PDU Mode: (according to GSM03.40)

Reference	Description	Length
<sca>	Service Center address: 1 BYTE: length (number of followed octets). Mandatory 1 BYTE: <tosca> - value between 128-255	1, 3-12 BYTES (When length is 1, length BYTE = 0)
<fo>	First Octet. See the table below.	1 BYTE
<TP-MR>	Message Reference. An integer representation of a reference number of the SM submitted to the SC by the MS. Values between 0-255.	1 BYTE
<TP-DA>	Destination address formatted according to the formatting rules of address fields.	2-12 BYTES
<TP-PID>	Protocol-Identifier. Values between 0-255.	1 BYTE
<TP-DCS>	Data Coding Scheme. Values between 0-255.	1 BYTE
<TP-VP>	Validity Period. depending on <fo>, TP-Validity-Period-Format bits setting.	0, 1, 7 BYTE
<TP-UDL>	User data length	1 BYTE
<TP-UD>	User data	0-140 BYTES

Table 3-65: Layout of SMS-COMMAND in PDU Mode: (according to GSM03.40)

Reference	Description	Length
<sca>	Service Center address: 1 BYTE: length (number of followed octets). Mandatory 1 BYTE: <tosca> - value between 128-255	1, 3-12 BYTES (When length is 1, length BYTE = 0)
<fo>	First Octet. See Table 3-66 .	1 BYTE
<TP-MR>	Message Reference. An integer representation of a reference number of the SM submitted to the SC by the MS. Values between 0-255.	1 BYTE
<TP-PID>	Protocol-Identifier. Values between 0-255.	1 BYTE
<TP-CT>	Command Type	1 BYTE
<TP-MN>	Message Number	1 BYTE
<TP-DA>	Destination address formatted according to the formatting rules of address fields.	2-12 BYTES

Table 3-65: Layout of SMS-COMMAND in PDU Mode: (according to GSM03.40)

Reference	Description	Length
<TP-CDL>	Command data length	1 BYTE
<TP-CD>	Command data	0-156 BYTES

Table 3-66: <fo> for SMS-SUBMIT Message

Bit/s	Reference	Description
0-1	Message-Type-Indicator	Parameter describing the message type. 0 1 SMS-SUBMIT (in the direction MS to SC)
2	TP-Reject-Duplicates	Parameter indicating whether or not the SC shall accept an SMS-SUBMIT for an SM still held in the SC which has the same MR and the same DA as a previously submitted SM from the same OA. 0 Instruct the SC to accept an SMS-SUBMIT as mention above 1 Instruct the SC to reject an SMS-SUBMIT as mention above. In this case an appropriate TP-FCS value will be returned in the SMS-SUBMIT-REPORT.
3-4	TP-Validity-Period-Format	Parameter indicating whether the TP-VP field is present and in which format. 0 0 TP-VP field not present 1 0 TP-VP field present - relative format 0 1 TP-VP field present - enhanced format - valid only in PDU mode 1 1 TP-VP field present - absolute format
5	TP-Status-Report-Request	Parameter indicating if a status report is requested by the MS 0 A status report is not requested 1 A status report is requested
6	TP-User-Data-Header-Indicator	Parameter indicating whether the beginning of the User Data field contains a Header in addition to the short message or contains only the short message 0 The TP-UD field contains only the short message 1 The beginning of the TP-UD field contains a Header in addition to the short message
7	TP-Reply-Path	Parameter indicating that Reply Path is set or not. 0 TP-Reply-Path parameter is not set 1 TP-Reply-Path parameter is set

Table 3-67: <fo> for SMS-COMMAND Message

Bit/s	Reference	Description
0-1	Message-Type-Indicator	Parameter describing the message type. 1 0 SMS-COMMAND (in the direction MS to SC)
5	TP-Status-Report-Request	Parameter indicating if a status report is requested by the MS 0 A status report is not requested 1 A status report is requested
6	TP-User-Data-Header-Indicator	Parameter indicating whether the beginning of the User Data field contains a Header in addition to the short message or contains only the short message 0 The TP-UD field contains only the short message 1 The beginning of the TP-UD field contains a Header in addition to the short message

Note: Any unused bits will be set to 0.

Example

```

AT+CMGF=1
OK
AT+CMGW="5124335432"
>This is the message body <CTRL+Z>//<CTRL+Z> ends the prompt text mode and returns to
regular AT command mode

+CMGW: 126
OK
AT+CMGW
> TEST <CTRL+Z>
+CMGW: 195
OK
AT+CMGF=0
OK
AT+CMGW=24
>079179521201009511FF0B917962543940F20008001400410042004300440045 <CTRL+Z>
+CMGW: 128
OK
AT+CMGR=128
+CMGR: 2,,24
079179521201009511FF0B917962543940F20008001400410042004300440045
OK
AT+CMGF=1
OK
AT+CSDH=1
OK
AT+CMGR=128
+CMGR: "STO UNSENT", "+97264593042",,,145,17,0,8,0,"+972521100059",145,5

```

```

00410042004300440045
OK
AT+CSMP=25,"05/03/15,21:22:23+08",0,0
OK
AT+CMGW="0544565034"
A<CTRL+Z>
+CMGW: 129
OK
AT+CMGR=129
+CMGR: "STO UNSENT", "0544565034",,129,25,0,0,"05/03/15,21:22:23+08", "+972521100059",145,1
A
OK
AT+CMGF=0
OK
AT+CMGR=129
+CMGR: 2,,20
079179521201009519FF0A8150446505430000503051122232800141
AT+CMGW=18
> 0011000c917952428650290004AA0441424344 // SCA is not given
+CMGW: 130
OK
AT+CMGR=130
+CMGR: 2,,18
079179521201009511000C917952428650290004AA0441424344
OK
AT+CMGW=19
> 079179521201009511000c917952428650290004AA0441424344 //Invalid length (19)
+CMS ERROR: invalid PDU mode parameter
AT+CMGW=19
> 079179521201009511000c917952428650290004AA044142434477 //UDL is not equal to UD length
+CMS ERROR: invalid PDU mode parameter
AT+CMGW=17
> 079179521201009501000c9179524286502900040441424344 //No VP in PDU message
+CMGW: 131
OK
AT+CMGR=131
+CMGR: 2,,17
079179521201009501000C9179524286502900040441424344
OK
AT+CMGW=14
> 07917952140230F212000000000c9179524286502900 //SMS Command
+CMGW: 132
OK
AT+CMGR=132
+CMGR: 2,,14
07917952140230F212000000000C9179524286502900
OK
AT+CMGF=1
OK
AT+CMGR=132
+CMGR: "STO UNSENT",18,0,0,0,"+972524680592",145,0
OK

```

+CMGD, Delete Message

This command handles deletion of a single message from memory location <index>, or multiple messages according to <delflag>. If the optional parameter <delflag> is entered, and is greater than 0, the <index> parameter is practically ignored. If deletion fails, result code +CMS ERROR: <err> is returned.

Note: The deletion of multiple commands is a time-consuming process that may require more than 60 seconds to complete.

Command Type	Syntax	Response/Action	Remarks
Set	+CMGD=<index> [,<delflag>]	OK or: +CMS ERROR: <err>	
Read			The Read command for +CMGD is not defined by ETSI, and therefore is not supported by the G24-L. The G24-L returns an error.
Test	+CMGD=?	+CMGD: (list of valid <index>s), (list of valid <delflag>s)	The Test command displays the supported values of <n>.

The following table shows the +CMGD parameters.

Table 3-68: +CMGD Parameters

<Parameter>	Description
<index>	1-352 Index in the SMS memory of the message to be deleted.
<delflag>	0 Deletes the message specified in <index> 1 Deletes all read messages 2 Deletes all read messages and sent MO messages 3 Deletes all read messages, sent and unsent MO messages 4 Deletes all messages

Example

```
AT+CMGD=4
OK
AT+CMGD=1,3
OK
```

+CGSMS, Select Service for MO SMS Messages

This command handles the selection of the service or service preference used by the G24-L to send mobile-originated SMS messages.

Note: This command is network dependent, which means that the network must support SMS over GPRS.

Command Type	Syntax	Response/Action	Remarks
Set	+CGSMS=[<service>]	OK +CME ERROR: <err>	The Set command selects the service or service preference used to send SMS messages. The value that is set is not retained after a power cycle.
Read	+CGSMS?	+CGSMS: <service> +CME ERROR: <err>	The Read command displays the current SMS service preference setting.
Test	+CGSMS=?	+CGSMS: (list of currently available <service>s) +CME ERROR: <err>	The Test command displays a list of currently available <service>s on the network.

The following table shows the +CGSMS parameters.

Table 3-69: +CGSMS Parameters

<Parameter>	Description
<service>	Indicates the service or service preference to be used. 0 GPRS 1 Circuit switched (default) 2 GPRS preferred (use circuit switched if GPRS is not available) 3 Circuit switched preferred (use GPRS if circuit switched is not available) Other values are reserved and will result in an ERROR response to the Set command.

Example

```
AT+CGSMS=?
CGSMS:(0-3)
OK
AT+CGSMS?
CGSMS: 1
OK
```

+CMGS, Send SM to Network

This command sends an SM from the G24-L to the network. The message reference value <mr> is returned to the G24-L upon successful delivery of the message.

Note: The DCD signal will be in ON state while text is entered.

The header parameters in TEXT mode will be set according to CSMP settings.

Command Type	Syntax	Response/Action	Remarks
Set	If text mode (+CMGF=1): +CMGS=<da>[,<toda>]<CR> text is entered<ctrl-Z/ESC> If PDU mode (+CMGF=0): +CMGS=<length><CR> PDU is entered<ctrl-Z/ESC>	+CMGS: <mr> +CMS ERROR: <err>	The Set command validates the input parameters, sends the SM to network and reports the result of the operation to the G24-L.

The following table shows the +CMGS parameters.

Table 3-70: +CMGS Parameters

<Parameter>	Description
<da>	Destination address in quoted string. This field contains a single MIN number.
<toda>	Type of DA. Value between 128-255 (according to GSM 03.40, 9.1.2.5). If this field is not given and first character of <da> is '+', <toda> will be 145, otherwise 129.
<length>	Size of message in PDU mode format, in octets, excluding SMSC data.
<mr>	Sent message reference number.
PDU	Message header and contents in PDU mode format. See description in +CMGW section.

Example

```
AT+CMGS="064593042",129
```

>This is the message body <CTRL+Z> //<CTRL+Z> ends the prompt text mode and returns to regular AT command mode

```
OK
```

```
AT+CMGF=0
```

```
OK
```

```
AT+CMGS=24
```

```
>079179521201009511FF0B917962543940F20008001400410042004300440045 <CTRL+Z>
```

```
+CMGS: 128
```

```
OK
```

Note: Any character sent by TE to G24-L before G24-L has reported a result of AT+CMGS operation, will abort AT+CMGS command execution. However, if SMS was already sent to network and sending operation was successful, the result of operation "+CMGS <mr>" will be reported by G24-L.

A flex dependant enhancement enables the reporting of numeric error code to TE, in case the sending operation has failed. The numeric error code will be reported in format:

```
" +CMGS ERROR: <err>".
```

If after aborting AT+CMGS command execution and before result of operation was reported by G24-L, a second AT+CMGS command is executed, then the result of the second AT+CMGS operation only will be reported by G24-L.

+MCSAT, Motorola Control SMS Alert Tone

This command enables/disables/exercises the SMS alert tone for an arriving SMS. It does not apply on Cell Broadcast SMS.

Command Type	Syntax	Response/Action	Remarks
Set	+MCSAT=<mode> [,<dc_s_mask>[,....]]	OK or: +CME ERROR: <err>	The Set command is used to: <ul style="list-style-type: none"> • Suppress (mute) the voice notification (alert tone) of a specific incoming SMS, identified by the received <dc_s_mask>s property • Enable voice notification (alert tone) of all incoming SMS events • Activate the current alert tone for an incoming SMS event
Read	+MCSAT?	+MCSAT: <mode>[,<dc_s_mask>[,]] OK or: +CME ERROR: <err>	The Read command returns the current <mode> and current <dc_s_mask>s.
Test	+MCSAT=?	+MCSAT: (list of supported <mode>s) OK or: +CME ERROR: <err>	The Test command returns the possible <mode> values.

The following table shows the +MCSAT parameters.

Table 3-71: +MCSAT Parameters

<Parameter>	Description
<mode>	0 Suppress alert tone 1 Enable alert tone 2 Play alert tone The default value at power-up is 1.
<dc_s_mask>	SMS data coding-scheme mask. The format is an 8-bit information parameter. Each bit contains 0, 1, or X (ASCII character): 0 Condition is met if the arriving SMS includes dcs with 0 in this position 1 Condition is met if the arriving SMS includes dcs with 1 in this position X or x This bit is ignored from the dcs of the arriving SMS

Example

```
AT+MCSAT=?  
+MCSAT:(0-2)  
OK  
AT+MCSAT?  
+MCSAT: 1  
OK  
AT+MCSAT=2  
OK  
AT+MCSAT=1,00001000 // UCS2  
OK  
AT+MCSAT=1,00000100 // UTF8  
OK  
AT+MCSAT=1,00000000 // GSM  
OK  
AT+MCSAT=1  
OK  
AT+MCSAT=0  
OK
```

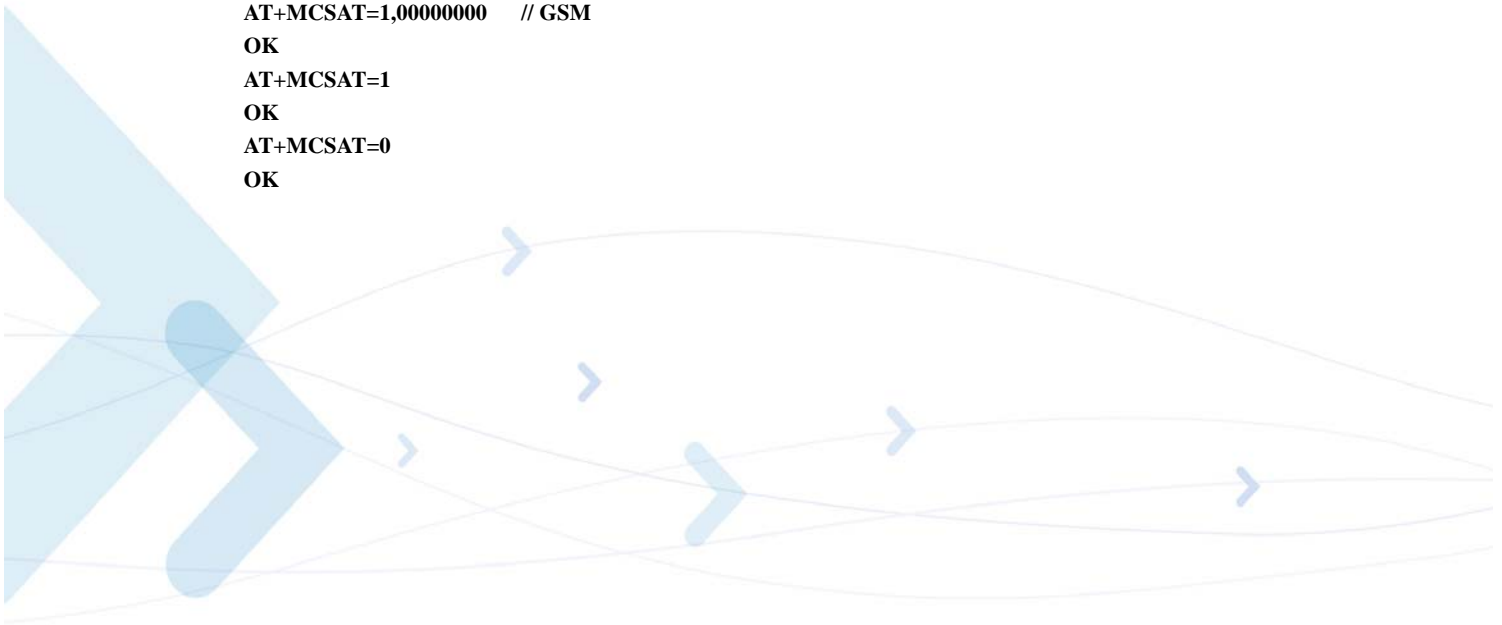

DCS handling

Sending or Storing SM

When sending or storing SM in TEXT mode, only the specified <dc>s in Table 3-46, +CSMP command definitions, will be supported. Handling will be as shown in Table 3-72.

Table 3-72 shows the conversion between the <dc> and +CSCS setting when storing SM to memory or sending SM.

Table 3-72: <dc> field and +CSCS settings conversion when writing SM

CASE	<dc> field	User-Data-Header	Current TE character set (+CSCS)	Action
A	Default alphabet	Not Set	UTF8 or UCS2	Returns an error since conversion from these character sets to default alphabet is impossible.
			GSM	G24-L converts each two IRA characters long hexadecimal number to 7-bit septet.
			ASCII or 8859	G24-L converts each character to 7-bit septet.
B	Default alphabet	Set	All	G24-L converts each two IRA characters long hexadecimal number to one 8-bit octet.
C	8-bit or UCS2	All	All	G24-L converts each two IRA characters long hexadecimal number to one 8-bit octet.

Note: If SMS, requested to be read in TEXT mode, is a GSM '7' bit Default alphabetical encoded and contains undefined extended characters in User Data (e.g. hex base 1B07), then two septets will be converted, as two separate characters accordingly, to currently selected (+CSCS setting) character set.

Reading SM

Any <dc> value is accepted when receiving an SM.

When reading a SM with unsupported <dc> the message header will be passed as usual. The DATA will be output in "HEX" format.

According to the GSM 03.38, Any reserved codings shall be assumed to be the GSM default alphabet (the same as DCS value 0x00) by a receiving entity. Handling will be as shown in [Table 3-73](#).

[Table 3-73](#) shows the conversion between the <dc> and +CSCS setting when reading SM.

Table 3-73: <dc> field and +CSCS settings conversion when reading SM

CASE	<dc> field	User-Data-Header	Current TE character set	Action
A	Default alphabet	Not Set	All	G24-L converts GSM alphabet into current TE character set according to rules of GSM07.05, Annex A
B	Default alphabet	Set	All	G24-L converts each 8-bit from TP-UD, encoded in GSM alphabet into two IRA character long hexadecimal number
C	8-bit or UCS2	All	All	G24-L converts each 8-bit octet into two IRA character long hexadecimal number

Examples:

```

### Store in TEXT mode SMS encoded in default alphabet with UDHI set.
### Character set is ASCII.
AT+CMGF=1
OK
AT+CSMP=81,167,0,0
OK
AT+CMGW="0544565803"
> 050003090301123456786543
+CMGW: 222
OK
AT+CMGR=222
+CMGR: "STO UNSENT","0544565803",
050003090301123456786543
OK
AT+CMGF=0
OK
AT+CMGR=222
+CMGR: 2,,25
07917952140230F251000A8150446585300000A70D050003090301123456786543
OK
### Store in TEXT mode SMS encoded in UCS2 alphabet with UDHI set.
### Character set is ASCII.
AT+CSMP=81,167,0,10
OK
AT+CMGF=1
OK

```

```

AT+CMGW="0544565803"
> 050003090301123456786543FE
+CMGW: 223
OK
AT+CMGR=223
+CMGR: "STO UNSENT","0544565803",
050003090301123456786543FE
OK
AT+CMGF=0
OK
AT+CMGR=223
+CMGR: 2,,26
07917952140230F251000A81504465853000AA70D050003090301123456786543FE
OK
### Store in TEXT mode SMS 8-bit encoded.
### Character set is ASCII.
AT+CSMP=17,167,0,245
OK
AT+CMGF=1
OK
AT+CMGW="0544565803"
> 050003090301123456786543
+CMGW: 225
OK
AT+CMGR=225
+CMGR: "STO UNSENT","0544565803",
050003090301123456786543
OK
AT+CMGF=0
OK
AT+CMGR=225
+CMGR: 2,,25
07917952140230F211000A81504465853000F5A70C050003090301123456786543
OK
### Store in TEXT mode SMS encoded in default alphabet.
### Character set is GSM.
AT+CSMP=17,167,0,0
OK
AT+CMGW="0544565803"
> 4144414441444144414441444144414441444144414441444144414441444144414441444144414441444144414441
44414441444144414441444144414441444144414441444144414441444144414441444144414441444144414441
44414441444144414441444144414441444144414441444144414441444144414441444144414441444144414441
44414441444144414441444144414441444144414441444144414441444144414441444144414441444144414441
44
+CMGW: 227
OK
AT+CMGR=227
+CMGR: "STO UNSENT","0544565803",
41444144414441444144414441444144414441444144414441444144414441444144414441444144414441444144
41444144414441444144414441444144414441444144414441444144414441444144414441444144414441444144
41444144414441444144414441444144414441444144414441444144414441444144414441444144414441444144
41444144414441444144414441444144414441444144414441444144414441444144414441444144414441444144

```

Network

Network Commands

+CSQ, Signal Strength

This command displays the received signal strength indication <rss> and channel bit error rate <ber> from the G24-L.

Command Type	Syntax	Response/Action
Execute/Read	AT+CSQ AT+CSQ?	+CSQ: <rss>,<ber> OK or: +CME ERROR: <err>
Test	AT+CSQ=?	+CSQ: (list of supported <rss>s),(list of supported <ber>s) OK or: +CME ERROR: <err>

The following table shows the +CSQ parameters.

Table 3-74: +CSQ Parameters

<Parameter>	Description
<rss>	0 through 31 - covers the range of -113 dbm (or less) to -51dbm (or greater)
<ber>	Channel bit error rate (in percent) 0-7 RXQUAL values in the GSM 05.08 table 99 Unknown or not detectable

Example

```
AT+CSQ
+CSQ: 031,000
OK
AT+CSQ=?
+CSQ: (000-031,099),(000-007,099)
OK
```

+CRLP, Radio Link Protocol

This command displays the Radio Link Protocol parameters that are used when non-transparent data calls are originated.

Command Type	Syntax	Response/Action	Remarks
Set	+CRLP=[<iws>[,<mws>[,<T1>[,<N2>]]]]	OK or: +CME ERROR: <err>	The Set command enables you to change the RLP parameters.
Read	+CRLP?	+CRLP= <iws>,<mws>,<T1>,<N2> OK or: +CME ERROR: <err>	
Test	+CRLP=?	+CRLP= (list of supported <iws>s), (list of supported <mws>s), (list of supported <T1>s), (list of supported <N2>s) OK or: +CME ERROR: <err>	

The following table shows the +CRLP parameters.

Table 3-75: +CRLP Parameters

<Parameter>	Description
<iws>	IWF to MS window size. The default value is 61.
<mws>	MS to IWF window size. The default value is 61.
<T1>	Acknowledgement timer T1. The default value is 48.
<N2>	Retransmission attempts N2 in integer format (refer to GSM 04.22 [18] subclause 5.4.3) The default value is 15.

Example

```
AT+CRLP=?
+CRLP: (010-061),(010-061),(048-255),(006-015)
OK
AT+CRLP?
+CRLP: 061,061,048,006
OK
```

+CREG, Network Registration Status

Command Type	Syntax	Response/Action	Remarks
Set	AT+CREG=<n>	OK or: +CME ERROR: <err>	The Set command controls the presentation of an unsolicited result code and the result of the Read operation.
Read	AT+CREG?	+CREG: <n>,<stat>[,<lac>,<ci>] OK or: +CME ERROR: <err>	The Read command returns the status of the result code presentation and shows whether the network has currently indicated the registration of the G24-L. Location information elements <lac> and <ci> are returned only when <n>=2 and the G24-L is registered in the network.
Test	AT+CREG=?	+CREG: (list of supported <n>s) OK	

The following table shows the +CREG parameters.

Table 3-76: +CREG Parameters

<Parameter>	Description
<n>	<ul style="list-style-type: none"> 0 Disables the network registration unsolicited result code. 1 Enables the network registration unsolicited result code +CREG: <stat>. 2 Enables the network registration and location information in unsolicited reports and Read command +CREG:<stat>[,<lac>,<ci>]. The default is 0.
<stat>	<ul style="list-style-type: none"> 0 Not registered, and the ME is not currently searching for a new operator to which to register. 1 Registered, home network. 2 Not registered, but the ME is currently searching for a new operator to which to register. 3 Registration denied. 4 Unknown. 5 Registered, roaming.
<lac>	Two-byte location area code in hexadecimal format.
<ci>	Two-byte cell ID in hexadecimal format.

Example

```
AT+CREG=?  
+CREG: (000 - 002)  
OK  
AT+CREG?  
+CREG: 000,001  
OK  
AT+CREG=2  
OK  
AT+CREG?  
+CREG: 002,001, a065,988b  
OK  
AT+CREG=1  
OK  
AT+CREG?  
+CREG: 001,001  
OK  
AT+CREG=0  
OK
```

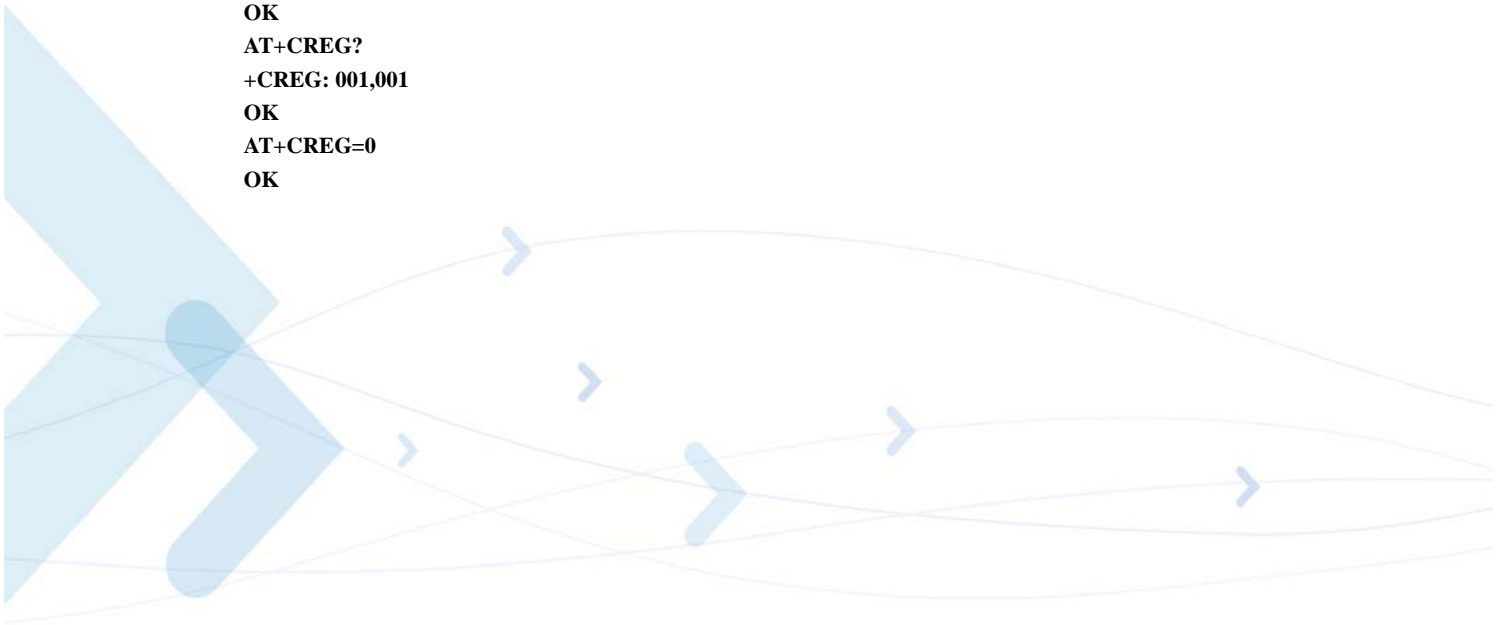

+CGREG, GPRS Network Registration

Command Type	Syntax	Response/Action	Remarks
Set	AT+CGREG=[<n>]	OK or: +CME ERROR: <err>	The Set command controls the presentation of an unsolicited result code "+CGREG:" and the result of the Read operation.
Read	AT+CGREG?	+CGREG: <n>,<stat>[,<lac>,<ci>] OK or: +CME ERROR: <err>	The Read command returns the status of the result code presentation and shows whether the network has currently indicated the GPRS registration of the G24-L. Location information elements <lac> and <ci> are returned only when <n>=2 and the G24-L is registered in the network.
Test	AT+CGREG=?	+CGREG: (list of supported <n>s) OK	The Test command displays the supported values of <n>.

The following table shows the +CGREG parameters.

Table 3-77: +CGREG Parameters

<Parameter>	Description
<n>	0 Disables the network registration unsolicited result code. 1 Enables the network registration unsolicited result code +CGREG: <stat>. 2 Enables the network registration and location information in unsolicited result code and Read command +CGREG:<stat>[,<lac>,<ci>]. The default is 0.
<stat>	0 Not registered, and the ME is not currently searching for a new operator to which to register. 1 Registered, home network. 2 Not registered, but the ME is currently searching for a new operator to which to register. 3 Registration denied. 4 Unknown. 5 Registered, roaming.
<lac>	Two-byte location area code in hexadecimal format.
<ci>	Two-byte cell ID in hexadecimal format.

Example

```
AT+CGREG=?
+CGREG: (000-002)
OK
AT+CGREG=2
OK
AT+CGREG?
+CGREG: 002,001,2648,988b
OK
AT+CGREG=1
OK
AT+CGREG?
+CGREG: 001,001
OK
AT+CGREG=0
OK
//Example for unsolicited reports:
AT+CGREG=1
OK
AT+CGATT=0
OK
+CGREG: 000
AT+CGATT=1
OK
+CGREG: 002
+CGREG: 001
//Remove GPRS enabled SIM
+CGREG: 000
//Insert GPRS enabled SIM
+CGREG: 002
+CGREG: 001
```

+COPS, Operator Selection

This command enables accessories to access the network registration information, and the selection and registration of the GSM network operator. The G24-L is registered in the Home network.

The Enhanced Operator Name String (EONS) feature enables the G24-L to return the operator name displayed on the handset. This feature allows the SIM card to store a mapping of MCC/MNC code pairs to the displayed operator name. As a result, several operators can share a single network while having their handsets display their own name as the network operator.

Testing the enhanced ONS feature requires a "SIM ONS" SIM card.

Command Type	Syntax	Response/Action	Remarks
Set	AT+COPS=[<mode>[,<format>[,<oper>]]]	OK or: +CME ERROR: <err>	The Set command can force an attempt to select and register a specific GSM network operator. The <mode> selects whether this is done automatically by the G24-L, or whether the selection is forced to an operator <oper> (given in format <format>). If the selected operator is not available, no other operator is selected (except when the <mode> is set to 4). <mode>=2 forces an attempt to deregister from the network. <mode>=3 sets the operator format to all further Read commands (+COPS?) as well. The selected mode applies to future network registrations, for example, once you deregister from the network, the G24-L remains unregistered until you select <mode>=0, <mode>=1, or <mode>=4
Read	AT+COPS?	+COPS: <mode>[,<format>,<oper>] OK or: +CME ERROR: <err>	The Read command returns the current mode and the currently selected operator.
Test	AT+COPS=?	+COPS: [list of supported (<stat>, long alpha numeric <oper>, short alphanumeric <oper>, numeric <oper>)] [list of supported <mode>s, (list of supported <format>s)] OK or: +CME ERROR: <err>	The Test command returns a list of quadruplets, each representing an operator present in the network. A quadruplet consists of an integer indicating the availability of the operator <stat>, long and short alphanumeric format of the name of the operator, and numeric format representation of the operator. If any of the formats are unavailable, there is an empty field. After the operator list, the G24-L returns lists of the supported <mode>s and <format>s. These lists are separated from the operator list by two commas.

The following table shows the +COPS parameters.

Table 3-78: +COPS Parameters

<Parameter>	Description
<format>	<p>The operator format type:</p> <ul style="list-style-type: none"> 0 Long alphanumeric 1 Short alphanumeric 2 Numeric <p>The default value is 0.</p>
<mode>	<p>Determines whether what is displayed is defined by <oper>, or is done automatically by the G24-L.</p> <ul style="list-style-type: none"> 0 Automatic (<oper> field is ignored) 1 Manual (<oper> field is present) 2 De-register from network 3 Set only <format> (<oper> field is ignored); used for Read command only, do not attempt registration/deregistration 4 Manual/automatic (<oper> field is present; if manual selection fails, use automatic mode) <p>The default value is 0.</p>
<stat>	<ul style="list-style-type: none"> 0 Unknown 1 Available 2 Current 3 Forbidden
<oper>	<p>Operator name displayed.</p> <p>The long alphanumeric format can be up to 16 characters long. The short alphanumeric format can be up to 8 characters long.</p> <p>The numeric format is the GSM Location Area Identification number (refer to GSM 04.08 [8] subclause 10.5.1.3), consisting of a three BCD digit country code (as per ITU-T E.212 Annex A [10]), plus a two BCD digit network code, which is administration specific.</p> <p>The returned <oper> is not in BCD format, but in IRA characters converted from BCD, and therefore the number has the following structure: (country code digit 3)(country code digit 2)(country code digit 1)(network code digit 2)(network code digit 1)</p>

+CPOL, Preferred Operators

This command is used to edit the list of preferred network operators located in the SIM card.

Command Type	Syntax	Response/Action	Remarks
Set	AT+CPOL=[<index>] [,<format>[, <oper>]]	OK or: +CME ERROR: <err>	The Set command writes an entry in the list of preferred operators. Note: The G24-L may also update this list automatically when new networks are selected.
Read	AT+CPOL?	+CPOL: <index1>,<format>,<oper1> [<CR><LF>+CPOL: <index2>,<format>,<oper2> [...]] OK or: +CME ERROR: <err>	The Read command displays all the preferred operators that have been entered into the list.
Test	AT+CPOL=?	+CPOL: (list of supported <index>s),(list of supported <format>s) OK or: +CME ERROR: <err> * Index range is SIM dependent	The Test command displays the entire index range supported by the SIM.

The following table shows the +CPOL parameters.

Table 3-79: +CPOL Parameters

<Parameter>	Description
<indexn>	Order number of network operator in the SIM preferred operator list
<format>	Defines the <oper> format: 0 Long alphanumeric format (up to 16 characters) 1 Short alphanumeric format (up to 8 characters) 2 Numeric (default)
<oper>	Name of the network operator

Note: To delete an entry from the list, enter an <index> without an <oper>.

If an <oper> is entered without an <index>, the <oper> is placed in the next free location in the list.

To change the format of <oper> displayed with the Read command, enter a <format>.

User is prevented to edit index No. 0. This is the HOME PLMN and is not stored in the SIM preferred list element file.

When entering a new item with an <index> to a full list, the G24-L deletes the last item, stores the new item in the requested entry, and shifts the rest of the list down.

When entering a new item without an <index> to a full list, the G24-L replaces the last entry with the new item.

+MFS, Motorola Frequency of Search

This command is used to determine how long the G24-L waits before attempting to reregister after a registration attempt has failed and the G24-L is not registered. The available settings are Slow Search, Medium Search, Fast Search or Continuous Search.

See [Table 3-80, “+MFS Parameters”](#), for the minimum interval lengths for every frequency of search. The interval between attempts can vary, depending on the number of operators displayed in the preferred operator list.

This command sets or reads Frequency of Search and Search mode settings. After a Set command has been executed, new Frequency of Search and Search mode values are active.

This command is a non-basic command, which means that the G24-L module rejects the command with an appropriate error message when the SIM is not present and/or the phone is in lock state.

Command Type	Syntax	Response/Action	Remarks
Set	+MFS=<freq> [,<mode>]	OK or: +CME ERROR: <err>	This command enables you to change and store in Flex the new values of Frequency of Search <freq> and Search mode <mode>. If only the <freq> value is given, then the Set command is interpreted as follows: <ul style="list-style-type: none"> Store new <freq> value. The <mode> value remains unchanged. If <freq> and <mode> values are given, then the Set command is interpreted as follows: <ul style="list-style-type: none"> Store new <freq> and <mode> values. Otherwise, an error message is sent to the DTE. Note: If the phone is not registered, then a set operation of Search mode to Manual is refused and ERROR is sent to the DTE.
Read	+MFS?	+MFS: <freq>,<mode> OK or: +CME ERROR: <err>	The Read command returns the current settings for values of <freq> and <mode>.
Test	+MFS=?	+MFS: (List of supported <freq>),(List of supported <mode>s) OK or: +CME ERROR: <err>	The Test command returns the possible <freq> and <mode> values.

The following table shows the +MFS parameters.

Table 3-80: +MFS Parameters

<Parameter>	Description
<freq>	This value defines the frequency of search. 0 Continuous. Minimum interval between subsequent search attempts is 1 second. 1 Medium. Minimum interval between subsequent search attempts is 10 seconds. 2 Slow. Minimum interval between subsequent search attempts is 30 seconds. 3 Fast. Minimum interval between subsequent search attempts is 5 seconds. The default value is 1, before it was changed for the first time.
<mode>	This value defines the search mode. The mode defines whether network selection and registration are performed automatically by the G24-L, or whether the selection is forced to the specific operator to which the G24-L is registered to at a given moment. 0 Automatic 1 Manual The default value is 0, before it was changed for the first time.

Example

```

AT+MFS=? //Test command
+MFS: (0-3),(0,1)
OK
AT+MFS? //Read command
+MFS: 1,0
OK
AT+MFS=3 //Set only Frequency of search
OK
AT+MFS?
+MFS: 3,0
OK
AT+MFS=2,1 //Set Frequency of search and search mode.
OK
AT+MFS?
+MFS: 2,1

//POWER CYCLE phone
AT+MFS?
+MFS: 2,1
OK
AT+MFS=0
OK
AT+MFS?
+MFS: 0,1
OK
  
```

Hardware Information

Hardware Information Commands

+CBC, Battery Charger Connection

This command enables a user to query the battery charger connection. The battery level is an average value, which is updated every 30 seconds

Command Type	Syntax	Response/Action
Read	+CBC	+CBC:<bc>,<bcl>

The following table shows the +CBC parameters.

Table 3-81: +CBC Parameters

<Parameter>	Description														
<bc>	Charger detection 0 Charger not detected 1 Charger detected Note: The G24-L input power source is connected via the battery pins.														
<bcl>	Battery charge level: <table border="1" data-bbox="678 1186 1063 1535"> <thead> <tr> <th>VCC, V</th> <th>Battery Level</th> </tr> </thead> <tbody> <tr> <td>>3.7</td> <td>90%</td> </tr> <tr> <td>3.5-3.7</td> <td>60%</td> </tr> <tr> <td>3.4-3.5</td> <td>20%</td> </tr> <tr> <td>3.35-3.4</td> <td>10%</td> </tr> <tr> <td>3.3-3.35</td> <td>5%</td> </tr> <tr> <td><3.3</td> <td>0%</td> </tr> </tbody> </table>	VCC, V	Battery Level	>3.7	90%	3.5-3.7	60%	3.4-3.5	20%	3.35-3.4	10%	3.3-3.35	5%	<3.3	0%
VCC, V	Battery Level														
>3.7	90%														
3.5-3.7	60%														
3.4-3.5	20%														
3.35-3.4	10%														
3.3-3.35	5%														
<3.3	0%														

Note: The G24-L does not allow the detection of battery use. The power supply of the G24-L is connected via the battery pins. However, users can use this command to verify the level of the G24-L input power source.

Example

```
AT+CBC
+CBC: 0,60 //This example shows 0 (battery powered) with 60% power.
```

OK

+MBC, Battery Charger

This command allows the battery charger to be managed (start, stop or automatic manage) and get indication for the battery level (solicited or unsolicited reports).

The Battery is external to the G24-L and connected via the 70 pin connector.

The values of the battery are: 3.2V-4.2V divided to 5 battery levels.

Notes:

- When the battery level is below the minimum, the G24-L will not power up until the pre-chargelevel reaches the minimum level for activation.
- The G24-L will manage the charging process and algorithm when charging is enabled.
- The unsolicited reports will appear in the following cases (in case <Ind=1>):
 1. Each time the level of the battery changes.
 2. Inside the limits (3.2 and 4.2).
 3. Charger connected/disconnected.
- The unsolicited report will appear even if the charger cable is not connected (only in case of <Ind=1>).
- **ERRORS:** Trying to start a charging process without a battery, error message of: NO BATTERY DETECTION will be received, for any other problems the following will be received: ERROR IN CHARGING PROCESS.

Command Type	Syntax	Response/Action	Remarks
Set	AT+MBC=<Mode>,<Ind >	OK or: +CME ERROR: <err>	The Set command sets the different mode (start, stop or automatic) and sets the report to be solicited or unsolicited.
Read	AT+MBC?	+MBC: <Status>,<Batterylevel >,<Mode>,<Ind> OK	The Read command returns the current status, battery level, mode and indication.
Test	AT+MBC=?	+MBC: (List of supported Mode),(List of supported Indication) OK	The Test command returns the list of supported modes and indications.

The following table shows the +MBC parameters.

Table 3-82: +MBC Parameters

<Parameter>	Description
<Mode>	0 Stop battery charging. 1 Start battery charging. 2 Automatic battery charging.
<Ind>	0 Disable MBC unsolicited report (default). 1 Enable MBC unsolicited report.
<BatteryLevel>	0-5 Battery Level values (see Table 3-83).
<Status>	The status of the battery charger: 0 The battery is in charging process. 1 The battery is not in charging process.

The following table shows the battery levels parameters (as defined in +CBC command).

Table 3-83: Battery Level Parameters

VCC, V	Battery Level
>3.7	5 (90%)
3.5-3.7	4 (60%)
3.4-3.5	3 (20%)
3.35-3.4	2 (10%)
3.3-3.35	1 (5%)
<3.3	0 (0%)

Example

```

AT+MBC? //Read the current values.
+MBC: 0,3,2,0
OK
AT+MBC=1,1 // Start charging with unsolicited report.
OK
AT+MBC? //Read the current values.
+MBC: 0,3,1,1
OK
+MBC: 0,3,1,1 //Unsolicited reports
+MBC: 0,4,1,1
+MBC: 0,5,1,1
AT+MBC=? //Test Mode.
+MBC: (0-2), (0-1)
OK

```

+CBAUD, Baud Rate Regulation

This command sets the baud rate. The baud rate of the G24-L is changed/set to the request value <rate> written in the command.

Specifying a value of 9 or 0 disables the function and allows operation only at rates automatically detectable by the G24-L. The specified rate takes effect following the issuing of any result code(s) associated with the current command line.

The UART is configured according to the request, or to the specific constant baud rate or auto baud rate after output "OK" response to the terminal. For example, AT+CBAUD=8 is equivalent to AT+CBAUD=57600. Using AT+CBAUD with the <rate> value other than 9 or 0 disables the auto baud rate detection feature.

Command Type	Syntax	Response/Action
Set	AT+CBAUD=<n> AT+CBAUD=<rate>	OK or: ERROR
Read	AT+CBAUD?	+CBAUD: <rate>
Test	AT+CBAUD=?	+CBAUD: (list of supported <n>s, list of supported <rate>s)

The following table shows the +CBAUD parameters.

Table 3-84: +CBAUD Parameters

<Parameter>	Description
<n> <rate>	0 Auto baud rate
	1 600
	2 1200
	3 2400
	4 4800
	5 9600
	6 19200
	7 38400
	8 57600
	9 Auto baud rate
	10 115200
	11 300
	12 230400
	13 460800
	The default value is 9.

Example

```
AT+CBAUD=57600
```

```
or
```

```
AT+CBAUD=8
```

```
//These commands have the same effect
```

```
OK
```

```

AT+CBAUD?
+CBAUD: 57600
OK
AT+CBAUD=?
+CBAUD: (0-13,300,600,1200,2400,4800,9600,19200,38400,57600,115200,230400,460800)
OK

```

+IPR, Local Terminal/G24-L Serial Port Rate

This command is responsible for setting and saving the request baud rate. This numeric extended-format parameter specifies the data rate at which the G24-L accepts commands. Specifying a value of 9 disables the function and allows operation only at rates automatically detectable by the G24-L. The specified rate takes effect following the issuing of any result code(s) associated with the current command line.

The <rate> value specified is the rate in bits per second at which the terminal-G24-L interface operates, for example, 19200 or 115200. The rates supported by the G24-L are manufacturer-specific. However, the +IPR parameter permits setting any rate supported by the G24-L during online operation.

The UART is configured to rates of 300, 600, 1200, 4800, 9600, 19200, 38400, 57600, 115200, 230400, 460800 bits per second according to the parameters of the +IPR command.

Using AT+IPR=<rate> with a <rate> value other than 9 and 0 disables the auto baud rate detection feature. The entered baud rate is stored in the G24-L and is restored after power up.

Notes: +IPR is similar to +CBAUD, but with the ability to save.

Command Type	Syntax	Response/Action
Set	AT+IPR=<n> AT+IPR=<rate>	OK or: ERROR
Read	AT+IPR?	+IPR: <rate>
Test	AT+IPR=?	+IPR: (list of supported <rate>s)

The following table shows the +IPR parameters.

Table 3-85: +IPR Parameters

<Parameter>	Description
<n> <rate>	0 Auto baud rate
	1 600
	2 1200
	3 2400
	4 4800
	5 9600
	6 19200
	7 38400
	8 57600
	9 Auto baud rate
	10 115200
	11 300
	12 230400
	13 460800

Example

```

AT+IPR=6
OK
AT+IPR?
+IPR: 19200
OK
AT+IPR=?
+IPR: (0-13,300,600,1200,2400,4800,9600,19200,38400,57600,115200,230400,460800)
OK
    
```

+MTDTR, DTR Line Test Command

This command checks and outputs the physical current status of the RS232 DTR pin.

Command Type	Syntax	Response/Action
Set	AT+MTDTR	+MTDTR:<n> OK
Read	AT+MTDTR?	+MTDTR:<n> OK
Test	AT+MTDTR =?	OK

The following table shows the +MTDTR parameters.

Table 3-86: +MTDTR Parameters

<Parameter>	Description
<n>	0 DTR OFF 1 DTR ON

Example

```
AT+MTDTR?
+MTDTR:1
OK
AT+MTDTR
+MTDTR:1
OK
AT+MTDTR=?
OK
```

+MTCTS, CTS Line Test Command

This command sets the CTS pin of the RS232 to active high, waits one second and then returns the CTS to active low.

Command Type	Syntax	Response/Action
Execute	AT+MTCTS	OK

Example

```
AT+MTCTS
OK
```

&K, RTS/CTS Flow Control

This command configures the flow control. The RTS (Request To Send) is an input line. The RTS signal is received from the terminal and a low condition indicates that the G24-L can send more data. The CTS (Clear To Send) is an output line. The CTS signal is sent to the terminal and a low state indicates that more data can be sent to the G24-L.

The RTS and CTS together make up what is called RTS/CTS or “hardware” flow control. Both lines are used when “hardware flow control” is enabled in both the terminal and the G24-L devices. When the terminal is ready and able to receive data, it puts the RTS line in an active (low) condition to indicate this to the G24-L. If the terminal is not able to receive data (typically because its receive buffer is almost full), it puts the RTS line in an inactive (high) condition as a signal to the G24-L to stop sending data. When the terminal is ready to receive more data (for example, after data has been removed from its receive buffer), it places this line back in the active

condition. The RTS line complements the CTS line. The G24-L puts the CTS line in an active condition to tell the terminal that it is ready to receive the data. Likewise, if the G24-L is unable to receive data, it places the CTS line in an inactive condition.

Command Type	Syntax	Response/Action
Set	AT&K<param>	OK
Read	AT&K?	&K: <param>
Test	AT&K=?	&K: (list of supported <param>s)

The following table shows the &K parameters.

Table 3-87: &K Parameters

<Parameter>	Description
<param>	0 Disable all terminal/G24-L flow control 3 Enable CTS/RTS terminal/G24-L flow control 4 Enable Xon/Xoff terminal/G24-L flow control 5 Enable Xon/Xoff terminal/G24-L flow control 6 Enable CTS/RTS terminal/G24-L flow control The default value is 3.

Example

```
AT&K?
&K: 3
OK
AT&K4
OK
```

&C, Circuit 109 Behavior

This parameter determines how the state of the DCD line relates to the detection of the received line signal from the distant end. Changing the parameters will take effect immediately in both the command and online command states.

The DCD line is an output line that indicates the following:

- In Circuit Switch Data mode an active (low) indicates that a valid carrier (data signal) was detected by the G24-L (CONNECT message is received), and inactive (high) indicates idle. The AT&C command always puts the DCD command ON, when set to 0. If the AT&C command is set to 1 then the "+++" escape command sets the DCD signal to an inactive state and the ATO command is set to active. The AT&C set to 2 sets the DCD signal OFF.
- In GPRS mode, the DCD line indicates the PDP context status. PDP context active sets the DCD to active (low); PDP context inactive sets the DCD to inactive (high). The DCD is activated only when the PDP context is achieved. The DCD is de-activated when the PDP context is off.

When AT&C is set to 0, the DCD signal is always ON. When AT&C is set to 1, the DCD is activated in online mode. When AT&C is set to 2, the DCD is activated only when the PDP context is achieved (temporary IP address is received).

Command Type	Syntax	Response/Action
Set	AT&C<param>	OK
Read	AT&C?	&C:<param>
Test	AT&C=?	&C:(list of supported <param>s)

The following table shows the &C parameters.

Table 3-88: &C Parameters

<Parameter>	Description
<param>	<p>DCD signal ON</p> <p>0 DCD is forced ON at all times.</p> <p>1 DCD is set to ON when:</p> <ul style="list-style-type: none"> a A CSD carrier is detected. b A GPRS external session is being established: <p>G24-L enters PPP mode TE is about to send an LCP configure-request to the G24-L (GPRS connection is not yet established).</p> <p>DCD is set to OFF when:</p> <ul style="list-style-type: none"> a No CSD carrier is detected. This can happen when a CSD call has been disconnected or when G24-L enters CSD online command mode (switch operation). b The G24-L has lost its GPRS connection with the network (PDP context was deactivated and the IP address is cancelled). <p>2 DCD is set to ON when G24-L establishes a GPRS connection with the network (PDP context is activated and the IP address is received from the network). DCD is set to OFF when G24-L has lost its GPRS connection with the network (PDP context was deactivated and the IP address is cancelled).</p> <p>The default value is 1.</p>

Note: If &C is set to 2 when a CSD call is set, DCD will always remain OFF.

Example

```
AT&C?
&C: 1
OK
AT&C0
OK
```

&D, Circuit 108 Behavior

This command determines how the G24-L responds when the DTR (Data Terminal Ready) status is changed from ON to OFF during the online data state. The DTR is an input line that indicates that the terminal is ready.

The DTR line must be active (low) in order for the G24-L to recognize the terminal. This signal is raised by the terminal when a process activates the serial port. If the DTR is not used by the application, it should connect this line to ground (DTR active). The default value is active (low).

Command Type	Syntax	Response/Action
Set	AT&D<param>	OK
Read	AT&D?	&D:<param>
Test	AT&D=?	&D:(list of supported <param>s)

The following table shows the &D parameters.

Table 3-89: &D Parameters

<Parameter>	Description
<param>	<p>The G24-L's reaction when the DTR status is changed from ON to OFF.</p> <p>In CSD calls:</p> <ul style="list-style-type: none"> 0,4 Ignores DTR changes 1 Switches the CSD call to asynchronous command mode (the call remains connected) 2,3 Disconnects the call and returns to the command mode <p>In GPRS calls:</p> <ul style="list-style-type: none"> 0,4 Ignores DTR changes 1-3 Deactivates the GPRS and returns to command mode <p>The default value is 2.</p>

Example

```
AT&D?
&D: 2
OK
AT&D1
OK
```

+MCWAKE, GPRS Coverage

This command tells the G24-L whether to report on the status of the GPRS/GSM coverage. There are three possibilities:

- Do not report the status of the GPRS/GSM coverage.
- Report only when the GPRS/GSM coverage goes off.
- Report only when the GPRS/GSM coverage goes on.

Command Type	Syntax	Response/Action
Set	AT+MCWAKE=<param>	OK
Read	AT+MCWAKE?	+MCWAKE: <param> OK
Test	AT+MCWAKE=?	+MCWAKE: (list of supported <param>s) OK

The following table shows the +MCWAKE parameters.

Table 3-90: +MCWAKE Parameters

<Parameter>	Description
<param>	0 Sends no indication. 1 Sends an indication when GPRS/GSM coverage goes off. 2 Sends an indication when GPRS/GSM coverage goes on. The default value is 2.

Example

```
AT+MCWAKE=0
OK
AT+MCWAKE?
+MCWAKE: 0
OK
AT+MCWAKE=1
OK
AT+MCWAKE=2
OK
AT+MCWAKE=?
+MCWAKE: (0,1,2)
OK
```

+MGGIND, GSM/GPRS Service Indicator

This command configures the service indicator line of pin 49 of the 70 pin connector to be GPRS or GSM registration indicator.

The IO line (pin 49) function according to the current registration state (in service or not) of the specific service indicator configuration.

Note: IO line (pin 49) outcome depends on +MCWAKE configuration.

Command Type	Syntax	Response/Action
Set	AT+MGGIND=<state>	OK or: +CME ERROR: <err>
Read	AT+ MGGIND ?	+MGGIND: <state> OK or: +CME ERROR: <err>
Test	AT+ MGGIND =?	+MGGIND: (list of supported <state>s) OK

The following table shows the +MGGIND parameters.

Table 3-91: +MGGIND Parameters

<Parameter>	Description
<state>	0 GPRS registration indicator. 1 GSM registration indicator.

Example

```
AT+MGGIND=0
OK
AT+MGGIND?
OK
+MGGIND: 0
AT+MGGIND=1
OK
AT+MGGIND?
+MGGIND: 1
OK
AT+MGGIND=?
+MGGIND: (0-1)
OK
```

+CFUN, Shut Down Phone Functionality

This command shuts down the phone functionality of smart phones and PDAs with phone capabilities in order to prevent interference from a nearby environment. This enables other functionality to continue to be used in environments where phone use is either impractical or not permitted. For example, on airplanes the use of Transceiver modules is forbidden during the entire flight, but the use of computers is allowed during much of the flight. This command enables other functionality to continue while preventing use of phone functionality.

Command Type	Syntax	Response/Action	Remarks
Set	AT+CFUN=[<fun> [<rst>]]	OK +CME ERROR: <err>	The Set command selects the level of functionality <fun> in the smart phone or PDA incorporating the G24-L.
Read	AT+CFUN?	+CFUN: <fun> OK	The Read command displays the current level of functionality.
Test	AT+CFUN=?	+CFUN: (list of supported <fun>s), (list of supported <rst>s) OK	The Test command displays the list of supported functionality settings.

The following table shows the AT+CFUN parameters.

Table 3-92: +CFUN Parameters

<Parameter>	Description
<fun>	Functionality levels: 0, 1 Full functionality (default 0) 4 Disables phone transmit & receive RF circuits 5-127 Reserved for future use
<rst>	0 Sets functionality to <fun> without resetting the device (default) 1 Resets the device before setting functionality to <fun>

Examples

```
AT+CFUN=?
```

```
+CFUN: (0-4), (0-1)
```

```
OK
```

```
AT+CFUN?
```

```
+CFUN: 0
```

```
OK
```

```
AT+CFUN=4
```

```
//Disable phone transmit and receive RF circuits
```

```
Ok
```

+ICF, DTE-DCE Character Framing

This command determines the local serial port start/stop (asynchronous) character framing used by the DCE when accepting DTE commands and transmitting information text and result codes, whenever these are not done automatically. Auto detect framing is not supported.

Command Type	Syntax	Response/Action	Remarks
Set	+ICF=[<format>[,<parity>]]	OK +CME ERROR: <err>	The Set command determines the local serial port start/stop character framing.
Read	+ICF?	+ICF: <format>,<parity> +CME ERROR: <err>	The Read command displays the currently selected character framing.
Test	+ICF=?	:+ICF:(list of supported <format> values),(list of supported <parity> values) +CME ERROR: <err>	The Test command displays a list of supported <format> and <parity> values.

The following table shows the +ICF parameters.

Table 3-93: +ICF Parameters

<Parameter>	Description
<format>	Determines the number of bits in the data bits, the presence (or absence) of a parity bit, and the number of stop bits in the start/stop frame. 1 8 Data, 2 Stop - can be set only with <parity> 4 2 8 Data, 1 Parity, 1 Stop - can be set with <parity> of 0 or 1 3 8 Data, 1 Stop (default) - can be set only with <parity> 4 4 7 Data, 2 Stop - can be set only with <parity> 4 5 7 Data, 1 Parity, 1 Stop - can be set with <parity> of 0 or 1 6 7 Data, 1 Stop - can be set only with <parity> 4 7 8 Data, 1 Parity, 2 Stop - can be set with <parity> of 0 or 1 8 7 Data, 1 Parity, 2 Stop - can be set with <parity> of 0 or 1
<parity>	Determines how the parity bit is generated and checked (if present). 0 Odd 1 Even 4 No parity (default)

Example

```
AT+ICF?
+ICF: 3,4
OK
AT+ICF=?
+ICF: (1-8),(0,1,4)
OK
AT+ICF=5,1
OK
```

ATS97, Antenna Diagnostic

This command indicates whether an antenna is physically connected to the G24-L RF connector. This information is also provided by a dedicated hardware signal, which is outputted on pin 41 (ANT_DET) of the interface connector.

Command Type	Syntax	Response/Action	Remarks
Execute	ATS97	OK or: +CME ERROR: <err>	
Read	ATS97?	<info> OK or: +CME ERROR: <err>	The Read command indicates whether the antenna is connected.

The following table shows the ATS97 parameters.

Table 3-94: ATS97 Parameters

<Parameter>	Description
<info>	000 The antenna is not connected 001 The antenna is connected

Example

```
// Connect the antenna
ATS97?
001
ATS97
OK
ATS97=?
ERROR
// Disconnect the antenna
ATS97?
000
```

+MRST, Perform Hard Reset

The +MRST command enables customer software to perform a hard reset to the G24-L unit.

Command Type	Syntax	Response/Action	Remarks
Set	+MRST	OK	The Set command performs a graceful hard reset to the G24-L module. Note: The Read and Test commands are not permitted for the +MRST command.

Example

```
AT+MRST
OK
// Result - G24-L module performs a power down
```

+MIOC, Motorola I/O Configure

This command defines the G24-L 8 GPIO pins data value. The feature is flex enabled or disabled. This command is a basic command.

The feature is active by default, however, changing the FLEX can eliminate it.

Note: Support of the GPIO pins comes instead of supporting the keypad of the Evaluation board.

Command Type	Syntax	Response/Action	Remarks
Set	AT+MIOC=<Pin selection>,<Data vector>	OK or: +CME ERROR: <err>	The set command defines the logic value of selected pins to high or low when pin is configured as output. The G24-L saves the new setting in flex. Only selected pins are affected. Set action is allowed only for pins configured as output. In case <Data vector> includes values of input pins, those values will be ignored. In case <pin selection> includes input pins, an error will be issued "Operation not allowed". No action will take place.
Read	+ MIOC?	+MIOC: <Data vector> OK	The read command returns the actual logical value of the 8 GPIO pins.
Test	+ MIOC=?	+MIOC: (list of supported <Pin selection>s),(list of supported <Data vector>s) OK or: +CME ERROR: <err>	The test command returns the possible ranges of <Pin selection>s and <Data vector>s.

The following table shows the +MIOC parameters.

Table 3-95: +MIOC Parameters

<Parameter>	Description
<pin selection>	Selected pins for the action invoked. This is a binary vector in which each bit points to pin number. Vector size is 8. 0 Not selected 1 Selected pin (default)
<data vector>	This is a binary vector in which each bit show the physical value of pin. Data vector size is 8. 0 Physical low signal. 1 Physical high signal (default). The default value: On Power Up - as previously saved in FLEX bytes. Before set command first used with <Data vector> and <Mode>=0, or after +MIOC without <Data vector> and before +MIOC command used - 1.

Example

```
AT+MIOC=?
+MIOC: (00000000-11111111),(00000000-11111111)
OK
```

Light control example:

Client has an electronic controlled light switch. The intent is to connect this switch to the G24-L (IO pin 5 - for example) and control the light by setting the logical values of pin 5.

Example of code is as follows:

```
AT+MIOD=00010000,0 // Set IO pin #5 to be output.
OK
AT+MIOD? // (Optional) Read the IO pin definitions to confirm correct settings.
+MIOD: 11101111 // Pins 1-4 and 6-8 are input pins. Pin 5 is output.
OK // At this point the module is configured to control the logic values of
pin 5.
AT+MIOC=00010000, 00010000 // Turn on the light by setting pin 5 to high.
AT+MIOC? // (Optional) read the pins status.
+MIOC: 00010000 // Pin 5 is set to high.
OK
AT+MIOD=00010000,0, 00010000 // All previous defined in one command.
OK
AT+MIOC=00010000,00000000 // Turn off the light by setting pin 5 to low.
OK
AT+MIOC? // (Optional) read the pins status.
+MIOC: 00000000 // Pin 5 is set to low.
OK
```

Data sending (vector example):

Client has a data bus with 8 bits and plans to implement some protocol over it. In this example 4 pins (pins 1-4) are used as an output and 4 pins (5-8) are used as input.

Example of code is as follows:

```
AT+MIOD=000001111,0      // Set IO pins 1-4 to be output level mode.
OK
AT+MIOD=11110000,1      // Set IO pins 5-8 to be input level mode.
OK                        // Unnecessary, because by default all pins are input.
AT+MIOD?                 // (Optional) Read the IO pin definitions to confirm correct settings.
+MIOD: 11110000         // Pins 1-4 output pins 5-8 input.
OK                        // At this point the module is configured to control the logic values of
                          // all pins.

AT+MIOC=00001111,00000011 // Write vector, 0x3 on pins 1-4.
OK                        // (pins 1,2 high, pins 3,4 low).
AT+MIOC?                 // Read the pins status.
+MIOC: 01000011         // Pins 1,2,7 show the logical value high.
OK
AT+MIOC=00001111,00000000 // Write vector 0x0 on pins 1-4.
OK
AT+MIOC?                 // (Optional) read the pins status.
+MIOC: 01110000         // Pin 1-4 low, pins 5,6,7 show logical high.
OK
```

+MIOD, Motorola I/O Define

This command defines the G24-L 8 GPIO pins configuration. The feature is flex enabled or disabled.

This command is a basic command.

The feature is active by default, however, changing the FLEX can eliminate it.

Note: When using the GPIO lines feature, lines should not be connected directly to ground, a resistor must be used. This is applicable when changing an I/O from input to output.

Command Type	Syntax	Response/Action	Remarks
Set	AT+MIOD=<Pin selection>,<Mode> [,<Data vector>]	OK or: +CME ERROR: <err>	The set command defines the behavior mode of each selected IO pin. The G24-L saves the new setting in flex. The selected pins are affected. Validity check of all parameters will be done and appropriate standard error will be issued. In case of legal parameters the new configuration is set. If <Data vector> doesn't supply and new <Mode> is output a line will care physical high signal. In case <Data vector> is supply and includes values of input pins, those values will be ignored. In case <Mode> is input and <Data vector> is supply, an error will be issued "Operation not allowed". No action will be done.
Read	+ MIOD?	+MIOD: <Mode vector> OK	The read command returns the current behavior mode of the 8 GPIO pins.
Test	+ MIOD=?	+MIOD: (list of supported <Pin selection>s),(list of supported <Mode>s),(list of supported <Data vector>s) OK or: +CME ERROR: <err>	The test command returns the possible ranges of <Pin selection>s, <Mode>s and <Data vector>s.

The following table shows the +MIOD parameters.

Table 3-96: +MIOD Parameters

<Parameter>	Description
<pin selection>	Selected pins for the action invoked. This is a binary vector in which each bit points to pin number. Vector size is 8. 0 Not selected 1 Selected pin (default)
<mode>	GPIO pin operation mode. 0 Output (level only) 1 Input (level mode)
<mode vector>	This is a binary vector in which each bit shows the operation mode of pin. Data vector size is 8. 0 Output (level only) 1 Input (level mode) The default value: On Power Up - as previously saved in FLEX bytes. Before set command first used - 1. (This means that all lines are configured as Input before set command first used).
<data vector>	This is a binary vector in which each bit shows the physical value of pin. Data vector size is 8. 0 Physical low signal. 1 Physical high signal (default). The default value: On Power Up - as previously saved in FLEX bytes. Before set command first used with <Data vector> and <Mode>=0, or after +MIOD without <Data vector> and before +MIOD command used - 1.

The following table shows the keypad GPIOs.

Table 3-97: Keypad GPIOs

GPIO Name	70 PIN connector, PIN#	GPIO Number
GPIO1	28	1
GPIO2	30	2
GPIO3	32	3
GPIO4	34	4
GPIO5	36	5
GPIO6	38	6
GPIO7	40	7
GPIO8	42	8

Example

```

+MIOD: (00000000-11111111),(0,1),( 00000000-11111111)
AT+MIOD=00010000,0           // Set IO pin #5 to be output.
OK
AT+MIOD?
+MIOD: 11101111             // Pins 1-4 and 6-8 are input. Pin 5 is output.
OK
AT+MIOD=00001111,0         // Set IO pins 1-4 to be output level mode.
OK
AT+MIOD=11110000,1        // Set IO pins 5-8 to be input level mode.(Default settings).
OK
AT+MIOD?
+MIOD: 11110000           // Pins 1-4 output pins, 5-8 input pins.
OK

```

+MMAD, Query and Monitor ADC Value

This command intends to query and monitor ADC value.

This command returns the current ADC values for the requested channel. The values received from the first 3 converters represent the DC voltage levels of the input to pins 37, 43 and 47 on the 70 pin connector.

The 5th converter functions as an input voltage monitor of the G24-L.

The returned value is a multiplication of the input level by 100 (e.g. input level of 1.56V will return 156).

This command can also calculate the average of the samples in a given duration and to forward it, unsolicited, according to report interval timer, or solicited.

Command Type	Syntax	Response/Action	Remarks
Set	AT+MMAD= <Converter_number>[,<Report>],[<Rate>],[<Low>],[<High>] [,<Num_Of_Samples>, [<Average_Calc_Duration>], [<Report_Interval>]] AT+MMAD= <Converter_number>	+MMAD: <Converter_number>, <Average> OK Or : +CME ERROR: <err> +MMAD: <Converter_number>, <Converted_Value> OK Or: +MMAD: <Converter_number>, <Average> OK	If average is active on that converter, the response value shall be the latest average calculated. If average is not active on that converter, the response value shall be the converted value. If average is active on that converter, and report interval not seted, the response value shall be the latest average calculated (solicited message).

Command Type	Syntax	Response/Action	Remarks
Read	AT+MMAD?	<p>List of converters and their monitoring setup values.</p> <p>+MMAD: <Converter number>, <Report>,<Rate>,<Low>,<High>< Num_of_samples> <Average_calc_duration><Report_ interval><CR><LF> <Converter number>, <Report>,<Rate>,<Low>,<High>> <Num_of_samples> <Average_calc_duration><Report_ interval> <CR><LF> <Converter number>, <Report>,<Rate>,<Low>,<High>> <Num_of_samples> <Average_calc_duration><Report_ interval> <CR><LF> <Converter number>, <Report>,<Rate>,<Low>,<High>> <Num_of_samples> <Average_calc_duration><Report_ interval> ><CR><LF> <Converter number>, <Report>,<Rate>,<Low>,<High>> <Num_of_samples> <Average_calc_duration><Report_ interval> OK</p>	<p>Reads the setting of the A/D converters.</p>
Test	AT+MMAD=?	<p>+MMAD:(range of <Converter_Number>'s) ,(range of<Report>) (range of <Rate>),(range of <Low>), (range of<High>), (range of<Num_of_samples>) ,(range of<Average_calc_duration>),(range of<Report_interval>) OK</p>	<p>Provides the range of the parameters.</p>

Command Type	Syntax	Response/Action	Remarks
Unsolicited Messages	AT+MMAD=<Converter_number> Case: *. Average calculation isn't active : *. Average calculation is active:	+MMAD: <Converter_number>, <Converted_Value> OK +MMAD: <Converter_number>, <Average> OK	If <Report> value is - 3, the report will be generated according to report interval value. If <Report interval> value was not set, there will be no messages, but you can ask for a solicited message.

The following table shows the +MMAD parameters.

Table 3-98: +MMAD Parameters

<Parameter>	Description	Range/Remark
<Converter Number>	1-5 Select the A2D converter.	
<Report>	0 Unsolicited report is not active/ stop unsolicited report & deactivate +MMAD operation. 1 Unsolicited report in active for all A2D conversion events. 2 Unsolicited reports are active only for out off boundaries events. 3 "Average report" - send periodic average.	Optional for Average calculation.
<Rate>	1-255 Select the time interval between two samples. Units: 100 milli Sec - in case of average computation. Seconds - in case of A/D sampling only.	100mili - for average; sec-Otherwise. Mandatory for Average calculation.
<low>,<High>	0,230 or 300,450 A decimal value represents the digital value. Low - The lowest boundary level of digital value. High - The Highest boundary level of digital value. Default value for converters 1-3 is 0,230. Default value for converter 5 is 300,450.	
<Converted Value>	A decimal value represents the returned digital value. For converters 1-3 and 5, the returned value represent the input level multiplied by 100.	
<Num_of_samples>	2 - 255 The number of samples that are used for average calculation.	Mandatory for Average calculation.
<Average_calc_duration>	1 - 255 For how long the average calculation will be active. 0 - Not active. 255 - Endless. 1...254 - minutes.	1- Default value if average is active. While not active = 0.

Table 3-98: +MMAD Parameters (Cont.)

<Parameter>	Description	Range/Remark
<Report_interval>	0 - 255 Time interval between two averages reports (seconds).	0 - Default value.
<Average>	Average calculation result.	

Example

```

AT+MMAD=1 // Read A2D1 values with analog input of 1.75V.
+MMAD:1,175

OK

AT+MMAD=2,1,15 // Read A2D2 converted value every 15 seconds and send

OK // unsolicited report to the DTE.

+MMAD: 2, 10 // Unsolicited Report after 15 seconds.
+MMAD: 2, 12 // Unsolicited Report after 30 seconds.
AT+MMAD= 3, 2,1,25,100 // Read A2D3 converted value every 1 second and send

OK // unsolicited report if the converted value is out of boundaries.

+MMAD: 3,102 // Unsolicited report of value out of boundaries.
:
minutes, rate=5. // Activate Average calculation periodically every 30 sec, during 5
// report originated by G24
// Converter num=1, report=3, rate=5*100ms, low,high, N_samples,
duration=5

AT+MMAD =1,3,5, , ,16,5,30

OK

+MMAD:1,175 //First report
+MMAD:1,140 //Second report
.....
+MMAD:1,160 //Last Avr report
AT+MMAD =1,0,5, , ,16,5,0 // Activate Average calculation during 5 minutes, rate=5.
// Converter num=1, report=0, rate=5*100ms, low,high, 16,
duration=5 min

OK

AT+MMAD=1 //Only on explicit "AT+MMAD=<Converter_number>" command

OK
    
```



```
+MMAD:1,160
//Operation not allowed because the parameters are valid but the
there is not enough time for calculation:
```

```
AT+MMAD =1,3,100, , ,7,1,5 // Activate Average calculation during 1 minute, rate=100,
// samples = 7, report interval = 5 sec.
//converter num=1, report=3, rate=100, low,high, 7,
// duration=1 min, interval = 5.
```

```
+CME ERROR: operation not allowed
```

```
AT+MMAD =1,0 // Stop Average calculation and report.
```

```
OK // converter num=1, report=0
```

```
AT+MMAD? // Read monitoring setup values of all A2D's
```

```
+MMAD:1,0,10,0,230,0,0,0
+MMAD:2,1,15,0,230,0,0,0
+MMAD:3,2,1,25,100,0,0,0
+MMAD:5,0,1,300,450,0,0,0
```

```
OK
```

```
AT+MMAD? // Read default values of all A2D's
```

```
+MMAD: 1,0,1,0,230,0,0,0
+MMAD: 2,0,1,0,230,0,0,0
+MMAD: 3,0,1,0,230,0,0,0
+MMAD: 5,0,1,300,450,0,0,0
```

```
OK
```

```
AT+MMAD=? //Test command - range of all setup parameters and
```

```
+MMAD: (1-3,5),(0-3),(1-255),(0-450),(0-450),(2-255),(1-255),(0-255)
```

```
OK
```

+MPCMC, Continuous PCM Clock

This command defines whether the PCM clock is generated continuously or not, when module is in digital audio mode (configured by AT+MADIGITAL command).

Note: User is advised not to enable sleep mode feature if he wants to use continuous PCM clock feature. Otherwise PCM clock will not work correctly while module is in deep sleep mode.

Command Type	Syntax	Response/Action	Remarks
Set	+MPCMC=<flag>	OK or: +CME ERROR: <err>	The Set command is used for setting the PCM clock configuration.
Read	+MPCMC?	+MPCMC: <flag> OK or: +CME ERROR: <err>	The Read command returns the current PCM clock <flag> value.
Test	+MPCMC=?	+MPCMC: (list of supported <flag>s) OK	The Test command returns the possible <flag> values.

The following table shows the +MPCMC parameters.

Table 3-99: +MPCMC Parameters

<Parameter>	Description
<flag>	0 Non-continuous PCM clock. 1 Continuous PCM clock. Before the AT+MPCMC command is set for the first time, this value is 0. Power-up is according to the flex.

Example

```
AT+MPCMC=?
+MPCMC:(0-1)
OK
AT+MPCMC=1
OK
AT+MPCMC?
+MPCMC: 1
OK
AT+MPCMC=0
OK
AT+MPCMC?
+MPCMC: 0
OK
```

Audio

Scope

The audio control can be summarized to the following three issues:

- Path: Selection of microphone and speaker to be used.
- Gain: Control of volume levels for rings, voice, etc.
- Algorithm: Activation of audio algorithms (echo cancellation, noise suppression and sidetone).

The G24-L incorporates two audio modes: 'Basic Audio' and 'Advanced Audio'. Each mode has a different behavior and a set of relevant AT commands. [Figure 3-3](#) describes the two audio modes, switching between them and the AT commands related to each mode.

Audio Control of Path, Gain and Algorithms is available by these two different modes' sets of commands. It is advised to select the audio mode according to the application needs, either the 'Basic Audio' set or the 'Advanced Audio' set.

Basic Audio

This mode of commands suits most users. It provides a simple audio control. In this mode the G24-L will also adjust the paths automatically upon headset interrupt. The G24-L powers up in 'Basic Audio' mode.

Basic audio specific commands are: +CRSL, +CLVL, +CMUT, S94, S96.

Advanced Audio

This mode suits users who require a full control of the audio. When using these advanced commands, the audio control will ignore the headset interrupt (when the headset will be connected the paths will not change automatically). Upon invoking, any of the advanced Audio specific commands: +MAVOL, +MAPATH, +MAFEAT, +MAMUT, the G24-L enters 'Advanced Audio' mode. G24-L remains in 'Advanced audio' mode until the next power up.

While in Advanced Mode, all Basic Audio AT commands (+CRSL, +CLVL, +CMUT, S94, S96) are blocked and will return an error.

General Audio Commands

The following audio commands can be used in both Basic and Advanced audio modes:

+CRTT, +VTD, +VTS, +CALM, +MMICG, +MADIGITAL

Table 3-100 shows the differences between Basic and Advanced audio modes in controlling the audio.

Table 3-100: Basic and Advanced Audio Modes Comparison

	Basic Audio	Advanced Audio
Path	Paths are set automatically (upon interrupt).	Paths are set manually. All routings are available; any microphone with any speaker for each type of sound (voice, keypad, ring, etc.).
Gain	There are two types of gains: phone (voice, keypad) and ring.	There is a matrix of gains: a different gain is saved for each type of sound through a specific speaker. For example, one volume level for rings through the speaker and a different volume level for rings through the transducer. Therefore, there will be 16 different volume levels, which is the product of the number of output accessories (speaker, headset speaker, transducer and digital output) and the number of audio tones (voice, keypad, ring and alert).
Algorithm	Algorithms are set by ATS94 and ATS96.	Algorithms are set by AT+MAFEAT.

Audio Setup

The G24-L has two audio modes: 'Basic Audio' and 'Advanced Audio'. Each mode has a different behavior and a set of relevant AT commands.

Figure 3-2 describes the two audio modes, switching between them and the AT commands related to each mode.

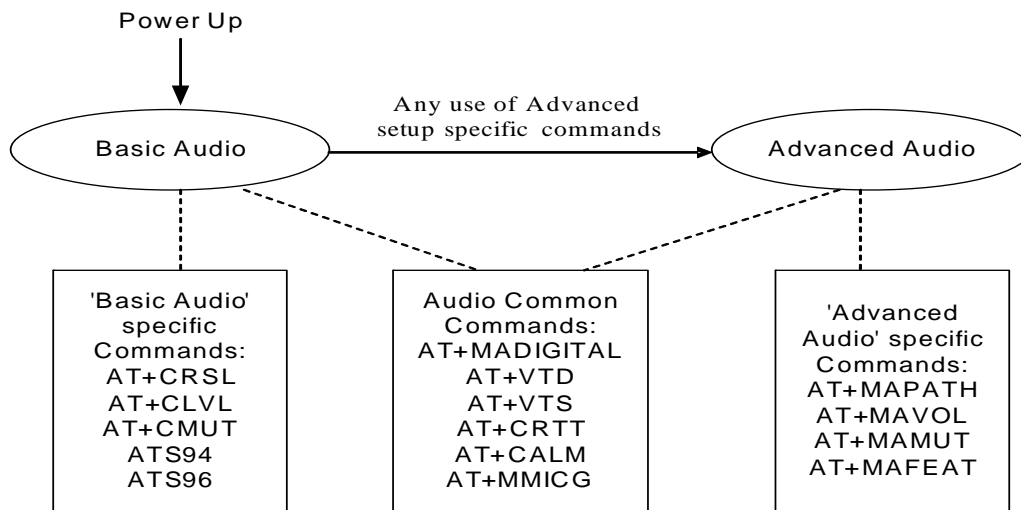

Figure 3-2: Audio Modes

Audio Control of Path, Gain and Algorithms is available by these two different modes' sets of commands. It is advised to select the audio mode according to the application needs, either the 'Basic Audio' set or the 'Advanced Audio'.

Basic Audio Setup

This mode's set of commands suits most users. It provides a simple audio control. In this mode the G24-L will also adjust the paths automatically upon headset interrupt. The G24-L powers up in 'Basic Audio' mode.

Basic audio specific commands are: +CRSL, +CLVL, +CMUT, S94, S96.

Figure 3-3 shows the basic audio setup.

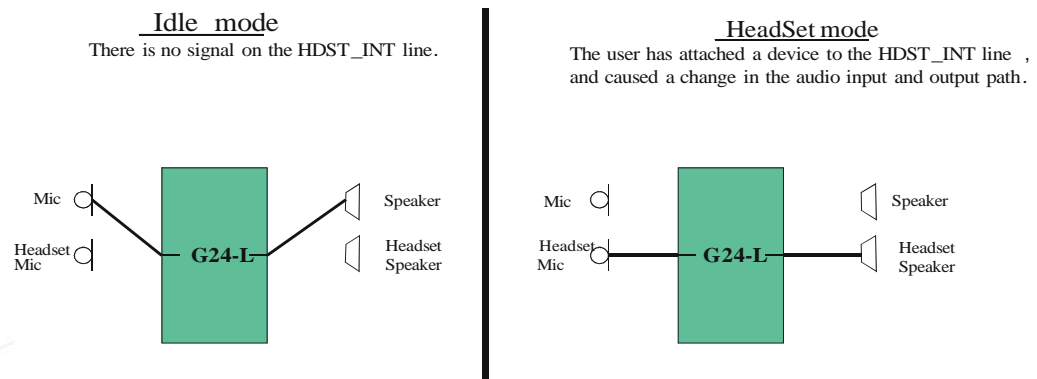

Figure 3-3: Basic Audio Setup

Advanced Audio Setup

This mode suits users which require a full control of the audio. When using these advanced commands the audio control will ignore the headset interrupt (when the headset will be connected the paths will not change automatically). Upon invoking any of the advanced Audio specific commands: +MAVOL, +MAPATH, +MAFEAT, +MAMUT the G24-L will enter 'Advanced Audio' mode. G24-L will remain in 'Advanced audio' mode until power cycle.

While in Advanced Mode, all Basic Audio AT commands (+CRSL, +CLVL, +CMUT, S94, S96) are blocked and will return an error.

Figure 3-4 shows the advanced setup.

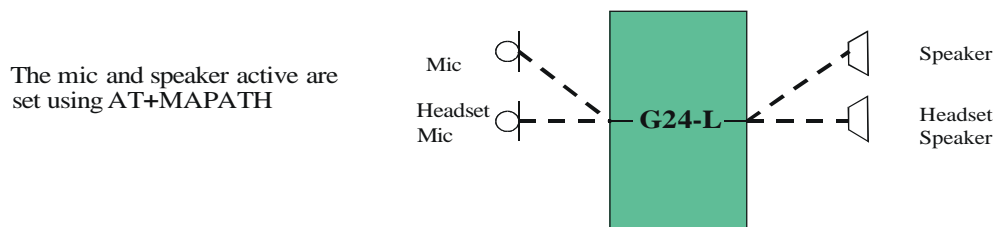

Figure 3-4: Advanced Audio Setup

G24-L supports both analog and digital audio. Digital audio is supported in both basic and advanced audio setups. Switching between analog and digital audio modes is done by AT+MADIGITAL command.

The default state is analog.

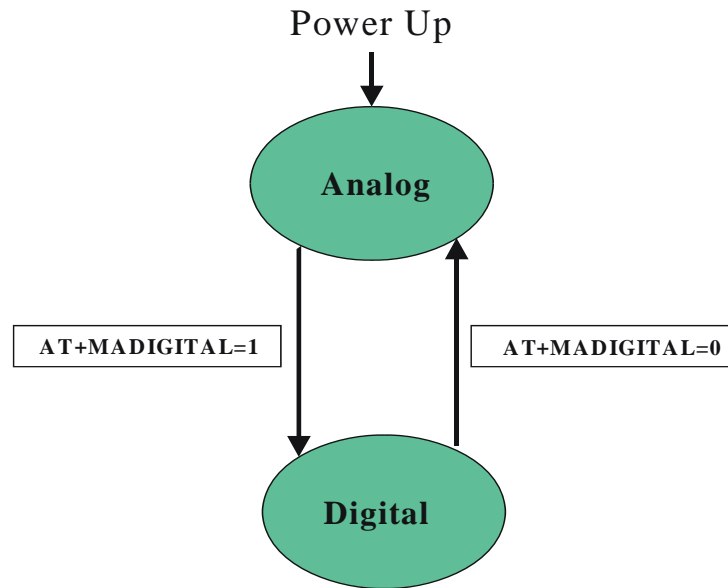

Figure 3-5: Analog/Digital Switching

General Audio Commands

The following audio commands can be used in both Basic and Advanced audio modes.

General audio commands are: +CRTT, +VTD, +VTS, +CALM, +MMICG, +MADIGITAL.

Basic Audio Setup Commands

+CRSL, Call Ringer Level

This command handles the selection of the incoming call ringer and alert tone (SMS) sound level on the alert speaker of the G24-L. The new value remains after power cycle.

Command Type	Syntax	Response/Action	Remarks
Set	+CRSL=<level>	OK +CME ERROR: <err>	The Set command sets the call ringer level.
Read	+CRSL?	+CRSL: <level> +CME ERROR: <err>	The Read command displays the current ringer alert (SMS) sound level setting.???????
Test	+CRSL=?	+CRSL: (list of supported <level>s) +CME ERROR: <err>	The Test command displays the list of supported sound level settings.

The following table shows the +CRSL parameters.

Table 3-101: +CRSL Parameters

<Parameter>	Description
<level>	0 Mute 1-7 Ringer sound level (1 is lowest; 7 is default after flex)

Example

```
AT+CRSL?
+CRSL: 7
OK
AT+CRSL=?
+CRSL: (0-7)
OK
AT+CRSL=5
OK
```

+CLVL, Loudspeaker Volume

This command sets the volume of the internal loudspeaker (which also affects the key feedback tone) of the G24-L.

This command is applicable for Analog and Digital modes.

Note: The +CLVL command does not control the alert speaker.

In this command, the new value remains after power cycle.

The +CLVL command can be used even when the SIM is not inserted.

Command Type	Syntax	Response/Action	Remarks
Set	+CLVL=<level>	OK +CME ERROR: <err>	The Set command sets the internal loudspeaker volume level.
Read	+CLVL?	+CLVL: <level> +CME ERROR: <err>	The Read command displays the current internal loudspeaker volume setting.
Test	+CLVL=?	+CLVL: (list of supported <level>s) +CME ERROR: <err>	The Test command displays the possible loudspeaker volume settings.

The following table shows the +CLVL parameters.

Table 3-102: +CLVL Parameters

<Parameter>	Description
<level>	0-7 Manufacturer-specific volume range. 0 is lowest volume (not mute). The default value is 7 after flex.

Example

```
AT+CLVL?
+CLVL: 7
OK
AT+CLVL=?
+CLVL: (0-7)
OK
AT+CLVL=3
OK
```

+CMUT, Mute/Unmute Currently Active Microphone Path

This command is used to mute/unmute the currently active microphone path by overriding the current mute state.

Command Type	Syntax	Response/Action	Remarks
Set	+CMUT=<state>	OK or: +CME ERROR: <err>	The Set command enables/disables uplink voice muting during a voice call.
Read	+CMUT?	+CMUT: <state> OK	The Read command returns the current uplink voice mute/unmute state.
Test	+CMUT=?	+CMUT: (list of supported <state>s) OK	The Test command returns the possible <state> values.

The following table shows the +CMUT parameters.

Table 3-103: +CMUT Parameters

<Parameter>	Description
<n>	0 Unmute microphone path 1 Mute microphone path

Example

```

AT+CMUT=?
+CMUT:(0-1)
OK
AT+CMUT?
+CMUT: 0                uplink voice is unmuted
OK
AT+CMUT=1                uplink voice is muted
OK
AT+CMUT?
+CMUT: 1
OK
AT+CMUT =2
+CME ERROR: <err>

```

S94, Sidetone Effect

This command reduces the microphone audio input that is routed to the selected speaker, so that people speaking will hear themselves talking (The default value of S94 is "1").

The following table explains the use of the ATS94 set.

Table 3-104: ATS94 and ATS96 Behavior

ATS94	ATS96	Echo Cancel	Noise Suppress	ST
0	0	Disabled	Disabled	Disabled
1	0	Disabled	Disabled	Enabled
0	1	Enabled	Enabled	Disabled
1	1	Enabled	Enabled	Disabled

Command Type	Syntax	Response/Action	Remarks
Set	ATS94=<n>	OK or: +CME ERROR: <err>	The Set command sets the sidetone status.
Read	ATS94?	<000-disabled, 001-enabled> OK or: +CME ERROR: <err>	The Read command returns the sidetone status.
Test	ATS94=?	+CME ERROR: <err>	The Test command displays the supported values of <n>.

The following table shows the S94 parameters.

Table 3-105: S94 Parameters

<Parameter>	Description
<n>	0 Disable sidetone 1 Enable sidetone On power up the sidetone is enabled.

Example

```

ATS94=0                    //Disable sidetone
OK
ATS94=2
+CME ERROR: <err>
ATS94?
000                        //Sidetone disabled
OK

```

S96, Echo Canceling

This command suppresses a large amount of the output sound picked up by the input device (cancels all echo). S96 value is saved in the Flex.

The following table explains the use of the ATS96 set.

Table 3-106: ATS96 and ATS94 Behavior

ATS96	ATS94	Echo Cancel	Noise Suppress	ST
0	0	Disabled	Disabled	Disabled
0	1	Disabled	Disabled	Enabled
1	0	Enabled	Enabled	Disabled
1	1	Enabled	Enabled	Disabled

Command Type	Syntax	Response/Action	Remarks
Set	ATS96=<n>	OK or: +CME ERROR: <err>	The Set command sets the echo canceling and noise suppression status.
Read	ATS96?	<000-disabled, 001-enabled> OK or: +CME ERROR: <err>	The Read command returns the echo canceling and noise suppression status.
Test	ATS96=?	+CME ERROR: <err>	

The following table shows the S96 parameters.

Table 3-107: S96 Parameters

<Parameter>	Description
<n>	0 Disable echo canceling. Disable noise suppression 1 Enable echo canceling. Enable noise suppression

Example

```

ATS96=1                //Enable echo canceling
OK
ATS96=4
+CME ERROR: <err>
ATS96?
001                    //Echo canceling enabled
OK
  
```

Advanced Audio Setup Commands

This group of commands enables accessory devices to control certain audio aspects within the system.

+MAPATH, Audio Path

This command sets/requests the active input accessory, and the output accessory for each feature. For example, you can choose the headset mic to be active, the voice and keypad feedbacks to go to the speaker, and the alerts and rings to go to the alert speaker. On power up, the default path, mic, speaker and alert speaker are restored.

Note: +MAPATH cannot be used to set digital audio, but only to read it. In order to set the digital audio path, use +MADIGITAL. For more information, refer to section “+MADIGITAL, Analog/Digital Audio Switching” on page 3-170.

The following diagram shows the audio paths:.

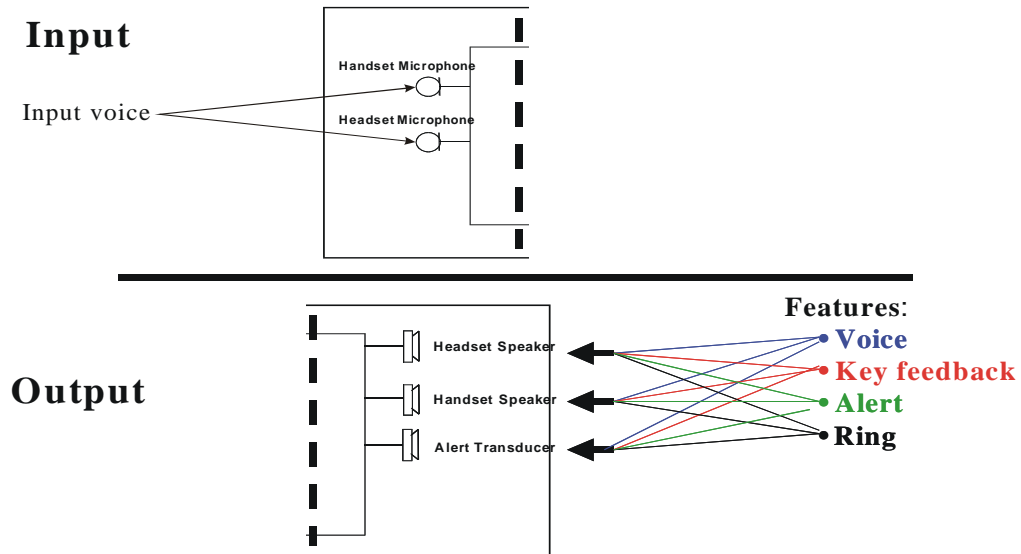

Figure 3-6: Audio Paths

Command Type	Syntax	Response/Action	Remarks
Set	+MAPATH= <direct>,<accy> [,<features>]	OK or: +CME ERROR: <err>	The Set command sets the audio path mode. The mode indicates which I/O accessories are now active for the different audio features. The <features> field is only used for outputs (direct=2).
Read	+MAPATH?	+MAPATH:1(mode in),<accy> +MAPATH:2(mode out), <accy>,<feature> [<CR><LF>+MAPATH:2 (mode out), <accy>,<feature> [...]] OK	The Read command returns the active input audio accessory and the output accessory for each feature.
Test	+MAPATH=?	+MAPATH: (list of supported directions),(list of supported accessories),(list of supported features combinations) OK	The Test command returns the supported audio directions (input/output), accessories and features.

The following table shows the +MAPATH parameters.

Table 3-108: +MAPATH Parameters

<Parameter>	Description
<direct>	1 Mode in, field <features> is ignored. 2 Mode out, field <features> is present.
<accy>	Mode in: 1 Mic 2 Headset mic 3 Digital RX (for read command only) Mode out: 1 Speaker 2 Headset speaker 3 Alert speaker, for example, battery low, incoming SMS, power up, and so on 4 Digital TX (for read command only)
<features> (1-15)	1 Voice 2 Key feedback 4 Alert 8 Ring

Example

```

AT+MAPATH=1,2           //Direct=1 (input), accy=2 (headset mic)
OK
AT+MAPATH=2,1,3        //Direct=2 (output), accy=1 (speaker), feature=1 (voice and keypad)
OK
AT+MAPATH?             //Set the headset mic as the input accessory
MAPATH: 1,2           //Direct=1 (input), accy=2 (headset mic)
MAPATH: 2,1,1         //Direct=2 (output), accy=1 (speaker), feature=1 (voice)
MAPATH: 2,1,2         //Direct=2 (output), accy=1 (speaker), feature=2 (keypad)
MAPATH: 2,3,4         //Direct=2 (output), accy=3 (alert speaker), feature=4 (alert)
MAPATH: 2,3,8         //Direct=2 (output), accy=3 (alert speaker), feature=8 (ring)
OK
AT+MAPATH=?
+MAPATH: (1,2),(1-4),(1-15)
OK
  
```

+MAVOL, Volume Setting

This command enables you to determine a volume level for a particular feature via a particular accessory. The gain levels are saved in flex. Therefore, upon power up, the path active (mic, speaker and alert speaker) will have these saved gain levels. This command is applicable for Analog and Digital modes.

Note: The SMS MT volume is adjusted using the +MAVOL command with type "ring". The RING value is related to the SMS alert, the MT call, and so on.

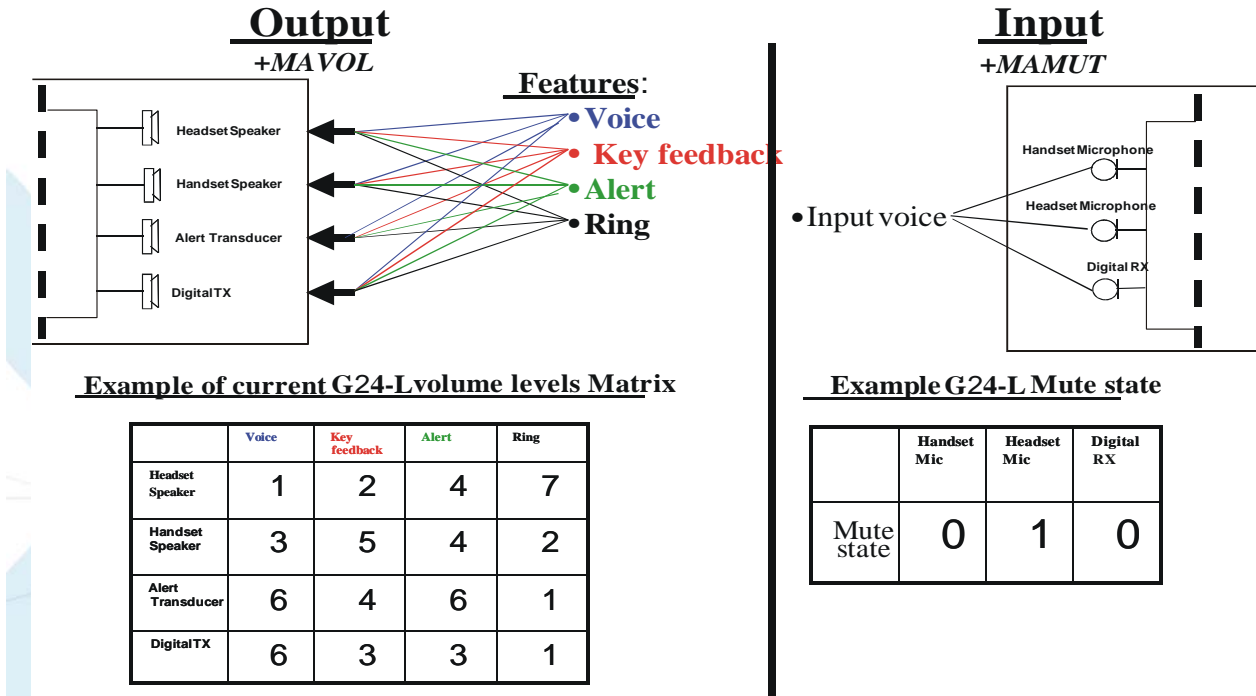

Figure 3-7: G24-L Audio Gain

Command Type	Syntax	Response/Action	Remarks
Set	+MAVOL=<accy>,<feature>,<vol>	OK or: +CME ERROR: <err>	The Set command sets the volume level <n> to a certain <feature> through a certain <accy>.
Read	+MAVOL?	(Current path volume) +MAVOL: <accy>,<feature1>,<vol> +MAVOL: <accy>,<feature2>,<vol> +MAVOL: <accy>,<feature4>,<vol> +MAVOL: <accy>,<feature8>,<vol> OK	The Read command returns the volume level of all the features in the current active accessories.
Test	+MAVOL=?	+MAVOL:(supported accessories),(supported features combinations),(supported volume levels)	Test command returns the supported range of volume levels, accessories and features.

The following table shows the +MAVOL parameters.

Table 3-109: +MAVOL Parameters

<Parameter>	Description
<accy> (1-15)	1 Speaker 2 Headset speaker 4 Alert speaker 8 Digital TX
<feature> (1-15)	1 Voice 2 Keypad feedback 4 Alert 8 Ring
<vol>	Volume level 0-7

Example

```

//Set volume level 3 for voice through speaker
AT+MAVOL=1,1,3           //Accy=1 (speaker), feature=1 (voice), vol=3 (volume level)
OK
//Set volume level 5 for voice and keypad through speaker
AT+MAVOL=1,3,5           //Accy=1 (speaker), feature=3 (voice and keypad), vol=5 (volume
level)
OK
AT+MAVOL?                 //Requests the volume level of the current path's features
//Currently the voice outputs through speaker and its volume level is 5
+MAVOL: 1,1,5             //Accy=1 (speaker), feature=1 (voice), vol=5
//Currently the keypad outputs through speaker and its volume level is 5
+MAVOL: 1,2,5             //Accy=1 (speaker), feature=2 (keypad), vol=5
//Currently the alert outputs through alert speaker and its volume level is 2
+MAVOL: 4,4,2             //Accy=4 (alert speaker), feature=4 (alert), vol=2
//Currently the ring outputs through alert speaker and its volume level is 2
+MAVOL: 4,8,2             //Accy=4 (alert speaker), feature=8 (ring), vol=2
OK
  
```

+MAMUT, Input Devices Mute

This command controls the muting/unmuting of all input paths (mic, headset mic or digital RX). Upon power up, all the devices are unmuted.

Command Type	Syntax	Response/Action	Remarks
Set	+MAMUT=<accy>,<state>	OK or: +CME ERROR: <err>	The Set command mutes/unmutes any input accessory or any combination of them.
Read	+MAMUT?	+MAMUT:<accy1>,<state> +MAMUT:<accy2>,<state> +MAMUT:<accy4>,<state> OK	The Read command returns the current mute/unmute state of all the input accessories.
Test	+MAMUT=?	+MAMUT:(<accy> range),(<state> range)	The Test command returns the mute states available and the output accessories supported.

The following table shows the +MAMUT parameters.

Table 3-110: MAMUT Parameters

<Parameter>	Description
<accy> (1-7)	1 Mic
	2 Headset mic
	4 Digital RX
<state>	0 Unmute
	1 Mute

Example

```

AT+MAMUT=2,0           //Accy=2 (headset mic), state=0 (unmute)
OK
AT+MAMUT=5,1           //Accy=5 (mic + Digital RX), state=1 (mute)
OK
AT+MAMUT?
+MAMUT: 1,1           //Accy=1 (mic), state=1 (mute)
+MAMUT: 2,0           //Accy=2 (headset mic), state=0 (unmute)
+MAMUT: 4,1           //Accy=4 (Digital RX), state=1 (mute)
AT+MAMUT=?
+MAMUT: (1-7),(0,1)
OK

```

+MAFEAT, Features Selection

This command controls the algorithm features: sidetone, echo cancel, noise suppression and automatic gain control. Upon power up, the sidetone is enabled, and echo canceling, noise suppression and automatic gain control are disabled.

Command Type	Syntax	Response/Action	Remarks
Set	AT+MAFEAT=<feature>,<state>	OK or: +CME ERROR: <err>	The Set command enables/disables feature combinations.
Read	AT+MAFEAT?	+MAFEAT: <feature><state>, [<CR><LF>+MAFEAT: <feature><state> [...]] OK or: +CME ERROR: <err>	The Read command returns the features state (enabled/disabled).
Test	AT+MAFEAT=?	+MAFEAT: (<list of supported <feature>s), (<list of supported <state>s) OK or: +CME ERROR: <err>	The Test command returns the list of supported features' numbers and supported states (enable/disable).

The following table shows the +MAFEAT parameters.

Table 3-111: MAFEAT Parameters

<Parameter>	Description
<feature>	A number between 1 to 15 which is built from a combination of: 1 - Side tone 2 - Echo cancel 4 - Noise suppress 8 - AGC (Automatic gain control)
<state>	0 - Disable 1 - Enable

Note: AGC - Automatic Gain Control is an electronic circuit that controls the gain of the received signal in order to ensure adequate performance over a range of input signal levels.

Example

```

AT+MAFEAT=5,1           //Enables sidetone and noise suppress
OK
AT+MAFEAT?
+MAFEAT: 1,1           //Feature=1 (sidetone), state=1 (enabled)
+MAFEAT: 2,0           //Feature=2 (echo cancel), state=0 (disabled)
+MAFEAT: 4,1           //Feature=4 (noise suppress), state=1 (enabled)
+MAFEAT: 8,0           //Feature=8 (AGC), state=0 (disable)
OK
    
```

General Audio Commands

+MADIGITAL, Analog/Digital Audio Switching

This command switches between analog and digital audio modes. AT+MADIGITAL=1 switches to digital audio mode, and AT+MADIGITAL=0 switches it back to analog mode.

Command Type	Syntax	Response/Action	Remarks
Set	+MADIGITAL= <mode>	OK or: +CME ERROR: <err>	The Set command sets analog or digital audio modes.
Read	+MADIGITAL?	+MADIGITAL:<mode> OK	The Read command returns the current audio mode (analog or digital).
Test	+MADIGITAL=?	+MADIGITAL: <available audio modes> OK	The test command returns the available digital audio modes.

The following table shows the +MADIGITAL parameters.

Table 3-112: +MADIGITAL Parameters

<Parameter>	Description
<mode>	0 G24-L works in analog audio mode. 1 G24-L works in digital audio mode.

Example

```

AT+MADIGITAL=?
+MADIGITAL: (0,1)
OK
AT+MADIGITAL?
+MADIGITAL: 0
OK
AT+MADIGITAL=1
OK
AT+MADIGITAL?
+MADIGITAL: 1
    
```

```

OK
AT+MADIGITAL=0
OK
AT+MADIGITAL?
+MADIGITAL: 0
OK
AT+MADIGITAL=3
ERROR
AT+MADIGITAL?
+MADIGITAL: 0
OK

```

+CALM, Alert Sound Mode

This command handles the selection of the G24-L's alert sound mode. The value of the command is saved after a power cycle.

Command Type	Syntax	Response/Action	Remarks
Set	+CALM=<mode>	OK +CME ERROR: <err>	The Set command sets the alert sound mode.
Read	+CALM?	+CALM: <mode> +CME ERROR: <err>	The Read command displays the current alert sound mode setting.
Test	+CALM=?	+CALM: (list of supported <mode>s) +CME ERROR: <err>	The Test command displays the list of supported modes.

The following table shows the +CALM parameters.

Table 3-113: +CALM Parameters

<Parameter>	Description
<mode>	Alert sound mode of the G24-L. 0 Ring (default) 1 Silent mode (ring prevented)

Note: Selecting the ring mode with this command retrieves the current alert volume level setting.

Example

```

AT+CALM=?
+CALM: (0,1)
OK
AT+CALM?
+CALM: 0
OK
AT+CALM=1
OK

```

+ MMICG, Microphone Gain Value

This command handles the selection of microphone gain values of MIC-handsets (not MIC-headsets). The new value remains after power cycle. This command is applicable for Analog and Digital modes. The gain levels are saved in flex.

Command Type	Syntax	Response/Action	Remarks
Set	+MMICG=<gain>	OK +CME ERROR: <err>	The Set command sets the microphone gain value.
Read	+MMICG?	+MMICG: <gain> +CME ERROR: <err>	The Read command displays the current microphone gain.
Test	+MMICG=?	+MMICG (list of supported <gain>s) +CME ERROR: <err>	The Test command displays the list of supported gain values.

The following table shows the +MMICG parameters.

Table 3-114: +MMICG Parameters

<Parameter>	Description
<gain>	Microphone gain values in db: 0-31 0 is lowest gain value (not mute); default is 16 db

Example

```
AT+MMICG=?
+MMICG: (0-31)
OK
AT+MMICG?
+MMICG: 16
OK
AT+MMICG=30
OK
```

+CRTT, Ring Type Selection

This command plays one cycle of a ring tone, stops the cycle in the middle and sets the ring tone to be used.

Command Type	Syntax	Response/Action	Remarks
Set	AT+CRTT= <RingTypeNumber>, <operation>	OK or: +CME ERROR: <err>	The Set command sets the ring type and operation.
Read	AT+CRTT?	+CRTT: <RingTypeNumber> OK or: +CME ERROR: <err>	The Read command returns the ring type number.
Test	AT+CRTT=?	+CRTT: (list of supported <RingTypeNumber>s), (list of supported <operation>s) OK or: +CME ERROR: <err>	The Test command returns the list of supported tone type numbers and operations.

The following table shows the +CRTT parameters.

Table 3-115: +CRTT Parameters

<Parameter>	Description
<RingType Number>	Ring tone styles (see Table 3-116)
<operation>	Play or set a tone 0 Play (play one cycle) 1 Set 2 Stop

Table 3-116: Ring Tone Types Available

CRTT=X	Ring Tone Style Name
1	Alert
2	Alert
3	Bells
4	Bits & Bytes
5	Charger1
6	Charger2
7	Door Bell
8	Triads
9	Wind Chimes
10	Up and Down
11	Random
12	Start Up
13	Cosmic
14	Cosmic2
15	Intrelude
16	Power Surge
17	Clouds
18	Waves

Example

```

AT+CRTT=4,0           //Ring type number 4, operation 0 (play)
OK                   //When 4 is in the supported <RingTypeNumber> range
AT+CRTT=4,2           //Ring type number=4, operation 2 (stop)
OK
AT+CRTT=?
+CRTT: (1-18),(0-2)
OK
AT+CRTT?
+CRTT: 4              //Ring type number 4
AT+CRTT=5,4           //Invalid operation
+CME ERROR: <err>

```

+VTD, Tone Duration

This command handles the selection of tone duration. An integer <n> defines the length of tones emitted as a result of the +VTS command. This command does not affect the D (dial) command. (Refer to “D, Dial Command”, page 11.)

Any value other than zero causes a tone of duration <n> in multiples of 100 msec.

In this command, the new value is erased after power down.

Note: In GSM, the tone duration value can be modified depending on the specific network.

Command Type	Syntax	Response/Action	Remarks
Set	+VTD=<n>	OK +CME ERROR: <err>	The Set command sets the tone duration.
Read	+VTD?	<n> +CME ERROR: <err>	The Read command displays the current tone duration.
Test	+VTD=?	+VTD: (list of supported <n>s) +CME ERROR: <err>	The Test command displays the list of supported tone durations.

The following table shows the +VTD parameters.

Table 3-117: +VTD Parameters

<Parameter>	Description
<n>	Defines the length of tones emitted by the +VTS command. 0-600 Multiples of 100 msec (0 is equivalent to 1, that is, 100 msec) The default is 5 multiples of 100 msec.

Example

```
AT+VTD=?
+VTD: (0-600)
OK
AT+VTD?
+VTD: 5
OK
AT+VTD=10
OK
```

+VTS, Command-Specific Tone Duration

This command transmits a string of DTMF tones when a voice call is active. DTMF tones may be used, for example, when announcing the start of a recording period.

The duration does not erase the VTD duration (Refer to “+VTD, Tone Duration” on page 3-175).

Note: In GSM, the tone duration value can be modified depending on the specific network.

If the active call is dropped in the middle of playing a DTMF tone, the following unsolicited message transfers to TE: +VTS: "Call termination stopped DTMF tones transmission".

Command Type	Syntax	Response/Action	Remarks
Set	+VTS= <DTMF>,<duration>]	OK +CME ERROR: <err>	The Set command sets the tone and duration (if entered).
Read	+VTS?	+VTS: <DTMF> +CME ERROR: <err>	The Read command displays the currently transmitted DTMF tone. An error is displayed if no tone is active.
Test	+VTS=?	+VTS: (list of supported <DTMF>, (list of supported <duration>s) +CME ERROR: <err>	The Test command displays the list of supported DTMF tones and tone lengths.

The following table shows the +VTS parameters.

Table 3-118: +VTS Parameters

<Parameter>	Description
<DTMF>	String of ASCII characters (0-9, #, *, A-D) String length is up to 32 characters long.
<duration>	A DTMF tone of different duration from that set by the +VTD command. 0-600 Multiples of 100 msec (0 is equivalent to 1, that is, 100 msec) <duration> does not erase the +VTD duration.

Note: The duration defined by +VTS is specific to the DTMF string in this command only. It does not erase the duration defined by the +VTD command, and is erased when the G24-L is powered down.

If <duration> is not defined, the +VTD value is used.

Example

```
AT+VTS ?
+VTS: "5"
OK
AT+VTS="2",10
OK
```

Access

Access Control Commands

When the module or SIM card is locked or blocked, the only accessory operations allowed are those that are called "Basic AT commands".

A/, Repeat Last Command

This command repeats the last command. It is not necessary to press <Enter> after this command.

Command Type	Syntax	Response/Action
Execute	A/	Repeats last command

Example

```
AT&D?
&D: 2
OK
A/
&D: 2
OK
```

AT, Check AT Communication

This command only returns OK.

Command Type	Syntax	Response/Action
Execute	AT	OK

Example

```
AT
OK
```

+CPIN, Enter PIN for Unlocking SIM Card or Enter PUK for Unlocking SIM Card

This command unlocks the SIM card when the proper SIM PIN is provided and unblocks the SIM card when the proper SIM PUK is provided.

The SIM card is unlocked only once the provided pin is verified as the SIM PIN. If the required PIN (determined by the error code returned from the requested operation or the Read command) is SIM PUK or SIM PUK2, the second pin is required. This second pin, <newpin>, is used to replace the old pin in the SIM card. When entering the pin, a <new pin> is not required.

Note: The SIM card lock is another level of security independent of the phone lock (See “Access Control Commands” on page 3-177 for more information).

Figure 3-8 presents a diagram of what occurs when using the SIM card. Note that if an incorrect password is entered three times, the G24-L requires that a master password be entered. If this also fails three times, the SIM will be blocked, and you will have to go to your provider to unblock it.

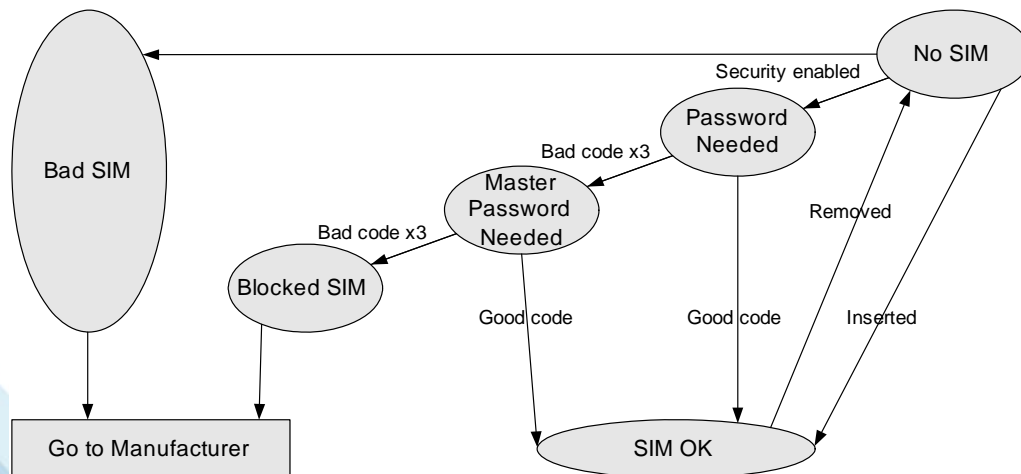

Figure 3-8: SIM States

A SIM card related error is returned if an AT command operation is unsuccessful due to a SIM card problem. The following table shows the SIM card errors.

Table 3-119: SIM Card Errors

Error	Description
10 SIM not inserted	SIM Card is not inserted
11 SIM PIN required	SIM Card waiting for SIM PIN to be entered
12 SIM PUK required	SIM PIN is blocked
13 SIM failure	SIM Card is permanently blocked
17 SIM PIN2 required	SIM Card is waiting for SIM PIN2 to be entered
18 SIM PUK2 required	SIM PIN2 is blocked

Command Type	Syntax	Response/Action	Remarks
Set	AT+CPIN=[<puk> or <pin>], [<newpin>]	OK or: +CME ERROR: <err>	The Set command sends the password to the G-LITE that is necessary before it can be operated (SIM PIN or SIM PUK). If there is no PIN request pending, no action is taken towards the G-LITE, and an error message, +CME ERROR, is returned to the terminal. The Set command issued gives the code (SIM PIN or SIM PUK) corresponding to the error code required or returned as the result of the Read command. For example, if the SIM PIN is blocked, the error code 11 or "SIM PIN required" is returned. The user must then issue the Set command with the SIM PIN.
Read	AT+CPIN?	+CPIN: <code> OK or: +CME ERROR: <err>	The Read command returns an alphanumeric string indicating the status of the SIM card, and whether a password is required or not. This is an independent SIM card lock status check only, and does not check the phone lock status.
Test	AT+CPIN=?	OK or: +CME ERROR: <err>	

The following table shows the +CPIN parameters.

Table 3-120: +CPIN Parameters

<Parameter>	Description
<puk>	PUK code for unblocking a blocked phone
<pin>	Current PIN for unlocking a locked phone
<newpin>	New PIN (after changing or after entering PUK) 4 - 8 digits
<code>	READY - Not waiting for a password SIM PIN - Waiting for SIM PIN SIM PUK - Waiting for SIM PUK SIM PIN2 - Waiting for SIM PIN, this response is given when the last executed command resulted in PIN2 authentication failure SIM PUK2 - Waiting for SIM PUK2, this response is given when the last executed command resulted in PUK2 authentication failure
SIM PIN SIM PUK SIM PUK2 SIM PIN 2	AT+CPIN=<pin> AT+CPIN=<puk>,<newpin> AT+CPIN=<puk2>,<newpin2> AT+CPIN=<pin2>

Example

```
AT+CPIN=?
```

```
OK
```

```
AT+CLCK="SC",1,"<correct PIN>"//Not case-sensitive
```

```
OK
```

The facility is enabled by the +CLCK command (Refer to "+CLCK, Facility Lock" on page 3-184)

```
AT+CPIN?
```

```
+CPIN: SIM PIN
```

```
OK
```

```
AT+CPIN="<correct PIN>"
```

```
OK
```

```
AT+CPIN?
```

```
+CPIN: READY
```

```
OK
```

The status of the SIM is still enabled, but the PIN is READY for this session.

The SIM is enabled per session. After power-up SIM must be unlocked again by using the +CLCK command.

The following case shows an example of three unsuccessful attempts at entering the PIN:

```
AT+CPIN?
```

```
+CPIN: SIM PIN
```

```
OK
```

```
AT+CPIN="<wrong pin>"
```

```
+CME ERROR: incorrect password
```

```
AT+CPIN="<wrong pin>"
```

```
+CME ERROR: incorrect password
```

```
AT+CPIN="<wrong pin>"
```

```
+CME ERROR: SIM PUK required
```

```
AT+CPIN?
```

```
+CPIN: SIM PUK
```

//PIN is blocked. The PUK is needed for unblocking.

```
OK
```

```
AT+CPIN="<PUK>","<NEW PIN>" //Enter PUK and new PIN
```

```
OK
```

```
AT+CLCK="FD",1,"<wrong PIN2>"
```

```
+CME ERROR: incorrect password
```

```
AT+CLCK="FD",1,"<wrong PIN2>"
```

```
+CME ERROR: incorrect password
```

```
AT+CLCK="FD",1,"<wrong PIN2>"
```

```
+CME ERROR: SIM PUK2 required
```

```
AT+CPIN?
```

```
+CPIN: SIM PUK2
```

//PIN2 is blocked. The PUK2 is needed for unlocking.

```
OK
```

```
AT+CPIN="<PUK2>","<NEW PIN2>" //Enter PUK2 and new PIN2
```

```
OK
```

+EPIN, Enter SIM PIN2 to Verify PIN2 Indicator

This AT command will be used to verify the PIN2 when the proper SIM PIN2 password has been provided. The code presented by the ME PIN2 password will be compared with the relevant one stored in the SIM. The execution of this command is possible only if the SIM is in READY state or waiting for PIN2 state. If the PIN2 presented is correct, the number of remaining PIN2 attempts will be reset to its initial value allowed by the service provider. If the PIN2 presented is false, the number of remaining PIN2 attempts will be decremented. If an incorrect password is entered for maximum attempts allowed by provider, the SIM will be blocked, and the user will have to unblock it. To unblock the SIM card, the user can use the AT+CPIN command.

Command Type	Syntax	Response/Action	Remarks
Set	AT+EPIN=<type>,<passwd>	OK or: +CME ERROR: <err>	
Test	AT+EPIN=?	+EPIN: possible list of <type> OK	

The following table shows the +EPIN parameters.

Table 3-121: +EPIN Parameters

<Parameter>	Description
<type>	Digit type value, that indicate what action need to be execute. 2 - Verify PIN2 indicator.
<passwd>	String type. PIN2 password 4 - 8 digits.

Example

```
AT+EPIN=?
+EPIN: 2
OK
```

```
AT+EPIN=2,"<wrong_passwd>"
+CME ERROR: incorrect password
```

```
AT+EPIN=1,"<passwd>"
+CME ERROR: not supported
```

```
AT+EPIN=2,"<correct_passwd>"
OK
```

+TPIN, Query Number of Remaining SIM PIN/PUK Entering Attempts

This command returns the number of remaining attempts of entering the PIN and PUK for the SIM card in use. The command returns the number of remaining attempts for PIN1 (CHV1), PIN2 (CHV2), PUK1 (unlock CHV1) and PUK2 (unlock CHV2).

Number of available attempts is provider dependant. Typically it is 3 attempts for PIN, 10 attempts for PUK.

This command will return error if SIM is not inserted.

Command Type	Syntax	Response/Action	Remarks
Read	AT+TPIN?	+TPIN:<chv1>, <unb1_chv1>,<chv2>, <unb1_chv2> or ERROR	

The following table shows the +TPIN parameters.

Table 3-122: +TPIN Parameters

<Parameter>	Description
<chv1>	Number of remaining PIN attempts
<chv2>	Number of remaining PIN2 attempts
<unb1_chv1>	Number of remaining PUK attempts
<unb1_chv2>	Number of remaining PUK2 attempts

Example

```
AT+TPIN=?
+TPIN: 3,10,3,10
OK
AT+CPIN="7777"
+CME ERROR: incorrect password
AT+TPIN?
+TPIN: 2,10,3,10
OK
```

+CPWD, Change Password

This command sets a new password for the facility lock. The password can only be changed once the required facility is enabled by the +CLCK command. (Refer to “+CLCK, Facility Lock” on page 3-184).

A password can be changed only if the provided password <oldpwd> has been verified. The entered password <newpwd> must also comply to the password rules. The facility value <fac> is not case-sensitive. In the password value, letters are not allowed.

Command Type	Syntax	Response/Action	Remarks
Set	AT+CPWD=<fac>,<oldpwd>,<newpwd>	OK or: +CME ERROR: <err>	The Set command sets a new password for the facility lock function, defined by the +CLCK command. (Refer to “+CLCK, Facility Lock” on page 3-184).
Read	AT+CPWD?	+CME ERROR: <err>	
Test	AT+CPWD=?	+CPWD:list of supported (<fac>,<pwdlength>)s OK or: +CME ERROR: <err>	The Test command returns a list of pairs which represent the available facilities, and the maximum length of their passwords.

The following table shows the +CPWD parameters.

Table 3-123: +CPWD Parameters

<Parameter>	Description
<fac>	List of supported facilities. All the facility messages, except for SC and P2, are sent to the network. (The facilities are not case-sensitive.) SC SIM (lock SIM card) The SIM requests the password during G24-L power-up and when this command is issued. AO BAOC (Bar All Outgoing Calls) OI BOIC (Bar Outgoing International Calls) OX BOIC-exHC (Bar Outgoing International Calls except to Home Country) AI BAIC (Bar All Incoming Calls) IR BIC-Roam (Bar Incoming Calls when Roaming outside the home country) AB All Barring services (applicable only for <mode>=0) AG All outGoing barring services (applicable only for <mode>=0) AC All inComing barring services (applicable only for <mode>=0) P2 SIM PIN2 (Refer to “+CLCK, Facility Lock”, page 3-184)
<oldpwd>	String type, 4-8 character password specified for the facility from the G24-L user interface.
<newpwd>	String type, 4-8 character new password specified by the user.
<pwdlength>	Maximum length of the facility password. Integer type.

Example

```

AT+CPWD=?
+CPWD: ("SC",8),("AO",4),("OI",4),("OX",4),("AI",4),("IR",4),("AB",4),("AG",4),("AC",4),("P2",8)
OK
AT+CPWD?
+CME ERROR: operation not supported
AT+CLCK: "sc",1,"current pin password"
AT+CPWD="sc","incorrect old password","new password"
+CME ERROR: incorrect password
AT+CLCK="sc",2
+CLCK: 0
OK
AT+CPWD="sc","old password","new password"
+CME ERROR: operation not allowed
AT+CLCK="fd",1,"current pin2 password"
AT+CPWD="p2","old password","new password"
OK
AT+CLCK="ai",2
+CLCK: 0,1
+CLCK: 0,2
+CLCK: 0,4
OK
AT+CLCK="ai",1,"correct password"
OK
AT+CLCK="ai",2
+CLCK: 1,1
+CLCK: 1,2
+CLCK: 1,4
OK
AT+CPWD="ai","old password","new password"
OK

```

+CLCK, Facility Lock

This command locks, unlocks or interrogates a G24-L or a network facility <fac> (any kind of call barring program). A password is mandatory for performing locking and unlocking actions, but not for querying. The features of the G24-L that are affected by this are the keypad power-up operation and fixed dialing list. When querying the status of a single call barring program <mode>=2, the <status> for each call type will be returned.

For <fac>="SC", SIM Card PIN setting and for <fac>="FD", SIM Fixed Dialing memory setting, (For more information about <class>, refer to [Table 3-124](#) showing the +CLCK parameters).

The <passwd> for "SC" is SIM PIN, and for "FD" it is SIM PIN2.

Note: Concerning <fac>="FD". When FD is enabled it is possible to make a call only to numbers that are located in the FD phone book, include GPRS session (#99*). If the number is not in the phone book the user will receive "operation not allowed". In order to insert a new number to the FD phone book, the user must disable the FD feature first <mode>=0, insert the new number and only then enable the FD feature <mode>=1.

Command Type	Syntax	Response/Action	Remarks
Set	+CLCK=<fac>,<mode> [,<passwd> [,<classx>]]	For <fac> where <class> is irrelevant (SC, FD): +CLCK=<fac>,2 +CLCK: <status> For <fac> with several supported <class>es: +CLCK=<fac>,2 +CLCK: <status>,<class1> [<CR><LF>+CLCK: <status>,<class2> [...]] OK	The Set command performs the specified <mode> action on the specified <fac>.
Read	+CLCK?	+CLCK: ERROR	
Test	+CLCK=?	+CLCK: (list of supported <fac>s)	The Test command returns the list of supported facilities.

The following table shows the +CLCK parameters.

Table 3-124: +CLCK Parameters

<Parameter>	Description
<fac>	SC SIM Card PIN setting <mode>0 Disable PIN 1 Enable PIN) FD SIM Fixed Dialing memory setting <mode>0 Disable fixed dialing feature 1 Enable fixed dialing feature) AO BAOC (Bar All Outgoing Calls) OI BOIC (Bar Outgoing International Calls) OX BOIC-exHC (Bar Outgoing International Calls except to Home Country) AI BAIC (Bar All Incoming Calls) IR BIC-Roam (Bar Incoming Calls when Roaming outside the home country) AB All Barring services (applicable only for <mode>=0) AG All outgoing barring services (applicable only for <mode>=0) AC All incoming barring services (applicable only for <mode>=0)
<passwd>	String type, 4-8 character password
<mode>	0 Unlock 1 Lock 2 Query status (<passwd> does not apply)

Table 3-124: +CLCK Parameters (Cont.)

<Parameter>	Description
<class>	Sum of integers, each representing a class of information <class>. Only applies to call barring related facilities. 1 Voice (telephony) 2 Data (refers to all bearer services) 4 Fax (facsimile services) 8 SMS (Short Message Services) The default value is 7.
<status>	0 Inactive 1 Active

Example

```

AT+CLCK=?
+CLCK: ("SC","AO","OI","OX","AI","IR","AB","AG","AC","FD")
OK
AT+CLCK="SC",2
+CLCK: 0
OK
AT+CLCK="SC",1
+CME ERROR: operation not allowed
AT+CLCK="SC",1,"incorrect password"
+CME ERROR: incorrect password
AT+CLCK="SC",1,"correct password"
OK
(From now SIM Card is locked and PIN is requested on power up)
AT+CLCK="AB",0,"incorrect password"
+CME ERROR: incorrect password
AT+CLCK="IR",2
+CLCK: 0,1
+CLCK: 0,2
+CLCK: 0,4
+CLCK: 0,8
OK
AT+CLCK="IR",1,"correct password" //<class> is defaulted to 7 when not specified
OK
AT+CLCK="IR",2
+CLCK: 1,1
+CLCK: 1,2
+CLCK: 1,4
+CLCK: 0,8
OK
AT+CLCK="OI",2
+CLCK: 0,1
+CLCK: 0,2
+CLCK: 0,4
+CLCK: 0,8
OK
AT+CLCK="OI",1,"correct password",3

```

```

OK
(Voice and data international calls barred, fax and SMS not barred.)
AT+CLCK="OI",2
+CLCK: 1,1
+CLCK: 1,2
+CLCK: 0,4
+CLCK: 0,8
OK

```

+EMPC, Unlocking or Locking Subsidy Code

This command is applicable for all types of Subsidy Lock types:

- HPLMN only
- Type 1 HPLMN and 1 IMSI digit
- Type 2 HPLMN and 2 IMSI digits
- Type 3 HPLMN and GID 1
- Type 4 HPLMN and Range of IMSI digits
- Type 5 First SIM Inserted
- Type 6 First SIS Inserted (GID 1 or No action)
- Type 7 First SIM Inserted (GID 1 or Range Setting)
- Type 9 PLMN of first SIM Inserted
- D2 SIM Lock
- HPLMN that matches 1st SIM Inserted
- Valid PLMN
- Telefonica SIM Lock
- Airtel SIM Lock

Once the subsidy unlock pin code is entered correctly to the unit, the unit is not locked any more. In order to relock the unit a Reset action is requested. Other PLMN that will be inserted into the unit when the first PLMN is locked will be transited to a Lock state and will not be permitted to perform other non-basic commands except for +EMPC and emergency calls. An error code 284 - "SIM is subsidy locked" will be returned if some non-basic commands were entered when the first PLMN is locked. If the user exceeds the maximum password attempts (5 attempts), the unit will be transited to a "penalty" state and only basic command will be permitted to perform and emergency calls. This state is effective to duration 5 minutes. An error code 285 - "The phone is in a penalty state" will be returned if non-basic command was entered in case of penalty state. When penalty state is over the unit will be transited to a Lock state. Availability of subsidy lock feature was determined only by the special flexing. If another flex was determined, the command will return +EMPC: 3,0 for read command and +EMPC: 1,0 for set command.

Command Type	Syntax	Response/Action	Remarks
Set	+EMPC=<pin>,<action>	+EMPC:<unlock>,<reset> OK or: +CME ERROR: <err>	The Set command checks the password with requested action type. All parameters are mandatory field. If the pin is wrong or inserts wrong action, no action is taken towards the G24-L, and an error message, +CME ERROR, is returned to the terminal. The Set command issued gives the code corresponding to the required action.
Read	+EMPC?	+EMPC:3,<reset> OK or: +CME ERROR <err>	The read command returns the current EMPC reset value only.

The following table shows the +EMPC parameters.

Table 3-125: +EMPC Parameters

<Parameter>	Description
<pin>	Subsidy Lock pin code.
<action>	0 Unlock subsidy 1 Reset subsidy
<unlock>	0 Correct pin code is entered 1 Wrong pin code is entered 2 Wait 3 No meaning
<reset>	0 No subsidy lock 1 Subsidy lock / Reset not allowed 2 Subsidy unlock / Reset allowed

Example

```
AT+EMPC?
+EMPC:3,0
OK
```

The status of phone is: the subsidy lock is not active.

```
AT+EMPC="<correct pin>",0
+EMPC:0,1
OK
```

The command unlocks the phone if the password was typed correctly.

```
AT+EMPC="<correct pin>",1
+EMPC:0,2
OK
```

The command resets the phone if the password was typed correctly.

The following case shows an example of five unsuccessful attempts at entering the pin:

```
AT+EMPC="<wrong pin>",0
+EMPC:1,1
OK
```

```
AT+EMPC="<wrong pin>",0
+EMPC:1,1
OK
```

```
AT+EMPC="<wrong pin>",0
+EMPC:1,1
OK
```

```
AT+EMPC="<wrong pin>",0
+EMPC:1,1
OK
```

```
AT+EMPC="<wrong pin>",0
+EMPC:2,1
OK
```

The phone moves to Penalty state.

```
AT+COPS?
+CME ERROR: Phone is in penalty state.
```

```
AT+EMPC="<correct pin>",0
+EMPC:0,0
OK
```

In case of penalty, after 5 min if user types a correct pin, the phone will unlock.

Modem Configuration and Profile

Modem Register Commands

The G24-L holds certain data items in selected memory space, named Software Registers (S-registers) and Modem Registers. Some of these registers are used as bitmaps, where one register holds more than one data item.

All S-registers can be accessed using the S command, described in “S, Bit Map Registers” on page 3-194. Some registers can also be accessed using dedicated commands, detailed below.

V, G24-L Response Format

This command determines the response format of the data adapter and the contents of the header and trailer transmitted with the result codes and information responses. This command also determines whether the result codes are transmitted in a numeric or an alphabetic ("verbose") form. The text portion of information responses is not affected by this setting.

The following table shows the effect that setting this parameter has on the format of information text and result codes.

Table 3-126: Effects of Parameter Settings

V0	V1	Information Responses
<ATV0><cr><lf>	<ATV1><cr><lf>	0 - "OK" 1 - "CONNECT" 2 - "RING" 3 - "NO CARRIER" 4 - "ERROR" 5 - "NO DIALTONE" 6 - "BUSY" 7 - "NO ANSWER"
<numeric code><cr><lf>	<verbose code><cr><lf>	

Command Type	Syntax	Response/Action	Remarks
Set	ATV<value>	OK or: +CME ERROR: <err>	The Set command sets the format of information responses and result codes.
Read	ATV?	<current value>	The Read command reads the current setting of response format.
Test			The Test command for V is not defined, and therefore is not supported by the G24-L. The G24-L returns an error.

The following table shows the V parameters.

Table 3-127: V Parameters

<Parameter>	Description
<value>	0 Transmits limited headers and trailers, and numeric text. 1 Transmits full headers and trailers, and verbose response text. The default value is 1.

Example

```

ATV?
V: 1
OK
ATV0
0
ATV7
4
ATV1
OK
ATV7
ERROR
  
```

Q, Result Code Suppression

This command determines whether to output the result codes. Information text transmitted in response to commands is not affected by the setting of this parameter.

Command Type	Syntax	Response/Action	Remarks
Set	ATQ<value>	OK or: +CME ERROR: <err>	The set commands sets whether or not to output result codes.
Read	ATQ?	<current value>	The Read command reads the current setting for result code suppression.
Test			The Test command for Q is not defined, and therefore is not supported by the G24-L. The G24-L returns an error.

The following table shows the Qn parameters.

Table 3-128: Qn Parameters

<Parameter>	Description
<value>	0 Transmit result codes. 1 Suppress result codes. The default value is 0.

Example

```

ATQ0
OK
ATQ?
Q: 0
OK
ATQ4
ERROR
ATQ1 //No response because result codes are suppressed.
ATQ4 //No response because result codes are suppressed.
    
```

E, Command Echo

This command defines whether input characters are echoed to output. If so, these characters are echoed at the same rate, parity and format at which they were received.

Command Type	Syntax	Response/Action	Remarks
Set	ATE<value>	OK or: +CME ERROR: <err>	The Set command sets whether or not to echo characters.
Read	ATE?	<current value>	The Read command reads the current setting for command echo.
Test			The Test command for E is not defined by ITU, and therefore is not supported by the G24-L. The G24-L returns an error.

The following table shows the E parameters.

Table 3-129: En Parameters

<Parameter>	Description
<value>	0 Does not echo characters 1 Echoes characters The default value is 0.

Example

```
ATE?
001
OK
```

X, Result Code Selection and Call Progress Monitoring Control

This command defines the CONNECT result code format. It determines whether or not the G24-L transmits particular result codes to the user. It also controls whether the G24-L verifies the presence of dial tone when it first goes off-hook to begin dialing, and whether the engaged tone (busy signal) detection is enabled.

Command Type	Syntax	Response/Action	Remarks
Set	ATX<value>	OK or: +CME ERROR: <err>	The Set command sets the result code and call progress monitoring control.
Read	ATX?	<current value>	
Test			The Test command for X is not defined by ITU, and therefore is not supported by the G24-L. The G24-L returns an error.

The following table shows the X parameters.

Table 3-130: X Parameters

<Parameter>	Description
<value>	<p>0 CONNECT result code given upon entering online data state: Dial tone detection - Disabled Busy detection - Disabled</p> <p>1 CONNECT <text> result code given upon entering online data state: Dial tone detection - Disabled Busy detection - Disabled</p> <p>2 CONNECT <text> result code given upon entering online data state: Dial tone detection - Enabled Busy detection - Disabled</p> <p>3 CONNECT <text> result code given upon entering online data state: Dial tone detection - Disabled Busy detection - Enabled</p> <p>4 CONNECT <text> result code given upon entering online data state: Dial tone detection - Enabled Busy detection - Enabled</p> <p>The default value is 0.</p>

Example

```
ATX?
000
OK
```

S, Bit Map Registers

This command reads/writes values of the S-registers. The G24-L supports this command for various S values, according to official specifications (ITU-I, ETSI, or manufacturer specific).

Command Type	Syntax	Response/Action	Remarks
Set	ATSn=<value>	OK or: +CME ERROR: <err>	The Set command is allowed for read/write S-registers, and not allowed for read-only S-registers.
Read	ATSn?	<current value of S-register n> or: +CME ERROR: <err>	
Test			The Test command for Sn is not defined by ITU, and therefore is not supported by the G24-L. The G24-L returns an error.

The following table shows the different S-registers and their associated values.

Sn	Description	Min Value	Max Value	Default Value
S0	Sets/gets number of rings before auto answer.	0	255	0
S2	Sets/gets escape code character.	0	255	43
S3	Sets/gets carriage return code character.	0	127	13
S4	Sets/gets line feed code character.	0	127	10
S5	Sets/gets command line editing character (backspace).	0	127	8
S7	Sets the number of seconds in which connection must be established before the call is disconnected.	1	255	30
S12	Sets/gets guard time (in units of 50 msec) for the escape character during CSD connections	0	255	20
S14	Read-only. Holds values of En (in bit 1), Qn (in bit 2), Vn (in bit 3).	—	—	170
S21	Read-only. Holds values of &Dn (in bits 2, 3 and 4), &Cn (in bits 5 and 6).	—	—	40
S22	Read-only. Holds values of Mn (in bits 2 and 3), Xn (in bits 4, 5 and 6)	—	—	134
S31	Read-only. Holds value of Wn (in bits 2 and 3).	—	—	0
S36	Sets/gets value of \Nn.	0	7	5
S39	Read-only. Holds value of &Kn (in bits 0, 1 and 2).	—	—	3
S40	Read-only. Holds value of \An (in bits 6 and 7).	—	—	192
S41	Read-only. Holds value of %Cn (in bits 0 and 1).	—	—	3

Note: S0 (Auto Answer) should work regardless of the DTR HW line state. This is a deviation from the ITU V. 25-ter standard.

Example

```

ATS36?
005
OK
ATS0=3
OK
ATS0?
003
OK
    
```

S2

This command handles the selection of the escape characters, which are stored in S-Register 2, and specifies the escape character used in CSD connections.

Command Type	Syntax	Response/Action	Remarks
Set	S2=<escape_character>	OK +CME ERROR: <err>	The Set command sets the CSD escape character value if all parameters are valid.
Read	S2?	<escape_character> OK +CME ERROR: <err>	The Read command displays the currently defined escape character for CSD connections.

The following table shows the S2 parameters.

Table 3-131: S2 Parameters

<Parameter>	Description
<escape_character>	CSD escape character. Range is 0 to 255. The default value is 43 ("+").

S12

This command handles the selection of the guard time, which is stored in S-Register 12, and specifies the behavior of escape characters during CSD connection.

Note: For a guard time specified by S-Register 12, no character should be entered before or after "+++". The duration between escape codes must be smaller than the guard time.

Command Type	Syntax	Response/Action	Remarks
Set	S12=<guard_time>	OK +CME ERROR: <err>	The Set command sets the CSD escape character guard time value if all parameters are valid.
Read	S12?	<guard_time> OK +CME ERROR: <err>	The Read command displays the current CSD escape character guard time.

The following table shows the S12 parameters.

Table 3-132: S12 Parameters

<Parameter>	Description
<guard_time>	CSD escape character guard time (units of 50 msec). Range is 0 to 255. The default value is 20.

\S, Show the Status of the Commands and S-registers in Effect

This command displays the status of selected commands and S-registers.

\G, Software Control

This command sets the use of the software control. It is used for backward compatibility.

\J, Terminal Auto Rate

This command adjusts the terminal auto rate. It is used for backward compatibility.

\N, Link Type

This command displays the link type. It is used for backward compatibility.

+CBAND, Change Radio Band

This command has no effect, and only returns OK. It is used for backward compatibility.

?, Return the Value of the Last Updated S-register

This command displays the most recently updated value stored in an S-register.

Command Type	Syntax	Response/Action	Remarks
Read	AT?	000 OK	The Read command returns the value of the last updated S-register.

Example

```
AT?
000
OK
AT?
003
OK
ATS36=5
OK
AT?
005
OK
```

&F, Set to Factory Defined Configuration

This command restores the factory default configuration profile. The G24-L only supports one factory default profile, 0.

Command Type	Syntax	Response/Action	Remarks
Set	AT&F<value>	OK or: +CMS ERROR: <err>	
Read	AT&F?	<current profile number>	
Test			The Test command for &F is not defined by ITU, and therefore is not supported by the G24-L. The G24-L returns an error.

The following table shows the &F parameters.

Table 3-133: &F Parameters

<Parameter>	Description
<value>	0 Factory default configuration profile. This is the only value supported.

Example

```
AT&F?
&F: 0
OK
```

Z, Reset to Default Configuration

This command drops the current call, and resets the values to default configuration.

Command Type	Syntax	Response/Action	Remarks
Set	ATZ<value>	OK or: +CMS ERROR: <err>	
Read			The Read command for Z is not defined, and therefore is not supported by the G24-L. The G24-L returns an error.
Test			The Test command for Z is not defined, and therefore is not supported by the G24-L. The G24-L returns an error.

The following table shows the Z parameters.

Table 3-134: Z Parameters

<Parameter>	Description
<value>	0 Set to user profile 0 1 Set to user profile 1 The default value is 0.

Example

```
ATZ0
OK
```

Sleep Mode Commands

When the G24-L is connected using RS232 connection to external device, a sleep mechanism is available. In order to improve the power consumption, the G24-L supports a low-power consumption mode, called "Sleep mode". The G24-L has internal decision conditions for entering and exiting sleep mode. As the terminal and the G24-L operate in a combined system, and as the communication between the G24-L and the terminal must be reliable, there should be a mechanism agreed upon by both the G24-L and the terminal to co-ordinate their separate sleep mode entering and exiting sequences. The G24-L will not enter sleep mode unless the terminal

enables the G24-L sleep mode and signals its readiness for sleep. For this purpose, a set of AT commands and dedicated HW lines are defined.

Note: The Sleep mode feature is not relevant when using USB. In USB mode the G24-L is always awake. While USB is connected, do not use the following:

1. Sleep mode AT commands.
2. Sleep mode dedicated HW line (wake in/wake out).

Sleep Mode AT Commands

The following are the Sleep mode AT commands:

- **ATS24:** Activates/deactivates Sleep mode.
The G24-L receives a request to activate or deactivate Sleep mode.
- **ATS102:** Sets the value of the delay before sending data to the terminal.
The G24-L receives the value that defines the period to wait between sending the wake-up signal, and sending data to the terminal.
- **ATS100:** The minimum time that takes the Terminal to enter sleep mode. Only if this time period passes, the G24-L will wait ATS102 time between wake-up out line and data transmission.
- **AT+MSCTS:** The UART's CTS line control.
The G24-L receives a request to define the behavior of the CTS line when the G24-L is in Sleep mode. It enables or disables activation of the CTS line after wakeup.

Sleep Mode HW Signals

Two HW lines are used:

- One for waking the G24-L (Wakeup-In)
- One for waking the terminal (Wakeup-Out)

Terminal Does Not Wake the G24-L (If the Terminal Uses Hardware Flow Control Only)

When the G24-L is in Sleep mode, the CTS line is also inactive. The terminal does not send any characters to the G24-L if the CTS is inactive, otherwise the character may be lost (Hardware Flow Control).

Terminal Wakes the G24-L Using the Wakeup-In Line

The terminal uses the Wakeup-In line (pin #16) to wake up the G24-L when it wants to send data. When the Wakeup-In line is low, the G24-L will not enter the Sleep mode. If the terminal has data to send while the G24-L is sleeping, it activates the line (brings it to active low), then waits 10 ms (the time required to wake the G24-L). Only then can the terminal start sending data.

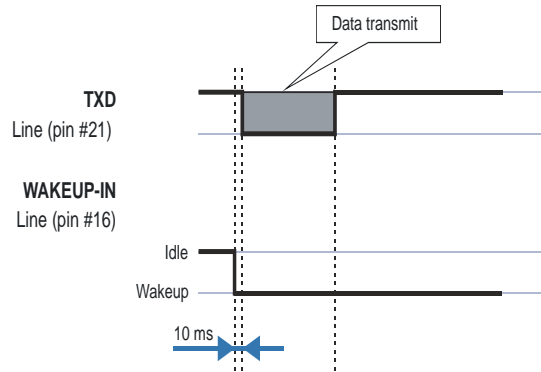

Figure 3-9: Wakeup-In Line

Two modes exist:

- Idle Mode: The terminal has no data to send. If the terminal enables sleep mode (using `ats24`), the G24-L activates its Sleep mode module.
- Wakeup Mode: The G24-L does not enter sleep mode, and the terminal can send data.

Once the terminal changes the line edge to Wakeup mode, it needs a 10 ms delay before sending any data to the G24-L (using the RS232 protocol).

G24-L Wakes the Terminal

- The G24-L follows these steps in order to wake up the terminal:
- The G24-L indicates to the terminal that it has data and that it must wake up. The G24-L uses the Wakeup-Out Line (pin #26) (brings it to active low).
- While the Wakeup Out line is low, the terminal should not enter Sleep mode.
- The terminal should set a value of the delay (in ms) needed for waking it (using the `ATS102` command) before receiving data (default value is 30 ms).

When the data transmission is complete, the G24-L gets the output wakeup line to high.

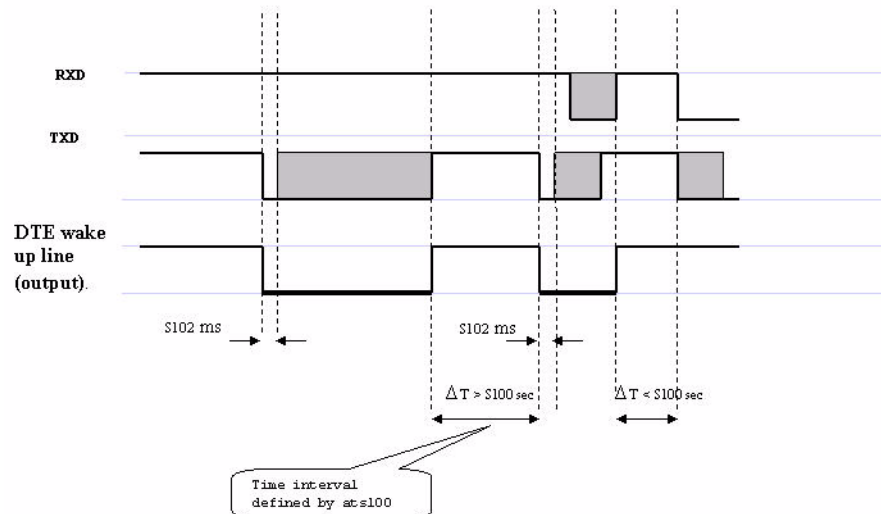

Figure 3-10: Wake up Outline

Two modes exist:

- Idle mode: The G24-L has no data to send.
- Wakeup mode: The G24-L has data to send to the terminal.

After the G24-L changes the line edge to Wakeup mode, there will be a delay (the default is 30 ms) sent by the atS102 command before sending any data to the terminal (using RS232 protocol).

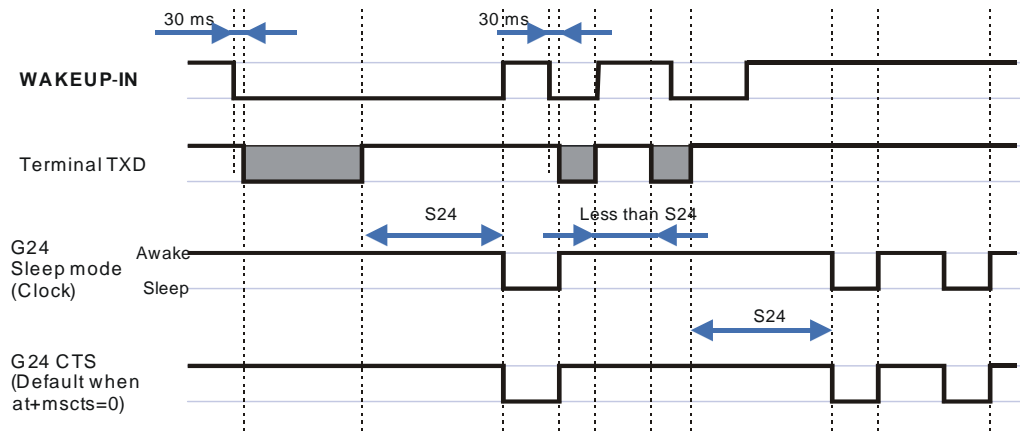

Figure 3-11: Sleep Mode when S24 > 0

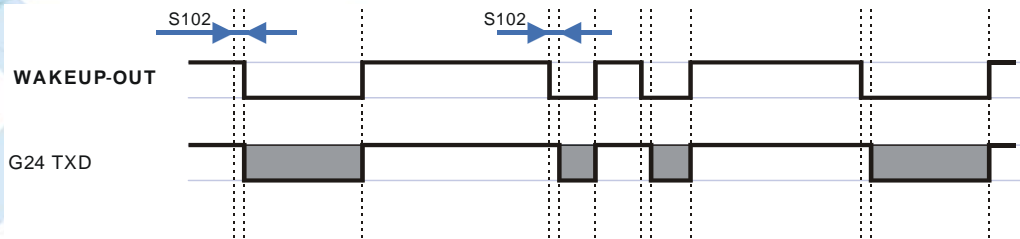

Figure 3-12: G24-L Lines when S24 > 0

S24, Set Number of Seconds Delay Before G24-L Enters Sleep Mode

This command activates/disables the Sleep mode. The terminal sends `ATS24=5`, and if there are no radio and UART activities, the G24-L enters sleep mode in 5 seconds.

If terminal has some indication of the CTS pin activity, it can see:

- If `+MSCTS=0` (default), the line changes its state periodically. (For more information refer to [“+MSCTS, Enable/Disable CTS During Wakeup Period”](#) on page 3-205.)
- If `+MSCTS=1`, the line is switched off at the moment of entering Sleep mode and stays off even if G24-L is awakened.

Command Type	Syntax	Response/Action	Remarks
Set	ATS24=[<value>]	OK	The Set command sets the amount of time, in seconds, the G24-L should wait before entering Sleep mode.
Read	ATS24?	<value> OK	The Read command returns the current value.

The following table shows the S24 parameters.

Table 3-135: S24 Parameters

<Parameter>	Description
<value>	Number of seconds ($0 \leq n \leq 255$) 0 Disable Sleep mode >0 Enable Sleep mode The default value is 0.

Example

```
ATS24? <enter>
000
OK
ATS24=5 <enter>
OK
ATS24? <enter>
005
OK
```

(If there are no radio and UART activities, the G24-L will enter sleep mode in 5 seconds)

S102, Set Delay Before Sending Data to the Terminal

This command sets the value of the delay before sending data to the terminal. Before receiving data, the terminal connected to the G24-L will receive:

- Terminal Wakeup signal (the Wakeup Out Line (pin #26) state will be active low).
- A delay that is equal ATS102 value.
- Data (GPRS, CSD, AT commands' echo and results, unsolicited reports).

Command Type	Syntax	Response/Action	Remarks
Set	ATS102 = <value>	OK	The Set command sets the delay before sending data to the terminal, and defines a period between sending the wakeup signal and sending data to the terminal.
Read	ATS102?	<value> OK	The Read command returns the current value.

The following table shows the S102 parameters.

Table 3-136: S102 Parameters

<Parameter>	Description
<value>	0 <= value <= 255 The default value is 30 ms.

Example

```
ATS102? <enter>
030
OK
ATS102=100 <enter>
OK
ATS102? <enter>
100
OK
```

(This means if there is data for transmission to the terminal, the G24-L drops the Wakeup Out line, waits 100 ms. and then sends data to the terminal.)

S100, Set Minimum Time for Terminal to Fall into Sleep Mode

ATS100 is a terminal minimum time limit for entering sleep mode.

In order to limit the number of interrupts on the DTE side and reduce data sending delay time on our side, G24-L sends wakeup-out pulse when the interval between one burst of sent/received data to the other is bigger than specified in ATS100.

Command Type	Syntax	Response/Action	Remarks
Set	ATS100=<delta>	OK Or +CME ERROR: <err>	The set command sets the terminal minimum time limit for entering sleep mode.
Read	ATS100?	<delta> OK	The Read command returns the current ATS100 value.

Table 3-137: Command parameters

<Parameter>	Description	Remarks
<delta>	Time interval between one burst of sent/received data to the other before the terminal enters sleep mode. 0 : Wakeup out feature isn't active. (default when +S100 set command is never used) 1 - 255: Time in seconds.	This value is saved on power down.

Example

```
ats100?
001
OK
ats100=0
OK
ats100?
000
OK
```

+MSCTS, Enable/Disable CTS During Wakeup Period

This command defines the behavior of the CTS line when the G24-L is in normal mode (not Sleep mode).

The command configures the G24-L CTS line behavior always to follow the flow control requirements, or to follow it only if the terminal initiated a serial transmission session. This saves the terminal from following the CTS interrupt every time the G24-L exits Sleep mode for internal G24-L reasons (non-terminal communication related reasons).

Command Type	Syntax	Response/Action	Remarks
Set	AT+MSCTS=<control>	OK	The Set command tells the G24-L whether to activate the CTS when the unit is awakening.
Read	AT+MSCTS?	+MSCTS: <current control> OK	The Read command returns the current control value.
Test	AT+MSCTS=?	+MSCTS: (list of supported <control>) OK	The Test command returns the possible control values.

The following table shows the +MSCTS parameters.

Table 3-138: +MSCTS Parameters

<Parameter>	Description
<control>	0 In Normal Mode: The CTS is used for Flow Control In Sleep mode: The CTS is inactive. 1 Wakeup In line is Active: The CTS is used for Flow Control. Wakeup In line is Inactive: The CTS is inactive. The default value is 0.

Example

```

AT+MSCTS = ?
+MSCTS: (0-1)
OK
AT+MSCTS?
+MSCTS: 0
OK
AT+MSCTS = 1
OK
ATS102?
1
OK
    
```

Note: This means that by waking up, the CTS line will stay OFF and it can be activated by the Wakeup IN Line interrupt only.

Error Handling Commands

+CMEE, Report Mobile Equipment Error

The Set command disables or enables the use of result code +CME ERROR: <err> as an indication of an error relating to the functionality of the G24-L. When enabled, G24-L-related errors cause a +CME ERROR: <err> final result code instead of the regular ERROR final result code. Usually, ERROR is returned when the error is related to syntax, invalid parameters or terminal functionality.

For all Accessory AT commands besides SMS commands, the +CMEE set command disables or enables the use of result code +CME ERROR: <err> as an indication of an error relating to the functionality of the G24-L. When enabled, G24-L related errors cause a +CME ERROR: <err> final result code instead of the regular ERROR result code.

For all SMS AT commands that are derived from GSM 07.05, the +CMEE Set command disables or enables the use of result code +CMS ERROR: <err> as an indication of an error relating to the functionality of the G24-L. When enabled, G24-L-related errors cause a +CMS ERROR: <err> final result code instead of the regular ERROR final result.

Command Type	Syntax	Response/Action	Remarks
Set	AT+CMEE=[<n>]	OK or: +CME ERROR: <err>	The Set command enables or disables the use of result code +CME ERROR: <err> as an indication of an error relating to the functionality of the G24-L.
Read	AT+CMEE?	+CMEE: <n> OK	The Read command returns the current setting format of the result code.
Test	AT+CMEE=?	+CMEE: (list of supported <n>s) OK	The Test command returns values supported by the terminal as a compound value.

The following table shows the +CMEE parameters.

Table 3-139: +CMEE Parameters

<Parameter>	Description
<n>	<p>0 Disable the +CME ERROR: <err> result code and use ERROR.</p> <p>1 Enable the +CME ERROR: <err> or +CMS ERROR: <err> result codes and use numeric <err> values or +STK ERROR: <err> result codes and use numeric <err> values.</p> <p>2 Enable the +CME ERROR: <err> or +CMS ERROR: <err> result codes and use verbose <err> values or +STK ERROR: <err> result codes and use numeric <err> values.</p> <p>The default value is 0.</p>

Table 3-140: +CME Errors

<Parameter>	Description
<err>	Numeric format followed by verbose format: 0, "phone failure" 1, "no connection to phone" 2, "phone-adaptor link reserved" 3, "operation not allowed" 4, "operation not supported" 5, "PH-SIM PIN required" 6, "PH-FSIM PIN required" 7, "PH-FSIM PUK required" 10, "SIM not inserted" 11, "SIM PIN required" 12, "SIM PUK required" 13, "SIM failure" 14, "SIM busy" 15, "SIM wrong" 16, "incorrect password" 17, "SIM PIN2 required" 18, "SIM PUK2 required" 20, "memory full" 21, "invalid index" 22, "not found" 23, "memory failure" 24, "text string too long" 25, "invalid characters in text string" 26, "dial string too long" 27, "invalid characters in dial string" 30, "no network service" 31, "network timeout" 32, "network not allowed - emergency calls only" 33, "command aborted" 34, "numeric parameter instead of text parameter" 35, "text parameter instead of numeric parameter" 36, "numeric parameter out of bounds" 37, "text string too short" 40, "network personalization PIN required" 41, "network personalization PUK required" 42, "network subset personalization PIN required" 43, "network subnet personalization PUK required" 44, "service provider personalization PIN required" 45, "service provider personalization PUK required" 46, "corporate personalization PIN required" 47, "corporate personalization PUK required" 60, "SIM service option not supported" 100, "unknown" 103, "Illegal MS (#3)" 106, "Illegal ME (#6)" 107, "GPRS services not allowed (#7)"

Table 3-140: +CME Errors (Cont.)

<Parameter>	Description
<err> Continued	111, "PLMN not allowed (#11)" 112, "Location area not allowed (#12)" 113, "Roaming not allowed in this location area (#13)" 132, "service option not supported (#32)" 133, "requested service option not subscribed (#33)" 134, "service option temporarily out of order (#34)" 147, "long context activation" 151, "GPRS disconnection timer is active" 149, "PDP authentication failure" 150, "invalid mobile class" 148, "unspecified GPRS error" 256, "too many active calls" 257, "call rejected" 258, "unanswered call pending" 259, "unknown calling error" 260, "no phone num recognized" 261, "call state not idle" 262, "call in progress" 263, "dial state error" 264, "unlock code required" 265, "network busy" 266, "Invalid phone number" 267, "Number Entry already started" 268, "Cancelled by user" 269, "Number Entry could not be started" 280, "Data lost" 281, "Invalid message body length" 282, "inactive socket" 283, "socket already open"

Note: +CME ERROR:280, Data lost, is sent to the terminal in extreme cases when the G24-L has to transmit data to the terminal and the buffers are full (Flow control Xoff status). This error occurs when:

- An unsolicited indication (such as RING, +CLCC and so on) encounters the Xoff status. When the flow control status returns to Xon, Error 280, Data lost, is sent to the terminal instead of the unsolicited indication.
- An initiated AT command is waiting for a response, and the response encounters the Xoff status.

When the flow control status returns to Xon, the AT command is aborted (if not yet aborted) and Error 280, Data lost is sent to the terminal instead of OK (and the missing data).

Table 3-141: +CMS Errors

<Parameter>	Description
<err>	Numeric format followed by verbose format: 1, "Unassigned (unallocated) number" 8, "Operator determined barring" 10, "Call barred" 21, "Short message transfer rejected" 27, "Destination out of service" 28, "Unidentified subscriber" 29, "Facility rejected" 30, "Unknown subscriber" 38, "Network out of order" 41, "Temporary failure" 42, "Congestion" 47, "Resources unavailable, unspecified" 50, "Requested facility not subscribed" 69, "Requested facility not implemented" 81, "Invalid short message transfer reference value" 95, "Invalid message, unspecified" 96, "Invalid mandatory information" 97, "Message type non-existent or not implemented" 98, "Message not compatible with short message protocol state" 99, "Information element non-existent or not implemented" 111, "Protocol error, unspecified" 127, "Interworking, unspecified" 128, "Telematic interworking not supported" 129, "Short message Type 0 not supported" 130, "Cannot replace short message" 143, "Unspecified TP-PID error" 144, "Data coding scheme (alphabet) not supported" 145, "Message class not supported" 159, "Unspecified TP-DCS error" 160, "Command cannot be actioned" 161, "Command unsupported" 175, "Unspecified TP-Command error" 176, "TPDU not supported" 192, "SC busy" 193, "No SC subscription" 194, "SC system failure" 195, "Invalid SME address" 196, "Destination SME barred" 197, "SM Rejected-Duplicate SM" 198, "TP-VPF not supported" 199, "TP-VP not supported" 208, "SIM SMS storage full" 209, "No SMS storage capability in SIM" 210, "Error in MS" 211, "Memory Capacity Exceeded" 213, "SIM Data Download Error" 255, "an unspecified error" 300, "ME failure"

Table 3-141: +CMS Errors (Cont.)

<Parameter>	Description
<err> <i>Continued</i>	301, "SMS service of ME reserved" 302, "operation not allowed" 303, "operation not supported" 304, "invalid PDU mode parameter" 305, "invalid text mode parameter" 310, "SIM not inserted" 311, "SIM PIN required" 312, "PH-SIM PIN required" 313, "SIM failure" 314, "SIM busy" 315, "SIM wrong" 316, "SIM PUK required" 317, "SIM PIN2 required" 318, "SIM PUK2 required" 320, "memory failure" 321, "invalid memory index" 322, "memory full" 330, "SMSC address unknown" 331, "no network service" 332, "network timeout" 340, "no +CNMA acknowledgement expected" 500, "unknown error" 512, "network busy" 513, "invalid destination address" 514, "invalid message body length" 515, "phone is not in service" 516, "invalid preferred memory storage" 517, "user terminated"

Table 3-142: +STK Errors

<Parameter>	Description
<err>	Numeric format followed by verbose format: 700, "SIM ToolKit not available" 701, "cannot sustain both call and SIM application"

Example

```

AT+CMEE=0                //+CME ERROR is not used
OK
AT+VTD
ERROR
AT+CMEE=1                //Use numeric <err>
OK
AT+VTD
+CME ERROR: 1
AT+CMEE=2                //Use verbose <err>
OK

```

AT+VTD
+CME ERROR: operation not supported

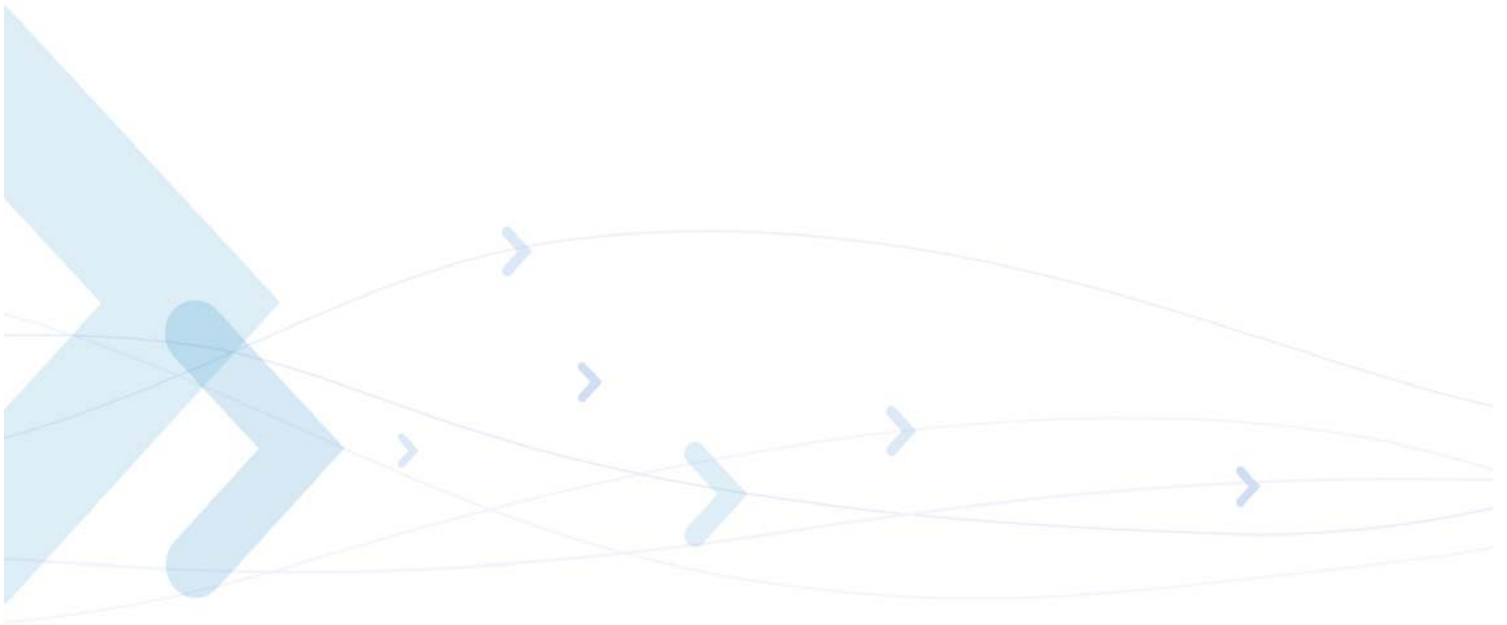

+CEER, Extended Error Report

This execution command returns an extended error report containing one or more lines of information text <report>, determined by the manufacturer, providing reasons for the following errors:

- Failure in the last unsuccessful call setup (originating or answering) or the in-call modification.
- Last call release.

Typically, the text consists of a single line containing the reason for the error according to information given by GSM network, in textual format.

Command Type	Syntax	Response/Action
Set	AT+CEER=[<n>]	OK
Execute	AT+CEER	+CEER: <report> OK
Read	AT+CEER?	+CEER: <n> OK
Test	AT+CEER=?	+CEER: (List of supported <n>s) OK

The following table shows the +CEER parameters.

Table 3-143: +CEER Parameters

<Parameter>	Description
<n>	1 Returns numeric response. 2 Returns verbose response. The default value is 2.
<report>	The total number of characters and line terminators (up to 2041) in the information text. The text must not contain the sequence 0<CR> or OK<CR>. Numeric format followed by verbose format: 1 Unassigned or unallocated number 3 No route to destination 6 Channel unacceptable 8 Operator determined barring 16 Normal call clearing 17 User busy 18 No user responding 19 User alerting, no answer 21 Call rejected 22 Number changed 26 Non selected user clearing 27 Destination out of order 28 Invalid number format (incomplete number) 29 Facility rejected 30 Response to STATUS ENQUIRY 31 Normal, unspecified 34 No circuit/channel available 38 Network out of order 41 Temporary failure 42 Switching equipment congestion 43 Access information discarded 44 Requested circuit/channel not available

Table 3-143: +CEER Parameters (Cont.)

<Parameter>	Description
<report> (continued)	47 Resources unavailable, unspecified 49 Quality of service unavailable 50 Requested facility not subscribed 55 Incoming calls barred within the CUG 57 Bearer capability not authorized 58 Bearer capability not presently available 63 Service or option not available, unspecified 65 Bearer service not implemented 69 Requested facility not implemented 70 Only restricted digital information bearer capability is available 79 Service or option not implemented, unspecified 81 Invalid transaction identifier value 87 User not member of CUG 88 Incompatible destination 91 Invalid transit network selection 95 Semantically incorrect message 96 Invalid mandatory information 97 Message type non-existent or not implemented 98 Message type not compatible with protocol state 99 Information element non-existent or not implemented 100 Conditional IE error 101 Message not compatible with protocol state 102 Recovery on timer expiry 111 Protocol error, unspecified 127 Interworking, unspecified

Example

```

At+CEER
+CEER: "No information available"
OK
AT+CEER?
+CEER:2
OK
AT+CEER=?
+CEER: (001-002)
OK

```

UI (User Interface)

+CRSM, Restricted SIM Access

This command provides limited access to the Elementary Files on the SIM. Access to the SIM database is restricted to the commands which are listed at <command>. All parameters of AT+CRSM are used as specified by GSM 11.11 version 8.7.0. As response to the command, the G24-L sends the actual SIM information parameters and response data. Error result code "+CME ERROR" may be returned if the command cannot be transferred to the SIM, e.g. if the SIM is not inserted, or defected, or PIN1/PUK authentication required, or required input parameters not present. However, failure in the execution of the command in the SIM is reported in <sw1> and <sw2> parameters.

Some of the AT+CRSM commands require PIN/PIN2 authentication.

Command Type	Syntax	Response/Action	Remarks
Set	AT+CRSM=<command>,[<file_id>[,<P1>,<P2>,<P3>[,<data>]]]	+CRSM: <sw1>,<sw2>[,<response>] OK or: +CME ERROR: <err>	Set command transmits the SIM <command> and its required parameters to the ME. ME sends the actual SIM information parameters and response data.
Test	AT+CRSM=?	+CRSM: (list of supported <command>s), (possible <file_id>s range value), (possible <P1> range value), (possible <P2> range value), (possible <P3>range value), OK or: +CME ERROR: <err>	The test command returns the possible ranges of CRSM parameters.

The following table shows the +CRSM parameters.

Table 3-144: +CRSM Parameters

<Parameter>	Description
<command>	Integer type. Command passed on by the ME to the SIM. 176 Read BINARY 178 Read RECORD 192 Get RESPONSE 214 Update BINARY 220 Update RECORD 242 STATUS
<file_id>	Integer type. This is the identifier of a elementary data file on SIM. Mandatory for every <command> except of STATUS.

Table 3-144: +CRSM Parameters (Cont.)

<Parameter>	Description
<p><P1>, <P2>, <P3></p>	<p>Integer type. Parameters passed on by the ME to the SIM. These parameters are mandatory for every command, except GET RESPONSE and STATUS.</p> <p>READ BINARY</p> <p><P1> Offset high (0...255) <P2> Offset low (0...255) <P3> Length (0...255)</p> <p>READ BINARY</p> <p><P1> Rec. No. (0...255) <P2> Mode "02" = next record "03" = previous record "04" = absolute mode/current mode, the record number is given in P1 with P1='00' denoting the current record. <P3> Length (0...255)</p> <p>GET RESPONSE</p> <p><P1> "00" <P2> "00" <P3> Length (0...255)</p> <p>UPDATE BINARY</p> <p><P1> Offset high (0...255) <P2> Offset low (0...255) <P3> Length (0...255)</p> <p>UPDATE RECORD</p> <p><P1> Rec. No. (0...255) <P2> Mode "02" = next record "03" = previous record "04" = absolute mode/current mode, the record number is given in P1 with P1='00' denoting the current record. <P3> Length (0...255)</p> <p>STATUS</p> <p><P1> "00" <P2> "00" <P3> Length (0...255)</p>
<p><data></p>	<p>Information which shall be written to the SIM (hexadecimal character format). Mandatory for UPDATE BINARY and UPDATE RECORD.</p>

Table 3-144: +CRSM Parameters (Cont.)

<Parameter>	Description																																																						
<sw1> <sw2>	<p>Integer character format. Information, from the SIM, about the execution of the actual command. These parameters are delivered to the TE in both cases, on successful or failed execution of the command.</p> <p>Responses to commands which are correctly executed:</p> <table border="1" data-bbox="623 470 1398 779"> <thead> <tr> <th data-bbox="623 470 753 520"><sw1></th> <th data-bbox="753 470 867 520"><sw2></th> <th data-bbox="867 470 1398 520">Description</th> </tr> </thead> <tbody> <tr> <td data-bbox="623 520 753 562">144</td> <td data-bbox="753 520 867 562">0</td> <td data-bbox="867 520 1398 562">Normal ending of the command</td> </tr> <tr> <td data-bbox="623 562 753 663">145</td> <td data-bbox="753 562 867 663">XX</td> <td data-bbox="867 562 1398 663">Normal ending of the command, with extra information from the proactive SIM, containing a command for the ME. Length 'XX' of the response data.</td> </tr> <tr> <td data-bbox="623 663 753 735">158</td> <td data-bbox="753 663 867 735">XX</td> <td data-bbox="867 663 1398 735">Length 'XX' of the response data given in case of a SIM data download error.</td> </tr> <tr> <td data-bbox="623 735 753 779">159</td> <td data-bbox="753 735 867 779">XX</td> <td data-bbox="867 735 1398 779">Length 'XX' of the response data.</td> </tr> </tbody> </table> <p>Responses to commands which are postponed:</p> <table border="1" data-bbox="623 884 1398 1717"> <thead> <tr> <th data-bbox="623 884 753 934"><sw1></th> <th data-bbox="753 884 867 934"><sw2></th> <th data-bbox="867 884 1398 934">Error Description</th> </tr> </thead> <tbody> <tr> <td data-bbox="623 934 753 1005">147</td> <td data-bbox="753 934 867 1005">0</td> <td data-bbox="867 934 1398 1005">SIM Application Toolkit is busy. Command cannot be executed at present, further normal commands are allowed.</td> </tr> <tr> <td data-bbox="623 1005 753 1077">146</td> <td data-bbox="753 1005 867 1077">0X</td> <td data-bbox="867 1005 1398 1077">Command successful but after using an internal update retry routine 'X' times.</td> </tr> <tr> <td data-bbox="623 1077 753 1119">146</td> <td data-bbox="753 1077 867 1119">64</td> <td data-bbox="867 1077 1398 1119">Memory problem.</td> </tr> <tr> <td data-bbox="623 1119 753 1161">148</td> <td data-bbox="753 1119 867 1161">0</td> <td data-bbox="867 1119 1398 1161">No EF selected.</td> </tr> <tr> <td data-bbox="623 1161 753 1203">148</td> <td data-bbox="753 1161 867 1203">2</td> <td data-bbox="867 1161 1398 1203">Out of range (invalid address).</td> </tr> <tr> <td data-bbox="623 1203 753 1274">148</td> <td data-bbox="753 1203 867 1274">4</td> <td data-bbox="867 1203 1398 1274"> <ul style="list-style-type: none"> • File ID not found. • Pattern not found. </td> </tr> <tr> <td data-bbox="623 1274 753 1316">148</td> <td data-bbox="753 1274 867 1316">8</td> <td data-bbox="867 1274 1398 1316">File is inconsistent with the command</td> </tr> <tr> <td data-bbox="623 1316 753 1358">152</td> <td data-bbox="753 1316 867 1358">2</td> <td data-bbox="867 1316 1398 1358">No CHV initialized</td> </tr> <tr> <td data-bbox="623 1358 753 1493">152</td> <td data-bbox="753 1358 867 1493">4</td> <td data-bbox="867 1358 1398 1493"> <ul style="list-style-type: none"> • Access condition not fulfilled. • Unsuccessful CHV verification, at least one attempt left. • Unsuccessful UNBLOCK CHV verification, at least one attempt left. • Authentication failed. </td> </tr> <tr> <td data-bbox="623 1493 753 1535">152</td> <td data-bbox="753 1493 867 1535">8</td> <td data-bbox="867 1493 1398 1535">In contradiction with CHV status.</td> </tr> <tr> <td data-bbox="623 1535 753 1577">152</td> <td data-bbox="753 1535 867 1577">16</td> <td data-bbox="867 1535 1398 1577">In contradiction with invalidation status.</td> </tr> <tr> <td data-bbox="623 1577 753 1717">152</td> <td data-bbox="753 1577 867 1717">64</td> <td data-bbox="867 1577 1398 1717"> <ul style="list-style-type: none"> • Unsuccessful CHV verification, no attempt left. • Unsuccessful UNBLOCK CHV verification, no attempt left. • CHV blocked. • UNBLOCK CHV blocked. </td> </tr> </tbody> </table>	<sw1>	<sw2>	Description	144	0	Normal ending of the command	145	XX	Normal ending of the command, with extra information from the proactive SIM, containing a command for the ME. Length 'XX' of the response data.	158	XX	Length 'XX' of the response data given in case of a SIM data download error.	159	XX	Length 'XX' of the response data.	<sw1>	<sw2>	Error Description	147	0	SIM Application Toolkit is busy. Command cannot be executed at present, further normal commands are allowed.	146	0X	Command successful but after using an internal update retry routine 'X' times.	146	64	Memory problem.	148	0	No EF selected.	148	2	Out of range (invalid address).	148	4	<ul style="list-style-type: none"> • File ID not found. • Pattern not found. 	148	8	File is inconsistent with the command	152	2	No CHV initialized	152	4	<ul style="list-style-type: none"> • Access condition not fulfilled. • Unsuccessful CHV verification, at least one attempt left. • Unsuccessful UNBLOCK CHV verification, at least one attempt left. • Authentication failed. 	152	8	In contradiction with CHV status.	152	16	In contradiction with invalidation status.	152	64	<ul style="list-style-type: none"> • Unsuccessful CHV verification, no attempt left. • Unsuccessful UNBLOCK CHV verification, no attempt left. • CHV blocked. • UNBLOCK CHV blocked.
<sw1>	<sw2>	Description																																																					
144	0	Normal ending of the command																																																					
145	XX	Normal ending of the command, with extra information from the proactive SIM, containing a command for the ME. Length 'XX' of the response data.																																																					
158	XX	Length 'XX' of the response data given in case of a SIM data download error.																																																					
159	XX	Length 'XX' of the response data.																																																					
<sw1>	<sw2>	Error Description																																																					
147	0	SIM Application Toolkit is busy. Command cannot be executed at present, further normal commands are allowed.																																																					
146	0X	Command successful but after using an internal update retry routine 'X' times.																																																					
146	64	Memory problem.																																																					
148	0	No EF selected.																																																					
148	2	Out of range (invalid address).																																																					
148	4	<ul style="list-style-type: none"> • File ID not found. • Pattern not found. 																																																					
148	8	File is inconsistent with the command																																																					
152	2	No CHV initialized																																																					
152	4	<ul style="list-style-type: none"> • Access condition not fulfilled. • Unsuccessful CHV verification, at least one attempt left. • Unsuccessful UNBLOCK CHV verification, at least one attempt left. • Authentication failed. 																																																					
152	8	In contradiction with CHV status.																																																					
152	16	In contradiction with invalidation status.																																																					
152	64	<ul style="list-style-type: none"> • Unsuccessful CHV verification, no attempt left. • Unsuccessful UNBLOCK CHV verification, no attempt left. • CHV blocked. • UNBLOCK CHV blocked. 																																																					

Table 3-144: +CRSM Parameters (Cont.)

<Parameter>	Description																					
	<table border="1"> <thead> <tr> <th data-bbox="521 380 646 426"><sw1></th> <th data-bbox="646 380 771 426"><sw2></th> <th data-bbox="771 380 1299 426">Error Description</th> </tr> </thead> <tbody> <tr> <td data-bbox="521 426 646 472">152</td> <td data-bbox="646 426 771 472">80</td> <td data-bbox="771 426 1299 472">Increase cannot be performed, Max value reached.</td> </tr> <tr> <td data-bbox="521 472 646 573">103</td> <td data-bbox="646 472 771 573">XX</td> <td data-bbox="771 472 1299 573">Incorrect parameter P3 (NOTE: 'XX' gives the correct length or states that no additional information is given ('XX' = '00')).</td> </tr> <tr> <td data-bbox="521 573 646 619">107</td> <td data-bbox="646 573 771 619">XX</td> <td data-bbox="771 573 1299 619">Incorrect parameter P1 or P2.</td> </tr> <tr> <td data-bbox="521 619 646 665">109</td> <td data-bbox="646 619 771 665">XX</td> <td data-bbox="771 619 1299 665">Unknown instruction code given in the command.</td> </tr> <tr> <td data-bbox="521 665 646 711">110</td> <td data-bbox="646 665 771 711">XX</td> <td data-bbox="771 665 1299 711">Wrong instruction class given in the command.</td> </tr> <tr> <td data-bbox="521 711 646 758">111</td> <td data-bbox="646 711 771 758">XX</td> <td data-bbox="771 711 1299 758">Technical problem with no diagnostic given.</td> </tr> </tbody> </table>	<sw1>	<sw2>	Error Description	152	80	Increase cannot be performed, Max value reached.	103	XX	Incorrect parameter P3 (NOTE: 'XX' gives the correct length or states that no additional information is given ('XX' = '00')).	107	XX	Incorrect parameter P1 or P2.	109	XX	Unknown instruction code given in the command.	110	XX	Wrong instruction class given in the command.	111	XX	Technical problem with no diagnostic given.
<sw1>	<sw2>	Error Description																				
152	80	Increase cannot be performed, Max value reached.																				
103	XX	Incorrect parameter P3 (NOTE: 'XX' gives the correct length or states that no additional information is given ('XX' = '00')).																				
107	XX	Incorrect parameter P1 or P2.																				
109	XX	Unknown instruction code given in the command.																				
110	XX	Wrong instruction class given in the command.																				
111	XX	Technical problem with no diagnostic given.																				
<response>	Response of a successful completion of the command previously issued (hexadecimal character uppercase format). STATUS and GET RESPONSE return data, which gives information about the current elementary data file_id. This information includes the type of file and its size (refer to GSM 11.11). After READ BINARY or READ RECORD command the requested data will be returned. <response> is not returned after a successful UPDATE BINARY or UPDATE RECORD command.																					

Example

```

AT+CRSM=176,28478,0,0,20 //READ BINARY, GID1(6F3E),0 ,0 , 20 bytes

+CRSM: 144,0,FFFFFFFF //Generic success code, 20 bytes of file data
FFFFFFFF000000000000000000000000
OK

AT+CRSM=178,28474,1,4,26 //READ RECORD, ADN file(6F3A) data, 1, current, 26 bytes
+CRSM: 144,0,72656EFFFFFFFFFFFFFFFF06818984143243FFFFFFFFFFFFFFF
//Generic success code, 26 bytes data of the 1st record

OK
AT+CRSM=192,12258 //GET RESPONSE, ICCID(2fe2)

+CRSM: 144,0,0000000A2FE204000B00BB01020000
//Generic success code, 0000-> RFU 000A->File size 2FE2-> File ID
04-> Type of the file (EF) 00->RFU 0B00BB->Access conditions (READ=0-ALW, UPDATE=B-NEVER)
01->File status 02->Length of the following data (byte 14 to the end) 00->Structure of EF (transparent)
00->Length of a record (For cyclic and linear fixed EFs this byte denotes the length of a record. For a
transparent EF, this byte shall be coded '00')

OK

AT+CRSM=214,28498,0,0,8,C69018C7958C87
//UPDATE BINARY, KcGPRS(6F52), 0,0, 8 bytes , data to be write to
the file
    
```

```

+CRSM: 152,4 //Error: access condition not fulfilled
OK

AT+CRSM=220,28474,1,4,30,
657469FFFFFFFFFFFFFFFFFFFFFFFFFFFFFFFFFFFFFFFFFFFFFFFFFFFFFFFF
//UPDATE RECORD, ADN file(6F3A), 1sh record, current, 30 bytes
data

+CRSM: 144,0 //Generic success code
OK

AT+CRSM=242,28589 //STATUS (6fad)

+CRSM: 144,0,000060907F200200000000000991001C080085858585
//Generic success code, 0000-> RFU 6090-> Total amount of memory
of the selected directory which is not allocated to any of the DFs or EFs under the selected directory.
7F20->File_id 02-> Type of file - DF 0000000000-> RFU 09-> Length of the following data.
91001C080085858585->GSM specific data
OK

AT+CRSM=? //Test Command

+CRSM=
(176,178,192,214,220,242),(12037-28599),(0-255),(0-255),(0-255)
//Possible values

```

&V, View Configuration

Command Type	Syntax	Response/Action	Remarks
Execute	&V	ACTIVE PROFILE: ... (profile data) STORED PROFILE 0: ... (profile data) STORED PROFILE1: ... (profile data) OK or +CME ERROR: <err>	The Execute command displays the current active configuration and stored user profiles.

Example

```

at&v
ACTIVE PROFILE:
E1 Q0 V1 X4 &C1 &D2 &K3 &Y0
S00:000 S01:000 S02:043 S03:013 S04:010 S05:008 S06:004 S07:050
S08:004 S09:006 S10:014 S12:040 S14:AAH S16:80H S18:000 S21:30H
S22:F6H S23:1BH S25:005 S26:001 S27:09H
STORED PROFILE 0:
E1 Q0 V1 X4 &C1 &D2 &K3
S00:000 S02:043 S03:013 S04:010 S05:008 S07:050 S12:040
STORED PROFILE 1:
E1 Q0 V1 X4 &C1 &D2 &K3
S00:000 S02:043 S03:013 S04:010 S05:008 S07:050 S12:040
OK
    
```

&W, Store User Profile

Command Type	Syntax	Response/Action	Remarks
Set	&W[<n>]	OK or: +CME ERROR: <err>	The Set command stores the current active configuration to user profile 0 or 1.

The following table shows the &W parameters.

Table 3-145: &W Parameters

<Parameter>	Description
<n>	User's profile number: 0 Store to user's profile 0 1 Store to user's profile 1 The default value is 0.

The parameters that are set in a profile are described in the table below.

Table 3-146: Profile Parameters

Profile Parameter	Description	Parameter Range	Default Value	Length in Bits
ATE	Echo	0-1	1	1
ATQ	Result code return mode	0-1	0	1
ATV	Display result code	0-1	1	1
ATX	Select result code	0-4	0	3

Table 3-146: Profile Parameters (Cont.)

Profile Parameter	Description	Parameter Range	Default Value	Length in Bits
AT&C	Set circuit 109 (DCD) behavior	0-2	1	2
AT&D	Set circuit 109 (DTR) behavior	0-4	2	3
AT&K	Flow control	0, 3-6	3	3
AT&Y	Power-up profile	0-1	0	1
S0	Auto-answer	0-255	0	8
S2	Escape code character	0-255	43	8
S3	Carriage return character	0-127	13	7
S4	Line feed character	0-127	10	7
S5	Backspace character	0-32	8	6
S7	Wait time for carrier. Register S7 tells the data adaptor how many seconds to wait for a remote data adaptor's carrier signal before hanging up. The register value can be increased if the data adaptor does not detect a carrier within the specified time. If the data adaptor detects a remote carrier signal within the specified time, it sends a CONNECT response and enters Data mode. If it does not detect a remote carrier signal within the specified time, it sends the NO ANSWER (or 8) response, hangs up, and returns to the Command Mode.	1-255	30	8
S 12	Time, in 50ths of a second, until OK is displayed after entering command mode by an escape sequence.	0-255	20	8

Example

```

AT&W0
OK
AT&W1
OK

```

&Y, Default User Profile

Command Type	Syntax	Response/Action
Set	&Y<n>	OK or: +CME ERROR: <err>

The following table shows the &Y parameters.

Table 3-147: &Y Parameters

<Parameter>	Description
<n>	User's profile number: 0 Selects power-up configuration to user's profile 0 1 Selects power-up configuration to user's profile 1 The default value is 0.

Example

```
AT&Y0
OK
AT&Y1
OK
```

+CMER, Mobile Equipment Event Reporting

Command Type	Syntax	Response/Action	Remarks
Set	+CMER=[<mode> [,<keyp>[,<disp> [,<ind>[,<bfr>]]]]]	OK or: +CME ERROR: <err>	The Set command enables/disables an external accessory to receive event reports from the G24-L. In some cases, this is used to track the user activity for redisplay on a vehicle system, or to perform accessory-specific menu operations.
Read	+CMER?	+CMER: <mode>,<keyp>,<disp>,<ind>,<bfr> OK or: +CME ERROR: <err>	The Read command queries the current settings for the AT+CMER command.
Test	+CMER=?	+CMER: (list of supported <mode>s),(list of supported <keyp>s),(list of supported <disp>s),(list of supported <ind>s),(list of supported <bfr>s)	The Test command returns the possible <mode>, <keyp>, <disp>, <ind>, and <bfr> values.

The following table shows the +CMER parameters.

Table 3-148: +CMER Parameters

<Parameter>	Description
<mode>	Controls the processing of unsolicited result codes specified within this command. 0 Buffer unsolicited result codes in G24-L
<keyp>	Reserved for future implementation.
<disp>	Reserved for future implementation.
<ind>	0 No indicator events reporting. 1 Indicator event +CIEV: <ind>,<value>. <ind> shows the indicator order number and <value> is new value of indicator. The default value is 0.
<bfr>	Controls the effect on buffered codes. 0 Clear buffer.

+CLAN, ME Language

This command handles the selection of language in the ME.

The <code> parameter is a two-letter abbreviation of the language. The language codes, as defined in ISO 639, consist of two characters, e.g. "DE", "EN" etc.

Command Type	Syntax	Response/Action	Remarks
Set	AT+CLAN=<code>	OK or: ERROR	Set command sets the selected language.
Read	AT+CLAN?	+CLAN: <code>	The read command displays the currently selected language.
Test	AT+CLAN=?	+CLAN: (list of <code>s)	Test command displays list of supported language <code>s.

The following table shows the +CLAN parameters.

Table 3-149: +CLAN Parameters

<code>	Description
DE	German
EN	English
IT	Italian
FR	French
ES	Spanish
NL	Dutch
SW	Swedish
DA	Danish
PT	Portoguese
FI	Finnish
NO	Norwegian
EL	Greek
TR	Turkish

Example

```

AT+CLAN?
+CLAN: "EN"
OK
AT+CLAN=?
+CLAN: "DE","EN","IT","FR","ES","NL","SW","DA","PT","FI","NO","EL","TR"
OK
    
```

```

AT+CLAN="DE"
OK
AT+CLAN?
+CLAN: "DE"
OK

```

+CIND, Indicator Control

This command is used to query the status of various ME indicators.

Command Type	Syntax	Response/Action	Remarks
Read	AT+CIND?	+CIND:<ind>,<ind>....	Read command returns the status of ME indicators.
Test	AT+CIND=?	+CIND :(<descr>,(list of supported <ind>s)) ,(<descr>,(list of supported<ind>s))...	Test command returns pairs, where string value <descr> is a short description of the indicator and compound value is the allowed values for the indicator.

The following table shows the +CIND parameters.

Table 3-150: +CIND Parameters

<Parameter>	Description
<service>	0 Service not available. 1 Service available.
<call>	0 No call in progress. 1 Call in progress.
<recsms>	0 No unread messages. 1 Unread messages exist.
<roam>	0 ME is camped on a home network. 1 ME is roaming on home network. 2 ME is roaming on other network.
<signal>	0 ME has no service. 1 ME has 1 bar of signal strength. 2 ME has 2 bars of signal strength. 3 ME has 3 bars of signal strength. 4 ME has 4 bars of signal strength. 5 ME has 5 bars of signal strength.
<simav>	0 No SIM card available. 1 SIM card is inserted.
<smsfull>	0 SMS storage is not full. 1 SMS storage is full.

Example

```
AT+CIND=?  
+CIND:  
("service",(0,1)),("call",(0,1)),("recmsg",(0,1)),("simav",(0,1)),("Roam",(0-2)),("signal",(0-5)),("smsfull",  
(0,1))  
OK  
AT+CIND?  
+CIND: 1,0,0,1,0,5,0  
OK  
ATD 035684469;  
OK  
CONNECT  
AT+CIND?  
+CIND: 1,1,0,1,0,5,0  
OK
```



Unsolicited UI Status Messages

Certain actions performed in the G24-L UI by the user are transmitted to all attached accessories, primarily as a notification of a change in state. For example, notification of a phone-book storage, recall operation or setting a call restriction level. These messages are required by certain accessories to maintain local information, or to provide additional information on an auxiliary display.

+CIEV, Indicator Event Reporting

When a G24-L indication is changed and the <ind> parameter of the +CMER command is set to 1, the +CIEV indication is sent to the DTE.

Unsolicited Report

+CIEV: <ind>,<value>

The following table shows the +CIEV parameters.

Table 3-151: +CIEV Parameters

<ind>	Description	<value> Range	Explanation
0	Battery indicator	0-3	0 Low battery 3 Full battery
1	Signal bars	0-5	0 No signal 1 Low signal strength 5 High signal strength
2	Service availability	0/1	0 Service available 1 Service not available
3	Unread message indication	0/1	0 No unread messages 1 Unread messages exist
4	Call in progress	0/1	0 Call not in progress 1 Call in progress
5	Roaming indicator	0/1	0 Not roaming 1 Roaming
6	SIM Pin 1 requested	0/1	0 SIM pin ready 1 SIM pin required
7	SIM SMS full	0/1	0 SIM SMS storage is not full 1 SIM SMS storage is full
8	GPRS coverage	0-2	0 No GPRS coverage 1 GPRS coverage 2 EDGE coverage Note: GPRS/EDGE coverage will be detected only when SIM has GPRS ability.
12	SIM insertion/removal indication	0/1	0 SIM card removed from phone 1 SIM card inserted into phone

GPRS

GPRS Functionality

GSM 07.07 defines commands that a TE may use to control a GPRS ME via a non-multiplexed character-stream interface. This places certain limitations on the functionality of the interface. For example, it is not possible for the ME to send control information to the TE or for the TE to send commands to the ME whilst the interface is in the online data state, unless the layer 2 protocol itself supports this feature (GSM 07.60-12). However, G24-L-specific escape mechanism (DTR) is provided to enable the TE to switch the G24-L into limited online command state.

The G24-L-specific escape mechanism use DTR as an escape signal (following &D parameters) and designed for limited non network related commands. This specific mechanism purpose is to give the user a way to retrieve the signal strength. The time limit of consecutive DTR toggles is a minimum of 90 seconds. The G24-L-specific is not designed to support online command and data states both at the same time, therefore any wrong or extreme usage can cause unexpected behaviors. The basic GPRS concept is be “always connected” and there is no charge for being connected (only per real data transferred).

GPRS Commands

This section defines commands that a terminal may use to control a GPRS ME. GPRS MTs vary widely in functionality. A class A ME might support multiple PDP-types as well as circuit-switched data, and use multiple external networks QoS profiles. At the other extreme, a class C ME might support only a single PDP-type using a single external network, and rely on the HLR to contain the PDP context definition. A comprehensive set of GPRS-specific commands is defined below to provide the flexibility needed by the more complex ME. The commands are designed to be expandable to accommodate new PDP types and interface protocols, merely by defining new values for many of the parameters. Multiple contexts may be activated if the interface link-layer protocol is able to support them. The commands use the extended information and error message capabilities described in this specification. For MTs of intermediate complexity, most commands have simplified forms where certain parameters may be omitted. For the simplest MTs, and for backwards compatibility with existing communications software, it is possible to control access to the GPRS using existing modem-compatible commands. This "modem compatible" mode of operation is described below.

+CGCLASS, GPRS Mobile Station Class

This command is used to set the G24-L to operate according to the specified GPRS mobile class. If the requested class is not supported, an ERROR or +CME ERROR response is returned. Extended error responses are enabled by the +CMEE command.

Command Type	Syntax	Response/Action	Remarks
Read	AT +CGCLASS?	+CGCLASS: <class> OK or: +CME ERROR: <err>	The Read command returns the current GPRS mobile class.
Test	AT +CGCLASS=?	+CGCLASS: (list of supported <class>s) OK or; +CME ERROR: <err>	The Test command is used for requesting information on the supported GPRS mobile classes.

Note: Issuing GPRS actions over a poor-quality connection may cause protocol errors and harm data validity. To prevent these problems, G24-L is equipped with a protection mechanism that confirms GPRS signal strength before issuing GPRS network-related commands.

The following table shows the +CGCLASS parameters.

Table 3-152: +CGCLASS Parameters

<Parameter>	Description
<class>	String parameter that indicates the GPRS mobile class: B Class B

Example

```
AT+CGCLASS=?
+CGCLASS: (B)
OK
```

Note: If a SIM card without GPRS allowance is used:

```
AT+CGCLASS=?
+CGCLASS: (CC) //Note that CC is a not supported value.
```

+CGDCONT, Define PDP Context

This command specifies the PDP (Packet Data Protocol) context.

Command Type	Syntax	Response/Action	Remarks
Set	AT+CGDCONT=[<cid> [,<PDP_type>[,<APN> [,<PDP_addr>[,<d_comp> [,<h_comp>]]]]]]	OK or: +CME ERROR: <err>	The Set command specifies the context identification parameter values for a PDP context. A special form of the Set command, +CGDCONT= <cid> causes the values for context number <cid> to become undefined.
Read	AT+CGDCONT?	+CGDCONT: <cid>, <PDP_type>, <APN>, <PDP_addr>, <data_comp>, <head_comp>[<CR><LF>+CGDCONT: <cid>, <PDP_type>, <APN>, <PDP_addr>, <data_comp>, <head_comp>	The Read command returns the current settings for each defined context.
Test	AT+CGDCONT=?	+CGDCONT: (range of supported <cid>s), <PDP_type>, , , (list of supported <d_comp>s), (list of supported <h_comp>s)	The Test command returns the values supported as a compound value. If the ME supports several PDP types, <PDP_type>, the parameter value ranges for each <PDP_type> are returned on a separate line.

The following table shows the +CGDCONT parameters.

Table 3-153: +CGDCONT Parameters

<Parameter>	Description
<cid>	Numeric parameter specifying a particular PDP context definition (PDP Context Identifier). The parameter is local to the Terminal-Mobile Terminal interface and is used in other PDP context-related commands. The Test command returns the range of permitted values (minimum value=1).
<"PDP_type"> (Packet data protocol type)	String parameter (in quotation marks) specifying the type of packet data protocol: IP Internet Protocol (IETF STD 5)
<"APN"> (Access Point Name)	String parameter (in quotation marks), which is a logical name that is used to select the GGSN or the external packet data network. If the value is null or omitted, the subscription value is requested.
<"PDP_addresses">	String parameter (in quotation marks), which identifies the ME in the address space applicable to the PDP. If the value is null or omitted, a value may be provided by the terminal during the PDP startup procedure or, failing that, a dynamic address is requested. The Read form of the command continues to return the null string even if an address has been allocated during the PDP startup procedure. The allocated address may be read using the +CGPADDR command. The default value is 0.
<d_comp>	Numeric parameter that controls PDP data compression. 0 OFF 1 ON Other values are reserved. The default value is 0.
<h_comp>	Numeric parameter that controls the PDP header compression. 0 OFF 1 ON Other values are reserved. Note: Currently, only one data compression algorithm (V.42bis) is provided in SNDCP. If and when other algorithms become available, a command will be provided to select one or more data compression algorithms. The default value is 0.

Note: The IP address may be entered without double quotes (" ").

For example:

```
AT+CGDCONT=1,IP,RTY,123.32.45.9
```

```
OK
```

Example

```
AT+CGDCONT=?
+CGDCONT: (1-3),("IP"),,,(0,1),(0,1)
OK
AT+CGDCONT?
+CGDCONT: 1,"IP",,"","0.0.0.0",0,0
+CGDCONT: 2,"IP",,"","0.0.0.0",0,0
```

```

+CGDCONT: 3,"IP",,,,,,"0.0.0.0",0,0
OK
AT+CGDCONT= 1,"IP","internetg","0.0.0.0",0,0
OK
AT+CGDCONT?
+CGDCONT: 1,"IP","internetg","0.0.0.0",0,0
+CGDCONT: 2,"IP",,,,,,"0.0.0.0",0,0
+CGDCONT: 3,"IP",,,,,,"0.0.0.0",0,0
OK
AT+CGDCONT= 1,"IP","internetg","0.0.0.0",0,0
OK
AT+CGDCONT=2,"IP","internetg","0.0.0.0",1,1
OK

```

+CGQMIN, Quality of Service Profile (Min Acceptable)

This command enables the terminal to specify the minimum acceptable profile which is checked by the ME against the negotiated profile returned in the Activate PDP Context Accept message.

Command Type	Syntax	Response/Action	Remarks
Set	AT+CGQMIN=[<cid> [,<precedence> [,<delay> [,<reliability.> [,<peak> [,<mean>]]]]]]	OK or: +CME ERROR: <err>	The Set command specifies a profile for the context identified by the (local) context identification parameter, <cid>. As this is the same parameter that is used in the +CGDCONT command, the +CGQMIN command is effectively an extension of the +CGDCONT command. The QoS profile consists of a number of parameters, each of which may be set to a separate value.

Command Type	Syntax	Response/Action	Remarks
Read	AT+CGQMIN?	+CGQMIN: <cid>, <precedence>, <delay>, <reliability>, <peak>, <mean>[<CR><LF>+CGQMIN: <cid>, <precedence>, <delay>, <reliability>, <peak>, <mean>[...]] OK or: +CME ERROR: <err>	The Read command returns the current settings for each defined context.
Test	AT+CGQMIN=?	+CGQMIN: <PDP_type>, (list of supported <precedence>s), (list of supported <delay>s), (list of supported <reliability>s), (list of supported <peak>s), (list of supported <mean>s) [<CR><LF>+CGQMIN: <PDP_type>, (list of supported <precedence>s), (list of supported <delay>s), (list of supported <reliability>s), (list of supported <peak>s), (list of supported <mean>s)] OK or: +CME ERROR: <err>	The Test command returns the parameter value ranges for each <PDP_type>

The following table shows the +CGQMIN parameters.

Table 3-154: +CGQMIN Parameters

<Parameter>	Description
<cid>	A numeric parameter that specifies a particular PDP context definition. The value is from 1 to 3.
<precedence>	A numeric parameter that specifies the precedence class.
<delay>	A numeric parameter that specifies the delay class.
<reliability>	A numeric parameter that specifies the reliability class.
<peak>	A numeric parameter that specifies the peak throughput class.
<mean>	A numeric parameter that specifies the mean throughput class.

Example

```

AT+CGQMIN=?
+CGQMIN: ("IP"),(0-3),(0-4),(0-5),(0-9),(0-18,31)
OK
AT+CGQMIN?
+CGQMIN: 1,2,4,3,9,10
+CGQMIN: 2,2,4,3,9,10
+CGQMIN: 3,2,4,3,9,10
OK

```

+CGQREQ, Quality of Service Profile (Requested)

This command enables the terminal to specify a Quality of Service Profile that is used when the ME sends an Activate PDP Context Request message to the network.

Command Type	Syntax	Response/Action	Remarks
Set	AT+CGQREQ=[<cid> [,<precedence> [,<delay> [,<reliability>[,<peak> [,<mean>]]]]]]	OK or: +CME ERROR: <err>	The Set command specifies a profile for the context identified by the (local) context identification parameter, <cid>. As this is the same parameter that is used in the +CGDCONT command, the +CGQREQ command is effectively an extension of the +CGDCONT command. The QoS profile consists of a number of parameters, each of which may be set to a separate value. A special form of the Set command, +CGQREQ= <cid>, causes the requested profile for context number <cid> to become undefined.
Read	AT+CGQREQ?	+CGQREQ: <cid>, <precedence>, <delay>, <reliability>, <peak>, <mean> OK or: +CME ERROR: <err>	The Read command returns the current settings for each defined context.
Test	AT+CGQREQ=?	+CGQREQ: <PDP_type>, (list of supported <precedence>s), (list of supported <delay>s), (list of supported <reliability>s), (list of supported <peak>s), (list of supported <mean>s) OK or: +CME ERROR: <err>	The Test command returns values supported as a compound value. If the ME supports several PDP types, the parameter value ranges for each PDP type are returned on a separate line.

The following table shows the +CGQREQ parameters.

Table 3-155: +CGQREQ Parameters

<Parameter>	Description
<cid>	A numeric parameter that specifies a particular PDP context definition. The value is from 1 to 3.
<precedence>	A numeric parameter that specifies the precedence class.
<delay>	A numeric parameter that specifies the delay class.
<reliability>	A numeric parameter that specifies the reliability class.
<peak>	A numeric parameter that specifies the peak throughput class.
<mean>	A numeric parameter that specifies the mean throughput class.

Example

```

AT+CGQREQ=?
+CGQREQ: ("IP"),(0-3),(0-4),(0-5),(0-9),(0-18,31)
OK
AT+CGQREQ?
+CGQREQ: 1,2,4,3,9,10
+CGQREQ: 2,2,4,3,9,10
+CGQREQ: 3,2,4,3,9,10
OK
AT+CGQREQ=1,0,,0,0,0
OK
AT+CGQREQ?
+CGQREQ: 1,0,4,0,0,0
+CGQREQ: 2,2,4,3,9,10
+CGQREQ: 3,2,4,3,9,10
OK

```

+CGATT, GPRS Attach or Detach

This command attaches/detaches the ME to/from the GPRS service. When the command has completed, the ME remains in V.25ter command state. If the ME is already in the requested state, the command is ignored and the OK response is returned. If the requested state cannot be achieved, an ERROR or +CME ERROR response is returned. Extended error responses are enabled by the +CMEE command. Any active PDP contexts will be automatically deactivated when the attachment state changes to detached.

Command Type	Syntax	Response/Action	Remarks
Set	AT+CGATT=[<state>]	OK or: +CME ERROR: <err>	The Set command attaches/detaches the ME to/from the GPRS service.
Read	AT+CGATT?	+CGATT: <state> OK or: +CME ERROR: <err>	The Read command returns the current GPRS service state.
Test	AT+CGATT=?	+CGATT: (list of supported <state>s) OK or: +CME ERROR: <err>	The Test command requests information on the supported GPRS service states.

Note: This command has the characteristics of both the V.25ter action and parameter commands. Therefore, it has the Read form in addition to the Execution/Set and Test forms.

The following table shows the +CGATT parameters.

Table 3-156: +CGATT Parameters

<Parameter>	Description
<state>	Indicates the state of the GPRS attachment: 0 Detached. 1 Attached.

Example

```
AT+CGATT=?
+CGATT: (0,1)
OK
AT+CGATT?
+CGATT: 0
OK
AT+CGATT=0
OK
```

+CGPADDR, Show PDP Address

The execution command returns a list of PDP addresses for the specified context identifiers.

The test command returns a list of defined <cid>s.

Command Type	Syntax	Response/Action	Remarks
Set	+CGPADDR=[<cid> [,<cid> [...]]]	+CGPADDR: <cid>,<PDP_addr> [<CR><LF>+CGPADDR: <cid>,<PDP_addr> [...]]	
Test	+CGPADDR=?	+CGPADDR: (list of defined <cid>s)	

The following table shows the +CGPADDR parameters.

Table 3-157: +CGPADDR Parameters

<Parameter>	Description
<cid>	A numeric parameter which specifies a particular PDP context definition (see the +CGDCONT and +CGDSCONT commands). If no <cid> is specified, the addresses for all defined contexts are returned.
< PDP_address>	A string that identifies the MT in the address space applicable to the PDP. The address may be static or dynamic. For a static address, it will be the one set by the +CGDCONT and +CGDSCONT commands when the context was defined. For a dynamic address it will be the one assigned during the last PDP context activation that used the context definition referred to by <cid>. <PDP_address> is omitted if none is available.

Example

```
AT+CGPADDR=?
+CGPADDR: (1,2,3)
OK
AT+CGPADDR=1
+CGPADDR: 1,0.0.0.0
OK
```

+MGEER, GPRS Extended Error Report

This command is used to return the PDP context activation reject cause.

Command Type	Syntax	Response/Action	Remarks
Set	AT+MGEER=[<n>]	OK or: +CME ERROR: <err>	
Read	AT+MGEER?	+MGEER: <cause> OK	
Test	AT+MGEER=?	+MGEER: <n> OK	

The following table shows the +MGEER parameters.

Table 3-158: +MGEER Parameters

<Parameter>	Description
<n>	Indicates what format of cause needs to be printed. The default value is 2. 1 Returns numeric cause format. 2 Returns text cause format.
<cause>	The PDP context activation reject cause. 0 Bad SIM (user authentication failed) 1 Roaming Not Allowed 2 Access Class Not Allowed 3 Network Failure 4 Insufficient Resource 5 All TID In Use 6 Link EST Failed 7 Activation Rejected By Network 8 Lower Layer Failure 9 Activation In Progress 10 Unspecified 11 Reactivation 12 Invalid QOS 13 MT AA Deactivation 14 MAX Timer Expiry 15 "Missing Or Unknown APN" 16 LLC Or SMDCP Failure 17 Feature Not Supported 18 CS Transaction In Progress 19 Primary NSAPI Being Deactivated 20 Primary NSAPI Inactive 21 Semantic Error In TFT Operatio 22 Syntactical Error In TFT Operation 23 Unknown PDP Context 24 Semantic Errors In Packet Filters 25 Syntactical Errors In Packet Filters 26 PDP Context Without TFT Already Activated 27 Feature Not Supported By Network 28 MT Modification In Progress 29 RAB Loss 30 Incompatible QOS Values 31 Activation Rejected Unspecified 32 Service Option Not Supported 33 Service Option Not Subscribed 34 Service Option Temporarily Out Of Order 35 Operator Determined Barring 36 QOS Not Accepted 37 NSAPI Already Used 38 Cause Protocol Error 254 Unspecified 255 No Information Available

D*99, Request GPRS Service "D"

This command enables the ME to perform the actions necessary for establishing communication between the terminal and the external Packet Data Network (PDN).

The ITU V.25ter 'D' (Dial) command causes the ME to enter the ITU V.25ter Online Data state and together with the terminal, to start the specified layer 2 protocol. The ME returns CONNECT to confirm acceptance of the command prior to entering the ITU V.25ter Online Data state. No further commands may follow on the AT command line.

The detailed behavior after the Online Data state has been entered is dependent on the PDP type, and is described briefly. GPRS attachment and PDP context activation procedures may take place prior to, or during the PDP startup if they have not already been performed using the +CGATT and +CGACT commands.

When the layer 2 protocols have terminated, either as a result of an orderly shut down of the PDP or an error, the ME enters the ITU V.25ter command state and returns the NO CARRIER final result code.

If <called address> is supported and provided, the ME automatically sets up a virtual call to the specified address after the PDP context has been activated.

If <L2P> and <cid> are supported, the +CGDCONT, +CGQREQ and other such commands may then be used in the modem initialization AT command string to set values for PDP type, APN, QoS and so on.

If <L2P> is not supported, or is supported but omitted, the ME uses a layer 2 protocol appropriate to the PDP type.

If <cid> is not supported, or is supported but omitted, the ME attempts to activate the context using one of the following:

- Any information provided by the terminal during the PDP startup procedure. For example, the terminal may provide a PDP type and/or PDP address to the ME.
- A prior knowledge, for example, the ME may implement only one PDP type.

Using the "Empty PDP type" No PDP address or APN is sent in this case and only one PDP context subscription record is present in the HLR for this subscriber.

This command may be used in both normal and modem compatibility modes.

Command Type	Syntax	Response/Action
Set	ATD*<GPRS_SC> [*[<called_address>][*[<L2P>] [*[<cid>]]]]#	CONNECT or: ERROR

The following table shows the D*99 parameters.

Table 3-159: D*99 Parameters

<Parameter>	Description
<GPRS_SC> (GPRS Service Code)	Digit string (value 99) which identifies a request to use GPRS.
<called_address>	<p>String that identifies the called party in the address space applicable to the PDP. For communications software that does not support arbitrary characters in the dial string, a numeric equivalent may be used. Also, the comma character "," may be used as a substitute for the period character ".".</p> <p>For PDP type OSP:IHOSS, the following syntax may be used for <called_address>:[<host>][@ [<port>][@ [<protocol>]]] where <host>, <port> and <protocol> are defined in "+CGDCONT, Define PDP Context" on page 3-232.</p> <p>For communications software that does not support arbitrary characters in the dial string, a numeric value equivalent to the hostname may be used. However, this should be avoided if at all possible.</p>
<L2P>	<p>String variable which indicates the layer 2 protocol to be used.</p> <p>For communications software that does not support arbitrary characters in the dial string, the following numeric equivalents are used:</p> <ul style="list-style-type: none"> 0 NULL 1 PPP 2 PAD 3 X25 9 yyyy M-xxxx <p>Other values are reserved and result in an ERROR response to the Set command.</p> <p>Note: V.250 (and certain communications software) do not permit arbitrary characters in the dial string. The <L2P> and <called_address> strings are therefore specified as containing digits (0-9) only.</p>
<cid>:	Digit string which specifies a particular PDP context definition (See "+CGDCONT, Define PDP Context" on page 3-232).

Example

```
ATD*99
+CGDCONT
```

```
//Try connecting to GPRS according to the first <cid>, defined in
```

+CGPRS, GPRS Coverage

This command indicates whether there is GPRS coverage.

Note: GPRS coverage will be detected only when SIM has GPRS ability.

Command Type	Syntax	Response/Action	Remarks
Execute	AT+CGPRS	+CGPRS: <mode> OK or: +CME ERROR: <err>	The Execute command returns the mode of the GPRS coverage.
Read	AT+CGPRS?	+CGPRS: <mode> OK or: +CME ERROR: <err>	The Read command returns the mode of the GPRS coverage

The following table shows the +CGPRS parameters.

Table 3-160: +CGPRS Parameters

<Parameter>	Description
<mode>	0 No GPRS coverage 1 GPRS coverage There is no parameter default value

Example

Without GPRS coverage

```
AT+CGPRS
+CGPRS: 0
OK
```

```
AT+CGPRS?
+CGPRS: 0
```

```
OK
```

With GPRS coverage

```
AT+CGPRS
+CGPRS: 1
```

```
OK
```

+CGACT, PDP Context Activate or Deactivate

This command activates/deactivates the specified PDP context(s).

Command Type	Syntax	Response/Action	Remarks
Set	AT+CGACT=[<state> [,<cid> [,<cid>[,]]]]	OK or: NO CARRIER or: +CME ERROR: <err>	The Set command activates/deactivates the specified PDP context(s). When the command is completed, the ME remains in V.25 command state. If any PDP context is already in the requested state, the state for that context remains unchanged. If the requested state for any specified context cannot be achieved, an ERROR or +CME ERROR response is returned. Extended error responses are enabled by the +CMEE command. If the ME is not GPRS-attached when the activation form of the command is executed, the ME first performs a GPRS attach and then attempts to activate the specified contexts. If the attach fails, the ME responds with an ERROR or, if extended error responses are enabled, with the appropriate failure-to-attach error message.
Read	AT+CGACT?	+CGACT: <cid>, <state> <CR><LF>+CGACT: <cid>, <state> <CR><LF>+CGACT: <cid>, <state> OK	The Read command returns the current activation states for all the defined PDP contexts.
Test	AT+CGACT=?	+CGACT: (list of supported <state>s) OK or: +CME ERROR: <err>	The Test command requests information on the supported PDP context activation states.

The following table shows the +CGACT parameters.

Table 3-161: +CGACT Parameters

<Parameter>	Description
<state>	Indicates the activation state of the context: 0 Non-active 1 Active
<cid>	1-3 A numeric parameter that specifies a particular PDP context definition

Example

```

AT+CGACT=?
+CGACT: (0,1)
OK
AT+CGACT?
+CGACT: 1,0
+CGACT: 2,0
+CGACT: 3,0
OK
AT+CGACT=1
ERROR //GPRS network not present.

```

Note: In some GPRS networks, +CGACT is not supported. the ATD*99 # command can be used to establish a connection.

Activating a context can take up to 150 seconds.

Deactivating a context can take up to 40 seconds.

When aborting a +CGACT Set command, the context is closed. This can take up to 40 seconds.

STK

The SIM Application Toolkit (STK) is a set of applications and related procedures, which may be used in conjunction with SIM or Smart Cards during a GSM session. The STK provides mechanisms that enable applications existing in the SIM to interact and operate with any ME (such as the G24-L) that support these mechanisms.

The following scheme shows the SIM Toolkit functionality commands and unsolicited results that are implemented. All these commands are non-basic commands.

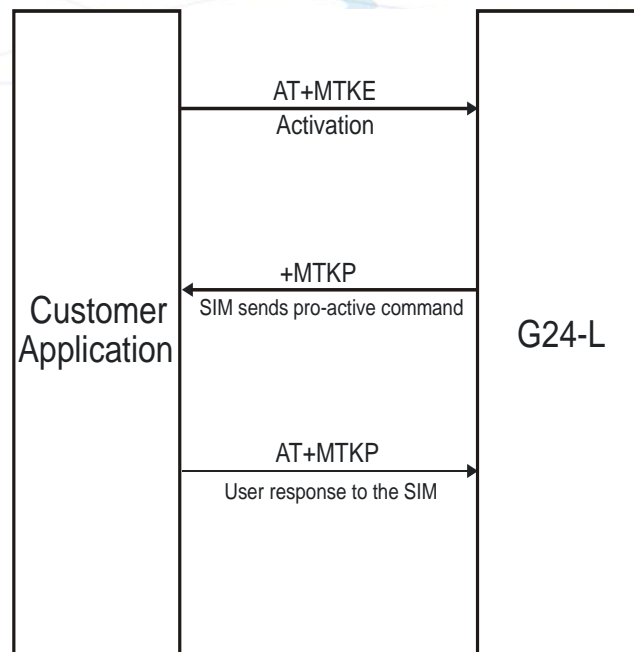

Figure 3-13: SIM Toolkit

- In the first step, the customer application informs the G24-L module that it wants all features to be supported. This operation is performed using the AT+MTKE (Motorola ToolKit Enable) command, which allows activating or deactivating the SIM Toolkit functionality.
- In the second step, an unsolicited result +MTKP (Motorola ToolKit Proactive) is sent by the G24-L in order to indicate the customer application, command type the SIM Application Toolkit is running on the SIM card, and the relevant information.
- In the third step, the customer application uses the AT+MTKP command to respond to the SIM ToolKit command, given by +MTKP.

STK Mechanisms

The mechanisms defined for the STK (Table 3-162) are dependent upon the relevant commands and protocols found in GSM 11.11.

Table 3-162: STK Mechanisms

Mechanism	Description
Profile Download	Enables the G24-L to tell the SIM what its capabilities are. (The G24-L is aware of the SIM's capabilities via the SIM Service Table and EFPHASE.) Refer to “+MTKR, Profile Download”, page 3-247
Provide Local Information	Defined as part of the proactive SIM service, this command requests the G24-L to pass local information to the SIM, for example, the mobile country and network codes (MCC + MNC) of the network on which the user is registered.
Send DTMF	Defined as part of the proactive SIM service, this command requests the G24-L to send DTMF tone(s) during an established call. Refer to “Send DTMF”, page 3-263.
Set Up Idle Mode Text	Defined as part of the proactive SIM G24-L, this command supplies a text string to be used by the ME as stand-by mode text.
Launch Browser	Defined as part of the proactive SIM service, this command requests a browser inside a browser-enabled user terminal to interpret the content corresponding to a URL. Refer to “Launch Browser”, page 3-264.
Set Up Event List	Defined as part of the proactive SIM service, this command supplies a list of events, which the SIM wants the G24-L to provide details of when these events happen. Refer to “Set Up Event List”, page 3-265.

+MTKR, Profile Download

This command displays the profile that is downloaded from the G24-L to the SIM during the SIM initialization process. This profile includes the facilities relevant to the STK that are supported by the G24-L, enabling the SIM to limit its instruction range to those STK features the G24-L supports. (Refer to “Profile Structure”, page 3-248) Without a profile, the SIM assumes that the G24-L does not support the STK.

Profile download is performed automatically during device initialization, with no user intervention required.

Command Type	Syntax	Response/Action	Remarks
Read	+MTKR?	+MTKR: <profile>	The Read command displays the current STK profile.

The following table shows the +MTKR parameters.

Table 3-163: +MTKR Parameters

<Parameter>	Description
<profile>	<p>Displayed in hexadecimal characters, each byte of the profile is represented by two characters:</p> <p>First character Higher nibble (bits 4-7) Second character Lower nibble (bits 0-3)</p> <p>The bits are displayed in the following order: <byte 1 higher nibble><byte 1 lower nibble><byte 2 higher nibble><byte 2 lower nibble> (and so on)</p>

Example

```
AT+MTKR?
+MTKR: 2F6FFFFFFF0E1F1F4300001F2300000003
```

```
OK
```

Profile Structure

The profile lists those STK facilities supported by the G24-L. One bit is used to code each facility:

- If bit = 1, facility is supported
- If bit = 0, facility is not supported

The following tables describe the contents of each bit in the profile.

Table 3-164: Profile Structure – Byte 1 (Download)

Bit	Description
b1	Profile download
b2	SMS-PP data download
b3	Cell Broadcast data download
b4	Menu selection

Table 3-164: Profile Structure – Byte 1 (Download) (Cont.)

Bit	Description
b5	9EXX' response code for SIM data download error
b6	Timer expiration
b7	USSD string data object supported in Call Control
b8	Envelope Call Control always sent to the SIM during automatic redial mode

Table 3-165: Profile Structure – Byte 2 (Other)

Bit	Description
b1	Command result
b2	Call Control by SIM
b3	Cell identity included in Call Control by SIM
b4	MO short message control by SIM
b5	Handling of the alpha identifier according to reference 1 subclause 9.1.3
b6	UCS2 Entry supported
b7	UCS2 Display supported
b8	Display of the extension text

Table 3-166: Profile Structure – Byte 3 (Proactive SIM)

Bit	Description
b1	Proactive SIM: DISPLAY TEXT
b2	Proactive SIM: GET INKEY
b3	Proactive SIM: GET INPUT
b4	Proactive SIM: MORE TIME
b5	Proactive SIM: PLAY TONE
b6	Proactive SIM: POLL INTERVAL
b7	Proactive SIM: POLLING OFF
b8	Proactive SIM: REFRESH

Table 3-167: Profile Structure – Byte 4 (Proactive SIM)

Bit	Description
b1	Proactive SIM: SELECT ITEM
b2	Proactive SIM: SEND SHORT MESSAGE
b3	Proactive SIM: SEND SS
b4	Proactive SIM: SEND USSD
b5	Proactive SIM: SET UP CALL
b6	Proactive SIM: SET UP MENU
b7	Proactive SIM: PROVIDE LOCAL INFORMATION (MCC, MNC,LAC, Cell ID & IMEI)
b8	Proactive SIM: PROVIDE LOCAL INFORMATION (NMR)

Table 3-168: Profile Structure – Byte 5 (Event driven information)

Bit	Description
b1	Proactive SIM: SET UP EVENT LIST
b2	Event: MT call
b3	Event: Call connected
b4	Event: Call disconnected
b5	Event: Location status
b6	Event: User activity
b7	Event: Idle screen available
b8	Event: Card reader status

Table 3-169: Profile Structure – Byte 6 (Event driven information extensions)

Bit	Description
b1	Event: Language selection
b2	Event: Browser Termination
b3	Event: Data available
b4	Event: Channel status

Table 3-169: Profile Structure – Byte 6 (Event driven information extensions)

Bit	Description
b5	RFU, bit = 0
b6	
b7	
b8	

Table 3-170: Profile Structure – Byte 7 (Multiple card proactive commands)

Bit	Description
b1	Proactive SIM: POWER ON CARD
b2	Proactive SIM: POWER OFF CARD
b3	Proactive SIM: PERFORM CARD APDU
b4	Proactive SIM: GET READER STATUS (Card reader status)
b5	Proactive SIM: GET READER STATUS (Card reader identifier)
b6	RFU, bit = 0
b7	
b8	

Table 3-171: Profile Structure – Byte 8 (Proactive SIM)

Bit	Description
b1	Proactive SIM: TIMER MANAGEMENT (start, stop)
b2	Proactive SIM: TIMER MANAGEMENT (get current value)
b3	Proactive SIM: PROVIDE LOCAL INFORMATION (date, time and time zone)
b4	Binary choice in GET INKEY
b5	SET UP IDLE MODE TEXT
b6	RUN AT COMMAND (that is, class "b" is supported)
b7	2nd alpha identifier in SET UP CALL
b8	2nd capability configuration parameter (see 3GPP TS 11.14 version 8.9.0 Release 1999, subclause 9.1.6)

Table 3-172: Profile Structure – Byte 9 (Proactive SIM)

Bit	Description
b1	Sustained DISPLAY TEXT (see 3GPP TS 11.14 version 8.9.0 Release 1999, subclause 6.4.1)
b2	SEND DTMF command (see 3GPP TS 11.14 version 8.9.0 Release 1999, subclause 6.4.24)
b3	Proactive SIM: PROVIDE LOCAL INFORMATION - BCCHChannel List coding, as per 3GPP TS 11.14 version 8.9.0 Release 1999, subclause 12.29)
b4	Proactive SIM: PROVIDE LOCAL INFORMATION (language)
b5	Proactive SIM: PROVIDE LOCAL INFORMATION (TimingAdvance)
b6	Proactive SIM: LANGUAGE NOTIFICATION
b7	Proactive SIM: LAUNCH BROWSER
b8	RFU, bit = 0

Table 3-173: Profile Structure – Byte 10 (Soft keys support)

Bit	Description
b1	Soft keys support for SELECT ITEM (see 3GPP TS 11.14 version 8.9.0 Release 1999, subclause 6.4.9)
b2	Soft Keys support for SET UP MENU (see 3GPP TS 11.14 version 8.9.0 Release 1999, subclause 6.4.8)
b3	RFU, bit = 0
b4	
b5	
b6	
b7	
b8	

Table 3-174: Profile Structure – Byte 11 (Soft keys information)

Bit	Description
b1	Maximum number of soft keys available.
b2	
b3	
b4	
b5	'FF' value is reserved for future use
b6	
b7	
b8	

Table 3-175: Profile Structure – Byte 12 (Bearer independent protocol proactive commands – class "e")

Bit	Description
b1	Proactive SIM: OPEN CHANNEL
b2	Proactive SIM: CLOSE CHANNEL
b3	Proactive SIM: RECEIVE DATA
b4	Proactive SIM: SEND DATA
b5	Proactive SIM: GET CHANNEL STATUS
b6	RFU, bit = 0
b7	
b8	

Table 3-176: Profile Structure – Byte 13 (Bearer independent protocol supported bearers – class "e")

Bit	Description
b1	CSD supported by ME
b2	GPRS supported by ME
b3	RFU, bit = 0
b4	
b5	
b6	Number of channels supported by ME
b7	
b8	

Table 3-177: Profile Structure – Byte 14 (Screen height)

Bit	Description
b1	Number of characters supported down the ME display, as defined in 3GPP TS 11.14 version 8.9.0 Release 1999, subclause 5.3.1
b2	
b3	
b4	
b5	
b6	RFU, bit = 0
b7	
b8	Screen Sizing Parameters supported as defined in 3GPP TS 11.14 version 8.9.0 Release 1999, section 5.3

Table 3-178: Profile Structure – Byte 15 (Screen width)

Bit	Description
b1	Number of characters supported across the ME display, as defined in 3GPP TS 11.14 version 8.9.0 Release 1999, subclause 5.3.2
b2	
b3	
b4	
b5	
b6	
b7	
b8	Variable size fonts supported

Table 3-179: Profile Structure – Byte 16 (Screen effects)

Bit	Description
b1	Display can be resized as defined in 3GPP TS 11.14 version 8.9.0 Release 1999, subclause 5.3.3
b2	Text Wrapping supported as defined in 3GPP TS 11.14 version 8.9.0 Release 1999, subclause 5.3.4
b3	Text Scrolling supported as defined in 3GPP TS 11.14 version 8.9.0 Release 1999, subclause 5.3.5
b4	RFU
b5	
b6	Width reduction when in a menu as defined in 3GPP TS 11.14 version 8.9.0 Release 1999, subclause 5.3.6
b7	
b8	

Table 3-180: Profile Structure – Byte 17 (Bearer independent protocol supported transport interface – class "e")

Bit	Description
b1	TCP
b2	UDP

Table 3-180: Profile Structure – Byte 17 (Bearer independent protocol supported transport interface – class "e") (Cont.)

Bit	Description
b3	RFU, bit = 0
b4	
b5	
b6	
b7	
b8	

Table 3-181: Profile Structure – Byte 18 (Reserved)

Bit	Description
b1	RFU, bit = 0
b2	
b3	
b4	
b5	
b6	
b7	
b8	

Table 3-182: Profile Structure – Byte 19 (Reserved for TIA/EIA-136 facilities)

Bit	Description
b1	Protocol Version, coded as indicated in TIA/EIA-136-123
b2	
b3	
b4	
b5	RFU, bit = 0
b6	
b7	
b8	

Note: The bits comprising each subsequent byte are all: RFU, bit = 0.

+MTKE, Motorola ToolKit Enable

This command enables/disables the SIM ToolKit functionality.

Command Type	Syntax	Response/Action	Remarks
Set	+MTKE=<Enable>	OK or: +CME ERROR: <err>	The Set command tells the G24-L in which mode to work.
Read	+MTKE?	+MTKE: <State>	The Read command returns the current values.
Test	+MTKE=?	+MTKE: (list of supported <state>s) OK	The Test command returns the supported values as a compound value.

The following table shows the +MTKE parameters.

Table 3-183: +MTKE Parameters

<Parameter>	Description
<State>	Indicates the state of the SIM ToolKit: 0 Deactivate the SIM ToolKit functionality 1 Activate the SIM ToolKit functionality The default is 0.

Example

```

AT+MTKE=? //Test command SIM ToolKit set facilities
+MTKE: (0-1)
OK

AT+MTKE? //No activation of SIM ToolKit functionality
+MTKE: 0
OK

AT+MTKE=1 //Set all facilities SIM ToolKit (class 2).
OK

AT+MTKE=3 //Syntax error
+CME ERROR:

AT+MTKE=1 //Activation of SIM ToolKit functionality
OK

```

+MTKP, Motorola ToolKit Proactive (Unsolicited Indication)

In order to allow the customer to identify the pro-active command sent by the SIM ToolKit, an unsolicited SIM ToolKit indication (with the appropriate information, such as text to display, priorities and so on) is implemented.

The following table shows the+MTKP Field Descriptions.

Table 3-184: +MTKP Field Descriptions

Cmd Type	Description	Responses
1	Provides data about the "Display text" pro-active command.	+MTKP: <ProactiveCmdType>,<Priority>,<Text>
2	Provides data about the "Get Inkey" pro-active command.	+MTKP: <ProactiveCmdType>,<ResponseType>,<HelpInfo>[,<Text>]
3	Provides data about the "Get Input" pro-active command.	+MTKP: <ProactiveCmdType>,<ResponseType>,<SecurityMode>,<MinLen>,<MaxLen>,<HelpInfo>[,<Text>]
5	Provides data about 'Play Tone' pro-active command.	+MTKP: <ProactiveCmdType>,<ToneType>[,<TimeUnit>,<TimeInterval>],<Text>]
9	Provides data about the 'Send SMS' pro-active command.	+MTKP: <ProactiveCmdType>[,<Text>]
10	Provides data about the 'Send SS' pro-active command.	+MTKP: <ProactiveCmdType>[,<Text>]
12	Provides data about the 'Setup call' pro-active command.	+MTKP: <ProactiveCmdType>,<Type>,<CalledNb>,<Redials>,<Text>
13	Provides data about the 'Refresh' pro-active command.	+MTKP: <ProactiveCmdType>,<RefreshType>
20	Provides data indicating the timeout (get inkey, get input and select item).	+MTKP: <ProactiveCmdType>
22	Provides a text string to display when the G24-L is in idle text mode.	+MTKP=22,"<idle mode text string>"
24	Sends a DTMF string after a call has been successfully established.	+MTKP: 24,<status>
26	Displays a browser for URLs inside browser-enabled G24s.	+MTKP: <ProactiveCmdType>,<URL>,<bearers>,<proxy_Id>[,<alpha_id>]

Note: The Cmd Type numbers refer to the proactive command which was sent from the SIM (This is the ProactiveCmdType field).

For "get inkey" and "get input", a one-minute timer is set, and any response for these unsolicited commands after one minute is not accepted.

The following table shows the +MTKP parameters.

Table 3-185: +MTKP Parameters of MTKP Field Description

<Parameter>	Description
ProactiveCmdType=1 (Display Text)	
<Priority>	0 Normal priority of display. 1 High priority of display.
<Text>	Text information in ASCII format.
ProactiveCmdType=2 (Get Inkey)	
<ResponseType>	0 Digit (0-9, *, #, and +) 1 SMS alphabet. 2 UCS2 characters 3 Yes/No
<HelpInfo>	0 No help information available. 1 Help information is available.
<Text>	Text information in ASCII format.
ProactiveCmdType=3 (Get Input)	
<ResponseType>	0 Digit (0-9, *, #, and +) 1 SMS alphabet. 2 UCS2 characters.
<SecurityMode>	0 Security off. 1 Security on.
<SizeMin>	Minimum length of input.
<SizeMax>	Maximum length of input.
<HelpInfo>	0 No help information available. 1 Help information is available.
<Text>	Text information in ASCII format.
Values when ProactiveCmdType=5 (Play tone)	
<ToneType>	1 Dial tone. 3 Network Congestion. 4 Radio ack. 5 Tone Dropped. 6 Tone Error. 7 Tone Call waiting. 8 Alert classic. 10 Powerup. 11 Confirm. 12 Negative.
<TimeUnit>	0 Minutes. 1 Seconds. 2 Tenths of seconds.
<TimeInterval>	(1-255) Time required expressed in units.
<Text>	Text information in ASCII format.

Table 3-185: +MTKP Parameters of MTKP Field Description (Cont.)

<Parameter>	Description
Values when ProactiveCmdType=9 (Send SMS)	
<Text>	Text information in ASCII format.
Values when ProactiveCmdType=10 (Send SS)	
<Text>	Text information in ASCII format.
Values when ProactiveCmdType=12 (Setup Call)	
<Parameter>	0 Set up call, but only if not currently busy on another call. 1 Set up call, putting all other calls (if any) on hold. 2 Set up call, disconnecting all other calls (if any).
<CalledNb>	Called number in ASCII format.
<Redials>	0 Redial allowed. 1 Redial not allowed.
<Text>	Text information in ASCII format.
Values when ProactiveCmdType=13 (Refresh)	
<RefreshType>	0 SIM initialization and full file change notification. 1 File change notification. 2 SIM initialization and file change notification. 3 SIM initialization. 4 SIM reset.
Values when ProactiveCmdType=22 (Set Up Idle Mode Text)	
<idle mode text string>	Text string to display when the G24-L is in idle mode.
Values when ProactiveCmdType=24 (Send DTMF)	
<alpha id>	Alpha ID of the DTMF string.
Values when ProactiveCmdType=26 (Launch Browser)	
<URL>	URL (text string of up to 100 characters).
<bearers>	0 Bearer unspecified. 1 Bearer SMS (for future use). 2 Bearer CSD. 4 Bearer USSD (for future use). 8 Bearer GPRS and all possible intersections (Currently only 2 bearer types are supported: CSD and GPRS. Valid bearers are: 0,2,8,10)
<proxy_id>	Text string containing name/identity of the gateway or proxy used for connecting to the URL (max. 20 characters).
<alpha_id>	Text string identifying the current connection (max. 20 characters).

Command Type	Syntax	Response/Action	Remarks
Set	AT+MTKP=<Cmd Type>,<Result> [,<Data>]	OK or: +CME ERROR: <err>	The Set command allows the user to answer the following proactive commands: <ul style="list-style-type: none">• GET_INKEY Key pressed from the user.• GET_INPUT Message entered by the user.• Enable/disable the DTMF service by the user.• Launch browser.• Set up event kist.

The following table shows the +MTKP Set parameters.

Table 3-186: +MTKP Set Command Parameters

<Parameter>	Description												
<CmdType>	2 Response for a "Get Inkey" 3 Response for a "Get Input"												
Values when CmdType=2 (Get Inkey)													
<Result>	0 Session ended by user. 1 Response given by the user. 2 Help information required by user.												
<Data>	Key pressed by the user.												
Values when CmdType=3 (Get Input)													
<Result>	0 Session ended by user. 1 Response given by the user. 2 Help information required by user.												
<Data>	String of characters entered by the user.												
Values when CmdType=16 (Set Up Event List)													
<Result>	5 User activity event. 6 Idle Screen Available event. 8 Language Selection event. 9 Browser Termination event.												
<Data>	None User activity event None Idle Screen Available event 0 Browser Termination event (user terminated) 1 Browser Termination event (error terminated) 4 String coded as follows: <table border="1" style="margin-left: 20px;"> <thead> <tr> <th>Byte(s)</th> <th>Description</th> <th>Length</th> </tr> </thead> <tbody> <tr> <td>1</td> <td>Language tag</td> <td>1</td> </tr> <tr> <td>2</td> <td>Length='02'</td> <td>1</td> </tr> <tr> <td>3-4</td> <td>Language</td> <td>2</td> </tr> </tbody> </table>	Byte(s)	Description	Length	1	Language tag	1	2	Length='02'	1	3-4	Language	2
Byte(s)	Description	Length											
1	Language tag	1											
2	Length='02'	1											
3-4	Language	2											
Values when CmdType=24 (DTMF service)													
<Result>	0 disable DTMF service. 1 enable DTMF, short tones. 2 enable DTMF, long tones.												
<Data>	None												

Note: If the SIM asks for yes/no answer then respond with 0 or 1.

Example

+ MTKP: 1,0,Hello

//Display text cmd was sent from SIM (number 1), with normal priority (number 0), and the text is "hello"

Send DTMF

This proactive SIM service command requests the G24-L to send a DTMF string after successfully establishing a call. This command can be used at any time during a call. The G24-L does not locally generate audible DTMF tones to play to the user.

This command can be activated/deactivated by the user using the command `+MTKP=24`. The setting defined by the user is retained during the currently active call and is restored after a power cycle. If a DTMF command is sent to the G24-L while this command is disabled, the G24-L sends an "Unable to process" terminal response to the SIM.

The terminal response indicating that the command has been performed successfully is sent after the complete DTMF string is sent to the network by the G24-L. If the command is in idle mode, or if a call is terminated or put on hold before the complete DTMF string is sent to the network, the G24-L informs the SIM using terminal response 20, with the additional information "Not in speech call". If the user indicates the need to end the proactive SIM application session while the G24-L is sending the DTMF string, the G24-L stops sending the string and sends the following terminal response, "Proactive SIM application session terminated by the user".

If the SIM includes an alpha identifier in the command, the G24-L displays this string for the user in the form of a `+MTKP` unsolicited response. In all other cases, no information is sent to the user.

Command Type	Syntax	Response/Action	Remarks
Set	<code>+MTKP=24,<enable/disable></code>	OK or: <code>+CME ERROR: <err></code>	The Set command activates and deactivates the send DTMF command.
Unsolicited Response		<code>+MTKP=24,<alpha identifier string></code>	
Read	<code>+MTKP?</code>	<code>+MTKP: 24,<status></code>	The Read command displays the current status of the send DTMF command.

The diagram below demonstrates the communication between the SIM, the G24-L and the TE regarding a DTMF command during an active voice call.

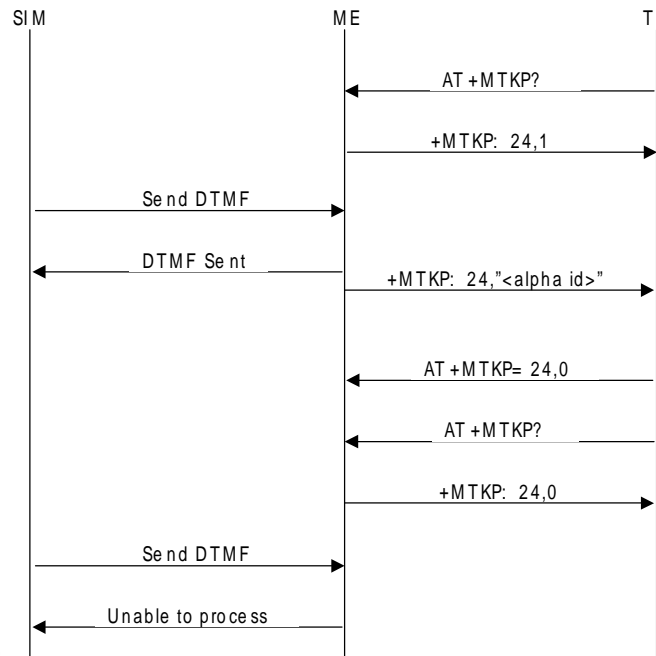

Figure 3-14: Communication During DTMF Command

Launch Browser

This is a proactive command that requests a browser inside a browser-enabled user terminal to interpret the content corresponding to a URL. It is forwarded to the TE using an unsolicited event mechanism.

Command Type	Syntax	Response/Action	Remarks
Unsolicited Response		+MTKP=26,<URL>,<bearers>,<proxy_Id>[,<alpha_id>]	

The TE answers this unsolicited response using the +MTKP command. For the general result, "launch browser generic error", the G24-L must provide additional information.

Command Type	Syntax	Response/Action	Remarks
	AT+MTKP=26,<Result>[<additional info>]	OK or: +CME ERROR: <err>	

The following table shows the +MTKP parameters for response code 26.

Table 3-187: +MTKP Parameters – Response Code 26

<Parameter>	Description
<result>	0 Success
	1 Failure
<additional info>	0 No specific cause can be given
	1 Bearer unavailable
	2 Browser unavailable
	3 G24-L unable to read provisioning data
Note: Additional info should be added only in case of failure.	
<err>	1 Unknown result value.

Note: When STK proactive commands are disabled by the TE, MTKP unsolicited events are not issued to it. In such a case, the Launch Browser command is rejected with the result value "Browser unavailable".

The diagram below demonstrates the communication during Launch Browser command.

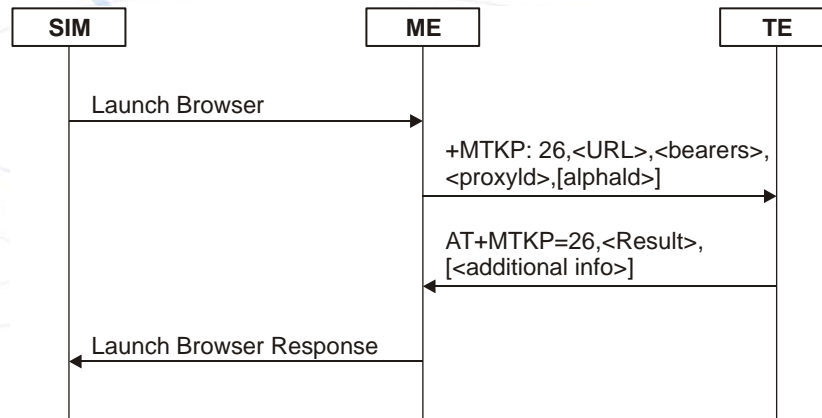

Figure 3-15: Communication During Launch Browser Command

Set Up Event List

The SIM card uses this command to supply a set of events, which becomes the current list of events for the G24-L to monitor, replacing any existing list. This command can also be used to remove the list of events. The list of events provided by the SIM is erased if the G24-L is powered down, or if the SIM is removed or electrically reset. When one of the events in the current list occurs, the G24-L uses the Event Download mechanism to transfer event details to the SIM.

The following table describes the events types.

Table 3-188: Current Event Types

Event	Notes
MT Call Event	Performed by G24; no indication sent to the TE.
Call Connected Event	Performed by G24; no indication sent to the TE.
Call Disconnected Event	Performed by G24; no indication sent to the TE.
Location Status Event	Performed by G24; no indication sent to the TE.
User Activity Event	Initiated by TE and reported via +MTKP command. TE is responsible for deciding what triggers this event. Only the event occurrence is monitored by G24; no additional information is required.
Idle Screen Available Event	Initiated by TE and reported via +MTKP command. TE is responsible for deciding what triggers this event. Only the event occurrence is monitored by G24; no additional information is required.
Card Reader Status Event	Issued by message handler of SCIM_CARD_DETECT_IND_ID message. Performed by G24; no indication sent to the TE.
Language Selection Event	TE is responsible for deciding what triggers this event. +MTKP command contains a data portion with language code – a pair of alphanumeric characters (defined in ISO 639 [29]), each of which is coded on one byte using the SMS default 7-bit coded alphabet, as defined in TS 23.038, with bit 8 set to 0.
Browser Termination Event	Initiated by TE and reported via +MTKP command. The command contains a data portion that includes the cause of termination: 0 User terminated 1 Error terminated TE is responsible for deciding what triggers this event.
Data Available Event	Performed by G24; no indication sent to the TE.
Channel Status Event	Performed by G24; no indication sent to the TE.

Command Type	Syntax	Response/Action	Remarks
Set	+MTKP=16,<result>[,<Data>]	OK or: +CME ERROR: <err>	The Set command defines the event type.
Test	+MTKP=?	OK	

The following table shows the Set Event List parameters.

Table 3-189: Set Event List Parameters

<Parameter>	Description												
<Result>	5 User Activity event 6 Idle Screen Available event 8 Language Selection event 9 Browser Termination event												
<Data>	None User Activity event None Idle Screen Available event 0 Browser Termination event (User terminated) 1 Browser Termination event (Error terminated) 4 Language Selection event, with string coded as follows: <table border="1" data-bbox="662 659 998 766"> <thead> <tr> <th>Byte(s)</th> <th>Description</th> <th>Length</th> </tr> </thead> <tbody> <tr> <td>1</td> <td>Language tag</td> <td>1</td> </tr> <tr> <td>2</td> <td>Length='02'</td> <td>1</td> </tr> <tr> <td>3-4</td> <td>Language</td> <td>2</td> </tr> </tbody> </table>	Byte(s)	Description	Length	1	Language tag	1	2	Length='02'	1	3-4	Language	2
Byte(s)	Description	Length											
1	Language tag	1											
2	Length='02'	1											
3-4	Language	2											

Note: Each language code consists of a pair of alphanumeric characters, defined in ISO 639 [4]. Each character is coded on one byte using the SMS default 7-bit coded alphabet, as defined in TS 23.038, with bit 8 set to 0. For a list of language codes, refer to the section that follows.

Language Codes

The following table lists an example of the codes for each language supported by the STK for Language Selection Events.

Table 3-190: Sample Language Codes

Code	Language
aa	Afar
ab	Abkhazian
af	Afrikaans
am	Amharic
ar	Arabic
as	Assamese
ay	Aymara
az	Azerbaijani
ba	Bashkir
be	Byelorussian
bg	Bulgarian
bh	Bihari
bi	Bislama
bn	Bengali;
bo	Tibetan
br	Breton
ca	Catalan
co	Corsican
cs	Czech
cy	Welsh
da	Danish
de	German
dz	Bhutani
el	Greek
en	English
eo	Esperanto
es	Spanish
et	Estonian
eu	Basque
fa	Persian
fi	Finnish

Table 3-190: Sample Language Codes (Cont.)

Code	Language
fj	Fiji
fo	Faroese
fr	French
fy	Frisian
ga	Irish
gd	Scots
gl	Galician
gn	Guarani
gu	Gujarati
ha	Hausa
he	Hebrew
hi	Hindi
hr	Croatian
hu	Hungarian
hy	Armenian
ia	Interlingua
id	Indonesian
ie	Interlingua
ik	Inupiak
is	Icelandic
it	Italian
iu	Inuktitut
ja	Japanese
jw	Javanese
ka	Georgian
kk	Kazakh
kl	Greenlandic
km	Cambodian
kn	Kannada
ko	Korean
ks	Kashmiri
ku	Kurdish
ky	Kirghiz

Table 3-190: Sample Language Codes (Cont.)

Code	Language
la	Latin
ln	Lingala
lo	Laothian
lt	Lithuanian
lv	Latvian,
mg	Malagasy
mi	Maori
mk	Macedonian
ml	Malayalam
mn	Mongolian
mo	Moldavian
mr	Marathi
ms	Malay
mt	Maltese
my	Burmese
na	Nauru
ne	Nepali
nl	Dutch
no	Norwegian
oc	Occitan
om	(Afan)
or	Oriya
pa	Punjabi
pl	Polish
ps	Pashto,
pt	Portuguese
qu	Quechua
rm	Rhaeto-Romance
rn	Kirundi
ro	Romanian
ru	Russian
rw	Kinyarwanda
sa	Sanskrit

Table 3-190: Sample Language Codes (Cont.)

Code	Language
sd	Sindhi
sg	Sangho
sh	Serbo-Croatian
si	Sinhalese
sk	Slovak
sl	Slovenian
sm	Samoan
sn	Shona
so	Somali
sq	Albanian
sr	Serbian
ss	Siswati
st	Sesotho
su	Sundanese
sv	Swedish
sw	Swahili
ta	Tamil
te	Telugu
tg	Tajik
th	Thai
ti	Tigrinya
tk	Turkmen
tl	Tagalog
tn	Setswana
to	Tonga
tr	Turkish
ts	Tsonga
tt	Tatar
tw	Twi
ug	Uighur
uk	Ukrainian
ur	Urdu
uz	Uzbek

Table 3-190: Sample Language Codes (Cont.)

Code	Language
vi	Vietnamese
vo	Volapuk
wo	Wolof
xh	Xhosa
yi	Yiddish
yo	Yoruba
za	Zhuang
zh	Chinese
zu	Zulu

+MTKM, Motorola ToolKit Menu

Command Type	Syntax	Response/Action	Remarks
Execute	AT+MTKM	+MTKM: <Alpha Identifier menu> +MTKM: <Idx1>, <NoOfItems>, <Alpha Idx1>, <Help Info> [<CR><LF>+MTKM: <Idx2>, <NoOfItems>, <Alpha Idx2>, <Help Info> [...]] OK	This command is sent when the customer application wants to see the SIM Toolkit Main menu. Note: This command invokes only the main send invocation of the Main menu. (Can be in any state or submenu.)
Set	AT+MTKM=<Cmd Type>[,<ItemId>]	OK or: +CME ERROR: <err>	The Set command is issued when the user wants to select an item from the menu.

The following table shows the +MTKM parameters.

Table 3-191: +MTKM Parameters

<Parameter>	Description
<CmdType>	0 Session terminated 1 Item selected 2 Help information request
<ItemId>	Item identifier of the selected item.

+MTKM, Motorola ToolKit Menu (Response)

Command Type	Syntax	Response/Action	Remarks
Response	AT+MTKM	+MTKM: [<DefaultItem>]<Alpha Identifier menu> +MTKM: <Idx1>, <NoOfItems>, <Alpha Idx1>, <Help Info> +MTKM: <Idx2>, <NoOfItems>, <Alpha Idx2>, <Help Info> [...]	This result appears after the SIM has sent the proactive command Select Item (as a result of the item selection by the user).

The following table shows the +MTKM unsolicited identification parameters.

Table 3-192: +MTKM Unsolicited Identification Parameters

<Parameter>	Description
<Alpha Identifier menu>	Alpha Identifier of the main menu.
<DefaultItem>	Default item.
<Idx>	Menu item identifier.
<NoOfItems>	Number of items in the current menu.
<Alpha Idx>	Alpha identifier of items.
<Help Info>	0 No help available 1 Help available

Example

Note: The following example is provider-specific, and is meant to demonstrate menu use via STK.

```

AT+MTKM //Display the main menu
+MTKM: SIM Applications //Main menu title
+MTKM: 1,3,BANK,0 //The main menu contains 3 items.
+MTKM: 2,3,SHOPPING,0
+MTKM: 3,3,WEATHER,0
OK

AT+MTKM=1,3 //Item 3 in the main menu has been selected.
OK //The Sel item menu has been sent from the SIM.
//Display data about the WEATHER menu
+MTKM: "WEATHER" //The WEATHER menu contains two items.
+MTKM: 1,2,"OVER THE WORLD",1
+MTKM: 2,2,"IN THE COUNTRY",0

```

```

AT+MTKM=1,1           //Select Item 1.
OK

+MTKP: 3,1,0,3,8,0,Enter Country name://User is requested to enter country name

AT+MTKP=3,1,"England" //User enters the country.
OK

//Text information is sent from the SIM.
+ MTKP: 1,0,"Weather in England is 5°C"

```

+MTKC, Motorola ToolKit Call Control

This unsolicited event notifies the terminal when supplementary services, SMS Control or Call Control are modified.

Command Type	Syntax	Response/Action	Remarks
Unsolicited event	+MTKC	+MTKC: <CCResult>[,<Number>]	

The following table shows the +MTKC parameters.

Table 3-193: +MTKC Parameters

<Parameter>	Description
<CCResult>	0 Control response not allowed. 1 Control response with modification.
<Number>	Called number or SS String in ASCII format.

+MTKA, Motorola Toolkit Acknowledge

This command sends acknowledge response from the user (TE) to the STK.

Command Type	Syntax	Response/Action	Remarks
Set	AT+MTKA=<n>	OK Or: +CME ERROR: <err>	Enable or disable the user ACK ability.
Execute	AT+MTKA		User sends ACK. Must enabled by the set command before use.
Read	AT+MTKA?	+MTKA:<n> OK	
Test	AT+MTKA=?	+MTKA:(0,1) OK	Shows list of supported <n>'s.

The following table shows the +MTKA parameters.

Table 3-194: +MTKA Parameters

<Parameter>	Description
<n>	Action type. 0 Disable (default). 1 Enable.

Notes: For <n> = 0 (disable)

All messages should be sent to the TE automatically.
Sending AT+MTKA has not influence.

For <n> = 1 (enable)

The first proactive message "Display Text" (+MTKP:1,...) should be sent to the TE. Until the user send acknowledge (by sending AT+MTKA command), NO other proactive of "Display Text" (+MTKP:1,...) or Menu message (+MTKM:...), should be sent to the TE. Other proactive or unsolicited indications and messages (RING, +CLCC:..., +MTKP:10, ...) should be sent automatically to the TE.

Example

```
AT+MTKA=?
+MTKA: (0,1)
```

```
OK
AT+MTKA=0 // set ACK to disabled
OK
AT+MTKA?
+MTKA: 0
OK
```

// Example of receiving messages from STK, and no ACK is required:

```
...
+MTKP: 1,0,"! YOUR RECHARGE OF TSH: 250.00 TO 0756706666 IS SUCCESSFUL"
+MTKP: 1,0,"Transaction successful!"
+MTKM: "VodaFASTA"
+MTKM: 96,5,Recharge,0
+MTKM: 97,5,Transfer,0
+MTKM: 98,5,Report,0
+MTKM: 99,5,Administration,0
+MTKM: 100,5,Exit,0
...
```

```
AT+MTKA=1 // set ACK to enabled
OK
AT+MTKA?
+MTKA: 1
OK
```

// Example of receiving messages from STK, and ACK is required:

```
...
```

```

+MTKP: 1,0,"! YOUR RECHARGE OF TSH: 250.00 TO 0756706666 IS SUCCESSFUL"
AT+MTKA // No other message should be display until this command sent.
+MTKP: 1,0,"Transaction successful!"
AT+MTKA // No other message should be display until this command sent.
+MTKM: "VodaFASTA"
+MTKM: 96,5,Recharge,0
+MTKM: 97,5,Transfer,0
+MTKM: 98,5,Report,0
+MTKM: 99,5,Administration,0
+MTKM: 100,5,Exit,0
...

```

TCP/IP

+MIPCALL, Create a Wireless Link

This command sets up a PPP (Point to Point Protocol) connection with the GGSN (Gate GPRS Support Node), and returns a valid dynamic IP for the G24-L.

Note: The DCD line changes only to reflect the state change from command mode to data mode.

Command Type	Syntax	Response/Action
Set	+MIPCALL= <Operation> [<APN>, <User name>, <Password>]	OK +MIPCALL: <"local IP address"> or: ERROR: <err> +MIPCALL: 0
Read	+MIPCALL?	+MIPCALL: <status>[,<IP>]
Test	+MIPCALL=?	+MIPCALL: (list of supported <operation>s)

Note: The +MIPCALL command does not return the prompt to the terminal until the IP is received from the provider, or time out has occurred, therefore, no other commands can be issued in the meantime.

The +MIPCALL command does not have a general ABORT mechanism, therefore a command cannot be issued until the previous command ends.

Note: When a call exists the dynamic IP address will be returned.

For example:

```

AT+MIPCALL?
+MIPCALL: 1,"172.17.237.80"

```

The following table shows the +MIPCALL parameters.

Table 3-195: +MIPCALL Parameters

<Parameter>	Description
<status>	0 Disconnect 1 Connected
"APN"	APN of service provider (in quotation marks). Contact your service provider for details.
"User name"	User name in provider server (in quotation marks). Contact your service provider for details.
"Password"	Password for provider server (in quotation marks). Contact your service provider for details.
Local IP-address	IP address given by server after PPP negotiation.

Example

```
AT+MIPCALL=1,"internet","User1","Pswd"//Connecting the provider 'Orange' and getting an IP
+MIPCALL: "123.145.167.230"
AT+MIPCALL=0 //The terminal hangs up the link
OK
```

+MIOPEN, Open a Socket (UDP or TCP)

This command causes the G24-L to initialize a new socket and open a connection with a remote side. Each socket allocates an accumulating buffer whose size is 1372 bytes.

Note: The +MIOPEN command returns a +MIPSTAT unsolicited event if it fails, for example, if it was rejected by the remote side.

MIPxxx is a complete set of GPRS commands. This set should not be used with other GPRS commands, such as CGATT, CGACT, and so on.

Command Type	Syntax	Response/Action	Remarks
Set	+MIOPEN= <Socket ID>, <Source Port>, <"Destination Address">, <Destination Port>,<Protocol>	OK +MIOPEN: <Socket ID>,<State> or: ERROR: <err>	

Command Type	Syntax	Response/Action	Remarks
Read	AT+MIOPEN?	+MIOPEN:[<SocketID>] for each socket that can be opened or: +MIOPEN 0 if there are no free sockets.	The Read command returns the numbers of the sockets that can be opened.
Test	AT+MIOPEN=?	+MIOPEN: (list of supported <socket ID>s),(list of supported <source port>s),(list of supported<"Destination IP">s), (list of <destination port>s),(list of supported <protocol>s)	

Example

```
+MIOPEN: 1 2 3 4           //All sockets closed
+MIOPEN: 1 3 4           //Socket 2 opened
```

The following table shows the +MIOPEN parameters.

Table 3-196: +MIOPEN Parameters

<Parameter>	Description
Socket ID	A unique number that identifies a connection (provided by the terminal application). 0 Invalid socket number 1,2,3,4 Valid socket number
Source Port	Port of source site. Port range: 1-65535 (decimal digits)
Destination Address	IP: IP of the destination site in the format "AAA.BBB.CCC.DDD". The range of each octant is 0-255. The value can be written in 1, 2, or 3 digits. Host name: Host-name of destination site. The host-name do not validate, except the maximum length (255 characters), the host-name convention should meet the rules as describe in RFC-1035 section: 2.3. Conventions.
Destination Port	Port of destination site. Port range: 1-65535 (decimal digits).
Protocol	Type of protocol stack. 0 TCP 1 UDP
State	State of socket or error indication. 0 Inactive 1 Active

Note: Motorola does not recommend using port numbers below 1024. These numbers are defined to be reserved for operating systems.

Example

```

AT+MIOPEN=1,1200,"123.245.213.012",1234,0//Opening socket 1, using TCP protocol, from port 1200,
targeting 123.245.213.012 port 1234
+MIOPEN=2,1300,"123.133.074.192",1242,1//Opening socket 2, using UDP protocol, from port 1300,
targeting 123.133.074.192 port 1242
AT+MIOPEN=1,1222,"123.245.213.012",1234,0//Opening socket 1, using TCP protocol, from port 1222,
targeting 123.245.213.012 port 1234
AT+MIOPEN:                               //Invalid command
ERROR
AT+MIOPEN?                               //Terminal checking the free sockets
+MIOPEN: 3 4
OK
AT+MIOPEN=1,0,"WWW.GOOGLE.COM",80,0//TCP
OK
+MIOPEN: 1,1
AT+MIOPEN=1,0,"www.google.com",80,0//TCP
OK
+MIOPEN: 1,1
AT+MIOPEN=2,0,"www.google.com",80,1//UDP
OK
+MIOPEN: 2,1

```

+MIPODM, Open a Socket (UDP or TCP) in Online Data Mode

This command causes the G24-L to initialize a new socket that waits for a connection from a remote machine or opens a connection with a remote side (according to received parameters) and switch it to Online (raw data transfer) Data Mode and open a connection with a remote side.

Notes: MIPxxx is a complete set of GPRS commands. This set should not be used with other GPRS commands, such as CGATT, CGACT, and so on.

Online Data Mode allows the user to transfer raw data from terminal to Network and vice versa over a GPRS channel. Currently, only RS232 connection to terminal with hardware flow control is supported.

Each socket allocates an accumulating buffer whose size is 1372 bytes. When the user sends amount of data, less than buffer size, the data is being sent to Network after a spooling timeout (200 mS), otherwise the data is being sent to Network immediately.

Only one socket is allowed at the same time in Online Data Mode.

The +MIPODM command returns a +MIPSTAT <Socket ID><Error> unsolicited event if it fails. For example, if it was rejected by the remote side.

Command Type	Syntax	Response/Action	Remarks
Set	AT+MIPODM= <Socket ID>, <Source Port>, <Remote IP>, <Remote Port>, <Protocol>	OK or: +MIPODM: <Socket ID>,<State>[,<Remote IP>,<Remote Port>] or: +MIPSTAT: <Socket ID>,<Status> or: ERROR: <err>	The Set command returns <Remote IP> and <Remote Port> parameters only for sockets opened in Listen mode.
Read	AT+MIPODM?	+MIPODM:[<SocketID>] for each socket that can be opened or: +MIPODM 0,0 if there are no free sockets.	When a socket opens in Online Data Mode, the command returns actual Socket ID value and '1' value (active). G24-L will be in pseudo-command mode for receiving the command.
Test	AT+MIPODM=?	+MIPODM: (list of supported <socket ID>s),(list of supported <source port>s),(list of supported<"Destination IP">s), (list of <destination port>s),(list of supported <protocol>s)	

The following table shows the +MIPODM parameters.

Table 3-197: +MIPODM Parameters

<Parameter>	Description
Socket ID	A unique number that identifies a connection. Valid socket numbers - 1,2,3 and 4
Source Port	Port of source site. Port range: 1-65535 (decimal digits)
Remote IP	IP of the remote site in the format "AAA.BBB.CCC.DDD". The range of each octet is 0-255. The value can be written in 1, 2, or 3 digits. Host-name of remote site. The host-name convention should meet the rules as describe in RFC-1035 section: 2.3 Conventions. Syntax is not validated, except the maximum length (255 characters).
Remote Port	Port of remote site. Port range: 1-65535 (decimal digits) for outgoing connection. Port 0 for incoming connection.
Protocol	Type of protocol stack. 0 TCP 1 UDP
State	0 Inactive 1 Active

Note: Motorola does not recommend using port numbers below 1024. These numbers are defined to be reserved for operating systems.

Example

Opening socket 3 in Online Data Mode, using TCP protocol, from port 1104, designation IP 123.245.213.012, designation port 1124:

```
AT+MIPODM=3,1104,"172.90.237.221",1124,0
```

OK

```
+MIPODM: 3,1
```

Enter invalid command format:

```
AT+MIPODM
```

ERROR

Check opened in Online Data Mode socket state when G24-L is pseudo-command mode:

```
AT+MIPODM?
```

```
+MIPODM: 3,1
```

OK

Listen socket over TCP:

```
AT+MIPODM=1,1100,"0.0.0.0",0,0 // Listens to any port at any IP.
```

OK

```
+MIPODM: 1,1,122.221.32.64,1200 // Remote side connected to the listen socket.
```

```
AT+MIPODM=3,3212,"122.1.222.134",0,0 // Listen to any port at specific IP.
```

OK

```
+MIPODM: 3,1,122.1.222.134,1222 // Remote side connected to the listen socket.
```

+MIPCLOSE, Close a Socket

This command causes the G24-L to free the socket accumulating buffer and to close the socket.

Note: All data stored in the accumulating buffer will be lost. Refer to “+MIPSETS, Set Size for Automatic Push” on page 3-283 and “+MIPPUSH, Push Data into Protocol Stack” on page 3-285.

Command Type	Syntax	Response/Action
Set	+MIPCLOSE = <Socket ID>	OK +MIPCLOSE: <Socket ID>[,<number_of_acknowledged_bytes >] or: ERROR
Read	+MIPCLOSE?	+MIPCLOSE 1234 +MIPCLOSE: [<socket ID>] - for all ACTIVE sockets.
Test	+MIPCLOSE=?	+MIPCLOSE: (1-4) OK

The following table shows the +MIPCLOSE parameters.

Table 3-198: +MIPCLOSE Parameters

<Parameter>	Description
<Socket_ID>	A unique number that identifies a connection. Valid socket numbers - 1, 2, 3, 4
<number_of_acknowledged_bytes >	Total number of bytes that were acknowledged.

Example

```
AT+MIPCLOSE=1           //The terminal closes the opened socket
OK
AT+MIPCLOSE=2           //The terminal closes the socket that wasn't opened
ERROR
AT+MIPCLOSE?            //Sockets 1 and 2 are opened
+MIPCLOSE: 1 2
AT+MIPCLOSE?            //No opened sockets
+MIPCLOSE: 0
```

+MIPSETS, Set Size for Automatic Push

This command causes the G24-L to set a watermark in the accumulating buffer. When the watermark is reached, data is pushed from the accumulating buffer into the protocol stack.

Data chunks between the terminal and the G24-L are limited to be smaller than 80 characters (160 characters in coded form). In order to reduce the overhead of sending small amounts of data over the air, the G24-L uses an accumulating buffer. The terminal can specify a watermark within the accumulating buffer size limits to indicate how much data should be accumulated. When the data in the accumulating buffer exceeds the watermark, only data equal to the watermark is sent. Data remaining in the buffer is sent with the next packet.

Note: If there is data in the accumulating buffer, the +MIPSETS command will be rejected.

Command Type	Syntax	Response/Action
Set	+MIPSETS= <Socket ID>,<Size>	OK or: ERROR +MIPSETS: <err>
Read	+MIPSETS?	+MIPSETS: [<SocketID>,<Current Size Settings>] For all ACTIVE sockets.
Test	+MIPSETS=?	+MIPSETS: (1-4),(list of supported <size>s)

The following table shows the +MIPSETS parameters.

Table 3-199: +MIPSETS Parameters

<Parameter>	Description
Size	Size of the buffer 1 < size ≤ 1372 The default value is 1372.
Extended err	3 Operation not allowed

Example

```
AT+MIPSETS=1,340           //Asks the G24-L to accumulate 340 bytes on socket 1 prior to sending
(socket should be activated by the +mipopen command)
+MIPSETS: 0
OK
AT+MIPSETS=1,200           //Asks the G24-L to accumulate 200 bytes on socket 1 prior to sending
(socket should be activated by the +mipopen command)
+MIPSETS: 0
OK
AT+MIPSETS=2,400           //Asks the G24-L to accumulate 400 bytes on socket 2 prior to sending
+MIPSETS: 0
OK
AT+MIPSETS=?
```

```

+MIPSETS: (1-4),(1-1372)
OK
AT+MIPSETS?
+MIPSETS: 1,100           //Information provided only for active sockets
+MIPSETS: 2,1372        //Information provided only for active sockets
OK

```

+MIPSEND, Send Data

This command causes the G24-L to store the data that the terminal provides in the accumulating buffer, and then send this data using an existing protocol stack when the amount of data reaches the predefined amount (see “+MIPSETS, Set Size for Automatic Push” on page 3-283). Before sending data, a valid connection must be created using the +MIPCALL and +MIPOPEN commands.

Motorola recommends that the terminal sets the watermark in the accumulating buffer prior to this command, using the +MIPSETS command. By default, the watermark is set to 1372 bytes of data.

Command Type	Syntax	Response/Action	Remarks
Set	+MIPSEND = <Socket ID>,<Data>	ERROR Or: +MIPSEND= <Socket ID>,<Status>,<Free Size>	Data in the +MIPSEND command is limited to 80 characters (160 in coded form). <Status>: 0 - Success 1 - Socket is flowed off
Read	+MIPSEND?	+MIPSEND <Socket ID>,<Free Size>>[<Socket ID> <Free Size>]<CR><LF> For all ACTIVE sockets.	
Test	+MIPSEND=?	ERROR	

The following table shows the +MIPSEND parameters.

Table 3-200: +MIPSEND Parameters

<Parameter>	Description
<socket ID>	1,2,3,4 Number of valid socket
<Free Size>	Free space in current buffer. Free size is calculated from the 1372. 0 < Free Size < 1372
<Data>	User data string is sent encoded with 0-F hexadecimal digits (String ends with a <CR>)

Example

```
(Socket 4 was not opened using +MIPOPEN AT command)
AT+MIPSEND=4,"4444"
ERROR
AT+MIPSEND=1,"4444"
+MIPSEND: 1,1370           //1372- 2 chars 'DD' = 1370
OK
AT+MIPSEND=?
ERROR
AT+MIPSEND?
+MIPSEND: 1,1372           //Sockets 1 and 2 were opened using + MIPOPEN AT command
+MIPSEND: 2,1372           //Sockets 1 and 2 were opened using + MIPOPEN AT command
OK
```

+MIPPUSH, Push Data into Protocol Stack

This command causes the G24-L to push the data accumulated in its accumulating buffers into the protocol stack. It is assumed that before using this command, some data should exist due to previous +MIPSEND commands.

Command Type	Syntax	Response/Action	Remarks
Set	+MIPPUSH = <Socket ID>[,<"Destination IP">,<Destination Port>]	+MIPPUSH: <Socket_ID>,<Status>[,<accumulated_sent_length>] OK Or: ERROR	Optional parameters are used only for UDP connections. If the Destination IP and Destination Port are not provided by the user, a datagram is sent to the last target (or the default target provided by the +MIPOPEN command). <accumulated_sent_length> - this parameter counts how many bytes were sent to the remote side by the G24-L TCP/IP stack. When user open socket, <accumulated_sent_length> initialized to zero. Size of <accumulated_sent_length> is four octets unsigned digit (0-4294967295). <Status>: 0 - Success 1 - socket is flowed off 2 - there is no data in socket to send
Read	+MIPPUSH?	MIPPUSH:[<socket ID>]	
Test	+MIPPUSH=?	MIPPUSH=<socket ID>,<IP>,<Port>	

The following table shows the +MIPPUSH parameters.

Table 3-201: +MIPPUSH Parameters

<Parameter>	Description
Socket ID	1,2,3,4 Number of valid socket
Destination IP	IP of destination site in the format AAA.BBB.CCC.DDD. The value can be written in 1, 2 or 3 digits.
Destination Port	0-65535 Port of destination site. Written in decimal digits.

Example

```
AT+MIPPUSH=1 //Terminal asks the G24-L to flush the buffer in socket 1 (was opened
using the +MIPOPEN command)
+MIPPUSH: 0
OK
```

+MIPFLUSH, Flush Data from Buffers

This command causes the G24-L to flush (delete) data accumulated in its accumulating buffers.

Command Type	Syntax	Response/Action
Set	+MIPFLUSH = <Socket ID>	ERROR or: +MIPFLUSH: <Socket ID> OK
Read	+MIPFLUSH?	+MIPFLUSH:[<socket ID>]
Test	+MIPFLUSH=?	+MIPFLUSH=(<Socket ID>)

The following table shows the +MIPFLUSH parameters.

Table 3-202: +MIPFLUSH Parameters

<Parameter>	Description
Socket ID	1,2,3,4 - Number of valid sockets

Example

```

AT+MIPFLUSH=2 //Socket number 2 was previously opened using the +MIOPEN
command
+MIPFLUSH: 2
OK
AT+MIPFLUSH=5
ERROR
AT+MIPFLUSH?
+MIPFLUSH: 1 2
OK

```

+MIPRUDP, Receive Data from UDP Protocol Stack

This unsolicited event is sent by the G24-L to the terminal when data is received from the UDP protocol stack.

Set Command Event

```
+MIPRUDP:<Source IP>,<Source Port><socket ID>,<Left>,<Data>
```

The following table shows the +MIPRUDP parameters.

Table 3-203: +MIPRUDP Parameters

<Parameter>	Description
Source IP	IP of the source
Source Port	Port of the source
Socket ID	1,2,3,4 - Number of valid sockets.
Left	Size of received Data still left in protocol stack.
Data	Data string received with 0-F hexadecimal digits. String ends with a <CR>.

Example

```
+MIPRUDP: 172.16.3.135,222,2,0,44444444
```

+MIPRTCP, Receive Data from TCP Protocol Stack

This unsolicited event is sent by the G24-L to the terminal when data is received from the TCP protocol stack.

Set Command Event

```
+MIPRTCP: <socket ID>,<Left>,<Data>
```

The following table shows the +MIPRTCP parameters.

Table 3-204: +MIPRTCP Parameters

<Parameter>	Description
Socket ID	1,2,3,4 - Number of valid sockets.
Left	Size of received Data still left in protocol stack.
Data	Data string received with 0-F hexadecimal digits. String ends with a <CR>.

Example

+MIPRTCP: 3,0,7171

+MIPSTAT, Status Report

This unsolicited event is sent to the terminal indicating a change in status. Currently there are two possible sources of failure, a broken logical connection or a broken physical connection.

Syntax

+MIPSTAT: <socket_ID>,<n>[,<number_of_acknowledged_bytes >]

The following table shows the +MIPSTAT parameters.

Table 3-205: +MIPSTAT Parameters

<Parameter>	Description
<SocketID>	A unique number that identifies a connection. Valid socket numbers - 1, 2, 3 and 4
<n>	0 - ACK indication 1 - Broken protocol stack
<number_of_acknowledged_bytes >	Total number of bytes that were acknowledged

Example

+MIPSTAT: 1,2

MIPXOFF, Flow Control - Xoff

This command is the unsolicited response that the G24-L sends to the terminal to stop sending data when it does not have enough memory to process new +MIPSEND requests. The G24-L uses the accumulating buffer prior to pushing data into the protocol stack. This memory resource is protected by a Xoff_upper watermark.

Event

+MIPXOFF: <Socket ID>

Example

+MIPXOFF: //The G24-L detects that the accumulating buffer 1 has reached its Xoff watermark.

From this point, the terminal is not allowed to send data, until it receives the +MIPXON command.

MIPXON, Flow Control - Xon

This command is the unsolicited event that the G24-L sends to the terminal when it detects that it has free memory in the accumulating buffer and can process new +MIPSEND requests, after the +MIPXOFF event.

Event

+MIPXON: <Socket ID>

Example

+MIPXON: 1 //The G24-L pushed the data into the protocol stack on socket 1 and is able to handle more data from the terminal.

MIPCONF - Configure Internal TCP/IP stack

This command allows to configure TCP stack parameters, such as retransmissions number, upper and bottom limits of retransmission timeout, close delay. It can be used to configure TCP socket

parameters before socket activation or when the socket is in active state. Configuration values will be stored in G24-L until power circle.

Command Type	Syntax	Response/Action	Remarks
Set	AT+MIPCONF=<socket>[,<retr_num>],[<min_TO>],[<max_TO>],[<max_close_delay>],[<is_nack_ind_req>]]	OK or: +CME ERROR: <err>	The Set updates TCP stack configuration parameters.
Read	+MIPCONF?	+MIPCONF: 1,<retr_num>,<min_TO>,<max_TO>,<max_close_delay>,<is_nack_ind_req> <CR><LF> +MIPCONF: 2,<retr_num>,<min_TO>,<max_TO>,<max_close_delay>,<is_nack_ind_req> <CR><LF> +MIPCONF: 3,<retr_num>,<min_TO>,<max_TO>,<max_close_delay>,<is_nack_ind_req> <CR><LF> +MIPCONF: 4,<retr_num>,<min_TO>,<max_TO>,<max_close_delay>,<is_nack_ind_req>	The read command returns current settings of TCP stack parameters.
Test	+MIPCONF=?	+MIPCONF: (1-4),(1-5),(1-10),(10-600),(1-75),(0-2)	The Test command returns the possible parameters values. Time values can be inserted with resolution of 100 milliseconds.

The following table shows the +MIPCONF parameters.

Table 3-206: +MIPCONF Parameters

Parameter	Description
< socket >	Number of configured TCP socket (1 to 4)
< retr_num >	Number of retransmissions (1 to 5)
< min_TO >	Bottom limit to retransmit timeout (100 ms to 1 sec.)
<max_TO>	Upper limit to retransmit timeout (1 sec. to 60 sec.)

Table 3-206: +MIPCONF Parameters

Parameter	Description
<max_close_delay>	Closing delay required by RFC 793 (100 ms to 7500 ms)
<is_nack_ind_req>	<p>NACK/ACK TCP indication feature.</p> <p>Activating this parameter enables G24-L to report the user, in case of losing a TCP connection, what data was received by the remote TCP layer.</p> <p>0 - feature inactive. 1 - NACK indication active. 2 - ACK indication active.</p> <ul style="list-style-type: none"> • Power Up - 0 • Default value - previously set value <p>This parameter resets after power cycle.</p>

Example

```

AT+MIPCONF=2,5,10,600,75,2
OK
AT+MIPOPEN=2,0,"66.249.87.99",80,0
OK
+MIPOPEN: 2,1
AT+MIPSETS=2,10
+MIPSETS: 0
OK
AT+MIPSEND=2,"474554202F20485454502F312E300D0A486F73743A207777772E676F6F676C652E636
F6D0D0A0D0A"
+MIPPUSH: 2,0,40
+MIPSEND: 2,0,1372
OK
+MIPXOFF: 2
AT+MIPSEND=2,"474554202F20485454502F312E300D0A486F73743A207777772E676F6F676C652E636
F6D0D0A0D0A"
+MIPSEND: 2,1,1372
OK
+MIPSTAT: 2,0,30
+MIPXON: 2
+MIPSTAT: 2,0,40
+MIPRTCP: 2,530,485454502F312E312033303220466F756E640D0A4C6F636174696F6E3A206874
74703A2F2F7777772E676F6F676C652E636F2E696C2F63786665723F633D505245462533443A544D25334
43131313935
+MIPRTCP: 2,450,31343833323A5325334467384A637631426A5458472D30636A5926707265763D
2F0D0A5365742D436F6F6B69653A20505245463D49443D363930376262383735313862663233373A43523D
313A544D3D
+MIPRTCP: 2,370,313131393531343833323A4C4D3D313131393531343833323A533D644F656476
7A6C34765F7059475A384A3B20657870697265733D53756E2C2031372D4A616E2D323033382031393A31
343A30372047
+MIPRTCP:
2,290,4D543B20706174683D2F3B20646F6D61696E3D2E676F6F676C652E636F6D0D0A436F6E74656E74
2D547970653A20746578742F68746D6C0D0A5365727665723A204757532F322E310D0A436F6E74656E
+MIPRTCP:
2,210,742D4C656E6774683A203231370D0A446174653A205468752C203233204A756E20323030352030383
A32303A333220474D540D0A436F6E6E656374696F6E3A20636C6F73650D0A0D0A3C48544D4C3E3C

```

```

+MIPRTCP:
2,130,484541443E3C5449544C453E333032204D6F7665643C2F5449544C453E3C2F484541443E3C424F44
593E0A3C48313E333032204D6F7665643C2F48313E0A54686520646F63756D656E7420686173206D
+MIPRTCP:
2,50,6F7665640A3C4120485245463D22687474703A2F2F777772E676F6F676C652E636F2E696C2F63786
665723F633D505245462533443A544D253344313131393531343833323A5325334467384A637631
+MIPRTCP:
2,0,426A5458472D30636A5926616D703B707265763D2F223E686572653C2F413E2E0D0A3C2F424F44593
E3C2F48544D4C3E0D0A
+MIPSTAT: 2,1,40

```

+MPING, Start Ping Execution (ICMP Protocol)

This command allows to verify IP connectivity to another remote machine (computer) by sending one or more Internet Control Message Protocol (ICMP) Echo Request messages. The receipt of corresponding Echo Reply messages are displayed, along with round trip times.

Valid IP address must be obtained using AT+MIPCALL command prior to starting ping execution.

Only one ping request execution will be allowed at any given moment.

Command Type	Syntax	Response/Action	Remarks
Set	+MPING=<mode>[,<"Destination IP/hostname">],[<count>][,<size>],[<TTL>],[<TOS>][,<TimeOut>]]]]]	OK or: +CME ERROR: <err>	The set command shall send a <count> Internet Control Message Protocol (ICMP) Echo Request messages to a target node defined by <"Destination IP/hostname"> parameter. If <mode> is equal 0, no parameters trailing <mode> parameter are allowed, otherwise ERROR message will be reported to DTE. If <mode> is equal 0, MS will abort sending Echo Request messages if ping request is in process, otherwise ERROR message will be reported to DTE.
Unsolicited Response		+MPING: <"Destination IP">,<type>,<code>[,<RTT>]	The receipt of corresponding ICMP Echo Reply messages will be displayed within unsolicited responses, along with round trip times.

Command Type	Syntax	Response/Action	Remarks
Read	+MPING?	+MPING: <count>, <size>,<TTL>, <TOS>,<TimeOut> OK	The read command displays currently selected parameters values for +MPING set command. If ping sending procedure is currently in process then user selected parameters for AT+MPING command will be displayed, otherwise default parameter values will be displayed.
Test	+MPING=?	+MPING: (List of supported <mode>s),(Range of <count>s),(Range of <size>s),(Range of <TTL>s), (Range of <TOS>s),(Range of <TimeOut>s) OK	The test command displays all supported parameters values for +MPING set command.

The following table shows the +MPING command parameters.

Table 3-207: +MPING Command Parameters

<Parameter>	Description
<mode>	0 - Abort current ping request execution. 1 - Launch new ping request. There is no default value - appropriate ERROR will be displayed if parameter is not supplied.
<"Destination IP/hostname">	Specifies the target machine (computer), which is identified either by IP address 4 octets long in dotted decimal notation or by host name of maximum 255 (not including double quotes) characters long in dotted notation. Each octet of IP address has valid value range of 0 to 255. Host names are not case sensitive and can contain alphabetic or numeric letters or the hyphen. There is no default value - appropriate ERROR will be displayed if parameter is not supplied.
<count>	Specifies a number of Internet Control Message Protocol (ICMP) Echo Request messages to send. Valid value range is from 1 to 255. Default value: 4
<size>	Specifies the length, in bytes, of the Data field in the Echo Request messages sent. The minimum size is 0. The maximum size is 1372. Default value: 32

Table 3-207: +MPING Command Parameters (Cont.)

<Parameter>	Description
<TTL>	Time To Live (TTL). Specifies number of hops (hop is one step, from one router to the next, on the path of a datagram on an IP network), which the Echo Request message may be routed over. The value is set by using TTL field in IP header. Valid value range is from 1 to 255. Default value: 64
<TOS>	The Type Of Service (TOS) is for internet service quality selection. The type of service is specified along the abstract parameters precedence, delay, throughput, and reliability. These abstract parameters are to be mapped into the actual service parameters of the particular networks the datagram traverses. Minimum and maximum values for TOS are 0 and 255 respectively. Refer to RFC 791 and RFC 2474 which obsoletes RFC 791 for TOS defined values. Default value: 0
<TimeOut>	Specifies the amount of time, in milliseconds, to wait for the Echo Reply message that corresponds to a sent Echo Request message, measured after Echo Request message was sent. If the Echo Reply message is not received within the time-out, +MPINGSTAT unsolicited response, with <status> equal to 1, will be sent to DTE. Valid value range is from 500 ms to 600,000 ms (10 minutes). Default value: 4000

The following table shows the +MPING unsolicited response parameters.

Table 3-208: +MPING Unsolicited Response Parameters

<Parameter>	Description
<"Destination IP">	Specifies the message sender machine (computer), which is identified by IP address 4 octets long in dotted decimal notation. Each octet of IP address has valid value range of 0 to 255. The message sender machine (computer) may be either the target of Echo Request message (if a response was an Echo Reply message) or a gateway (router) in a path of Echo Request message passage for any other ICMP response message.
<type>	The first octet of the ICMP header is a ICMP type field, which specifies the format of the ICMP message. Refer to IETF RFC 792 for <type> valid values.
<code>	The reasons for the non-delivery of a packet are described by code field value of ICMP header. Every <type> has its own defined <code> values. Refer to IETF RFC 792 for <code> valid values.
<RTT>	Specifies Round Trip Time (RTT) measured in milliseconds. This parameter will be reported in command response only if Echo Reply message was received.

Notes:

1. Ping request is being executed from the moment the valid AT+MPING set command was received by G24-L until +MPINGSTAT unsolicited report with <status> equal either to 0 or 2 is sent to DTE or ping request execution was aborted with AT+MPING=0 command. Refer to description of +MPINGSTAT unsolicited response for details.

2. In some cases, the reply message for an Echo Request message might be not an Echo Reply messages but rather some other ICMP message, which is reporting an error in datagram processing. For purpose of reporting an exact type of response for sent Echo Request message, unsolicited response includes <type> and <code> fields.

The first octet of the data portion of the IP datagram is an ICMP <type> field. The value of this field determines the format of the remaining data. The <type> and <code> fields jointly define ICMP message type.

For example, a case when an Echo Request message encapsulated in IP datagram to be forwarded by a gateway has exceeded TTL (equal zero). In this case the gateway must discard the datagram and may return an ICMP Time Exceeded message.

Example

```

AT+MPCALL=1,"internet"
OK
+MPCALL: 10.170.4.111
AT+MPING=1,"10.170.4.112" // Ping remote computer using default parameters
OK

+MPING: "10.170.4.112",0,0,400 //Echo Reply message received, RTT is 400 ms.

+MPING: "10.170.4.112",0,0,420

+MPING: "10.170.4.112",0,0,440
+MPING: "10.170.4.112",0,0,410

//Ping request execution is completed. Four Echo Request
messages were sent, and four //Echo Reply messages
were received. Average RTT is 417 milliseconds.

+MPINGSTAT: 0,"10.170.4.112",4,4,417

```

+MPINGSTAT, Status Update for +MPING Execution

This is the unsolicited response that the G24-L sends to the terminal to inform of ping execution status update and provides summary statistics of ping request when ping request execution is completed.

Command Type	Syntax	Response/Action	Remarks
Unsolicited Response		+MPINGSTAT: <status>[,<"Destination IP">,<SentMessages>,<ReceivedMessages>[,<AverageRTT>]]	The receipt of corresponding ICMP Echo Reply messages will be displayed within unsolicited responses, along with round trip times.

The following table shows the +MPINGSTAT unsolicited response parameters.

Table 3-209: +MPINGSTAT Unsolicited Response Parameters

<Parameter>	Description
<status>	<p>Specifies a status of ping request execution.</p> <p>Defined values:</p> <p>0 - The unsolicited response with this <status> will be sent to DTE upon completion of ping request. If ping request was aborted or socket connection was terminated for any reason, this unsolicited response will not be reported to DTE.</p> <p>1 - The unsolicited response with this <status> will be sent to DTE if no ICMP reply message was received within timeout.</p> <p>2 - The unsolicited response with this <status> will be sent to DTE if socket connection was terminated for any reason. This status essentially means that ping request execution was aborted.</p> <p>3 - Flow Control OFF. The unsolicited response with this <status> will be sent to DTE if phone doesn't have enough memory to process sending an Echo Request message.</p> <p>4 - Flow Control ON. The unsolicited response with this <status> will be sent to DTE if phone has enough memory to send an Echo Request message after flow control was OFF.</p>
<"Destination IP">	<p>Specifies the target machine (computer) for ping request, which is identified by IP address 4 octets long in dotted decimal notation. Each octet of IP address has valid value range of 0 to 255.</p>
<SentMessages>	<p>Specifies a total number of sent Echo Request messages.</p>
<ReceivedMessages>	<p>Specifies a total number of received Echo Reply messages corresponding to Echo Request messages.</p>
<AvarageRTT>	<p>Specifies average Round Trip Time (RTT) for this ping request. This value will be reported if and only if <ReceivedMessages> value is greater than zero. Calculation of this value comprises of accumulating all RTT values and dividing total accumulated RTT by <ReceivedMessages> value. Only an integral part of a result will be reported and any digits of a fraction part will be truncated.</p>

Example

```
AT+MIPCALL=1,"internet"
OK
+MIPCALL: 10.170.4.111
//Ping host www.motorola.com 3 times with <TTL>=255. All other parameters are default.

AT+MPING=1,"www.motorola.com",3,,255
OK

//ICMP Echo Reply message received, RTT is 522 ms.

+MPING: "88.221.5.223",0,0,522
+MPINGSTAT: 1 // No corresponding reply within timeout.

+MPINGSTAT: 3 // Flow Control OFF.

+MPINGSTAT: 4 // Flow Control ON, a new Echo Request message is sent immediately.
+MPING: "88.221.5.223",0,0,638
//Ping request execution is completed. Statistics displayed to terminal. Three Echo Request messages were
sent, and two Echo Reply messages were received. Average RTT is 580 milliseconds.

+MPINGSTAT: 0,"88.221.5.223",3,2,580
//Ping host www.motorola.com 1 time with <TTL>=1 and <size>=1372.
AT+MPING=1," www.motorola.com",1,1372,1
OK

//ICMP Time Exceeded message received. TTL expired in transit.

+MPING: "192.168.252.65",11,0

//Ping request execution is completed.

+MPINGSTAT: 0,"88.221.5.223",1,0
```

+MSDNS, Set DNS IP Address

This command set/read DNS (Domain Name Server) IP address (primary/secondary) for each socket. If the user doesn't specify DNS servers by AT+MSDNS, G24-L will use default DNS from NW. The defined value(s) will be saved during disconnect PDP context (can be used in next PDP context), but will reset after power cycle.

Command Type	Syntax	Response/Action	Remarks
Set	AT+MSDNS=[<Socket_id>[,<Primary DNS server IP>[,<Secondary DNS server IP>]]]	OK or: +CME ERROR: <err>	
Read	AT+MSDNS?	+MSDNS: 1,<Primary DNS server IP>,< Secondary DNS server IP><CR><LF> +MSDNS: 2,<Primary DNS server IP>,< Secondary DNS server IP><CR><LF> +MSDNS: 3,<Primary DNS server IP>,< Secondary DNS server IP><CR><LF> +MSDNS: 4,<Primary DNS server IP>,< Secondary DNS server IP><CR><LF> +MSDNS: 5,<Primary DNS server IP>,< Secondary DNS server IP><CR><LF> <CR><LF> OK	
Test	AT+MSDNS=?	+MSDNS: (List of supported <Socket_id>s),(<IP>),(<IP>)	

The following table shows the +MSDNS parameters.

Table 3-210: +MSDNS Parameters

<Parameter>	Description
<Socket_id>	A unique number that identifies a connection (provided by the terminal application). 0 - Invalid socket number 1,2,3,4 - Valid socket number 5 - Valid socket number dedicated to +MPING.
<Primary DNS server IP>, <Secondary DNS server IP>	IP of the destination site in the format "AAA.BBB.CCC.DDD". The range of each octant is 0-255. The value can be written in 1, 2, or 3 digits.

Example

```
AT+MSDNS=?
+MSDNS: (1-5),(<IP>),(<IP>)

OK
AT+MSDNS? // read when MIPCALL is disconnected
+MSDNS: 1,"0.0.0.0","0.0.0.0"
+MSDNS: 2,"0.0.0.0","0.0.0.0"
+MSDNS: 3,"0.0.0.0","0.0.0.0"
+MSDNS: 4,"0.0.0.0","0.0.0.0"
+MSDNS: 5,"0.0.0.0","0.0.0.0"

OK
AT+MSDNS=2,"212.150.49.10","206.49.94.234" //set socket 2 prim & sec DNS
OK
AT+MSDNS=4,"62.120.55.10" //set socket 4 prim DNS only
OK
AT+MSDNS=5,"212.150.49.10","206.49.94.234" //set socket 5 prim & sec DNS
OK
AT+MSDNS? // read when MIPCALL is disconnected
+MSDNS: 1,"0.0.0.0","0.0.0.0"
+MSDNS: 2,"212.150.49.10","206.49.94.234"
+MSDNS: 3,"0.0.0.0","0.0.0.0"
+MSDNS: 4,"62.120.55.10","0.0.0.0"
+MSDNS: 5,"212.150.49.10","206.49.94.234"

OK
AT+MIPCALL=1,"internet"
OK
+MIPCALL: 10.170.7.91

AT+MSDNS? // read when MIPCALL is connected
+MSDNS: 1,"192.118.9.177","192.118.11.77"
+MSDNS: 2,"212.150.49.10","206.49.94.234"
+MSDNS: 3,"192.118.9.177","192.118.11.77"
+MSDNS: 4,"62.120.55.10","192.118.11.77"
+MSDNS: 5,"212.150.49.10","206.49.94.234"

OK
AT+MSDNS=2 // socket #2 set to default values
OK
AT+MSDNS?
+MSDNS: 1,"192.118.9.177","192.118.11.77"
+MSDNS: 2,"192.118.9.177","192.118.11.77"
+MSDNS: 3,"192.118.9.177","192.118.11.77"
+MSDNS: 4,"62.120.55.10","192.118.11.77"
+MSDNS: 5,"212.150.49.10","206.49.94.234"

OK
```

+MIPCF, Control Filtering Feature for Incoming TCP Connection

The filtering feature aims to protect the G24-L from non-authorized clients trying to establish an IP connection with it. It is applicable for cases where G24-L communicates as a listener with others devices.

The filtering feature consists of a "white list" defined per connection. The "white list" can be configured when filtering feature is set to disable and before connection is established. Once a connection is established, changes in its "white list" are forbidden.

The following services are provided by the G24-L on behalf the "white list" management:

- Disable/Enable filtering on a connection;
- Add/Remove IP to/from "white list";
- Clear "white list"

After Power-up, the "white list" will be empty and disabled for all connections.

White List	List of IP addressed that represent devices which are allowed to establish an IP connection with G24-L. The white list is defined per connection.
Listen Mode	A mode in which the G24-L expects to received data from the other side.
IP CIDR	An efficient way to represent range of IP_Addresses. It composed of "IPaddr/A", where: IP_address's format is "AAA.BBB.CCC.DDD", /A indicates that the subnet mask would start with A 1 bits. See Figure 3-16 .

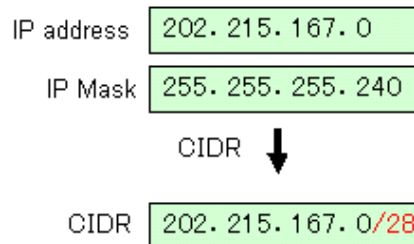

Figure 3-16: CIDR Scheme

Command Type	Syntax	Response/Action	Remarks
Set	+MIPCFE = <Socket ID>,<CmdType>,['<IP>']	Comment: IP in IP CIDR presentation OK or: +CME: <error code>	
Read	AT+MIPCFE?	+MIPCFE: 1,<STATUS>,<IP1.1>,<IP1.2....<IP1.n> +MIPCFE: 2,<STATUS>,<IP2.1>,<IP1.2....<IP2.n> +MIPCFE: 3,<STATUS>,<IP3.1>,<IP1.2....<IP3.n> +MIPCFE: 4,<STATUS>,<IP4.1>,<IP1.2....<IP4.n>	
Test	AT+MIPCFE=?	+MIPCFE=(1-4),(0-4),("IP in CIDR notation") OK or: +CME: <error code>	

The following table shows the +MIPCFE parameters.

Table 3-211: +MIPCFE Parameters

<Parameter>	Description	Value
<Socket_id>	Identification Number of Sockets.	0 - Invalid socket number. 1, 2 ... Max (=4).
<CmdType>	Operation that should be accomplished.	0 - Disable filtering. 1 - Enable filtering. 2 - Add IP to white list. 3 - Remove IP from white list. 4 - Clear IP white list.
<IP>	IP for an allowed node.	IP in format AAA.BBB.CCC.DDD. The range of each octant is 0-255. Value can be written in 1,2,3 digits. Fixed bit A: The range is 1 - 32. Value can be written in 1 or 2 digits.
<Status>	Indicate filtering status on socket.	0 - Disabled. 1 - Enabled. 2- Not applicable (when socket is opened as client).

The following table shows the +MIPCF filtering error codes and status.

Table 3-212: Filtering Error Codes and Status

<Parameter>	Description	Value
Error Codes	Extended error codes.	3 - Operation not allowed. 20 - Memory full. 22 - Not found. 35 - Text parameter instead of numeric parameter. 36 - Numeric parameter out of bounds. 282 - Inactive socket.
Status>	Socket filtering status.	2 - Not applicable. 1 - Enabled. 0 - Disabled.

NOP - Compatible

IGNORED (Compatible Only) Commands

The following commands return OK, but do not execute any operation. They are only used to provide backward compatibility.

Command	Description
F	Selects the line modulation standard
L	Monitors the speaker loudness
M	Monitors the speaker mode
N	Enables auto mode
P	Selects pulse dialing
T	Selects tone dialing
W	Wait for dial tone
Y	Disconnects on long space
&G	Selects the guard tone
&J	Jack type selection
&L	Leased line operation
&M	Asynch/synch mode connection
&P	Selects pulse dialing
&Q	Communications mode options
&R	Selects the CTC controls
&S	Defines the DSR behavior
&T	Selects tone dialing
\A	Sets the maximum MNP block size
\G	Sets the use of the Xon/Xoff flow control
\J	Adjusts the terminal auto rate
\K	This command is supported for backward compatibility only, and has no effect.
\N	Displays the link type
%C	Enables/disables data compression
\B	Transmits break to remote
\K	Breaks control
+CBAND	Changes band frequencies

Chapter 4: Using the Commands

Setting Up the G24-L (Power On and Initial Actions)

There are three phases of connectivity for the G24-L:

- Init General.
In this phase, the G24-L is asked to provide basic information which ensures that the phone is functioning properly.
- Enabling the SIM.
- Registering the SIM on a network in order to see that wireless access is functioning properly.

After these three phases are completed, G24-L is ready for action and you can send/receive voice calls, circuit switched data and GPRS.

The following figures show the phone state transactions:

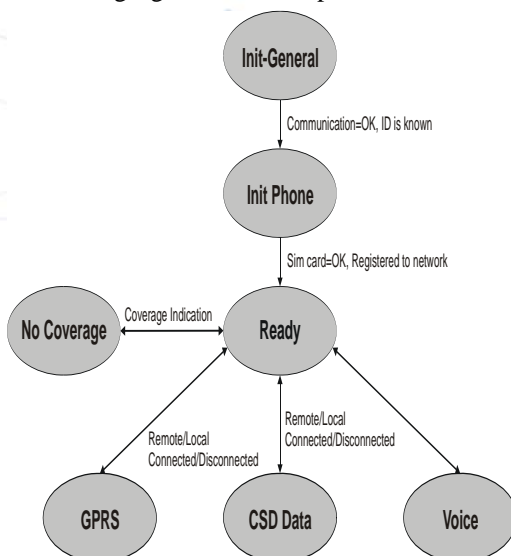

Figure 4-1: Phone State Transactions

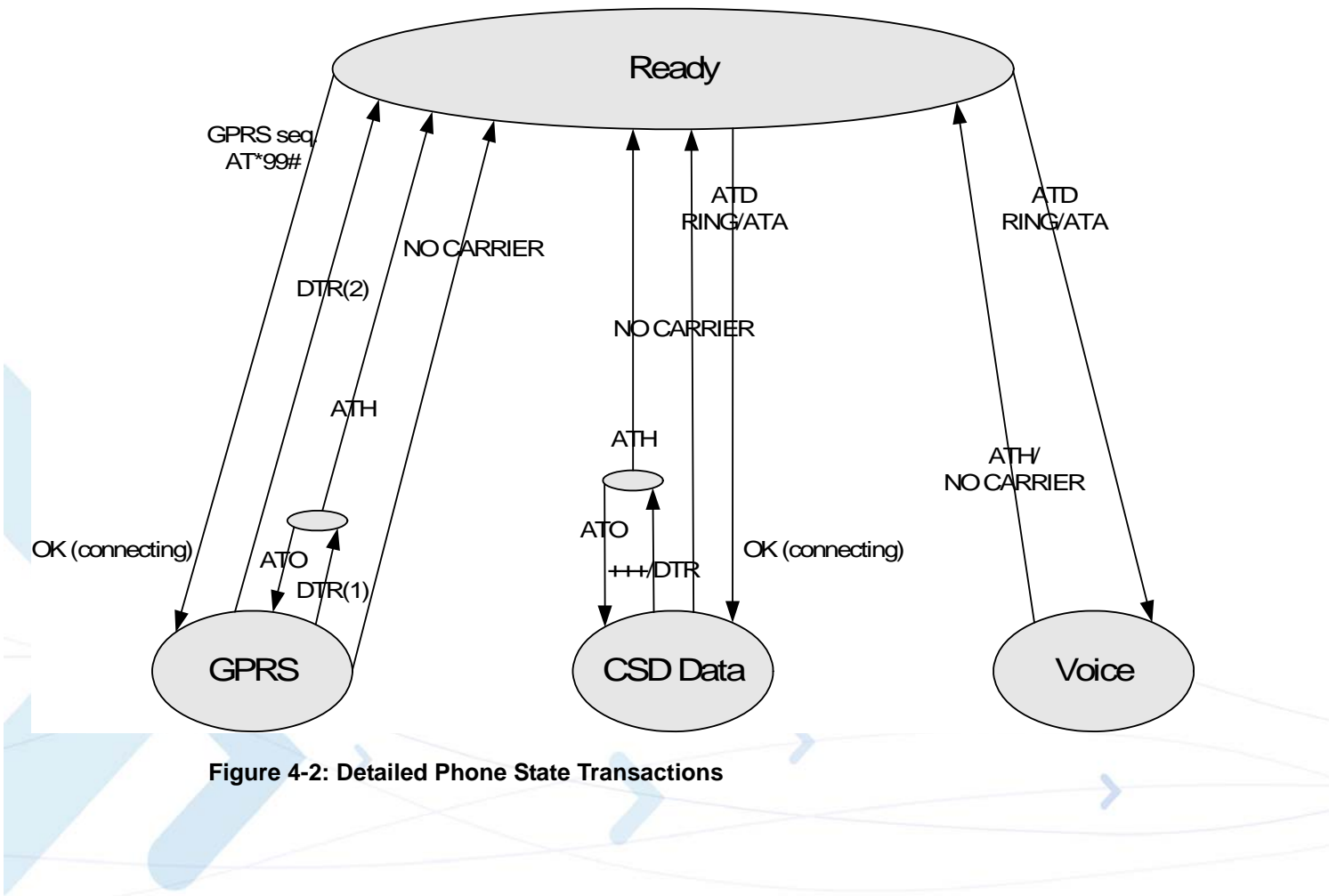

Figure 4-2: Detailed Phone State Transactions

Recommended G24-L Initialization after Powerup

Figure 4-3 provides a recommended workflow for initializing the G24-L after startup. The following sections explain this workflow in detail.

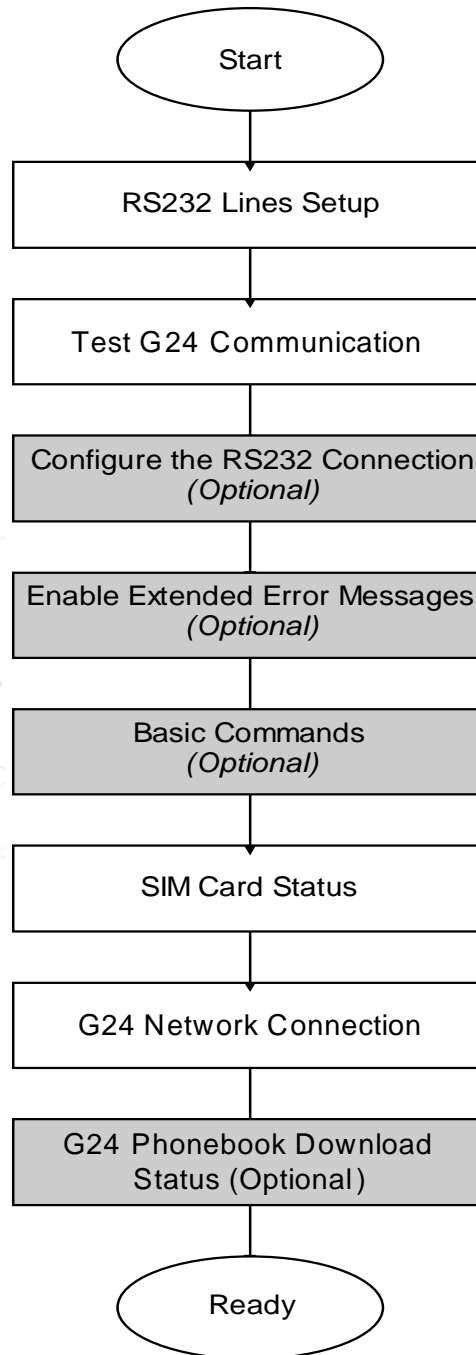

Figure 4-3: Recommended G24-L Initialization Workflow

RS232 Lines Setup

There is no dynamic detection. Upon power up, the hardware is detected. If USB is detected, then USB is selected. If USB is not connected, then the RS232 is selected. For a pin description, refer to the G24-L Developer's Kit Manual: 6802984C10.

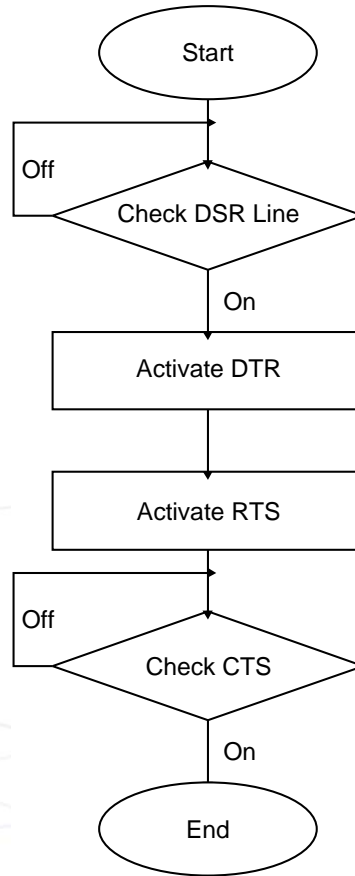

Figure 4-4: RS232 Lines Setup

Test G24-L Communication

This is a preliminary step. During this step, the ability to communicate with the G24-L using AT commands is tested.

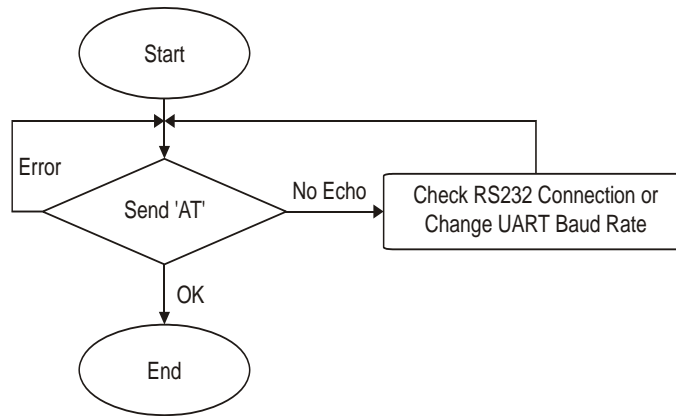

Figure 4-5: Test G24-L Communication

Communication example:

```

AT
ATE1 //By default, the echo should be enabled
AT
OK //Confirm that G24-L replies with OK
  
```

Basic Configuration

These are optional steps. If required, specific RS232 pin behavior can be selected. Extended error notification is recommended for debugging and field-support purposes.

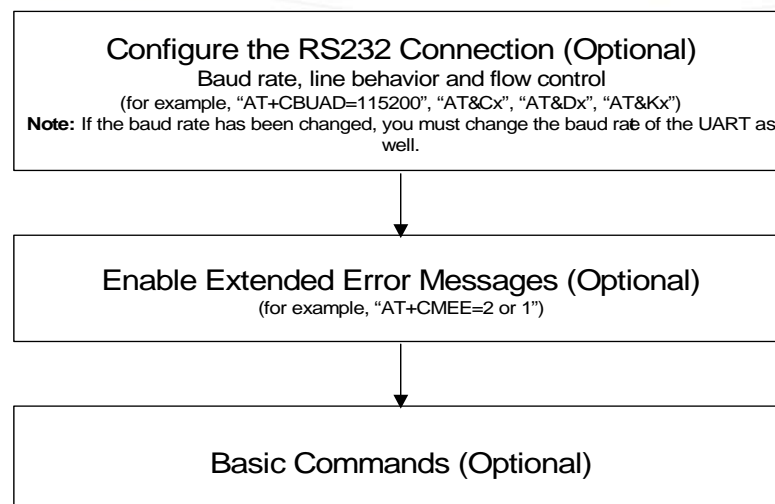

Figure 4-6: Basic Configuration

1. Baud setting example:
`AT+CBAUD=6//Setting baud rate for 19200`
`OK`
`AT+CBAUD=19200//Same as issuing this command`
`OK`
2. RS232 HW lines configuration: &C(DCD), &D(DTR), &K(flow-control).
Default settings should be:
`AT&C1`
`OK`
`AT&D2`
`OK`
`AT&K3`
`OK`
3. Modem IDs (optional): +CGMI,+CGMM,+CGMR,+CGSN
`AT+CGMI`
`+CGMI: "Motorola"`
`OK`
`AT+CGMM`
`+CGMM: "GSM900","GSM1800","GSM1900","GSM850","MODEL=G24-L"`
`OK`
`AT+CGMR`
`+CGMR: "G24-L_G_0C.11.45R"`
`OK`
`AT+CGSN//Read the IMEI number of the G24-L`
`+CGSN: 448954035283579`
`OK`
4. Error messages (optional): +CMEE, +CEER
`AT+CMEE=2 //Enable +CME ERROR: error messages verbose string`
`OK`
`AT+CEER=2//Enable +CEER: call status indication verbose string`
`OK`

SIM Card Status

To enable the module to transfer from basic commands to full operational mode, a SIM card must be ready and the PIN enabled.

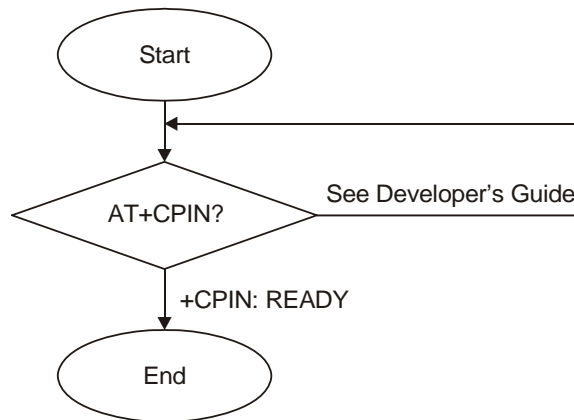

Figure 4-7: SIM Card Status

Note: For a full description of SIM states, see “[+CPIN, Enter PIN for Unlocking SIM Card or Enter PUK for Unlocking SIM Card](#)” on page 3-177.

The following steps are part of the SIM card status step:

1. Check SIM security: AT+CPIN?
2. Confirm that the result is +CPIN: READY
3. If the SIM PIN is required, then the following response appears: +CPIN: SIM PIN.
4. Unlock the SIM, if needed: AT+CPIN="XXXX".
Note: XXXX is the PIN password (4-8 digits long).
5. If the SIM PUK/PUK2 is required, then the following response appears: +CPIN: SIM PUK/PUK2.
6. Unblock the SIM, if needed: AT+CPIN="YYYYYYYY", "ZZZZ".

Note: YYYYYYYY is the PUK/PUK2 password (4-8 digits long).
ZZZZ is the new defined PIN/PIN2 password (4-8 digits long).

G24-L Network Connection

In this step, the G24-L detects existing networks (the user must register to a specific network).

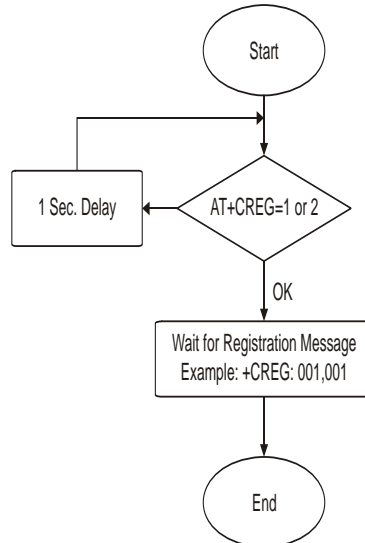

Figure 4-8: G24-L Network Connection

1. Registration and call indications example: +CREG, +CLCC

```
AT+CREG=2
```

```
OK
```

```
AT+CLCC=1
```

```
OK
```

2. Get available networks example: +COPS

```
AT+COPS=? //To read all possible operators
```

```
+COPS:(002,"ILORANGE","ORANGE","42501"), //G24-L answer example
```

```
(000,"AT&T Wireless", "AT&T","31038"),
```

```
(001,"IL Cellcom","Cellcom","42502"),
```

```
(003,"IL-77","IL-77","42577"),,(000,001,002,003,004),
```

```
(000,001,002)
```

3. Get registration messages example: +CREG

```
AT+CGREG=1
```

```
OK
```

```
+CREG: 001//G24-L example output when it is registered on the home network
```

```
Get GSM registration status: +CREG
```

```
AT+CREG=2//Get unsolicited GSM registration reports
```

```
+CREG: 001,2648, 988b
```

4. Get GPRS registration status example: +CGREG

```
AT+CREG=2//Get unsolicited GPRS registration reports
```

```
+CGREG: 001,2648,988b
```

Terminal Synchronization

In this step, the terminal requests the stored phonebook, SMS, and so on, from the G24-L.

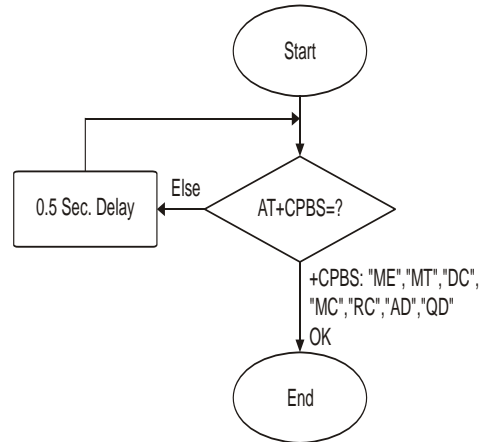

Figure 4-9: Terminal Synchronization

SMS

Managing Stored Messages in the G24-L Memory

```

AT+CPMS="me" //Select NVM as preferred memory storage using the +CPMS
command
+CPMS: 11,61,11,61,2,20
OK
AT+CMGF=1 // move to TEXT mode
OK
AT+CMGL="ALL" //List all messages in memory storage
+CMGL: 225,"STO UNSENT","054565132"
<Message body>
+CMGL: 223,"STO UNSENT","4565029" //Example of G24-L response
<Message body>
+CMGL: 222,"STO SENT","054565029"
<Message body>
+CMGL: 221,"STO SENT","054565132"
<Message body>
+CMGL: 220,"STO UNSENT",""
<Message body>
OK
AT+CMGL="STO UNSENT" //List all messages of a certain type (for example, stored
unsent messages)
+CMGL: 225,"STO UNSENT","054565132"
<Message body>
+CMGL: 223,"STO UNSENT","4565029"
<Message body>
+CMGL: 220,"STO UNSENT",""
<Message body>
OK
AT+CMGR=225 //Read any message from the list using its index
+CMGR: "STO UNSENT","054565132"
<Message body>
OK
AT+CMGR=9
+CMS ERROR: invalid index
AT+CPMS="sm"
+CPMS: 2,20,11,61,2,20
OK
AT+CMGR=9
+CMGR: "REC UNREAD","+97254565132",,"05/02/18,"21:22:23+08"
<Message body>
OK
AT+CSDH=1
OK
AT+CMGR=9
+CMGR: "REC UNREAD","+97254565132",,"05/02/18,"21:22:23+08",145,4,0,0,"+
97254120032",145,<message length>
<Message body>
OK

```

Setting the Notification Indication for Incoming Messages (Using AT+CNMI)

```

AT+CNMI=,1 //To receive indications of new incoming MT messages, the second
parameter of +CNMI should be set to 1
OK
+CMTI: "SM",4 //When a new MT message is received, the unsolicited response
+CMTI will be displayed, denoting the message index
AT+CMGR=4 //Use the new message index to read it
+CMGR: "REC UNREAD","+97254565132",,"05/02/13,07:15:36+08"
<message body>
OK
AT+CMGD=4 //Delete the message after reading it
OK

```

Another Possible Option for Setting the CNMI Notification Indication

```

AT+CNMI=,2 //To have new incoming MT messages displayed on the terminal, the
second parameter of +CNMI should be set to 2
OK
+CMT: "+97254565132",,"03/3/24,15:38:55"
<message contents> //When a new MT message is received, the unsolicited response
+CMT is displayed along with the message
AT+CNMA //To acknowledge receipt of a message, use the AT+CNMA command
within 60 seconds of the +CMT unsolicited response
OK

```

The acknowledged message is not saved in the database. If the +CMT unsolicited response is not acknowledged within 60 seconds, the new message is saved in database.

Setting TEXT Mode Parameters (Using AT+CMGW and AT+CMGS)

```

AT+CSMP?
+CSMP=17,167,0,0
OK
AT+CMGW="0544565034"
> text is entered <ctrl z>
+CMGW: 141
OK
AT+CSDH=1
OK
AT+CMGR=141
+CMGR: "STO UNSENT", "0544565034",,,129,17,0,0,167,"+ 97254120032",145,<message length>
<message body>
AT+CSMP= 1,256,0,0
+CMS ERROR: numeric parameter out of bounds

```

Writing, Saving and Sending Messages (Using AT+CMGW and AT+CMSS)

Writing messages into the database, with or without destination address. In TEXT mode, the header parameters will be set according to CSMP settings:

```

AT+CMGW                                     //Writing a message without destination address
> message text <ctrl z>
+CMGW: 142
OK
AT+CMGW="054565132"                         //Writing a message with destination address
> message text <ctrl z>
+CMGW: 143
OK
:
AT+CMSS=143                                  //Send a message to the destination address with which it was stored,
using the message index
OK
AT+CMSS=143,"054565029"                     //Send a message to a destination address, regardless of the
destination address with which it was stored (if any), using the message index
OK
AT+CMSS=3,"054565029"                       //In this way, received messages (stored in the inbox) can also be sent
OK
AT+CSMP=25,"05/03/15,21:22:23+08"
OK
AT+CMGW="0544565034"
A<CTRL+Z>
+CMGW: 129
OK
AT+CMGR=129
+CMGR: "STO UNSENT", "0544565034",,129,25,0,0,"05/03/15,21:22:23+08", "+972521100059",145,1
A
OK
AT+CMGF=0
OK
AT+CMGR=129
+CMGR: 2,,1
079179521201009519FF0A8150446505430000503051122232800141
AT+CMGW=24
> 079179521201009519000c917952428650290000AABBAABBAABB010441424344
+CMGW: 146
OK

```

Sending Messages (Using AT+CMGS)

Sends an SM from the G24-L to the network in TEXT mode, the header parameters will be set according to CSMP settings. In text mode (+CMGF=1):

```
AT+CMGS="054565028" //Writing a message to be sent to specified destination address
>This is the message body <CTRL+Z> //<CTRL+Z> ends the prompt text mode and returns to
regular AT command mode
+CMGS: 238 //Message successfully sent. Returns the Message Reference
OK
AT+CMGS="+97254565028",145 //Writing a message to be sent to specified destination address
>message text <CTRL/Z>
+CMGS: 239 //Message successfully sent . Returns the Message Reference
OK
```

Deleting Messages (Using AT+CMGD)

```
AT+CMGD=179 //Delete a message using its index
OK
AT+CMGR=179 //The message index is now empty
+CMS ERROR: invalid memory index
Delete a group of messages. Note that deletion of a number of messages may take a short time.
AT+CMGD=1, 1 //Delete all read messages
OK
AT+CMGD= 1,2 //Delete all read and sent messages
OK
AT+CMGD= 1,3 //Delete all read, sent and unsent messages
OK
AT+CMGD= 1,4 //Delete all messages
OK
```

Call Control

The following figure is a detailed view of the states the G24-L goes through for Voice and CSD Data, as shown in [Figure 4-2](#). Note that between the time the OK is received and the actual connection occurs, call state alerts are received.

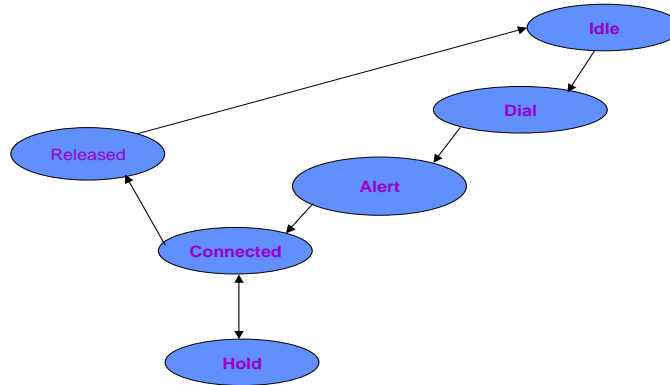

Figure 4-10: Call States

Dialing Using ATD

```

atd+44 34 56 78;           // VOICE call; number includes international access code
OK
OK
atd17085763400;          //Second VOICE call
OK
OK                          //Call to 44345678 is being put on hold
ath                        //Hang up active call
NO CARRIER
OK
AT+CHLD=0                 //Hang up held call
NO CARRIER
OK
atd+44 34 56 78          //DATA call
...
OK                          //Move to online Data state
//ESC sequence back to the Command state. +++ is sent from the
terminal (+++ is not displayed)
ath                        //Hang up data call
NO CARRIER
OK                          //Data call terminated
AT+FCLASS=1
OK
atd+44 34 56 78          //FAX call
...
NO CARRIER               //Fax call was terminated by remote side
  
```

```

atd035659260,345,22;           //VOICE call with tones sent after connecting
OK
OK
3 4 5                         //Sent as DTMF tones
...                            //Pause
2 2                           //Sent as DTMF tones
ath                            //Voice call is hung up
NO CARRIER
OK
atd0356592,60                 //DATA/FAX call with comma
                              //Comma is ignored; 035659260 is dialed

OK

```

Direct Dialing from Phone Book

This example uses a phone book with these pre-saved items.

```

AT+CPBS?
+CPBS: "MT"                   //Current phone book is now MT
AT+CPBR=1,260                 //This is a specific example with memory values
+CPBR: 5,"4444",129,"BE"
+CPBR: 6,"+97235659260",145,"eran"
+CPBR: 7,"035659260",129,"eran"
+CPBR: 8,"+97251632603",145,"long"
+CPBR: 9,"5555",129,"B"
+CPBR: 77,"035619942",129,"er"
atd>"long";
OK
OK                             //Exact match; 051 632603 call dialed; voice call answered
atd>8;
OK
OK                             //Speed-dial from current phone book; 051 632603 call dialed; voice
call answered
atd>"era"
OK
OK                             //Prefix pattern matched; entry for "eran" was selected;
+97235659260 call dialed
atd>"er"
OK
OK                             // Exact match; overrides prefix match; 03 5619942 call connected

```

In the next example, the current phone book is changed. The numbers are matched via a specific phone book specified in the command.

```

AT+CPBS="fd"                  //Change the current phone book to Fix-dialing phone book
OK
atd>MT9;
OK
NO CARRIER                   //Speed-dial number (using ") 5555 call dialed; number is incorrect
atd>MT;
OK
NO CARRIER                   //Speed-dial number 5555 call dialed, number is incorrect
atd>MT17
+CME ERROR: not found         //Trying to dial from a non-existent entry
atd>MT1117
+CME ERROR: invalid index     //Speed-dial number is out of range

```

Dialing the Last Number Example

```

atd035658278;
OK
OK
ath
NO CARRIER
OK
atdl //Last called number is "035658278"
ATDL: "035658278"
OK //DATA call
atdl;
ATDL: "035658278"
OK
OK //VOICE call
atdl //Last called number is "035658278,123,78;"
ATDL: "035658278"
OK //DATA call

```

Voice Call Manipulations

Call Waiting

```

AT+CCWA=1 //Enabling the call waiting on G24-L
OK
atd9311234567; //Originate a voice call
OK //Voice call connected
OK
(...conversation...)
+CCWA: "+358317654321",145,1,"Bob" //Call-waiting indication received by the G24-L; Bob is calling
+CCWA: "+358317654321",145,1,"Bob"
AT+CHLD=0 //Release the waiting call
OK
NO CARRIER //Current call is still active

```

Call Forwarding

```

AT+CCFC=1,3,"0545658278" //Network register UC forward-to of all classes
OK
AT+CCFC=1,1 //Network activate UC forward-to of all classes
OK //At this point, the G24-L will not receive any calls; all calls will be
//forwarded by the network to phone number 0545658278
AT+CCFC=1,2 //Interrogate reason unconditional of all classes
+CCFC: 1,1,"0545658278",129 //Class voice - UC forwarding is activated
+CCFC: 2,1,"0545658278",129 //Class data - UC forwarding is activated
+CCFC: 4,1,"0545658278",129 //Class fax - UC forwarding is activated
OK

```



Conference Call

```
atd051632601;           //Dialing the first member of the conference
OK
OK
AT+CHLD=2                //Call hold, switch command
OK                        //Active call switched to hold
atd035659260;           //Calling the second member of the conference
OK
OK
(Dual call state: one call on hold; 2nd is active.)
AT+CHLD=3                //Call link command
OK                        //Held call is linked to active call
(Active conference of two calls)
AT+CLCC                  //Verifying call state through CLCC
                          //(Verifying call state is optional.)
+CLCC: 1,0,0,0,1,"051632601",129,""
+CLCC: 2,0,0,0,1,"035659260",129,""
ath                       //Hang up the conference call
NO CARRIER              //First member dropped
NO CARRIER              //Second member dropped
OK
```

Data Call

Switching Modes (Data Mode/Command Mode)

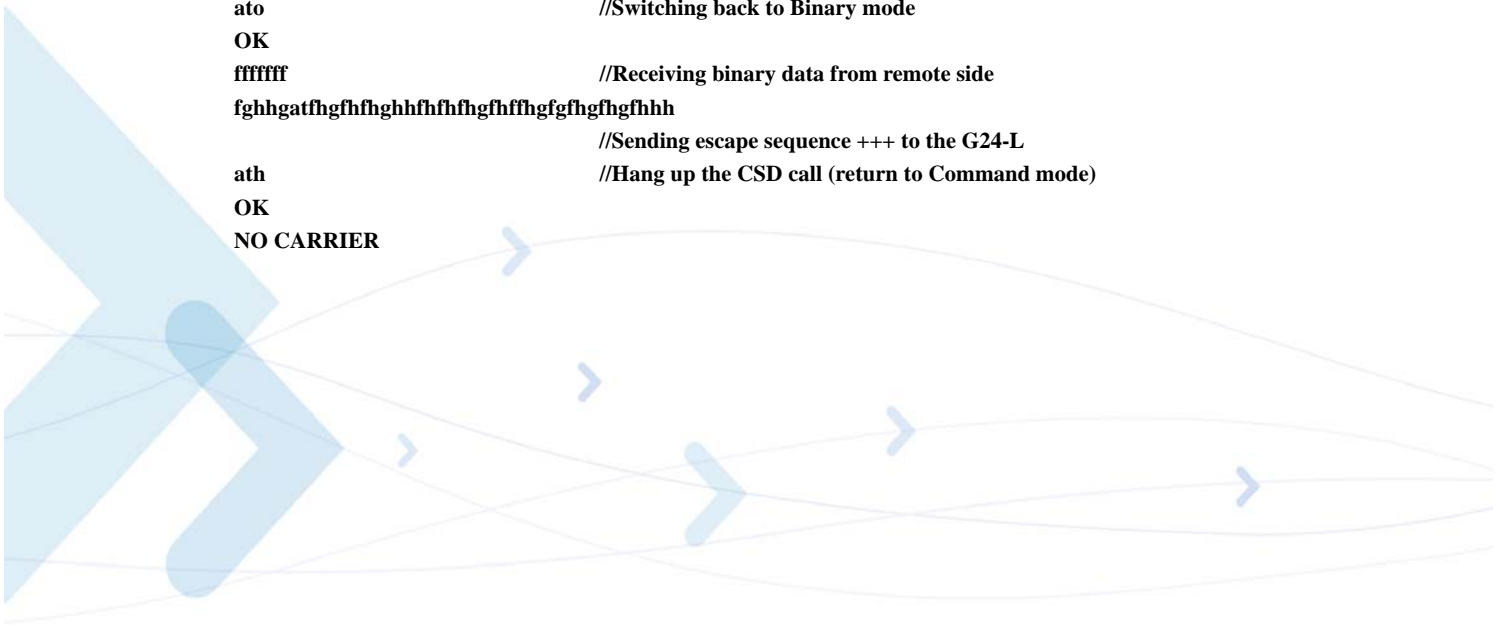
```
atd054565190           //Calling the remote modem
OK
aaaaaaaaaaaa           //Receiving binary data from remote side (G24-L is in Data mode)
//Sending escape sequence +++ to G24-L (the remote side does not treat +++ as escape)
OK                       //G24-L is in Command mode
ati3                     //Issuing an AT command
Motorola Mobile Phone
OK
ato                       //Switching back to Binary mode
OK
ffffff                 //Receiving binary data from remote side
fghhgatfhgfhfghhfhfhgfhffhfgfhgfhgfhhh
//Sending escape sequence +++ to the G24-L
ath                       //Hang up the CSD call (return to Command mode)
OK
NO CARRIER
```



GPRS

When using the GPRS, it is recommended to implement a "keep alive" mechanism.

The G24-L memory resources should not be used as a buffer for the user, the user maintains its own memory and flow control in its own application. The G24-L has finite limited resources such as network related, SIM card and phone memory. In general the user should use a single resource at a time. As an example, when G24-L GPRS network resources are in an active session, user should not manually detach from the network or place a CSD call etc.

Note: The basic GPRS concept is be "always connected" and there is no charge for being connected (only per real data transferred). GPRS users are advised to connect the GPRS network once in the beginning of a session and remain connected rather than to toggle from online to offline and back in a high rate. In specific cases when this is needed, contact customer care for advice and knowledge base.

Establishing GPRS PDP Context

When using the GPRS network for any IP data, you must be attached to the GPRS network before activating PDP context.

Activating a Saved Profile in G24-L

```
AT+CGATT=1 //By default, after power-up, the G24-L attaches to the GPRS
network, if possible (if the network and SIM allow)
AT+CGATT? //Check your connection status
AT+CGDCONT=1,"IP","RTY","123.32.45.9"//Context definition example
```

Two Ways to Activate PDP Context

Each of the two main ways in which to activate PDP context are described below.

Using the GPRS Wizard Application

1. Double-click the button predefined as the dialer for this provider to automatically establish PDP context. If the G24-L was not previously attached to GPRS, it will be attached automatically.
2. Setup configuration.
3. Enter into the wizard, the parameters provided by your operator.
4. Set definitions to allow your http/ftp browser to use the G24-L as a port to the Internet.
5. Usage:
 - Open the GPRS Manager.
 - Double-click the dialer icon to select and activate the provider of your choice (multiple providers may be displayed in the list).
 - After dialing, your temporary IP address, the GPRS DATA session message will be displayed.
 - Minimize the GPRS wizard window and use your http/ftp browser (Internet Explorer, Netscape).

Using the ATD* Command Set

Request GPRS service 'D':

```
ATD*99***(CID)#
```

The CID (Context ID) includes the APN (defined by the AT+CGDCONT command) to which you want to be connected. This depends on the ability of the SIM card to be attached to the different networks.

The format ATD*99# may also be used. In this case, the G24-L will first try to activate a non-empty (predefined) CID. If the attempt fails, the G24-L will try the next CID, and so on.

Note: When buffering the terminal message, data in the G24-L (both inbound and outbound data), the following apply:

- Turning off the G24-L clears any buffered data.
- Removing power from the G24-L clears any buffered data.
- Whenever the terminal drops the PPP connection with the G24-L, via LCP terminate, the buffered data is cleared.
- Whenever the G24-L drops the PPP connection with the terminal, with LCP terminate, the buffered data is cleared. LCP termination triggers the termination of the data in the G24-L buffer.
- Whenever the G24-L drops the PPP connection with the terminal, without an LCP terminate, the buffered data is cleared. Dropping the DTR also clears the buffer.
- When the network sends a deactivation message or a detached message, the G24-L buffer is cleared.
- When the G24-L transfers data in the uplink and GPRS coverage is lost, the data may flow-off. If the mobile has lost coverage and is unable to send the packets from the terminal to the network, the buffers will continue to store the packets until the buffers are full. The terminal will then be flowed off and the packets will be stored until they can be sent to the GPRS network.
- The amount of time that takes before the user is notified is specified in the T3312 timer that is located in the mobile side. The default delay time of T3312 is 54 minutes, as per the GSM 0408 specification. After 54 minutes, the G24-L deactivates the PDP session.

Changing the Character Set

Example

When an SMS messages with the following text: "Motorola G24-L OEM Module", is saved inside the G24-L at entry 128, you can read it using several character sets.

When the "ASCII" character set is used, the following is received by the terminal:

```
AT+CSCS?                //Read the current character set
+CSCS: "ASCII"          //Currently using ASCII character set
OK
AT+CMGR=128             //Read SMS entry 128
+CMGR: "STO UNSENT", ""
Motorola G24-L OEM Module //The content of SMS entry 128
OK
```

When the "UCS2" character set is used, the following is received by the terminal:

```
AT+CSCS?                //Read the current character set
+CSCS: "UCS2"           //Currently using UCS2 character set
OK
AT+CMGR=128
+CMGR: "STO UNSENT", ""
004D006F0074006F0072006F006C006100200067003200300020004F0045004D
0020004D006F00640075006C0065 //The content of SM entry 128
OK
```

The following is an ASCII translation of the SM contents:

004D	M
006F	o
0074	t
006F	o
0072	r
006F	o
006C	l
0061	a
0020	[space]
0067	g
0032	2
0030	0
0020	[space]
004F	O
0045	E
004D	M
0020	[space]
004D	M
006F	o
0064	d
0075	u
006C	l
0065	e

As this SMS was originally written in ENGLISH, meaning ASCII letters, each digit quadruplet starts with double zeros (00). When other languages are used, the quadruplets have different values.

Sleep Mode

Note: The notation of TXD and RXD are from the perspective of the terminal unless otherwise specified.

The terminal should activate Sleep mode by sending `ATS24=n` (n - number of seconds). To disable Sleep mode, send `ATS24=0`.

Example of G24-L Entering Sleep Mode

Terminal-TX: `ATS24=n`

Terminal-TX: `ATxxx`

Terminal-Wakeup-In=Inactive//n seconds passed since last command (and other conditions met)

G24-L-CTS=Inactive//G24-L enters Sleep mode

Example of Terminal Wake G24-L Sleep Mode

Terminal-Wakeup-In=Active

G24-L-CTS=Active//G24-L exits Sleep mode

Terminal-TX: `ATxxx/30` mseconds passed since Terminal-Wakeup-In became active

Example of G24-L Wake Terminal Up

G24-L-CTS=Active//G24-L internal event occurred. Incoming call is pending
//G24-L exits Sleep mode

G24-L-Wakeup-Out=Active

G24-L-TX: `RING/T` mseconds passed since Terminal-Wakeup-Out became active
(T is defined by `ATS102`.)

The figure below shows a Sleep mode example when $S24 > 0$.

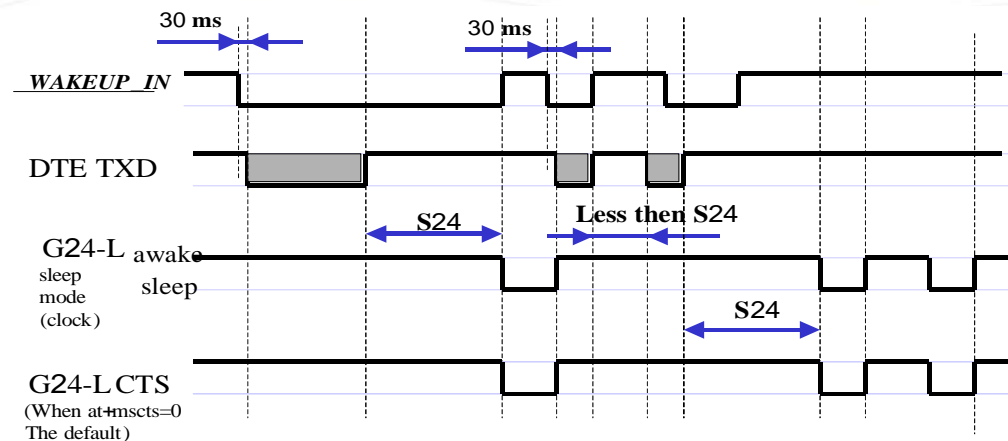

Figure 4-11: Sleep Mode when $S24 > 0$

STK

Display Text/Display Idle Mode Text

The SIM card requests to send text to the G24-L and the G24-L displays it on the terminal.



Figure 4-12: Display Text

Get Inkey

The SIM card requests to display text on the terminal, and waits for a response from the terminal (user). The response is a single character.

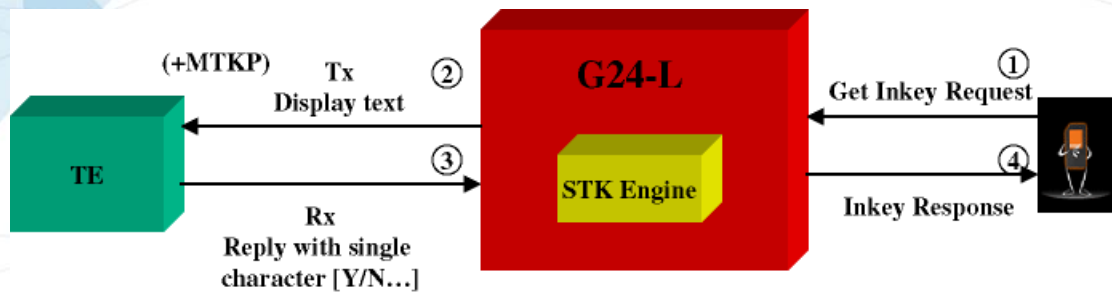

Figure 4-13: Get Inkey

Note: All responses to unsolicited events are expected within one minute.

Get Input

The SIM card requests to display text on the terminal, and waits for a response from the terminal (user). The response is a string.

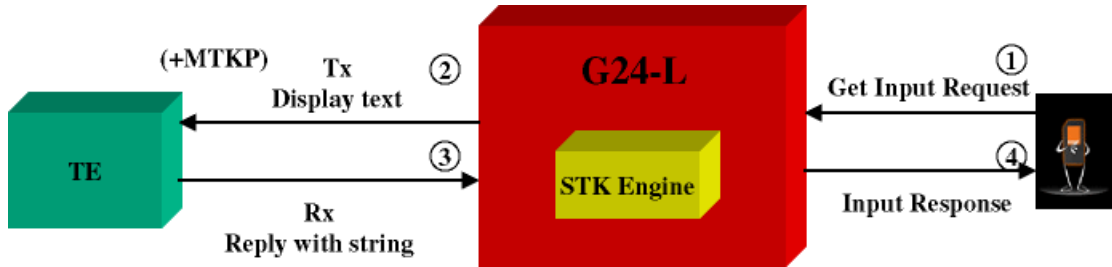

Figure 4-14: Get Input

Note: All responses to unsolicited events are expected within one minute.

Play Tone

The SIM card requests a tone to be played via the SIM. The G24-L sends information about the play tone to the terminal.

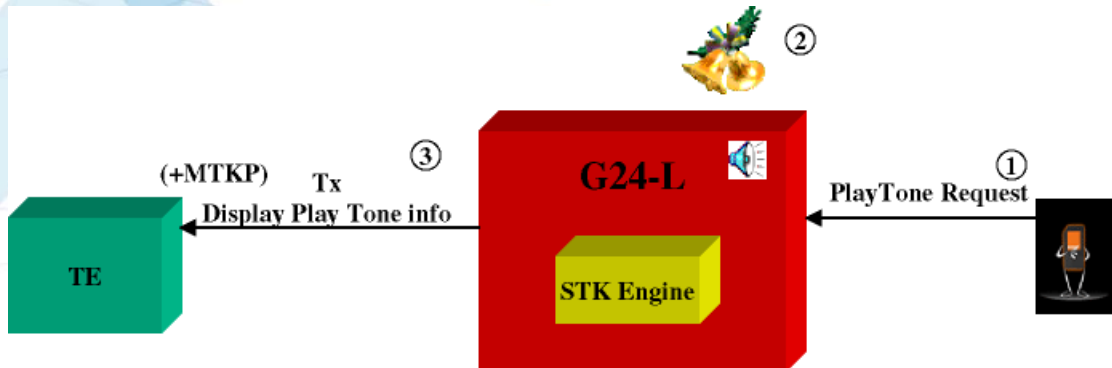

Figure 4-15: Play Tone

Set Up Menu

The terminal requests the STK menu. As a result, the SIM sends the menu items to the terminal. The user then selects an item from the menu.

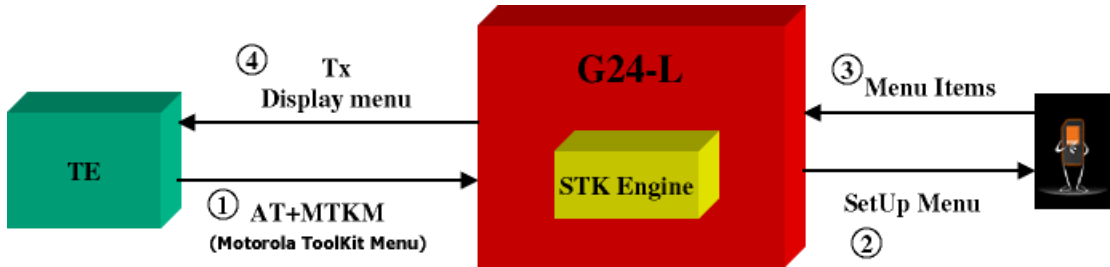

Figure 4-16: Set Up Menu

Select Item

The user selects an item. As a result, the SIM sends a response to the terminal.

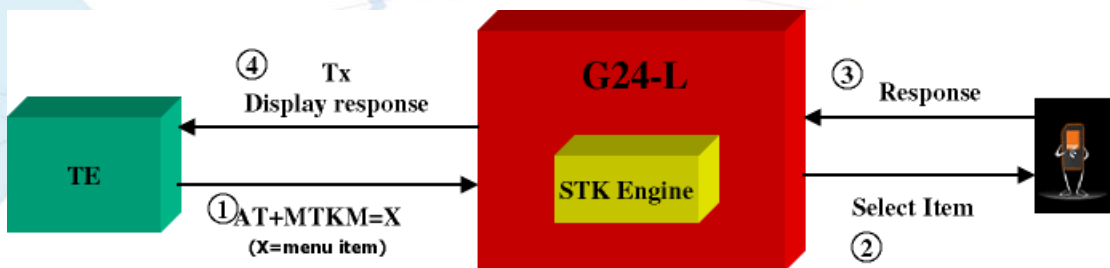

Figure 4-17: Select Item

Send SMS

The SIM requests to send SMS, and the SMS data is displayed on the terminal.

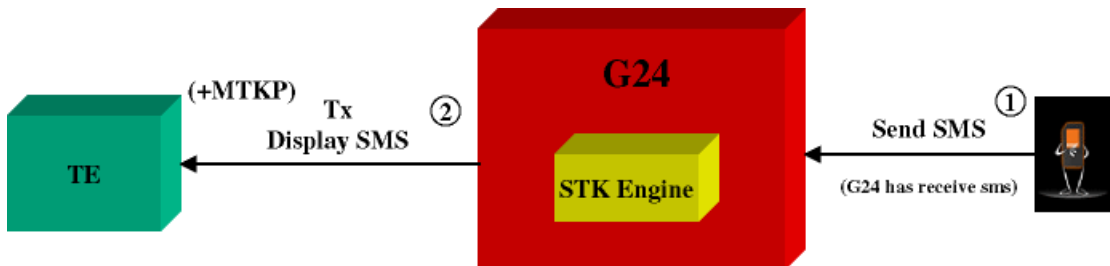

Figure 4-18: Send SMS

Set Up Call

The SIM initiates a call, and its data is displayed on the terminal.

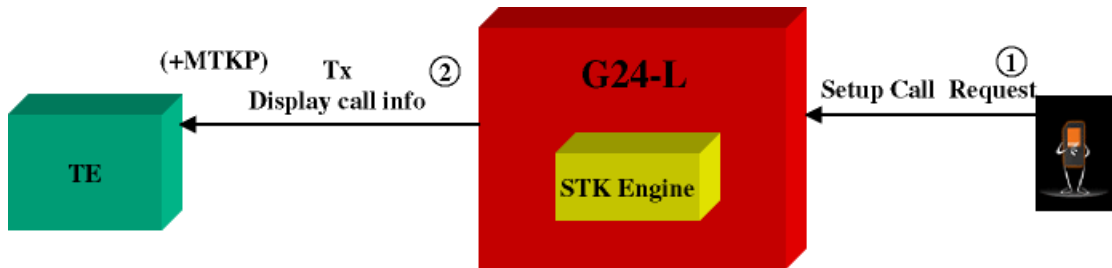

Figure 4-19: Set Up Call

Call Control

1. First, the user makes a call.
2. The call number is sent to the SIM, which decides whether to change the number or not. If the call has been changed, the new number is displayed on the terminal.

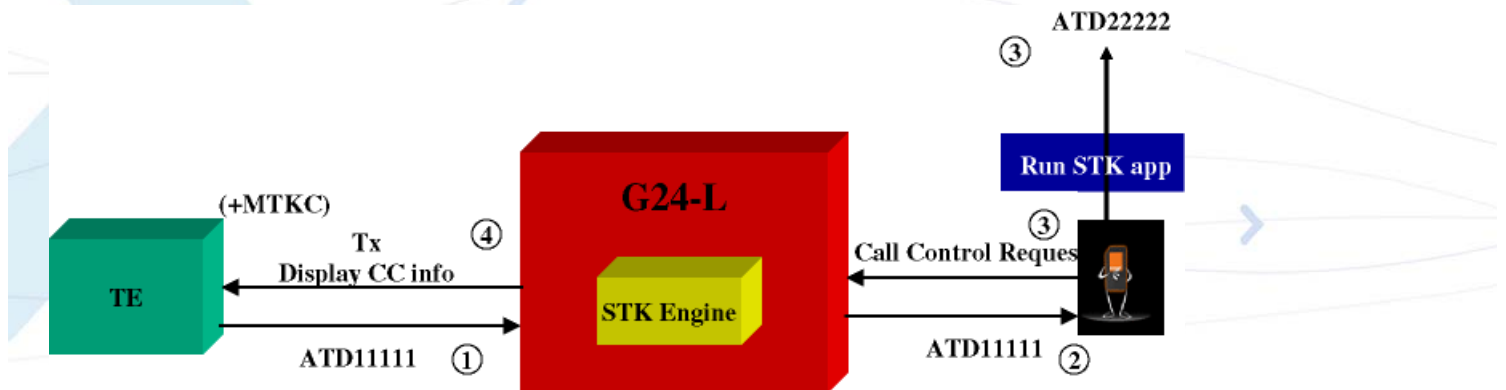

Figure 4-20: Call Control

Example

```

AT+MTKM //Displays the main menu
+MTKM: SIM Applications //Main menu title
+MTKM: 1,3,BANK,0 //The main menu contains three items
+MTKM: 2,3,SHOPPING,0
+MTKM: 3,3,WEATHER,0
OK

AT+MTKM=1,3 //Item 3 in the main menu has been selected
OK //The Sel item menu has been sent from the SIM

+MTKM: "WEATHER" //Displays data about the WEATHER menu
The WEATHER menu contains two items
+MTKM: 1,2,"OVER THE WORLD",1
    
```

```
+MTKM: 2,2,"IN THE COUNTRY",0
```

```
AT+MTKM=1,1 //Select Item 1.
OK
```

```
+MTKP: 3,1,0,3,8,0,Enter Country name://User is requested to enter country name
AT+MTKP=3,1,"England" //User enters the country
OK
```

```
+MTKP: 1,0,"Weather in England is 5°C"//Text is sent from the SIM
```

Send DTMF

The SIM card requests to send a DTMF string. The G24-L sends the DTMF during an active voice call, and notifies the terminal using an +MTKP of this sending action. The G24-L responds with the status of the sending result to the SIM.

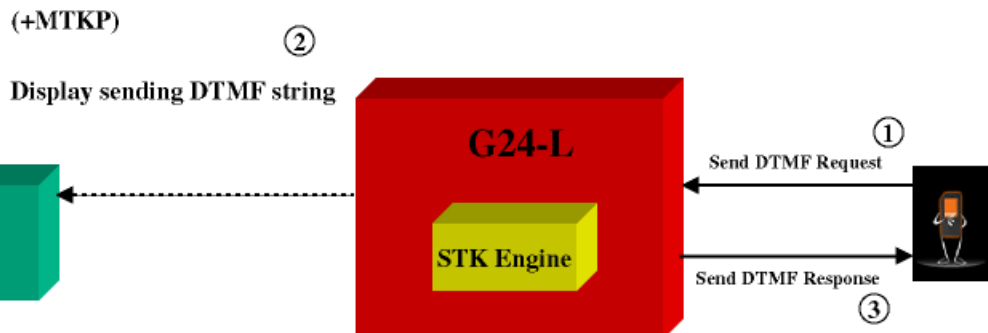

Figure 4-21: Send DTMF

Launch Browser

SIM card requests to open a browser with a specific URL and info. The G24-L notifies the terminal and waits for the request results. The terminal must respond to the G24-L with a result. The terminal result is passed to the SIM by the G24-L.

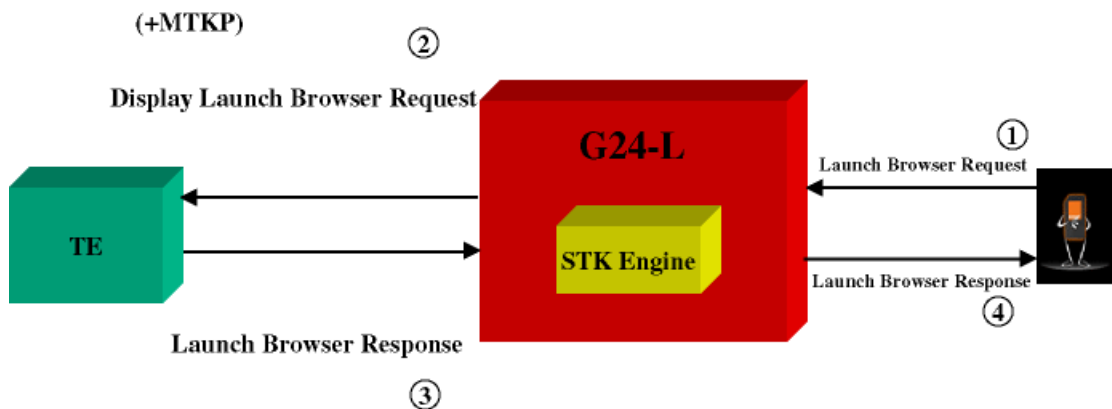

Figure 4-22: Launch Browser

Setup Event List

The terminal updates the G24-L on any of the events. The G24-L passes events from the terminal to the SIM card according to the event list. The event list is requested by the SIM using the "setup event list" command.

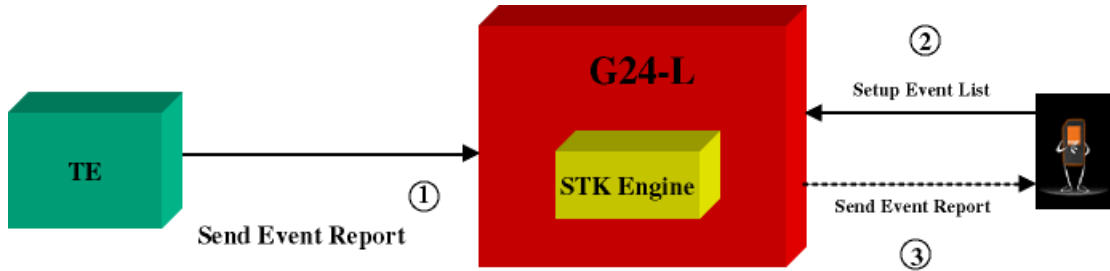

Figure 4-23: Setup Event List

TCP/IP

TCP Data Transfer Example

```

AT+MIPCALL=1,"orange","test","test"
OK
+MIPCALL: 172.17.242.86
AT+MIPOPEN=1,1222,"123.245.213.012",1234,0 //Opening socket 1 using TCP protocol, from port 1222,
targeting 123.245.213.012 port 1234
OK
+MIPOPEN: 1,1
AT+MIPOPEN? //Terminal checking the status of socket to be opened (socket 1 opened
OK)
+MIPOPEN: 2 3 4
+MIPSETS=1,340 //Asking the G24-L to accumulate 340 bytes on socket 1 prior to
sending
+MIPSETS: 0
OK
AT+MIPSETS?
+MIPSETS: 1 340
OK
AT+MIPSEND=1,"444444" //Sent coded "DDD" string
+MIPSEND: 1,1497 //Free storage in the accumulating buffer
OK
Note: This step can be repeated several times until the buffer is full or until the amount of data
reaches 340 bytes and data pushed into the stack.
AT+MIPSEND? //Checking the size remaining (optional)
+MIPSEND: 1 1497
OK
+MIPPUSH=1 //Terminal asks G24-L to flush the buffer in socket 1
+MIPPUSH: 0
+MIPCLOSE=1 //Terminal closes the socket
+MIPCLOSE: 1
OK
+MIPCALL=0 //Terminal hangs up the link
OK

```

Multi-point Data Transfer Example

```

AT+MIPCALL=1,"orange","test","test"
OK
+MIPCALL: 172.17.242.86
AT+MIPOPEN=1,1001,"172.17.238.44",1001,0
OK
+MIPOPEN: 1,1
AT+MIPOPEN=2,1111,"172.17.238.44",1111,0
OK
+MIPOPEN: 2,1

```

```

+MIPSETS=1,200           //Asking the G24-L to accumulate 200 bytes on socket 1 prior to
sending
+MIPSETS: 0
OK
+MIPSETS=2,400           //Asking the G24-L to accumulate 400 bytes on socket 2 prior to
sending
+MIPSETS: 0
OK
+MIPSEND=1,"444444"
+MIPSEND:1,1497
OK
+MIPSEND=2,"DD"          //Passing data to the G24-L socket 2
+MIPSEND:2,1499
OK
+MIPPUSH=1               //Terminal asks the G24-L to flush the buffer in sockets 1 and 2
+MIPPUSH:0
+MIPPUSH=2
+MIPPUSH:0
+MIPCLOSE=1              //Terminal closes sockets 1 and 2
+MIPCLOSE:1
OK
+MIPCLOSE=2
+MIPCLOSE:2
OK
+MIPCALL=0                //Terminal hangs up the link
OK
+MIPSETS=1,120           //Asking the G24-L to accumulate 120 bytes on socket 1 prior to
sending
+MIPSETS: 0
OK
+MIPSEND=1,"444444"      //Passing 3 bytes of data to the G24-L socket 1
+MIPSEND:1,1497
Note: Size remaining in socket 1 buffer is 1497 bytes.
+MIPSEND:1,1497
+MIPPUSH=1                //At this point, the terminal can decide on flushing the remainder to
the stack

```

Xoff and Xon Example

In this example, it is assumed that the buffer size is 1500 and that some kind of error happened on the protocol stack.

```

+MIPSEND=1,"A344343ABC343438980BC...AB4" //Passing data to G24-L socket 1
+MIPSEND:1,1200           //(Note: Size remaining in socket 1 accumulating buffer is 1200 bytes.)
+MIPSEND=1,"A344343ABC343438980BC...A23"
+MIPSEND:1,0              //(Note: No free space in buffer.)
+MIPXOFF: 1               //The G24-L detects that the accumulating buffer on socket 1 has no
free space to accumulate data and data cannot be sent to the protocol stack.

```

From this point on, the terminal is not allowed to send data until it receives the +MIPXON command.

```

+MIPSEND=1,A344343ABC343438980BC...AB4//Terminal disregards the Xoff request of G24-L and keeps
sending //(Note: The terminal does not stop.)
ERROR 3

```

```
+MIPXON: 1 //G24-L pushed the data into the protocol stack and is able to handle  
more sends from the terminal
```

Error in Reopening a Valid Socket

```
AT+MIPCALL=1,"orange","test","test"  
OK  
+MIPCALL:123.145.167.230  
+MIOPEN=1,1222,"123.245.213.012",1234,0 //Opening socket 1 using TCP protocol, from port 1222,  
targeting 123.245.213.012 port 1234  
OK  
+MIOPEN:1,1  
+MIOPEN? //Terminal checking the status of socket to be ready  
+MIOPEN: 2 3 4  
MIOPEN=1,12,123.245.213.012,234,0//Terminal tries to reopen socket 1  
ERROR
```



Audio

Scenarios for Setting Up Handset Mode or Handsfree Mode

Handset Mode

<code>AT+MAPATH=1,1</code>	<code>//Set the input path through the microphone</code>
<code>AT+MAPATH=2,1,3</code>	<code>//Set voice and keypad through the earpiece speaker</code>
<code>AT+MAPATH=2,3,12</code>	<code>//Set alerts and rings to go through the transducer</code>
<code>AT+MAFEAT=6,0</code>	<code>//Disable echo cancellation and noise suppression</code>
<code>AT+MAFEAT=1,1</code>	<code>//Enable sidetone</code>

Handsfree Mode

<code>AT+MAPATH=1,1</code>	<code>//Set the input path through the microphone</code>
<code>AT+MAPATH=2,1,15</code>	<code>//Set all tones through the earpiece speaker</code>
<code>AT+MAFEAT=1,0</code>	<code>//Disable sidetone</code>
<code>AT+MAFEAT=6,1</code>	<code>//Enable echo cancellation and noise suppression</code>

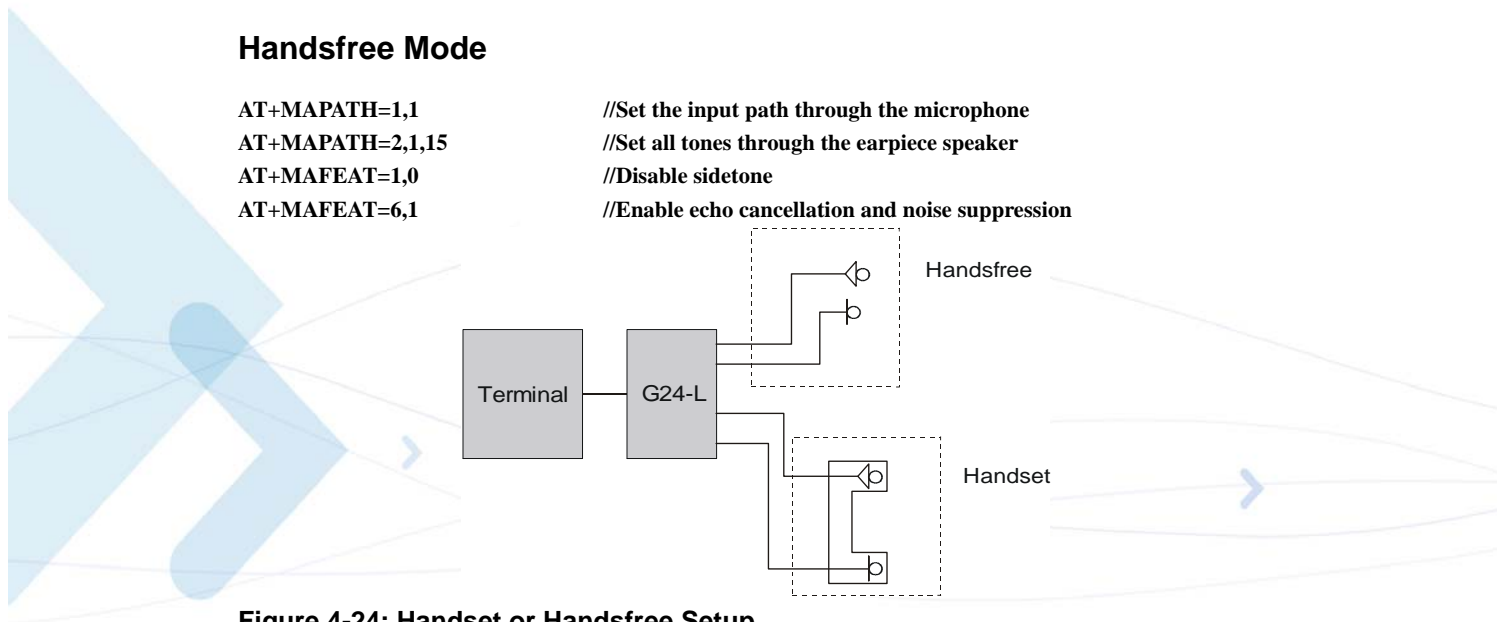

Figure 4-24: Handset or Handsfree Setup

Chapter 5: Tools

Tools Overview

This chapter describes the G24-L Drivers and application flashing tool.

The G24-L Drivers, USB and RS232, enables the use of the G24-L as a PC external modem for performing GPRS packet data connections. The flashing application enables users to reprogram and upgrade G24-L modules SW version through an USB/RS232 interface.

More detailed information regarding the drivers and the flashing application tool will be provided in a separate document.

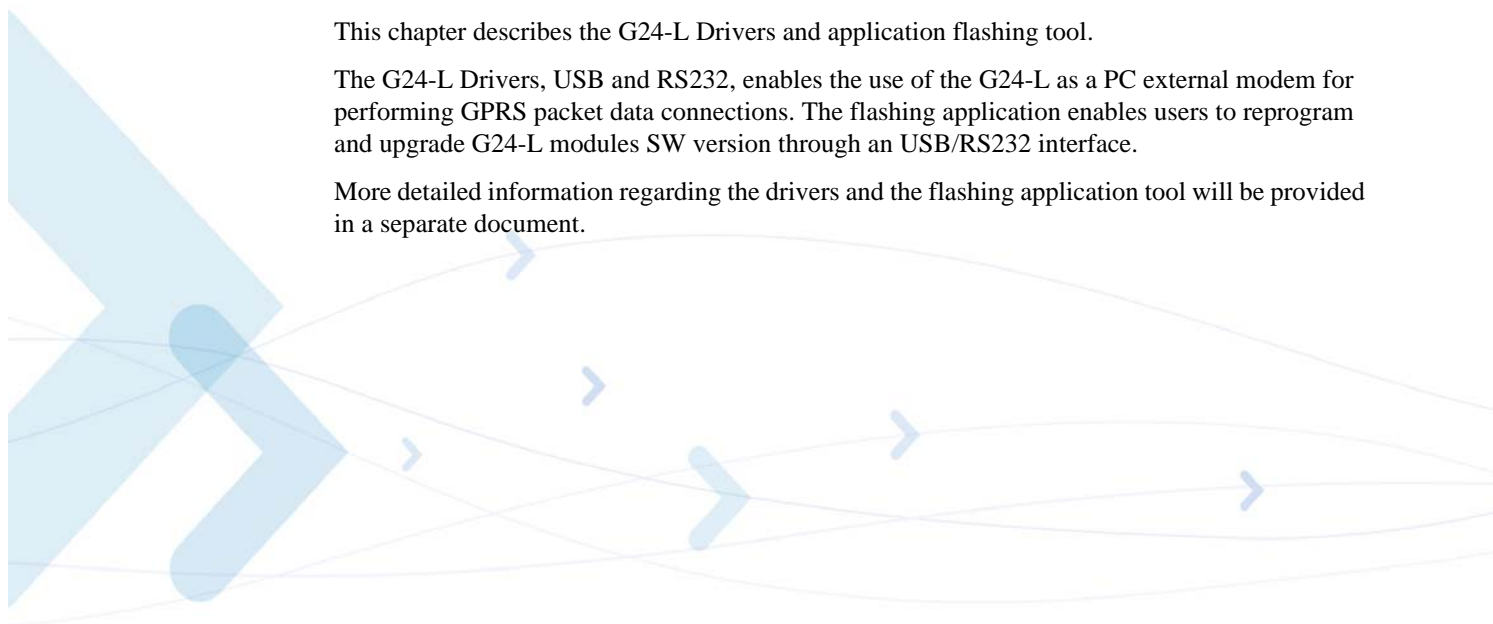

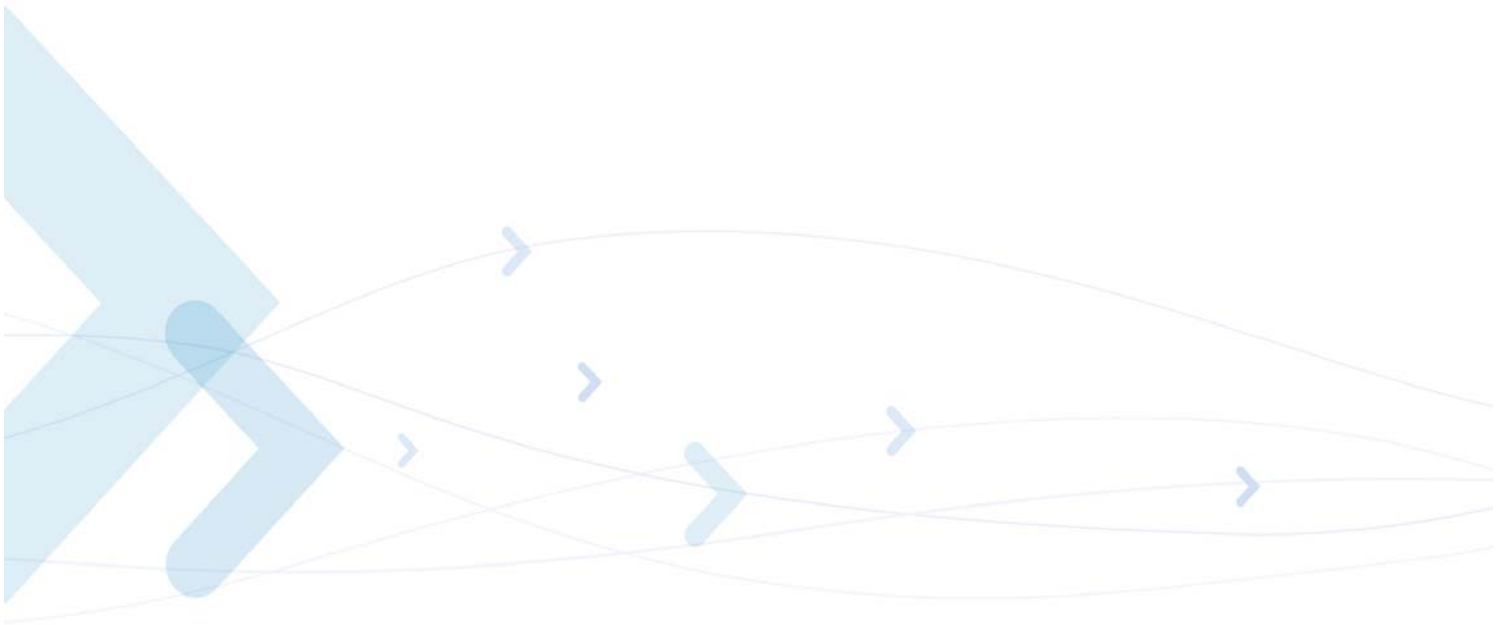

Appendix A: Reference Tables

This appendix contains the following sections:

- AT Commands Alphabetical Summary, below
- Character Set Table CS1: (GSM -> UCS-2), [Page -17](#)
- Character Set Table CS2: (ASCII <-> UTF-8), [Page -21](#)
- Character Set Table CS3: (UCS-2 <-> UTF-8), [Page -21](#)
- Character Set Table CS6: (UCS-2 Full Table), [Page -21](#)
- Character Set Table CS7: (ASCII table), [Page -22](#)

Note: Character Set Table CS6: (UCS-2) is provided on CD due to its size.

AT Commands Alphabetical Summary

The following table contains an alphabetical list of all the G24-L AT commands.

Table A-1: AT Commands (Alphabetical)

AT Command	Description	Page
\$	This command displays a list of all the AT commands supported by the G24-L.	Page 3-7
%C	This command is supported for backward compatibility only, and has no effect.	Page 3-304
&C	This command determines how the state of the DCD line relates to the detection of the received line signal from the distant end.	Page 3-136
&D	This command determines how the G24-L responds when the DTR (Data Terminal Ready) status is changed from ON to OFF during the online data state.	Page 3-138
&F	This command restores the factory default configuration profile.	Page 3-198

Table A-1: AT Commands (Alphabetical) (Cont.)

AT Command	Description	Page
&G	This command is supported for backward compatibility only, and has no effect.	Page 3-304
&J	This command is supported for backward compatibility only, and has no effect.	Page 3-304
&K	This command configures the RTS/CTS flow control.	Page 3-135
&L	This command is supported for backward compatibility only, and has no effect.	Page 3-304
&M	This command is supported for backward compatibility only, and has no effect.	Page 3-304
&P	This command is supported for backward compatibility only, and has no effect.	Page 3-304
&Q	This command selects the asynchronous mode, and has no effect.	Page 3-33
&R	This command is supported for backward compatibility only, and has no effect.	Page 3-304
&S	This command is supported for backward compatibility only, and has no effect.	Page 3-304
&T	This command is supported for backward compatibility only, and has no effect.	Page 3-304
&V	This command displays the current active configuration and stored user profiles.	Page 3-221
&W	This command stores the user profile.	Page 3-222
&Y	This command displays the default user profile.	Page 3-224
?	This command displays the most recently updated value stored in the S-register.	Page 3-198
\A	This command is supported for backward compatibility only, and has no effect.	Page 3-304
\B	This command is supported for backward compatibility only, and has no effect.	Page 3-304

Table A-1: AT Commands (Alphabetical) (Cont.)

AT Command	Description	Page
\G	This command sets the use of the software control.	Page 3-197
\J	This command adjusts the terminal auto rate.	Page 3-197
\K	This command is supported for backward compatibility only, and has no effect.	Page 3-304
\N	This command links the type.	Page 3-197
\S	This command displays the status of selected commands and S-registers.	Page 3-197
ATS97	This command indicates whether an antenna is physically connected to the G24-L RF connector.	Page 3-143
+CACM	This command resets the Advice of Charge accumulated call meter value in the SIM file, EFACM.	Page 3-46
+CALM	This command handles the selection of the G24's alert sound mode.	Page 3-171
+CAMM	This command sets the Advice of Charge accumulated call meter maximum value in the SIM file, EFACMmax.	Page 3-47
+CAOC	This command enables the subscriber to get information about the cost of calls.	Page 3-44
+CBAND	This command is supported for backward compatibility only, and has no effect.	Page 3-197
+CBAUD	This command sets the baud rate.	Page 3-132
+CBC	This command enables a user to query the battery charger connection.	Page 3-129
+CBST	This command selects the bearer service and the connection element to be used when data calls are originated.	Page 3-31
+CCFC	This command enables control of the call-forwarding supplementary service.	Page 3-27

Table A-1: AT Commands (Alphabetical) (Cont.)

AT Command	Description	Page
+CCLK	This command reads/sets the G24's current date and time settings.	Page 3-73
+CCWA	This command controls the Call Waiting supplementary service, including settings and querying of the network by the G24-L.	Page 3-21
+CDS	Unsolicited Response (New SMS-STATUS-REPORT Receipt).	Page 3-88
+CDSI	Unsolicited Response (New SMS-STATUS-REPORT Indication).	Page 3-88
+CEER	This command returns an extended error report containing one or more lines of information text <report>, determined by the manufacturer, providing reasons for errors. The errors are call clearing codes.	Page 3-213
+CFSN	This command is used to query the manufacturing serial number.	Page 3-5
+CFUN	This command shuts down the phone functionality of smart phones and PDAs with phone capabilities.	Page 3-141
+CGACT	This command activates/deactivates the PDP Context.	Page 3-245
+CGATT	This command attaches the G24-L to the GPRS network.	Page 3-237
+CGCLASS	This command sets the GPRS mobile station class.	Page 3-231
+CGDCONT	This command specifies the PDP (Packet Data Protocol) context.	Page 3-232
+CGMI	This command requests manufacturer identification.	Page 3-1
+CGMM	This command requests the model identification.	Page 3-2
+CGMR	This command requests the revision identification.	Page 3-3
+CGPADDR	This command reads the allocated PDP addresses for the specified context identifiers.	Page 3-238

Table A-1: AT Commands (Alphabetical) (Cont.)

AT Command	Description	Page
+CGPRS	This command indicates whether there is GPRS coverage.	Page 3-244
+CGQMIN	This command sets the minimum acceptable quality of service profile.	Page 3-234
+CGQREQ	This command returns the requested quality of service profile.	Page 3-236
+CGREG	This command enables/disables the GPRS network status registration unsolicited result code.	Page 3-121
+CGSMS	This command handles the selection of the service or service preference used by the G24-L to send mobile-originated SMS messages.	Page 3-109
+CGSN	This command requests the product serial number identification.	Page 3-3
+CHLD	This command controls the Call Hold and Multiparty Conversation supplementary services.	Page 3-23
+CHUP	This command causes the G24-L to hang up the current GSM call.	Page 3-34
+CIEV	An unsolicited indication regarding various phone indications that is sent to the DTE when the <ind> parameter of the +CMER command is set to 1.	Page 3-229
+CIMI	This command requests the International Mobile Subscriber Identity number.	Page 3-5
+CIND	This command is used to query the status of various ME indicators.	Page 3-227
+CLAC	This command displays a list of all the AT commands supported by the G24-L.	Page 3-8
+CLAN	This command handles the selection of language in the ME.	Page 3-225

Table A-1: AT Commands (Alphabetical) (Cont.)

AT Command	Description	Page
+CLCC	This command returns a list of all current G24-L calls and their statuses, and also enables/disables the unsolicited indication of the call list.	Page 3-40
+CLCK	This command locks, unlocks or interrogates a G24-L or a network facility <fac>.	Page 3-184
+CLIP	This command controls the Calling Line Identity (CLI) presentation to the terminal when there is an incoming call.	Page 3-19
+CLIR	This command enables/disables the sending of caller ID information to the called party, for an outgoing call.	Page 3-29
+CLVL	This command sets the volume of the internal loudspeaker (which also affects the key feedback tone) of the G24-L.	Page 3-159
+CMEE	This command enables/disables the use of result code +CME ERROR: <err> as an indication of an error relating to the functionality of the G24-L.	Page 3-206
+CMER	This command enables an external accessory to receive key press information from the G24's internal keypad.	Page 3-225
+CMGD	This command deletes messages from the G24-L memory.	Page 3-108
+CMGF	This command handles the selection of message formats.	Page 3-77
+CMGL	This command displays a list of SMS messages stored in the G24-L memory.	Page 3-89
+CMGR	This command enables the user to read selected SMS messages from the G24-L memory.	Page 3-94
+CMGS	This command sends an SM from the G24-L to the network.	Page 3-110
+CMGW	This command writes and saves messages in the G24-L memory.	Page 3-103
+CMSS	This command selects and sends pre-stored messages from the message storage.	Page 3-101

Table A-1: AT Commands (Alphabetical) (Cont.)

AT Command	Description	Page
+CMUT	This command mutes/unmutes the currently active microphone path by overriding the current mute state.	Page 3-160
+CMT	This unsolicited message forwards the SMS upon its arrival.	Page 3-86
+CMTI	This unsolicited message, including the SMS index, is sent upon the arrival of an SMS.	Page 3-86
+CNMA	This command acknowledges the receipt of a +CMT response.	Page 3-84
+CNMI	This command sends an unsolicited indication when a new SMS message is received by the G24-L.	Page 3-82
+CNUM	This command returns up to five strings of text information that identify the G24-L.	Page 3-6
+COLP	This command refers to the GSM supplementary service COLP, Connected Line Identification Presentation, which enables a calling subscriber to get the connected line identity (COL) of the called party after setting up a mobile originated call.	Page 3-56
+COPS	This command enables accessories to access the network registration information, and the selection and registration of the GSM network operator.	Page 3-122
+CPAS	This command returns the current activity status of the G24-L, for example, call in progress, or ringing.	Page 3-39
+CPBF	This command enables the user to search the currently active phone book for a particular entry, by name.	Page 3-63
+CPBR	This command recalls phone book entries from a specific entry number, or from a range of entries.	Page 3-61

Table A-1: AT Commands (Alphabetical) (Cont.)

AT Command	Description	Page
+CPBS	This command selects the memory that is to be used for reading and writing entries in G24s that contain more than one phone book memory.	Page 3-60
+CPBW	This command enables the user to store a new entry in the phone book, or delete an existing entry from the phone book.	Page 3-64
+CPIN	This command is only relevant for phones that use SIM cards. It unlocks the SIM card when the proper SIM PIN is provided, and unblocks the SIM card when the proper SIM PUK is provided.	Page 3-177
+CPMS	This command handles the selection of the preferred storage area for messages.	Page 3-76
+CPOL	This command is used to edit the list of preferred operators located in the SIM card.	Page 3-125
+CPUC	This command sets the parameters of the Advice of Charge-related price per unit and currency table found in the SIM file, EFPUCT.	Page 3-48
+CPWD	This command sets a new password for the facility lock.	Page 3-183
+CR	This command controls whether or not the extended format of an outgoing call is displayed or not.	Page 3-49
+CRC	This command controls whether to present the extended format of the incoming call indication.	Page 3-17
+CREG	This command enables/disables the network status registration unsolicited result code.	Page 3-119
+CRING	This unsolicited event indicates the type of incoming call.	Page 3-17
+CRLP	This command returns the Radio Link Protocol parameters.	Page 3-118
+CRSL	This command handles the selection of the incoming call ringer and alert tone (SMS) sound level on the alert speaker of the G24-L.	Page 3-158

Table A-1: AT Commands (Alphabetical) (Cont.)

AT Command	Description	Page
+CRSM	This command provides limited access to the Elementary Files on the SIM.	Page 3-216
+CRTT	This command plays one cycle of a ring tone, stops the cycle in the middle, and sets the ring tone to be used.	Page 3-173
+CSCA	This command handles the selection of the SCA and the TOSCA.	Page 3-78
+CSCS	This command selects the G24-L character set.	Page 3-4
+CSDH	This command shows the Text Mode parameters.	Page 3-81
+CSMP	This command sets the Text Module parameters.	Page 3-79
+CSMS	This command handles the selection of the SMS service type.	Page 3-75
+CSNS	This command handles the selection of the bearer or teleservice to be used when a mobile terminated single numbering scheme call is established.	Page 3-34
+CSSN	This command handles the enabling and disabling of supplementary service-related, network-initiated, notifications.	Page 3-50
+CSQ	This command returns the signal strength received by the G24-L.	Page 3-117
+CSVM	This command handles the selection of the number to the voice mail server.	Page 3-66
+CTFR1	This command terminates an incoming call and diverts the caller to the number previously defined in CCFC, or to a voice mail if one exists for the subscriber.	Page 3-37
+CUSD	This command allows control of Unstructured Supplementary Service Data (USSD), according to GSM 02.90.	Page 3-53

Table A-1: AT Commands (Alphabetical) (Cont.)

AT Command	Description	Page
+EMPC	This command unlocks or resets the first PLMN of the inserted SIM.	Page 3-187
+EPIN	This command is only relevant for phones that use SIM cards. It verifies the PIN2 indicator.	Page 3-181
+FMI	This command requests manufacturer identification.	Page 3-1
+FMM	This command requests the model identification.	Page 3-2
+FMR	This command requests the revision identification.	Page 3-3
+GMI	This command requests manufacturer identification.	Page 3-1
+GMM	This command requests the model identification.	Page 3-2
+GMR	This command requests the revision identification.	Page 3-3
+GSN	This command requests the product serial number identification.	Page 3-3
+ICF	This command determines the local serial port start/stop (asynchronous) character framing used by the DCE when accepting DTE commands and transmitting information text and result codes, whenever these are not done automatically.	Page 3-142
+IPR	This command is responsible for setting and saving the request baud rate.	Page 3-133
+MADIGITAL	This command switches between analog and digital audio modes.	Page 3-170
+MAFEAT	This command controls the various algorithm features, such as sidetone, echo cancel and noise suppress.	Page 3-169
+MAMUT	This command controls the muting/unmuting of all input paths (MIC, HDST_MIC, DIGITAL_RX).	Page 3-168
+MAPATH	This command sets/requests the active input accessory, and the output accessory for each feature.	Page 3-163

Table A-1: AT Commands (Alphabetical) (Cont.)

AT Command	Description	Page
+MAVOL	This command enables you to determine a volume setting for a particular feature in a particular accessory.	Page 3-166
+MBC	This command controls the battery charger process.	Page 3-130
+MCSAT	This command enables/disables/exercises SMS alert tone for an arriving SMS.	Page 3-111
+MCSN	This command sets EFmsisdn in the SIM.	Page 3-69
+MCST	This command displays the current state of the call processing, and also enables/disables the unsolicited indication of any change in the call processing state.	Page 3-42
+MCWAKE	This command requests reports on the status of the GPRS/GSM coverage.	Page 3-139
+MDC	This command enables you to select the desired messages to be displayed upon connection of a voice call with a remote party.	Page 3-36
+MDSI	This command enables unsolicited reporting of indications of SIM deactivation and invalidation.	Page 3-67
+MFS	This command is used to determine how long the G24-L waits before attempting to re-register after a registration attempt has failed and the G24-L is not registered.	Page 3-126
+MGEER	This command returns the PDP context activation reject cause.	Page 3-240
+MGGIND	This command configures the service indicator on pin 49 of the 70 pin connector to be GPRS or GSM.	Page 3-140
+MIOC	This command defines the G24-L 8 GPIO pins data value.	Page 3-144
+MIOD	This command defines the G24-L 8 GPIO pins configuration.	Page 3-147

Table A-1: AT Commands (Alphabetical) (Cont.)

AT Command	Description	Page
+MIPCALL	This command creates a wireless PPP connection with the GGSN, and returns a valid dynamic IP for the G24-L.	Page 3-276
+MIPCFF	This command sets the Filtering List.	Page 3-301
+MIPCLOSE	This command causes the G24-L to free the socket accumulating buffer and disconnect the G24-L from a remote side.	Page 3-282
+MIPCONF	Configure Internal TCP/IP stack.	Page 3-289
+MIPFLUSH	This command causes the G24-L to flush (delete) data accumulated in its accumulating buffers.	Page 3-286
+MIPODM	This command causes the G24-L to initialize a new socket in Online Data Mode and open a connection with a remote side.	Page 3-279
+MIPOPEN	This command causes the G24-L to initialize a new socket and open a connection with a remote side.	Page 3-277
+MIPPUSH	This command causes the G24-L to push the data accumulated in its accumulating buffers into the protocol stack.	Page 3-285
+MIPRTCP	This unsolicited event is sent to the terminal when data is received from the TCP protocol stack.	Page 3-287
+MIPRUDP	This unsolicited event is sent to the terminal when data is received from the UDP protocol stack.	Page 3-287
+MIPSEND	This command causes the G24-L to transmit the data that the terminal provides, using an existing protocol stack.	Page 3-284
+MIPSETS	This command causes the G24-L to set a watermark in the accumulating buffer. When the watermark is reached, data is pushed from the accumulating buffer into the protocol stack.	Page 3-283

Table A-1: AT Commands (Alphabetical) (Cont.)

AT Command	Description	Page
+MIPSTAT	This unsolicited event is sent to the terminal indicating a change in link status.	Page 3-288
+MIPXOFF	This unsolicited event is sent to the terminal to stop sending data.	Page 3-288
+MIPXON	This unsolicited event is sent to the terminal when the G24-L has free memory in the accumulating buffer.	Page 3-289
+MMAD	This command reads and monitors digital value from a specified ADC.	Page 3-149
+MMAR	This command changes the status of an SMS message in the G24-L memory from "REC UNREAD" to "REC READ".	Page 3-101
+MMICG	This command handles the selection of microphone gain values.	Page 3-172
+MMGL	This command displays a list of SMS messages stored in the G24-L memory.	Page 3-89
+MMGR	This command enables the user to read selected SMS messages from the G24-L memory.	Page 3-94
+MPCMC	This command defines whether the PCM clock is generated continuously or not, when module is in digital audio mode.	Page 3-153
+MPING	This command will allow verifying IP connectivity to another remote machine (computer) by sending one or more Internet Control Message Protocol (ICMP) Echo Request messages.	Page 3-292
+MPINGSTAT	This is the unsolicited response that the G24-L sends to the terminal to inform of ping execution status update and provides summary statistics of ping request when ping request execution is completed.	Page 3-296
+MRST	This command enables customer software to perform a hard reset to the G24-L unit.	Page 3-143

Table A-1: AT Commands (Alphabetical) (Cont.)

AT Command	Description	Page
+MSCTS	This command defines the behavior of the CTS line when the G24-L is in Sleep mode.	Page 3-205
+MSDNS	This command sets/reads DNS IP address for each socket.	Page 3-299
+MTCTS	This command sets the CTS pin of the RS232 to not active (high), waits one second and then returns the CTS to active (low).	Page 3-135
+MTDTR	This command checks and outputs the physical current status of the DTR pin of the RS232.	Page 3-134
+MTKA	This command sends acknowledge response from the user (TE) to the STK.	Page 3-274
+MTKC	This unsolicited event notifies the terminal when supplementary services, SMS Control or Call Control are modified.	Page 3-274
+MTKE	This command enables/disables the SIM ToolKit functionalities.	Page 3-257
+MTKM	This is both a command and an unsolicited event. The command selects items from the menu.	Page 3-272
+MTKP	This is both a command and an unsolicited event. The command responds to an unsolicited event.	Page 3-258
+MTKR	This command displays the profile that is downloaded from the G24-L to the SIM during the SIM initialization process.	Page 3-247
+MTTY	This command is used to enable/disable the TTY (Tele Typewriter) support in the G24.	Page 3-57
+MVC	This AT command is used to choose and configure the priority order of the supported voice codecs (vocoders).	Page 3-38
+TPIN	This command queries the number of remaining SIM PIN/PUK entering attempts.	Page 3-182
+VTD	This command handles the selection of tone duration.	Page 3-175

Table A-1: AT Commands (Alphabetical) (Cont.)

AT Command	Description	Page
+VTS	This command transmits DTMF tones when a voice call is active.	Page 3-176
A	This command answers an incoming call, placing the G24-L into the appropriate mode, as indicated by the RING message.	Page 3-17
A/	This command repeats the last command entered on the terminal.	Page 3-177
AT	This command checks the AT communication and only returns OK.	Page 3-177
D	This command places a voice call on the current network, when issued from an accessory device.	Page 3-11
D*99	This command enables the ME to perform the actions necessary for establishing communication between the terminal and the external PDN.	Page 3-242
D>	This command places a voice/fax/data call on the current network by dialing directly from the G24-L phone book.	Page 3-12
DL	This command places a voice call to the last number dialed.	Page 3-14
E	This command defines whether the G24-L echoes the characters received from the user, (whether input characters are echoed to output).	Page 3-192
F	This command is supported for backward compatibility only, and has no effect.	Page 3-304
H	This command hangs up, or terminates a particular call.	Page 3-15
I	This command requests various G24-L information items.	Page 3-6
L	This command is supported for backward compatibility only, and has no effect.	Page 3-304
M	This command is supported for backward compatibility only, and has no effect.	Page 3-304

Table A-1: AT Commands (Alphabetical) (Cont.)

AT Command	Description	Page
N	This command is supported for backward compatibility only, and has no effect.	Page 3-304
O	This command returns a phone to the Online Data mode and issues a CONNECT or CONNECT <text> result code.	Page 3-33
P	This command is supported for backward compatibility only, and has no effect.	Page 3-304
Q	This command determines whether to output/suppress the result codes.	Page 3-191
RING	This unsolicited event is received when an incoming call (voice, data or fax) is indicated by the cellular network.	Page 3-17
S102	This S-register sets the value of the delay before sending the data to the terminal.	Page 3-203
S24	This S-parameter activates/disables the Sleep mode. If the parameter value is greater than 0, it represent the number of seconds till the G24-L enters sleep mode.	Page 3-202
S94	This S-parameter represents the Boolean status, On/Off, of the sidetone feature.	Page 3-161
S96	This S-parameter represents the Boolean status, On/Off, of the echo cancelling feature in the handsfree.	Page 3-162
Sn	This command reads/writes values of the S-registers, and includes registers 1-49.	Page 3-194
T	This command is supported for backward compatibility only, and has no effect.	Page 3-304
V	This command determines the response format of the data adapter and the contents of the header and trailer transmitted with the result codes and information responses.	Page 3-190

Table A-1: AT Commands (Alphabetical) (Cont.)

AT Command	Description	Page
X	This command defines the data adaptor response set, and the CONNECT result code format.	Page 3-193
Y	This command is supported for backward compatibility only, and has no effect.	Page 3-304
Z	This command resets the default configuration.	Page 3-199

Character Set Table CS1: (GSM -> UCS-2)

The following table shows the conversion between the GSM and UCS-2 character sets.

Symbol	GSM	(GSM 03.38)
UCS-2	(ISO 10646-1)	@
0x00	0x0040	£
0x01	0x00A3	\$
0x02	0x0024	¥
0x03	0x00A5	è
0x04	0x00E8	é
0x05	0x00E9	ù
0x06	0x00F9	ì
0x07	0x00EC	ò
0x08	0x00F2	Ç
0x09	0x00C7	LF
0x0A	0x000A	∅
0x0B	0x00D8	ø
0x0C	0x00F8	CR
0x0D	0x000D	Å
0x0E	0x00C5	â
0x0F	0x00E5	Ä
0x10	0x0394	–
0x11	0x005F	Ö
0x12	0x03A6	Ã
0x13	0x0393	Ë

Symbol	GSM	(GSM 03.38)
0x14	0x039B	Û
0x15	0x03A9	Ð
0x16	0x03A0	Ø
0x17	0x03A8	Ó
0x18	0x03A3	È
0x19	0x0398	Î
0x1A	0x039E	l)
0x1B	0x258A	Æ
0x1C	0x00C6	æ
0x1D	0x00E6	ß
0x1E	0x03B2	É
0x1F	0x00C9	SP
0x20	0x0020	!
0x21	0x0021	"
0x22	0x0022	#
0x23	0x0023	¤
0x24	0x00A4	%
0x25	0x0025	&
0x26	0x0026	'
0x27	0x0027	(
0x28	0x0028)
0x29	0x0029	*
0x2A	0x002A	+
0x2B	0x002B	,
0x2C	0x002C	-
0x2D	0x002D	.
0x2E	0x002E	/
0x2F	0x002F	0
0x30	0x0030	1
0x31	0x0031	2
0x32	0x0032	3
0x33	0x0033	4
0x34	0x0034	5

Symbol	GSM	(GSM 03.38)
0x35	0x0035	6
0x36	0x0036	7
0x37	0x0037	8
0x38	0x0038	9
0x39	0x0039	:
0x3A	0x003A	;
0x3B	0x003B	<
0x3C	0x003C	=
0x3D	0x003D	>
0x3E	0x003E	?
0x3F	0x003F	i
0x40	0x00A1	A
0x41	0x0041	B
0x42	0x0042	C
0x43	0x0043	D
0x44	0x0044	E
0x45	0x0045	F
0x46	0x0046	G
0x47	0x0047	H
0x48	0x0048	I
0x49	0x0049	J
0x4A	0x004A	K
0x4B	0x004B	L
0x4C	0x004C	M
0x4D	0x004D	N
0x4E	0x004E	O
0x4F	0x004F	P
0x50	0x0050	Q
0x51	0x0051	R
0x52	0x0052	S
0x53	0x0053	T
0x54	0x0054	U
0x55	0x0055	V

Symbol	GSM	(GSM 03.38)
0x56	0x0056	W
0x57	0x0057	X
0x58	0x0058	Y
0x59	0x0059	Z
0x5A	0x005A	Ä
0x5B	0x00C4	Ö
0x5C	0x00D6	Ñ
0x5D	0x00D1	Û
0x5E	0x00DC	§
0x5F	0x00A7	ı
0x60	0x00BF	a
0x61	0x0061	b
0x62	0x0062	c
0x63	0x0063	d
0x64	0x0064	e
0x65	0x0065	f
0x66	0x0066	g
0x67	0x0067	h
0x68	0x0068	i
0x69	0x0069	j
0x6A	0x006A	k
0x6B	0x006B	l
0x6C	0x006C	m
0x6D	0x006D	n
0x6E	0x006E	o
0x6F	0x006F	p
0x70	0x0070	q
0x71	0x0071	r
0x72	0x0072	s
0x73	0x0073	t
0x74	0x0074	u
0x75	0x0075	v
0x76	0x0076	w

Symbol	GSM	(GSM 03.38)
0x77	0x0077	x
0x78	0x0078	y
0x79	0x0079	z
0x7A	0x007A	ä
0x7B	0x00E4	ö
0x7C	0x00F6	ñ
0x7D	0x00F1	ü
0x7E	0x00FC	à
0x7F	0x00E0	

Character Set Table CS2: (ASCII <-> UTF-8)

The following table shows the conversion between the ASCII and UTF-8 character sets.

ASCII-7bit Byte Encoding	UTF-8 Bit Encoding
00 - 7F	0xxxxxxx

Character Set Table CS3: (UCS-2 <-> UTF-8)

The following table shows the conversion between the UCS-2 and UTF-8 character sets.

UCS2		UTF-8		
Byte Encoding	Bit Encoding	Byte 1	Byte 2	Byte 3
0000 - 007F	00000000xxxxxx x	0xxxxxxx		
0080 - 07FF	00000yyyyyxxxxx x	110yyyyy	10xxxxxx	
0800 - FFFF	zzzzyyyyyyxxxxxx	1110zzzz	10yyyyyy	10xxxxxx

Note: Conversion from the default GSM alphabet to the above character set is straightforward. Conversions of the characters listed below the table are not supplied.

Character Set Table CS6: (UCS-2 Full table)

Character Set Table CS6: (UCS-2) is not provided due to its size.

Character Set Table CS7: (ASCII table)

The following table shows the conversion for the ASCII character set.

Decimal	Octal	Hex	Binary	Value	Description
000	000	000	00000000	NUL	(Null char.)
001	001	001	00000001	SOH	(Start of Header)
002	002	002	00000010	STX	(Start of Text)
003	003	003	00000011	ETX	(End of Text)
004	004	004	00000100	EOT	(End of Transmission)
005	005	005	00000101	ENQ	(Enquiry)
006	006	006	00000110	ACK	(Acknowledgment)
007	007	007	00000111	BEL	(Bell)
008	010	008	00001000	BS	(Backspace)
009	011	009	00001001	HT	(Horizontal Tab)
010	012	00A	00001010	LF	(Line Feed)
011	013	00B	00001011	VT	(Vertical Tab)
012	014	00C	00001100	FF	(Form Feed)
013	015	00D	00001101	CR	(Carriage Return)
014	016	00E	00001110	SO	(Shift Out)
015	017	00F	00001111	SI	(Shift In)
016	020	010	00010000	DLE	(Data Link Escape)
017	021	011	00010001	DC1	(XON)(Device Control 1)
018	022	012	00010010	DC2	(Device Control 2)
019	023	013	00010011	DC3	(XOFF)(Device Control 3)
020	024	014	00010100	DC4	(Device Control 4)
021	025	015	00010101	NAK	(Negative Acknowledgment)
022	026	016	00010110	SYN	(Synchronous Idle)

Decimal	Octal	Hex	Binary	Value	Description
023	027	017	00010111	ETB	(End of Trans. Block)
024	030	018	00011000	CAN	(Cancel)
025	031	019	00011001	EM	(End of Medium)
026	032	01A	00011010	SUB	(Substitute)
027	033	01B	00011011	ESC	(Escape)
028	034	01C	00011100	FS	(File Separator)
029	035	01D	00011101	GS	(Group Separator)
030	036	01E	00011110	RS	(Request to Send)(Record Separator)
031	037	01F	00011111	US	(Unit Separator)
032	040	020	00100000	SP	(Space)
033	041	021	00100001	!	(exclamation mark)
034	042	022	00100010	"	(double quote)
035	043	023	00100011	#	(number sign)
036	044	024	00100100	\$	(dollar sign)
037	045	025	00100101	%	(percent)
038	046	026	00100110	&	(ampersand)
039	047	027	00100111	'	(single quote)
040	050	028	00101000	((left/opening parenthesis)
041	051	029	00101001)	(right/closing parenthesis)
042	052	02A	00101010	*	(asterisk)
043	053	02B	00101011	+	(plus)
044	054	02C	00101100	,	(single quote)
045	055	02D	00101101	-	(minus or dash)
046	056	02E	00101110	.	(dot)
047	057	02F	00101111	/	(forward slash)
048	060	030	00110000	0	
049	061	031	00110001	1	
050	062	032	00110010	2	

Decimal	Octal	Hex	Binary	Value	Description
051	063	033	00110011	3	
052	064	034	00110100	4	
053	065	035	00110101	5	
054	066	036	00110110	6	
055	067	037	00110111	7	
056	070	038	00111000	8	
057	071	039	00111001	9	
058	072	03A	00111010	:	(colon)
059	073	03B	00111011	;	(semi-colon)
060	074	03C	00111100	<	(less than)
061	075	03D	00111101	=	(equal sign)
062	076	03E	00111110	>	(greater than)
063	077	03F	00111111	?	(question mark)
064	100	040	01000000	@	(AT symbol)
065	101	041	01000001	A	
066	102	042	01000010	B	
067	103	043	01000011	C	
068	104	044	01000100	D	
069	105	045	01000101	E	
070	106	046	01000110	F	
071	107	047	01000111	G	
072	110	048	01001000	H	
073	111	049	01001001	I	
074	112	04A	01001010	J	
075	113	04B	01001011	K	
076	114	04C	01001100	L	
077	115	04D	01001101	M	
078	116	04E	01001110	N	
079	117	04F	01001111	O	
080	120	050	01010000	P	
081	121	051	01010001	Q	
082	122	052	01010010	R	
083	123	053	01010011	S	
084	124	054	01010100	T	

Decimal	Octal	Hex	Binary	Value	Description
085	125	055	01010101	U	
086	126	056	01010110	V	
087	127	057	01010111	W	
088	130	058	01011000	X	
089	131	059	01011001	Y	
090	132	05A	01011010	Z	
091	133	05B	01011011	[(left/opening bracket)
092	134	05C	01011100	\	(back slash)
093	135	05D	01011101]	(right/closing bracket)
094	136	05E	01011110	^	(caret/circumflex)
095	137	05F	01011111	_	(underscore)
096	140	060	01100000	`	
097	141	061	01100001	a	
098	142	062	01100010	b	
099	143	063	01100011	c	
100	144	064	01100100	d	
101	145	065	01100101	e	
102	146	066	01100110	f	
103	147	067	01100111	g	
104	150	068	01101000	h	
105	151	069	01101001	i	
106	152	06A	01101010	j	
107	153	06B	01101011	k	
108	154	06C	01101100	l	
109	155	06D	01101101	m	
110	156	06E	01101110	n	
111	157	06F	01101111	o	
112	160	070	01110000	p	
113	161	071	01110001	q	
114	162	072	01110010	r	
115	163	073	01110011	s	
116	164	074	01110100	t	

Decimal	Octal	Hex	Binary	Value	Description
117	165	075	01110101	u	
118	166	076	01110110	v	
119	167	077	01110111	w	
120	170	078	01111000	x	
121	171	079	01111001	y	
122	172	07A	01111010	z	
123	173	07B	01111011	{	(left/opening brace)
124	174	07C	01111100		(vertical bar)
125	175	07D	01111101	}	(right/closing brace)
126	176	07E	01111110	~	(tilde)
127	177	07F	01111111	DEL	(delete)

Acronyms and Abbreviations

Abbreviation	Full Name
A	
ACCH	AT Command Channel - Used for AT-commands, TCP/IP, Internal-GPRS session, Voice-Call, and SMS applications
AGC	Automatic Gain Control
AOC	Advice of Charge
APN	Access Point Name
ASCII	A standard seven-bit code character set
ATA	AT command for call answer
ATD	AT command for call originating
ATH	AT command for Hanging-up a call
ATO	AT command to return to Data mode after temporarily exiting by ESC
B	
BM	Broadcast Message
C	
CA	A certificate authority or certification authority is an entity which issues digital certificates for use by other parties. It is an example of a trusted third party.
CB	Cell Broadcast
CBM	Cell Broadcast Message
CDS	Call Data Services (External-GPRS session, CSD session, FAX session)
Certificate	A public key certificate (or identity certificate) is a certificate which uses a digital signature to bind together a public key with an identity - information such as the name of a person or an organization, their address, and so forth. The certificate can be used to verify that a public key belongs to an individual.
Cipher Suite	A set of cryptographic algorithms. A cipher suite specifies one algorithm for each of the following tasks: Key exchange, Bulk encryption and Message authentication.
CSD	Circuit-switched Data
CSNS	Single Numbering Call Scheme
CTS	Clear to Send

Abbreviation	Full Name
CTS	RS232 pin used for HW flow control. The MGOM uses this pin to stop data transmission from the DTE (on the TXD pin).
D	
DA	Destination Address
DCD	Data Carrier Detect
DCE	Data Communication Equipment (G24)
DCSs	Data Coding Schemas
DLC	Data Link Connection
DLC0	The multiplexer control channel.
DLCI	Data Link Connection Identifier
DSP	Digital Signal Processor
DSR	Data Set Ready
DSR	MGOM is ON and ready to communicate with the DTE device.
DT	Discharge Time
DTE	Data Terminal Equipment (such as terminals, PCs and so on). Also called Application Processor (AP).
DTMF	Dual-Tone Multi-Frequency
DTR	Data Terminal Ready
E	
EF	Elementary Files
EONS	Enhanced Operator Name String
ERM	Error Recovery Mode
ESC	Exit to Command Mode from Data Mode (usually the +++ sequence)
ETSI	European Telecommunication Standards Institute
F	
FCC	Federal Communications Commission (U.S.)
FO	First Octet
FTA	Full Type Approval
G	
GCF	GSM Certification Forum
GGSN	Gate GPRS Support Node
GPIO	General Purpose Input/Output
GPRS	General Packet Radio Service
GRLC	General RS232 Logical Channel - This channel can handle the 07.07/07.05 AT command set (CSD, FAX, GPRS, Voice, Network AT, and so on.)
GSM	Global System for Mobile Communications

Abbreviation	Full Name
--------------	-----------

H

HCO

Hearing Carry Over allows Speech Disabled callers who can hear well on the telephone to listen directly to the person they are talking with. The Speech Disabled Relay user types his or her part of the conversation on a TTY. A Communication Assistant (CA) then speaks the typed conversation, word for word, to the standard telephone user.

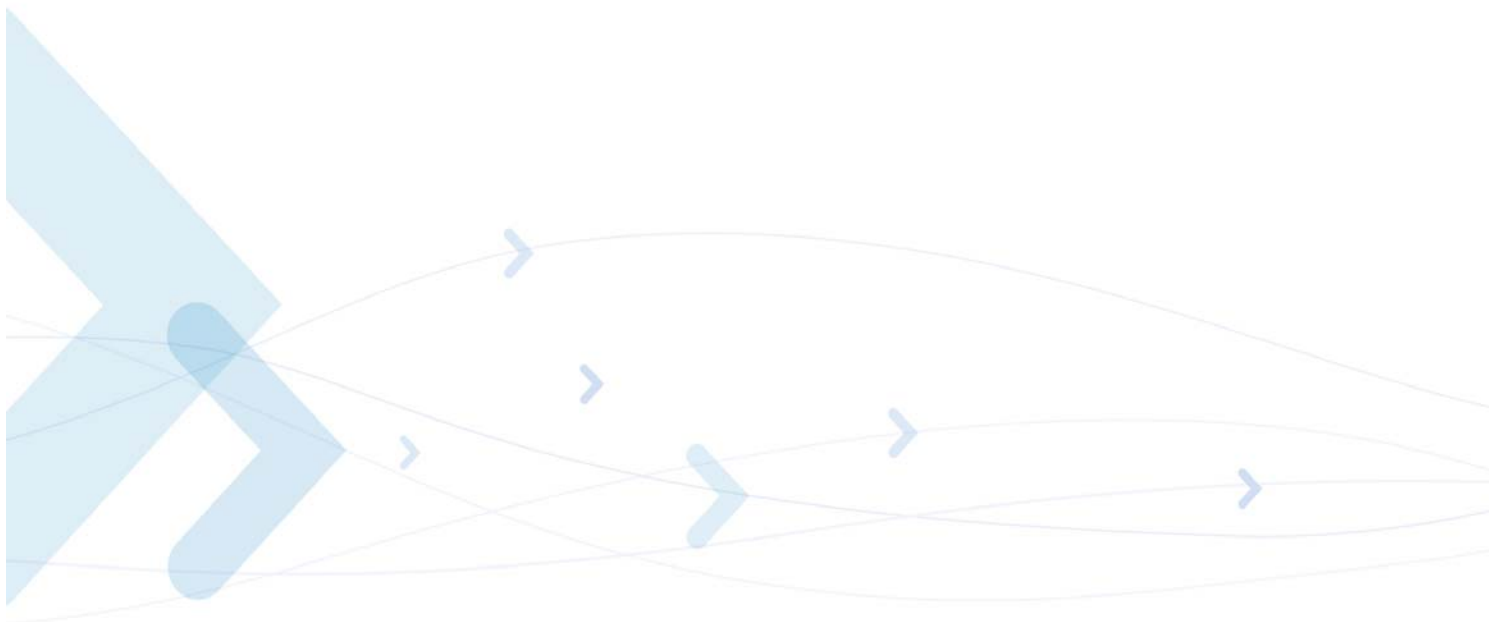

Abbreviation	Full Name
I	
IC	Integrated Circuit
ID	Identification
IDLC	Information DLC - refers to all the data channels except the control channel.
IMEI	International Mobile Equipment Identification.
ISR	Interrupt Service Routine
ITU	International Telecommunication Union
L	
LCA	Low Cost Architecture
M	
MCC/MNC	Mobile Country Code / Mobile Network Code
ME	Mobile Equipment
MGOM	Motorola G24-L GSM OEM Modem, also called Base Band processor.
MIDs	Message IDs (Channels)
MO	Mobile Originated - sets up a call session.
MR	Message Reference
MT	Mobile Terminated - accepts a call session.
O	
OA	Origination Address
OEM	Original Equipment Manufacturer
P	
PCB	Printed Circuit Board
PCM	Pulse Code Modulation
PDN	Packet Data Network
PDU	Packet Data Unit
PID	Protocol Identifier
PPP	Point-to-Point Protocol

Abbreviation	Full Name
--------------	-----------

Q, R

QoS	Quality of Service
RA	Recipient Address
RI	Ring Indicator
RTS	Request To Send
RTS	RS232 pin used for HW flow control. The DTE uses this pin to stop data transmission from the MGOM (on the RXD pin).
RXD	DTE received data from MGOM.

S

S-register	Software Resister
SC	Service Center
SCA	Service Center Address
SCTS	Service Center Time Stamp
SIM	Subscriber Identity Module
SM	Short Message
SMS	Short Message Service
SN	Serial Number
SSL	Secure Socket Layer protocol. Created by Netscape to ensure secure transactions between a client and a server.
ST	Status
SW flow control	ISO/IEC 646 SW flow control (the DC1/XON and DC3/XOFF control characters).

Abbreviation	Full Name
T	TBD To Be Defined
	TDMA Time Division Multiple Access
	TE Terminal Equipment
	TLS Transport Layer Security protocol for establishing a secure connection between a client and a server. TLS is based on SSL 3.0 protocol.
	TODA Type of Destination Address
	TOOA Type of Origination Address
	TORA Type of Recipient Address
	TOSCA Type of SCA
	TTY Tele Typewriter
	TXD DTE transmit data to MGOM
U	UA Unnumbered Acknowledgement
	UIH Unnumbered Information, with Only Header Checksum
	USB Universal Serial Bus
V	VCO Voice Carry Over. This is available for people who cannot hear but are able to speak clearly. During a VCO relay call, the Deaf or Hard of Hearing caller speaks directly to the person they are conversing with. When that person responds, a Communication Assistant (CA) types back exactly what is said to the screen of the TTY or VCO phone.

Index

Numerics

8859 Character Set Management, 1-14

A

Abbreviations

General System, 2-2

Aborting Commands, 2-8

Access Control Commands, 3-177

Acknowledgement

New Message, 3-84

Address

Service Center, 3-78

Argument Types in AT Commands, 2-7

ASCII Character Set Management, 1-13

AT Command Reference

+CALM, Alert Sound Mode, 3-171

+CFUN, Shut Down Phone Functionality, 3-141

+CLVL, Loudspeaker Volume, 3-159

+CPOL, Preferred Operators, 3-125

+CRSL, Call Ringer Level, 3-158

+CSVM, Voice Mail Server, 3-66

+VTD, Tone Duration, 3-175

AT Commands

Aborting Commands, 2-8

Command Argument Types, 2-7

Command Mode Types, 2-7

Command Token Types, 2-6

General Symbols in Description, 2-1

Introduction, 2-1

List All, 3-7

Overview, 2-1

Protocol, 2-2

Protocol and Structure Configuration, 2-5

Structure, 2-3

Summary, 1-15, A-1

Using, 4-1

Values, 2-8

AT Commands Reference, 3-1

\$, List of All Available AT Commands, 3-7

&C, Circuit 109 Behavior, 3-136

&D, Circuit 108 Behavior, 3-138

&F, Set to Factory Defined Configuration, 3-198

&J, 3-304

&K, RTS/CTS Flow Control, 3-135

&V, View Configuration, 3-221

&W, Store User Profile, 3-222

&Y, Default User Profile, 3-224

+CACM, Accumulated Call Meter, 3-46

+CAMP, Accumulated Call Meter Maximum, 3-47

+CAOC, Advice of Charge, 3-44

+CBAND, Change Radio Band, 3-197

+CBAUD, Baud Rate Regulation, 3-132

+CBC, Battery Charger Connection, 3-129

+CBST, Select Bearer Service Type, 3-31

+CCFC, Call Forwarding Number and Conditions, 3-27

+CCLK, Read/Set System Date and Time, 3-73

+CCWA, Call Waiting Command, 3-21

+CEER, Extended Error Report, 3-213

+CFSN, Read Factory Serial Number, 3-5

+CGACT, 3-245

+CGACT, PDP Context Activate or Deactivate, 3-245

+CGATT, GPRS Attach or Detach, 3-237

+CGCLASS, GPRS Mobile Station Class, 3-231

+CGDCONT, Define PDP Context, 3-232

+CGMI, Request Manufacturer ID, 3-1

+CGMM, Request Model ID, 3-2

+CGMR, Request Revision, 3-3

+CGPRS, GPRS Coverage, 3-244

+CGQMIN, Quality of Service Profile (Min Acceptable), 3-234

+CGREQ, Quality of Service Profile (Requested), 3-236

+CGREG, GPRS Network Registration, 3-121

+CGSMS, Select Service for MO SMS Messages, 3-109

+CGSN, Request Product Serial Number Identification, 3-3

+CHLD, Call Related Supplementary Services, 3-23

+CHUP, Hang Up Call, 3-34

+CIEV, Indicator Event Reporting, 3-229

+CIMI, Request IMSI, 3-5

+CIND, Indicator Control, 3-227

+CLAC, List of All Available AT Commands, 3-8

+CLAN, ME Language, 3-225

+CLCC, List Current Calls, 3-40

+CLCK, Facility Lock, 3-184

+CLIP, Calling Line Identification, 3-19

+CLIR, Calling Line Identification Restriction, 3-29

+CMEE, Report Mobile Equipment Error, 3-206

+CMER, Set/Request Local Key Press Echo Keypad Mode, 3-225–3-227

+CMGD, Delete Message, 3-108

+CMGF, Message Format, 3-77

+CMGL, List Messages, 3-89

+CMGR, Read Message, 3-94

+CMGS, Send SM to Network, 3-110

+CMGW, Write Message to Memory, 3-103

+CMSS, Send Message From Storage, 3-101

+CMTI, Unsolicited Result Code, 3-86

+CMUT, Mute/Unmute Currently Active Microphone Path, 3-160

+CNMA, New Message Acknowledgement, 3-84

+CNMI, New Message Indications to Terminal, 3-82

+CNUM, Request MSISDN(s), 3-6

+COLP, Connected Line Identification Presentation, 3-56

+COPS, Operator Selection, 3-122

- +CPAS, Phone Activity Status, 3-39
- +CPBF, Find Phone Book Entries, 3-63
- +CPBR, Read Phone Book Entries, 3-61
- +CPBS, Select Phone Book Memory, 3-60
- +CPBW, Write Phone Book Entry, 3-64
- +CPIN, Enter PIN for Unlocking SIM Card or Enter PUK for Unlocking SIM Card, 3-177
- +CPMS, Preferred Message Storage, 3-76
- +CPUC, Price per Unit and Currency Table, 3-48
- +CPWD, Change Password, 3-183
- +CR, Service Reporting Control, 3-49
- +CRC, Cellular Result Codes, 3-17
- +CREG, Network Registration Status, 3-119
- +CRLP, Radio Link Protocol, 3-118
- +CRSM, Restricted SIM Access, 3-216
- +CRTT, Ring Type Selection, 3-173
- +CSCA, Service Center Address, 3-78
- +CSMS, Select Message Service, 3-75
- +CSNS, Single Numbering Call Scheme, 3-34
- +CSQ, Signal Strength, 3-117
- +CSSN, Supplementary Service Notifications, 3-50
- +CTFR1, Divert an Incoming Call When User Busy, 3-37
- +CUSD, Unstructured Supplementary Service Data, 3-53
- +EMPC, Unlocking or Locking Subsidy Code, 3-187
- +EPIN, Enter SIM PIN2 to Verify PIN2 Indicator, 3-181
- +FMI, Request Manufacturer ID, 3-1
- +FMM, Request Model ID, 3-2
- +FMR, Request Revision, 3-3
- +GMI, Request Manufacturer ID, 3-1
- +GMM, Request Model ID, 3-2
- +GMR, Request Revision, 3-3
- +GSN, Request Product Serial Number Identification, 3-3
- +ICF, DTE-DCE Character Framing, 3-142
- +IPR, Local DTE-DCE Serial Port Rate, 3-133
- +MA, Audio Control Commands, 3-163
- +MAFEAT, Features Selection, 3-169
- +MAMUT, Input Devices Mute, 3-168
- +MAPATH, Audio Path, 3-163
- +MAVOL, Volume Setting, 3-166
- +MCSAT, Motorola Control SMS Alert Tone, 3-111
- +MCSN, Motorola Change Subscriber Number, 3-69
- +MCWAKE, GPRS Coverage, 3-139
- +MDC, Selection of Desired Message to Be Displayed Upon Connection of a Voice Call, 3-36
- +MDSI, Motorola Deactivate SIM Card Indication, 3-67
- +MFS, Motorola Frequency of Search, 3-126
- +MGEER, GPRS Extended Error Report, 3-240
- +MGGIND, GSM/GPRS Service Indicator, 3-140
- +MIOC, Motorola I/O Configure, 3-144
- +MIOD, Motorola I/O Define, 3-147
- +MIPCALL, Create a Wireless Link, 3-276
- +MIPCFE, Control Filtering Feature for incoming TCP connection, 3-301
- +MIPCLOSE, Close a Socket, 3-282
- +MIPFLUSH, Flush Data from Buffers, 3-286
- +MIPODM, Open a Socket (UDP or TCP) in Online Data Mode, 3-279
- +MIPOPEN, Open a Socket (UDP or TCP), 3-277
- +MIPPUSH, Push Data into Protocol Stack, 3-285
- +MIPRTCP, Receive Data from TCP Protocol Stack, 3-287
- +MIPRUDP, Receive Data from UDP Protocol Stack, 3-287
- +MIPSEND, Send Data, 3-284
- +MIPSTAT, Status Report, 3-288
- +MMAD, Query and Monitor ADC Value, 3-149
- +MMAR, Motorola Mark As Read, 3-101
- +MMGL, List Messages, 3-89
- +MMGR, Read Message, 3-94
- +MPING, Start Ping Execution (ICMP Protocol), 3-292
- +MPINGSTAT, Status Update for +MPING Execution, 3-296
- +MRST, Perform Hard Reset, 3-143
- +MSCTS, Enable/Disable CTS During Wakeup Period, 3-205
- +MSDNS, Set DNS IP Address, 3-299
- +MTCTS, CTS Line Test Command, 3-135
- +MTTY, Motorola TTY Configuration, 3-57
- +MVC, Motorola Vocoders Configuration, 3-38
- +TPIN, Query Number of Remaining SIM PIN/PUK Entering Attempts, 3-182
- ?, Return the Value of the Last Updated S-Register, 3-198
- A, Answer Incoming Call, 3-17
- A/, Repeat Last Command, 3-177
- Access Control Commands, 3-177
- AT, Check AT Communication, 3-177
- ATS97, Antenna Diagnostic, 3-143
- Audio Tone Commands, 3-158
- Call Control, 3-9, 3-11
- Capability Reporting, 3-8
- D*99, Request GPRS Service "D", 3-242
- D, Dial, 3-11
- Directory Access Commands, 3-60
- DL, Dial Last Number, 3-14
- E, Command Echo, 3-192
- Error Handling Commands, 3-206
- GPRS Commands, 3-223
- H, Hang-up Call, 3-15
- Hardware Information, 3-129
- I, Request Identification Information, 3-6
- IGNORED (Compatible Only) Commands, 3-304
- J, Terminal Auto Rate, 3-197
- MIPSETS, Set Size for Automatic Push, 3-283
- MIPXON, Flow Control - Xoff, 3-288
- MIPXON, Flow Control - Xon, 3-289
- Modem Configuration and Profile, 3-190
- Modem ID, 3-1
- Modem Register Commands, 3-190
- Network Commands, 3-117
- O, Return to Online Data State, 3-33
- Phone and Date Books, 3-60
- Q, Result Code Suppression, 3-191
- S, Bit Map Registers, 3-194
- S, Show the Status of the Commands and S-Registers in Effect, 3-197
- S102, Set Delay Before Sending Data to the Terminal, 3-203
- S24, Set Number of Seconds Delay before G24 Enters

- Sleep Mode, 3-202
- S94, Sidetone Effect, 3-161
- S96, Echo Canceling, 3-162
- Sleep Mode AT Commands, 3-200
- Sleep Mode Commands, 3-199
- Sleep Mode HW Signals, 3-200
- SMS Commands, 3-75
- Subscriber Unit Identity, 3-1
- System Date and Time Access Commands, 3-73
- TCP/IP, 3-276
- UI, 3-216
- Unsolicited UI Status Messages, 3-229
- V, G24 Response Format, 3-190
- X, Result Code Selection and Call Progress Monitoring Control, 3-193
- Z, Reset to Default Configuration, 3-199
- AT Commands Summary, 1-15, A-1
- AT Commands Reference
 - +CSCS, Select Terminal Character Set, 3-4
- AT Communication
 - Check, 3-177
- Audio, 1-8, 3-155
 - +MA Audio Control Commands, 3-163
 - Features and Benefits, 1-8
 - Overview, 1-8
 - Technical Description, 1-9
 - Tone Commands, 3-158
- Audio Path, 3-163
- Audio Tone Commands, 3-158
- Automatic Push
 - Set Size, 3-283

B

- Battery
 - Charger Connection, 3-129
- Baud Rate Regulation, 3-132
- Bearer
 - Select, 3-31
- Bit Map Registers, 3-194
- Buffers
 - Flush Data, 3-286

C

- Call
 - Indicator, 3-17
- Call Control, 3-9, 4-14
 - Dialing Electronic Telephone Service, 3-10
 - Hanging Up, 3-10
 - Managing a CSD (Data) Call, 3-9
 - Receiving Data Call, 3-10
 - Simple Dialing, 3-9
 - Switching Modes, 3-10
- Call Control Commands, 3-11
- Call Forwarding
 - Conditions, 3-27
 - Numbers, 3-27
- Call Progress
 - Monitoring Control, 3-193

- Call Waiting, 3-21
- Calling Line
 - Identification, 3-19
 - Identification Restriction, 3-29
- Capability Reporting, 3-8
- Cellular Result Codes, 3-17
- Character Set
 - Terminal, 3-4
- Character Set Conversion tables, 1-13
- Character Sets
 - 8859, 1-14
 - ASCII, 1-13
 - GSM, 1-13
 - UCS2, 1-13
 - UTF-8, 1-13
- Charge
 - Advice, 3-44
- Circuit 108 Behavior, 3-138
- Circuit 109 Behavior, 3-136
- Clock, 3-60
- Command Argument Types
 - Numeric Constants, 2-7
 - String Constants, 2-7
- Command ArgumentTypes, 2-7
- Command Mode Types, 2-7
- Command ModeTypes
 - Parameter Read Command Syntax, 2-7
 - Parameter Set Command Syntax, 2-7
 - Parameter Test Command Syntax, 2-7
- Command Token Types, 2-6
 - Basic Syntax Command Format, 2-6
 - Extended Syntax Command Format, 2-6
 - S-parameters, 2-6
- Commands
 - Show Status, 3-197
- Communication Cable, 4-4
- Compatible Only Commands, 3-304
- Configuration
 - Protocol and Structure of AT Commands, 2-5
- Constants
 - Numeric in Command Argument Types, 2-7
 - String in Command Argument Types, 2-7
- CSD, 1-2
 - Features and Benefits, 1-2
 - Overview, 1-2
 - Technical Description, 1-2
- CSD Operation, 1-2
- CTS
 - Enable/Disable During Wakeup Period, 3-205
 - Flow Control, 3-135
 - Line Test, 3-135
- Current Calls
 - List, 3-40

D

- Data
 - Flush from Buffers, 3-286
 - Push into Protocol Stack, 3-285

- Receive from TCP Protocol Stack, 3-287
- Receive from UDP Protocol Stack, 3-287
- Send, 3-284
- Data Call, 4-18
- Data Calls
 - Managing, 3-9
 - Receiving, 3-10
- Date
 - Read/Set, 3-73
- Default Configuration
 - Reset, 3-199
- Dial
 - Last Number, 3-14
- Dial Command, 3-11
- Dialing, 3-9
 - Electronic Telephone Service, 3-10
- Directory Access Commands, 3-60
- DTE-DCE
 - Serial Port Rate, 3-133
- DTE-DCE Serial Port Rate, 3-133

E

- Echo, 3-192
- Echo Cancel, 1-9
- Echo Canceling, 3-162
- Equipment
 - Report Mobile Error, 3-206
- Error Handling Commands, 3-206
- Error Report, 3-213
- Extended, 3-213
- Extended Syntax Command Format, 2-6

F

- Facility Lock, 3-184
- Factory Defined Configuration
 - Set, 3-198
- Features and Benefits
 - Audio, 1-8
 - CSD, 1-2
 - GPRS, 1-1
 - SMS, 1-11
 - TCP/IP, 1-7
- Features Selection, 3-169
- Flow Control
 - Xoff, 3-288
 - Xon, 3-289

G

- GPRS
 - Attach/Detach, 3-237
 - Coverage, 3-139, 3-244
 - Features and Benefits, 1-1
 - Mobile Station Class, 3-231
 - Operation, 1-1
 - Overview, 1-1
 - Request Service "D", 3-242
 - Technical Description (Class B Operation), 1-1

- GPRS Commands, 3-230
- GPRS Operation, 1-1
- GSM Character Set Management, 1-13

H

- Hanging Up, 3-10
- Hang-up Call, 3-15
- Hardware Information, 3-129

I

- Identification
 - Request Information, 3-6
- IGNORED (Compatible Only) Commands, 3-304
- Ignored Commands, 3-304
- IMSI
 - Request, 3-5
- Incoming Call
 - Answer, 3-17
- Incoming Call Indicator, 3-17
- Indications
 - New Message, 3-82
- Indicator
 - Incoming Call, 3-17
- Init General, 4-10
- Input Devices
 - Mute, 3-168

K

- Key Press Echo
 - Set/Request, 3-225–3-227

L

- Last Command
 - Repeat, 3-177
- Last Number
 - Dial, 3-14
- Line
 - Identification Restriction, 3-29

M

- Manufacturer ID
 - Request, 3-1
- Message
 - Acknowledgement, 3-84
 - Indication, 3-82
 - Receipt Indication, 3-86
- Message Format, 3-77
- Message Service
 - Select, 3-75
- Message Storage
 - Preferred, 3-76
- Messages
 - Delete, 3-108
 - List, 3-89
 - Mark as Read, 3-101
 - Read, 3-94

- Send from Storage, [3-101](#)
- Write to Memory, [3-103](#)
- Mobile Equipment
 - Report Error, [3-206](#)
- Mobile Station Class, [3-231](#)
- Mode Types in AT Commands, [2-7](#)
- Model ID
 - Request, [3-2](#)
- Modem
 - Configuration, [3-190](#)
 - Profile, [3-190](#)
- Modem ID, [3-1](#)
 - Subscriber Unit Identity, [3-1](#)
- Modem Register Commands, [3-190](#)
- Modes
 - Switching, [3-10](#)
- MSISDN(s)
 - Request, [3-6](#)
- Mute
 - Input Devices, [3-168](#)

N

- Network Commands, [3-117](#)
- Network Registration, [3-121](#)
 - Status, [3-119](#)
- Noise Suppress, [1-9](#)
- NOP - Compatible, [3-304](#)

O

- OEM Features
 - Improved, [1-3](#)
- Online Data State
 - Return to, [3-33](#)
- Operator Selection, [3-122](#)
- Overview
 - AT Commands, [2-1](#)
 - Audio, [1-8](#)
 - CSD, [1-2](#)
 - GPRS, [1-1](#)
 - SMS, [1-11](#)
 - TCP/IP, [1-3, 1-5](#)

P

- Parameter Read Command Syntax
 - Command Mode Types, [2-7](#)
- Parameter Set Command Syntax
 - Command Mode Types, [2-7](#)
- Parameter Test Command Syntax
 - Command Mode Types, [2-7](#)
- Password
 - Change, [3-183](#)
- PDP Context
 - Define, [3-232](#)
- Phone
 - Activity Status, [3-39](#)
- Phone Book, [3-60](#)
 - Directory Access Commands, [3-60](#)

- Find Entries, [3-63](#)
- Read Entries, [3-61](#)
- Select Memory, [3-60](#)
- Write Entry, [3-64](#)
- PIN
 - Unlocking SIM Card, [3-177](#)
- Power On/INIT, [4-1](#)
- Protocol
 - AT Commands, [2-2](#)
- Protocol Stack
 - Push Data, [3-285](#)
 - Receive Data, [3-287](#)
- PUK
 - Unlocking SIM Card, [3-177](#)
- Push
 - Automatic, [3-283](#)

Q

- Quality
 - Min. Acceptable Service, [3-234](#)
 - Requested Service Profile, [3-236](#)
- Quality of Service Profile, [3-234, 3-236](#)

R

- Radio
 - Change Band, [3-197](#)
- Radio Link Protocol, [3-118](#)
- Repeat
 - Last Command, [3-177](#)
- Reset
 - Default Configuration, [3-199](#)
- Response and Indications Structure, [2-4](#)
- Response Format, [3-190](#)
- Result Code
 - Selection, [3-193](#)
 - Suppression, [3-191](#)
 - Unsolicited, [3-86](#)
- Results Code Structure, [2-4](#)
- Revision
 - Request, [3-3](#)
- Ring Type Selection, [3-173](#)
- RTS Flow Control, [3-135](#)

S

- Sending, [1-11](#)
- Sending SMS, [1-11](#)
- Serial Number
 - Request Identification, [3-3](#)
- Serial Port Rate, [3-133](#)
- Service Center
 - Address, [3-78](#)
- Service Type
 - Select, [3-31](#)
- Side Tone Effect, [3-161](#)
- Sidetone, [1-8](#)
- Signal Strength, [3-117](#)
- SIM Card

- Unblocking, [3-177](#)
- Unlocking, [3-177](#)
- Sleep Mode
 - HW Signals, [3-200](#)
 - Set Delay, [3-202](#)
- Sleep Mode AT Commands, [3-200](#)
- Sleep Mode Commands, [3-199](#)
- SM, [3-216](#)
- SMS, [1-11](#), [4-10](#)
 - Features and Benefits, [1-11](#)
 - Overview, [1-11](#)
 - Technical Description, [1-12](#)
- SMS Commands, [3-75](#)
- Socket
 - Close, [3-282](#)
 - Open, [3-277](#)
- S-parameters in Command Token Types, [2-6](#)
- S-Registers
 - Show Status, [3-197](#)
- S-Regsiter
 - Return Last Updated, [3-198](#)
- Status
 - Commands and S-Registers in Effect, [3-197](#)
 - Network Registration, [3-119](#)
 - Phone Activity, [3-39](#)
- Status Messages
 - Unsolicited, [3-229](#)
- Status Report, [3-288](#)
- Storage
 - Message, [3-76](#)
- Structure
 - Response and Indications in AT Commands, [2-4](#)
 - Results Code in AT Commands, [2-4](#)
- Structure of AT Commands, [2-3](#)
- Subscriber Unit Identity, [3-1](#)
- Supplementary Services
 - Call Related, [3-23](#)
- System Date and Time Access Commands, [3-73](#)

T

- TCP/IP, [1-5](#), [3-276](#)
 - Features and Benefits, [1-7](#)
 - Overview, [1-3](#), [1-5](#)
 - Technical Description, [1-8](#)
- Technical Description
 - Audio, [1-9](#)
 - CSD, [1-2](#)
 - GPRS (Class B Operation), [1-1](#)
 - SMS, [1-12](#)
 - TCP/IP, [1-8](#)
- Terminal Auto Rate, [3-197](#)
- Time
 - Read/Set, [3-73](#)
- Token Types in AT Commands, [2-6](#)

U

- UCS2 Character Set Management, [1-13](#)
- Unblocking
 - SIM Card, [3-177](#)
- Unlocking
 - SIM Card, [3-177](#)
- Unsolicited Result Code, [3-86](#)
- Unsolicited UI Status Messages, [3-229](#)
- User Interface Commands, [3-216](#)
- UTF-8 Character Set Management, [1-13](#)

V

- Values in AT Commands, [2-8](#)
 - Compound Range, [2-8](#)
 - Range, [2-8](#)
- Volume Setting, [3-166](#)

W

- Wireless Link
 - Create, [3-276](#)

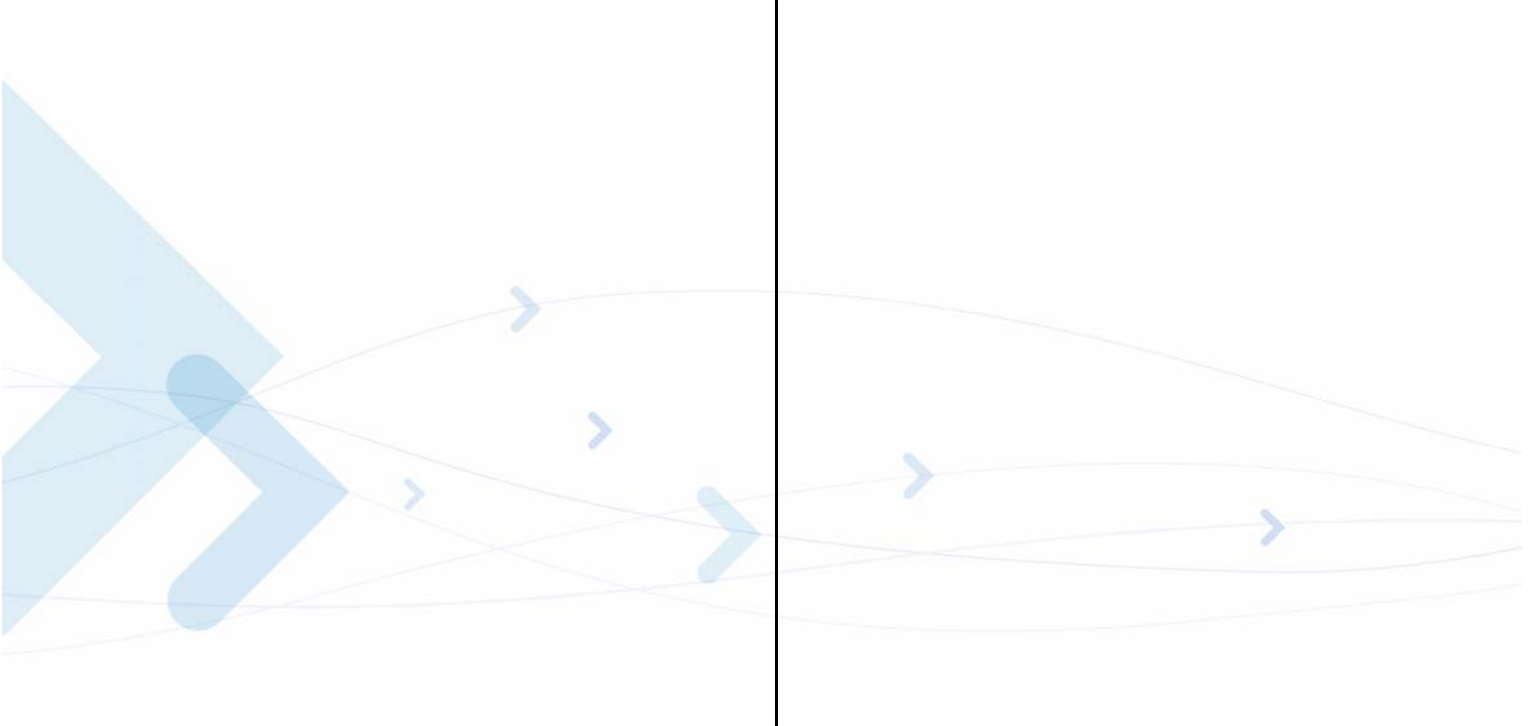

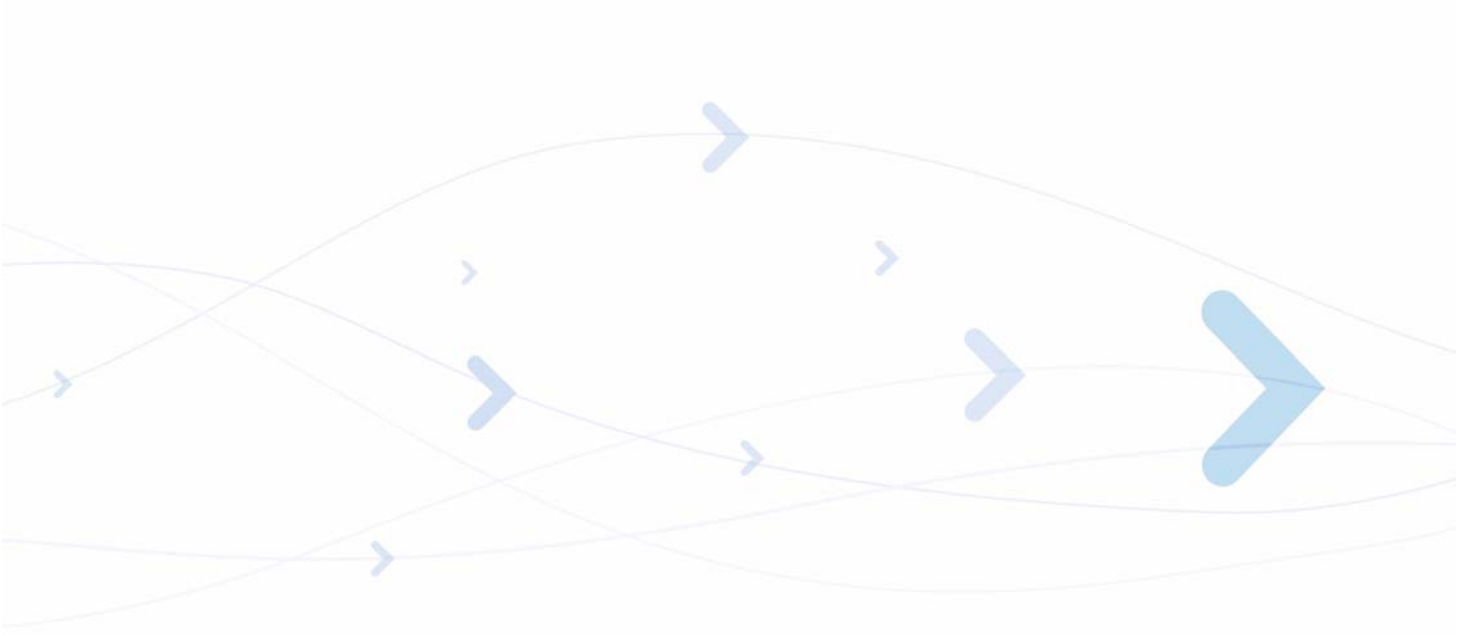

MOTOROLA and the Stylized M Logo are registered in the US Patent & Trademark Office.
All other product or service names are the property of their respective owners.
©Copyright 2007 Motorola, Inc.
Java™ Technology and/or J2ME™ : Java and all other Java-based marks are trademarks or registered trademarks of Sun Microsystems, Inc. in the U.S. and other countries.
UNIX® : UNIX is a registered trademark of The Open Group in the United States and other countries.



6802983C95-C