

# SmartNode 4830 Series Analog VoIP Integrated Access Device

## Getting Started Guide

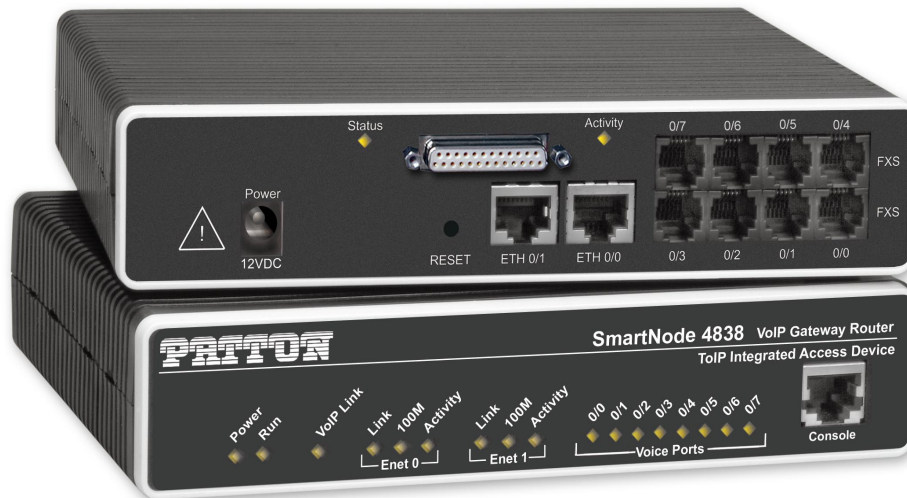

### Approval

Models that are equipped with telecom interfaces have been approved for connection to the public telecommunication network as listed under PSTN regulatory compliance.

### Important

This is a Class A device and is intended for use in a light industrial environment. It is not intended nor approved for use in an industrial or residential environment.

Sales Office: +1 (301) 975-1000  
Technical Support: +1 (301) 975-1007  
E-mail: [support@patton.com](mailto:support@patton.com)  
WWW: [www.patton.com](http://www.patton.com)

Document Number: **13219U1-001 Rev. C**  
Part Number: **07MSN4830-GS**  
Revised: **May 16, 2007**

**Patton Electronics Company, Inc.**

7622 Rickenbacker Drive  
Gaithersburg, MD 20879 USA  
Tel: +1 (301) 975-1000  
Fax: +1 (301) 869-9293  
Support: +1 (301) 975-1007  
URL: [www.patton.com](http://www.patton.com)  
E-Mail: [support@patton.com](mailto:support@patton.com)

**Trademark Statement**

The terms *SmartWare* and *SmartView* are trademarks of Patton Electronics Company. All other trademarks presented in this document are the property of their respective owners.

**Copyright © 2006–2007, Patton Electronics Company. All rights reserved.**

The information in this document is subject to change without notice. Patton Electronics assumes no liability for errors that may appear in this document.

**Warranty Information**

The software described in this document is furnished under a license and may be used or copied only in accordance with the terms of such license.

**Patton Electronics** warrants all SmartNode product components to be free from defects, and will—at our option—repair or replace the product should it fail within one year from the first date of the shipment.

This warranty is limited to defects in workmanship or materials, and does not cover customer damage, abuse or unauthorized modification. If the product fails to perform as warranted, your sole recourse shall be repair or replacement as described above. Under no condition shall **Patton Electronics** be liable for any damages incurred by the use of this product. These damages include, but are not limited to, the following: lost profits, lost savings and incidental or consequential damages arising from the use of or inability to use this product. **Patton Electronics** specifically disclaims all other warranties, expressed or implied, and the installation or use of this product shall be deemed an acceptance of these terms by the user.

# Summary Table of Contents

- 1 General information ..... 15
- 2 Applications overview..... 25
- 3 Hardware installation..... 28
- 4 Getting started with the SmartNode..... 43
- 5 LEDs status and monitoring ..... 52
- 6 Contacting Patton for assistance ..... 56
- A Compliance information ..... 59
- B Specifications ..... 63
- C Cabling ..... 70
- D Port pin-outs ..... 76
- E SmartNode 4830 Series factory configuration ..... 81
- F Installation checklist ..... 83
- G Accessories ..... 85

# Table of Contents

<b>Summary Table of Contents</b> .....	<b>3</b>
<b>Table of Contents</b> .....	<b>4</b>
<b>List of Figures</b> .....	<b>8</b>
<b>List of Tables</b> .....	<b>9</b>
<b>About this guide</b> .....	<b>10</b>
Audience.....	10
Structure.....	10
Precautions .....	11
Safety when working with electricity .....	12
General observations .....	13
Typographical conventions used in this document.....	13
General conventions .....	13
<b>1 General information</b> .....	<b>15</b>
SmartNode Model 4830 Series Overview .....	16
SmartNode 4830 Series Detailed Description .....	18
Ports descriptions .....	22
Reset button behavior .....	22
<b>2 Applications overview</b> .....	<b>25</b>
Introduction .....	26
Applications for SmartNode 4830 Series .....	26
Multiservice carrier access over leased lines .....	26
Converged enterprise network over leased line .....	27
<b>3 Hardware installation</b> .....	<b>28</b>
Planning the installation .....	29
Installation checklist .....	30
Site log .....	31
Network information .....	31
Network Diagram .....	31
IP related information .....	31
Software tools .....	32
Power source .....	32
Location and mounting requirements .....	32
Installing the VoIP IAD .....	32
Mounting the VoIP IAD .....	32
Connecting cables .....	32
Installing an interface cable on the VoIP IAD's FXS and FXO interface ports .....	33
Installing the Ethernet cable .....	35
Installing the serial WAN cable .....	36
Installing the DSL interface cable .....	37

Installing the V.35 interface cable .....	37
Installing the X.21 interface cable .....	38
Installing the T1/E1 twisted pair cables .....	39
Installing the E1 dual coaxial cables .....	40
Connecting to external power source .....	41
<b>4 Getting started with the SmartNode.....</b>	<b>43</b>
Introduction .....	44
1. Configure IP address .....	45
Power connection and default configuration .....	45
Connect with the serial interface .....	45
Login .....	46
Changing the IP address .....	46
2. Connect the SmartNode to the network.....	47
3. Load configuration .....	47
Bootloader.....	48
Start Bootloader .....	48
Start-up with factory configuration .....	49
Load a new application image (SmartWare) via TFTP .....	49
Load a new application image (SmartWare) via the serial link .....	51
Additional information.....	51
<b>5 LEDs status and monitoring .....</b>	<b>52</b>
Status LEDs.....	53
<b>6 Contacting Patton for assistance .....</b>	<b>56</b>
Introduction .....	57
Contact information.....	57
Patton support headquarters in the USA .....	57
Alternate Patton support for Europe, Middle East, and Africa (EMEA) .....	57
Warranty Service and Returned Merchandise Authorizations (RMAs).....	57
Warranty coverage .....	57
Out-of-warranty service .....	58
Returns for credit .....	58
Return for credit policy .....	58
RMA numbers .....	58
Shipping instructions .....	58
<b>A Compliance information .....</b>	<b>59</b>
Compliance .....	60
EMC compliance: .....	60
Safety compliance: .....	60
PSTN regulatory compliance: .....	60
Radio and TV Interference (FCC Part 15) .....	60
FCC Part 68 (ACTA) Statement (FXO ports).....	61
Industry Canada Notice (FXO ports).....	61

CE Notice .....	62
Authorized European Representative .....	62
<b>B Specifications .....</b>	<b>63</b>
DSP.....	64
Voice connectivity .....	64
Ethernet interface .....	64
Sync serial interface (if applicable) .....	64
T1/E1 interface (if applicable) .....	64
ADSL Daughter Card (if applicable) .....	65
G.SHDSL Daughter Card (if applicable).....	65
PPP and Frame-Relay support .....	66
Voice processing (signaling dependent).....	66
Fax and modem support .....	66
Voice signaling .....	66
Voice routing—session product.....	67
IP services.....	67
Management .....	67
Operating environment .....	68
Operating temperature .....	68
Operating humidity .....	68
System .....	68
Dimensions .....	68
Weight and power dissipation .....	68
Power supply .....	68
Identification of the SmartNode devices via SNMP.....	69
<b>C Cabling .....</b>	<b>70</b>
Introduction .....	71
Serial console.....	71
Ethernet 10Base-T and 100Base-T .....	72
Analog FXS .....	73
Analog FXO .....	74
T1/E1.....	75
DSL.....	75
<b>D Port pin-outs .....</b>	<b>76</b>
Introduction.....	77
Console port.....	77
Ethernet 10Base-T and 100Base-T port.....	77
Sync Serial Port .....	78
V.35 Serial port .....	78
X.21 Serial Port .....	79
FXS port.....	79
FXO port .....	79
T1/E1 port .....	80

ADSL/G.SHDSL port.....	80
<b>E SmartNode 4830 Series factory configuration .....</b>	<b>81</b>
Introduction.....	82
<b>F Installation checklist .....</b>	<b>83</b>
Introduction.....	84
<b>G Accessories .....</b>	<b>85</b>
Introduction.....	86

## List of Figures

1	SmartNode product (SmartNode 4838 shown)	16
2	SmartNode product (SmartNode 4838 with DSL shown)	16
3	Examples of SN4830 Series rear panels (FXS only)	18
4	Examples of SN4830 Series rear panels (FXO only and combined FXS/FXO)	19
5	SmartNode 4830 Series DSL, X.21, V.35, and T1/E1 serial connectors	20
6	SmartNode 4830 Series power input connector	21
7	SmartNode 4830 Series front panels (FXS only)	23
8	SmartNode 4830 Series front panels (FXO only and combined FXS/FXO)	24
9	Multiservice carrier access over leased lines	26
10	Converged enterprise network over leased line	27
11	Rear view showing location of Ethernet and FXS connectors (SmartNode 4834 shown)	33
12	Analog FXS connection	33
13	RJ-11 pinout diagram	34
14	Analog FXO connection	35
15	Connecting a SmartNode 4830 Series device to a hub	36
16	Rear view of the SN4830 showing location of V.35 interface connector	37
17	Rear view of the SN4830 showing location of X.21 interface connector	38
18	Rear panel of SN4830 T1/E1 -/K Model	39
19	Rear panel of SN4830 T1/E1 -/T Model	39
20	Rear panel of SN4830 T1/E1 -/K Model	40
21	Power connector location on rear panel	41
22	VoIP IAD front panel LEDs and Console port locations (SmartNode 4834 shown)	42
23	Steps for setting up a new SmartNode	44
24	Connecting to the terminal	45
25	Connecting the SmartNode to the network	47
26	SmartNode 4830 Series front panels (FXS only)	53
27	SmartNode 4830 Series front panels (FXO only and combined FXS/FXO)	54
28	Connecting a serial terminal	71
29	Ethernet straight-through	72
30	Connecting an FXS device	73
31	Connecting to an FXO line socket	74
32	Connecting the DSL cable	75
33	EIA-561 (RJ-45 8-pin) port	77



## List of Tables

1	General conventions	13
2	Rear panel ports	22
3	Installation checklist	30
4	Sample site log entries	31
5	RJ-11 socket	34
6	Ethernet 10/100Base-T (RJ-45) port pin-outs	35
7	Signal pin-outs for the V.35 interface on the SmartNode 4830	37
8	Signal pin-outs for the X.21 interface on the SmartNode 4830	39
9	RJ-48C receptacle	39
10	Factory default IP address and network mask configuration	45
11	SmartNode LED Indications	55
12	G.SHDSL Daughter Card Specifications	65
13	SmartNode weight and maximum power specifications	68
14	SmartNode Models and their Unique sysObjectID	69
15	RJ-45 socket	77
16	V.35 Female DB-25 connector	78
17	X.21 Female DB-15 connector	79
18	RJ-11 socket	79
19	RJ-11 socket	79
20	RJ-45 socket	80
21	RJ-11 connector	80
22	Installation checklist	84
23	Accessory cables	86

# About this guide

---

This guide describes the SmartNode 4830 hardware, installation and basic configuration. For detailed software configuration information refer to the *SmartWare Software Configuration Guide* and the available Configuration Notes.

## Audience

---

This guide is intended for the following users:

- Operators
- Installers
- Maintenance technicians

## Structure

---

This guide contains the following chapters and appendices:

- [Chapter 1](#) on page 15 provides information about product features and capabilities
- [Chapter 2](#) on page 25 contains an overview describing product operation and applications
- [Chapter 3](#) on page 28 provides hardware installation procedures
- [Chapter 4](#) on page 43 provides quick-start procedures for configuring the SmartNode product
- [Chapter 5](#) on page 52 provides LED definitions
- [Chapter 6](#) on page 56 contains information on contacting Patton technical support for assistance
- [Appendix A](#) on page 59 contains compliance information
- [Appendix B](#) on page 63 contains specifications for the products
- [Appendix C](#) on page 70 provides cable recommendations
- [Appendix D](#) on page 76 describes the product's ports and pin-outs
- [Appendix E](#) on page 81 lists the factory configuration settings for the SmartNode 4830
- [Appendix F](#) on page 83 provides license information that describes acceptable usage of the software provided with the SmartNode 4830
- [Appendix G](#) on page 85 lists the cables that are available as accessories for the SmartNode 4900 Series products

For best results, read the contents of this guide *before* you install the product.

## Precautions

Notes, cautions, and warnings, which have the following meanings, are used throughout this guide to help you become aware of potential problems. **Warnings** are intended to prevent safety hazards that could result in personal injury. **Cautions** are intended to prevent situations that could result in property damage or impaired functioning.

**Note** A note presents additional information or interesting sidelights.



IMPORTANT

The alert symbol and IMPORTANT heading calls attention to important information.



CAUTION

The alert symbol and CAUTION heading indicate a potential hazard. Strictly follow the instructions to avoid property damage.



CAUTION

The shock hazard symbol and CAUTION heading indicate a potential electric shock hazard. Strictly follow the instructions to avoid property damage caused by electric shock.



WARNING

The alert symbol and WARNING heading indicate a potential safety hazard. Strictly follow the warning instructions to avoid personal injury.



WARNING

The shock hazard symbol and WARNING heading indicate a potential electric shock hazard. Strictly follow the warning instructions to avoid injury caused by electric shock.

## Safety when working with electricity



WARNING

The SmartNode contains no user serviceable parts. The equipment shall be returned to Patton Electronics for repairs, or repaired by qualified service personnel. Opening the SmartNode case will void the warranty.



WARNING

**Mains Voltage:** Do not open the case when the power cord is attached. For systems without a power switch, line voltages are present within the power supply when the power cords are connected. The mains outlet that is utilized to power the device shall be within 10 feet (3 meters) of the device, shall be easily accessible, and protected by a circuit breaker.



WARNING

For units with an external power adapter, the adapter shall be a listed Limited Power Source.



WARNING

For AC powered units, ensure that the power cable used with this device meets all applicable standards for the country in which it is to be installed, and that it is connected to a wall outlet which has earth ground.



WARNING

Hazardous network voltages are present in WAN ports regardless of whether power to the SmartNode is ON or OFF. To avoid electric shock, use caution when near WAN ports. When detaching cables, detach the end away from the SmartNode first.



WARNING

Do not work on the system or connect or disconnect cables during periods of lightning activity.



WARNING

Before opening the chassis, disconnect the telephone network cables to avoid contact with telephone line voltages. When detaching the cables, detach the end away from the SmartNode first.



The VoIP IAD power supply automatically adjusts to accept an input voltage from 100 to 240 VAC (50/60 Hz).

Verify that the proper voltage is present before plugging the power cord into the receptacle. Failure to do so could result in equipment damage.



The interconnecting cables shall be acceptable for external use and shall be rated for the proper application with respect to voltage, current, anticipated temperature, flammability, and mechanical serviceability.



In accordance with the requirements of council directive 2002/96/EC on Waste of Electrical and Electronic Equipment (WEEE), ensure that at end-of-life you separate this product from other waste and scrap and deliver to the WEEE collection system in your country for recycling.

### General observations

- Clean the case with a soft slightly moist anti-static cloth
- Place the unit on a flat surface and ensure free air circulation
- Avoid exposing the unit to direct sunlight and other heat sources
- Protect the unit from moisture, vapors, and corrosive liquids

## Typographical conventions used in this document

This section describes the typographical conventions and terms used in this guide.

### General conventions

The procedures described in this manual use the following text conventions:

Table 1. General conventions

Convention	Meaning
Garamond blue type	Indicates a cross-reference hyperlink that points to a figure, graphic, table, or section heading. Clicking on the hyperlink jumps you to the reference. When you have finished reviewing the reference, click on the <b>Go to Previous View</b> button  in the Adobe® Acrobat® Reader toolbar to return to your starting point.
Futura bold type	Commands and keywords are in <b>boldface</b> font.
Futura bold-italic type	Parts of commands, which are related to elements already named by the user, are in <b>boldface italic</b> font.
Italicized Futura type	Variables for which you supply values are in <i>italic</i> font
Futura type	Indicates the names of fields or windows.
Garamond bold type	Indicates the names of command buttons that execute an action.
< >	Angle brackets indicate function and keyboard keys, such as <SHIFT>, <CTRL>, <C>, and so on.

Table 1. General conventions

Convention	Meaning
[ ]	Elements in square brackets are optional.
{a   b   c}	Alternative but required keywords are grouped in braces ({ }) and are separated by vertical bars (   )
blue screen	Information you enter is in <code>blue screen</code> font.
screen	Terminal sessions and information the system displays are in <code>screen</code> font.
node	The leading IP address or nodename of a SmartNode is substituted with <b><i>node</i></b> in <b><i>boldface italic</i></b> font.
SN	The leading <b>SN</b> on a command line represents the nodename of the SmartNode
#	An hash sign at the beginning of a line indicates a comment line.

# Chapter 1 **General information**

---

## **Chapter contents**

SmartNode Model 4830 Series Overview .....	16
SmartNode 4830 Series Detailed Description .....	18
Ports descriptions .....	22
Reset button behavior .....	22

## SmartNode Model 4830 Series Overview

The SmartNode 4830 Series Analog VoIP Integrated Access Devices (see [figure 1](#)) combines IP routing, VPN/Security, and Quality of Service with sync-serial WAN access for up to 8 voice and FAX calls over any IP or PSTN network. Leverage low-cost IP services with packet-voice and serial WAN connectivity for complete branch-office voice-and-data networking.

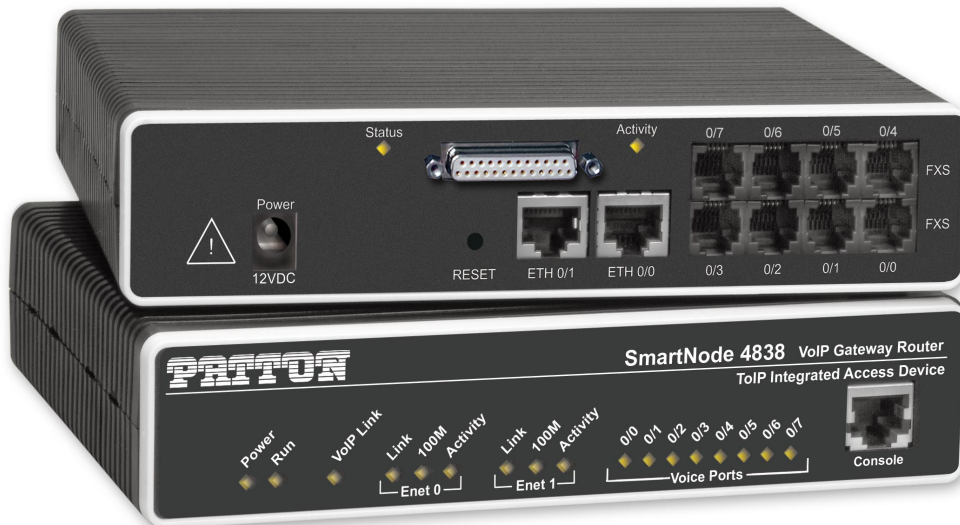

Figure 1. SmartNode product (SmartNode 4838 shown)



Figure 2. SmartNode product (SmartNode 4838 with DSL shown)



The SmartNode 4830 Series Analog VoIP Integrated Access Devices comes equipped with two 10/100Base-T Ethernet ports and plus an integrated ADSL, G.SHDSL, T1/E1, V.35 or X.21 serial-WAN port to provide voice-over-IP (VoIP) and Internet telephony integrated with routed serial-WAN access. The SN4830 IAD series supports Frame-Relay and PPP networking with VPN and firewall functions, and provides extensive Quality of Service (QoS) features for best-possible voice quality over any broadband IP network.

The SmartNode VoIP IAD performs the following major functions:

- Voice over IP and local switching via a combination of 2 to 8 analog phone ports (FXS) and 2 to 4 analog line ports (FXO).
- Standards-compliant conversion between analog voice and digital VoIP in accordance with SIP and H.323 protocols.
- Internet access and IP Routing with IP Quality of Service (QoS) support for mixed voice and data traffic.
- Routed LAN-to-WAN connectivity between two 10/100 Ethernet LAN ports and a ADSL, G.SHDSL, serial T1/E1, V.35, or X.21 WAN interface.

### SmartNode 4830 Series Detailed Description

The SmartNode 4830 Series VoIP Integrated Access Device (IAD) provides VoIP calling for up to 8 analog phone lines seamlessly integrated with 2-port Ethernet LAN connectivity and serial WAN access via a T1/E1, V.35 or X.21 service. Available with various combinations of FXS and FXO ports, this compact analog VoIP and Serial WAN Integrated Access Device supports 2, 4, 6, or 8 VoIP calls (see [figure 3](#) for FXS versions and [figure 4](#) on page 19 for FXO and FXS/FXO combined versions).

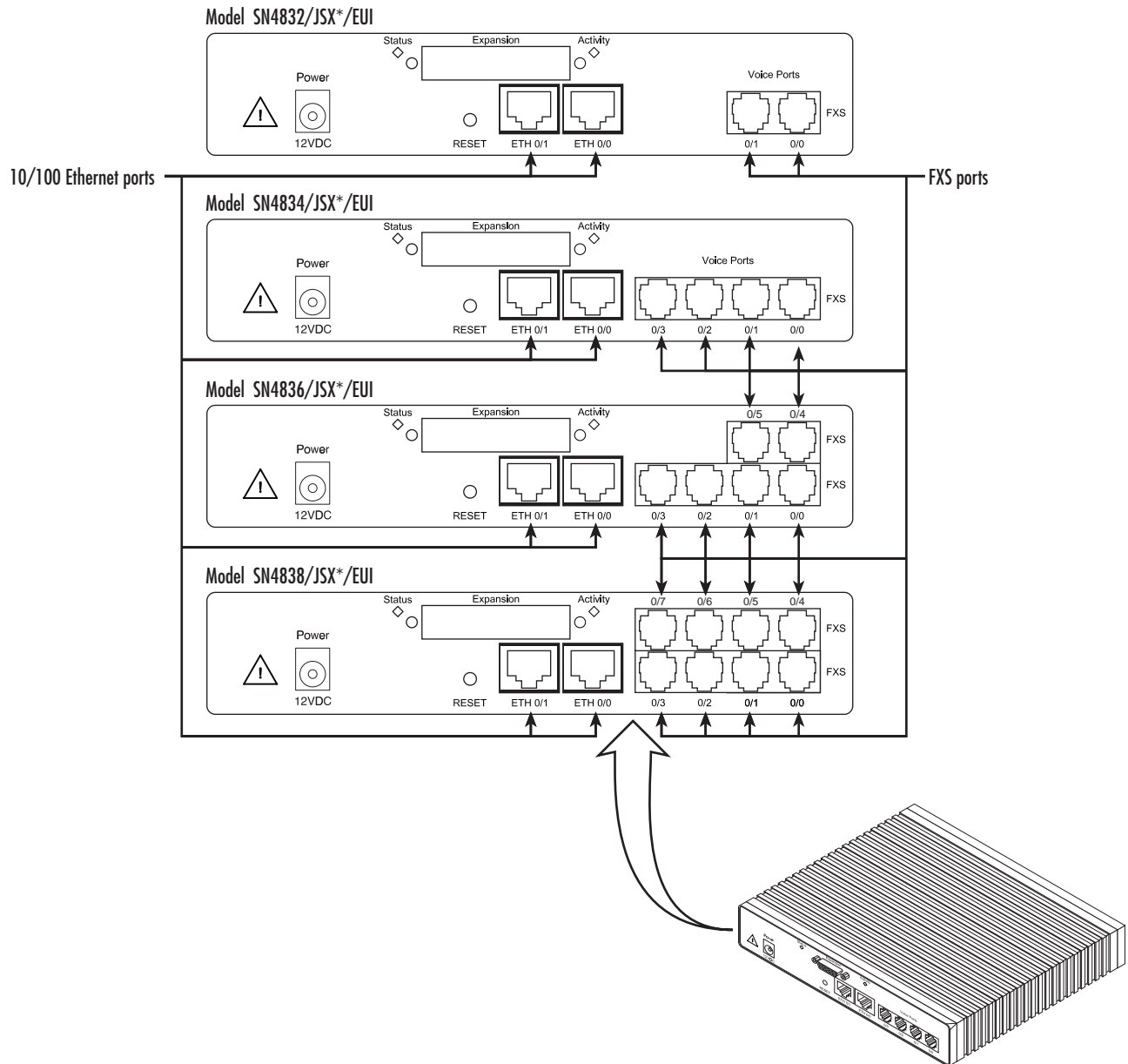

Figure 3. Examples of SN4830 Series rear panels (FXS only)

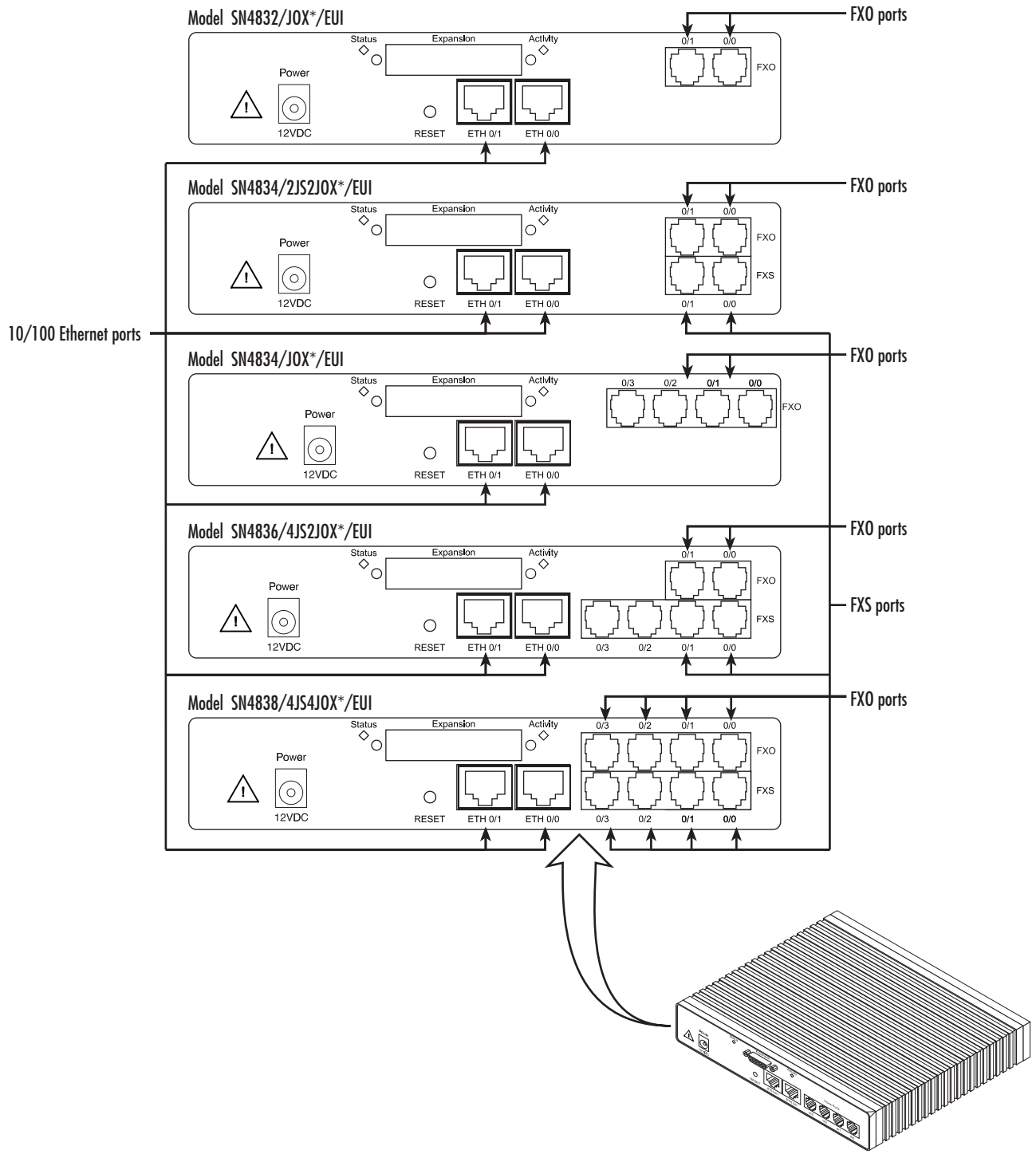

Figure 4. Examples of SN4830 Series rear panels (FXO only and combined FXS/FXO)

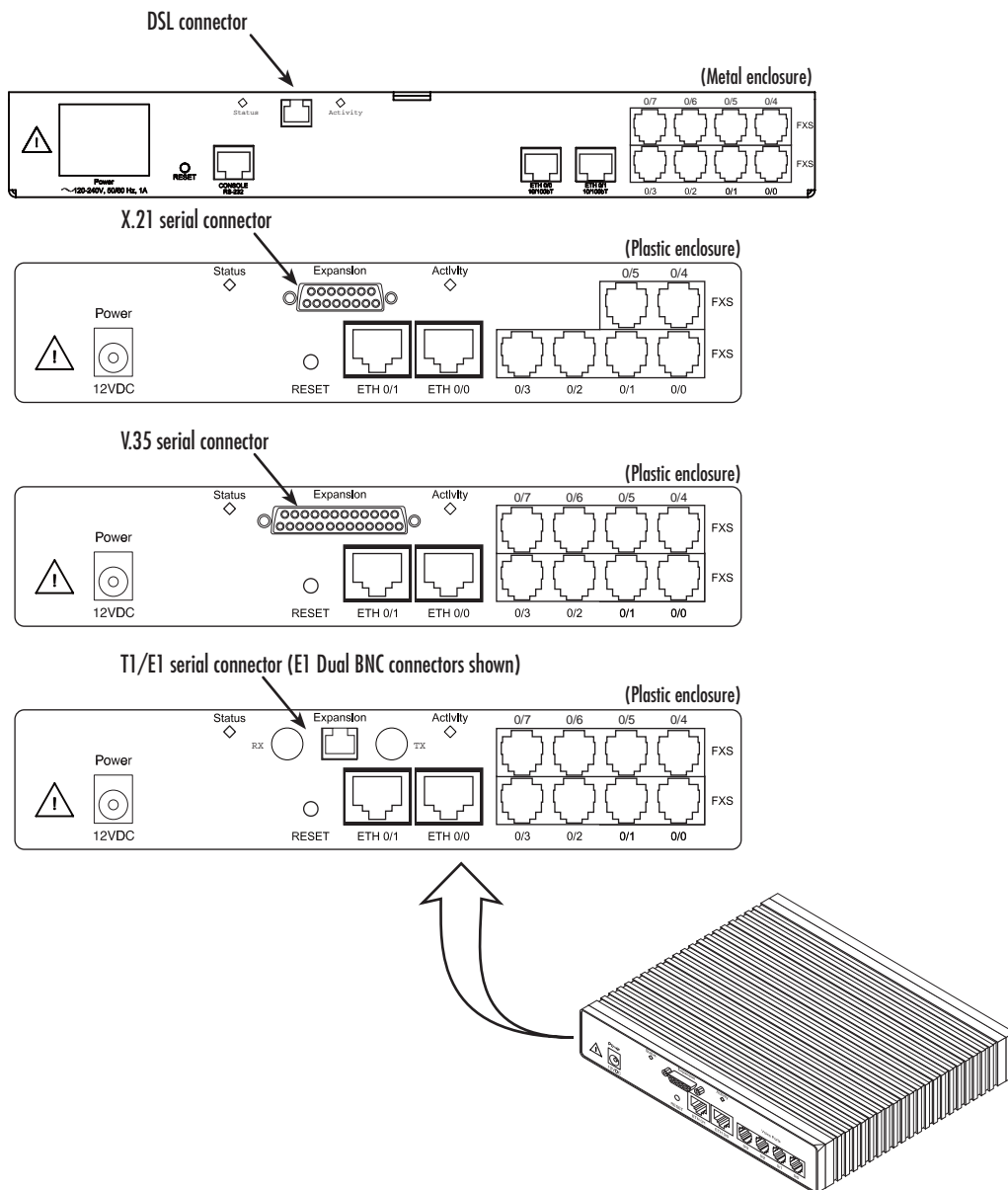

Figure 5. SmartNode 4830 Series DSL, X.21, V.35, and T1/E1 serial connectors

Each model within the SN4830 series comes equipped with two 10/100Base-T Ethernet ports and an integrated V.35, X.21, or T1/E1 serial WAN port (see [figure 5](#)). The following base model numbers are available:

- SmartNode 4832 (2 VoIP calls)
- SmartNode 4834 (4 VoIP calls)
- SmartNode 4836 (6 VoIP calls)
- SmartNode 4838 (8 VoIP calls)

A model-code extension indicates the combination of ports the IAD model provides. The model-code conventions are, according to the following conventions:

- *JS* indicates FXS ports are present
- *JO* indicates FXO ports are present
- *X* stands for the type of WAN interface present. It can take the following values:
  - *C* (V.35)
  - *D* (X.21)
  - *K* (E1 RJ48C plus dual coax)
  - *T* (T1 RJ48C)
  - *AYA* (ADSL Annex A RJ11)
  - *AYB* (ADSL Annex B RJ11),
  - *G* (G.SHDSL RJ11)
- *EUI* stands for external universal input power supply (see [figure 6](#))
- *UI* stands for universal input power supply

For example, the model code *SN4836/4JS2JOD/EUI* describes a SmartNode configured as follows:

- 4 FXS analog telephony ports
- 2 FXO analog telephony voice ports
- An X.21 serial WAN data port
- An external universal input power supply

**Note** For a complete listing of available models, refer to the SmartNode VoIP page at <http://www.patton.com/voip/>.

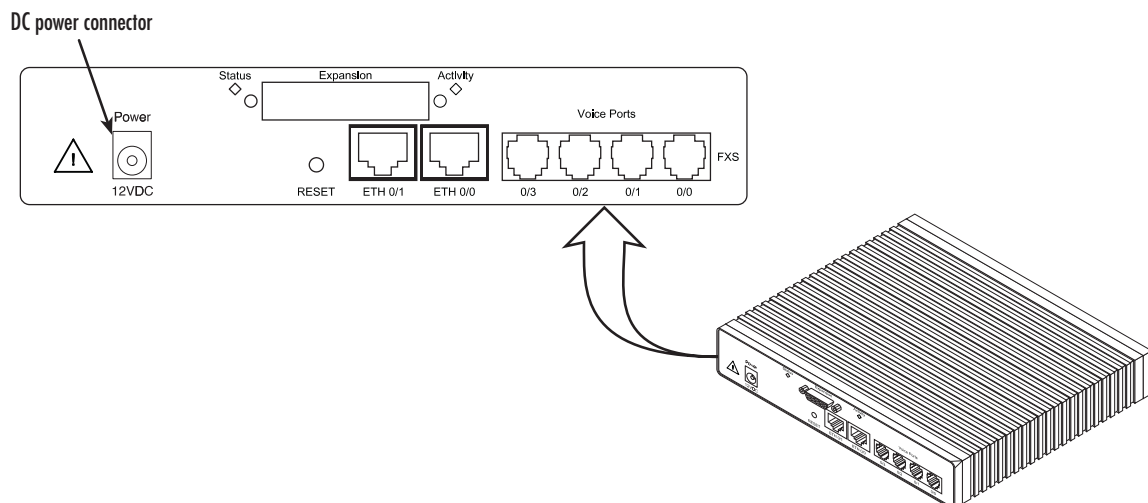

Figure 6. SmartNode 4830 Series power input connector

### Ports descriptions

The SmartNode 4830 Series rear-panel ports are described in [table 2](#).

Table 2. Rear panel ports

Port	Location	Description
10/100 Ethernet ETH 0/0 & ETH 0/1	Rear panel	RJ-45 connectors (see <a href="#">figure 3</a> on page 18) that connect the product to an Ethernet device (e.g., a cable or DSL modem, LAN hub or switch).
Analog voice port, FXS	Rear panel	FXS RJ-11 (6 position, 4 wire) connectors (see <a href="#">figure 3</a> on page 18) that connect the product with an analog terminal (a telephone, for example) FXO port. EuroPOTS support (ETSI EG201 188).
Analog voice port, FXO	Rear panel	FXO RJ-11 (6 position, 4 wire) connectors that connect the product with an analog line (FXS port). EuroPOTS support (ETSI EG201 188).
V.35 or X. 21 Serial (option)	Rear Panel	Female DB-25 or DB-15 socket provides a V.35 or X.21 serial interface for leased-line connection to a WAN at rates up to 2 Mbps.
T1/E1 (option)	Rear panel	E1—G.703/G.704 with HDB3 or AMI encoding. RJ-48C and dual coaxial connectors. T1—ANSI T1.403 & AT&T TR54016 with AMI coding/D4 framing or B8ZS coding/ESF framing. RJ-48C connector.
G.SHDSL/ADSL port (option)	Rear panel	Provides up to 5.7 Mbps (G.SHDSL) or 8 Mbps (ADSL) symmetrical throughput, supporting ATM QoS. Supports multiple PVC and DSLAM interoperability. The DSL LEDs are located on either side of the DSL port. ACT (when lit or blinking) shows Activity, and LINK (when lit) shows that the DSL port is connected.
Power	Rear panel	The gateway is available in a DC or AC power input version (see <a href="#">figure 6</a> ), labeled 100–240 VAC, 50/60 Hz, 200 mA
Console	Front panel	Used for service and maintenance, the Console port (see <a href="#">figure 7</a> on page 23), an RS-232 RJ-45 connector, connects the product to a serial terminal such as a PC or ASCII terminal (also called a dumb terminal).

### Reset button behavior

For those SmartNode devices that have a *Reset* button on the rear panel, its behavior is as follows:

- To restart the unit with the current startup configuration—Press for less than 1 second and release the *Reset* button. The SmartNode will restart with the current startup configuration.
- To restart the unit with factory default configuration—Press the *Reset* button for 5 seconds until the Power LED starts blinking. The unit will restart with factory default configuration.
- To restart the unit in bootloader mode (to be used only by trained SmartNode technicians)—Start with the unit powered off. Press and hold the *Reset* button while applying power to the unit. Release the *Reset* button when the *Power* LED starts blinking so the unit will enter bootloader mode.

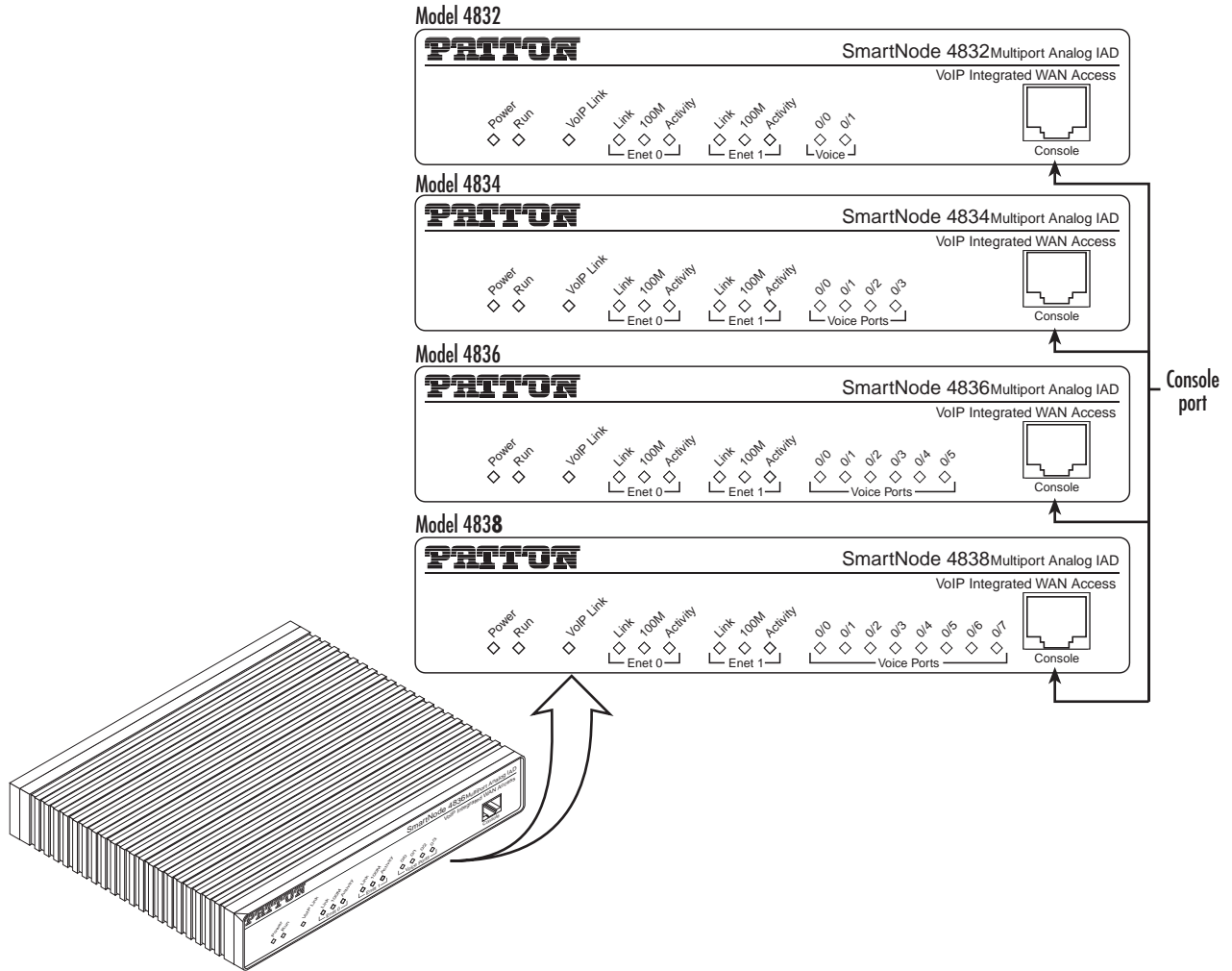

Figure 7. SmartNode 4830 Series front panels (FXS only)

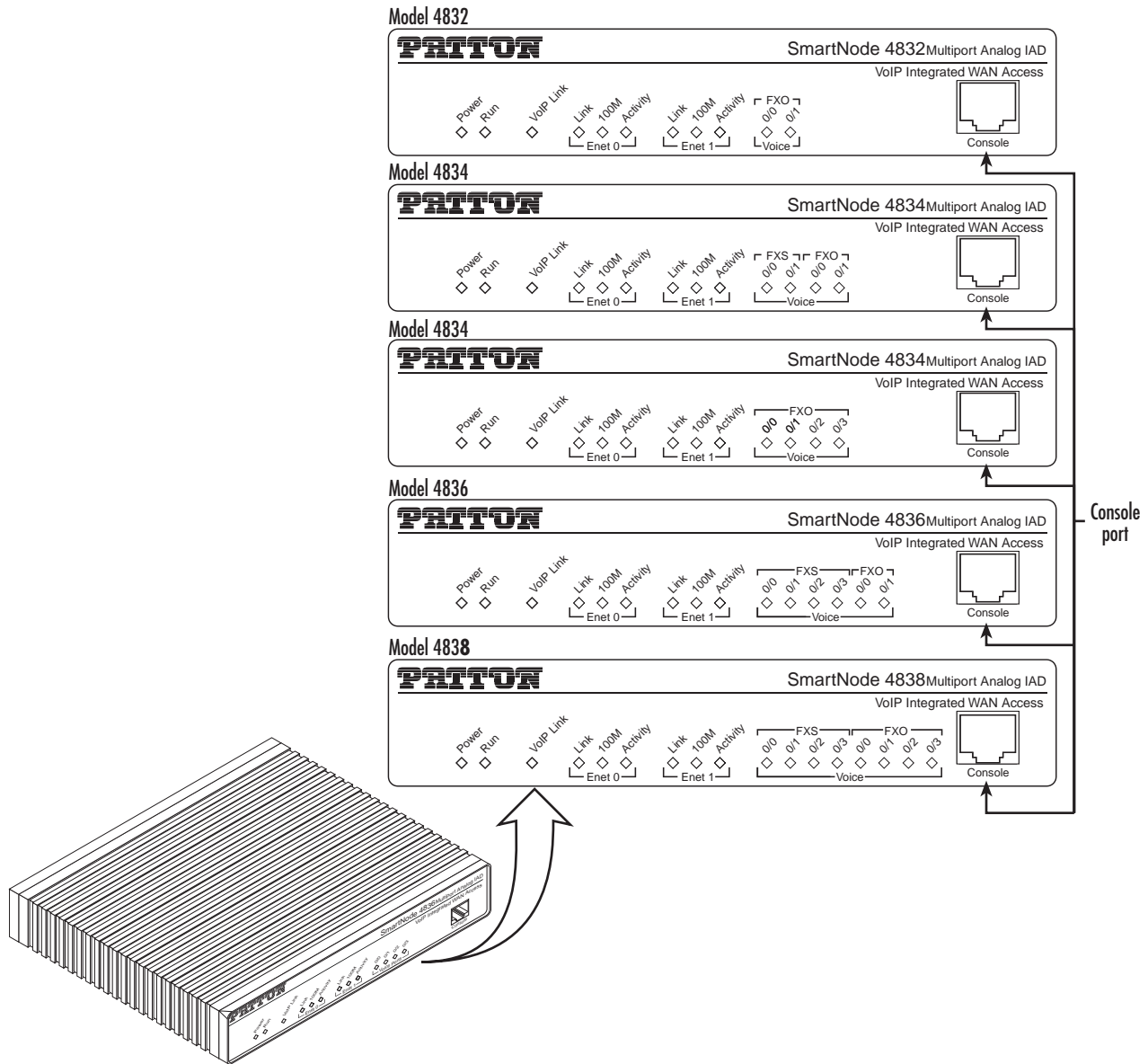

Figure 8. SmartNode 4830 Series front panels (FXO only and combined FXS/FXO)

**Note** For LED descriptions, refer to chapter 5, “LEDs status and monitoring” on page 52.

**Note** Some models within the 4830 Series differ from the above representation as they come in a different shaped enclosure.



## Chapter 2 **Applications overview**

### **Chapter contents**

Introduction .....	26
Applications for SmartNode 4830 Series .....	26
Multiservice carrier access over leased lines .....	26
Converged enterprise network over leased line .....	27

## Introduction

Patton's SmartNode VoIP IADs deliver the features you need for advanced multiservice voice and data networking. SmartNode IADs combine high-quality voice-over-IP with powerful *quality of service* routing features to deliver seamlessly-integrated VoIP and data access over synchronous serial leased lines. This chapter describes typical applications for which the SmartNode 4830 Series series is uniquely suited.

**Note** Detailed configuration information for the applications can be found on the CD-ROM that was included with your SmartNode device or online from the Patton webserver.

## Applications for SmartNode 4830 Series

SmartNode 4830 Series devices have dual 10/100Base-T Ethernet ports and a single V.35 or X.21 sync-serial port. The two Ethernet ports provide full featured IP routing plus Ethernet and IP layer QoS services. The sync-serial port provides WAN access for integrated voice and data via a leased-line connection to the network. Voice prioritization and traffic management avoid network congestion and provide optimal voice quality. The following sections show two typical converged voice-and-data applications.

### Multiservice carrier access over leased lines

The SN4830 Series enables service providers to use Frame-Relay or PPP sync-serial access lines to offer Internet and VPN services integrated with voice services for up to 8 analog telephone lines (see figure 9). The dual 10/100Base-TX LAN ports can be used for LAN connectivity and a dedicated VPN and DMZ connection.

The FXS ports connect to PBXs, key-systems or handsets while the FXO ports can be used for local breakout or fallback to the PSTN.

Like all members of the SmartNode family of VoIP solutions, the 4830 series supports all the industry-standard VoIP signaling protocols, including SIP, H.323, T.38 fax-relay, plus fax- and modem-bypass. The SmartNode 4830 is interoperable with leading softswitches and VoIP servers.

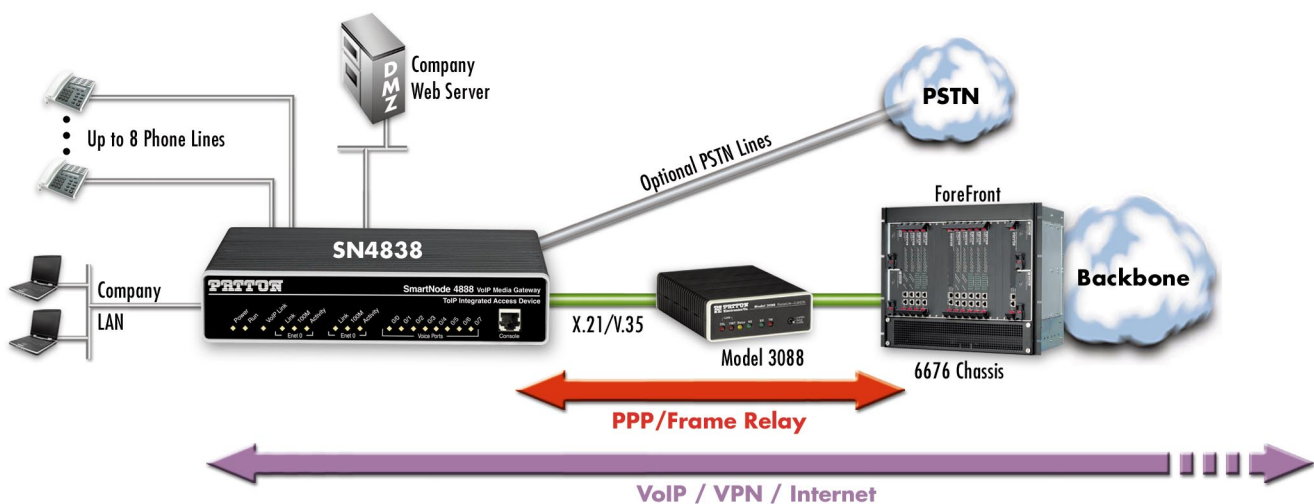

Figure 9. Multiservice carrier access over leased lines

### Converged enterprise network over leased line

The SN4830 Series enables Enterprise Network Administrators to connect branch offices over point-to-point leased lines or a Frame-Relay backbone. In this application the SmartNode provides inter-office data connectivity plus private PBX networking for up to four telephone-line extensions (see [figure 10](#)). The advanced Quality of Service (QoS) features ensure optimal bandwidth usage and voice quality even over low bandwidth links starting at 64kbps.

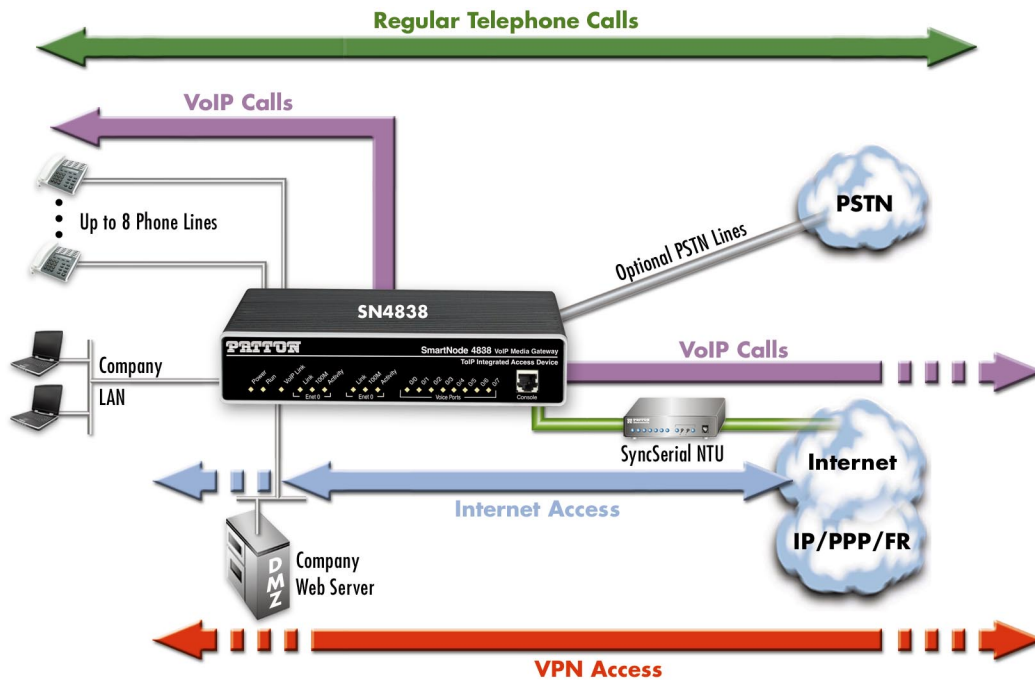

Figure 10. Converged enterprise network over leased line

## Chapter 3 **Hardware installation**

### **Chapter contents**

Planning the installation .....	29
Installation checklist .....	30
Site log .....	31
Network information .....	31
Network Diagram .....	31
IP related information .....	31
Software tools .....	32
Power source .....	32
Location and mounting requirements .....	32
Installing the VoIP IAD .....	32
Mounting the VoIP IAD .....	32
Connecting cables .....	32
Installing an interface cable on the VoIP IAD's FXS and FXO interface ports .....	33
Installing the Ethernet cable .....	35
Installing the serial WAN cable .....	36
Installing the DSL interface cable .....	37
Installing the V.35 interface cable.....	37
Installing the X.21 interface cable.....	38
Installing the T1/E1 twisted pair cables.....	39
Installing the E1 dual coaxial cables.....	40
Connecting to external power source .....	41

## Planning the installation

Before you start the actual installation, we strongly recommend that you gather all the information you will need to install and setup the device. See [table 3](#) for an example of what pre-installment checks you might need to carry out. Completing the pre-installation checks enables you to install and set up your VoIP IAD within an existing network infrastructure with confidence.



**Mains Voltage:** Do not open the case when the power cord is connected. For systems without a power switch, line voltages are present within the power supply when the power cord is connected. The mains outlet that is utilized to power the SmartNode router shall be within 10 feet (3 meters) of the device, shall be easily accessible, and protected by a circuit breaker.

**Note** When setting up your VoIP IAD you must consider cable-length limitations, and potential electromagnetic interference (EMI) as defined by the applicable local and international regulations. Ensure that your site is properly prepared before beginning installation.

Before installing the VoIP IAD device, the following tasks should be completed:

- **Create a network diagram** (see section “[Network information](#)” on page 31)
- **Gather IP related information** (see section “[IP related information](#)” on page 31 for more information)
- **Install the hardware and software needed to configure the SmartNode.** (See section “[Software tools](#)” on page 32)
- **Verify power source reliability** (see section “[Power source](#)” on page 32).

When you finish preparing for your VoIP IAD installation, go to section “[Installing the VoIP IAD](#)” on page 32 to install the device.

### Installation checklist

The installation checklist (see [table 3](#)) lists the tasks for installing a SmartNode 4830 Series VoIP IAD. Make a copy of this checklist and mark the entries as you complete each task. For each SmartNode 4830 Series VoIP IAD, include a copy of the completed checklist in your site log.

Table 3. Installation checklist

Task	Verified by	Date
Network information available & recorded in site log		
Environmental specifications verified		
Site power voltages verified		
Installation site pre-power check completed		
Required tools available		
Additional equipment available		
All printed documents available		
SmartWare release & build number verified		
Rack, desktop, or wall mounting of chassis completed		
Initial electrical connections established		
ASCII terminal attached to console port		
Cable length limits verified		
Initial configuration performed		
Initial operation verified		

### Site log

Patton recommends that you maintain a site log to record all actions relevant to the system, if you do not already keep such a log. Site log entries should include information such as listed in [table 4](#).

Table 4. Sample site log entries

Entry	Description
Installation	Make a copy of the installation checklist and insert it into the site log
Upgrades and maintenance	Use the site log to record ongoing maintenance and expansion history
Configuration changes	Record all changes and the reasons for them
Maintenance	Schedules, requirements, and procedures performed
Comments	Notes, and problems
Software	Changes and updates to SmartWare software

### Network information

When planning your installation there are certain network-connection considerations that you should take into account. The following sections describe such considerations for several types of network interfaces.

#### Network Diagram

Draw a network overview diagram that displays all neighboring IP nodes, connected elements and telephony components.

### IP related information

Before you can set up the basic IP connectivity for your SmartNode 4830 series you should have the following information:

- IP addresses used for Ethernet LAN and WAN ports
- Subnet mask used for Ethernet LAN and WAN ports
- Sync serial line speed
- Frame Relay PVC DLCI or PPP parameters
- IP addresses used for the V.35 or X.21 serial WAN port
- Subnet mask used for the V.35 or X.21 serial WAN port
- IP addresses and subnet masks used for the T1/E1 WAN port
- IP addresses of central H.323 Gatekeeper (if used)
- IP addresses of central PSTN Gateway for H.323 and/or ISoIP based calls
- IP addresses of central TFTP Server used for configuration upload and download

### Software tools

You will need a PC (or equivalent) with a VT-100 emulation program (e.g. HyperTerminal) to configure the software on your SmartNode VoIP IAD.

### Power source

If you suspect that your AC power is not reliable, for example if room lights flicker often or there is machinery with large motors nearby, have a qualified professional test the power. Install a power conditioner if necessary.

### Location and mounting requirements

The SmartNode VoIP IAD is intended to be placed on a desktop or similar sturdy, flat surface that offers easy access to the cables. Allow sufficient space at the rear of the chassis for cable connections. Additionally, you should consider the need to access the unit for future upgrades and maintenance.

## Installing the VoIP IAD

SmartNode VoIP IAD installation consists of the following:

- Placing the device at the desired installation location (see section “Mounting the VoIP IAD” on page 32)
- Installing the interface and power cables (see section “Connecting cables” on page 32)

When you finish installing the SmartNode, go to chapter 4, “Getting started with the SmartNode” on page 43.

### Mounting the VoIP IAD

Place the VoIP IAD on a desktop or similar sturdy, flat surface that offers easy access to the cables. The VoIP IAD should be installed in a dry environment with sufficient space to allow air circulation for cooling.

**Note** For proper ventilation, leave at least 2 inches (5 cm) to the left, right, front, and rear of the SmartNode VoIP IAD.

### Connecting cables



**Do not work on the system or connect or disconnect cables during periods of lightning activity.**



The interconnecting cables shall be acceptable for external use and shall be rated for the proper application with respect to voltage, current, anticipated temperature, flammability, and mechanical serviceability.

Installing VoIP IAD cables takes place in the following order:

1. Installing the RJ-11 voice port (FXS) cable or cables (see section “Installing an interface cable on the VoIP IAD’s FXS and FXO interface ports” on page 33)
2. Installing the 10/100 Ethernet port cable or cables (see section “Installing the Ethernet cable” on page 35)



3. Installing the DSL, V.35, X.21, or T1/E1 serial WAN cable (see section “Installing the serial WAN cable” on page 36)
4. Installing the power input (see section “Connecting to external power source” on page 41)

#### Installing an interface cable on the VoIP IAD's FXS and FXO interface ports

The gateway comes with at least two FXS or FXO analog ports—or a combination of FXS and FXO ports—located on the back of the VoIP IAD (see figure 11). The FXS interfaces are connected to analog devices via cables (see figure 12) terminated with RJ-11 connectors (see figure 13 and table 5 on page 34 for pin-out information). The FXO interface connects the VoIP IAD with analog lines via cables (see figure 14 on page 35) terminated with RJ-11 connectors (see figure 13 and table 5 on page 34 for pin-out information).

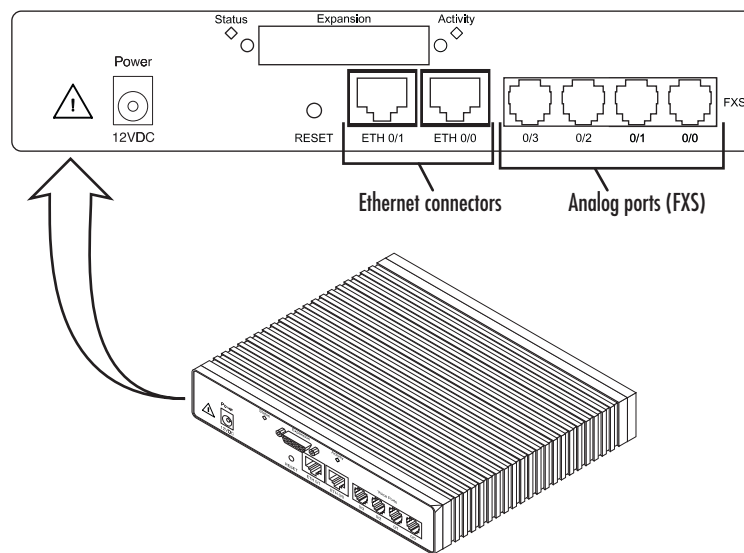

Figure 11. Rear view showing location of Ethernet and FXS connectors (SmartNode 4834 shown)

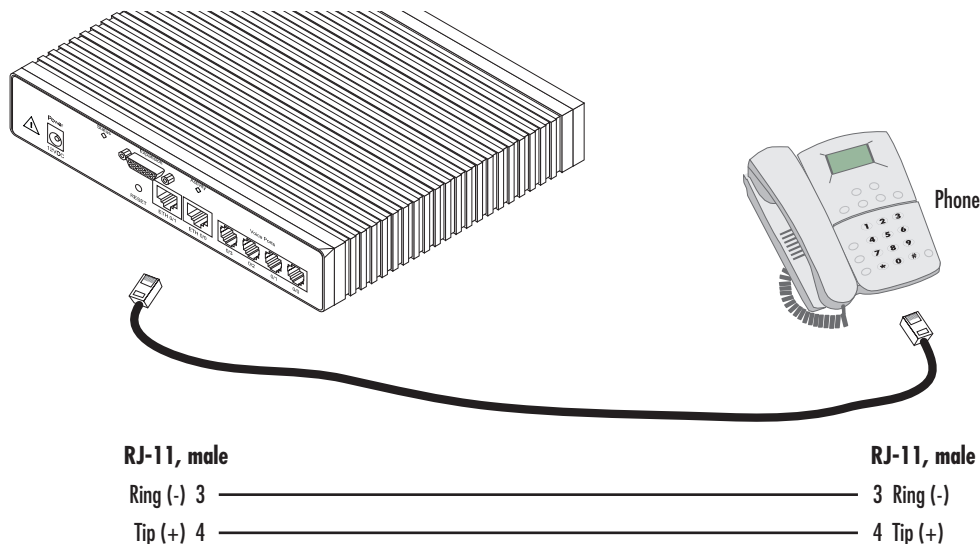

Figure 12. Analog FXS connection

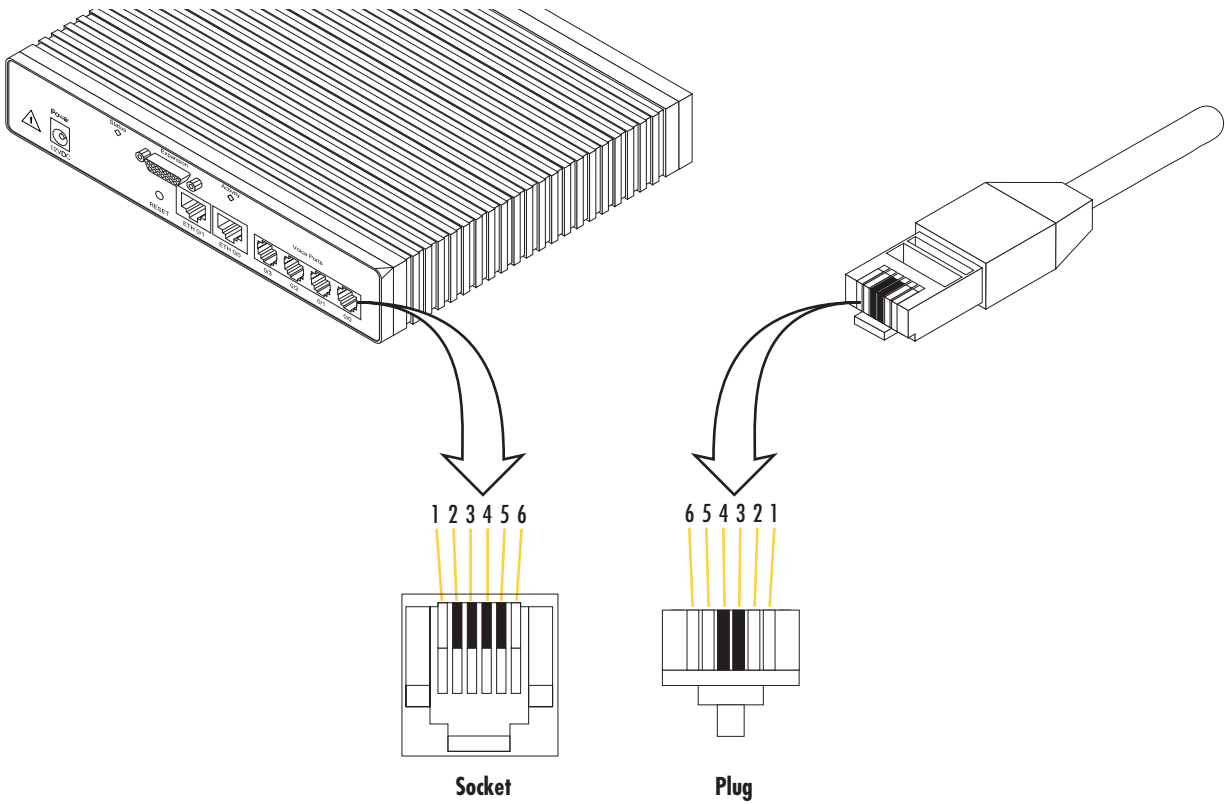

Figure 13. RJ-11 pinout diagram

Table 5. RJ-11 socket

Pin	Signal
3	Ring (-)
4	Tip (+)

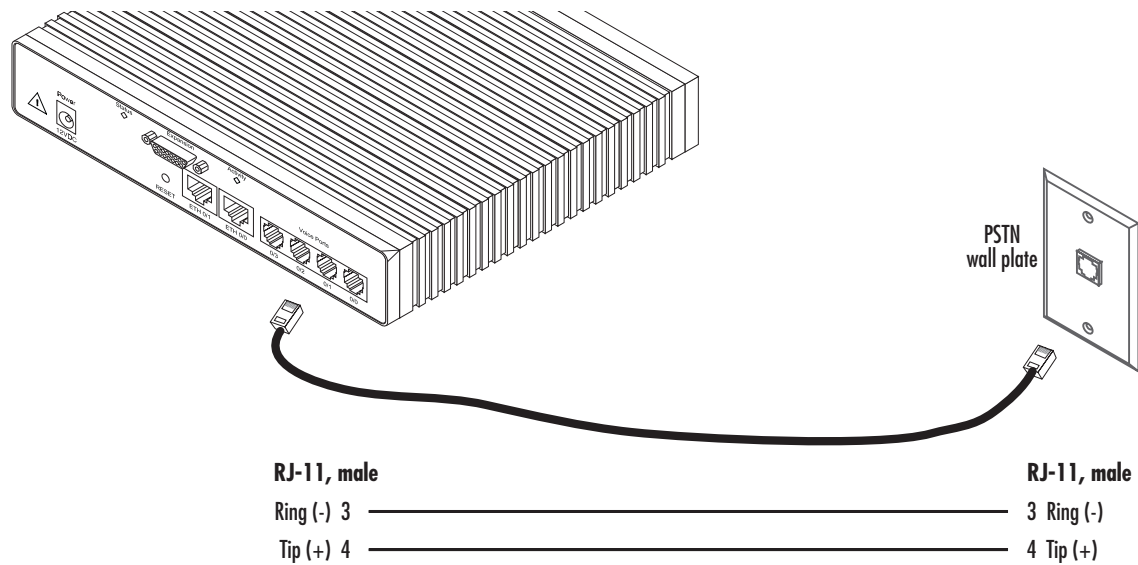

Figure 14. Analog FXO connection

### Installing the Ethernet cable

The SmartNode 4830 Series has automatic MDX (auto-cross-over) detection and configuration on the Ethernet ports. Any of the two ports can be connected to a host or hub/switch with a straight-through wired cable (see [figure 15](#)). Ethernet devices (10Base-T or 100Base-T) are connected to the SmartNode's Ethernet ports (see [table 6](#) for port pin-out listing) via a cable terminated with RJ-45 plugs.

Table 6. Ethernet 10/100Base-T (RJ-45) port pin-outs

Pin	Signal
1	TX+
2	TX-
3	RX+
6	RX-

**Note** Pins not listed are not used.

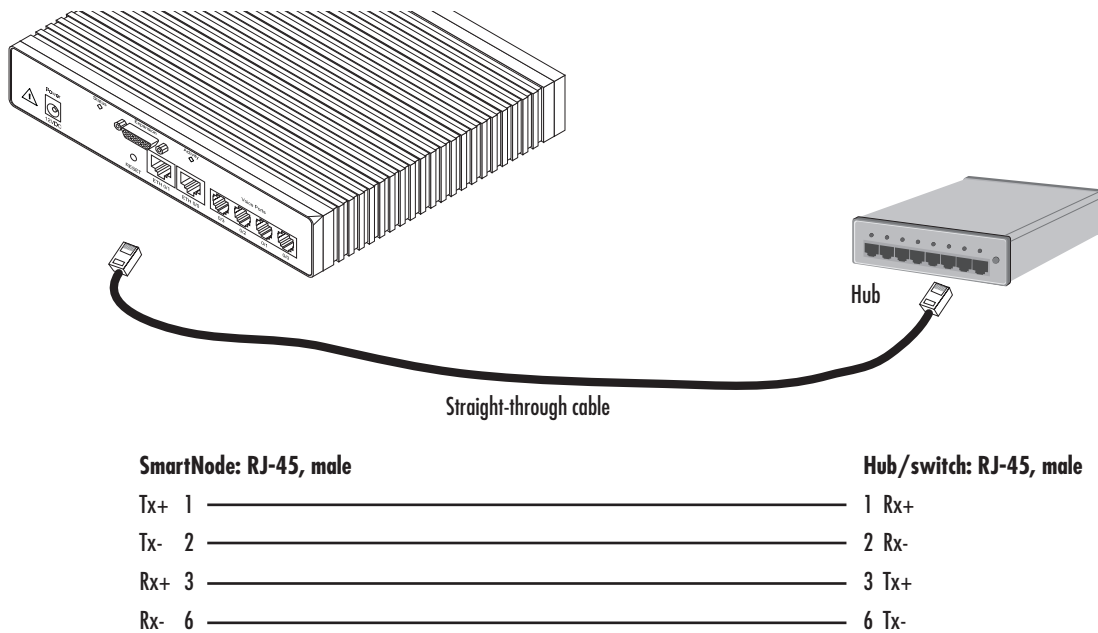

Figure 15. Connecting a SmartNode 4830 Series device to a hub

### Installing the serial WAN cable

The SmartNode 4830 Series is available with the following serial interfaces):

- DSL (RJ11)—See section “[Installing the DSL interface cable](#)” on page 37 for details on installing the interface cable
- V.35 (DB-25)—See section “[Installing the V.35 interface cable](#)” on page 37 for details on installing the interface cable
- X.21 (DB-15)—See section “[Installing the X.21 interface cable](#)” on page 38 for details on installing the interface cable
- T1/E1 (RJ48C connectors)—See section “[Installing the T1/E1 twisted pair cables](#)” on page 39 for details on installing the twisted pair cable
- E1 (Dual coaxial connectors)—See section “[Installing the E1 dual coaxial cables](#)” on page 40 for details on installing the coaxial cables

**Installing the DSL interface cable.** The SmartNode Model 4830 comes with an option for a G.SHDSL or ADSL interface. Use a straight-through RJ-11 cable to connect the DSL port.

**Installing the V.35 interface cable.** The SmartNode Model 4830 comes with a V.35 interface presented on a DB-25 female connector (see [figure 16](#)).

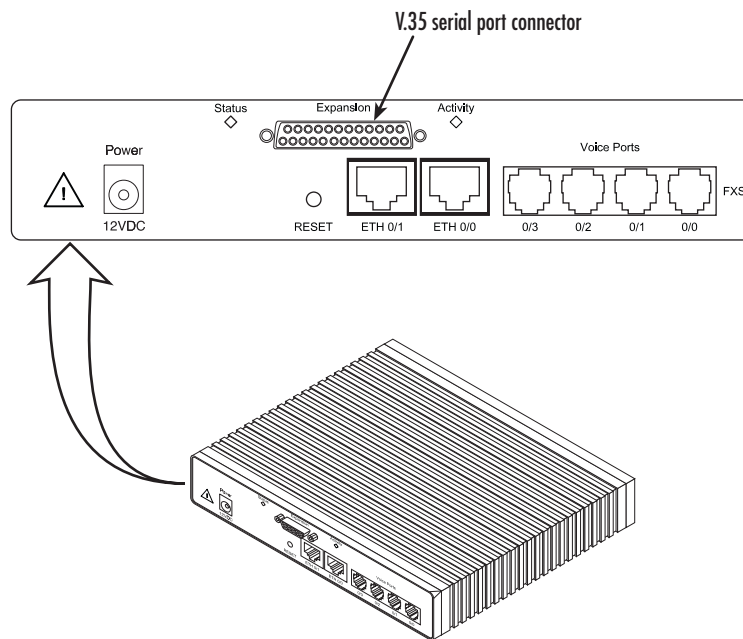

Figure 16. Rear view of the SN4830 showing location of V.35 interface connector

The signal pin-outs for the Model 4830 V.35 interface are shown in [table 7](#).

Table 7. Signal pin-outs for the V.35 interface on the SmartNode 4830

Pin	Signal	Pin	Signal
1	Frame Ground	12	TXCb
2	TXDa	14	TXDb
3	RXDa	15	RXCa
4	RTS	16	RXDb
5	CTS	17	RXCa
6	DSR	18	LL
7	Signal Ground	20	DTR
8	DCD	21	RL
9	RXCb	24	EXTCa
11	EXTCb		

The SN4830's V.35 interface is wired as a DTE. No DCE configuration is possible. If you are directly connecting the SN4830's V.35 interface to third-party equipment that cannot be configured as a DCE, you must use a

tail-circuit cable. You can purchase a tail-circuit cable from a datacom-supply vendor. A tail-circuit cable will cross-over the necessary V.35 signals so that the two DTE interfaces can communicate.

**Note** Some third-party equipment will not be able to work properly in DTE-to-DTE configurations even when using a tail-circuit cable. Please refer to your third party equipment user manual for information on DTE-to DTE operation.

The SN4830's V.35 interface requires a cable with a male DB-25 connector. Attach the male DB-25/M35 connector of the V.35 cable to the female DB-25 connector on the SN4830. Attach the other end of the cable to the V.35 connector on local V.35 modem or multiplexer device.

**Installing the X.21 interface cable.** The SmartNode Model 4830 comes with an X.21 interface presented on a DB-15 female connector (see [figure 17](#)).

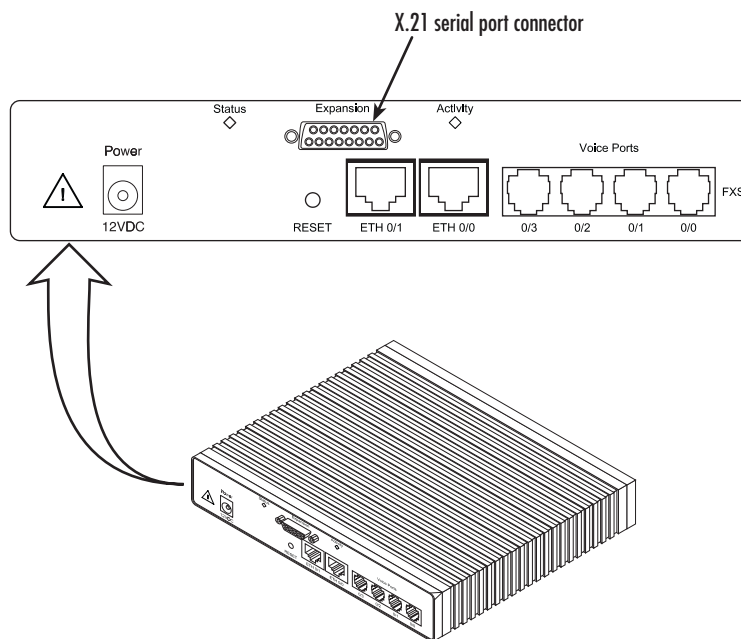

Figure 17. Rear view of the SN4830 showing location of X.21 interface connector

The signal pin-outs for the Model 4830 X.21 interface are shown in [table 7](#).

Table 8. Signal pin-outs for the X.21 interface on the SmartNode 4830

Pin	Signal	Pin	Signal
1	Frame Ground	8	Signal Ground
2	TXDa	9	TXDb
3	CNTa	10	CNTb
4	RXDa	11	RXDb
5	INDa	12	INDb
6	SETa	13	SETb

The SN4830's X.21 interface is wired as a DTE, however, it can also be configured as a DCE. The SN4830's X.21 interface requires a cable with a male DB-15 connector. Attach the male DB-15 connector of the X.21 cable to the female DB-15 connector on the SN4830. Attach the other end of the cable to the X.21 connector on local modem or multiplexer device.

**Installing the T1/E1 twisted pair cables.** The T1/E1 is usually connected to a PBX or switch (local exchange (LE)). Type and pin-outs of these devices vary depending on the manufacturer. In most cases, a straight-through RJ-48C to RJ-48C can be used to connect to the T1/E1 (see for E1 RJ-48C pin-out listing) with a PBX. A cross-over cable is required to connect to an NT1.

Table 9. RJ-48C receptacle

Pin	Signal
1	TX tip
2	TX ring
3	TX shield
4	RX tip
5	RX ring
6	RX shield

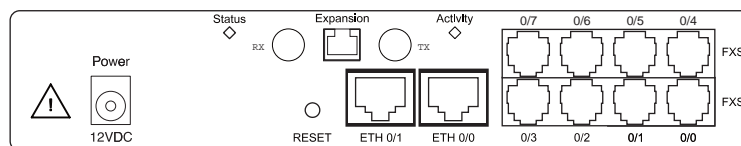

Figure 18. Rear panel of SN4830 T1/E1 -/K Model

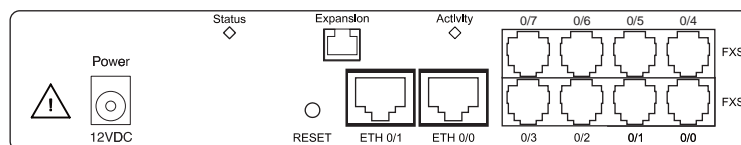

Figure 19. Rear panel of SN4830 T1/E1 -/T Model

**Note** Pins not listed are not used.



**Hazardous network voltages are present in the T1/E1 cables. If you detach the cable, detach the end away from the IPLink first to avoid possible electric shock. Network hazardous voltages may be present on the device in the area of the T1/E1 port, regardless of power being on or off.**



To prevent damage to the system, make certain you connect the T1/E1 cable to the T1/E1 port only and not to any other RJ type receptacle.

**Installing the E1 dual coaxial cables.** If the PBX or switch connection provides dual coaxial cables for the E1 connection, the transmit cable from the PBX/switch connects to the RX coaxial connector. Similarly, the receive cable from the PBX/switch connects to the TX coaxial connector.

Figure 20. Rear panel of SN4830 T1/E1 -/K Model

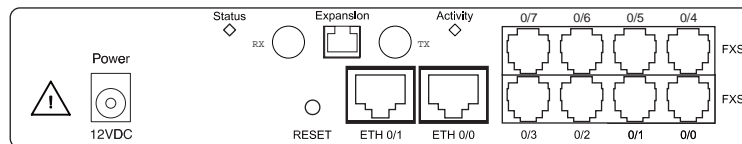

**Hazardous network voltages are present in the T1/E1 cables. If you detach the cable, detach the end away from the IPLink first to avoid possible electric shock. Network hazardous voltages may be present on the device in the area of the T1/E1 port, regardless of power being on or off.**



To prevent damage to the system, make certain you connect the T1/E1 cable to the T1/E1 port only and not to any other RJ type receptacle.



### Connecting to external power source

The VoIP IAD comes with an internal or external power supply. This section describes installing the power cord into the VoIP IAD. Do the following:

**Note** *Do not connect the power cord to the power outlet at this time.*

1. If your unit is equipped with an internal power supply, go to step 2. Otherwise, insert the barrel type connector end of the AC power cord into the external power supply connector (see figure 21).
2. Insert the female end of the power cord into the internal power supply connector (see figure 21).

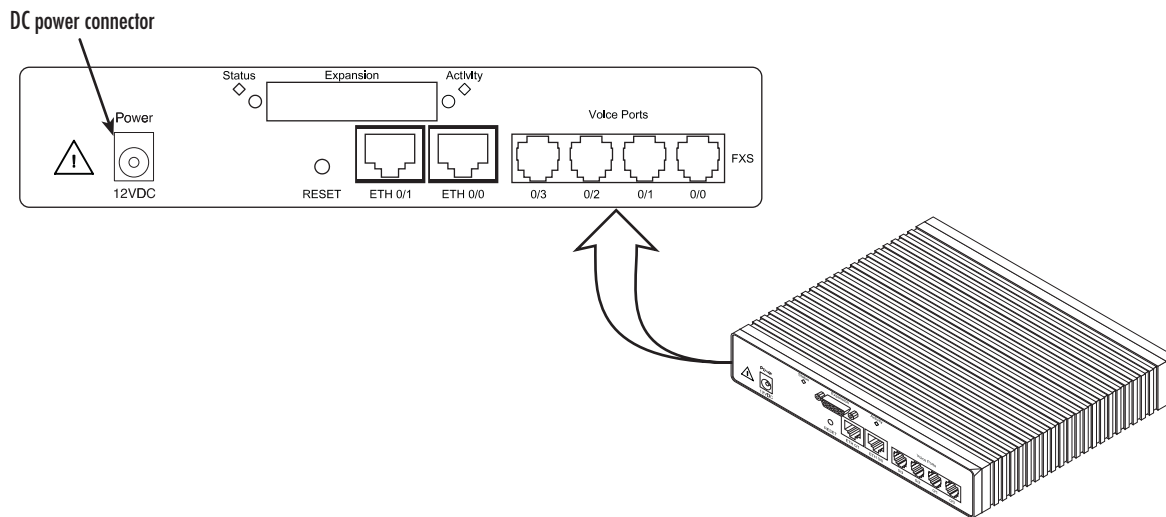

Figure 21. Power connector location on rear panel



The VoIP IAD power supply automatically adjusts to accept an input voltage from 100 to 240 VAC (50/60 Hz).

Verify that the proper voltage is present before plugging the power cord into the receptacle. Failure to do so could result in equipment damage.

3. Verify that the AC power cord included with your VoIP IAD is compatible with local standards. If it is not, refer to chapter 6, “[Contacting Patton for assistance](#)” on page 56 to find out how to replace it with a compatible power cord.
4. Connect the male end of the power cord to an appropriate power outlet.

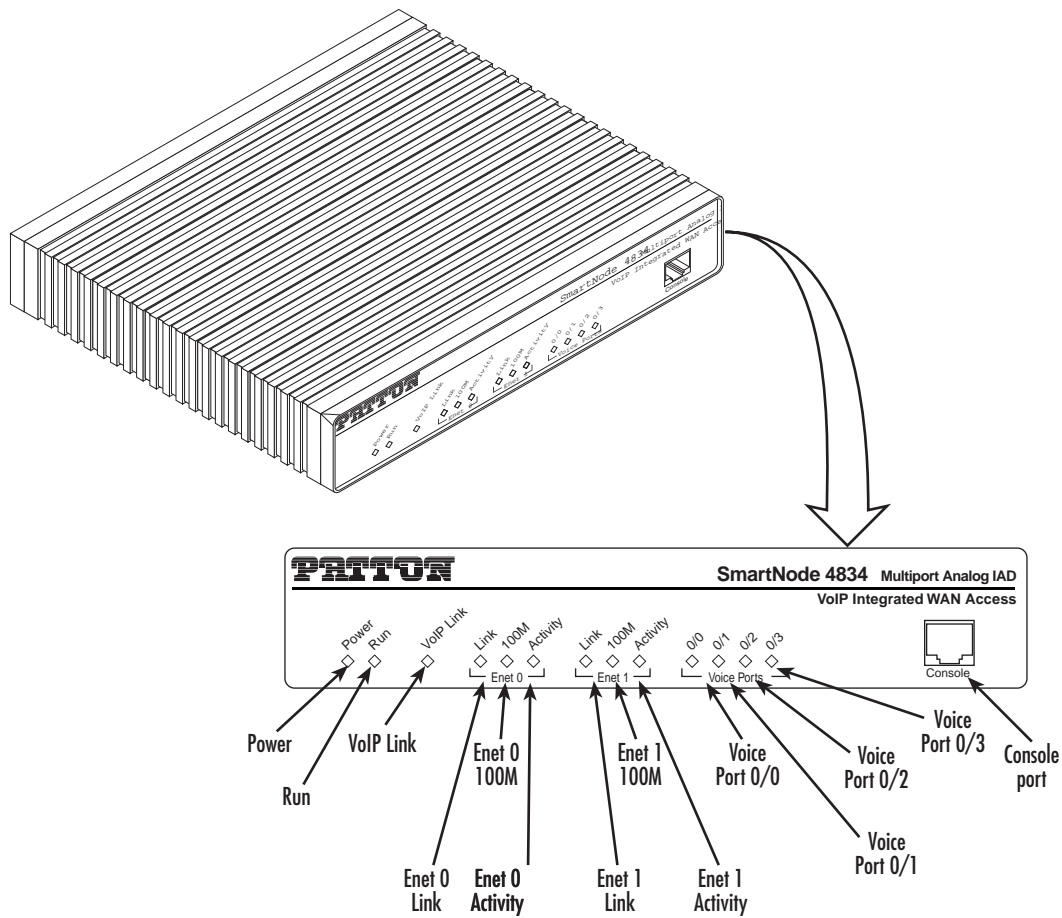

Figure 22. VoIP IAD front panel LEDs and Console port locations (SmartNode 4834 shown)

5. Verify that the green *Power* LED is lit (see [figure 22](#)).

Congratulations, you have finished installing the SmartNode VoIP IAD! Now go to chapter 4, “Getting started with the SmartNode” on page 43.

## Chapter 4 **Getting started with the SmartNode**

### **Chapter contents**

Introduction .....	44
1. Configure IP address .....	45
Power connection and default configuration .....	45
Connect with the serial interface .....	45
Login .....	46
Changing the IP address .....	46
2. Connect the SmartNode to the network .....	47
3. Load configuration .....	47
Bootloader .....	48
Start Bootloader .....	48
Start-up with factory configuration .....	49
Load a new application image (SmartWare) via TFTP .....	49
Load a new application image (SmartWare) via the serial link .....	51
Additional information .....	51

## Introduction

This chapter leads you through the basic steps to set up a new SmartNode and to download a configuration.

Patton SmartNodes can be used for a wide variety of IP-based network applications. To support and ease the configuration of the SmartNodes configuration, templates for the most important applications are available on the Patton server at [www.patton.com/voip](http://www.patton.com/voip).

The main steps for setting up a new SmartNode (as of release 2.00 or 2.10) are shown in [figure 23](#).

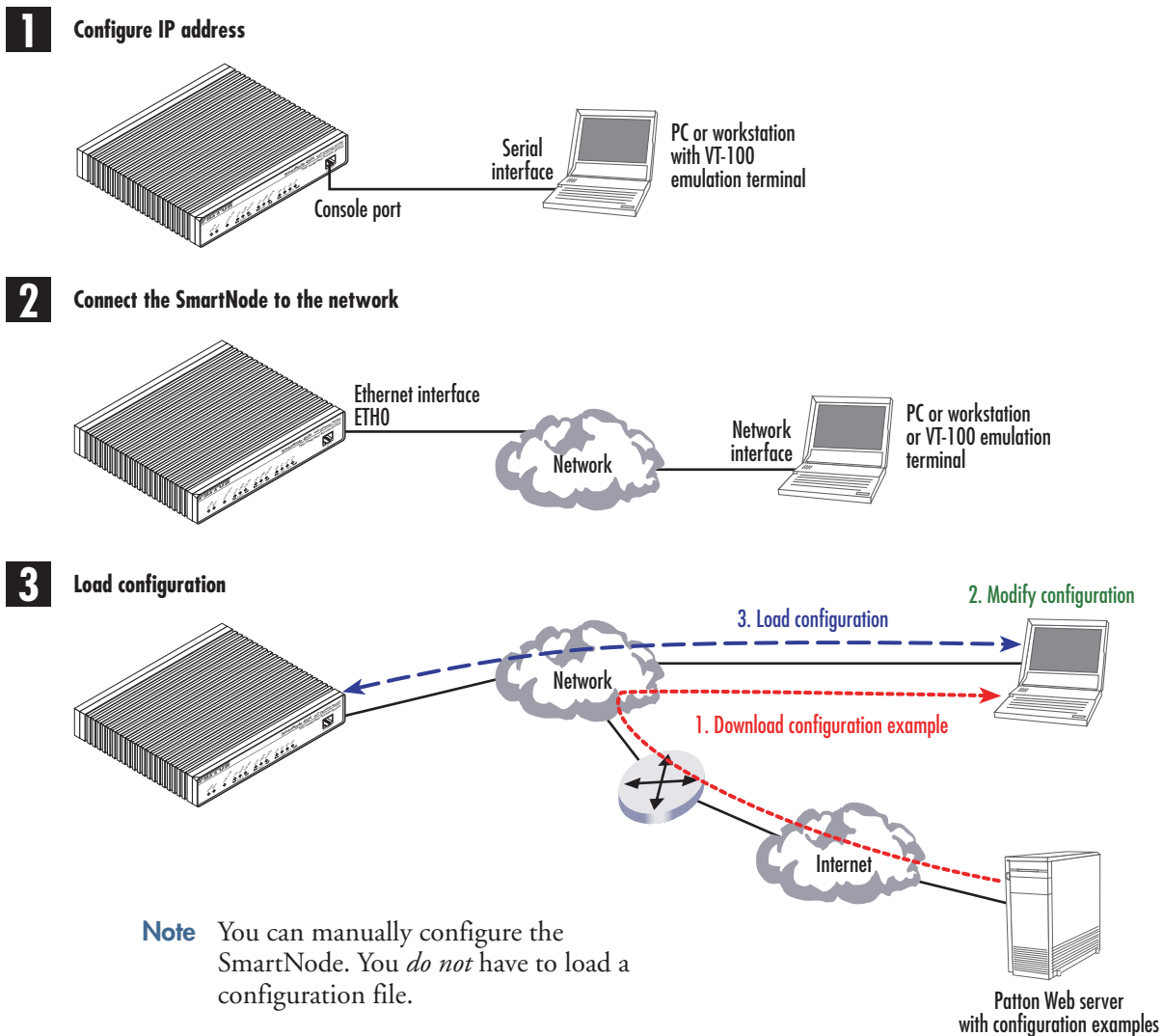

Figure 23. Steps for setting up a new SmartNode

## 1. Configure IP address

### Power connection and default configuration

The factory default configuration for the Ethernet IP addresses and network masks are listed in [table 10](#). Both Ethernet interfaces are activated upon power-up. LAN interface ETH 0/1 (LAN) provides a default DHCP server.

Table 10. Factory default IP address and network mask configuration

	IP Address	Network Mask
WAN interface Ethernet 0 (ETH 0/0)	DHCP	DHCP
LAN interface Ethernet 1 (ETH 0/1)	192.168.1.1	255.255.255.0
DHCP address range	192.168.1.10–192.168.1.19	255.255.255.0

Both Ethernet interfaces are activated upon power-up.

If these addresses match with those of your network, go to section “[2. Connect the SmartNode to the network](#)” on page 47. Otherwise, refer to the following sections to change the addresses and network masks.

### Connect with the serial interface

The *Console* port is wired as an EIA-561, RS-232 port. Use the included Model 16F-561 adapter and cable (see [figure 24](#)) between the SmartNode’s *Console* port and a PC or workstation’s RS-232 serial interface. Activate the terminal emulation program on the PC or workstation that supports the serial interface (e.g. HyperTerm).

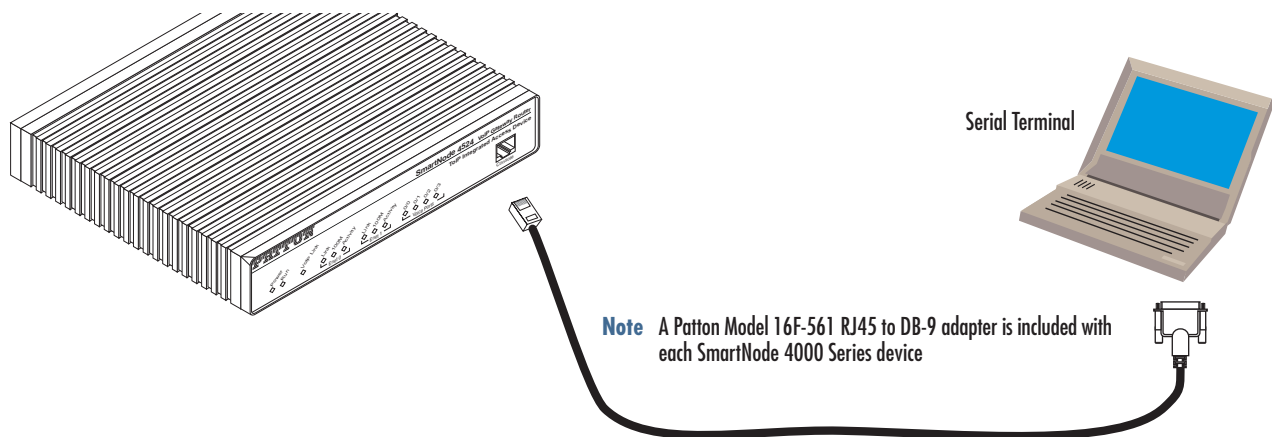

Figure 24. Connecting to the terminal

Terminal emulation program settings:

- 9600 baud
- no parity
- 8 bit
- 1 stop bit
- No flow control

## Login

Accessing your SmartNode via the local console port (or via a Telnet session) causes the login screen to display. Type the factory default login: *administrator* and leave the password empty. Press the *Enter* key after the password prompt.

```
login:administrator
password: <Enter>
172.16.40.1>
```

After you have successfully logged in you are in the operator execution mode, indicated by *>* as command line prompt. With the commands *enable* and *configure* you enter the configuration mode.

```
172.16.40.1>enable
172.16.40.1#configure
172.16.40.1(cfg)#
```

## Changing the IP address

Select the context IP mode to configure an IP interface.

```
172.16.40.1(cfg)#context ip product
172.16.40.1(ctx-ip)[product]#
```

Now you can set your IP address and network mask for the interface *eth0*. Within this example a class C network (172.16.1.0/24) is assumed. The IP address in this example is set to *172.16.1.99* (you should set this to an unused IP address on your network).

```
172.16.40.1(ctx-ip)[product]#interface eth0
172.16.40.1(if-ip)[eth0]#ipaddress 172.16.1.99 255.255.255.0
2002-10-29T00:09:40 : LOGINFO    : Link down on interface eth0.
2002-10-29T00:09:40 : LOGINFO    : Link up on interface eth0.
172.16.1.99(if-ip)[eth0]#
```

Copy this modified configuration to your new start-up configuration. Upon the next start-up the system will initialize itself using the modified configuration.

```
172.16.1.99(if-ip)[eth0]#copy running-config startup-config
172.16.1.99(if-ip)[eth0]#
```

The SmartNode can now be connected with your network.

## 2. Connect the SmartNode to the network

The 4830 Ethernet ports are auto MDX, therefore a straight-through wired cable can be used for host and switch connections (see [figure 25](#)).

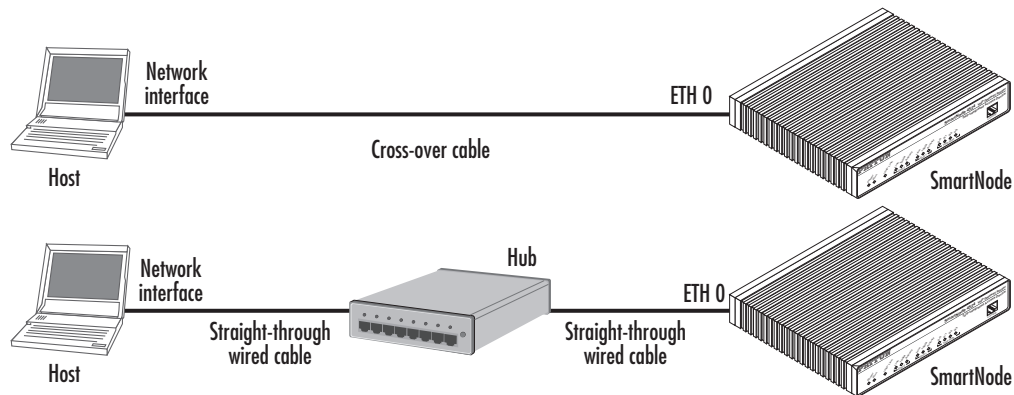

Figure 25. Connecting the SmartNode to the network

You can check the connection with the ping command to another host on the local LAN.

```
172.16.1.99(if-ip)[eth0]#ping <IP Address of the host>
```

Respectively from the host: *ping 172.16.1.99*

**Note** To ping outside your local LAN, you will need to configure the default gateway.

## 3. Load configuration

Patton provides a collection of configuration templates on the CD-ROM that came with the SmartNode device—and also on the support page at [www.patton.com/voip](http://www.patton.com/voip)—one of which may be similar enough to your application that you can use it to speed up configuring the SmartNode. Simply download the configuration note that matches your application to your PC. Adapt the configuration as described in the configuration note to your network (remember to modify the IP address) and copy the modified configuration to a TFTP server. The SmartNode can now load its configuration from this server.

**Note** Patton regularly adds new configuration templates to the collection at [www.patton.com/voip](http://www.patton.com/voip), so if you do not see your application on the CD-ROM, it may have been added to the website.

**Note** If your application is unique and not covered by any of Patton's configuration templates, you can manually configure the SmartNode instead of loading a configuration file template. In that case, refer to the *SmartNode Series SmartWare Software Configuration Guide* for information on configuring the SmartNode device.

In this example we assume the TFTP server on the host with the IP address 172.16.1.11 and the configuration named *SN.cfg* in the root directory of the TFTP server.

```
172.16.1.99(if-ip)[eth0]#copy tftp://172.16.1.11/SN.cfg startup-config
Download...100%
172.16.1.99(if-ip)[eth0]#
```

After the SmartNode has been rebooted the new startup configuration will be activated.



When you issue the **reload** command, the SmartNode will ask if you want to copy the running configuration to the startup configuration. Since you just downloaded a configuration file to the startup configuration you must answer this question with **NO**. Otherwise, the downloaded configuration will be overwritten and lost!

```
172.16.1.99(if-ip)[eth0]#reload
Running configuration has been changed.
Do you want to copy the 'running-config' to the 'startup-config'?
Press 'yes' to store, 'no' to drop changes : no
Press 'yes' to restart, 'no' to cancel : yes
The system is going down
```

## Bootloader

The bootloader ensures that basic operations, network access, and downloads are possible in case of interrupted or corrupted application image downloads. It offers console access to the Bootloader and the capability for downloading application images (e.g. SmartWare) via the serial link of the console.

### Start Bootloader

To start the Bootloader, power on the SmartNode while pressing the reset button. Open a Telnet session to the SmartNode via one of the Ethernet interfaces, or open a CLI session via the console port (if available on the SmartNode). The login display will appear. Using the credentials admin / patton , log in to the SmartNode. The following prompt will be displayed:

```
RedBoot>
```

Type **help** to display an overview of the available commands.



### Start-up with factory configuration

Step	Command	Purpose
<b>1</b>	<b>RedBoot&gt; fis load</b>	Copies the SmartWare application image from the persistent memory (flash:) to the volatile memory (RAM) from where it will be executed.
<b>2</b>	<b>RedBoot&gt; go -s factory-config</b>	Starts the SmartWare application telling it to use 'factory-config' as startup configuration. You can also start-up with any other configuration available in the persistent memory (nvram:) by providing its name instead of 'factory-config'.

### Load a new application image (SmartWare) via TFTP

The following procedure downloads the application image (SmartWare) for the mainboard. See the note below on how to download the respective CLI description file.

Step	Command	Purpose
<b>1</b> <b>optional</b>	<b>RedBoot&gt; ip_address -l</b> <i>local_ip_address</i> [/mask_len]	Sets the IP address and subnet mask of the Ethernet interface 0/0 which shall be used to receive the new application image. <i>mask_len</i> is the length of the network address (or the number of 1's within the subnet mask). See Note below.
<b>2</b> <b>optional</b>	<b>RedBoot&gt; ip_address -g</b> <i>gateway</i>	Sets the IP address of the default gateway.
<b>3</b> <b>optional</b>	<b>RedBoot&gt; ping -h</b> <i>tftp-server_ip_address</i>	Tests the connectivity to the TFTP server.
<b>4</b>	<b>RedBoot&gt; load -r -v -h</b> <i>host -b</i> <i>base_address file_name</i>	Downloads an application image into the volatile memory (RAM) from where the SmartNode could directly execute it. <i>host</i> : IP address of the TFTP server <i>base_address</i> : memory location where to store the application image. Use the default address 0x1800100 <i>file_name</i> : path and name of the file on the TFTP server. Note: use the image file that contains the whole application, not the image parts.
<b>5</b>	<b>RedBoot&gt; fis delete -n 1</b>	Deletes the first application image. Reply with 'y' to the confirmation request.
<b>6</b>	<b>RedBoot&gt; fis create</b>	Stores the downloaded application image to the permanent memory (flash:). Reply with 'y' to the confirmation request.
<b>7</b>	<b>RedBoot&gt; fis list -l</b>	Checks whether the image has been successfully stored, whether it is the desired Release and Build, and whether it is valid.

Step	Command	Purpose
8	RedBoot> go	Starts the application image that was downloaded into the volatile memory (RAM).

**Note** With the Bootloader, only the Ethernet interface 0/0 is available. The Bootloader applies the IP address, subnet mask, and default gateway that were last configured by the Bootloader itself or by another application (e.g. SmartWare). If an application configured the Ethernet interface 0/0 to use DHCP, the Bootloader will also use DHCP to learn the interface configuration. It can receive and apply the IP address, subnet mask, default gateway, and default (TFTP) server (transmitted as basic DHCP information 'Next server IP address').

**Note** This procedure does not download the respective CLI description file. Download it after starting up SmartWare with the following command:  
copy tftp://<tftp\_server\_address>/<server path>/b1 flash:

**Example:** Downloading and storing a new application image (SmartWare)

```
RedBoot> ip -l 172.16.40.98/19
RedBoot> ip -g 172.16.32.1
RedBoot> ping -h 172.16.32.100
Network PING - from 172.16.40.98 to 172.16.32.100
.....PING - received 10 of 10 expected

RedBoot> load -r -v -h 172.16.32.100 -b 0x1800100 /Sn4xxx/image.bin
Using default protocol (TFTP)
-
Raw file loaded 0x01800100-0x0199ca6b, 1689964 bytes, assumed entry at 0x01800100

RedBoot> fis delete -n 1
Delete image 1 - continue (y/n)? y
... Erase from 0x60030000-0x601cc974: .....
```

```
RedBoot> fis create
Use address 0x01800100, size 1684402 ? - continue (y/n)? y
... Erase from 0x60030000-0x601cb3ba: .....
```

```
... Program from 0x00011eec-0x00011ef4 at 0x60030000: .
... Program from 0x01800100-0x0199b4b2 at 0x60030008: .....
... Program from 0x00011eec-0x00011ef4 at 0x60030000: .
Image successfully written to flash
```

```
RedBoot> fis list -l
Id Address      Length  State      Description
  Entry        Load Addr      Version
-----
1  0x60030000  1693438  valid      SmartWare R2.10 BUILD28015
   0x01800100  0x01800100  V2.10
```

```
RedBoot> go
Starting 'SmartWare R2.10 BUILD28015' at 0x01800100 via 0x01800100
```

### Load a new application image (SmartWare) via the serial link

The Bootloader supports the 'X-Modem' and 'Y-Modem' protocols to download application images via the serial link of the console. Do the following to initiate the download:

Step	Command	Purpose
<b>1</b>	<b>RedBoot&gt; load -r -v -m { xmodem   ymodem } -b base_address</b>	Downloads an application image into the volatile memory (RAM) from where the SmartNode could directly execute it. 'xmodem' or 'ymodem': Specify the protocol to be used, X-Modem or Y-Modem <i>base_address</i> : memory location where to store the application image. Use the default address 0x1800100 Execute the above RedBoot command first, then start the transfer from the terminal program with the command 'Send file via X-Modem' (or similar).
<b>5</b>	RedBoot> fis delete -n 1	Deletes the first application image. Reply with 'y' to the confirmation request.
<b>6</b>	RedBoot> fis create	Stores the downloaded application image to the permanent memory (flash:). Reply with 'y' to the confirmation request.
<b>7</b>	RedBoot> fis list -l	Checks whether the image has been successfully stored, whether it is the desired Release and Build, and whether it is valid.
<b>8</b>	RedBoot> go	Starts the application image that was downloaded to the volatile memory (RAM).

**Note** This type of download takes about **25 minutes** since it uses a serial link at only 9600 bps.

### Additional information

For detailed information about configuring and operating guidance, set up procedures, and troubleshooting, refer to the *Software Configuration Guide* on the enclosed CD-ROM or the Patton website at [www.patton.com](http://www.patton.com). On the CD you will also find numerous freeware applications such as a TFTP server.

# Chapter 5 **LEDs status and monitoring**

## **Chapter contents**

Status LEDs.....53

## Status LEDs

This chapter describes SmartNode gateway product front panel LEDs. [Figure 26](#) and [figure 27](#) on page 54 show SmartNode 4830 Series LEDs. LED definitions are listed in [table 11](#) on page 55.

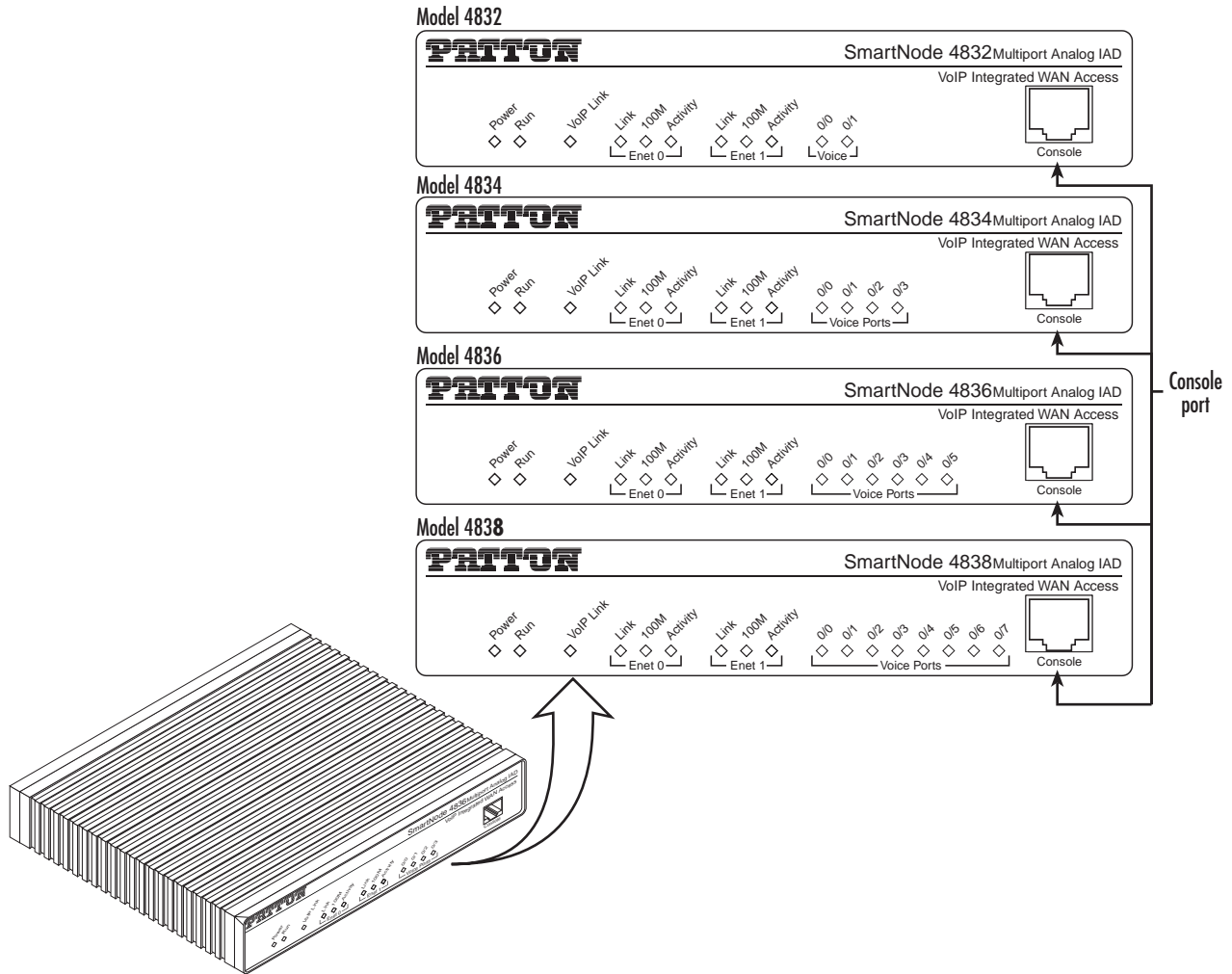

Figure 26. SmartNode 4830 Series front panels (FXS only)

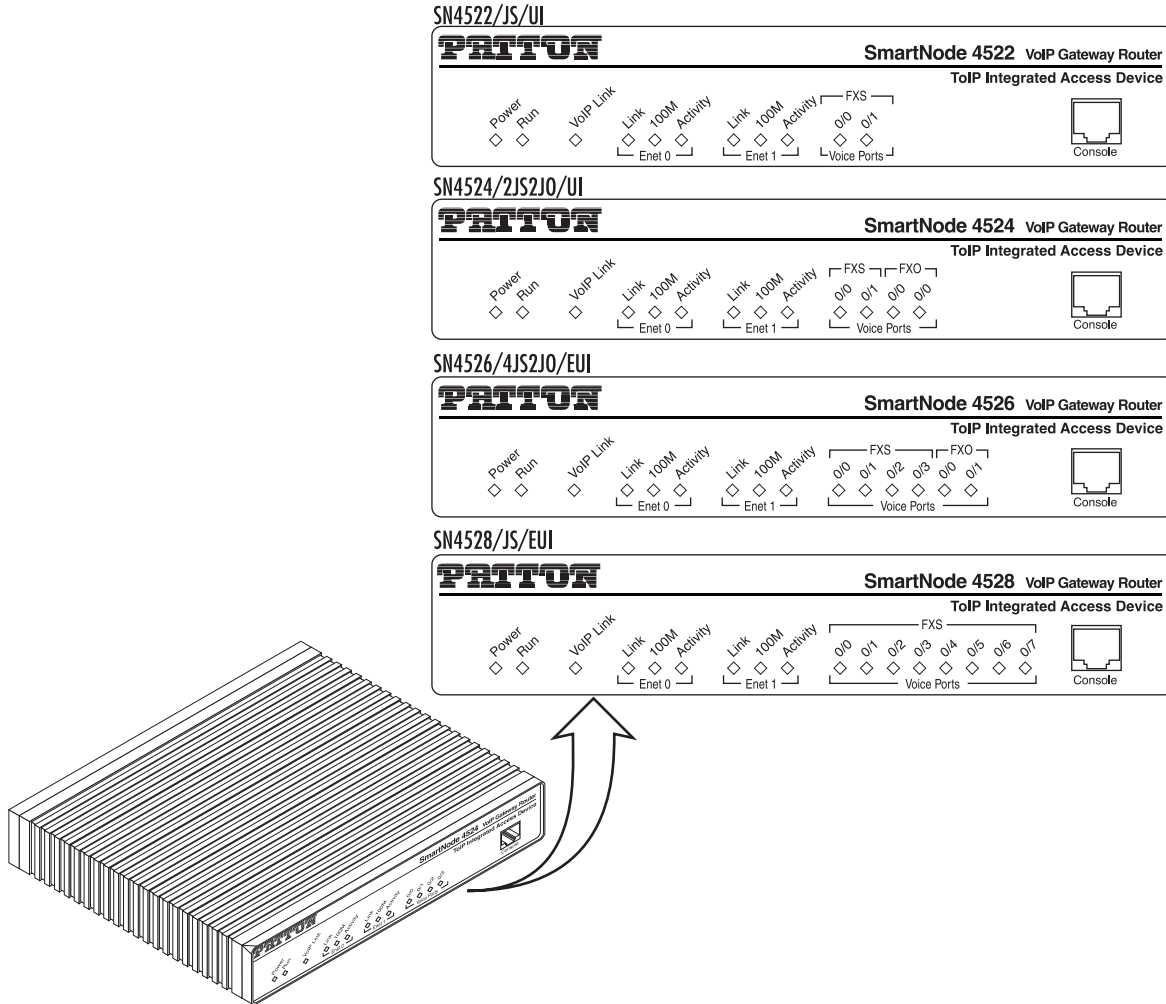

Figure 27. SmartNode 4830 Series front panels (FXO only and combined FXS/FXO)

Table 11. SmartNode LED Indications

LED	Description
<b>Note</b> If an error occurs, all LEDs will flash once per second.	
Power	When lit, indicates power is applied. Off indicates no power applied.
Run	When lit, indicates normal operation. Flashes once per second during boot (startup).
VoIP Link	When lit, indicates the gateway is registered on a gatekeeper, media gateway controller, associated to a remote unit, or has an active VoIP connection. Off indicates the unit is not configured or registered and has no active VoIP connection. Flashing green indicates that the unit is attempting or has failed to associate/register
FXS (each port)	Off indicates on-hook condition. Solid green when off-hook. Flashes to follow ring cadence.
FXO (each port)	Off indicates on-hook condition. Solid green when off-hook. Flashes to follow ring cadence.
Serial	<ul style="list-style-type: none"> <li>• STATUS: Lit when serial link is up.</li> <li>• ACTIVITY: Flashes when serial data is transmitted or received from the unit.</li> </ul>
Ethernet (each port)	<ul style="list-style-type: none"> <li>• Link: Lit when Ethernet link is up.</li> <li>• 100M: On when 100-Mbps Ethernet is selected.</li> <li>• Activity: Flashes when data is received or transmitted from the unit to the LAN.</li> </ul>
T1/E1 Status (optional) (Rear panel)	<ul style="list-style-type: none"> <li>• Green indicates signal acquisition (unframed mode) and frame lock (unframed mode).</li> </ul>
T1/E1 Activity (optional) (Rear panel)	<ul style="list-style-type: none"> <li>• Flashes when serial data is transmitted or received from the unit.</li> </ul>

# Chapter 6 **Contacting Patton for assistance**

## **Chapter contents**

- Introduction .....57
- Contact information .....57
  - Patton support headquarters in the USA .....57
  - Alternate Patton support for Europe, Middle East, and Africa (EMEA) .....57
- Warranty Service and Returned Merchandise Authorizations (RMAs) .....57
  - Warranty coverage .....57
    - Out-of-warranty service .....58
    - Returns for credit .....58
    - Return for credit policy .....58
  - RMA numbers .....58
  - Shipping instructions .....58



## Introduction

---

This chapter contains the following information:

- “Contact information”—describes how to contact Patton technical support for assistance.
- “Warranty Service and Returned Merchandise Authorizations (RMAs)”—contains information about the RAS warranty and obtaining a return merchandise authorization (RMA).

## Contact information

---

Patton Electronics offers a wide array of free technical services. If you have questions about any of our other products we recommend you begin your search for answers by using our technical knowledge base. Here, we have gathered together many of the more commonly asked questions and compiled them into a searchable database to help you quickly solve your problems:

### **Patton support headquarters in the USA**

- Online support: Available at **www.patton.com**
- E-mail support: E-mail sent to **support@patton.com** will be answered within 1 business day
- Telephone support: Standard telephone support is available five days a week—from **8:00 am to 5:00 pm EST (1300 to 2200 UTC/GMT)**—by calling **+1 (301) 975-1007**
- Support via VoIP: Contact Patton free of charge by using a VoIP ISP phone to call **sip:support@patton.com**
- Fax: **+1 (253) 663-5693**

### **Alternate Patton support for Europe, Middle East, and Africa (EMEA)**

- Online support: Available at **www.patton-inalp.com**
- E-mail support: E-mail sent to **support@patton-inalp.com** will be answered within 1 business day
- Telephone support: Standard telephone support is available five days a week—from **8:00 am to 5:00 pm CET (0900 to 1800 UTC/GMT)**—by calling **+41 (0)31 985 25 55**
- Fax: **+41 (0)31 985 25 26**

## Warranty Service and Returned Merchandise Authorizations (RMAs)

---

Patton Electronics is an ISO-9001 certified manufacturer and our products are carefully tested before shipment. All of our products are backed by a comprehensive warranty program.

**Note** If you purchased your equipment from a Patton Electronics reseller, ask your reseller how you should proceed with warranty service. It is often more convenient for you to work with your local reseller to obtain a replacement. Patton services our products no matter how you acquired them.

### **Warranty coverage**

Our products are under warranty to be free from defects, and we will, at our option, repair or replace the product should it fail within one year from the first date of shipment. Our warranty is limited to defects in work-

manship or materials, and does not cover customer damage, lightning or power surge damage, abuse, or unauthorized modification.

#### *Out-of-warranty service*

Patton services what we sell, no matter how you acquired it, including malfunctioning products that are no longer under warranty. Our products have a flat fee for repairs. Units damaged by lightning or other catastrophes may require replacement.

#### *Returns for credit*

Customer satisfaction is important to us, therefore any product may be returned with authorization within 30 days from the shipment date for a full credit of the purchase price. If you have ordered the wrong equipment or you are dissatisfied in any way, please contact us to request an RMA number to accept your return. Patton is not responsible for equipment returned without a Return Authorization.

#### *Return for credit policy*

- Less than 30 days: No Charge. Your credit will be issued upon receipt and inspection of the equipment.
- 30 to 60 days: We will add a 20% restocking charge (crediting your account with 80% of the purchase price).
- Over 60 days: Products will be accepted for repairs only.

#### **RMA numbers**

RMA numbers are required for all product returns. You can obtain an RMA by doing one of the following:

- Completing a request on the RMA Request page in the *Support* section at **www.patton.com**
- By calling **+1 (301) 975-1007** and speaking to a Technical Support Engineer
- By sending an e-mail to **returns@patton.com**

All returned units must have the RMA number clearly visible on the outside of the shipping container. Please use the original packing material that the device came in or pack the unit securely to avoid damage during shipping.

#### *Shipping instructions*

The RMA number should be clearly visible on the address label. Our shipping address is as follows:

#### **Patton Electronics Company**

RMA#: xxxx

7622 Rickenbacker Dr.

Gaithersburg, MD 20879-4773 USA

Patton will ship the equipment back to you in the same manner you ship it to us. Patton will pay the return shipping costs.

# Appendix A **Compliance information**

## **Chapter contents**

Compliance .....	60
EMC compliance: .....	60
Safety compliance: .....	60
PSTN regulatory compliance: .....	60
Radio and TV Interference (FCC Part 15) .....	60
FCC Part 68 (ACTA) Statement (FXO ports) .....	61
Industry Canada Notice (FXO ports) .....	61
CE Notice .....	62
Authorized European Representative .....	62

## Compliance

---

### **EMC compliance:**

- FCC Part 15, Class A
- EN55022, Class A
- EN55024

### **Safety compliance:**

- UL60950-1/CSA C22.2 No. 60950-1
- IEC 60950-1
- EN60950-1

### **PSTN regulatory compliance:**

- FCC Part 68
- CS-03
- TBR 21
- TBR 12 & 13 (E1)
- AS/ACIF S016:2001 (E1)
- AS/ACIF S043:2005 (DSL Models)

## Radio and TV Interference (FCC Part 15)

---

The SmartNode product generates and uses radio frequency energy, and if not installed and used properly—that is, in strict accordance with the manufacturer's instructions—may cause interference to radio and television reception. The SmartNode product have been tested and found to comply with the limits for a Class A computing device in accordance with specifications in Subpart B of Part 15 of FCC rules, which are designed to provide reasonable protection from such interference in a commercial installation. However, there is no guarantee that interference will not occur in a particular installation. If the SmartNode product does cause interference to radio or television reception, which can be determined by disconnecting the unit, the user is encouraged to try to correct the interference by one or more of the following measures: moving the computing equipment away from the receiver, re-orienting the receiving antenna and/or plugging the receiving equipment into a different AC outlet (such that the computing equipment and receiver are on different branches).



Disconnect all power before servicing.



The SmartNode product contains no user serviceable parts.



The mains outlet that is utilized to power the equipment must be within 1 foot (3 meters) of the device and shall be easily accessible.

## FCC Part 68 (ACTA) Statement (FXO ports)

This equipment complies with Part 68 of FCC rules and the requirements adopted by ACTA. On the bottom side of this equipment is a label that contains—among other information—a product identifier in the format *US: AAAEQ##TXXXX*. If requested, this number must be provided to the telephone company.

The method used to connect this equipment to the premises wiring and telephone network must comply with the applicable FCC Part 68 rules and requirements adopted by the ACTA.

If this equipment causes harm to the telephone network, the telephone company will notify you in advance that temporary discontinuance of service may be required. But if advance notice isn't practical, the telephone company will notify the customer as soon as possible. Also, you will be advised of your right to file a complaint with the FCC if you believe it is necessary.

The telephone company may make changes in its facilities, equipment, operations or procedures that could affect the operation of the equipment. If this happens the telephone company will provide advance notice in order for you to make necessary modifications to maintain uninterrupted service.

If trouble is experienced with this equipment, for repair or warranty information, please contact our company. If the equipment is causing harm to the telephone network, the telephone company may request that you disconnect the equipment until the problem is resolved.

Connection to party line service is subject to state tariffs. Contact the state public utility commission, public service commission or corporation commission for information.

## Industry Canada Notice (FXO ports)

This equipment meets the applicable Industry Canada Terminal Equipment Technical Specifications. This is confirmed by the registration number. The abbreviation, *IC*, before the registration number signifies that registration was performed based on a Declaration of Conformity indicating that Industry Canada technical specifications were met. It does not imply that Industry Canada approved the equipment.

This Declaration of Conformity means that the equipment meets certain telecommunications network protective, operational and safety requirements. The Department does not guarantee the equipment will operate to the user's satisfaction. Before installing this equipment, users should ensure that it is permissible to be con-

nected to the facilities of the local telecommunications company. The equipment must also be installed using an acceptable method of connection. In some cases, the company's inside wiring associated with a single line individual service may be extended by means of a certified connector assembly (telephone extension cord). The customer should be aware that compliance with the above condition may not prevent degradation of service in some situations. Repairs to some certified equipment should be made by an authorized maintenance facility designated by the supplier. Any repairs or alterations made by the user to this equipment, or equipment malfunctions, may give the telecommunications company cause to request the user to disconnect the equipment. Users should ensure for their own protection that the ground connections of the power utility, telephone lines and internal metallic water pipe system, are connected together. This protection may be particularly important in rural areas.

## CE Notice

---

This equipment conforms to the requirements of Council Directive 1999/5/EC on the approximation of the laws of the member states relating to Radio and Telecommunication Terminal Equipment and the mutual recognition of their conformity.

The safety advice in the documentation accompanying this product shall be obeyed. the conformity to the above directive is indicated by the CE sign on the device.

## Authorized European Representative

---

D R M Green

European Compliance Services Limited.

Oakdene House, Oak Road

Watchfield,

Swindon, Wilts SN6 8TD, UK

## Appendix B **Specifications**

### **Chapter contents**

DSP.....	64
Voice connectivity .....	64
Ethernet interface .....	64
Sync serial interface (if applicable) .....	64
T1/E1 interface (if applicable) .....	64
ADSL Daughter Card (if applicable) .....	65
G.SHDSL Daughter Card (if applicable).....	65
PPP and Frame-Relay support .....	66
Voice processing (signaling dependent).....	66
Fax and modem support.....	66
Voice signaling .....	66
Voice routing—session product.....	67
IP services.....	67
Management .....	67
Operating environment .....	68
Operating temperature .....	68
Operating humidity .....	68
System.....	68
Dimensions .....	68
Weight and power dissipation .....	68
Power supply.....	68
Identification of the SmartNode devices via SNMP.....	69

## DSP

---

One or two 4-channel DSPs

## Voice connectivity

---

2-wire Loopstart, RJ-11/12

Short haul loop 1.1 km @3REN

EuroPOTS (ETSI EG201 188)

Programmable AC impedance, feeding, and ring voltage; On-Hook Voltage 48VDC

Caller-ID Type-1/2 FSK and ITU V.23/Bell 202 generation

## Ethernet interface

---

2 10/100 Full Duplex/Autosensing Ethernet RJ-45

## Sync serial interface (if applicable)

---

ITU-T X.21 or V.35 interface

Female DB-25 and DB-15 connectors

DTE orientation. (DCE orientation for X.21 is available from the Patton factory upon special request).

## T1/E1 interface (if applicable)

---

- T1: RJ-48C connector (receptacle)
- E1: RJ-48C connector (receptacle) and dual BNC coaxial connectors (receptacles)
- Line Rate
  - 1.544 Mbps (T1) in accordance with ANSI T1.403
  - 2.048 Mbps (E1) in accordance with ITU-T G.703
- Line Coding
  - T1 AMI or B8ZS (default), selectable
  - E1 AMI or HDB3 (default), selectable
- Clocking is software selectable as Internal or Network Timing source (default)
- T1 Line Build-out
  - Transmit: Selectable for 0, -7.5, -15, -22.5 dB
  - Receive: Automatic
- Line Framing
  - T1 ESF (default) and unframed
  - E1 CRC (default), non-CRC-4, and unframed



- Isolation 1,500 Vrms

## ADSL Daughter Card (if applicable)

ADSL2+ ITU-T G.992.1 Annex A, B, G.992.2 G.dmt, G.lite, G.992.3 Annex L, I, J

8 user configurable PVCs

ATM QoS per PVC (UBR, CBR, VBR-rt)

Supports PPPoE, Routed IP over ATM

## G.SHDSL Daughter Card (if applicable)

Table 12. G.SHDSL Daughter Card Specifications

Factor	Specs
<b>DSL</b>	<ul style="list-style-type: none"> <li>• ITU-T G.991.2 (and Amendment 2)</li> <li>• ITU-T G.991.2, Annex A, B, F, G</li> <li>• Upgradable to ITU-T G.shdsl.bis—Annex F and G</li> <li>• G.991.2 2/4 (1/2 pair) operation</li> <li>• G.994.1 (G.hs) (per G.991.2)</li> <li>• ITU-T G.991.2 Section E.9 (TPS-TC for ATM transport)</li> <li>• ITU-T G.991.2 Section E.11 (TPS-TC for PTM transport)</li> </ul>
<b>DSL Connection</b>	RJ-11/12 (2-wire)
<b>Management</b>	<ul style="list-style-type: none"> <li>• I.610 OAM F4/F5</li> <li>• Management interfaces: GUI and Telnet</li> <li>• Software upgrade: GUI and TFTP</li> </ul>
<b>ATM Support</b>	<ul style="list-style-type: none"> <li>• Classical IPoA (RFC 1577/2225)</li> <li>• PPPoE Client (over ATM) (RFC 2516)</li> <li>• IPoA (RFC 2684/1483)</li> <li>• ATM AAL5 encapsulation</li> <li>• Max. 8 PVCs</li> <li>• User selectable VC MUX and LLC MUX (default)</li> <li>• Configurable auto-connection</li> <li>• ATM QoS: UBR (default), CBR, and VBR-rt, VBR-nrt, UBR: per VC queuing</li> <li>• Auto-configuration: TR-037 &amp; ILMI 4.0</li> </ul>
<b>Interworking/Interoperability</b>	<ul style="list-style-type: none"> <li>• G.SHDSL Interoperability: <ul style="list-style-type: none"> <li>- Alcatel</li> <li>- NEC</li> <li>- Lucent Anymedia</li> <li>- Lucent Stinger</li> </ul> </li> <li>• BRAS Interoperability: <ul style="list-style-type: none"> <li>- Cisco</li> <li>- Redback</li> </ul> </li> </ul>

## PPP and Frame-Relay support

---

X.21 or V.35 WAN

Frame-Relay (8 PVCs)

RFC1490, FRF.12 fragmentation

LMI, Q.933D, ANSI 617D, Gang of Four

PPP, PAP, CHAP, LCP, IPCP

## Voice processing (signaling dependent)

---

Voice codes:

- G.711 A-Law/ $\mu$ -Law (64 kbps)
- G.726 (ADPCM 40, 32, 24, 16 kbps)
- G.723.1 (5.3 or 6.3 kbps)
- G.729ab (8 kbps)
- Transparent pass through

G.168 echo cancellation

8 parallel voice connections

DTMF detection and generation

Carrier tone detection and generation

Silence suppression and comfort noise

Configurable dejitter buffer

Configurable tones (dial, ringing, busy)

Configurable transmit packet length

RTP/RTCP (RFC 1889)

## Fax and modem support

---

G.711 transparent FAX

Fax over IP (FoIP)

T.38 Fax relay (9.6 k, 14.4 k)

## Voice signaling

---

H.323v4

- RAS, H.225, H.245
- Fast-connect, early H.245
- Gatekeeper autodiscovery

- Alias registration
- Overlap sending
- Empty capability set (call transfer, hold)
- H.323v1 call transfer, hold
- H.323 GW and GK compatible
- H.323 Annex M3

SIP:

- SIPv2 (RFC3261, RFC3263)
- SIP call transfer, redirect, DTMF relay

## Voice routing—session product

---

Local switching; Interface huntgroups

Routing Criteria:

- Interface
- Calling/called party number
- Time of day, day of week, date

Number manipulation functions

- Replace numbers; Add/remove digits
- Multiple remote gateways; PLAR

## IP services

---

IPv4 product; RIPv1, v2 (RFC 1058 and 2453)

Programmable static routes

ICMP redirect (RFC 792); Packet fragmentation

DiffServe/ToS set or queue per header bits

Pocket Policing discards excess traffic

802.1p VLAN tagging

IPSEC AH & ESP Modes

Manual Key; IKE optional

AES/DES/3DES Encryption

## Management

---

Industry standard CLI with local console (RJ-45, RS-232, 9600 bps, 8, N, 1) and remote Telnet access

TFTP configuration & firmware loading

SNMP v1 agent (MIB II and private MIB)  
 Built-in diagnostic tools (trace, debug)  
 Java™ Applet; HPOV Integration with NNM

## Operating environment

---

### Operating temperature

32–104°F (0–40°C)

### Operating humidity

5–80% (non condensing)

## System

---

CPU Motorola MPC875 operating at 66 MHz

Memory:

- 32 Mbytes SDRAM
- 8 Mbytes Flash

## Dimensions

---

7.3W x 1.6H x 6.1D in. (18.5H x 4.1W x 15.5D cm)

## Weight and power dissipation

---

See [table 13](#).

Table 13. SmartNode weight and maximum power specifications

SmartNode model	Weight	Maximum power dissipation
SN4832/JSX/EUI	30.5 oz./500 g	7W
SN4834/JSX/EUI	30.5 oz./500 g	9W
SN4836/JSX/EUI	30.5 oz./500 g	11W
SN4838/JSX/EUI	30.5 oz./500 g	13W

## Power supply

---

External power supply, 100–240 VAC, 50/60 Hz, 200 mA

## Identification of the SmartNode devices via SNMP

All SmartNode devices have assigned sysObjectID (.iso.org.dod.internet.mgmt.mib-2.system.sysObjectID) numbers (see [table 14](#)).

Table 14. SmartNode Models and their Unique sysObjectID

SmartNode Model	SysObjectID
SN4834-JS	.iso.org.dod.internet.private.enterprises.patton.products.sn4xxx.1 1.3.6.1.4.1.1768.2.4.5.1
SN4836-JS	.iso.org.dod.internet.private.enterprises.patton.products.sn4xxx.3 1.3.6.1.4.1.1768.2.4.5.3
SN4838-JS	.iso.org.dod.internet.private.enterprises.patton.products.sn4xxx.4 1.3.6.1.4.1.1768.2.4.5.4
SN4834-2JS2JO	.iso.org.dod.internet.private.enterprises.patton.products.sn4xxx.9 1.3.6.1.4.1.1768.2.4.5.9
SN4836-4JS2JO	.iso.org.dod.internet.private.enterprises.patton.products.sn4xxx.10 1.3.6.1.4.1.1768.2.4.5.10
SN4838-4JS4JO	.iso.org.dod.internet.private.enterprises.patton.products.sn4xxx.11 1.3.6.1.4.1.1768.2.4.5.11
SN4832-JO	.iso.org.dod.internet.private.enterprises.patton.products.sn4xxx.15 1.3.6.1.4.1.1768.2.4.5.15
SN4834-JO	.iso.org.dod.internet.private.enterprises.patton.products.sn4xxx.16 1.3.6.1.4.1.1768.2.4.5.16

According to [table 14](#), an SNMP get request to *.iso.org.dod.internet.mgmt.mib-2.system.sysObjectID* of a SmartNode 4834-JS device reads out a numeric OID of *1.3.6.1.4.1.1768.2.4.5.1*, which represents a SmartNode 4834 device. The mapping of the sysObjectID to each of the SmartNode model is realized with the SmartNode product identification MIB.



The SNMP agent running in SmartWare is SNMP version 1 (SNMPv1) compliant. SNMP version 2 (SNMPv2) and SNMP version 3 (SNMPv3) are not currently supported.

# Appendix C **Cabling**

---

## **Chapter contents**

Introduction .....	71
Serial console .....	71
Ethernet 10Base-T and 100Base-T .....	72
Analog FXS .....	73
Analog FXO .....	74
T1/E1 .....	75
DSL .....	75

## Introduction

This section provides information on the cables used to connect the SmartNode and the interface cards to the existing network infrastructure and to third party products.

## Serial console

The SmartNode can be connected to a serial terminal over its serial console port, as depicted in [figure 28](#).

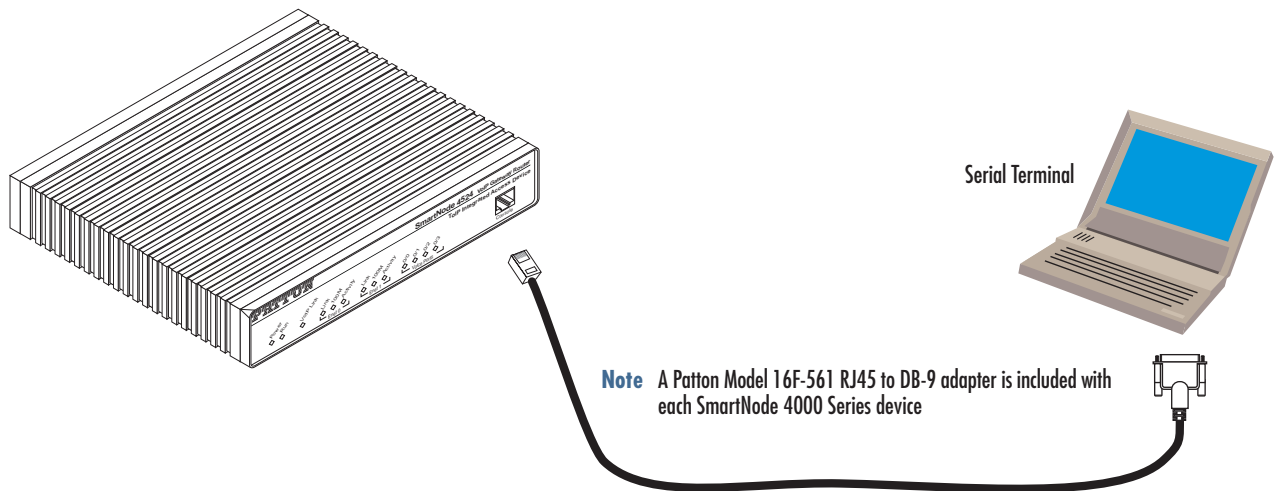

Figure 28. Connecting a serial terminal

**Note** See section “[Console port](#)” on page 77 for console port pin-outs.

## Ethernet 10Base-T and 100Base-T

Ethernet devices (10Base-T/100Base-T) are connected to the SmartNode over a cable with RJ-45 plugs. The Ethernet ports support auto-MDI-X, so any standard Ethernet cable will work properly.

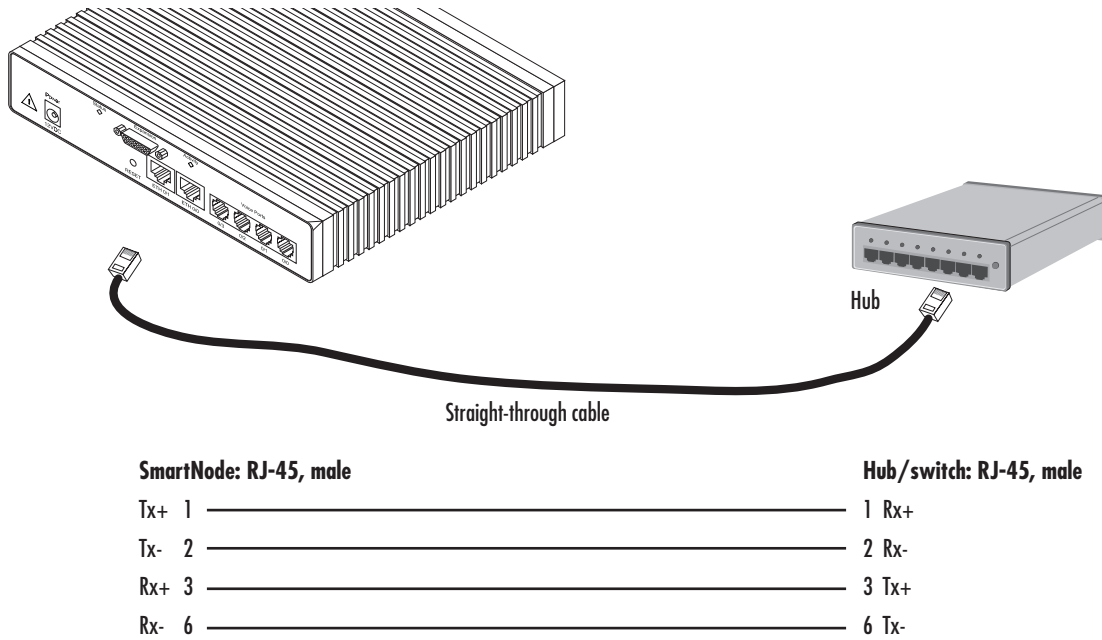

Figure 29. Ethernet straight-through



## Analog FXS

Applicable to SmartNodes equipped with FXS ports. The FXS ports are connected to analog terminals (phones, fax machines, answering machines) via cables terminated with RJ-11 connectors (see section “FXS port” on page 79 for details on port pinouts).

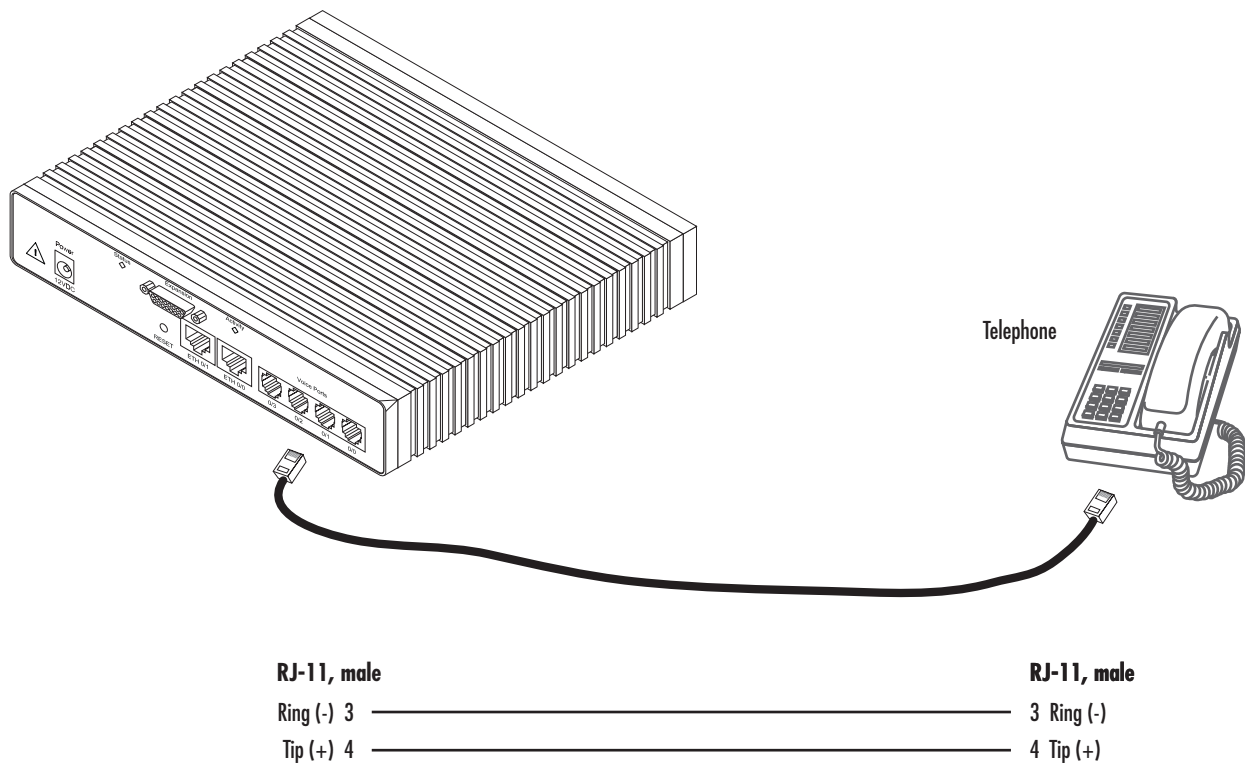

Figure 30. Connecting an FXS device

## Analog FXO

Applicable to SmartNodes equipped with FXO ports. The FXO ports are connected to analog phone lines via cables terminated with RJ-11 connectors (see section “FXO port” on page 79 for details on port pinouts).

**Note** The phone line socket (connector type and pinout) available from the public network vary from country to country. Refer to technical information available from your local operator for additional cabling information.

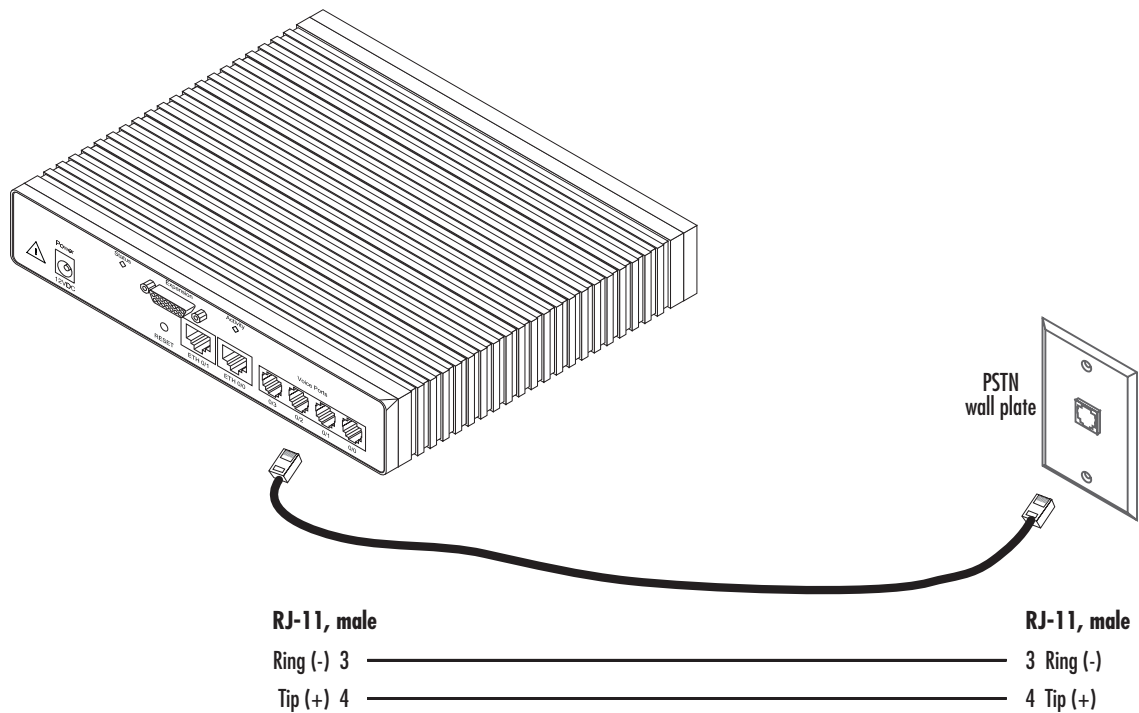

Figure 31. Connecting to an FXO line socket

## T1/E1

(Applicable to SmartNodes with integrated T1 or E1 WAN interface). The T1 or E1 ports are connected to local exchange (LE). On this SmartNode series, the T1/E1 ports may only be used for data connections, and not for voice (PRI). There are other SmartNodes that carry PRI voice interfaces. Type and pin outs may vary depending on the manufacturer. In most cases, a straight-through RJ-45 to RJ-45 can be used to connect the SmartNode.



**Hazardous network voltages are present in the T1/E1 cables. If you detach the cable, detach the end away from the SmartNode or interface card first to avoid possible electric shock. Network hazardous voltages may be present on the device in the area of the T1/E1 port, regardless of when power is turned OFF.**



To prevent damage to the system, make certain you connect the T1/E1 cable to the T1/E1 port only and not to any other RJ-45 socket.

## DSL

(Applicable to SmartNodes with integrated DSL WAN interface). The DSL interface connects to the analog or ISDN telecom line coming to your house. Depending on the country and type of installation, a frequency splitter device may be inserted between the phone outlet and the SmartNode, splitting the DSL signal from the phone signal.

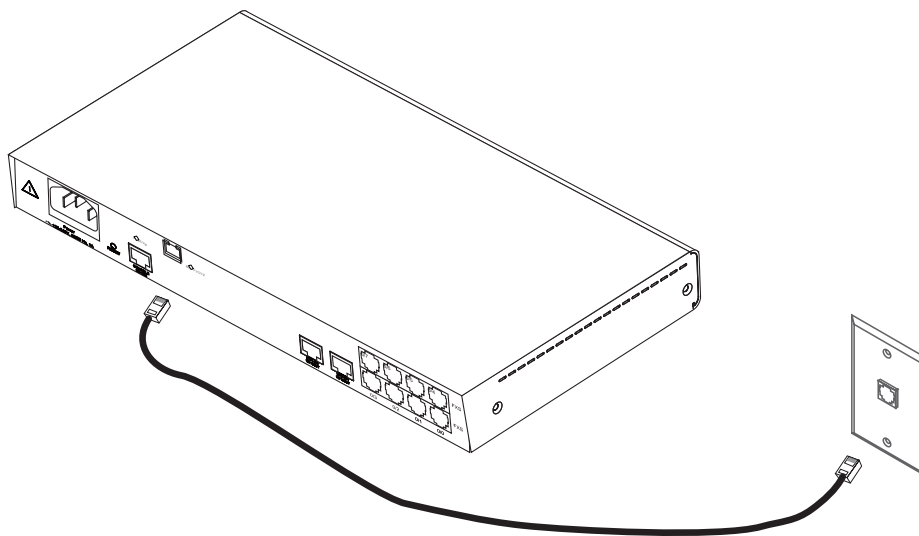

Figure 32. Connecting the DSL cable

## Appendix D **Port pin-outs**

### **Chapter contents**

Introduction .....	77
Console port.....	77
Ethernet 10Base-T and 100Base-T port.....	77
Sync Serial Port .....	78
V.35 Serial port .....	78
X.21 Serial Port .....	79
FXS port.....	79
FXO port .....	79
T1/E1 port .....	80
ADSL/G.SHDSL port.....	80

## Introduction

This section provides pin-out information for the ports of the SmartNode.

### Console port

**Configuration settings:** 9600 bps, 8 bits, no parity, 1 stop bit, no flow control

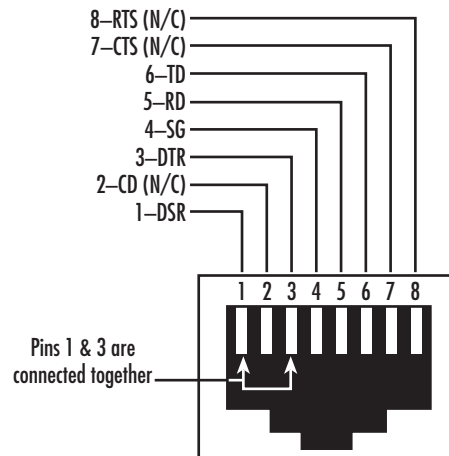

Figure 33. EIA-561 (RJ-45 8-pin) port

**Note** *N/C* means no internal electrical connection.

### Ethernet 10Base-T and 100Base-T port

Table 15. RJ-45 socket

Pin	Signal
1	TX+
2	TX-
3	RX+
6	RX-

**Note** Pins not listed are not used.

## Sync Serial Port

---

### V.35 Serial port

---

Table 16. V.35 Female DB-25 connector

V.35 Interface Pin-Out	
Pin	Signal
1	Frame Ground
2	TD-a
3	RD-a
4	RTS
5	CTS
6	DSR
7	Signal Ground
8	CD
9	RC-b
11	XTC-b
12	TC-b
14	TD-b
15	TC-a
16	RD-b
17	RC-a
18	LL
20	DTR
21	RL
24	XTC-a

## X.21 Serial Port

Table 17. X.21 Female DB-15 connector

X.21 Interface Pin-Out	
Pin	Signal
1	Signal Ground
2	TD-d
3	Control-a
4	RD-a
5	Indication-a
6	Signal Element Timing (Clock) -a
8	DTE Common Return
9	TD-b
10	Control-b
11	RD-b
12	Indication-b
13	Signal Element Timing (Clock)-b

## FXS port

The FXS ports use an RJ-11 connector with 6 positions. The middle two positions, 3 and 4, are used according to [table 18](#).

Table 18. RJ-11 socket

Pin	Signal
3	Ring (-)
4	Tip (+)

**Note** Pins not listed are not used.

## FXO port

The FXO ports use an RJ-11 connector with 6 positions. The middle two positions, 3 and 4, are used according to [table 19](#).

Table 19. RJ-11 socket

Pin	Signal
3	Ring (-)
4	Tip (+)

**Note** Pins not listed are not used.

## T1/E1 port

---

Table 20. RJ-45 socket

Pin	USR
1	RX Ring
2	RX Tip
3	RX Shield
4	TX Ring
5	TX Tip
6	TX Shield

**Note** Pins not listed are not used.

## ADSL/G.SHDSL port

---

Table 21. RJ-11 connector

Pin	Signal
1	No connection
2	Tip
3	Ring
6	No connection

**Note** Pins not listed are not used.



# Appendix E **SmartNode 4830 Series** **factory configuration**

---

## **Chapter contents**

Introduction .....	82
--------------------	----

## Introduction

---

The factory configuration settings for SmartNode 4830 Series devices are as follows:

```
#-----#
#
# 4830 Series
# Factory configuration file
#
#-----#

dns-relay
ntp-client
ntp-client server primary 129.132.2.21 port 123 version 4

system
ic voice 0
    low-bitrate-codec g729

profile napt NAPT

profile dhcp-server DHCP
network 192.168.1.0 255.255.255.0
include 1 192.168.1.10 192.168.1.99
lease 2 hours
default-router 1 192.168.1.1
domain-name-server 1 192.168.1.1

context ip router
interface eth0
    ipaddress dhcp
    tcp adjust-mss rx mtu
    tcp adjust-mss tx mtu

interface eth1
    ipaddress 192.168.1.1 255.255.255.0
    tcp adjust-mss rx mtu
    tcp adjust-mss tx mtu

interface wan
    ipaddress dhcp
    use profile napt NAPT

context ip router
    dhcp-server use DHCP
port ethernet 0 0
    medium auto
    encapsulation ip
    bind interface eth0 router
    no shutdown
port ethernet 0 1
    medium auto
    encapsulation ip
    bind interface eth1 router
    no shutdown
```

# Appendix F **Installation checklist**

---

## **Chapter contents**

Introduction.....	84
-------------------	----

## Introduction

This appendix lists the tasks for installing a SmartNode 4830 Series Analog VoIP IAD (see [table 22](#)). Make a copy of this checklist and mark the entries as you complete each task. For each SmartNode 4830 Series IAD, include a copy of the completed checklist in your site log.

Table 22. Installation checklist

Task	Verified by	Date
Network information available & recorded in site log		
Environmental specifications verified		
Site power voltages verified		
Installation site pre-power check completed		
Required tools available		
Additional equipment available		
All printed documents available		
SmartWare release & build number verified		
Rack, desktop, or wall mounting of chassis completed		
Initial electrical connections established		
ASCII terminal attached to console port		
Cable length limits verified		
Initial configuration performed		
Initial operation verified		

# Appendix G **Accessories**

---

## **Chapter contents**

Introduction.....	86
-------------------	----

## Introduction

---

The cables listed in [table 23](#) are available as accessories for the SmartNode 4900 Series products.

Table 23. Accessory cables

Description	Part Number
DB-25 male to M/34 male cable (Sync serial v.35 port)	1205-25M/35M
DB-25 male to M/34 female cable (Sync serial v.35 port)	1205-25M/35M
DB-15 male to DB-15 male cable (Sync serial x.21 port)	EMEM216006