

USER MANUAL

**MODEL 1004
and 1004S**
High Speed,
Multipoint Short
Range Modem



PE PATTON
Electronics Co.

Part# 07M1004-C
Doc# 047011UC
Revised 8/10/95

SALES OFFICE
(301) 975-1000
TECHNICAL SUPPORT
(301) 975-1007

1.0 WARRANTY INFORMATION

Patton Electronics warrants all Model 1004 components to be free from defects, and will—at our option—repair or replace the product should it fail within one year from the first date of shipment.

This warranty is limited to defects in workmanship or materials, and does not cover customer damage, abuse or unauthorized modification. If this product fails or does not perform as warranted, your sole recourse shall be repair or replacement as described above. Under no condition shall **Patton Electronics** be liable for any damages incurred by the use of this product. These damages include, but are not limited to, the following: lost profits, lost savings and incidental or consequential damages arising from the use of or inability to use this product. **Patton Electronics** specifically disclaims all other warranties, expressed or implied, and the installation or use of this product shall be deemed an acceptance of these terms by the user.

1.1 RADIO AND TV INTERFERENCE

The Model 1004 generates and uses radio frequency energy, and if not installed and used properly—that is, in strict accordance with the manufacturer's instructions—may cause interference to radio and television reception. The Model 1004 has been tested and found to comply with the limits for a Class A computing device in accordance with the specifications in Subpart J of Part 15 of FCC rules, which are designed to provide reasonable protection from such interference in a commercial installation. However, there is no guarantee that interference will not occur in a particular installation. If the Model 1004 does cause interference to radio or television reception, which can be determined by disconnecting the RS-232 interface, the user is encouraged to try to correct the interference by one or more of the following measures: moving the computing equipment away from the receiver, re-orienting the receiving antenna and/or plugging the receiving equipment into a different AC outlet (such that the computing equipment and receiver are on different branches).

1.2 SERVICE

All warranty and non-warranty repairs must be returned freight prepaid and insured to Patton Electronics. All returns must have a Return Materials Authorization number on the outside of the shipping container. This number may be obtained from Patton Electronics Technical Service at **(301) 975-1007**. *Packages received without an RMA number will not be accepted.*

Patton Electronics' technical staff is also available to answer any questions that might arise concerning the installation or use of your Model 1004. Technical Service hours: **8AM to 5PM EST, Monday through Friday.**

2.0 GENERAL INFORMATION

Thank you for your purchase of this Patton Electronics product. This product has been thoroughly inspected and tested and is warranted for One Year parts and labor. If any questions or problems arise during installation or use of this product, please do not hesitate to contact Patton Electronics Technical Support at (301) 975-1007.

2.1 FEATURES

- Operates asynchronously, point to point or multipoint
- Up to 50 multipoint device drops in a polling environment
- Data rates to 115.2 Kbps
- Passes transmit & receive data, one control signal each direction
- DCE/DTE switch selectable on RS-232 interface
- No AC power or batteries are required
- Variable high/low impedance settings
- Carrier can be set as “constantly on” or “controlled by RTS”

2.2 DESCRIPTION

The Model 1004 High Speed, Multipoint Short Range Modem provides exceptional versatility in a compact package. Requiring no AC power or batteries for operation, the Model 1004 supports asynchronous RS-232 data rates to 115.2 Kbps over one or two unconditioned twisted pair. Distances up to 9.4 miles are attainable at lower data rates (19.2 Kbps, 19 AWG twisted pair).

The Model 1004 can handle up to 50 terminal drops in a multipoint polling environment. For RS-485 and serial printer applications requiring hardware handshaking, the Model 1004 passes one control signal in each direction. The Model 1004 may be configured for high or low impedance operation, and carrier may be set to “constantly on” or “controlled by RTS”.

Options for twisted pair connection include terminal blocks with strain relief, RJ-11, RJ-45 and dual modular connectors for daisy chaining. The surge protected Model 1004S incorporates Silicon Avalanche Diodes which provide 600 watts per wire of protection against harmful data line transient surges.

3.0 CONFIGURATION

The Model 1004 is configured using six PC board mounted switches. Figure 1 shows the switch locations, along with the location of the terminal blocks and optional surge protectors:

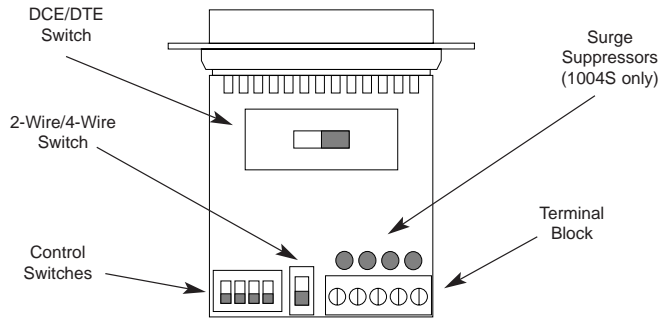

Figure 1. Model 1004 board, showing switch locations

3.1 SETTING THE DCE/DTE SWITCH

For your convenience, the Model 1004 has an externally accessible DCE/DTE switch (Figure 2). If the device connected to the Model 1004 is a modem or multiplexer (or is wired like one), set the switch to "DTE". This setting causes the Model 1004 to behave like Data Terminal Equipment and transmit data on pin 2.

If the device connected to the Model 1004 is a PC, terminal or host computer (or is wired like one), set the switch to "DCE". This setting causes the Model 1004 to behave like Data Communications Equipment and transmit data on pin 3.

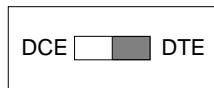

Figure 2. Close up of the external DCE/DTE switch

3.2 ACCESSING THE CONFIGURATION SWITCHES

The five switches shown in Figure 3 configure the Model 1004 for RTS/CTS delay, echo, method of carrier control, impedance and 2-wire/4-wire operation. These switches are located *internally* on the Model 1004's PC board. To access switch set 1 (SW1) and switch set 2 (SW2), use a small flat blade screwdriver to pop open the Model 1004's case as shown in Figure 4.

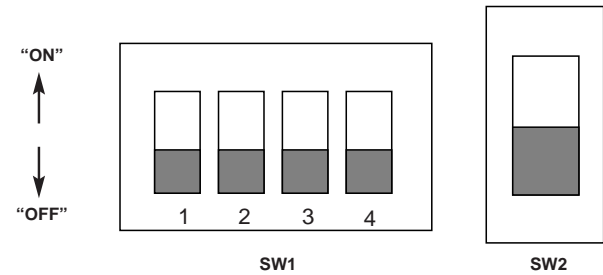

Figure 3. Close up of switches SW1 and SW2 on the PC board

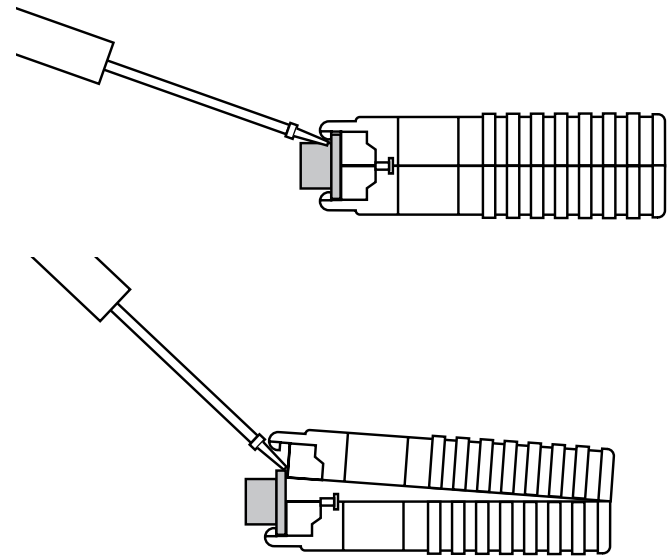

Figure 4. Opening the Model 1004's plastic case with a small screwdriver

3.2.1 SWITCH SETTINGS

All possible settings for the Model 1004's configuration switches are presented in the summary table below. If you have additional questions, contact Technical Support at (301) 975-1000.

SWITCH SUMMARY TABLE			
Position	Function	Off Position	On Position
SW1-1	RTS/CTS Delay	0mS	8mS
SW1-2	Echo Enable	Echo "Off"	Echo "On"
SW1-3	Carrier Control	Constantly "On"	Controlled by RTS
SW1-4	Impedance	High (120K Ohm)	Low (120 Ohm)
SW2	2 wire/4 wire	2-wire	4-wire

SW 1-1: RTS/CTS Delay

The setting for Switch SW1-1 determines the amount of delay between the time the Model 1004 "sees" RTS and when it sends CTS. (This option is available in DCE mode only).

<u>SW1-1</u>	<u>Setting</u>
Off	0mS
On	8mS

SW 1-2: Echo Enable

Switch SW1-2 determines whether the Model 1004 echoes data back to the transmitting device. (Half duplex modes only).

<u>SW1-2</u>	<u>Setting</u>
Off	Echo Off
On	Echo On

SW 1-3: Carrier Control Method

Switch SW1-3 determines whether the carrier is "constantly on" or "controlled by RTS". This setting allows for operation in switched carrier, multipoint and/or hardware handshaking applications.

<u>SW1-3</u>	<u>Setting</u>
Off	Constantly "on"
On	Controlled by RTS

SW 1-4: Impedance

Switch SW1-4 defines a termination resistance. The Model 1004's generator can drive 50 unit loads including two termination resistances of 120 Ohms each.

<u>SW1-4</u>	<u>Setting</u>
Off	High (120K Ohm)
On	Low (120 Ohm)

SW 2: 2-Wire/4-Wire

Switch SW1-4 determines whether the Model 1004 will operate in either 2-wire or 4-wire mode.

<u>SW1-4</u>	<u>Setting</u>
Off	2-wire
On	4-wire

3.2.2 CONFIGURATION SWITCH APPLICATIONS

The table below shows you how to set the Model 1004's configuration switches to fit several common applications. If you have any questions, call Patton Technical Support at (301) 975-1007.

TYPICAL SWITCH APPLICATIONS					
Switch Settings	Point-to-Point			Multi-point	
	4W	4W HDX	2W	4W	2W
SW1-1: RTS/CTS*	ON	ON	ON	ON	ON
SW1-2: Echo	OFF	ON	OFF	ON	OFF
SW1-3: Carrier	OFF	ON	ON	Master-OFF Slaves-ON	ON
SW1-4: Impedance	ON	ON	ON	Master - ON Slaves - HIGH Last Slave - ON	
SW2: 2-wire/4-wire	ON	ON	OFF	ON	OFF

*NOTE: RTS/CTS Delay setting should be based upon transmission timing.

4.0 INSTALLATION

Once the Model 1004 is properly configured, it is ready to connect to your system. This section tells you how to properly connect the Model 1004 to the twisted pair and RS-232 interfaces, and how to operate the Model 1004.

4.1 TWISTED PAIR CONNECTION

The Model 1004 supports data-only communication between two RS-232 devices at distances to 9.4 miles and data rates to 115.2 Kbps. There are two essential requirements for installing the Model 1004:

1. These units work in **pairs**. Therefore, you must have one Model 1004 at each end of a two twisted pair interface. In multipoint environments, there must be one Model 1004 at the RS-232 host and one at each RS-232 terminal.
2. To function properly, the Model 1004 needs two twisted pairs of metallic wire. These pairs must be **unconditioned** dry metallic wire, between 19 and 26 AWG (the higher number gauges may limit distance). Standard dial-up telephone circuits, or leased circuits that run through signal equalization equipment, are *not acceptable*.

For your convenience, the Model 1004 is available with several different twisted pair interfaces: RJ-11 jack, RJ-45 jack, terminal blocks with strain relief and dual modular jacks (for multipoint daisy-chaining).

4.1.1 TWISTED PAIR CONNECTION USING TERMINAL BLOCKS

If your application requires you to connect one or two pairs of bare wires to the Model 1004, you will need to open the case to access the terminal blocks. The following instructions will tell you how to open the case, connect the bare wires to the terminal blocks and fasten the strain relief collar in place so the wires won't pull loose.

1. You should already have the case open for the configuration procedure. If not, see Section 3.2.
2. Strip the outer insulation from the twisted pair(s) about one inch from the end.

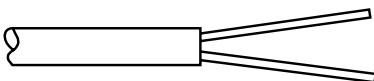

3. Strip the insulation on each of the twisted pair wires about .25".

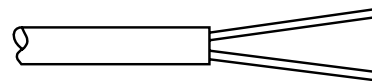

4. In a **two pair circuit**, connect *one pair* of wires to XMT+ and XMT- (transmit positive and negative) on the terminal block, making careful note of which color is positive and which color is negative.

5. Connect the *other pair* of wires to RCV+ and RCV- (receive positive and negative) on the terminal block, again making careful note of which color is positive and which color is negative.

Ultimately, you will want to construct a two pair crossover cable that makes a connection with the two Model 1004s as shown below.

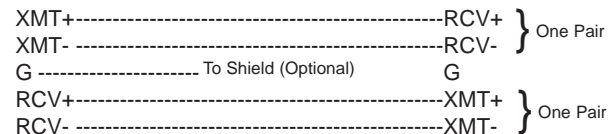

6. In a **single pair circuit**, use *only the transmit (XMT) pair* as

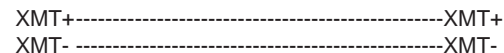

shown below:

7. If there is a shield around the telephone cable, it may be connected to "G" on the terminal block. To avoid ground loops, we recommend connecting the shield at the computer end only. A ground wire is *not necessary* for proper operation of the Model 1004.

8. When you finish connecting the wires to the terminal block, the assembly should resemble the diagram below:

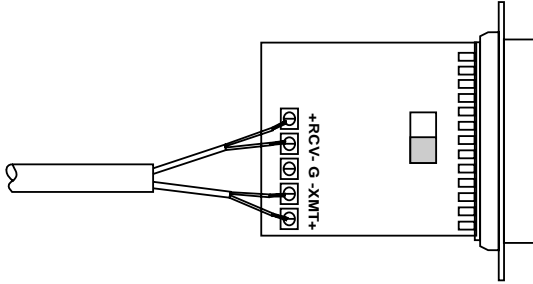

9. Place the 2 halves of the strain relief assembly on either side of the telephone wire and press together very lightly. Slide the assembly so that it is about 2 inches from the terminal posts and press together firmly. If your cable diameter is too small or too large for our strain relief, please contact our technical support. We have strain relief assemblies to accommodate most cable diameters.

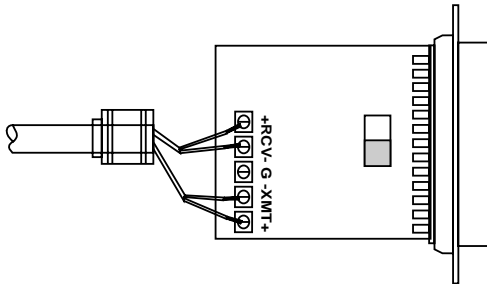

10. Insert the strain relief assembly and wire into the slot in the bottom half of the modem case. Set it into the recess in the case.

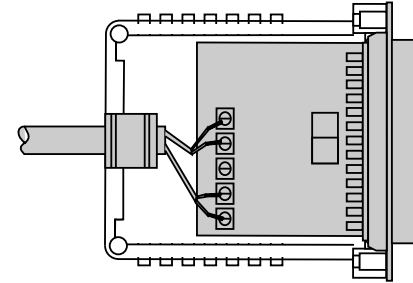

11. BEND the top half of the case as necessary to place it over the strain relief assembly. Do not snap the case together yet.

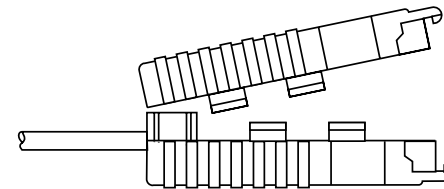

12. Insert one captive screw through a saddle washer. Then insert the entire piece through the hole in the DB-25 end of the case. Snap that side of the case closed. Repeat the process for the other side. This completes cable installation.

4.1.2 TWISTED PAIR CONNECTION USING RJ-11 OR RJ-45

The RJ-11 and RJ-45 connectors on the Model 1004's twisted pair interface are pre-wired for a standard TELCO wiring environment. The signal/pin relationships are shown below:

<u>RJ-11</u>	<u>SIGNAL</u>	<u>RJ-45</u>	<u>SIGNAL</u>
1	GND†	1	N/C
2	RCV-	2	GND
3	XMT+	3	RCV-
4	XMT-	4	XMT+
5	RCV+	5	XMT-
6	GND	6	RCV+
		7	GND
		8	N/C

†Connection to ground is optional

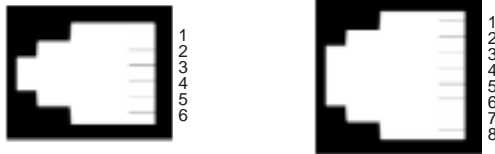

AT&T standard modular color codes

When connecting two Model 1004's, it is necessary to use a crossover cable. The diagrams below show how a crossover cable should be constructed for the following environments: 4-wire RJ-11, 4-wire RJ-45, 2-wire RJ-11 or 2-wire RJ-45.

RJ-11 Cable (4-Wire)

<u>SIGNAL</u>	<u>PIN#</u>	<u>PIN#</u>	<u>SIGNAL</u>
GND†	1-----	6	GND†
RCV-	2-----	4	XMT-
XMT+	3-----	5	RCV+
XMT-	4-----	2	RCV-
RCV+	5-----	3	XMT+
GND†	6-----	1	GND†

†Connection to ground is optional

RJ-45 Cable (4-Wire)

<u>SIGNAL</u>	<u>PIN#</u>	<u>PIN#</u>	<u>SIGNAL</u>
GND†	2-----	7	GND†
RCV-	3-----	5	XMT-
XMT+	4-----	6	RCV+
XMT-	5-----	3	RCV-
RCV+	6-----	4	XMT+
GND†	7-----	2	GND†

RJ-11 Cable (2-Wire)

<u>SIGNAL</u>	<u>PIN#</u>	<u>PIN#</u>	<u>SIGNAL</u>
XMT+	3-----	3	XMT+
XMT-	4-----	4	XMT-

RJ-45 Cable (2-Wire)

<u>SIGNAL</u>	<u>PIN#</u>	<u>PIN#</u>	<u>SIGNAL</u>
XMT+	4-----	4	XMT+
XMT-	5-----	5	XMT-

†Connection to ground is optional

4.2 WIRING FOR MULTIPOINT CIRCUITS

The Model 1004 supports multi-point applications using either a star or daisy chain topology. Both topologies require special wiring, as well as specific DIP switch settings for master and slave units. **Note:** Refer to Section 3.2.2 for multipoint DIP switch settings.

4.2.1 STAR TOPOLOGY

Using a star topology, you may connect several Model 1004s together in a master/slave arrangement. Maximum distance between the units will vary based upon the number of drops, data rate, wire gauge, etc. Call Technical Support for specific distance estimates.

Figure 4 shows how to wire the two-pair cables properly for a Model 1004 star topology. Note that the ground connection is not needed.

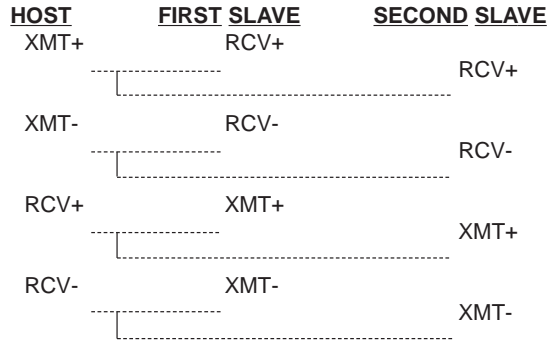

Figure 4. Star wiring for Model 1004 host and slaves

4.2.2 DAISY CHAIN TOPOLOGY

Using a daisy chain topology, you may connect several Model 1004s together in a master/slave arrangement. Maximum distance between the units will vary based upon the number of drops, data rate, wire gauge, etc. Call Technical Support for specific distance estimates.

Figure 5 shows how to wire the two-pair cables properly for a Model 1004 daisy chain topology. Note that the ground connection is not needed.

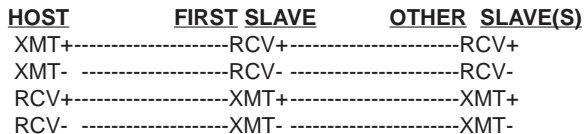

Figure 5. Daisy chain wiring for Model 1004 host and slaves

Optional Connection: Dual Modular Jacks

To facilitate daisy chaining, the Model 1004 is available in a “DRJ11” (dual RJ-11) or “DRJ45” (dual RJ-45) version. These units have two specially wired modular jacks for twisted pair connection.

With the dual modular units, you won't need to build cumbersome “Y” cables for your daisy chain application. Simply use a **crossover** cable to go between the host and the first slave (see Section 4.1.2 for crossover cable wiring instructions), and **straight through** cables between the slaves.

4.3 CONNECTION TO THE RS-232 INTERFACE

Once you have properly configured the Model 1004 and connected the twisted pair wires correctly, simply plug the Model 1004 directly into the DB-25 port of the RS-232 device. Remember to insert and tighten the two captive connector screws.

(Note: If you must use a cable to connect the Model 1004 to the RS-232 device, make sure it is a *straight through* cable of the shortest possible length—we recommend 6 feet or less).

4.4 OPERATING THE MODEL 1004

Once the Model 1004 is properly installed, it should operate transparently—as if it were a standard cable connection. Operating power is derived from the RS-232 data and control signals; there is no “ON/OFF” switch. All data signals from the RS-232 and RS-485 interfaces are passed straight through. Additionally, one hardware flow control signal is passed *in each direction*.

**APPENDIX A
SPECIFICATIONS**

Transmission Format: Asynchronous

Data Rate: Up to 115,200 bps

Transmit Line: 2, 4 wire unconditioned twisted pair

Transmit Mode: Full or half duplex

Transmit Level: 0 dBm

Range: Up to 9 miles

Control Signals: In DCE mode, DSR turns "ON" immediately after the terminal raises DTR; DCD turns "ON" after recognizing the receive signal from the line; CTS turns on after the terminal raises RTS

Carrier: The carrier is switch selected either continuous operation or switched operation, controlled by RTS

Surge Protection: 600W power dissipation at 1 mS and response time less than 1.0 pS

Power: No external power required, uses ultra low power from EIA data and control signals

Size: 2.66" x 2.10" x 0.73"

**APPENDIX B
RS-232 PIN CONFIGURATIONS**

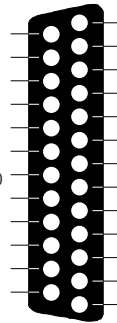
DIRECTION	"DCE" SETTING	DIRECTION
To Model 1004	 <p>Data Term. Ready (DTR) - 20</p>	To Model 1004 From Model 1004 To Model 1004 From Model 1004 From Model 1004 From Model 1004

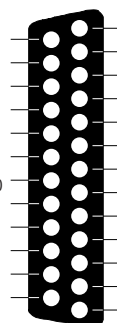
DIRECTION	"DTE" SETTING	DIRECTION
From Model 1004	 <p>Data Term. Ready (DTR) - 20</p>	From Model 1004 To Model 1004 From Model 1004 To Model 1004 To Model 1004 To Model 1004

APPENDIX C BLOCK DIAGRAM

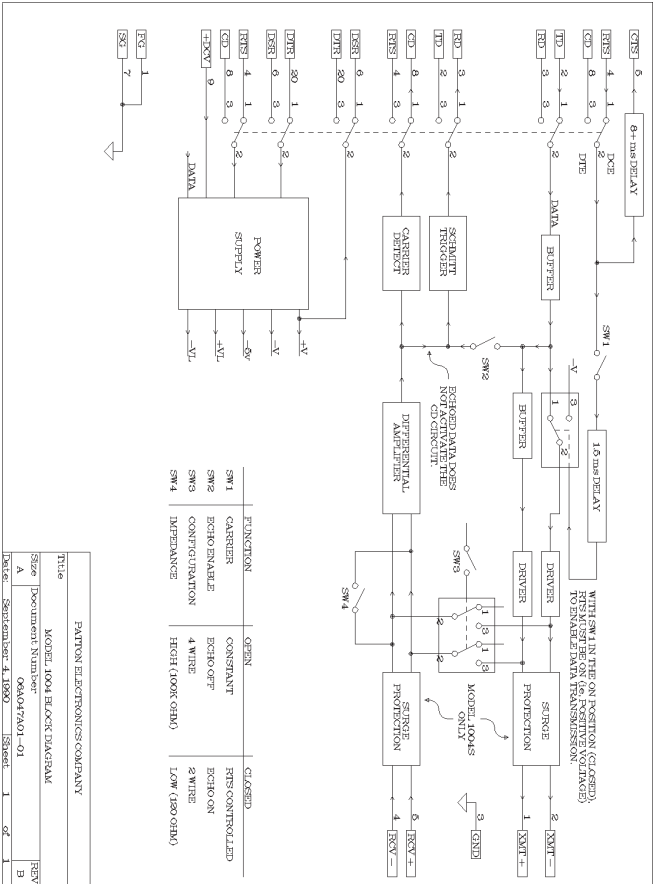

PATTON ELECTRONICS COMPANY	
Title: MODEL 1004 BLOCK DIAGRAM	
Size: A	Document Number: 00A07A01-01
Date: September 4, 1990	Issue: 1 of 1
	REV B