

# Kodak **ADVANTiX**

*4700ix / 4800ix Zoom*  
Camera

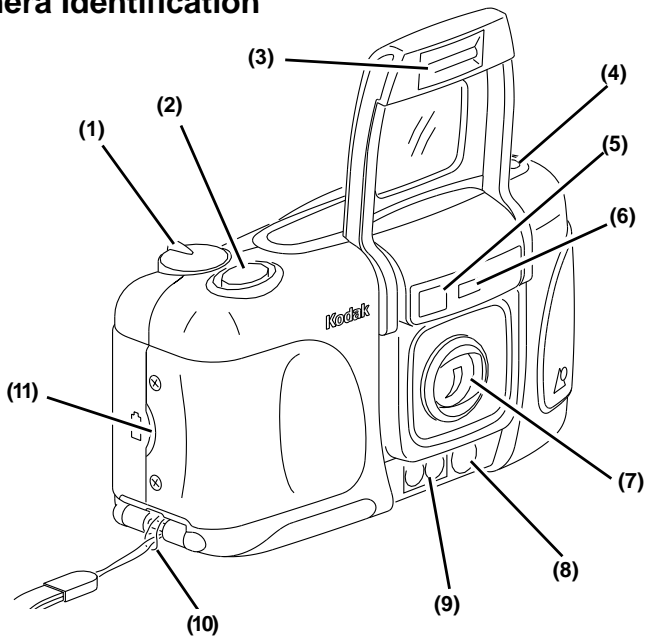

# Camera Identification



*Unfold the front and back flaps of this manual for easy reference to the camera's parts.*

# Camera Identification

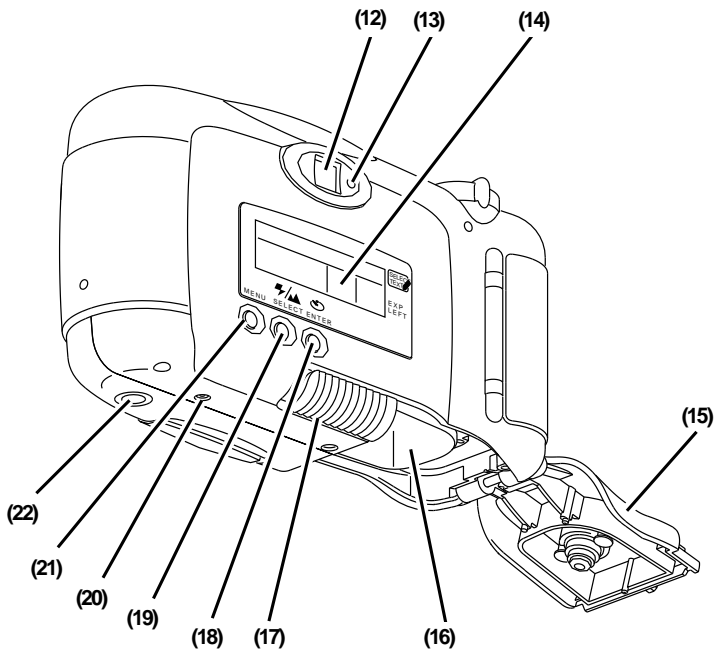

# LCD Panel

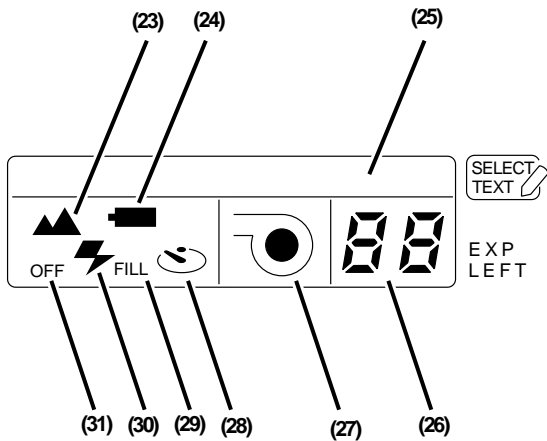

**This device complies with part 15 of the FCC Rules. Operation is subject to the following two conditions: (1) this device may not cause harmful interference, and (2) this device must accept any interference received, including interference that may cause undesired operation.**

---

**NOTE:** Your model camera has been tested and found to comply with the limits for a Class B digital device, pursuant to Part 15 of the FCC Rules. These limits provide reasonable protection against interference in residential use. The camera generates, uses and can radiate radio frequency energy and, if not used in accordance with the instructions, may cause interference to radio communications. There is no guarantee that interference will not occur. If this camera does cause interference to radio or television reception, which can be determined by turning the camera off and on, you may reduce the interference by the following:

- Reorient or relocate the receiving antenna.
- Increase the separation between the camera and the receiver.
- Consult the dealer or an experienced radio/television technician for help.

Changes or modifications not approved by the party responsible for compliance could void the user's authority to operate the equipment.

**This Class B digital apparatus meets all requirements of the Canadian Interference-Causing Equipment Regulations**



## **KODAK ADVANTIX 4700ix/4800ix Zoom Camera**

Welcome to the innovative world of the Advanced Photo System!  
And thank you for buying this KODAK ADVANTIX Camera.

### **Need Help with Your Camera?**

**Call:**

Kodak (USA only) toll free from 9:00 a.m. to 7:00 p.m. (Eastern time)  
Monday through Friday at 1 (800) 242-2424.

Kodak (Canada only) from 8:30 a.m. to 5:00 p.m. (Eastern time) Monday  
through Friday at 1 (800) 465-6325, ext. 36100; for the Toronto area, call  
(416) 766-8233, ext. 36100.

Visit our web site at <http://www.kodak.com>

---

**For warranty purposes, please keep your sales receipt as proof of  
the date of purchase.**



Look for this logo to be certain that the film you buy is made for this camera.



Look for this logo to select a certified photofinisher for developing your film and to assure that you get all the features of the Advanced Photo System.

### Film Status Indicator (FSI)

A highlighted indicator advances from one symbol to another to identify the status of the film inside the cassette.

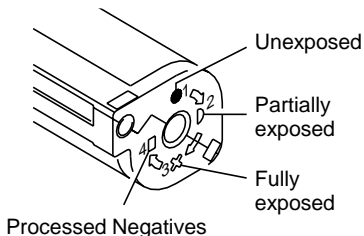

# Contents

Camera Identification .....	9	Using the “SELFTIMER” .....	18
Attaching the Strap .....	10	Date and Time Imprinting .....	18
Loading the Battery .....	10	<i>Setting the Date and Time</i> .....	18
<i>Low-Battery Indicator</i> .....	11	<i>Date and Time Formats</i> .....	19
<i>Battery Tips</i> .....	11	<i>Changing the Date and Time</i>	
<i>Power Shut-Off</i> .....	11	<i>Formats</i> .....	19
Loading the Film .....	12	Using the “SET DISPLAY” .....	20
Taking Pictures .....	13	Setting the Language .....	20
<i>Typical Print Sizes (Formats)</i> .....	13	Print Title Imprinting .....	21
<i>Using the Zoom Lens</i> .....	14	Roll Title Imprinting .....	21
Taking Flash Pictures .....	15	<i>Title-Select List</i> .....	22
<i>Flash-Lamp Signals</i> .....	15	Unloading the Film .....	23
<i>Flash-to-Subject Distance</i> .....	16	<i>Automatic Rewind</i> .....	23
Selecting Flash Modes and		<i>Using the Manual Rewind Button</i> ....	24
Infinity-Focus Mode .....	16	Caring For Your Camera .....	24
“FILL FLASH” .....	17	Troubleshooting .....	25
“INFINITY ” .....	17	Specifications .....	27
“FLASH OFF” .....	17		



# Camera Identification

*(Unfold the front and back cover flaps of manual for camera diagrams.)*

- |                                   |                                    |
|-----------------------------------|------------------------------------|
| <b>1</b> Zoom-Dial Lever          | <b>18</b> Enter Button             |
| <b>2</b> Shutter Button           | <b>19</b> Select Button            |
| <b>3</b> Lens Cover/Flash         | <b>20</b> Film-Rewind Button       |
| <b>4</b> Format-Selector Button   | <b>21</b> Menu Button              |
| <b>5</b> Viewfinder               | <b>22</b> Tripod Socket            |
| <b>6</b> Light Sensor             |                                    |
| <b>7</b> Lens                     |                                    |
| <b>8</b> Self-Timer Lamp          |                                    |
| <b>9</b> Auto-focus Windows       |                                    |
| <b>10</b> Strap Post              |                                    |
| <b>11</b> Battery Door            |                                    |
| <b>12</b> Viewfinder Eyepiece     |                                    |
| <b>13</b> Flash/Camera-Ready Lamp |                                    |
| <b>14</b> LCD Panel               |                                    |
| <b>15</b> Film Door               |                                    |
| <b>16</b> Film Chamber            |                                    |
| <b>17</b> Film-Door Latch         |                                    |
|                                   |                                    |
|                                   | <b><i>LCD Panel</i></b>            |
|                                   | <b>23</b> Infinity-Focus Indicator |
|                                   | <b>24</b> Battery Symbol           |
|                                   | <b>25</b> Text-Messaging Panel     |
|                                   | <b>26</b> Frame Counter            |
|                                   | <b>27</b> Film-Presence Indicator  |
|                                   | <b>28</b> Self-Timer Indicator     |
|                                   | <b>29</b> Fill-Flash Indicator     |
|                                   | <b>30</b> Flash Indicator          |
|                                   | <b>31</b> Off-Flash Indicator      |

## Attaching the Strap

1. Insert the shorter looped end of the strap behind the Strap Post (10).

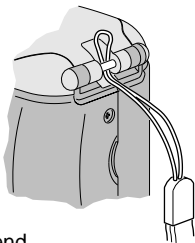

2. Thread the longer end of the strap through the shorter loop.

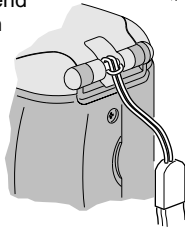

3. Pull the strap tight.

## Loading the Battery

This camera uses one 3-volt lithium KODAK K123LA (or equivalent) Battery that supplies power for all camera operations.

1. Open the Battery Door (11) by using your finger tip.

- Before you remove the old battery, close the lens cover/flash.

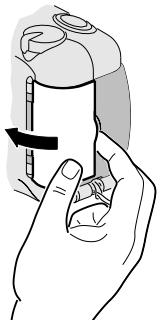

2. Insert the battery into the chamber as shown.

3. Snap the battery door closed.

- After you load a new battery into the camera, you will need to reset the date and time.

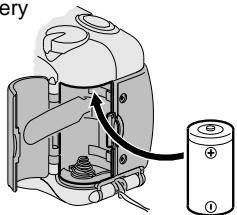

### ***Low-Battery Indicator***

It's time to replace the battery when—

- the Battery Symbol **(24)** “blinks” and the “**BATTERY LOW**” message appears on the LCD panel *or*
- none of the indicators, except for steady battery symbol, appears on the LCD panel and the shutter button cannot be released.

### ***Battery Tips***

- Remember to keep a spare battery with you at all times.
- Read and follow all warnings and instructions supplied by the battery manufacturer.
- Keep batteries away from children.
- Do not try to take apart, recharge or short circuit the battery, or subject it to high temperature or fire.
- Store batteries in their original packaging prior to use.

### ***Power Shut-Off***

To save battery power, the camera will automatically go into a sleep mode if it is not operated for more than 60 seconds. You can press the shutter button, zoom control, film-rewind, mode buttons or rewind button to awake the camera.

## Loading the Film

You can load film into the camera with the lens cover/flash opened or closed.

1. Turn the camera upside down and slide the Film-Door Latch (17) to automatically open the Film Door (15).
  - The film door will open only when the film chamber is empty or the film in the camera is completely rewound into the film cassette.

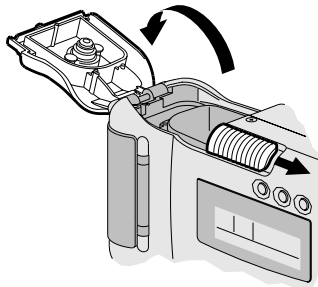

2. Insert the film cassette **completely** into the Film Chamber (16). Make sure the Film Status Indicator (FSI) on the film cassette is at ●.

- **Do not force the film cassette into the film chamber.**

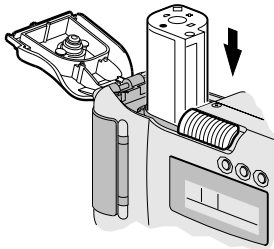

3. Close the film door to start the auto-film advance. The Frame Counter (26) on the LCD Panel (14) will show the number of frames remaining on the film cassette.
  - After you close the safety-interlock film door, you cannot open the door until the film is completely rewound into the film cassette.

# Taking Pictures

You can take Classic (C), HDTV (H), and Panoramic (P) pictures on the same film cassette (see the following table for **Typical Print Sizes**). Your photo-processing cost will be based on the format size(s) that you use to expose the film.

1. Lift the Lens Cover/Flash (3) up to uncover the Lens (7) and to activate the flash.

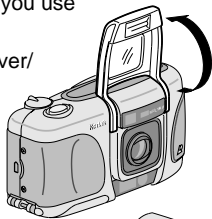

2. Press the Format-Selector Button (4) to the desired format (C, H, or P). The viewfinder will change to show the selected field of view.

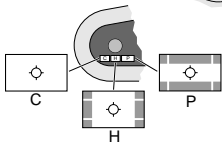
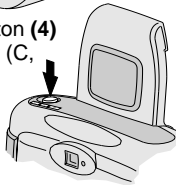

3. Frame your subject within the Viewfinder Eyepiece (12). For a sharp picture, **stand at least 2.5 ft (0.8 m) from your subject.**

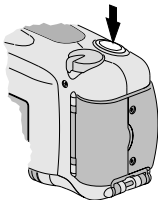

4. Partially depress the Shutter Button (2) until the Flash/Camera-Ready Lamp (13) turns green. Fully depress the shutter button to take the picture.

- Follow the instructions on the text-messaging panel when the flash/camera-ready lamp is red.

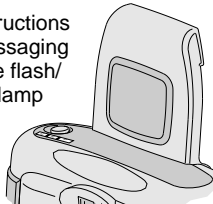

## Typical Print Sizes (Formats)

C	H	P
Classic	Group (HDTV)	Panoramic
3 1/2 x 5" or 4 x 6" (88.9 x 127 mm or 102 x 152 mm)	3 1/2 x 6" or 4 x 7" (88.9 x 152 mm or 102 x 178 mm)	3 1/2 x 8 1/2" to 4 x 11 1/2" (88.9 x 216 mm to 102 x 292.7 mm)

## Using the Zoom Lens

This camera has a motorized-zoom lens that lets you select the ideal lens-focal length for taking pictures. When you turn the camera on, it is initially set to the wide-mode position.

1. Lift the Lens Cover/Flash (3) up to uncover the Lens (7) and to activate the flash.
2. Slide the Zoom-Dial Lever (1) to the left to the wide-mode position to zoom *away* from the subject. Slide the lever to the right to the tele-mode position to zoom *closer* to the subject.

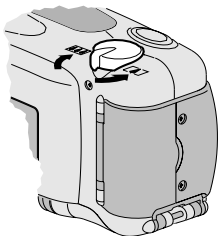

3. Frame your subject within the Viewfinder Eyepiece (12).
4. Partially depress the Shutter Button (2) until the Flash/Camera-Ready Lamp (13) turns green. Fully depress the shutter button to take the picture.
  - The lens barrel will automatically return to the wide-mode position after approximately 60 seconds.

## Taking Flash Pictures

In dim light, such as indoors or outdoors in heavy shade, or on dark overcast days, you need flash. Your camera features an automatic flash that fires when you need it. It also provides automatic daylight fill flash under certain bright-light conditions where shadows may exist. When you partially depress the shutter button and the flash-ready lamp glows green, the flash is fully charged and ready for picture-taking (see the following tables for **Flash-Lamp Signals** and **Flash-to-Subject Distance**).

1. Lift the Lens Cover/Flash (3) up to uncover the Lens (7) and to activate the flash.
2. Take the picture when the Flash-Ready Lamp (13) glows green.
  - The LCD panel will display “FLASH NOT READY” message when the flash is not fully charged.

3. Keep the subject within the distance range for the speed of film in your camera. Don't take pictures beyond the maximum distance or your pictures will be dark.

### Flash-Lamp Signals

Lamp Indicator	Situation
Glow green	Flash fully charged
“Blinks” red *	Flash not fully charged
Glow red	Subject closer than 2.5 ft (0.8 m)

\* A text message will appear on the LCD panel to inform the user the reason of warning.

### Flash-to-Subject Distance

ISO Film Speed	Wide (30 mm)	Tele (60 mm)
50	2.5 to 9 ft (0.8 to 2.7 m)	2.5 to 8 ft (0.8 to 2.4 m)
100	2.5 to 13 ft (0.8 to 4 m)	2.5 to 11 ft (0.8 to 3.4 m)
200	2.5 to 18 ft (0.8 to 5.5 m)	2.5 to 15 ft (0.8 to 4.6 m)
400	2.5 to 26 ft (0.8 to 7.9 m)	2.5 to 22 ft (0.8 to 6.7 m)
800	2.5 to 36 ft (0.8 to 11 m)	2.5 to 31 ft (0.8 to 9.4 m)
1600	2.5 to 52 ft (0.8 to 15.8 m)	2.5 to 44 ft (0.8 to 13.4 m)

## Selecting Flash Modes and Infinity-Focus Mode

Besides the “*AUTO FLASH*” mode, you can select “*FILL FLASH*,” “*INFINITY*,” and “*FLASH OFF*.”

Press the SELECT Button **(19)** until the desired indicator and corresponding text message appear on the LCD Panel **(14)**.

---

Flash modes and the infinity mode remain selected after you take the picture. To cancel the selection, close the lens cover/ flash or press the SELECT button to return to the standard point-and-shoot “*AUTO FLASH*” mode.

---



## **"FILL FLASH"** FILL

Bright light indoors or outdoors from backlit subjects can create dark shadows (especially on faces) in high-contrast scenes. Use fill flash to lighten these shadows.

1. Press the SELECT Button **(19)** until the **"FILL FLASH"** message and indicator appear on the LCD Panel **(14)**.
2. Frame your subject within the Viewfinder Eyepiece **(12)**.
3. Press the Shutter Button **(2)** to take the picture.

## **"INFINITY "**

For maximum sharpness of distant scenery at any zoom position, use the infinity feature (for outdoor use only).

1. Press the SELECT Button **(19)** until the **"INFINITY"** message and indicator appear on the LCD Panel **(14)**.
2. Frame your subject within the Viewfinder Eyepiece **(12)**.
3. Press the Shutter Button **(2)** to take the picture.

## **"FLASH OFF"** OFF

When you do not want to use the flash, especially indoors where flash is prohibited, such as in theaters and museums, or when you want to take twilight scenes or distant subjects that are beyond the flash range, or capture the ambiance of existing light, use the flash-off feature.

1. Press the SELECT Button **(19)** until the **"FLASH OFF"** message and indicator appear on the LCD Panel **(14)**.
2. Frame your subject within the Viewfinder Eyepiece **(12)**.
3. Press the Shutter Button **(2)** to take the picture.
  - Use a tripod and high-speed film because the shutter speed at night will most likely be slow.

## Using the “SELFTIMER”



You can include yourself in pictures by using the self-timer feature. The electronic self-timer will delay the release of the shutter button for approximately 10 seconds after you press the shutter button.

1. Place the camera on a tripod (Tripod Socket **[22]**) and press the ENTER Button **(18)**. The “SELFTIMER READY” message and indicator will appear on the LCD Panel **(14)**.
2. Frame your picture in the Viewfinder Eyepiece **(12)**.
3. Press the Shutter Button **(2)**. The Self-Timer Lamp **(8)** on the front of the camera will blink during the self-timer countdown.
  - To cancel the self-timer selection before the shutter releases, press the ENTER button or close the lens-cover flash.
  - The self-timer is automatically canceled after the shutter releases.

## Date and Time Imprinting

This camera has a quartz clock and automatic calendar through the year 2099.

Traditional cameras print date and/or time information directly onto the film. Your camera uses the film's magnetic data strip to record date and time information which your photofinisher imprints on the back of your photographs.

### *Setting the Date and Time*

1. Repeatedly press the MENU Button **(21)** until the LCD Panel **(14)** displays “SET DATE.”
2. Press the SELECT Button **(19)** to select the date function. The first two digits of the date will “blink.” Press the Zoom-Dial Lever **(1)** to the right or left to increase or decrease the number.

- Press the ENTER Button **(18)** to store the selected month and to activate the next “blinking” date option (follow steps 2 and 3 to complete your selection).
  - After you set the “date” or “time,” the LCD panel will display “DATE IS” or “TIME IS” followed by the selected date or time.
- Repeat steps 1–3 to choose and “SET TIME.”

### ***Date and Time Formats***

The date and time formats are automatically set for you according to the designated language listed below. If you want to change the automatic settings for date and time formats, see ***Changing the Date and Time Formats***.

	<b>Time Format</b>	<b>Date Format</b>
English	12 hour	month, day, year
German	24 hour	day, month, year
French	24 hour	day, month, year
Spanish	24 hour	day, month, year
Japanese	24 hour	year, month, day

### ***Changing the Date and Time Formats*** (*mm, dd, yy/ dd, mm, yy/ yy, mm, dd and 12/24 hour*)

- Repeatedly press the MENU Button **(21)** until the LCD Panel **(14)** displays “SET DATE FORMAT.”
- Press the SELECT Button **(19)** to make the selection. Press the Zoom-Dial Lever **(1)** to the right or left to increase or decrease the number.
- Press the ENTER Button **(18)** to store the selected format.
  - After you set the “date” or “time,” the LCD panel will display “DATE FORMAT IS” followed by the selected format.
- Repeat steps 1–3 to choose and “SET

## Using the “SET DISPLAY”

This feature will allow you to view one of three display formats:

### Example

“SHOW DATE TIME:”	03/21/97	12:00
“SHOW DATE/ISO:”	03/21/97	ISO 200
“SHOW TIME/ISO:”	ISO 200	12:00

1. Repeatedly press the MENU Button **(21)** until “*SET DISPLAY*” appears on the LCD Panel **(14)**.
2. Press the SELECT Button **(19)** to make the selection. To change the data option, use the Zoom-Dial Lever **(1)** to cycle to your selection.
3. Press the ENTER Button **(18)** to set the selected data option.

## Setting the Language

U.S. “*ENGLISH*” is initially set into the memory of this camera or you can change the language to “*DEUTSCH*” for German, “*FRANCAIS*” for French, “*ESPANOL*” for Spanish or [Katakana] for Japanese.

1. Press and **hold** the MENU Button **(21)** for 4 seconds until the “blinking” language appears on the LCD Panel **(14)**.
2. Press the Zoom-Dial Lever **(1)** to cycle to your selection.
3. Press the ENTER Button **(18)** to set the language.
  - After you set the language, the LCD panel will display “*LANGUAGE IS*” followed by the selected language.

## Print Title Imprinting

You can choose a print title from the **Title-Select List** and choose a language (see **Setting the Language**) before you take the picture. The title you select will be recorded on the film's magnetic data strip. At certified Advanced Photo System labs, the selected title will be printed on the back of the print.



1. Repeatedly press the MENU Button **(21)** until the LCD Panel **(14)** displays "SET PRINT TITLE."
2. Press the SELECT Button **(19)** to select "SET PRINT TITLE." Use the Zoom-Dial Lever **(1)** to cycle from one title to another.
3. Press the ENTER Button **(18)** to store the selected title.
  - After you set the title, the LCD panel will display "SET PRINT TITLE IS" followed by the selected title.

**NOTE: Print title selections will automatically cancel after 24 hours of camera inactivity.**

## Roll Title Imprinting

You can choose an additional roll title from the **Title-Select List** for the entire roll of film. Both the roll and print title will be imprinted on the back of the print.

1. Repeatedly press the MENU Button **(21)** until the LCD Panel **(14)** displays "SET ROLL TITLE."
2. Press the SELECT Button **(19)** to select "SET ROLL TITLE." Use the Zoom-Dial Lever **(1)** to cycle to another title selection.
3. Press the ENTER Button **(18)** to store the selected title.
  - After you set the title, the LCD panel will display "SET ROLL TITLE IS" followed by the selected title.

***Title-Select List***

<b>Title</b>	<b>Title</b>
<i>ANNIVERSARY</i>	<i>HOLIDAY</i>
<i>BAPTISM</i>	<i>HONEYMOON</i>
<i>BIRTHDAY</i>	<i>I LOVE YOU</i>
<i>CANADA DAY</i>	<i>INDEPENDENCE DAY</i>
<i>CHRISTMAS</i>	<i>MOTHER'S DAY</i>
<i>CONGRATULATIONS</i>	<i>PARTY</i>
<i>EASTER</i>	<i>REUNION</i>
<i>FAMILY</i>	<i>SCHOOL EVENT</i>
<i>FATHER'S DAY</i>	<i>SEASONS GREETING</i>
<i>FESTIVAL</i>	<i>THANK YOU</i>
<i>FRIENDS</i>	<i>THANKSGIVING</i>
<i>GRADUATION</i>	<i>TRIP</i>
<i>HALLOWEEN</i>	<i>VACATION</i>
<i>HANUKKAH</i>	<i>VALENTINE'S DAY</i>
<i>HAPPY NEW YEAR</i>	<i>WEDDING</i>

# Unloading the Film

## *Automatic Rewind*

The camera automatically rewinds the film into the cassette after the last exposure.

1. Wait for the film to completely rewind into the film cassette.
  - The “*FILM REWINDING*” message will appear on the LCD Panel (14) and the Frame Counter (26) will count down to “0.”
  - The empty Film-Presence Indicator (27) and “*REMOVE FILM*” message will appear on the LCD panel when the film is rewound. (The message will only appear when the lens cover/flash is up.)

2. Turn the camera upside down and slide the Film-Door Latch (17) to automatically open the Film Door (15).

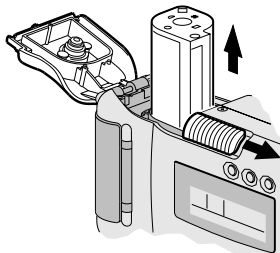

3. Remove the film cassette from the camera.
  - The FSI on the film cassette will be at **X**.

### ***Using the Manual Rewind Button***

If you don't want to take pictures on the entire roll of film, you can manually activate the automatic rewind.

1. Gently press the Film-Rewind Button (20) by using a pointed object to start the auto-film rewind.
2. Follow steps 1–3 from ***Automatic Rewind***.

**NOTE: You cannot reload partially exposed film into this camera for continuous picture-taking.**

## **Caring For Your Camera**

1. Protect the camera from dust, moisture, sudden impact, and excessive heat.

**CAUTION:** Do not use solvents or harsh or abrasive cleaners on the camera body.

2. If the lens appears dirty, breathe on it to form a mist and wipe the surface gently with a soft, lintless cloth or lens-cleaning tissue. Never wipe a dry lens.

**CAUTION:** Do not use solvents or solutions not designed for cleaning camera lenses. Do not use chemically treated tissues intended for cleaning eye glasses.

3. Remove the battery when you store the camera for an extended time.

**CAUTION:** To prevent possible damage and electrical shock, do not attempt to disassemble or repair the camera or flash unit by yourself.



# Troubleshooting

What happened	Probable cause	Solution
Camera will not operate	There are no more pictures remaining  Battery weak, dead, missing, or improperly loaded	Remove the film  Replace or reload the battery
Film does not advance or rewind	Battery weak, dead, missing, or improperly loaded	Replace or reload the battery
LCD panel is blank	Battery weak, dead, missing, or improperly loaded	Replace or reload the battery
LCD panel displays: "BATTERY LOW" "REPLACE BATTERY"  "FLASH NOT READY"	Battery weak Battery weak, dead, missing, or improperly loaded Flash not fully charged	Replace the battery Replace or reload the battery  Wait until the "FLASH NOT READY" message disappears or until the flash-ready lamp glows green

<b>What happened</b>	<b>Probable cause</b>	<b>Solution</b>
Flash/camera ready lamp “blinks” red	Flash not fully charged	Wait for lamp to glow green
Flash/camera ready lamp glows red	Subject closer than 2.5 ft (0.8 m)	See <b><i>Flash-to-Subject Distance</i></b> on page 11
Film cassette does not fit completely into the film chamber; film door does not close	Loaded exposed, or processed film into the camera	Load only unexposed film into the camera

# Specifications

<b>Film Type:</b>	KODAK ADVANTIX Film for color pictures
<b>Lens:</b>	Autofocusing 30–60 mm motorized zoom lens, 5-elements/2-group construction, glass aspheric
<b>Focus System:</b>	Passive multi-spot AF
<b>Focus Range:</b>	C, H, & P: Wide/Tele: 2.5 ft – $\infty$ (0.8 m – $\infty$ )
<b>Viewfinder:</b>	Real image with C, H, & P format display
<b>LCD:</b>	Text display with camera-status information and warnings
<b>Film-Speed:</b>	DXIX (ISO) 50–1600 for color films
<b>Flash Unit:</b>	Built-in, KODAK SENSALITE™ Flash
<b>Flash Range: (ISO 200)</b>	Wide: 2.5–18 ft (0.8–5.5 m) Tele: 2.5–15 ft (0.8–4.6 m)
<b>Apertures:</b>	<i>f/5.9–f/6.9</i>
<b>Shutter:</b>	Programmed auto-exposure electronic
<b>Power Source:</b>	Main power: one 3 V lithium KODAK K123LA (or equivalent) Battery
<b>Dimensions:</b>	121 mm X 67 mm X 43.5 mm
<b>Weight:</b>	8.1 oz (230 g) without film or battery

Kodak, Sensalite, Advantix, and the Advanced Photo System symbol and logotype are trademarks.



Consumer Imaging  
EASTMAN KODAK COMPANY  
Rochester, NY 14650

© Eastman Kodak Company, 1997

Pt. No. **917 4459**

28

11-97  
Printed in U.S.A.