



MOTOROLA™

iDEN®

Digital Multi-Service Phone

i500plus User's Guide

PATENT AND TRADEMARK INFORMATION

This product is protected under one or more of the following patents:

4817157, 4896361, 4857928, 5041793, 5060294, 5066923, 5134718,
5140156, 5239963, 5257411, 5287387, 5265219, 5289504, 5316168,
5317247, 5338396, 5389927, 5406588, 5424921, 5457376, 5460906,
5551063, 5557079, 5596487, 5615412, 5638403, 5559468, 5469465,
5170413, 5140615, 5519730, 5241544, 5584059, 5574992, 5396656,
5487091, 5533004, 5299199, 5343499, 5369501, 5509031, 5515379,
5528723, 5598417, 5066923, 5241650, 5278833, 5359696, 5548631,
5410632, 5440582, 5457735, 5457818, 5471670, 5477550, 5481537,
5566181, 5229767, 5208804, 5295140, 5381449, 5440590, 5467398,
5490230, 5620242, 5623523, 5655913, 5715240, 5771440, 5854578,
5675281

Additional patents are pending.

®, Motorola, iDEN, Call Alert, and Message Mail are trademarks or registered trademarks of Motorola, Inc.

®Reg. U.S. Pat. & Tm. Off.

T9 Text Input is a trademark of Tegic Communications.

All other trademarks mentioned in this manual are trademarks of their respective companies.

CONTENTS

Welcome	1
Features of Your <i>i500plus</i>	2
Attaching and Charging the Battery	4
Turning On Your <i>i500plus</i>	5
Turning Off Your <i>i500plus</i>	5
Display Icons	6
About Modes and Menus	7
Changing the Display Language	7
Making Phone Calls	8
Using Other Dialing Methods	8
Emergency Dial	9
Automatic Redial	9
Last Number Redial	9
Receiving a Phone Call	10
What Is My Phone Number?	10
Setting the Ringer Volume	10
Selecting a Ring Style	10
Call Forwarding	11
Unconditional Call Forwarding	11
Conditional Call Forwarding	12
Call Waiting	13
Call Hold	13
Creating, Editing, and Using Stored Lists	14
Quickstore of Phone Numbers	17
Making Private Calls	18
Receiving a Private Call	19
Private/Group Mode Speaker	19
Call Alert™	19
Sending a Call Alert	19
Receiving a Call Alert	20
Call Alert Queuing	20
Quickstore of Private IDs	21
Storing Your Private ID	22
Making Group Calls	23
Receiving a Group Call	23
Adding and Storing a Talkgroup	24
Area Selection	24
Private/Group Mode Speaker	24

Using Mail Services	25
Net Mail	25
Voice Mail	26
Message Mail	27
Saving and Erasing Mail	27
Auto Call Back	27
Mail Memory Full	28
Using Your Phone as a Modem	29
Programming Menus	30
About Status Messages	36
Accessories	37
Batteries	37
Travel Chargers	38
Using the Standard Travel Charger	38
Using the Rapid Travel Charger (110V/220V/240V)	38
Vehicular Battery Charger	39
Desktop Dual-Pocket Charger	40
Audio Adapter	43
Dash Mount Holder	44
Swivel Belt Clip	45
Leather Carry Case with Clear Plastic Cover	45
Hands-Free Car Kit	46
Safety and General Information	48
Exposure To Radio Frequency Energy	48
Interference to Medical and Personal Electronic Devices	49
Pacemakers	49
Hearing Aids	49
Other Medical Devices	50
Interference to Other Electronic Devices	50
Use While Driving	50
Operational Warnings	51
Potentially Explosive Atmospheres	51
Batteries	51
Blasting Caps and Areas	51
For Vehicles Equipped with Air Bags	51



Operational Cautions 52
 Damaged Antennas 52
 Batteries 52
Cleaning Instructions 52
Antenna Considerations 52
Accessory Safety Information 53

Owner's Information 55

WELCOME

Congratulations on purchasing your Motorola iDEN *i500plus* data-capable, multi-service, digital portable phone. Superior features and state-of-the-art technology help to keep you in constant touch with all your business and personal contacts.

The *i500plus* offers:

- **Phone Mode**—for cellular phone operation.
See page 8.
- **Private Mode**—for two-way radio use to talk with one person.
See page 18.
- **Group Mode**—for two-way radio use to talk with several people.
See page 23.
- **Mail Services**—for message, voice, and net mail.
See page 25.

Optional Features

With optional wireless access to the Internet, you can check on the latest news and weather, get stock quotes, send and receive e-mail, and download information from your computer. Wireless features include:

- **Net Mode**—to access the built-in microbrowser.
- **Fax and Data Transfer**—to send and receive faxes and transfer files.
- **TTY Access**—for assisting hearing-impaired users. See the *Wireless Data Services User's Guide* for information about data calls and TTY access.

NOTE : This guide describes the features of the *i500plus* as they were set up by Motorola. However, your carrier or your organization may have changed or added features. For more information, check with your carrier or your organization.

This manual provides information about how Net Mode works with various features of your *i500plus*. For information on using the microbrowser and other components of Net Mode, see the *Net Mode User's Guide*.

Features of Your i500plus

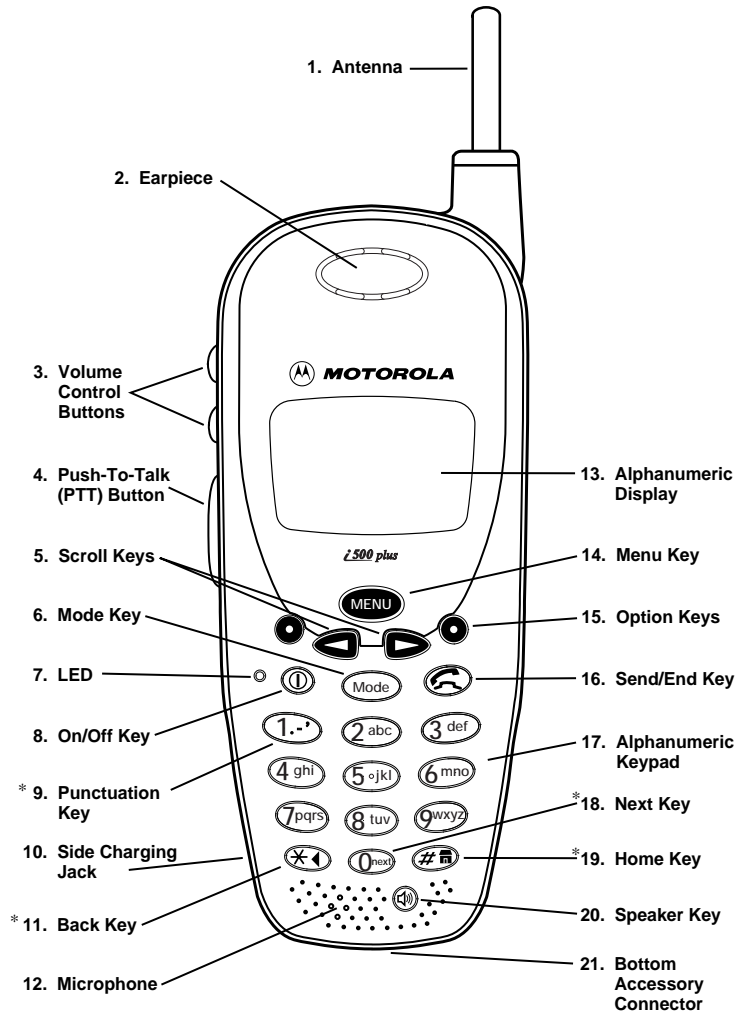

***These features are available in the Net Mode browser.**

- NOTE :**
- Remove the plastic lens protector from the display before initial use.
 - Some keys have multiple uses. For more information, see the *Net Mode User's Guide*.
 - Press any key or button to turn on the keypad backlight.

1. Antenna	Extend for optimal signal.
2. Earpiece	Hold to your ear to hear the other party.
3. Volume Control Buttons	Press to adjust volume levels in Phone, Private, and Group modes.
4. Push-To-Talk (PTT) Button	Transmit a Private or Group Call, or a Call Alert. Press and hold the PTT button to talk; release it to listen.
5. Scroll Keys	Press the left key to scroll backward or the right key to scroll forward through menu options and lists.
6. Mode Key	Press to change modes.
7. LED (Light Emitting Diode)	Check the phone's status. See <i>Table 2 on page 5</i> for more information.
8. On/Off Key	Press and hold to turn your <i>i500plus</i> on or off.
9. Punctuation Key	Add punctuation in the Net Mode browser (within T9™ Text Input).
10. Side Charging Jack	Attach charging accessories.
11. Back Key	Return to the previous browser screen.
12. Microphone	Use to speak during calls.
13. Alphanumeric Display	View up to four lines (12 characters per line) or six lines (16 characters per line) on the display.
14. Menu Key	Press to scroll through menu options.
15. Option Keys	Press the right or left option key to select the menu option that appears directly above the key.
16. Send/End Key	Press to answer an incoming Phone call. After entering a phone number, press to begin an outgoing Phone call or to redial the entered phone number. Press to end Phone calls.
17. Alphanumeric Keypad	Enter telephone numbers, Private Call IDs, and alphanumeric characters.
18. Next Word Key	Press to display the next word choice in the browser (within T9 Text Input).
19. Home Key	Press to return to the browser Home menu.
20. Speaker Key	Press to hear incoming calls through the earpiece or the speaker during private and group conversations.
21. Bottom Accessory Connector	Connect accessories and the data cable.

Attaching and Charging the Battery

Attaching the Battery

1. Release the lock located at the bottom of the battery door by pressing up on the latch, and remove the door.
2. Insert the battery with the "+" and "-" at the top, per the figure. Install the battery bottom first, then press down on the battery to secure it.
3. Replace the battery cover and lock by pressing down on the latch.

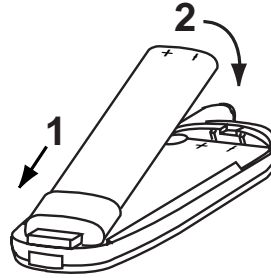

Detaching the Battery

1. Release the battery door by sliding the battery door latch upward.
2. Remove the battery door housing and remove the battery from the phone.

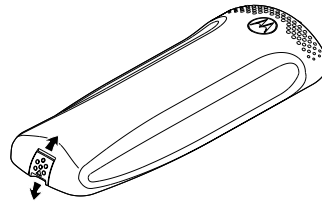

Charging the Battery with the Standard Travel Charger

Attach the Charger to the *i500plus* via the Side Charging Jack, and plug the Charger into an electrical outlet. For more information about Chargers, see "Accessories" on page 37.

To get the maximum use from the battery, charge it overnight before you use it for the first time. See *Table 1* for battery charging status.

Battery and Charging Status

A low battery is indicated by a short, chirp-like sound through the speaker. The battery strength indicator icon shows the remaining charge in your battery. Three bars indicate full charge. As the charge is reduced through use, the bars disappear. The indicator flashes when you have less than five minutes of talk time.

Table 1: Battery Charging Status

	Icon Flashes				
Charging	Low Battery	0-30%	31-60%	61-90%	91-100%
Discharging	Low Battery	0-10%	11-40%	41-70%	71-100%

Turning On Your *i500plus*

Press the On/Off button  until a set of icons appears on your display. Next, a welcome message displays while the *i500plus* connects to your carrier's network.

The LED indicator on the *i500plus* shows the service state. See *Table 2*.

Table 2: LED Indicator

Status Light Indicator	<i>i500plus</i> Phone Status
Flashing Red	Registering—your <i>i500plus</i> is signing on to your carrier's network. Please wait.
Solid Red	No service—your <i>i500plus</i> cannot sign on because it is outside your carrier's service area.
Flashing Green	In service—your <i>i500plus</i> is ready to use. You can now place and receive calls.
Solid Green	In use—your <i>i500plus</i> is currently being used. To make sure that you ended the last call, press  .

Turning Off Your *i500plus*

Press and hold the On/Off button  until you see the message "Powering Off".

Display Icons

After you turn on the phone, display icons appear on the screen to inform you of existing conditions. See the following list.

The following icons may appear on the display.



Signal Strength Indicator

Shows the signal strength. Six bars indicate the strongest signal. Calls and messages may not be sent or received when there is no signal.



Battery Strength Indicator

Shows the remaining charge in your battery. Three bars show full charge. The indicator flashes when you have less than five minutes of talk time remaining.



Voice Mail

Indicates that you listened to but did not save or delete messages. This icon flashes when unplayed messages are waiting in your voice mailbox.



New Message Mail

Indicates that you have new text messages in your mailbox.



Unread Message Mail

Indicates that you have unread text messages.



Call Forward

Indicates that incoming phone calls are being forwarded.



Private/Group Speaker

Indicates that the Private/Group speaker is off. You will hear calls through the earpiece.



Optional: Packet Data

Indicates packet data registration. The blinking arrows indicate send and receive activity. For more information, see the *Wireless Data User's Guide*.

Some of the following icons may appear on the last line of the display.



Optional: Secure Packet Data Connection

Indicates that your packet data information is encrypted during transmission.



More Information

Indicates that there is more text to read above, below, or above and below the current screen.

About Modes and Menus



Modes and menus are the navigational tools, providing access to the various features of your *i500plus*. There are four modes:

- **Phone**—For cellular phone calls. See page 8.
- **Private**—for one-to-one radio calls. See page 18.
- **Group**—For radio calls with all individuals in a designated talkgroup. See page 23.
- **Net**—(optional) for browser use. See the *Net Mode User's Guide*.

To change modes, press .

Menu choices within each mode provide access to the various features of your *i500plus*.







To select menu options:

- (1) Press  until you see the desired menu option.
- (2) Press  under the desired menu option.

Changing the Display Language

You can customize your *i500plus* to display one of four languages: English, French, Spanish, or Portuguese.

To change the displayed language:

1. Press , , , .
2. Select “Ok”.
3. Press  or  to scroll through the language options.

Selecting “Exit” at any time retains the current language selection.

4. When the desired language appears on your display, select “Ok”. The displayed text immediately changes to the selected language.
5. Select “Exit”.



The language you select will be the displayed language.

MAKING PHONE CALLS



In addition to making and receiving phone calls in Phone mode, you can forward calls, use call waiting, put calls on hold, and create and use stored lists. Phone Ready is the main screen.

You can place a call by entering the phone number on the keypad.

1. From the "Phone Ready" screen, using the keypad, enter the desired number.

If you make a mistake, press  once to move back one digit, or select "Cancel" to start over.







2. Press  to place the call.
3. To end the call, press .



Using Other Dialing Methods

To use Scroll, Speed Dial, or Name Search, names and numbers must be programmed into your phone. See "Creating, Editing, and Using Stored Lists" on page 14.





Scroll

1. From the Phone Ready screen, press  or  to scroll backward or forward through the stored list of numbers and names.
2. Press  to place the call.
3. To end the call, press .

Speed Dial



1. From the Phone Ready screen, press  until you see the "Spd#" option on the last line of your display.
2. Select "Spd#".
3. Enter the assigned speed-dial number (1-100). You will see the stored name and phone number associated with the speed dial number.
4. Press  to place the call.
5. To end the call, press .

Name Search

1. From the Phone Ready screen, select “Name”.
2. Using the keypad, enter the first letter of the desired name, for example, to search for the name Bob:
 - a. Enter “B” by pressing  twice.
 - b. Press  to scroll through all the names starting with “B” until you see “Bob”.
3. Press  to place the call.
4. To end the call, press .

Emergency Dial

You can dial the emergency phone number even if the keypad is locked. If you are on an active call, you must end it before using the emergency number.

1. From any mode (Phone, Private, Group, or Net), press and hold  for two seconds until the phone displays “EMERGENCY”. The phone then automatically dials the emergency number.
2. To end the call, press . *The emergency phone number will not be saved as the last number dialed.*

NOTE : For more information on the Emergency Dial feature, contact your carrier.





Automatic Redial

If you receive a “System Busy, Try Later” message, press  to have your phone automatically redial the number. You will hear a ring-back tone when the call is successful.

Last Number Redial



To redial the last number that you called, press .

Receiving a Phone Call

- Press one of the following keys: , , or . Or, press any numeric key (0 through 9).
- To end the call, press .







What Is My Phone Number?

Press , ,  to display your phone number



Setting the Ringer Volume

You can adjust the ringer volume for incoming calls.

1. Press , ,  (def),  (next). The “30=Ringer Volume” screen displays. The display shows your current ringer volume.
2. Press the Volume Control buttons on the side of the phone to listen as you raise or lower the volume. At the lowest setting, the screen displays “Volume Silent”.
3. When you reach the desired level, select “Exit”.



Selecting a Ring Style

Your phone has nine selectable ring styles.



Incoming circuit data calls have a unique, preset ring style which you cannot change.

Setting a Ring Style

1. Press , ,  (def), .

The display shows your current ring style.



2. Select "Ok".
3. Press  or  to scroll through the available ring styles.
4. To listen to the selected ring style, press the Volume buttons on the side of the phone.
5. Select "Ok" to select the ring style shown.
To leave the ring style unchanged, select "Cancel".
6. Select "Exit".



Call Forwarding

Call forwarding lets callers reach you wherever you are. You have two options: forward all incoming calls (unconditional) or select those circumstances (conditional) when you want your calls forwarded.

Unconditional Call Forwarding

Unconditional call forwarding sends all incoming calls to the designated number.

NOTE : When you set unconditional call forwarding, your phone does not ring.

1. From the "Phone Ready" screen, press  until you see "Forwd" on the last line of the display.
2. Select "Forwd".
3. To select the number where you want your calls forwarded, do one of the following:
 - Enter a number.
 - Or, press the scroll keys to select a number from your stored list.
4. Select "On".
5. After the "Please Wait" message displays, Select "Exit".



Notice that the Call Forward icon  appears on your display when Unconditional Call Forwarding is set.

Conditional Call Forwarding

You may want to forward your calls when your *i500plus* is:

- Busy on another call or the browser (Busy)
- Not answered (NoAns)
- Outside the service area (NoRch)

NOTE : You must turn off Unconditional Call Forwarding before you can set Conditional Call Forwarding options.

1. From the Phone Ready screen, press **MENU** until you see “Forwd” on the last line of the display, then select it.



2. Press **MENU** again until you see “Busy” and “NoAns” on the last line of your display.

- To forward your calls when your phone is in use, select “Busy”.
- To forward your calls when you do not want to answer them, select “NoAns”.



3. Press **MENU** until you see “NoRch” and “Rcl#”.

- To forward your calls when you cannot be reached, select “NoRch”.
- To see the call forward number, select “Rcl#”.



4. After you select the call forward option, either enter the number where you want your calls to be forwarded, or press the scroll buttons and select a number.
5. Select “On”.
6. Select “Exit”.

You can set more than one condition by repeating steps 2 through 6.

Call Waiting

Using the Call Waiting feature, you can answer an incoming call when you are on another call. Call Waiting is on unless you turn it off for a particular call.

1. After the alert tone, your display shows the incoming number and asks “Take Call?”. To accept the call, select “Yes”. To decline the call, select “No”.

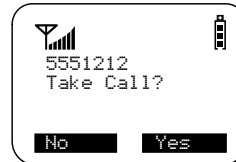

2. Select “Hold” to place the second call on hold and return to the first call.



Selecting “Hold” switches you between the two calls.

3. To end the active call, press .



Turning Off Call Waiting

You can turn off Call Waiting if you do not want to be interrupted during a call.

1. Press  until you see “Wait”, then select “Wait”.
2. Press  under “Off”. Call Waiting will be disabled for one call—but will automatically reset to “On” after that call.

Call Hold

When you are on a call, you can place the call on hold and make a second call.

1. To place the active call on hold, select “Hold”. You can then answer or place another call.
2. To remove the call from hold, select “Hold” again.

Creating, Editing, and Using Stored Lists

A stored list is a directory of phone numbers and Private IDs and their related names. Stored lists are convenient because you do not have to remember names and numbers—you simply scroll through your stored list.

Combined Phone Number and Private ID List

You can set a combined Phone and a Private ID with the associated name, which eliminates the need to program the Private ID separately. You can add up to 100 numbers to your Phone list, store them with names, and assign them to speed-dial numbers.

Entering Numbers

To enter a number, press the corresponding key on the keypad.

Entering Names

To enter a letter, press the key the required number of times, which is related to the letter's position on the key. Table 3 describes how to enter each letter on the **7pqrs** key.

Table 3: Entering Letters and Numbers on the Keypad

To enter:	Press 7pqrs
P	once.
Q	twice.
R	three times.
S	four times.
7	five times

To shift to lowercase letters, press and hold **#** after you enter a letter.

Storing Names and Numbers

1. Press *****, **#**, **2abc**, **0next**.
2. Select "Ok".



The next screen briefly displays the remaining number of phone numbers and Private IDs that you can store.



3. Enter the name that you wish to store.
4. Select "Store".

See Table 4 for an example of entering a name.



Table 4: Entering a Name

To store the name "TIM":

1. Enter "T" by pressing (8 tuv) once.
2. Enter "I" by pressing (4 ghi) three times.
3. Enter "M" by pressing (6 mno) once.

5. Enter the phone number that you want to associate with this name and select "Store".

To skip the Phone Number entry, select "Skip". You will go directly to the "Enter Prvt ID Number" screen.



The next screen displays the name that you entered and a flashing speed-dial number where the entry will be stored.

6. Do one of the following:
 - To accept the speed-dial number shown, select "Store".
 - To change the speed-dial number, enter the desired speed-dial number. The speed-dial number stops flashing.











7. At the next screen, enter the Private ID number associated with the name that you entered, then select "Store".







To skip the Private ID number entry, select "Skip."



Editing and Erasing Phone List Entries

1. Press , , , .
2. Select "Ok". The "Edit Entry" screen displays.
3. Do one of the following:
 - To edit an entry, select "Ok":
 - (1) At the "Edit Entry?" screen, press  or  until the desired entry appears, then select "Ok".
 - (2) At the "Edit Number" screen, edit the phone number, if you wish; then select "Store".
 - (3) At the "Edit Name" screen, edit the name, if you wish; then select "Store".
 - (4) At the "Edit Spd#" screen, edit the speed number, if you wish; then select "Store".
 - To erase an entry:
 - (1) At the "Edit Entry?" screen, press  or .
 - (2) At the "Erase Entry?" screen, select "Ok".
 - (3) Scroll to the desired entry, then select "Ok". At the "Erase?" screen, select "Yes".
4. Select "Exit" to close the Phone List Edit screen.

Editing and Erasing Private ID List Entries

1. Press , , , .
2. Select "Ok". The "Edit Entry?" screen displays.
3. Do one of the following:
 - To edit an entry, select "Ok".
 - (1) At the "Edit Entry?" screen, press  or  until the desired entry appears, then select "Ok".
 - (2) At the "Edit ID" screen, edit the number, if you wish, then select "Store".
 - (3) At the "Edit Name" screen, edit the name, if you wish, then select "Store".

- To erase an entry:
 - (1) At the “Edit Entry?” screen, press ◀ or ▶ once, then select “Ok”.
 - (2) Press ◀ or ▶ to scroll to the desired entry, then select “Ok”.
 - (3) At the “Erase?” screen, select “Yes”.
- 4. Select “Exit” to close the Private ID List Edit screen.

Quickstore of Phone Numbers

You can use Quickstore to store the last number that you dialed without having to enter the programming menu.

If the last number that you dialed is not currently stored in your Phone Call list, the “Store” option will be available.

To use Phone Number Quickstore, from the Phone Ready screen:

1. Press ▶ to see the last number you dialed.



2. Select “Store”. The “Enter Name” screen displays.



3. Enter the name, then select “Store”.



The combined name and number entry is stored in the first available storage space.



MAKING PRIVATE CALLS

A Private call is a one-to-one conversation between two people. In Private mode, each *i500plus* is identified by a name or a number called a Private ID.

To make a Private Call:

1. Press **Mode** until you see "Prvt Ready" on your display.
2. Use the keypad to enter the Private ID of the person that you want to reach.
3. To speak, press and hold the PTT button, wait for the chirp, then speak into the microphone.
4. To listen, release the PTT button.



To use Scroll or Name Search, you must have a Private ID list.

Scroll

1. Press **Mode** until you see "Prvt Ready" on your display.
2. Press **Left Arrow** or **Right Arrow** to scroll through the stored Private ID list.
3. Press and hold the PTT button, wait for the chirp, then speak into the microphone.

Name Search

1. Press **Mode** until you see "Prvt Ready" on your display.
2. Select "Name".
3. Press the key with the first letter of the name you are searching for.
4. Press **Left Arrow** or **Right Arrow** to scroll through other stored names associated with the letter you entered.
5. Press and hold the PTT button, wait for the chirp, then speak into the microphone.

Receiving a Private Call

When you receive an incoming Private call, you hear a brief chirp-like tone. Your *i500plus* automatically switches to Private mode, and the Private ID or the name of the caller displays.

1. Your phone must be idle, that is, not busy in an active call or on the browser.
2. Wait for the caller to finish speaking.
3. Press and hold the PTT button. Begin speaking after you hear the chirp.

Private/Group Mode Speaker





You can hear Private calls through either the earpiece or the speaker. Press the Speaker button  on your *i500plus* to turn the Private/Group Mode Speaker on or off.

- With the Speaker on, you will hear incoming calls through the speaker.
- With the Speaker off, you will hear incoming calls through the earpiece.

Call Alert™

Call Alert enables you to page an individual by sending an audible tone. A Call Alert allows the individual to respond when it is convenient. The alert plays intermittently until the individual clears it.

Sending a Call Alert

1. Press  to go to the “Prvt Ready” screen.
2. Select “Alert”.
3. Enter the Private ID, or press  or  to scroll to the desired name. You may also select the name by pressing  and using Name Search.
4. Press the PTT button.



Receiving a Call Alert

When you receive a Call Alert, you will hear an alert tone and see a message on your display.

- To answer the Call Alert, press the PTT button.
- To clear the Call Alert without answering it, select “Clear”.
- To silence the Call Alert without clearing it, press any key other than the PTT button.

NOTE : Until the Call Alert is cleared or returned, the alert plays intermittently and you will not be able to receive any additional Phone, Private, Group, or Net calls.

Call Alert Queuing

If your carrier provides Call Alert Queuing, you can save up to eight Call Alerts in a queue for later use.

After you respond to the Call Alert, it is removed from the queue.

Clearing or Queueing a Call Alert

When you receive a Call Alert, do one of the following:



- To clear a Call Alert, select “Clear”.
- To place the Call Alert into the queue, select “Queue”. Pressing  also queues the Call Alert.



If you receive multiple Call Alerts, the last received Call Alert displays and the remaining Call Alerts are stacked at the beginning of the queue.

Responding to a Queued Call Alert

You can respond to the Call Alerts in any order. To select a Call Alert for response:

1. Select “Queue”.
2. Press  or  to scroll to the desired Call Alert.
3. Press the PTT button to respond to the Call Alert.

Quickstore of Private IDs

Quickstore allows you to quickly store a received or sent Private ID, without having to enter the programming menu.

The ID is added as the last number received or sent in Private mode.

From the Private Ready screen, with the Private ID displayed:

1. Select “Store”.

If an ID is greater than 12 characters in length, the ID wraps to the third line.



2. Enter the name associated with the Private ID.



3. Select “Store”. The Stored message displays.

If the list is full with the maximum 100 entries, you will get the message, “Prvt List Full”. You cannot add names until you remove some names from the list.



4. Next, the display returns to the Private Ready mode.



Storing Your Private ID

To store your Private ID in your *i500plus*:

1. Press ***←**, **#**, **2 abc**. The screen displays the message, "2=Own Pvt ID".
2. Select "Ok".
3. Enter the Private ID provided by your carrier.
4. Select "Store".

To view your Private ID at any time after you store it:

1. Press ***←**, **#**, **2 abc**. The screen displays the message, "2=Own Pvt ID". The next line displays your Private ID. *This is the number supplied by your carrier that you store in your phone.*
2. Select "Exit".

MAKING GROUP CALLS

A Group Call allows you to communicate instantly with members of a selected Talkgroup—a pre-defined set of people who share a communication need.

Talkgroups appear on your display as numbers or programmed names, such as Talkgrp10 or Sales Team.

To make a Group Call:

1. Press **Mode** until “Group Ready” displays. Your most recently used talkgroup displays, for example, “Talkgrp 10”.
2. To place a call, do one of the following:
 - To speak to this talkgroup, press and hold the PTT button. Wait for the chirp, then speak into the microphone.
 - To speak to another talkgroup, press **◀** or **▶** until you see the desired talkgroup name. Press and hold the PTT button. Wait for the chirp, then speak into the microphone.
3. To listen, release the PTT button.



Receiving a Group Call

When you receive an incoming Group call, you will hear a brief chirp-like tone. Your *i500plus* automatically switches to Group mode, and the Talkgroup name displays.

1. Your phone must be idle, that is, not busy in an active call or on the browser.
2. Wait for the caller to finish speaking, then press and hold the PTT button. Begin speaking after you hear the chirp.
3. To listen, release the PTT button.

You can receive group calls only in the Talkgroups that you have predefined. *For more information, see “Adding or Storing a Talkgroup” on page 24.*

Adding and Storing a Talkgroup

To add and store a talkgroup name to your *i500plus*:

1. Press , , , .
2. Select "Ok".
3. At "Add New Entry?", select "Ok".
4. At "Enter ID", enter the desired talkgroup number and select "Store".
5. At "Enter Name", enter a name for the talkgroup and select "Store".

Area Selection

In Group mode, you can call only those talkgroup members in a specific location. This is useful when you know where the individuals are located within the service area.

1. Press until you see "Group Ready" on your display.
2. Press , then select "Area".
3. Press or to scroll through the targeted areas specified by your local carrier.
4. Select "Ok" to select the targeted area.

Private/Group Mode Speaker

You can hear Group calls through either the earpiece or the speaker.

Press the Speaker button on the *i500plus* to turn the Private/Group Mode Speaker on or off.

With the Speaker on, you will hear incoming calls through the speaker. This is useful to monitor talkgroup activity in Group mode.

With the Speaker off, you will hear incoming calls through the earpiece.

USING MAIL SERVICES

Your *i500plus* provides the following mail services:

- Net Mail™
- Voice Mail
- Message Mail

When you receive a new message, the  icon appears and flashes.

- To read your new mail immediately, select “Now”.
- To read your new mail later, select “Later”.



*An asterisk * next to a mail service indicates new mail.*

To use message services, select “Mail” from any Ready screen. The inbox screen opens with your message services listed.

To select a message service, scroll to highlight the service or press the corresponding number. For example, to access your Message Mail, press 2.



Net Mail

If you subscribe to the optional Net mode feature, Net Mail alerts you when you receive alerts from the Browser. For example, notification of an e-mail or fax.

From any mode:

1. Select “Mail”
2. Select “Net Mail”, then select “Ok”.

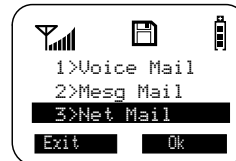

The Alerts inbox opens and displays the type of Net mail alerts.

3. Scroll to the type of alert that you wish to view, then select “Ok”.



4. The details of the alert type displays.
To read the message, select "View".



5. After you read the message, do one of the following:

- Select "Menu" to view a list of actions that you can take for this message, such as reply, delete, save, and so forth.
- Or, select "Next" to read the next message.



Voice Mail

When your *i500plus* receives a Voice Mail message:

- The  icon appears on your display.
- The Voice Mail alert tone sounds (if Mail Notification is turned on).
- The message, "New Voice Mail Waiting" appears on your display.
- An exclamation point (!) on the display indicates that you have at least one urgent message.

From any mode:

1. Select "Mail".
2. Select "Voice Mail".



The Voice Mail inbox opens and displays the number of your new and total Voice Mail messages.

To retrieve your voice mail immediately:

1. Select "Dial". This action automatically places a call to your voice mailbox. The most recent message is retrieved first.
2. To close your voice mailbox, select "Exit".

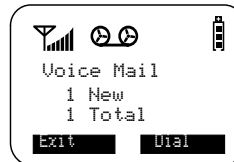

Message Mail

Message Mail can be either a numeric page or a text message of up to 140 characters. Your phone can receive and store 16 mail messages at any time.

1. To postpone reading your mail and to clear the display, select “Later”. The icon stops flashing but remains on your display to remind you that you have unread messages.

To read you mail now:

2. To read your mail now, select “Now”. The screen will briefly display the number of new and saved messages in your mailbox.
3. A list of all your messages will display. Highlight the message that you wish to read and select “Read”.

To read you mail later:

4. From any mode, select “Mail”. The Mailbox opens.
5. Select “Mesg Mail”.



Your message mailbox opens and briefly displays the number of new and saved messages currently in your mailbox.



6. Next, a list of all messages will display. Select the message that you wish to read and select “Read”.



Saving and Erasing Mail

Your message shows the time and date that the sender entered it in the network

After you read a text or numeric message, you can either Save or Erase the message. Press  under the desired option.



Auto Call Back

You can respond to numeric pages and text messages containing a call-back number. To automatically dial a number contained within a Message Mail, press .

Mail Memory Full

If all 16 message registers are full, your phone displays the message "Mail Waiting, Memory Full". You cannot receive new Message Mail until you empty register space by erasing saved or unread messages.

USING YOUR PHONE AS A MODEM

You can use your *i500plus* as a modem for data transfer from your laptop, handheld device, or desktop computer. This is particularly useful when there is no wired phone line (wall jack) available.

You simply attach a data cable to your phone and your computer. From that point, your phone is your modem. This allows you to send or receive time-critical information such as e-mail, a field service report, or files. In addition, you can also send or receive faxes.

This type of wireless connection uses one of two types of data connection: circuit-switched data and packet data.

- Circuit-switched data is typically used for sending and receiving faxes and for transferring large files.
- Packet data is used for small file transfers such as e-mail.



To use these services, you must install the iDEN Wireless Data Services software. For more information on setting up your computer and your *i500plus* for Packet and Circuit Data calls, see the *Wireless Data Services User's Guide* and contact your carrier.

TTY Users



You can use your phone and computer in TTY mode. Your computer screen and keyboard replace the standard TTY device. For more information, please see the *Wireless Data Services User's Guide*.

PROGRAMMING MENU

You can customize the settings on your phone using the Programming Menu.

1. Press  until you see "Prgm" on the display.
2. Select "Prgm".
3. Select "Ok".
4. Press  or  to scroll to the desired Programming Menu Option or enter the number of the Option.

SHORTCUT...

Press , press , then press the keypad number. See Table 5 .

This shortcut does not function within the browser.

Table 5: Programming Menu Options

Press-Keypad Number	Menu Option	To
1	Own Ph #	Automatically store the telephone number of your phone after you receive the first incoming call. You can also enter the number and view it.
2	Own Pvt ID	Display the private number of your phone. You must first store this number.
3	Mail Display:On/Off	Turn on and off the New Mail message that is displayed with incoming Voice, Message, or Net Mail.

Table 5: Programming Menu Options

Press-Keypad Number	Menu Option	To
4	Manual Lock:Off	Lock your phone to prevent unauthorized use. You must enter a pass code to unlock it. Even with the manual lock on, you can reach emergency help by pressing and holding the emergency key designated by your carrier.
5	Auto Lock:Off	Automatically lock your phone each time it is powered off to prevent unauthorized use.
6	Auto Answer:Off	Turn on or off automatic answering of incoming phone calls after 1-4 rings.
10	Last Call Timer	Display the duration of the most recent phone call.
11	Display Timer:Off	Turn on or off automatic display of the Last Call Timer at the end of each phone call.
12	Reset Timer	Display cumulative airtime of all phone calls since the last reset.
13	Total Timer	Display cumulative airtime of all phone calls.
14	1 Minute Beep:Off	Automatically signal each minute of elapsed phone airtime with an audible beep.
20	Phone/Prvt List	Add phone and private numbers in one procedure. See <i>"Combined Phone Number and Private ID List"</i> on page 14.

Table 5: Programming Menu Options

Press-Keypad Number	Menu Option	To
21	Phone List Edit	Edit or erase up to 100 frequently called phone numbers and associated names. See <i>"Editing and Erasing Phone List Entries"</i> on page 16.
22	Prvt ID List Edit	Edit or erase up to 100 Private numbers and associated names. See <i>"Editing and Erasing Private ID List Entries"</i> on page 16.
23	Talkgrp List Program	Add/Edit/Erase numbers and associated names for up to 10 pre-programmed talkgroups. See <i>"Adding and Storing a Talkgroup"</i> on page 24.
24	Area List Program	Add/Edit/Erase numbers and associated names for up to 50 targeted areas.
30	Ringer Volume	Set the ringer volume using the volume control keys, or lower the volume to silence the ringer. See <i>"Setting the Ringer Volume"</i> on page 10.
31	Set Ring Style	Select a distinct ring style for incoming phone calls. See <i>"Selecting a Ring Style"</i> on page 10.
32	Mail Volume	Set the volume of incoming Message Mail, Voice Mail, and Net alert tones using the volume control keys, or lower the volume to silence the mail alert tones.

Table 5: Programming Menu Options

Press-Keypad Number	Menu Option	To
33	Earpiece Volume	Set the default earpiece volume using the volume control keys.
34	Keypad Volume	Set the volume of the keypad tones using the volume control keys, or to silence the keypad tones.
35	Speaker Volume	Temporarily adjust the Group/Private Speaker volume for noisy environments.
36	Spkr Vol Set Tone	Turn the speaker volume set tones on or off.
38	Silent Group	Silence all incoming Group call alerts and voice activity. When set, your screen displays the message, "Group-Silent".
40	Change Passcode	Change your secret 4-digit pass code from the initial setting 0000.
60	Set Baud Rate <i>(for optional data services)</i>	Set the modem baud rate between the phone and the PC. See the <i>Wireless Data Services User's Guide</i> .
61	Data Ring Volume <i>(for optional data services)</i>	Set the default data ringer volume using the volume control buttons. See the <i>Wireless Data Services User's Guide</i> .
62	Program Data # <i>(for optional data services)</i>	View your circuit data (fax) number. See the <i>Wireless Data Services User's Guide</i> .

Table 5: Programming Menu Options

Press-Keypad Number	Menu Option	To
63	IP Address <i>(for optional data services)</i>	Use the scroll keys to view the Internet Protocol (IP) Address-1 for your browser, as programmed in your phone. If your phone is cabled to a computer, view IP Address-2, the stored IP address of your computer. See the <i>Wireless Data Services User's Guide</i> .
64	Reset KBytes Tx/Rx <i>(for optional data services)</i>	View the number of kilobytes sent and received for packet data. See the <i>Wireless Data Services User's Guide</i> .
65	Lines per Screen (Browser and Mail menu)	View the display in 4 lines, 12 characters or 6 lines, 16 characters.
70	Language	Select one of four languages for your display text. The default is English. See " <i>Changing the Display Language</i> " on page 7.

NOTE : **Important!** Do not perform the following shaded menu options unless you are instructed to do so by your carrier. You could damage your phone. In the Browser, do not select the “Advanced Encryption New” key. Instead, contact your carrier.

Option Number	Menu Option	Function
41	Feature Reset	Returns all feature settings to their original defaults.
42	Master Clear	Performs Feature Reset and erases all stored lists.
43	Master Reset	Resets the phone’s identification number.
44	Change Service Key	Changes or resets the fraud prevention service key.
50	NAM	Selects alternate Numeric Assignment Module (NAM). See local carrier for information.
51	Network ID	Edits the pre-programmed Network number list and select roaming options.

ABOUT STATUS MESSAGES

You may receive status messages under certain conditions. Before contacting your carrier, note the message, numeric code, and the conditions under which it appeared. Table 6 lists and describes the error messages.

Table 6: Status Messages

Status Messages	Message Description
Number Not in Service	The number that you entered is not valid.
User Not Available	The party that you called is either busy, out-of-range, or turned off. Please try again later.
User Not Authorized	The party that you called has not purchased this service.
Please Try Later	This service is temporarily not available. Please try again later.
User Busy in Private	The party that you called is busy in a Private call.
User Busy in Data	The party that you called is busy in a data call.
Service Restricted	This service was restricted by your carrier or it was not purchased.
Service Not Available	This feature is not available on the current network.
System Busy Try Later	The system is experiencing heavy traffic. Please try again later.
Service Conflict	This service cannot be enabled because an incompatible service has already been turned on.
Please Try Again	An error occurred. Note the error code and try again.
Self Check Error	A fault was detected with your phone. If this error recurs, note the error code and contact your carrier.
Self Check Fail	An operational fault was detected with your phone. Note the numeric code, turn your phone off, and contact your carrier immediately.

ACCESSORIES

Batteries

-
- NOTE :**
- For best results, charge the batteries within the temperature range of 10°C to 40°C (50°F to 104°).
 - Prolonged charging is not recommended. See Table 7 for battery charging guidelines.
-

Charging the Battery

To get the maximum use from the battery, charge it overnight before you use it for the first time. *See Table 7 for battery charging times.*

Attach the Charger to the *i500plus* via the Side Charging Jack, and plug the charger into an electrical outlet.

Table 7: Battery Charging Times

Motorola Battery		Charging Time to 90%:	
Kit Number	Description Chemistry	Standard Travel Charger	Rapid Charger
NTN8971	Standard NiMH	5 hours	75 minutes
NTN8970	Slim NiMH	3.5 hours	50 minutes

Battery Operating Instructions

- Extreme temperatures will degrade battery performance. Do not store your battery where temperatures exceed 60°C (140°F) or fall below -20°C (4°F).
- The battery capacity will be degraded if stored for long periods while fully charged. If long term storage is required, store at half capacity.
- For optimal battery life, use a Motorola iDEN approved NiMH Charger with your Motorola iDEN NiMH battery. Other chargers may not fully charge your NiMH or may yield a reduced number of charge cycles.

Travel Chargers

Using a Travel Charger, you can charge a battery from an electrical outlet.

You can use:

- The SPN4474 Standard Travel Charger
- The NTN1680 Rapid Travel Charger (110V/220V/240V) with U.S. Plug Adapter

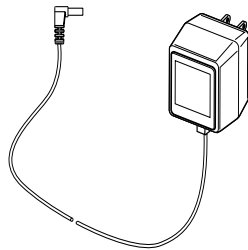

Standard Travel Charger

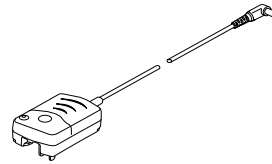

Rapid Travel Charger

Figure 1. Using the Travel Chargers

Using the Standard Travel Charger

1. Insert the Standard Travel Charger's power supply plug into an electrical outlet (110V U.S.).
2. Insert the Charger's DC plug into the Side Charging Jack on your *i500plus*.

Using the Rapid Travel Charger (110V/220V/240V)

1. Insert the wall plug adapter into the Rapid Travel Charger's power supply.
2. Insert the Charger's power supply into an electrical outlet.
3. Insert the DC plug into the Side Charging Jack of your *i500plus*.
4. The power light (green LED) turns on when the Rapid Travel Charger is receiving power.

Standard Travel Charger Operating Specifications

Input voltage range: 110V - U.S.

Operating temperature range: 0°C to +50°C.

Rapid Travel Charger Operating Specifications

Input voltage range: 110V/220V/240V.

Operating temperature range: 0°C to +50°C.

Vehicular Battery Charger

The NTN8978 Vehicular Battery Charger enables in-vehicle communications by charging the NiMH battery and providing power to your *i500plus*.

The power light (green LED) will light when the Vehicular Battery Charger is receiving power.

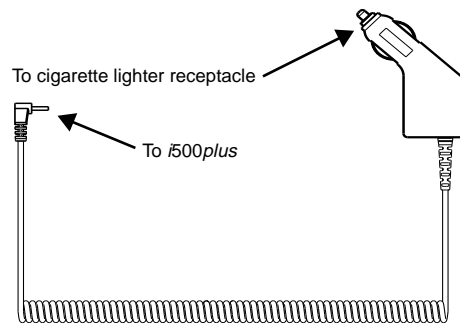

Figure 2. Using the Vehicular Battery Charger

Using the Vehicular Battery Charger

1. Insert the Vehicular Battery Charger's DC plug into the Side Charging Jack of your *i500plus*. Push firmly until the plug rests securely in the Side Charging Jack.
2. Remove the vehicle's cigarette lighter plug (if one exists) from the cigarette lighter receptacle.
3. Plug the Vehicular Battery Charger into the cigarette lighter receptacle. The power light (green LED) will turn on.

While your *i500plus* is attached to the Vehicular Battery Charger, you can leave the phone off, turn it on, or use it. For best charging results, leave it off.

Removing the Vehicular Battery Charger:

1. Unplug the Vehicular Battery Charger from the vehicle's cigarette lighter receptacle.
2. Gently pull the plug from the Side Charging Jack of your *i500plus*.

Vehicular Battery Charger Operating Specifications

Operating voltage range: 10.8 - 33.0 Vdc.

Operating temperature range: -30°C to +60°C.

Desktop Dual-Pocket Charger

The NTN1690 Desktop Dual-Pocket Charger charges Motorola authorized batteries, as listed on page 37, for the *i500plus*.

NOTE: The Desktop Dual-Pocket Charger should only be powered by the included Rapid Power Supply. The Charger will flash both LEDs red if the Standard Travel Charger is attached.

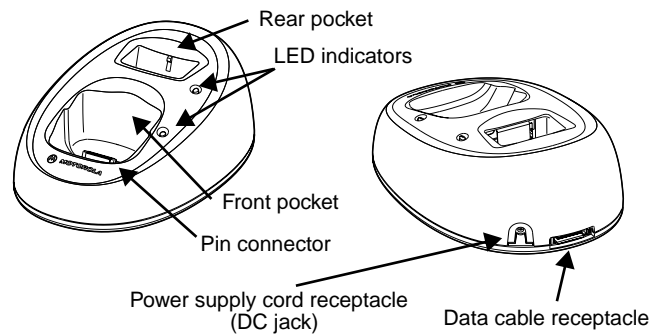

Figure 3. Desktop Dual-Pocket Charger

Charging a battery:

1. Insert the power supply's DC jack plug into the DC jack receptacle on the back of the Charger. *Use only with the Motorola rapid charger included with your Desktop Charger package.*
2. Plug the power supply end of the power-supply cord into any standard AC outlet. The Charger performs a quick power-up self-test during which both LED indicators flash green once to indicate a successful power-up.
3. Attach a battery to your *i500plus* phone. Place the *i500plus* onto the pin connector located in the charger's front pocket.

Data Operation

1. Insert the round end of the iDEN Data Cable (NKN6521) into the data cable receptacle located on the back of the charger, with the Motorola logo facing upwards.
2. Connect the opposite end of the data cable to the PC.

NOTE : Charging times may vary when performing data operations.

Adding and removing a battery from the rear pocket

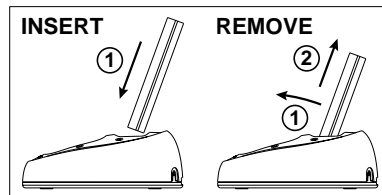

Figure 4. Adding and Removing a Battery from the Rear Pocket

1. Insert the battery with the Motorola label facing forward and the (+ and -) symbols pointing downward.
2. To remove the battery, pull it forward, then up and out of the Charger.

NOTE : If a battery is in the rear pocket...
and the *500plus* with a battery is inserted into the front pocket, the battery in the front pocket will charge to full capacity before the battery in the rear pocket is charged. The LED for the rear pocket flashes yellow, indicating that its battery is waiting to be charged.

To remove the battery from the rear pocket, hold the base of the Charger and pull the battery forward, then straight up.

Desktop Charger Status

The Charger displays the battery's charge status. The indicator will show one of the following:

solid red =1-30%; solid yellow =31-60%; flashing green =61-90%; solid green =91-100%.

Desktop Charger Troubleshooting

If the battery is not charging and you see:

A flashing yellow indicator -

- The flashing yellow LED is used to indicate that the Charger's pocket is in a wait state.
- If a battery is in the rear pocket, the rear pocket's LED continues to flash yellow until the battery in the front pocket is more than 90% charged (front pocket's LED is solid green). This is normal operation.
- To protect your battery's life expectancy, the Charger does not rapid charge a battery when its temperature is below 5°C (41°F) or above 45°C (113°F).

No LED indication -

- Check that the *i500plus* with battery, or a battery alone, is inserted correctly.
- Make sure that the power supply is plugged into an appropriate AC outlet and that the connector is properly seated.
- *Rear pocket only:* Remove the battery from the Charger. Use an ordinary pencil eraser to clean the three metal contacts on the battery and then place the battery in the Charger.
- If the LED indicator remains turned OFF, the battery may be defective and should be replaced.

Flashing red LED indicator -

- Remove the battery from the Charger. Use an ordinary pencil eraser to clean the three metal contacts on the battery and then place the battery in the Charger.
- If the LED indicator remains turned OFF, the battery may be defective and should be replaced.

Both LEDs flash red -

- This indicates that the incorrect power supply is plugged in.

Audio Adapter

The NTN8654 Audio Adapter connects an earpiece microphone or headset to your *i500plus* for privacy and hands-free operation.

The Audio Adapter fits onto the bottom of the *i500plus* and provides a standard 2.5mm jack connection for an earpiece microphone or headset.

The following audio accessories are compatible with the audio adapter:

- Earpiece with Microphone (NTN8367)
- Headset with Boom Microphone (NTN8513)
- Lightweight Headset with Microphone (NTN8496)
- Over-the-Ear Style Headset (NTN8497)

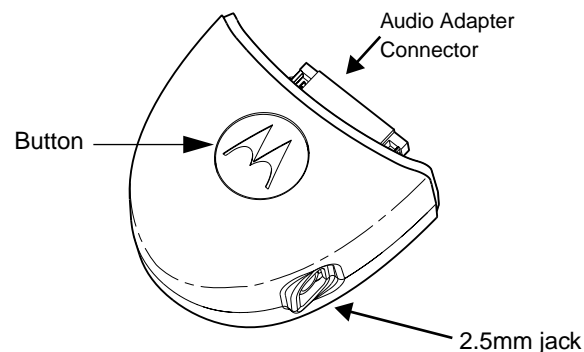

Figure 5. Using the Audio Adapter

Using the Audio Adapter

1. Hold the phone and the Audio Adapter facing you so that you see the Motorola logo on the adapter.
2. Insert the Audio Adapter's connector into the *i500plus* Bottom Accessory Connector. You will hear the connector snap into place.

Attaching/Detaching the Earpiece Microphone or Headset

1. Insert the 2.5mm plug of the earpiece microphone or headset cord into the jack of the Audio Adapter.
2. Pull on the plug, not on the cord, to remove the earpiece microphone.

Removing the Audio Adapter

1. Press the button on the front of the Audio Adapter. The button displays the Motorola logo.
2. Pull the Audio Adapter from the *i500plus*.

Dash Mount Holder

The NTN9025 Dash Mount Holder provides a convenient holder for your *i500plus*. The Dash Mount Holder can be installed either horizontally or vertically.

Important! Do not place the dash mount holder over the air bag or in the air bag deployment area. For more information, see “For Vehicles Equipped with Air Bags” on page 44

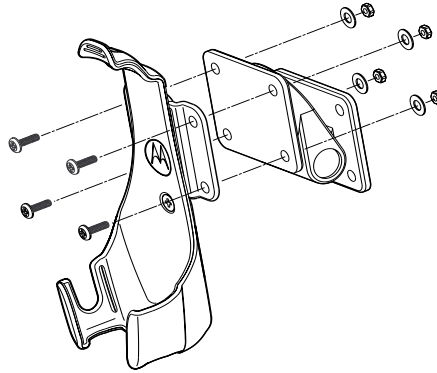

Figure 6. Installing the Dash Mount Holder

Using the Dash Mount Holder

1. Mount the Dash Mount Holder to the dash of your vehicle by securing the four self-tapping screws to the base of the Holder. Or, for a semi-permanent installation, use the included adhesive strip.
2. Snap your phone securely into the holder.

Swivel Belt Clip

The NTN8980 Swivel Belt Clip provides a convenient means by which to carry your *i500plus* with you.

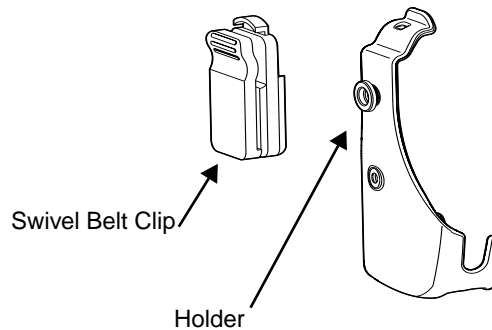

Figure 7. Using the Swivel Belt Clip

Using the Swivel Belt Clip

1. Attach the Swivel Belt Clip to your belt.
2. Insert your *i500plus* into the belt clip holder and attach the holder to the Swivel Belt Clip.
3. To remove your *i500plus* from the holder, push the holder tab inward while pulling the phone outward.
4. To remove your *i500plus* and the holder from the Swivel Belt Clip, push down on the button on top of the Swivel Belt Clip and lift the holder out.

Leather Carry Case with Clear Plastic Cover

- The NTN8981 Leather Carry Case protects your *i500plus* while on the go
- Includes a leather belt clip for easy attachment to a belt or purse
- Accommodates most *i500plus* accessories including travel chargers, audio accessories, vehicle accessories, and data accessories.

Hands-Free Car Kit

IMPORTANT! The Hands-Free Car Kit is also a charger. Therefore, DO NOT operate this kit and the Vehicular Battery Charger at the same time.

The NTN1674 Hands-Free Car Kit enables in-vehicle communications by providing a built-in speaker, a power supply for the phone's internal battery charger, hands-free visor microphone, dash-mount holder, and power to the phone.

An external Push-To-Talk (PTT) switch is also included. When the phone is turned off, the Hands-Free Car Kit charges the Standard battery in 75 minutes to 90% capacity. Charging time will be longer if the phone is operational during charge time.

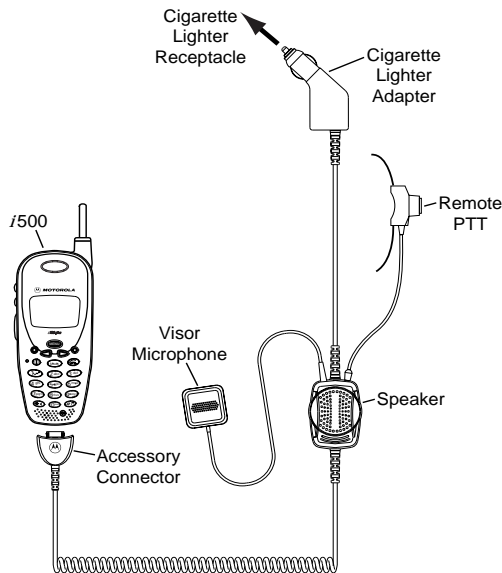

Figure 8. Using the Hands-Free Car Kit

Using the Hands-Free Car Kit

1. Hold the *i500plus* with its front toward you. Insert the accessory connector (with the Motorola logo facing you) into the phone's bottom accessory connector until it clicks into place.
2. Remove the vehicle's cigarette lighter from the cigarette lighter receptacle.
3. Plug the Hands-Free Car Kit's Vehicular Battery Charger into the cigarette lighter receptacle. The power light (green LED) will come on.

4. Selecting the correct position for the hands-free visor microphone is vital for the performance of the hands-free circuitry. It is recommended that the microphone be mounted either on the sun visor directly above (and facing) the driver, or on the headliner just above (and facing) the driver.

The visor microphone:

- Should NOT be located within 12 inches of the speaker box.
 - Should never be mounted near the vehicle's window, or in a spot where road and ambient noise are substantially high.
 - Should be mounted so that it does not come into contact with the air bag, or interfere with air bag deployment.
5. Turn on your *i500plus* phone.
 6. Adjust the speaker volume using the volume control buttons on your *i500plus*.

To remove the *i500plus*:

1. Push the Motorola logo button on the accessory connector and remove the connector from the phone.

NOTE : The *i500plus* should only be used with a Hands-free Car Kit that has a grey button on the accessory connector. The use of any other hands-free car kit will result in an "incompatible accessory" message on the phone's display.

SAFETY AND GENERAL INFORMATION

IMPORTANT INFORMATION ON SAFE AND EFFICIENT OPERATION. READ THIS INFORMATION BEFORE USING YOUR INTEGRATED MULTI-SERVICE PORTABLE RADIO.

For the Safe and Efficient Operation of Your Radio, Observe these Guidelines:

Your radio product contains a transmitter and a receiver. When it is *ON*, it receives and transmits radio frequency (RF) energy. The radio operates in the frequency range of 806 MHz to 870 MHz and employs digital modulation techniques. When you use your radio, the system handling your call controls the power level at which your radio transmits. The power level typically may vary over a range from .0024 Watts to 0.6 Watts.

Exposure To Radio Frequency Energy

Your Motorola Radio Product is designed to comply with the following national and international standards and guidelines regarding exposure of human beings to radio frequency electromagnetic energy:

- United States Federal Communications Commission, Code of Federal Regulations; 42 CFR part 2 sub-part j
- American National Standards Institute (ANSI) IEEE. C95. 1-1992
- National Council on Radiation Protection and Measurements (NCRP). Report 86
- International Commission on Non-Ionizing Radiation Protection (ICNIRP) 1998
- National Radiological Protection Board of the United Kingdom, GS 11, 1988
- Verband Deutscher Elektrotechniker (VDE) DIN-0848
- Department of Health and Welfare Canada. Safety Code 6

To assure optimal radio performance and make sure human exposure to radio frequency electromagnetic energy is within the guidelines set forth in the above standards, always adhere to the following procedures:

When placing or receiving a phone call, or using the group and private call functions with a Group/Private Speaker OFF (muted speaker icon visible on the display), hold your *i500plus* as you would a telephone. Speak directly into the mouthpiece and position the antenna up and over your shoulder.

When using your *i500plus* as a traditional two-way radio while making group or private calls with the Group/Private Speaker ON (no speaker icon visible in the display), hold the radio in a vertical position with the microphone one to two inches away from the lips.

For body-worn operation, the antenna should be kept at least one inch from the body when transmitting.



DO NOT hold the antenna when the radio is "IN USE". Holding the antenna affects call quality and may cause the radio to operate at a higher power level than needed.

Interference to Medical and Personal Electronic Devices

Most electronic equipment is shielded from RF energy. However, certain equipment may not be shielded against the RF signals from your *i500plus*.

Pacemakers

The Health Industry Manufacturers Association recommends that a minimum separation of 6 inches be maintained between a handheld wireless phone and a pacemaker to avoid potential interference with the pacemaker. These recommendations are consistent with the independent research by and recommendations of Wireless Technology Research.

Persons with pacemakers should:

- ALWAYS keep the phone more than six inches from the pacemaker when the phone is turned ON.
- Not carry the phone in a breast pocket.
- Use the ear opposite the pacemaker to minimize the potential for interference.
- Turn the phone OFF immediately if you have any reason to suspect that interference is taking place.

Hearing Aids

Some digital wireless phones may interfere with some hearing aids. In the event of such interference, you may want to consult your hearing aid manufacturer to discuss alternatives.

Other Medical Devices

If you use any other personal medical device, consult the manufacturer of your device to determine if it is adequately shielded from external RF energy. Your physician may be able to assist you in obtaining this information.

Turn your phone OFF in health care facilities when any regulations posted in these areas instruct you to do so. Hospitals or health care facilities may be using equipment that could be sensitive to external RF energy.

Interference to Other Electronic Devices

RF energy may affect improperly installed or inadequately shielded electronic operating and entertainment systems in motor vehicles. Check with the manufacturer or representative to determine if these systems are adequately shielded from external RF energy. Also check with the manufacturer of any equipment that has been added to the vehicle.

Turn your radio off before boarding any aircraft to prevent possible interference to aircraft systems. Regulations of the United States Federal Aviation Administration prohibit use when the plane is in the air and require you have permission from a crew member to use your radio while the plane is on the ground.

Safety and General

Use While Driving

Check the laws and regulations on the use of telephones in the area where you drive. Always obey them.

When using the phone while driving, please:

- Give full attention to driving and to the road
- Use hands-free operation, if available
- Pull off the road and park before making or answering a call if driving conditions so require.



OPERATIONAL WARNINGS

WARNING

Potentially Explosive Atmospheres

Turn off your two-way radio when you are in any area with a potentially explosive atmosphere, unless it is a radio type especially qualified for use in such areas (for example, Factory Mutual Approved). Sparks in a potentially explosive atmosphere can cause an explosion or fire resulting in bodily injury, or even death.

Note: *The areas with potentially explosive atmospheres referred to above include fueling areas such as: below decks on boats; fuel or chemical transfer or storage facilities; areas where the air contains chemicals or particles such as grain, dust or metal powders; and any other area where you would normally be advised to turn off your vehicle engine. Areas with potentially atmospheres are often, but not always posted.*

Batteries

Do not replace or charge batteries in a potentially explosive atmosphere. Contact sparking may occur while installing or removing batteries and cause an explosion.

Blasting Caps and Areas

To avoid possible interference with blasting operations, turn off your radio when you are near electrical blasting caps, in a blasting area, or in areas posted: "Turn off two-way radio". Obey all signs and instructions.

For Vehicles Equipped with Air Bags

Do NOT place objects, including both installed and portable wireless equipment, in the area over the air bag or in the air bag deployment area. An air bag inflates with great force. If in-vehicle wireless equipment is improperly installed and the air bag inflates, serious injury could result.



Caution OPERATIONAL CAUTIONS

Damaged Antennas

Do not use any portable two-way radio that has a damaged antenna. If a damaged antenna comes into contact with your skin, a minor burn can result.

Batteries

All batteries can cause property damage and/or bodily injury such as burns if a conductive material such as jewelry, keys, or beaded chains touch exposed terminals. The conductive material may complete an electrical circuit (short circuit) and become quite hot. Exercise care in handling any charged battery, particularly when placing it inside a pocket, purse, or other container with metal objects.

Cleaning Instructions

Clean the external surfaces of the unit with a damp cloth, using a mild solution of dishwashing detergent and water. Some household cleaners may contain chemicals that could seriously damage the unit. Avoid the use of any petroleum-based solvent cleaners. Also, avoid applying liquids directly on the unit.

Antenna Considerations

Use only the supplied or an approved antenna. Unauthorized antennas, modifications, or attachments could impair call quality, damage the radio, or result in violation of local agency regulations.

Accessory Safety Information

IMPORTANT:

SAVE THESE ACCESSORY SAFETY INSTRUCTIONS

- Before using the battery, read all the instructions and cautionary markings on (1) the battery, (2) the battery charger, and (3) the phone using the battery.
- Before using the Standard Travel Charger, read all the instructions and cautionary markings on (1) the Standard Travel Charger, (2) the battery, and (3) the phone using the battery.
- Before using the Rapid Travel Charger, read all the instructions and cautionary markings on (1) the Rapid Travel Charger, (2) the battery, and (3) the phone using the battery.
- Before using the Vehicular Battery Charger (VBC), read all the instructions and cautionary markings on (1) the VBC, (2) the battery, and (3) the phone using the battery.
- Before using the Desktop Dual-Pocket Charger, read all the instructions and cautionary markings on (1) the battery charger, (2) the battery, and (3) the phone using the battery.
- Do not expose the Standard Travel Charger, Rapid Travel Charger, Desktop Dual-Pocket Charger, or VBC to water.
- Use only Motorola Approved accessories.



WARNING

To reduce the risk of injury, charge only the rechargeable batteries listed. Other types of batteries may burst, causing personal injury and damage.

- To reduce the risk of damage to the cord or plug, pull by the plug rather than the cord when you disconnect the Standard or Rapid Travel Chargers or Desktop Dual-Pocket Charger from the AC receptacle or when you disconnect the VBC from the cigarette lighter.
- Do not operate a Charger or VBC with a damaged cord or plug.
- Do not attempt to disassemble the Chargers or VBC.
- The Chargers or VBC may become warm during operation, but not hot. If the Charger becomes hot to the touch, unplug it from the AC outlet immediately and discontinue its use. If the VBC becomes hot to the touch, unplug it from the cigarette lighter immediately and discontinue its use.

- Use of a non-recommended attachment to the Desktop Dual-Pocket Charger may result in a risk of fire, electric shock, or injury to persons.
- Make sure the Desktop Dual-Pocket Charger cord is located so that it will not be stepped on, tripped over, or subjected to damage or stress.
- An extension cord should not be used with the Desktop Dual-Pocket Charger unless absolutely necessary. Use of an improper extension cord could result in a risk of fire and electric shock. If an extension cord must be used, make sure that:
 - The pins on the plug of the extension cord are the same number, size, and shape as those on the plug of the charger.
 - The extension cord is properly wired and in good electrical condition.
 - The cord size is 18AWG for lengths up to 100 feet and 16AWG for lengths up to 150 feet.
- Do not operate the Desktop Dual-Pocket Charger with a damaged cord or plug - replace them immediately.
- Do not operate the Desktop Dual-Pocket Charger if it has received a sharp blow, has been dropped, or has been damaged in any way; take it to a qualified service technician.
- Do not disassemble the Desktop Dual-Pocket Charger; take it to a qualified service technician when service or repair is required. Incorrect reassembly may result in a risk of electric shock or fire.
- Maximum ambient temperature around the power supply of the Desktop Dual-Pocket Charger should not exceed 40°C (104°F).
- The output power from the power supply must not exceed the rating given on the Desktop Dual-Pocket Charger.
- The disconnection from the line voltage is made by unplugging the power supply from the AC receptacle.
- To reduce risk of electric shock, unplug the Desktop Dual-Pocket Charger from the outlet before attempting any maintenance or cleaning.
- For optimum performance, turn off the *i500plus* while charging it in the Desktop Dual-Pocket Charger.
- The Desktop Dual-Pocket Charger is for indoor use only.

OWNER'S INFORMATION

Mobile Equipment Identifier (IMEI)

Own Phone Number

Own Private ID

Date Purchased

Sales Representative Telephone Number

Customer Care Number
