

Motorola

3460 Fast'R and 3460 Fast'R *Plus* Reference Guide

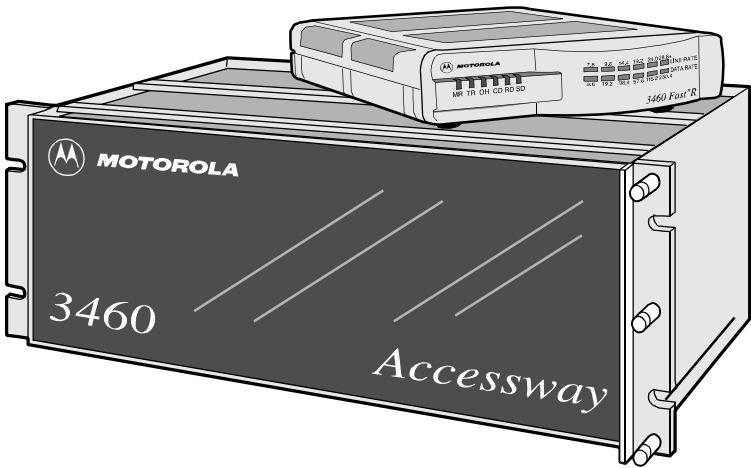

Notices

©2000 Telenetics Corporation
39 Parker
Irvine, California 92618
(949) 455-4000
All rights reserved
Printed in U.S.A.



Proprietary Material

Information and software in this document are proprietary to Motorola, Inc. (or its Suppliers) and without the express prior permission of an officer of Motorola, Inc., may not be copied, reproduced, disclosed to others, published, or used, in whole or in part, for any purpose other than that for which it is being made available.

This document is for information purposes only and is subject to change without notice.

Product Declarations and Regulatory Information

Writer: Christina Lamkin Publication Specialist: Denise Skinner Illustrator: Tim Kinch	Part No.: T0022, Rev F Publication Code: RC
This guide is current for Release 5.1 of the 3460 Fast'R and 3460 Fast'R <i>Plus</i> Modem. To comment on this manual, please send email to: LAM001@email.mot.com or use the Customer Response Card in this guide.	

Information on the World Wide Web

Additional company and product information can be found on our World-Wide Web page at:

<http://www.mot.com/MIMS/ISG/>

At this Web site, you can download user documentation and software releases as they become available.

Connecting Ports



Warning

Ports that are capable of connecting to other apparatus are defined as SELV. To ensure conformity with EN60950 - ensure that these ports are only connected to ports of the same type on other apparatus.



Avertissement

Les ports qui sont susceptibles d'être connectés à des équipements sont désignés comme TBTS. Pour garantir la conformité à la norme EN 60950, n'interconnecte ces ports qu'avec des ports du même type sur des autres matériels.



Warnung

Anschlüsse, die mit anderen Geräten verbunden werden können, sind als SELV beschrieben. Um Konformität mit EN 60950 zu versichern, sichern Sie es, daß diese Anschlüsse nur mit den des selben Type auf anderen Geräten verbunden werden.

Contents

About This Guide

Chapter 1. Introduction

3460 Fast'R Overview	1-1
Network Management Support	1-1

Chapter 2. Access Security Functions

In This Chapter	2-1
Password Verification on Connection	2-1
Callback Verification and Dial Restriction	2-1
Configuration/Phone Number Access Restriction.....	2-3
Access Security AT Command Summary	2-4

Appendix A. Specifications

In This Appendix	A-1
Physical Characteristics	A-1
Operating Modes	A-2
Fax	A-2
Fax Data Rates	A-2
Fax Standards	A-2
Fax Modulation Protocols	A-2
Environmental Limits	A-3
Product Safety Regulatory Marking	A-3
Electromagnetic Compatibility	A-4
Fax Branding	A-4
AccessWay Enclosure Power Supply and Power Requirements	A-5
AccessWay Enclosure Connectors and Interfaces	A-6
Modem Interface	A-6
Computer (DTE) Interface	A-8
Dial and Two-Wire Leased Line Telephone Interface	A-8
Network Management Interface	A-9
Power Interface	A-9
Off-Line Configuration (OLC) Button	A-10
Vanguard 3460 V.34 Daughtercard Connectors and Interfaces..	A-11
Telephone Interface	A-11
Network Management Interface	A-11

Appendix A. Specifications (Continued)

Stand-Alone Modem Interfaces and Connectors	A-12
Computer (DTE) Interface	A-12
Telephone Interface	A-13
Network Management Interface	A-14
Power Interface and On/Off Switch	A-15
Off-Line Configuration (OLC) Button	A-15
Panel Indicators and Switches	A-17
Front-Panel User Interface	A-18
LCD Display	A-18
Control Buttons	A-19
Compatibility	A-19

Appendix B. Country-Specific Information

In This Appendix	B-1
Country-Specific Parameters	B-1
S7 Parameter	B-8

Appendix C. Attention (AT) Commands for Fax

In This Appendix	C-1
AT Command Set	C-1
Result Messages and Codes	C-11

Index

About This Guide

Introduction

This guide describes the features, specifications, and applications of the:

- Motorola 3460 Fast'R Modem
- Motorola 3460 Fast'R *Plus* modem
- AccessWay Enclosure
- Motorola Vanguard 3460 V.34 Daughtercard

Use this guide in conjunction with the *3460 Fast'R User Guide* (Part Number T0022-01) and the *Vanguard 3460 V.34 Daughtercard Installation Guide* (Part Number T0020-02).

Audience

This manual is intended for operators and administrators of the Motorola 3460 Fast'R and Fast'R *Plus* Modem and the Vanguard 3460 V.34 Daughtercard.

Special Notices

The following notices emphasize certain information in the guide. Each serves a special purpose and is displayed in the format shown:

IMPORTANT: *Important is used to emphasize any significant procedural information.*

IMPORTANT: *Important est utilisé pour souligner des informations critiques au sujet d'une procédure.*

WICHTIG: *Wichtig wird zur Betonung signifikanter Angaben zu Vorgehensweisen verwendet.*



Caution

Caution provides you with information that, if not followed, can result in damage to software, hardware, or data.



Mise en Garde

Une mise en garde vous fournit des informations qui, si elles ne sont pas observées, peuvent se traduire par des dommages pour le logiciel, le matériel ou les données.



Vorsicht

Ein Vorsichtshinweis macht Sie darauf aufmerksam, daß Nichtbefolgung zu Software-, Hardware- oder Datenschäden führen kann.



Warning

Warning is the most serious notice, indicating that you can be physically hurt.



Avertissement

Un avertissement constitue le message le plus sérieux, indiquant que vous pouvez subir des blessures corporelles.



Warnung

Eine Warnung ist der ernsthafteste Hinweis auf Körperverletzungsgefahr.

Trademarks

The following are trademarks or registered trademarks of their respective companies or organizations.

<i>Product</i>	<i>Company/Organization</i>
<i>AT</i>	Hayes Microcomputer Products, Inc.
<i>Hayes</i>	Hayes Microcomputer Products, Inc.
<i>HyperTerminal</i>	Hilgraeve, Inc.
<i>Windows</i>	Microsoft Corporation

All other brand and product names trademarks or registered trademarks of their respective owners.

Chapter 1

Introduction

3460 Fast'R Overview

The Motorola 3460 Fast'R Modem family provides reliable data communication to meet a wide variety of networking requirements. The 3460 Fast'R Modem, the 3460 Fast'R *Plus* Modem, and the Vanguard 3460 V.34 Daughtercard modem are fully interoperable.

Network Management Support

The modem supports the Motorola 9000 OMS Network Management System, allowing you to configure local modems and access alarm, event, and statistical information.



Warning

All Motorola devices should be used in environments designed for computers and electronic equipment. **In areas susceptible to lightning, take precautions to prevent damage to electronic equipment.** Contact your telephone company, or an electronic accessories vendor, for information on lightning protection equipment. Customers experiencing problems caused by surges from lightning have eliminated such problems by installing appropriate **surge suppressors** on power and data lines connected to Motorola devices.



Avertissement

Tous les dispositifs Motorola doivent être utilisés dans des environnements conçus pour des ordinateurs et du matériel électronique. Dans les zones susceptibles d'être frappées par la foudre, prenez des précautions pour éviter que le matériel électronique soit endommagé. Contactez votre compagnie téléphonique, ou un vendeur d'accessoires électroniques, pour obtenir des renseignements concernant les systèmes de protection contre la foudre. Certains usagers confrontés à des problèmes causés par des sautes de tension dues à la foudre ont éliminé ces problèmes en installant des régulateurs de tension appropriés sur les câbles électriques et les câbles de données reliés aux dispositifs Motorola.



Warnung

Motorola-Geräte sind grundsätzlich in für Rechner und elektronische Anlagen vorgesehenen Umgebungen zu verwenden. In unwettergefährdeten Bereichen ist jegliche Elektronik gegen Blitzeinwirkung Z_u schützen. Näheres über entsprechende Schutzrichtungen erfahren Sie von Ihrer Telefongesellschaft oder einem Elektrohändler. Probleme mit Spannungsschößen durch Blitzeinwirkung lassen sich durch Einbau von Überspannungsableitern in die zu Motorola-Geräten führenden Netz- und Datenleitungen beheben.



Warning

Do not attempt to repair the modem or enclosure. They contain *no* electronic components that can be serviced or replaced by a user. Any attempt at user service of the modem or enclosure, or opening of the 3460 Fast'R unit, voids the product warranty.



Avertissement

N'essayez pas de réparer le modem ou le boîtier. Ils ne contiennent aucun composant électronique pouvant être réparé ou remplacé par un usager. Toute tentative de réparation du boîtier du 3460 Fast'R ou de l'AccessWay 16 par un usager, ou toute intervention à l'intérieur du 3460 Fast'R, annule la garantie du produit.



Warnung

Versuchen Sie nicht, das Modem oder sein Gehäuse zu reparieren. Es sind keine durch den Benutzer wartungs- oder austauschfähige Teile darin enthalten. Bei jeglichem Öffnen oder Wartungsversuch am 3460 Fast'R bzw. AccessWay 16-Schaltkasten durch den Benutzer verfällt die Gerätegarantie.

Chapter 2

Access Security Functions

In This Chapter

This chapter describes the following functions that implement password security:

- Password verification
- Callback
- Callback dial restriction
- Configuration/phone number access restriction options.

Password Verification on Connection

With password verification, the modem must receive a password from the calling device, then validate it internally or send it to a Motorola network management system (NMS) for validation, in order to complete the connection. If a password is invalid, the modem disconnects.

To enable password verification, determine whether the **modem** or an **NMS** will verify passwords. Follow the appropriate procedure below.

Enabling Password Verification by a Local Modem

Step	Stage
1	Use the AT*ZI command to enter a password in the local modem.
2	Use the AT*ZVI command to enable internal password verification in the local modem.
3	Use the AT*ZI command to enter a password in a remote modem.
4	Use the AT*ZVI command to enable internal password verification in the remote modem.

Callback Verification and Dial Restriction

Callback verification and restriction apply to incoming calls.

With callback verification, the answering modem that successfully completes password verification with a calling modem hangs up, then calls the modem back. The modems then pass data.

With callback dial restriction, the answering modem calls back only stored Phonebook numbers, not numbers sent by a calling modem.

Enable these functions as follows.

Enabling Callback Verification and Dial Restriction

Step	Stage
1	Configure password verification, as described above.
2	Use the AT*ZC command* in the local modem to specify the callback phone number source: <ul style="list-style-type: none"> • The local modem (AT*ZC<i>n</i>, where <i>n</i> specifies a Phonebook entry) • The remote modem (AT*ZC10). This option does not use the secondary channel.
3	Store a callback telephone number in the device selected in the previous step, using the AT&Z (Enter Phone Number) command.
4	If you selected the remote modem as the callback-number source, use the AT*ZR command to specify whether supplying the number is mandatory (AT*ZR1) or optional (AT*ZR0). With the Mandatory option, the remote modem must supply a callback number during its initial call, or the local modem disconnects and does not make a callback. With the Optional option, the remote modem may establish a call without supplying a callback number. The local modem does not disconnect.
5	To prevent the local modem from executing an Auto Redial command, issue the AT*ZD1 command. To prevent the modem from calling any number except those stored in the Phonebook, issue the AT*ZD1 command.
*ZC parameter default value is Off (AT*ZC0).	

Configuration/Phone Number Access Restriction

Configuration and phone number access restriction applies to the local modem. With it enabled, you must enter a correct password before:

- Listing, echoing, or storing Phonebook entries
- Changing configuration options

You do not enter the password to perform these functions:

- Dial a stored Phonebook number
- Answer an incoming call

After storing a password in a modem, enable configuration and phone number access restriction by issuing the AT*PF command to lock it. A summary of access security commands follows.

IMPORTANT: Know your password before enabling password functions. If you lose a password, the only way to regain access to all modem actions is to re-initialize the modem memory (AT&F). Once you re-initialize modem memory, you must re-enter Phonebook information and reconfigure option settings.

Access Security AT Command Summary

Security Parameters, Factory Default Options

<i>Command</i>	<i>Factory Default Option</i>	<i>Description</i>
AT*PE	AT*PE0 (Disabled)	Password protection
AT*PF	AT*PF	Lock Configuration and Phone Number password-protection
AT*PN	[None]	Enter password. Issue AT*PNx , where x =password.
AT*PW	[None]	Change password. Issue AT*PWx/y , where x =old password and y =new password.
AT*ZC	AT*ZC0 (Off)	Callback function
AT*ZD	AT*ZD0 (Off)	Dial Restriction function
AT*ZI	[None]	Enter Group password
AT*ZR	AT*ZR0 (Off)	Remote Number Required
AT*ZV	AT*ZV0 (Disable)	Password Verification

Appendix A

Specifications

In This Appendix

This appendix describes the physical characteristics, connectors, and interfaces of:

- The 3460 Fast'R and Fast'R Plus stand-alone modem
- The 3460 Fast'R and Fast'R Plus modem card
- The AccessWay enclosure, backplane, and power supply
- The Vanguard 3460 V.34 DaughterCard modem card

For Vanguard 3460 V.34 Daughtercard specifications not shown here, refer to the Vanguard documentation.

Physical Characteristics

Physical Properties

<i>Property</i>	<i>Modem Card</i>	<i>AccessWay</i>	<i>Stand-Alone</i>	<i>Vanguard Daughter-card</i>
Height	6.32"	7"	1.8"	0.9"
Width	0.7"	19"	6.8"	2.95"
Depth	8.9"	9.5"	10.2"	8.85"
Weight	1 lb.	20 lb.	2 lb.	2 lb.
Heat Output	5 Watt	105 Watt	6 Watt*	2 Watt
*Includes wall-mount transformer.				
1 Watt= 3.4 BTU/Hr.				

The stand-alone modem has a single modem in a plastic housing. Units may be stacked on a shelf or rack. Clips for this purpose are included in an accessory kit.

Operating Modes

Full-duplex, point-to-point.

Accessway enclosure-card modems, Vanguard 3460 V.34 Daughtercard modems, and stand-alone units are fully interoperable.

Fax

Fax Data Rates

- ITU-T Rec. T.4 and T.30 Group 3—14.4 KBPS

Fax Standards

EIA 578 Class 1 Fax

EIA 592 Class 2.0 Fax

Fax Modulation Protocols

ITU-T V.17

ITU-T V.27ter

ITU-T V.29

ITU-T V.21

Environmental Limits

Operating Conditions

Condition	Modem Card	AccessWay	Stand-Alone
Temperature	Operating temperature: 32° to 122°F (0° to 50°C) maximum		
Relative Humidity	5% to 90% (noncondensing)		
Vibration and Shock	In approved shipping container, conforms to the National Safe Transit Association Percipient Test Specification requirements.		
The stand-alone modem requires locking clips for stacking units to a maximum recommended height of 9 units.			

Non-Operating Conditions

Condition	Modem Card	AccessWay	Stand-Alone
Temperature	-40° to +158°F (-40° to +70°C)		
Relative Humidity	5% to 90% (noncondensing)		
Vibration and Shock	In approved shipping container, conforms to the National Safe Transit Association Percipient Test Specification requirements.		

Product Safety Regulatory Marking

Regulatory labels indicate compliance with safety standards.

Modems and enclosures carry one of the following labels:

- UL, CSA, and TUV

Electromagnetic Compatibility

The stand-alone modem, Fast'R modem card, and AccessWay enclosure conform to the following emissions standards.

- FCC PART 15A CLASS A (card and enclosure)
- FCC PART 15A CLASS B (stand-alone modem)
- IEC CISPR 22 and EN 55022 CLASS A (card and enclosure)
- IEC CISPR 22 and EN 55022 CLASS B (stand-alone modem)
- AS 3548, Class B
- EN 50082-1

Fax Branding

The Telephone Consumer Protection Act of 1991 makes it unlawful for any person to use a computer or other electronic device, including fax machines, to send any message unless such message clearly contains in a margin at the top or bottom of each transmitted page or on the first page of the transmission, the date and time it is sent, an identification of the business or other entity, or other individual sending the message, and the telephone number of the sending machine or of such business, other entity, or individual. (The telephone number provided may not be a 900 number or any other number for which charges exceed local or long-distance transmission charges.)

To program this information into your fax application, refer to the "Installing a Modem on a Windows Computer" section of the 3460 Fast'R User's Guide, and to your fax application documentation.

AccessWay Enclosure Power Supply and Power Requirements

The AccessWay enclosure backplane provides common power and communications connections for up to 16 Fast'R modem cards mounted within. Its connectors are shown in Figure A-1.

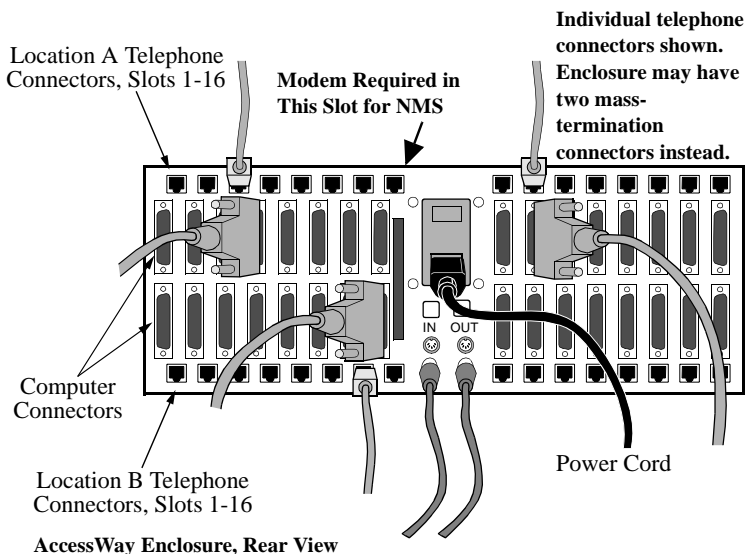

Figure A-1. AccessWay Backplane Connectors

The enclosure accommodates a standard 19" rack-mount configuration.

The AccessWay enclosure power distribution system includes an AC or DC power supply module.

AC Power Supply Module

- Voltage: 100/120/220/240 VAC nominal (switch-selectable)
- Frequency: 50/60 Hz

DC Power Supply Module

- Voltage: -48VDC nominal

AccessWay Enclosure Power and Modem Operation

You can insert and remove modem cards while the AccessWay enclosure is powered on and operational.

AccessWay Enclosure and Network Management

The AccessWay provides a network management interface to a Motorola ISG 9000 NMS. Up to four AccessWays can be connected in daisy-chain fashion to one NMS connection. A modem card must be present in Slot 9 of each enclosure to transmit network management information to and from other modems in the enclosure.

AccessWay Enclosure Connectors and Interfaces

Modem Interface

AccessWay backplane interface and connectors are as follows.

Modems That Support Two-Wire Leased or Dial Connections

<i>MODEM A and MODEM B Individual Connectors*</i>	
Interface: RJ-11	
Connection Type: Two-Wire Leased or Dial Line	
Pin	Function
3	Ring
4	Tip
<i>MODEM A and MODEM B Mass Line-Termination Connectors</i>	
Interface: RJ-21X.	
Connection Type: Two-Wire Leased or Dial-Line	
Pin	Function
1	Slot 1 Modem Card Tip
26	Slot 1 Modem Card Ring
2	Slot 2 Modem Card Tip
27	Slot 2 Modem Card Ring
...	...
8	Slot 8 Modem Card Tip/
33	Slot 8 Modem Card Ring
9 - 17	None
34 - 42	None
*AccessWay backplanes labeled "Modem A/Modem B" do not support four-wire leased-line connections.	

Modems That Support Two-Wire Leased or Dial Connections

18	Slot 9 Modem Card Tip
43	Slot 9 Modem Card Ring
19	Slot 10 Modem Card Tip
44	Slot 10 Modem Card Ring
...	...
25	Slot 16 Modem Card Tip
50	Slot 16 Modem Card Ring
*AccessWay backplanes labeled "Modem A/Modem B" do not support four-wire leased-line connections.	

Modems That Support Two- or Four-Wire Leased or Dial Connections

LINE A Connectors	
Interface: RJ-11	
Connection Type: Two- or Four-Wire Leased Line or Dial Line	
Pin	Function
2	Four-Wire Rx Tip
3	Dial-Line Ring/Two-Wire Ring/Four-Wire Tx Ring
4	Dial-Line Tip/Two-Wire Tip/Four-Wire Tx Tip
5	Four-Wire Rx Ring
LINE B Connectors	
Interface: RJ-11	
Connection Type: Two-Wire Leased or Dial Line	
Pin	Function
3	Two-wire Leased Line/Dial-Line Ring
4	Two-wire Leased Line/Dial-Line Tip

Computer (DTE) Interface

The AccessWay rear panel has up to 32 female DB25 connectors, which support a subset of the ITU-T V.24 and EIA/TIA-232E specifications. Pinouts are as follows:

Computer Interface

<i>V.24 Signal Number</i>	<i>Pin</i>	<i>Circuit</i>	<i>Function</i>
103	2	BA/103	TXD
104	3	BB/104	RXD
105	4	CA/105	RTS
106	5	CB/106	CTS
107	6	CC/107	DSR
102	7	AB/102	Signal Ground
109	8	CF/109	DCD
114	15	DB/114	TXCLK
115	17	DD/115	RXCLK
108.x	20	CD/108.1/2	DTR
125	22	CE/125	RI
113	24	DA/113	XTCLK
Pins not listed here are not used.			

Dial and Two-Wire Leased Line Telephone Interface

The AccessWay enclosure rear panel has 32 RJ11 connectors *or* two 50-pin mass-termination connectors. Pinouts for each are as follows:

RJ11 Interface Pinouts

<i>Pin</i>	<i>Function</i>
3	Ring
4	Tip
Pins not listed here are not used.	

Mass-Termination Interface Pinouts

<i>Pin</i>	<i>Function</i>
1 through 25	Tip
26 through 50	Ring
Pins not listed here are not used. A 50-pin connector provides connections to 16 modems. Tip-ring pin pairs are: 1 and 26; 2 and 27; and so on.	

In some countries, the telephone interface requires an adaptor.

Network Management Interface

The AccessWay rear panel has two female 8-pin DIN connectors. Pinouts are as follows:

Network Management Interface Pinouts

<i>Pin</i>	<i>NM OUT</i>	<i>NM IN</i>
2	TXD	TXD
3	RXD	RXD
4	RTS	RTS
7	Signal Ground	Signal Ground
8	DCD	DCD
Pins not listed here are not used.		

Power Interface

The AccessWay rear panel has one power connector, as follows:

Power Interface

<i>Power Type</i>	<i>Connector</i>
AC	Industry Standard
DC	Barrier strip

Off-Line Configuration (OLC) Button

The off-line configuration button, labelled OLC, is located on the front of the card.

Pressing the button makes the modem enter command mode, in which the user in synchronous or leased-line environments can change configuration options.

Use the OLC button to change a configuration as follows.

Changing a Configuration With the OLC Button

Step	Stage
1	Change one or more configuration options.
2	Enter the Save to Option Set command (<code>AT&Wn</code> , where <i>n</i> is 1 or 2).
3	Enter the Option Set to Power Up In command (<code>AT&Yn</code> , where <i>n</i> is: 0 for last-loaded option set; 1 for Option Set 1, or 2 for Option Set 2)
4	Press the OLC button. The modem restarts and powers up using the selected configuration option set.

Vanguard 3460 V.34 Daughtercard Connectors and Interfaces

Vanguard 3460 modem card interface and connectors are as follows.

Telephone Interface

Telephone Interface

<i>DIAL Connector</i>		
Interface: RJ-11		
Connection Type: Dial Line		
Pin	Function	
3	Ring	
4	Tip	
<i>LEASE Connector</i>		
Interface: RJ-11		
Connection Type: Two- or Four-Wire Leased Line		
Pin	Two-Wire Function	Four-Wire Function
2	Not used	Rx Ring
3	Ring	Tx Ring
4	Tip	Tx Tip
5	Not used	Rx Tip

Network Management Interface

Network Management Interface Pinouts

<i>Pin</i>	<i>Signal</i>
2	TXD
3	RXD
4	RTS
7	Signal Ground
8	DCD
Pins not listed here are not used.	

Stand-Alone Modem Interfaces and Connectors

Computer (DTE) Interface

The stand-alone modem rear panel has one female DB25 connector. Pinouts are as follows:

Computer Interface

<i>Pin</i>	<i>Circuit</i>	<i>Function</i>
2	BA/103	TXD
3	BB/104	RXD
4	CA/105	RTS
5	CB/106	CTS
6	CC/107	DSR
7	AB/102	Signal Ground
8	CF/109	DCD
15	DB/114	TXCLK
17	DD/115	RXCLK
20	CD/108.1/2	DTR
22	CE/125	RI
24	DA/113	XTCLK
Pins not listed here are not used.		

Telephone Interface

The stand-alone modem rear panel has two RJ11 connectors, labelled LINE and PHONE. Pinouts are as follows:

Modems That Support Two-Wire Leased or Dial Connections

<i>LINE* Connector</i>	
Interface: RJ-11	
Connection Type: Two-Wire Leased-Line or Dial Line	
Pin	Function
2	Telset Ring (Alternative)
3	Two-wire Leased Line/Dial-Line Ring
4	Two-wire Leased Line/Dial-Line Tip
5	Telset Tip (Alternative)
<i>PHONE Connector</i>	
Interface: RJ-11	
Connection Type: Telephone	
Pin	Function
3	Telset Ring
4	Telset Tip
*Pins 2 and 5 are disconnected in some units. Pins not listed here are not used.	

Modems That Support Two- or Four-Wire Leased or Dial Connections

<i>PHONE/LINE Connector</i>	
Interface: RJ-11	
Connection Type: Dial Line and Telephone Set	
Pin	Function
2	Telset Ring
3	Dial-Line Ring
4	Dial-Line Tip
5	Telset Tip
<i>LEASE Connector</i>	
Interface: RJ-11	
Connection Type: Two- or Four-Wire Leased Line	
Pin	Function
2	Four-Wire Rx Tip
3	Two-Wire Ring/Four-Wire Tx Ring
4	Two-Wire Tip/Four-Wire Tx Tip
5	Four-Wire Rx Ring

Network Management Interface

The stand-alone modem rear panel has two female 8-pin DIN connectors. Pinouts are as follows:

Network Management Interface Pinouts

<i>Pin</i>	<i>NMS OUT</i>	<i>NMS IN</i>
2	TXD	TXD
3	RXD	RXD
4	RTS	RTS
7	Signal Ground	Signal Ground
8	DCD	DCD
Pins not listed here are not used.		

Power Interface and On/Off Switch

The stand-alone modem rear panel has one power connector.

Power Interface

<i>Power Type</i>	<i>Connector</i>
Low Voltage AC	Industry standard hollow co-axial

The On (1)/Off (0) switch supplies and removes power to the modem.

A power transformer accompanies each stand-alone modem. The unit conditions the power supply, as follows:

Power Requirements

<i>Characteristic</i>	<i>Requirement at Main Supply</i>	<i>Requirement at Modem Input</i>
Voltage	100/120/230/240 VAC*	9 VAC
Frequency	50/60 Hz	50/60 Hz
Input Current	150/120/80/70 mA	800 mA
*The power transformer is rated for one of these settings.		

Off-Line Configuration (OLC) Button

The off-line configuration button, labelled OLC, is located on the back of some stand-alone modems.

Pressing the button makes the modem enter command mode, in which the user in synchronous or leased-line environments can change configuration options.

Use the OLC button to change a configuration as follows.

Changing a Configuration With the OLC Button

Step	Stage
1	Change one or more configuration options.
2	Enter the Save to Option Set command (AT&W n , where n is 1 or 2).
3	Enter the Option Set to Power Up In command (AT&Y n , where n is: 0 for last-loaded option set; 1 for Option Set 1, or 2 for Option Set 2)
4	Press the OLC button. The modem restarts and powers up using the selected configuration option set.

Panel Indicators and Switches

Accessway enclosure cards and stand-alone modems have the following front panel indicators, except where noted. On a dual-modem card, each modem has a set of indicators. Vanguard 3460 V.34 Daughtercard modems have only the MR and OH indicators.

Front Panel Interface

<i>Indicator</i>	<i>Description</i>
MR Modem Ready/ Test Mode	<ul style="list-style-type: none"> • On: modem is ready to interwork with computer • Flashing: Modem is in V.54 test mode
TR Transmit/ Receive (Data Terminal Ready)	On: computer is asserting DTR (Circuit 108) to modem
OH Off Hook (connected to phone line)/ Ring Indicator	<p>On:</p> <ul style="list-style-type: none"> • Regular operation: modem is connected to dial line • Restoral operation: when regular operation is configured for leased-line or dial-line operation, and modem is operating on restoral dial line: modem is connected to dial line <p>Flashing: modem receiving Active Ring</p> <p>Off:</p> <ul style="list-style-type: none"> • In dial configuration: no call in progress, modem is disconnected from telephone line • In leased-line configuration: modem is connected to leased line
CD DataCarrier Detect	On: modem is receiving a valid carrier signal from a remote modem
RD Receive Data	Flashing: modem is transferring data received from a remote modem and command responses to computer
SD Send Data	Flashing: modem receiving transmit data and commands from computer

Front Panel Interface (continued)

Indicator	Description
Light bars	Operating-status indicators. Stand-alone modem only.
OLC button	Off-Line Configuration. (Only required with leased-line or synchronous applications, where no ACU is present.) Places the modem into a mode in which the configuration can be modified. On the stand-alone modem, the OLC button is on the <i>rear</i> panel.

Front-Panel User Interface

Figure A-2 shows the 3460 Fast'R *Plus* modem front panel interface.

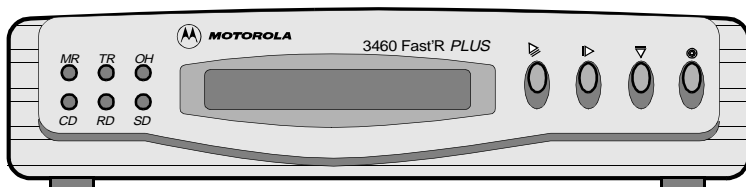

Figure A-2. 3460 Fast'R Plus Modem Front Panel Interface

LCD Display







The front panel has a 16-character alphanumeric LCD display. You access the configuration menu tree through the display, to:

- Configure the modem
- Store and display telephone numbers
- Initiate and answer calls
- Display status information
- Run on-line tests
- Enter passwords and network addresses

Control Buttons

The control buttons let you access parameters and options.

Front-Panel Control Buttons

Button	Function
 Return	Steps up through the menu tree from a parameter to a category, or from a category to the default display. Example: from Test= , pressing  displays the TEST OPTS category.
 Across	Steps through the parameters in a menu category. Example: From Test= , pressing  displays the Accept RDL option.
 Down	At the menu tree top level, steps through categories At a parameter within a category, steps through the options. Example: From Test=End Test , pressing  displays Test=:LAL .
 Enter	In the menu tree, selects an option and/or initiates an action. Allows you to toggle between using a telephone and the modem to establish a telephone connection.

Compatibility

The modem is compatible with modems that comply with the CCITT V-series specifications and ITU modulation modes, including the Motorola 326X Series, V.3400 Series, and "M" Series modems.

326X Leased-Line Operation Note

For optimum performance between a 3460 and a 326X in V.34 mode over a leased line, Motorola recommends the following configuration:

- Set the 3460 to V.34 Only modulation mode (AT*MM parameter)
- Set the 326X modulation mode to:
 - V.34 Auto if it is set to Originate
 - V.34 Only if it is set to Answer
- Set the maximum modem (DCE) rate (AT*MX parameter) to 31.2 on at least one modem.

Appendix B

Country-Specific Information

In This Appendix

This appendix describes modem functions and features that vary by country from the standard Universal International command set.

Country-Specific Parameters

Modems are pre-configured for a country or region of operation. These default options vary by country from the standard Universal International command set.

The tables that follow show, for each country or region, the default parameter option, the available options, and any other country-specific information. For descriptions of parameters and options, refer to Appendix A of the *3460 Fast'R User Guide*.

Australia, New Zealand

<i>Command</i>	<i>Command Name</i>	<i>Default Option</i>	<i>Available Options</i>
ATS0	Ring Count to Answer On	2	0, 1, 2, 4
AT*DR or AT*RD	Auto Redial	0	0, 1, 2, 3
ATS6	Blind Dial	4	4
AT*TT	Call Time-Out	0	0, 5
ATS10	DCD Loss Disconnect	15	0 - 255
AT*PT	Dial Type	1	0, 1, 2
AT*DX	Dial Transmit (Tx) Level	10	10 - 15
AT*DD	Dial Wait	0	0, 1, 2, 3
ATS11	DTMF Tone Length	72	72
AT&G	Guard Tone	2	1, 2
ATH	LAL Busy Out	Allowed	
AT*LX	Leased-Line Transmit (Tx) Level	10	10 - 20
ATS8	Pause Delay	4	4
AT&P	Pulse Dial Cycle	1	1
ATS30	Terminal Inactivity Timer	0	0 - 255
Other country-specific restrictions:			
(None)			
The characters AT or at precede all commands except: +++, #####, and A/			

Austria

<i>Command</i>	<i>Command Name</i>	<i>Default Option</i>	<i>Available Options</i>
ATS0	Ring Count to Answer On	1	0, 1, 2
AT*DR or AT*RD	Auto Redial	0	0, 1, 2, 3
ATS6	Blind Dial	4	3, 4, 6
AT*TT	Call Time-Out	0	0, 2
ATS10	DCD Loss Disconnect	70	30, 70
AT*PT	Dial Type	1	0, 1, 2
AT*DX	Dial Transmit (Tx) Level	9	6 - 13
AT*DD	Dial Wait	3	1, 2, 3
ATS11	DTMF Tone Length	72	72
AT&G	Guard Tone	2	1, 2
ATH	LAL Busy Out	Not allowed	
AT*LX	Leased-Line Transmit (Tx) Level	9	9 - 30
ATS8	Pause Delay	3	0 - 255
AT&P	Pulse Dial Cycle	0	0
ATS30	Terminal Inactivity Timer	60	18, 60
Other country-specific restrictions:			
DTMF dialing of the A, B, C, and D keys is not allowed.			
The characters AT or at precede all commands except: +++, #####, and A/			

Belgium

<i>Command</i>	<i>Command Name</i>	<i>Default Option</i>	<i>Available Options</i>
ATS0	Ring Count to Answer On	3	0, 2, 3, 4
AT*DR or AT*RD	Auto Redial	0	0, 1, 2, 3
ATS6	Blind Dial	3	3
AT*TT	Call Time-Out	2	0, 2
ATS10	DCD Loss Disconnect	15	0 - 255
AT*PT	Dial Type	0	0, 1, 2
AT*DX	Dial Transmit (Tx) Level	6	6 - 13
AT*DD	Dial Wait	4	4, 5, 6
ATS11	DTMF Tone Length	72	72
AT&G	Guard Tone	0	0, 1, 2
ATH	LAL Busy Out	Allowed	
AT*LX	Leased-Line Transmit (Tx) Level	9	9 - 30
ATS8	Pause Delay	3	0 - 255
AT&P	Pulse Dial Cycle	1	1
ATS30	Terminal Inactivity Timer	0	0 - 255
Other country-specific restrictions:			
(None)			
The characters AT or at precede all commands except: +++ , ##### , and A/			

Canada

<i>Command</i>	<i>Command Name</i>	<i>Default Option</i>	<i>Available Options</i>
ATS0	Ring Count to Answer On	0	0 - 255
AT*DR or AT*RD	Auto Redial	0	0 - 15
ATS6	Blind Dial	3	3
AT*TT	Call Time-Out	1	0, 1
ATS10	DCD Loss Disconnect	15	0 - 255
AT*PT	Dial Type	0	0, 1, 2
AT*DX	Dial Transmit (Tx) Level	9	9 - 16
AT*DD	Dial Wait	0	0, 2, 3, 9
ATS11	DTMF Tone Length	72	50 - 255
AT&G	Guard Tone	0	0, 1, 2
ATH	LAL Busy Out	Allowed	
AT*LX	Leased-Line Transmit (Tx) Level	0	0 - 30
ATS8	Pause Delay	3	0 - 255
AT&P	Pulse Dial Cycle	0	0, 1, 2
ATS30	Terminal Inactivity Timer	0	0 - 255
Other country-specific restrictions:			
(None)			
The characters AT or at precede all commands except: +++, #####, and A/			

Denmark, Netherlands, Luxembourg

<i>Command</i>	<i>Command Name</i>	<i>Default Option</i>	<i>Available Options</i>
ATS0	Ring Count to Answer On	1	0 - 255
AT*DR or AT*RD	Auto Redial	0	0 - 15
ATS6	Blind Dial	4	3, 4, 5
AT*TT	Call Time-Out	2	0, 2, 3
ATS10	DCD Loss Disconnect	15	15, 30, 45, 60, 90
AT*PT	Dial Type	0	0, 1, 2
AT*DX	Dial Transmit (Tx) Level	9	9 - 30
AT*DD	Dial Wait	3	0, 2, 3, 9
ATS11	DTMF Tone Length	77	77
AT&G	Guard Tone	0	0, 1, 2
ATH	LAL Busy Out	Allowed	
AT*LX	Leased-Line Transmit (Tx) Level	9	9 - 30
ATS8	Pause Delay	3	3
AT&P	Pulse Dial Cycle	1	0, 1, 2
ATS30	Terminal Inactivity Timer	0	0 - 255
Other country-specific restrictions:			
Flash Hook is disabled.			
The characters AT or at precede all commands except: +++, #####, and A/			

Finland

Command	Command Name	Default Option	Available Options
ATS0	Ring Count to Answer On	3	0 - 255
AT*DR or AT*RD	Auto Redial	0	0, 1, 2, 3
ATS6	Blind Dial	3	1 - 255
AT*TT	Call Time-Out	2	0, 2
ATS10	DCD Loss Disconnect	30 ¹	0 - 255
AT*PT	Dial Type	1	0, 1, 2
AT*DX	Dial Transmit (Tx) Level	11	10 - 30
AT*DD	Dial Wait	2	2, 3, 5, 9
ATS11	DTMF Tone Length	72	72
AT&G	Guard Tone	0	0, 1, 2
ATH	LAL Busy Out	Allowed	
AT*LX	Leased-Line Transmit (Tx) Level	9	9 - 30
ATS8	Pause Delay	3	0 - 255
AT&P	Pulse Dial Cycle	0	0
ATS30	Terminal Inactivity Timer	0	0 - 255
Other country-specific restrictions:			
¹ In V.21 and B103 modulation mode, DCD Loss Disconnect Time is 2, regardless of the value of S10. The value of S10 is not changed.			
The characters AT or at precede all commands except: +++, #####, and A/			

France

Command	Command Name	Default Option	Available Options
ATS0	Ring Count to Answer On	3	0, 3, 4
AT*DR or AT*RD	Auto Redial	0	0 - 5
ATS6	Blind Dial	3	3
AT*TT	Call Time-Out	5	0, 1, 2, 3, 5
ATS10	DCD Loss Disconnect	30	0, 30
AT*PT	Dial Type	1	0, 1, 2
AT*DX	Dial Transmit (Tx) Level	10	0 - 30
AT*DD	Dial Wait	4	3, 4
ATS11	DTMF Tone Length	72	72
AT&G	Guard Tone	2	1, 2
ATH	LAL Busy Out	Not allowed	
AT*LX	Leased-Line Transmit (Tx) Level	9	9 - 30
ATS8	Pause Delay	3	3, 6, 9, 12
AT&P	Pulse Dial Cycle	1	1
ATS30	Terminal Inactivity Timer	0	0 - 255
Other country-specific restrictions:			
France restricts S7 (Wait for Carrier). If the country code is France, the modem automatically sets S7=140. The available options are 2- 150.			
The characters AT or at precede all commands except: +++ , ##### , and A/			

S7 Parameter

The S7 parameter is country-specific for France only.

S-Register Command Cross-Reference

Register	Parameter	Command	Description
...
S7	Wait For Data Carrier (Country-specific for France only)	ATS7= <i>n</i> AT*DD9 AT*TT5	Set duration Dial Wait=S7 Call Timeout=S7
...
*Changed values are <i>not</i> automatically stored to non-volatile memory. To retain changed values, save them to an option set.			

Germany

<i>Command</i>	<i>Command Name</i>	<i>Default Option</i>	<i>Available Options</i>
ATS0	Ring Count to Answer On	3	0, 1, 2, 3, 4
AT*DR or AT*RD	Auto Redial	0	0 - 11
ATS6	Blind Dial	4	3, 4, 6
AT*TT	Call Time-Out	0	0, 2
ATS10	DCD Loss Disconnect	30	0, 30, 70
AT*PT	Dial Type	0	0
AT*DX	Dial Transmit (Tx) Level	10	1 - 13
AT*DD	Dial Wait	6	0, 2, 3, 5, 6
ATS11	DTMF Tone Length	85	85
AT&G	Guard Tone	0	0, 1, 2
ATH	LAL Busy Out	Not allowed	
AT*LX	Leased-Line Transmit (Tx) Level	9	9 - 30
ATS8	Pause Delay	3	0 - 255
AT&P	Pulse Dial Cycle	0	0
ATS30	Terminal Inactivity Timer	0	0 - 255
Other country-specific restrictions:			
Pulse dialing is not allowed.			
The characters AT or at precede all commands except: +++, #####, and A/			

India

<i>Command</i>	<i>Command Name</i>	<i>Default Option</i>	<i>Available Options</i>
ATS0	Ring Count to Answer On	0	0 - 255
AT*DR or AT*RD	Auto Redial	0	0 - 15
ATS6	Blind Dial	3	1 - 255
AT*TT	Call Time-Out	2	0, 2, 3, 5
ATS10	DCD Loss Disconnect	15	0 - 255
AT*PT	Dial Type	1	0, 1, 2
AT*DX	Dial Transmit (Tx) Level	9	0 - 30
AT*DD	Dial Wait	0	0, 2, 3, 9
ATS11	DTMF Tone Length	72	72
AT&G	Guard Tone	0	0, 1, 2
ATH	LAL Busy Out	Not allowed	
AT*LX	Leased-Line Transmit (Tx) Level	0	0 - 30
ATS8	Pause Delay	3	0 - 255
AT&P	Pulse Dial Cycle	0	0
ATS30	Terminal Inactivity Timer	0	0 - 255
Other country-specific restrictions:			
(None)			
The characters AT or at precede all commands except: +++, #####, and A/			

Italy

<i>Command</i>	<i>Command Name</i>	<i>Default Option</i>	<i>Available Options</i>
ATS0	Ring Count to Answer On	3	0, 3, 4
AT*DR or AT*RD	Auto Redial	0	0, 1, 2, 3
ATS6	Blind Dial	4	3 - 255
AT*TT	Call Time-Out	0	0, 5
ATS10	DCD Loss Disconnect	15	0 - 255
AT*PT	Dial Type	1	0, 1, 2
AT*DX	Dial Transmit (Tx) Level	9	3 - 13
AT*DD	Dial Wait	3	2, 3, 5, 9
ATS11	DTMF Tone Length	72	72
AT&G	Guard Tone	0	0, 1, 2
ATH	LAL Busy Out	Allowed	
AT*LX	Leased-Line Transmit (Tx) Level	9	9 - 30
ATS8	Pause Delay	3	0 - 255
AT&P	Pulse Dial Cycle	2	2
ATS30	Terminal Inactivity Timer	0	0 - 255
Other country-specific restrictions:			
(None)			
The characters AT or at precede all commands except: +++, #####, and A/			

Japan

<i>Command</i>	<i>Command Name</i>	<i>Default Option</i>	<i>Available Options</i>
ATS0	Ring Count to Answer On	0	0 - 255
AT*DR or AT*RD	Auto Redial	0	0, 1, 2
ATS6	Blind Dial	4	3, 4, 6
AT*TT	Call Time-Out	1	0, 1
ATS10	DCD Loss Disconnect	15	0 - 255
AT*PT	Dial Type	0	0, 1, 2
AT*DX	Dial Transmit (Tx) Level	15	9 - 30
AT*DD	Dial Wait	2	1, 2, 3
ATS11	DTMF Tone Length	72	72
AT&G	Guard Tone	0	0, 1, 2
ATH	LAL Busy Out	Allowed	
AT*LX	Leased-Line Transmit (Tx) Level	0	0 - 30
ATS8	Pause Delay	3	0 - 255
AT&P	Pulse Dial Cycle	1	1 - 3
ATS30	Terminal Inactivity Timer	0	0 - 255
Other country-specific restrictions:			
(None)			
The characters AT or at precede all commands except: +++, #####, and A/			

Malaysia

<i>Command</i>	<i>Command Name</i>	<i>Default Option</i>	<i>Available Options</i>
ATS0	Ring Count to Answer On	0	0, 1, 2
AT*DR or AT*RD	Auto Redial	0	0, 1, 2
ATS6	Blind Dial	3	1 - 255
AT*TT	Call Time-Out	2	0, 2, 3, 5
ATS10	DCD Loss Disconnect	15	0 - 255
AT*PT	Dial Type	1	0, 1, 2
AT*DX	Dial Transmit (Tx) Level	9	0 - 30
AT*DD	Dial Wait	0	0, 2, 3, 9
ATS11	DTMF Tone Length	72	72
AT&G	Guard Tone	0	0, 1, 2
ATH	LAL Busy Out	Not allowed	
AT*LX	Leased-Line Transmit (Tx) Level	0	0 - 30
ATS8	Pause Delay	3	0 - 255
AT&P	Pulse Dial Cycle	1	0, 1, 2
ATS30	Terminal Inactivity Timer	0	0 - 255
Other country-specific restrictions:			
(None)			
The characters AT or at precede all commands except: +++, #####, and A/			

Norway

<i>Command</i>	<i>Command Name</i>	<i>Default Option</i>	<i>Available Options</i>
ATS0	Ring Count to Answer On	2	0, 1, 2
AT*DR or AT*RD	Auto Redial	0	0 - 9
ATS6	Blind Dial	3	3
AT*TT	Call Time-Out	2	0, 2
ATS10	DCD Loss Disconnect	30	0, 30, 70
AT*PT	Dial Type	0	0
AT*DX	Dial Transmit (Tx) Level	10	10 - 30
AT*DD	Dial Wait	3	0, 2, 3, 5, 6
ATS11	DTMF Tone Length	72	72
AT&G	Guard Tone	0	0, 1, 2
ATH	LAL Busy Out	Allowed	
AT*LX	Leased-Line Transmit (Tx) Level	9	9 - 30
ATS8	Pause Delay	3	0 - 255
AT&P	Pulse Dial Cycle	0	0
ATS30	Terminal Inactivity Timer	0	0 - 255
Other country-specific restrictions:			
Pulse dialing is not allowed.			
The characters AT or at precede all commands except: +++, #####, and A/			

Portugal

<i>Command</i>	<i>Command Name</i>	<i>Default Option</i>	<i>Available Options</i>
ATS0	Ring Count to Answer On	0	0, 1, 2, 4
AT*DR or AT*RD	Auto Redial	0	0, 1, 2, 3, 4
ATS6	Blind Dial	3	1 - 255
AT*TT	Call Time-Out	2	0, 2, 3, 5
ATS10	DCD Loss Disconnect	15	0 - 255
AT*PT	Dial Type	0	0, 1, 2
AT*DX	Dial Transmit (Tx) Level	10	10 - 30
AT*DD	Dial Wait	0	0, 2, 3, 9
ATS11	DTMF Tone Length	72	72
AT&G	Guard Tone	0	0, 1, 2
ATH	LAL Busy Out	Not allowed	
AT*LX	Leased-Line Transmit (Tx) Level	9	9 - 30
ATS8	Pause Delay	3	0 - 255
AT&P	Pulse Dial Cycle	1	1
ATS30	Terminal Inactivity Timer	0	0 - 255
Other country-specific restrictions:			
DTMF dialing of the A, B, C, and D keys is not allowed.			
The characters AT or at precede all commands except: +++, #####, and A/			

Singapore

<i>Command</i>	<i>Command Name</i>	<i>Default Option</i>	<i>Available Options</i>
ATS0	Ring Count to Answer On	0	0, 1, 2
AT*DR or AT*RD	Auto Redial	0	0 - 9
ATS6	Blind Dial	3	1 - 255
AT*TT	Call Time-Out	2	0, 2, 3, 5
ATS10	DCD Loss Disconnect	15	0 - 255
AT*PT	Dial Type	1	0, 1, 2
AT*DX	Dial Transmit (Tx) Level	9	6 - 13
AT*DD	Dial Wait	0	0, 2, 3, 9
ATS11	DTMF Tone Length	72	72
AT&G	Guard Tone	0	0, 1, 2
ATH	LAL Busy Out	Not allowed	
AT*LX	Leased-Line Transmit (Tx) Level	0	6 - 13
ATS8	Pause Delay	3	0 - 255
AT&P	Pulse Dial Cycle	0	0
ATS30	Terminal Inactivity Timer	0	0 - 255
Other country-specific restrictions:			
(None)			
The characters AT or at precede all commands except: +++, #####, and A/			

South Africa

<i>Command</i>	<i>Command Name</i>	<i>Default Option</i>	<i>Available Options</i>
ATS0	Ring Count to Answer On	1	0 - 255
AT*DR or AT*RD	Auto Redial	0	0, 1, 2, 3
ATS6	Blind Dial	4	4
AT*TT	Call Time-Out	2	0, 2
ATS10	DCD Loss Disconnect	15	0 - 255
AT*PT	Dial Type	1	0, 1, 2
AT*DX	Dial Transmit (Tx) Level	9	6 - 13
AT*DD	Dial Wait	3	3, 4
ATS11	DTMF Tone Length	72	72
AT&G	Guard Tone	2	1, 2
ATH	LAL Busy Out	Allowed	
AT*LX	Leased-Line Transmit (Tx) Level	9	9
ATS8	Pause Delay	4	4
AT&P	Pulse Dial Cycle	1	1
ATS30	Terminal Inactivity Timer	0	0 - 255
Other country-specific restrictions:			
(None)			
The characters AT or at precede all commands except: +++, #####, and A/			

Spain

<i>Command</i>	<i>Command Name</i>	<i>Default Option</i>	<i>Available Options</i>
ATS0	Ring Count to Answer On	3	0 - 255
AT*DR or AT*RD	Auto Redial	0	0, 1, 2, 3
ATS6	Blind Dial	3	3
AT*TT	Call Time-Out	0	0
ATS10	DCD Loss Disconnect	30	30, 70
AT*PT	Dial Type	1	0, 1, 2
AT*DX	Dial Transmit (Tx) Level	11	10 - 30
AT*DD	Dial Wait	3	1, 2, 3
ATS11	DTMF Tone Length	135	135
AT&G	Guard Tone	2	0, 1, 2
ATH	LAL Busy Out	Not allowed	
AT*LX	Leased-Line Transmit (Tx) Level	9	9 - 30
ATS8	Pause Delay	3	0 - 255
AT&P	Pulse Dial Cycle	1	1
ATS30	Terminal Inactivity Timer	0	0 - 255
Other country-specific restrictions:			
(None)			
The characters AT or at precede all commands except: +++, #####, and A/			

Switzerland

<i>Command</i>	<i>Command Name</i>	<i>Default Option</i>	<i>Available Options</i>
ATS0	Ring Count to Answer On	2	0, 2
AT*DR or AT*RD	Auto Redial	0	0, 1, 2, 3
ATS6	Blind Dial	4	4
AT*TT	Call Time-Out	2	0, 2
ATS10	DCD Loss Disconnect	15	0 - 255
AT*PT	Dial Type	1	0, 1, 2
AT*DX	Dial Transmit (Tx) Level	9	9 - 30
AT*DD	Dial Wait	3	3, 4
ATS11	DTMF Tone Length	72	72
AT&G	Guard Tone	0	0, 1, 2
ATH	LAL Busy Out	Allowed	
AT*LX	Leased-Line Transmit (Tx) Level	9	9 - 30
ATS8	Pause Delay	3	3
AT&P	Pulse Dial Cycle	2	2
ATS30	Terminal Inactivity Timer	0	0 - 255
Other country-specific restrictions:			
(None)			
The characters AT or at precede all commands except: +++, #####, and A/			

Universal/International

<i>Command</i>	<i>Command Name</i>	<i>Default Option</i>	<i>Available Options</i>
ATS0	Ring Count to Answer On	0	0 - 255
AT*DR or AT*RD	Auto Redial	0	0 - 15
ATS6	Blind Dial	3	1 - 255
AT*TT	Call Time-Out	2	0, 2, 3, 5
ATS10	DCD Loss Disconnect	15	0 - 255
AT*PT	Dial Type	1	0, 1, 2
AT*DX	Dial Transmit (Tx) Level	9	0 - 30
AT*DD	Dial Wait	0	0, 2, 3, 9
ATS11	DTMF Tone Length	72	72
AT&G	Guard Tone	0	0, 1, 2
ATH	LAL Busy Out	Allowed	
AT*LX	Leased-Line Transmit (Tx) Level	0	0 - 30
ATS8	Pause Delay	3	0 - 255
AT&P	Pulse Dial Cycle	0	0, 1, 2
ATS30	Terminal Inactivity Timer	0	0 - 255
Other country-specific restrictions:			
(None)			
The characters AT or at precede all commands except: +++ , ##### , and A/			

Universal/International - CTR21

<i>Command</i>	<i>Command Name</i>	<i>Default Option</i>	<i>Available Options</i>
ATS0	Ring Count to Answer On	0	0 - 255
AT*DR or AT*RD	Auto Redial	0	0 - 15
ATS6	Blind Dial	4	3, 4, 5
AT*TT	Call Time-Out	2	0, 2, 3
ATS10	DCD Loss Disconnect	15	15, 30, 45, 60, 90
AT*PT	Dial Type	0	0, 1, 2
AT*DX	Dial Transmit (Tx) Level	9	9 - 30
AT*DD	Dial Wait	3	0, 2, 3, 9
ATS11	DTMF Tone Length	77	77
AT&G	Guard Tone	0	0, 1, 2
ATH	LAL Busy Out	Allowed	
AT*LX	Leased-Line Transmit (Tx) Level	0	0 - 30
ATS8	Pause Delay	3	0 - 255
AT&P	Pulse Dial Cycle	1	0, 1, 2
ATS30	Terminal Inactivity Timer	0	0 - 255
Other country-specific restrictions:			
Flash Hook is disabled.			
The characters AT or at precede all commands except: +++, #####, and A/			

Universal/International - CTR15, CTR17, CTR21

<i>Command</i>	<i>Command Name</i>	<i>Default Option</i>	<i>Available Options</i>
ATS0	Ring Count to Answer On	0	0 - 255
AT*DR or AT*RD	Auto Redial	0	0 - 15
ATS6	Blind Dial	4	3, 4, 5
AT*TT	Call Time-Out	2	0, 2, 3
ATS10	DCD Loss Disconnect	15	15, 30, 45, 60, 90
AT*PT	Dial Type	0	0, 1, 2
AT*DX	Dial Transmit (Tx) Level	9	9 - 30
AT*DD	Dial Wait	3	0, 2, 3, 9
ATS11	DTMF Tone Length	77	77
AT&G	Guard Tone	0	0, 1, 2
ATH	LAL Busy Out	Allowed	
AT*LX	Leased-Line Transmit (Tx) Level	9	9 - 30
ATS8	Pause Delay	3	0 - 255
AT&P	Pulse Dial Cycle	1	0, 1, 2
ATS30	Terminal Inactivity Timer	0	0 - 255
Other country-specific restrictions:			
Flash Hook is disabled.			
The characters AT or at precede all commands except: +++, #####, and A/			

Universal/International - K.21

<i>Command</i>	<i>Command Name</i>	<i>Default Option</i>	<i>Available Options</i>
ATS0	Ring Count to Answer On	0	0, 1, 2, 3, 4
AT*DR or AT*RD	Auto Redial	0	0 - 11
ATS6	Blind Dial	3	3, 4, 6
AT*TT	Call Time-Out	2	2
ATS10	DCD Loss Disconnect	15	0 - 255
AT*PT	Dial Type	1	0, 1, 2
AT*DX	Dial Transmit (Tx) Level	9	0 - 30
AT*DD	Dial Wait	0	0, 2, 3, 9
ATS11	DTMF Tone Length	72	72
AT&G	Guard Tone	0	0, 1, 2
ATH	LAL Busy Out	Allowed	
AT*LX	Leased-Line Transmit (Tx) Level	0	0 - 30
ATS8	Pause Delay	3	0 - 255
AT&P	Pulse Dial Cycle	0	0, 1, 2
ATS30	Terminal Inactivity Timer	0	0 - 255
Other country-specific restrictions:			
(None)			
The characters AT or at precede all commands except: +++ , ##### , and A/			

Universal/International - K.21- Czech Republic

<i>Command</i>	<i>Command Name</i>	<i>Default Option</i>	<i>Available Options</i>
ATS0	Ring Count to Answer On	0	0, 2, 3, 4
AT*DR or AT*RD	Auto Redial	0	0 - 11
ATS6	Blind Dial	3	3, 4, 6
AT*TT	Call Time-Out	2	2
ATS10	DCD Loss Disconnect	15	0 - 255
AT*PT	Dial Type	1	0, 1, 2
AT*DX	Dial Transmit (Tx) Level	9	0 - 30
AT*DD	Dial Wait	0	0, 2, 3, 9
ATS11	DTMF Tone Length	72	72
AT&G	Guard Tone	0	0, 1, 2
ATH	LAL Busy Out	Allowed	
AT*LX	Leased-Line Transmit (Tx) Level	0	0 - 30
ATS8	Pause Delay	3	0 - 255
AT&P	Pulse Dial Cycle	0	0, 1, 2
ATS30	Terminal Inactivity Timer	0	0 - 255
Other country-specific restrictions:			
(None)			
The characters AT or at precede all commands except: +++ , ##### , and A/			

U. S. A.

<i>Command</i>	<i>Command Name</i>	<i>Default Option</i>	<i>Available Options</i>
ATS0	Ring Count to Answer On	0	0 - 255
AT*DR or AT*RD	Auto Redial	0	0 - 15
ATS6	Blind Dial	3	1 - 255
AT*TT	Call Time-Out	2	0, 2, 3, 5
ATS10	DCD Loss Disconnect	15	0 - 255
AT*PT	Dial Type	0	0, 1, 2
AT*DX	Dial Transmit (Tx) Level	9	9 - 30
AT*DD	Dial Wait	0	0, 2, 3, 9
ATS11	DTMF Tone Length	72	50 - 255
AT&G	Guard Tone	0	0, 1, 2
ATH	LAL Busy Out	Allowed	
AT*LX	Leased-Line Transmit (Tx) Level	0	0 - 30
ATS8	Pause Delay	3	0 - 255
AT&P	Pulse Dial Cycle	0	0, 1, 2
ATS30	Terminal Inactivity Timer	0	0 - 255
Other country-specific restrictions:			
(None)			
The characters AT or at precede all commands except: +++, #####, and A/			

Appendix C

Attention (AT) Commands for Fax

In This Appendix

This section describes fax control and management (AT+) commands.

AT Command Set

AT (ATtention) commands are character sequences that you enter from a computer or network management system (NMS) to control and manage a modem.

The semi-colon is the separator character. Fax commands must be the last on the line when fax commands are entered on a line with other fax or data commands.

Table 2-1. Fax Class 1 AT Command Set

Command	Option	Description
+F commands control fax operation.		
For fax parameters:		
• The AT+F[parameter]? command returns the options for the parameter, or, if the parameter is not supported, ERROR.		
• The AT+F[parameter]=? command returns the current option for the parameter, or, if the parameter is not supported, ERROR.		
• The AT+F[parameter]=[value] command sets the option for the parameter, or, if the option or parameter is not supported, returns ERROR.		
Capabilities Identification and Control Commands		
+FCLASS?		Service Class
or		Reads the modem's Service Class.
+FCLASS=?		
	0	Data modem
	1	Service Class 1 fax modem
	2.0	Service Class 2.0 fax modem
The characters AT or at precede all commands except: +++ , ##### , and A/		
Default (pre-set) options are underlined.		

Table 2-1. Fax Class 1 AT Command Set (continued)

Command	Option	Description
+FCLASS=<i>n</i>		Service Class Sets the modem's Service Class.
	0	Data modem
	1	Service Class 1 fax modem
	2	Service Class 2.0 fax modem
+FMI?		Manufacturer ID Reads the manufacturer ID from the modem. The modem responds: Motorola
+FMM?		Modem ID Reads the modem ID from the modem. The modem responds: 3460
+FMR?		Software Revision Level Reads the software revision ID from the modem. The modem responds (example): 4.0
Action Commands		
+FRH=<i>n</i>		Specifies the modulation mode, training time, and data rate for received HDLC fax data frames (for control signalling).
	3	V.21 Ch2, 300 BPS
	24	V.27 ter, 2400 BPS
	48	V.27 ter, 4800 BPS
	72	V.29, 7200 BPS
	73	V.17, long train time, 7200 BPS
	74	V.17, short train time, 7200 BPS
	96	V.29, 9600 BPS
	97	V.17, long train time, 9600 BPS
	98	V.17, short train time, 9600 BPS
	121	V.17, long train time, 12000 BPS
	122	V.17, short train time, 12000 BPS
	145	V.17, long train time, 14400 BPS
	146	V.17, short train time, 14400 BPS

The characters **AT** or **at** precede all commands except: **+++**, **#####**, and **A/**
Default (pre-set) options are underlined.

Table 2-1. Fax Class 1 AT Command Set (continued)

Command	Option	Description
+FRM= <i>n</i>		Specifies the modulation mode, training time, and data rate for received fax data without HDLC framing.
	<i>n</i>	<i>Same options as +FRH</i>
+FRS= <i>n</i>		Waits for silence to be present on the line for the specified time. It responds "OK" to the DTE when the required length of silence has been detected or the DTE sends a character other than XON or XOFF, which are discarded.
	<i>n</i>	<i>n</i> = ms.
+FTH= <i>n</i>		Specifies the modulation mode, training time, and data rate for the modem's transmitted HDLC data frames (for control signalling).
	<i>n</i>	<i>Same options as +FRH</i>
+FTM= <i>n</i>		Specifies the modulation mode, training time, and data rate for transmitted fax data without HDLC framing.
	<i>n</i>	<i>Same options as +FRH</i>
+FTS= <i>n</i>		Transmit silence for specified time.
	<i>n</i>	<i>n</i> = ms. Stops transmission, waits for the specified time, then responds to the DTE with the "OK" result code.

Configuration Commands

+FLO= <i>n</i>	Flow Control
	Selects the computer/modem flow control method.
	0 None
	<u>1</u> XON/XOFF
	2 RTS/CTS
+FPR= <i>n</i>	Serial Port Rate
	Selects the computer/modem serial port rate. This parameter has no effect when +FCLASS=0.
	1 2400 BPS
	2 4800 BPS
	3 7200 BPS
	4 9600 BPS
	5 12.0 KBPS
	6 14.4 KBPS
	7 16.8 KBPS
	8 19.2 KBPS

The characters **AT** or **at** precede all commands except: +++, #####, and A/

Default (pre-set) options are underlined.

Table 2-1. Fax Class 1 AT Command Set (continued)

Command	Option	Description
	9	21.6 KBPS
	10	24.0 KBPS
	11	26.4 KBPS
	12	28.8 KBPS
	13	31.2 KBPS
	14	31.2 KBPS
	16	38.4 KBPS
	24	57.6 KBPS
	48	115.2 KBPS
	96	230.4 KBPS

The characters **AT** or **at** precede all commands except: **+++**, **#####**, and **A/**

Default (pre-set) options are underlined.

Table 2-2. Fax Class 2.0 AT Command Set

Command	Option	Description
<p>+F commands control fax operation.</p> <p>For fax parameters:</p> <ul style="list-style-type: none"> • The AT+F[parameter]? command returns the options for the parameter, or, if the parameter is not supported, ERROR. • The AT+F[parameter]=? command returns the current option for the parameter, or, if the parameter is not supported, ERROR. • The AT+F[parameter]=[value] command sets the option for the parameter, or, if the option or parameter is not supported, returns ERROR. 		
Capabilities Identification and Control Commands		
+FCLASS? or +FCLASS=?		Service Class Reads the modem's Service Class.
	0	Data modem
	1	Service Class 1 fax modem
	2.0	Service Class 2.0 fax modem
+FCLASS=n		Service Class Sets the modem's Service Class.
	0	Data modem
	1	Service Class 1 fax modem
	2.0	Service Class 2.0 fax modem
+FMI?		Manufacturer ID Reads the manufacturer ID from the modem. The modem responds: Motorola
+FMM?		Modem ID Reads the modem ID from the modem. The modem responds: 3460
+FMR?		Software Revision Level Reads the software revision ID from the modem. The modem responds (example): 4.0
The characters AT or at precede all commands except: +++ , ##### , and A/		
Parameters and options shown shaded gray vary by country. For your country's options, refer to the <i>3460 Fast'R Reference Guide</i> (T0022).		
Default (pre-set) options are underlined.		

Table 2-2. Fax Class 2.0 AT Command Set (continued)

Command	Option	Description
Action Commands		
+FDR		Data Receive Initiates a transition to Phase C data reception. Phase A, B, and C results shown in Table 2-3.
+FDT		Data Transmit Transmits a Phase C page.
+FIP		Default Resets Services Class 2.0 parameters to default values.
+FKS		Terminate Session Sends DCN at next opportunity and hangs up.
Configuration Commands		
+FCC=		Allows DTE to sense and set the capabilities of the fax modem. Sets values used to generate DIS (sends capabilities to remote modem).
	VR, BR, WD, LN, DF, EC, BF, ST	See Table 2-8
+FCR=<i>n</i>		Receive Fax Data Specifies whether the computer can receive fax data.
	0	No
	1	Yes
+FIS=		Allows DTE to sense and set the fax capabilities for current session. DCE copies +FCC into +FIS (generates DIS, DTC, or DCS).
	VR, BR, WD, LN, DF, EC, BF, ST	See Table 2-8
The characters AT or at precede all commands except: +++, #####, and A/		
Parameters and options shown shaded gray vary by country. For your country's options, refer to the <i>3460 Fast'R Reference Guide</i> (T0022).		
Default (pre-set) options are underlined.		

Table 2-2. Fax Class 2.0 AT Command Set (continued)

Command	Option	Description
+FCS=		Sets negotiated T.30 parameters for session.
	<i>VR, BR, WD, LN, DF, EC, BF, ST</i>	See Table 2-8
+FLI=	<i>a</i>	Defines local ID string <i>a</i> for TSI/CSI signals. Sent to remote modem.
+FPI=	<i>a</i>	Defines local polling ID string <i>a</i> for CIG signals. Sent to remote modem.
+FNR=	<i>r, t, i, n</i>	Controls the reporting of messages generated during T.30 Phase B negotiations. <i>r</i> - RX parameter messages <i>t</i> - TX parameter messages <i>i</i> - ID string messages <i>n</i> - non-standard frame messages For each sub-parameter, the options are:
	<u>0</u>	Prevents reporting of messages
	1	Reports messages
+FPS=	<i>n</i>	Contains value representing T.30 post page response; includes page quality and end-of-page status
	<u>1</u>	See Table 2-7
	2 - 4	See Table 2-7
The characters AT or at precede all commands except: +++ , ##### , and A/		
Parameters and options shown shaded gray vary by country. For your country's options, refer to the <i>3460 Fast'R Reference Guide</i> (T0022).		
Default (pre-set) options are underlined.		

Table 2-2. Fax Class 2.0 AT Command Set (continued)

Command	Option	Description
+FCQ=<i>r, t</i>		Controls copy quality checking (conformance to negotiated T.4 format) and correction by fax modem of: <i>r</i> - Received image data <i>t</i> - Transmitted image data
	<i>r</i> options:	
	<u>0</u>	Disables receive copy quality checking. The modem generates MCF (Copy Quality OK) responses and sets +FPS=1.
	<u>1</u>	Enables receive copy quality checking. The modem determines the post-page message and stores it in the +FPS parameter.
	2	Enables receive copy quality checking. The modem determines the post-page message, stores it in the +FPS parameter, and detects and corrects errors in data received from the remote station.
	<i>t</i> options:	
	<u>0</u>	Disables transmit copy quality checking.
	1	Enables transmit copy quality checking. The modem returns <CAN> to the computer if errors are detected
	2	Enables transmit copy quality checking. The modem detects and corrects errors in the data received from the local computer.
+FLO=<i>n</i>		Flow Control Specifies the computer/modem flow control method.
	0	None
	<u>1</u>	XON/XOFF
	2	RTS/CTS
+FPR=<i>n</i>		Serial Port Rate Specifies the computer/modem serial port rate. This parameter has no effect when +FCLASS=0.
	1	2400 BPS
	2	4800 BPS
	3	7200 BPS
The characters AT or at precede all commands except: +++, #####, and A/		
Parameters and options shown shaded gray vary by country. For your country's options, refer to the <i>3460 Fast'R Reference Guide</i> (T0022).		
Default (pre-set) options are underlined.		

Table 2-2. Fax Class 2.0 AT Command Set (continued)

Command	Option	Description
	4	9600 BPS
	5	12.0 KBPS
	6	14.4 KBPS
	7	16.8 KBPS
	8	19.2 KBPS
	9	21.6 KBPS
	10	24.0 KBPS
	11	26.4 KBPS
	12	28.8 KBPS
	13	31.2 KBPS
	14	31.2 KBPS
	16	38.4 KBPS
	24	57.6 KBPS
	48	115.2 KBPS
	96	230.4 KBPS
+FBO=		Controls mapping between PSTN facsimile data and the DTE-DCE link, for Phase C and Phase B/D data.
	<u>0</u>	Direct bit order for all data
	1	Reversed bit order for Phase C data; direct bit order for Phase B/D data
+FCR=<i>n</i>		Specifies whether the modem can receive message data.
	0	The modem cannot receive message data and cannot poll a remote device. The modem can send data and it can be polled for a document
	1	The modem can receive message data.
+FBU		Controls HDLC frame reporting
	<u>0</u>	Disable
	1	Enable
The characters AT or at precede all commands except: +++, #####, and A/		
Parameters and options shown shaded gray vary by country. For your country's options, refer to the <i>3460 Fast'R Reference Guide (T0022)</i> .		
Default (pre-set) options are underlined.		

Table 2-2. Fax Class 2.0 AT Command Set (continued)

Command	Option	Description
+FAA=<i>n</i>		Controls whether the modem can adaptively answer a call as a fax or data modem.
	<u>0</u>	The modem answers only as a Fax Class 2.0 device.
	<u>1</u>	The modem answers and automatically connects as either a fax modem or as a data modem. If a data modem is detected, the fax modem reports this by the +FDM response. It reconfigures itself to answer as a data modem, sets +FCLASS=0, and issues the appropriate result codes to the computer.
+FCT=<i>n</i>	0 - FFH (hex)	Determines how long the modem waits (in seconds) for a command from the computer after transmitting Phase C data.
	<u>1EH</u> (30 sec.)	Default
+FHS?		Reports the hang-up status code
+FBS?		Reports the size (in bytes) of the modem's transmit and receive data buffers.
The characters AT or at precede all commands except: +++ , ##### , and A/		
Parameters and options shown shaded gray vary by country. For your country's options, refer to the <i>3460 Fast'R Reference Guide</i> (T0022).		
Default (pre-set) options are underlined.		

The fax modem supports the V.25ter ATA, ATD*string*, and ATH commands. These commands are used to answer a call, dial a call, and hang up a call, respectively.

The function of these commands is the same as in data mode.

Result Messages and Codes

The modem follows most AT commands with messages that indicate its responses or actions. The following table shows messages the modem sends in response to AT commands and operating events.

Table 2-3. Result Messages and Codes

<i>Text Form</i>	<i>Numeric Form</i>
Call Progress Result Codes	
OK	0
CONNECT	1
RING	2
NO CARRIER	3
ERROR	4
NO DIALTONE	6
BUSY	7
NO ANSWER	8
Connect Message Result Codes, Reliable=Off	
CONNECT 300	30
CONNECT 600	31
CONNECT 1200	32
CONNECT 2400	33
CONNECT 4800	34
CONNECT 7200	35
CONNECT 9600	36
CONNECT 12000	37
CONNECT 14400	38
CONNECT 16800	39
CONNECT 19200	40
CONNECT 21600	41
CONNECT 24000	42
CONNECT 26400	43
CONNECT 28800	44
CONNECT 31200	45
CONNECT 33600	46

Table 2-3. Result Messages and Codes (continued)

Text Form	Numeric Form
CONNECT 38400	47
CONNECT 57600	48
CONNECT 115200	49
CONNECT 230400	50
Connect Message Result Codes, Reliable=Short	
CONNECT RELIABLE	60
CONNECT 1200 RELIABLE	61
CONNECT 2400 RELIABLE	62
CONNECT 4800 RELIABLE	63
CONNECT 7200 RELIABLE	64
CONNECT 9600 RELIABLE	65
CONNECT 12000 RELIABLE	66
CONNECT 14400 RELIABLE	67
CONNECT 16800 RELIABLE	68
CONNECT 19200 RELIABLE	69
CONNECT 21600 RELIABLE	70
CONNECT 24000 RELIABLE	71
CONNECT 26400 RELIABLE	72
CONNECT 28800 RELIABLE	73
CONNECT 31200 RELIABLE	74
CONNECT 33600 RELIABLE	75
CONNECT 38400 RELIABLE	76
CONNECT 57600 RELIABLE	77
CONNECT 115200 RELIABLE	78
CONNECT 230400 RELIABLE	79
Connect Message Result Codes, Reliable=Long	
CONNECT RELIABLE EC=(x) DC=(y)	60
CONNECT 1200 RELIABLE EC=(x) DC=(y)	61
CONNECT 2400 RELIABLE EC=(x) DC=(y)	62
CONNECT 4800 RELIABLE EC=(x) DC=(y)	63
CONNECT 7200 RELIABLE EC=(x) DC=(y)	64
CONNECT 9600 RELIABLE EC=(x) DC=(y)	65

Table 2-3. Result Messages and Codes (continued)

Text Form	Numeric Form
CONNECT 12000 RELIABLE EC=(x) DC=(y)	66
CONNECT 14400 RELIABLE EC=(x) DC=(y)	67
CONNECT 16800 RELIABLE EC=(x) DC=(y)	68
CONNECT 19200 RELIABLE EC=(x) DC=(y)	69
CONNECT 21600 RELIABLE EC=(x) DC=(y)	70
CONNECT 24000 RELIABLE EC=(x) DC=(y)	71
CONNECT 26400 RELIABLE EC=(x) DC=(y)	72
CONNECT 28800 RELIABLE EC=(x) DC=(y)	73
CONNECT 31200 RELIABLE EC=(x) DC=(y)	74
CONNECT 33600 RELIABLE EC=(x) DC=(y)	75
CONNECT 38400 RELIABLE EC=(x) DC=(y)	76
CONNECT 57600 RELIABLE EC=(x) DC=(y)	77
CONNECT 115200 RELIABLE EC=(x) DC=(y)	78
CONNECT 230400 RELIABLE EC=(x) DC=(y)	79
Remote Configuration Result Codes	
RC DENIED	12
RC ESTABLISHED	13
RC COMPLETE	15
RC ABORTED	16
Miscellaneous Result Codes	
PASSWORD PROTECTED	18
NETWORK MANAGEMENT INHIBITED	19
Test Pattern Result Code	
NO SYNC ACHIEVED	20
Fax Class 1 Result Codes	
OK	0
CONNECT	1
NO CARRIER	3
ERROR	4
+FCERROR	+F4
+FRH:3	
RING	2

Table 2-3. Result Messages and Codes (continued)

Text Form	Numeric Form
NO DIALTONE	6
BUSY	7
NO ANSWER	8
Fax Class 2.0 Responses	
+FCI - Remote CSI (Called Station ID) string.	
+FCO - Connection with Group 3 facsimile station established	
+FCS - DCS frame information. Negotiated T.30 parameters for session. Syntax: <i>VR, BR, WD, LN, DF, EC, BF, ST</i> . See Table 2-8.	
+FDM - Transition to Data Modem	
+FET - Post page message from transmitting station. Message codes are listed in Table 2-6.	
+FHR - HDLC data (T.30 Phase B and Phase D HDLC control frames) received by the DCE.	
+FHS - Call termination status. Status codes are listed in Table 2-5.	
+FHT - HDLC data (T.30 Phase B and Phase D HDLC control frames) transmitted by the DCE.	
+FIS - DIS frame information (identifies remote station capabilities)	
+FNC - Non-Standard Command negotiation frame.	
+FNF - Non-Standard Facilities negotiation frame. NSF FIF Frame octets. DLC flags and zero bits inserted for transparency are removed. Frame octets are reported in the order received. Syntax: NSF FIF (hex).	
+FNS - Non-Standard Set-up negotiation frame. Up to 90 hexadecimal octets, separated by spaces. Syntax: <i>hex-coded octet string</i> .	
+FPO - Remote station has document to poll (polling request).	
+FPI - Remote CIG (Polling Station ID) string. Syntax: <i>VR, BR, WD, LN, DF, EC, BF, ST</i> . See Table 2-8.	
+FPS - T.30 phase C page reception status; includes post page response to +FDR command. See Table 2-7.	
+FTC - DTC frame information (identifies remote station intention: request for polling, transmit command). Syntax: <i>VR, BR, WD, LN, DF, EC, BF, ST</i> . See Table 2-8.	
+FTI - Remote TSI (Transmit Station ID) string. Syntax: <i>TSI ID string</i> Remote TSI (Transmit Station ID) string, in reversed time sequence from that in which it was received.	

Table 2-3. Result Messages and Codes (continued)

<i>Text Form</i>	<i>Numeric Form</i>
Phase D +FDR Command Responses	
CONNECT - another page	
OK	
+FHS:00	

Table 2-4. Disconnect Reasons

<i>Code</i>	<i>Description</i>	<i>Code</i>	<i>Description</i>
1	DTR dropped	36	ABT timeout, no answer
2	ATH command issued	37	ABT timeout, busy after ringback
3	Remote disconnected	38	Denied; manager down
4	Manager request	39	Error correction retransmit level
5	Configuration changed	40	Error correction remote requested
6	Restoral - Manager	41	Error correction no valid packet rev'd
7	End Restoral - Manager	42	Error correction establishment error
8	MI/MIC signal trans to off	44	Error correction negotiation failure
9	Talk/Data pushed	45	Error correction protocol violation
10	End restoral - DTR	46	Error correction bad parameter
12	Off-line test initiated	47	Error correction data compr error
13	Training failure	48	FSK & rel mode invalid
14	Sec fail - Password invalid	49	Restoral - DTR
15	Security callback	51	Restoral - Auto
16	End restoral - Auto	52	Restoral - Answer
17	Error corr disc	55	End Restoral - D to L Timeout
18	Already connected	56	Lease Line Test
19	Dial aborted	57	Lease Line Test - Manager
20	Busy tone detected	58	Lease Line Test Failed
21	No dial tone detected	59	External Option Set selected
22	Longspace detected	61	Lease Line Test Passed
23	Incoming call	62	Sec fail - No Callback number provided

Table 2-4. Disconnect Reasons (continued)

<i>Code</i>	<i>Description</i>	<i>Code</i>	<i>Description</i>
24	DTR not in proper state	63	Sec fail - Manager Timeout
25	Number Forbidden or Delayed	64	Sec fail - Invalid callback number
26	Retrain threshold exceeded	65	Sec fail - Inter-digit timeout
27	Ans/Orig mode changed-Pin 11	66	DTE inactivity timer expired
28	No stored number to dial	67	Restoral - ACU
29	Test in progress	68	End restoral - ACU
30	Callback in progress	69	Restoral - DTR ACU
31	FSK & sync mode invalid	70	End restoral - DTR
32	Semicolon detected	74	Remote disconnect w/o sending PSTN
33	ABT timeout, no ringback	75	Configuration change caused disconnect
34	ABT timeout, with ringback	76	Retrain time exceeded
35	ABT timeout, no call progress	77	

Table 2-5. +FHS Command Responses: Hang-Up Status Codes

<i>Value</i>	<i>Description</i>
<i>Call placement and termination hang-up codes:</i>	
00	Normal end of connection
01	Ring Detect without successful handshake
02	Call aborted, from +FKS or <CAN>
03	No Loop Current
04	Ringback detected, no answer (time-out)
05	Ringback detected, answer without CED
<i>Transmit Phase A and miscellaneous errors:</i>	
10	Unspecified Phase A error
11	No answer (T.30 T1 time-out)
<i>Transmit Phase B hang-up codes:</i>	
20	Unspecified Transmit Phase B error
21	Remote cannot receive or send
22	"Command Received?" error in transmit Phase B
23	"Command Received?" invalid command received
24	"Response Received?" error

Table 2-5. +FHS Command Responses: Hang-Up Status Codes (continued)

Value	Description
25	DCS sent 3 times without response
26	DIS/DTC received 3 times; DCS not recognized
27	Failure to train at 2400 bps or +FMS value
28	"Response Received?" invalid response received
<i>Transmit Phase C Hang-up Codes</i>	
40	Unspecified Transmit Phase C error
41	Unspecified image format error
42	Image conversion error
43	DTE to DCE data underflow
44	Unrecognized transparent data command
45	Image error, line length wrong
46	Image error, page length wrong
47	Image error, wrong compression code
<i>Transmit Phase D Hang-up Codes</i>	
50	Unspecified Transmit Phase D error
51	"Response Received?" error
52	No response to MPS repeated 3 times
53	Invalid response to MPS
54	No response to EOP repeated 3 times
55	Invalid response to EOP
56	No response to EOM repeated 3 times
57	Invalid response to EOM
58	Unable to continue after PIN or PIP
<i>Receive Phase B Hang-up Codes</i>	
70	Unspecified Receive Phase B error
71	"Response Received?" error
72	"Command Received?" error
73	T.30 T2 time-out, expected page not received
74	T.30 T1 time-out after EOM received
<i>Receive Phase C Hang-up Codes</i>	
90	Unspecified Receive Phase C error
91	Missing EOL after 5 seconds
92	Bad CRC or frame (ECM mode)
93	DCE to DTE buffer overflow

Table 2-5. +FHS Command Responses: Hang-Up Status Codes (continued)

Value	Description
<i>Receive Phase D Hang-up Codes</i>	
A0	Unspecified Receive Phase D error
A1	“Response Received?” invalid response received
A2	“Command Received?” invalid response received
A3	Unable to continue after PIN or PIP

Table 2-6. T.30 Post-Page Message Codes

PPM Code	T.30 Label	Description
0	MPS	Another page next, same document
1	EOM	Another document next
2	EOP	No more pages or documents
3	PRI-MPS	Another page next, same document, procedure interrupt requested
4	PRI-EOM	Another document next, procedure interrupt requested
5	PRI-EOP	No more pages or documents, procedure interrupt requested

Table 2-7. T.30 Post-Page Response Codes

Value	T.30 Label	Result Code	Description
1	MCF	OK	Page OK
2	RTN	ERROR	Page bad; retrain requested.
3	RTP	OK	Page good; retrain requested.
4	PIP	OK	Page good; remote request for procedure interrupt accepted.
5	PIN	ERROR	Page bad; retrain requested; remote request for procedure interrupt accepted.

Table 2-8. Frame Sub-Parameters

Label	Function	Value	Description	
VR	Vertical Resolution	0	Normal	
		1	Fine	
BR	Bit Rate	0	2400 bps	
		1	4800 bps	
		2	7200 bps	
		3	9600 bps	
		4	12000 bps	
		5	14400 bps	
WD	Page Width	0	1728 pixels in 215 am	
LN	Page Length	0	A4, 297 am	
DF	Data Compression Format	0	1-D Modified Huffman	
EC	Error Correction	0	Disable ECM	
BF	Binary File Transfer	0	Disable BFT	
ST	Minimum Scan Time/Line		VR = normal	VR = fine
		0	0 msec	0 msec
		1	5 msec	5 msec
		2	10 msec	5 msec
		3	10 msec	10 msec
		4	20 msec	10 msec
		5	20 msec	20 msec
		6	40 msec	20 msec
7	40 msec	40 msec.		

Symbols

- + commands
 - action C-2, C-6
 - capabilities-identification and control C-1, C-5

Numerics

- 326X Series modem A-19
- 9000 NMS A-6

A

- AC power supply module A-5
- Across button A-19
- AT commands C-1
- Audience vii
- Australia B-2
- Austria B-3

B

- backplane A-5
- Belgium B-4
- buttons, control A-19

C

- Call Progress Result Codes C-11
- Callback 2-4
- Callback Verification 2-1
- Canada B-5
- CCITT A-19
- CD LED A-17
- Change password 2-4
- Changing a configuration with the OLC button A-10
- clips for stacking A-1
- Computer Interface A-8, A-12
- configuration options
 - front panel A-19
- Configuration/phone number access restriction 2-3
- Connect Message Result Codes C-11, C-12
- Connectors A-6, A-7, A-11, A-13, A-14
- CSA A-3

D

- DC power supply module A-5
- Denmark B-6
- DIAL Connector A-11
- Dial Restriction 2-1, 2-4
- dimensions A-1
- Down button A-19
- Downloading documentation and software ii

E

- EIA/TIA-232E A-8
- Electromagnetic specifications A-4
- emissions standards A-4
- Enabling Callback Verification and Dial Restriction 2-2
- Enabling Password Verification by a Local Modem 2-1
- Enter button A-19

F

- Fax Class 1 Result Codes C-13
- Fax Class 2.0 Result Codes C-14
- fax specifications A-2
- Finland B-7
- France B-8
- Front Panel Interface A-17

G

- Germany B-9

H

- heat output A-1

I

- India B-10
- interoperability A-2
- Italy B-11
- ITU A-19
- ITU-T V.24 A-8

J

- Japan B-12

L

LEASE Connector A-11, A-14
LINE A Connector A-7
LINE B Connector A-7
LINE connector A-13
Lock Configuration 2-4
Luxembourg B-6

M

M Series modem A-19
Malaysia B-13
Mass-termination connectors A-8
Mass-Termination Interface Pinouts A-9
Messages spéciaux
 Important vii
Miscellaneous Result Codes C-13
MODEM A and MODEM B Connectors A-6
MODEM A and MODEM B Mass Line-Termination Connectors A-6
Motorola 9000 OMS Network Management System 1-1
Motorola Web site ii
MR LED A-17

N

Netherlands B-6
network management A-6
Network Management Interface Pinouts A-9, A-11, A-14
New Zealand B-2
Non-Operating Conditions A-3
Norway B-14

O

Off-Line Configuration (OLC) button A-10
Off-line Configuration (OLC) button A-15
OH LED A-17
OLC button A-10, A-15
On (1)/Off (0) switch A-15
Operating Conditions A-3
operating modes A-2

P

password 2-1
Password protection 2-4
Password Verification 2-1
Password verification 2-1
PHONE connector A-13
PHONE/LINE Connector A-14
Phonebook 2-3
Pinouts A-8, A-12, A-13, A-14
Portugal B-15
Power connector A-9, A-15
Power Interface A-15
Power Requirements A-15
power supply module A-5
Power surges 1-1
power transformer A-15

R

RD LED A-17
Regulatory labels A-3
relative humidity A-3
Remote Configuration Result Codes C-13
Repair 1-3
Result Codes
 Call Progress C-11
 Connect Message C-11
 Fax C-13, C-14
 Miscellaneous C-13
 Remote Configuration C-13
 Test Pattern C-13
Return button A-19
RJ11 connectors A-8, A-13
RJ11 Interface Pinouts A-8

S

safety standards A-3
SD LED A-17
Singapore B-16
South Africa B-17
Spain B-18
Special notices
 description vii
Specifications A-1
S-Register Command Cross-Reference B-8
Stacking modems A-3

S (Continued)

stacking modems **A-1**
stand-alone modem **A-1**
Switzerland **B-19**

T

temperature **A-3**
Test Pattern Result Code **C-13**
TR LED **A-17**
transformer **A-1**
TUV **A-3**

U

U.S.A. **B-25**
UL **A-3**
Universal/International **B-20**
Universal/International - CTR15, CTR17, CTR21 **B-22**
Universal/International - CTR21 **B-21**
Universal/International - K.21 **B-23**
Universal/International - K.21 Czech Republic **B-24**
Universal/International command set **B-1**

V

V.3400 Series modem **A-19**
Vanguard **A-11**
Vanguard 3460 V.34 Daughtercard modem **1-1**
vibration and shock **A-3**

W

Wait For Data Carrier **B-8**
Warning statement
 connecting ports **iii**
 lightning **1-1**
Warranty **1-3**
weight **A-1**
WICHTIG-Hinweis, Beschreibung **vii**
World-Wide Web **ii**