

USER GUIDE

**12 Volt Power Over
Ethernet Adapter Kit**

Model: WAPPOE12 (EU)



About This Guide

Icon Descriptions

While reading through the User Guide you may see various icons that call attention to specific items. Below is a description of these icons:



NOTE: This check mark indicates that there is a note of interest and is something that you should pay special attention to while using the product.



WARNING: This exclamation point indicates that there is a caution or warning and it is something that could damage your property or product.



WEB: This globe icon indicates a noteworthy website address or e-mail address.

Online Resources

Website addresses in this document are listed without **http://** in front of the address because most current web browsers do not require it. If you use an older web browser, you may have to add **http://** in front of the web address.

Resource	Website
Linksys	www.linksys.com
Linksys International	www.linksys.com/international
Glossary	www.linksys.com/glossary
Network Security	www.linksys.com/security

Copyright and Trademarks



Linksys, Cisco and the Cisco Logo are registered trademarks or trademarks of Cisco Systems, Inc. and/or its affiliates in the U.S. and certain other countries. Copyright © 2008 Cisco Systems, Inc. All rights reserved. Other brands and product names are trademarks or registered trademarks of their respective holders.

Chapter 1: Product Overview	1
Introduction	1
Injector	1
Splitter	2
Chapter 2: Wireless Security Checklist	3
General Network Security Guidelines	3
Additional Security Tips	3
Chapter 2: Configuration	4
Overview	4
Power on a Device that Uses a Standard Power Adapter	4
Power on a Device that Uses Inline Power	5
Appendix A: Specifications	6
Appendix B: Warranty Information	7
Limited Warranty	7
Appendix C: Regulatory Information	9
FCC Statement	9
Safety Notices	9
Industry Canada Statement	9
EC Declaration of Conformity (Europe)	9
User Information for Consumer Products Covered by EU Directive 2002/96/EC on Waste Electric and Electronic Equipment (WEEE)	10
Appendix D: Software License Agreement	14
Software in Linksys Products	14
Software Licenses	14

Chapter 1:

Product Overview

Introduction

Thank you for choosing the Linksys 12 Volt Power Over Ethernet Adapter Kit, comprised of the Injector and Splitter. The Injector sends power and data over the Ethernet cable to the Splitter. Then the Splitter separates the data and power back into two cables and delivers them to the remotely located access point or other network device that requires a 12-volt power input. The Injector can also be used by itself with any Power Over Ethernet (POE)-enabled network device that accepts 48 volts directly on a POE port.



NOTE: If your Linksys product uses a 5-volt power input, then you should use the 5-volt kit, model number: WAPPOE.

This is a list of compatible Linksys products, alphabetized by model number:

- ADSLMUE1 (all versions) - ADSL Modem with USB & Ethernet
- AG041 - ADSL Gateway with 4-Port Switch
- BEFSX41 (versions 1 and 2) - Broadband Firewall Router with 4-Port Switch/VPN Endpoint
- BEFW11S4 (version 4) - Wireless-B Broadband Router
- RT31P2 - Broadband Router with 2 Phone Ports
- WAG54G (versions 1.2 and 2) - Wireless-G ADSL Gateway
- WAP54G (version 2) - Wireless-G Access Point
- WCG200 (all versions) - Wireless-G Cable Gateway
- WGA54G - Wireless-G Game Adapter
- WPS54GU2 - Wireless-G PrintServer for USB 2.0
- WRK54G - Wireless-G Broadband Router
- WRT54G - Wireless-G Broadband Router
- WRT54GS - Wireless-G Broadband Router with SpeedBooster
- WRT54GP2 - Wireless-G Broadband Router with 2 Phone Ports

Injector

The Injector's built-in cable and ports are located on side panels.

Injector's First Side Panel

The Power & Data OUT port is located on the Injector's first side panel.



Power & Data OUT This port allows you to connect the Injector to the Splitter or a network device that supports inline power. (You will use the included Ethernet network cable to make this connection.)

Injector's Second Side Panel

The built-in Ethernet network cable and Power port are located on the Injector's second side panel.



Power The Power port is where you will connect the included adapter.

Ethernet IN The Injector has a built-in Ethernet network cable. You will connect this cable to one of the Ethernet network ports on your router or switch.

Injector's LED

The Power LED is located on the top of the Injector.



- Power** (Green) The Power LED lights up when the Injector is powered on and ready for use.

Splitter

The Splitter's built-in cables and port are located on side panels.

Splitter's First Side Panel

The Power & Data IN port is located on the Injector's first side panel.



- Power & Data IN** This port allows you to connect the Splitter to the Injector. (You will use the included Ethernet network cable to make this connection.)

Splitter's Second Side Panel

The built-in Ethernet network and Power cables are located on the Splitter's second side panel.



Ethernet OUT The Splitter has a built-in Ethernet network cable. You will connect this cable to the Ethernet network port of your remotely located access point or other network device.

Power The Splitter has a built-in power cord. You will connect this cord to the Power port of your remotely located access point or other network device.

Splitter's LED

The Splitter's LED is located on the top of the Splitter.



- Power** (Green) The Power LED lights up when the Splitter is powered on and ready for use.

Chapter 2: Wireless Security Checklist

Wireless networks are convenient and easy to install, so homes with high-speed Internet access are adopting them at a rapid pace. Because wireless networking operates by sending information over radio waves, it can be more vulnerable to intruders than a traditional wired network. Like signals from your cellular or cordless phones, signals from your wireless network can also be intercepted. Since you cannot physically prevent someone from connecting to your wireless network, you need to take some additional steps to keep your network secure.

1. Change the default wireless network name or SSID

Wireless devices have a default wireless network name or Service Set Identifier (SSID) set by the factory. This is the name of your wireless network, and can be up to 32 characters in length. Linksys wireless products use **linksys** as the default wireless network name. You should change the wireless network name to something unique to distinguish your wireless network from other wireless networks that may exist around you, but do not use personal information (such as your Social Security number) because this information may be available for anyone to see when browsing for wireless networks.

2. Change the default password

For wireless products such as access points, routers, and gateways, you will be asked for a password when you want to change their settings. These devices have a default password set by the factory. The Linksys default password is **admin**. Hackers know these defaults and may try to use them to access your wireless device and change your network settings. To thwart any unauthorized changes, customize the device's password so it will be hard to guess.

3. Enable MAC address filtering

Linksys routers and gateways give you the ability to enable Media Access Control (MAC) address filtering. The MAC address is a unique series of numbers and letters assigned to every networking device. With MAC address filtering enabled, wireless network access is provided solely for wireless devices with specific MAC addresses. For example, you can specify the MAC address of each computer in your home so that only those computers can access your wireless network.

4. Enable encryption

Encryption protects data transmitted over a wireless network. Wi-Fi Protected Access (WPA/WPA2) and Wired Equivalency Privacy (WEP) offer different levels of security for wireless communication.

A network encrypted with WPA/WPA2 is more secure than a network encrypted with WEP, because WPA/WPA2 uses dynamic key encryption. To protect the information as it passes over the airwaves, you should enable the highest level of encryption supported by your network equipment.

WEP is an older encryption standard and may be the only option available on some older devices that do not support WPA.

General Network Security Guidelines

Wireless network security is useless if the underlying network is not secure.

- Password protect all computers on the network and individually password protect sensitive files.
- Change passwords on a regular basis.
- Install anti-virus software and personal firewall software.
- Disable file sharing (peer-to-peer). Some applications may open file sharing without your consent and/or knowledge.

Additional Security Tips

- Keep wireless routers, access points, or gateways away from exterior walls and windows.
- Turn wireless routers, access points, or gateways off when they are not being used (at night, during vacations).
- Use strong passphrases that are at least eight characters in length. Combine letters and numbers to avoid using standard words that can be found in the dictionary.



WEB: For more information on wireless security, visit www.linksys.com/security

Chapter 2: Configuration

Overview

This chapter gives instructions on how to connect the Power Over Ethernet Kit. Once connected, the Kit will transmit data and power over the Ethernet network cable to your remotely located network device.

The diagram shows an example of how the Kit can be connected to a wired switch and a wireless access point.

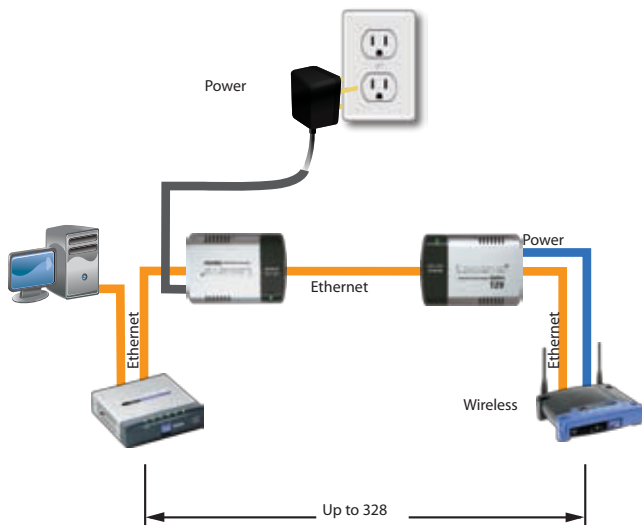

To connect the Kit to a device with a conventional power port, proceed to the section, "Power on a Device that Uses a Standard Power Adapter." To connect the Injector to a device that supports inline power, proceed to the section, "Power on a Device that Uses Inline Power."

Power on a Device that Uses a Standard Power Adapter

Use the Injector and Splitter to power up a device that uses a standard power adapter. Follow these instructions:

1. Connect the Injector's built-in Ethernet network cable to your router, switch, or other network device.

2. Connect the Kit's included Ethernet network cable to the Injector's Power & Data OUT port.



NOTE: If this cable is not long enough, then you can use your own Ethernet network cable.

3. Then connect the other end to the Splitter's Power & Data IN port.



4. Connect the Splitter's built-in Ethernet network cable to the Ethernet port of your remotely located access point or other network device.
5. Connect the Splitter's Power cord to the Power port of your remotely located access point or other network device.



NOTE: If the plug of the Splitter's Power cord does not fit into your network device, then use the included barrel jack adapter. Plug the Splitter's Power cord into the jack end, and plug the other end of the barrel jack adapter into the Power port of your network device.



6. Connect the Kit's power adapter to the Injector, and plug the other end into an electrical outlet or surge protector.



Congratulations! The installation of the 12 Volt Power Over Ethernet Kit is complete.

Power on a Device that Uses Inline Power

Use only the Injector to power up a device that supports inline power. Follow these instructions:

1. Connect the Injector's built-in Ethernet network cable to your router, switch, or other network device.
2. Connect the Kit's included Ethernet network cable to the Injector's Power & Data OUT port.



3. Then connect the other end to the Ethernet port of your remotely located access point or other network device.



NOTE: If the plug of the Splitter's Power cord does not fit into your network device, then use the included barrel jack adapter. Plug the Splitter's Power cord into the jack end, and plug the other end of the barrel jack adapter into the Power port of your network device.

4. Connect the Kit's power adapter to the Injector, and plug the other end into an electrical outlet or surge protector.



Congratulations! The installation of the Power Over Ethernet Kit is complete.

Appendix A: Specifications

Model	WAPPOE12
Standards	IEEE 802.3, 802.3u
Ports	Injector: Power, Data and
Power OUT	Splitter: Data and Power IN
Cabling Type	Category 5 or better
LED	Power
Environmental	
Dimensions	3.15" x 0.87" x 2.20" (80 x 22 x 56 mm)
Weight	2.65 oz. (0.075 kg)
Power	External Adapter: 100~240VAC, Injector 48VDC
Certification	FCC Class B
Operating Temp.	32 to 104°F (0 to 40°C)
Storage Temp.	-4 to 158°F (-20 to 70°C)
Operating Humidity	10 to 85% Noncondensing
Storage Humidity	5 to 90% Noncondensing

Specifications are subject to change without notice.

Appendix B: Warranty Information

Limited Warranty

Linksys warrants that this Linksys hardware product will be substantially free of defects in materials and workmanship arising under normal use during the Warranty Period, which begins on the date of purchase by the original end-user purchaser and lasts for the period specified below:

- Two (2) years for new product
- Ninety (90) days for refurbished product

This limited warranty is non-transferable and extends only to the original end-user purchaser. Your exclusive remedy and Linksys' entire liability under this limited warranty will be for Linksys, at its option, to (a) repair the product with new or refurbished parts, (b) replace the product with a reasonably available equivalent new or refurbished Linksys product, or (c) refund the purchase price of the product less any rebates. Any repaired or replacement products will be warranted for the remainder of the original Warranty Period or thirty (30) days, whichever is longer. All products and/or parts that are replaced become the property of Linksys.

This limited warranty shall apply in addition to any statutory or other rights which you may have under a contract of sale.

Exclusions and Limitations

This limited warranty does not apply if: (a) the product assembly seal has been removed or damaged, (b) the product has been altered or modified, except by Linksys, (c) the product damage was caused by use with non-Linksys products, (d) the product has not been installed, operated, repaired, or maintained in accordance with instructions supplied by Linksys, (e) the product has been subjected to abnormal physical or electrical stress, misuse, negligence, or accident, (f) the serial number on the Product has been altered, defaced, or removed, or (g) the product is supplied or licensed for beta, evaluation, testing or demonstration purposes for which Linksys does not charge a purchase price or license fee.

ALL SOFTWARE PROVIDED BY LINKSYS WITH THE PRODUCT, WHETHER FACTORY LOADED ON THE PRODUCT OR CONTAINED ON MEDIA ACCOMPANYING THE PRODUCT, IS PROVIDED "AS IS" WITHOUT ANY WARRANTY OF ANY KIND. Without limiting the foregoing, Linksys does not warrant that the operation of the product or software will be uninterrupted or error free. Also, due to the continual development of new techniques for intruding upon and attacking networks, Linksys does not warrant that the product, service, software or any equipment, system or

network on which the product or software is used will be free of vulnerability to intrusion or attack. The product may include or be bundled with third party software or service offerings. This limited warranty shall not apply to such third party software or service offerings. This limited warranty does not guarantee any continued availability of a third party's service for which this product's use or operation may require.

TO THE EXTENT NOT PROHIBITED BY LAW, ALL IMPLIED WARRANTIES AND CONDITIONS OF MERCHANTABILITY, SATISFACTORY QUALITY OR FITNESS FOR A PARTICULAR PURPOSE ARE LIMITED TO THE DURATION OF THE WARRANTY PERIOD. ALL OTHER EXPRESS OR IMPLIED CONDITIONS, REPRESENTATIONS AND WARRANTIES, INCLUDING, BUT NOT LIMITED TO, ANY IMPLIED WARRANTY OF NON-INFRINGEMENT, ARE DISCLAIMED. Some jurisdictions do not allow limitations on how long an implied warranty lasts, so the above limitation may not apply to you. This limited warranty gives you specific legal rights, and you may also have other rights which vary by jurisdiction.

TO THE EXTENT NOT PROHIBITED BY LAW, IN NO EVENT WILL LINKSYS BE LIABLE FOR ANY LOST DATA, REVENUE OR PROFIT, OR FOR SPECIAL, INDIRECT, CONSEQUENTIAL, INCIDENTAL OR PUNITIVE DAMAGES, REGARDLESS OF THE THEORY OF LIABILITY (INCLUDING NEGLIGENCE), ARISING OUT OF OR RELATED TO THE USE OF OR INABILITY TO USE THE PRODUCT (INCLUDING ANY SOFTWARE), EVEN IF LINKSYS HAS BEEN ADVISED OF THE POSSIBILITY OF SUCH DAMAGES. IN NO EVENT WILL LINKSYS' LIABILITY EXCEED THE AMOUNT PAID BY YOU FOR THE PRODUCT. The foregoing limitations will apply even if any warranty or remedy provided under this limited warranty fails of its essential purpose. Some jurisdictions do not allow the exclusion or limitation of incidental or consequential damages, so the above limitation or exclusion may not apply to you.

Obtaining Warranty Service

If you have a question about your product or experience a problem with it, please go to www.linksys.com/support where you will find a variety of online support tools and information to assist you with your product. If the product proves defective during the Warranty Period, contact Linksys Technical Support for instructions on how to obtain warranty service. The telephone number for Linksys Technical Support in your area can be found in the product User Guide and at www.linksys.com. Have your product serial number and proof of purchase on hand when calling. A DATED PROOF OF ORIGINAL PURCHASE IS REQUIRED TO PROCESS WARRANTY CLAIMS. If you are requested to return your product, you will be given a Return Materials Authorization (RMA) number. You are responsible for properly packaging and shipping your product to Linksys at your cost and risk. You must include the RMA number

and a copy of your dated proof of original purchase when returning your product. Products received without a RMA number and dated proof of original purchase will be rejected. Do not include any other items with the product you are returning to Linksys. Defective product covered by this limited warranty will be repaired or replaced and returned to you without charge. Customers outside of the United States of America and Canada are responsible for all shipping and handling charges, custom duties, VAT and other associated taxes and charges. Repairs or replacements not covered under this limited warranty will be subject to charge at Linksys' then-current rates.

Technical Support

This limited warranty is neither a service nor a support contract. Information about Linksys' current technical support offerings and policies (including any fees for support services) can be found at www.linksys.com/support

General

This limited warranty is governed by the laws of the jurisdiction in which the Product was purchased by you.

If any portion of this limited warranty is found to be void or unenforceable, its remaining provisions shall remain in full force and effect.

Please direct all inquiries to: Linksys, P.O. Box 18558, Irvine, CA 92623.

For more information, please contact us

www.linksys.com

Select your country, and then select SUPPORT/TECHNICAL

For product returns:

Select your Country and then select CUSTOMER SUPPORT

Appendix C: Regulatory Information

FCC Statement

This product has been tested and complies with the specifications for a Class B digital device, pursuant to Part 15 of the FCC Rules. These limits are designed to provide reasonable protection against harmful interference in a residential installation. This equipment generates, uses, and can radiate radio frequency energy and, if not installed and used according to the instructions, may cause harmful interference to radio communications. However, there is no guarantee that interference will not occur in a particular installation. If this equipment does cause harmful interference to radio or television reception, which is found by turning the equipment off and on, the user is encouraged to try to correct the interference by one or more of the following measures:

- Reorient or relocate the receiving antenna
- Increase the separation between the equipment or devices
- Connect the equipment to an outlet other than the receiver's
- Consult a dealer or an experienced radio/TV technician for assistance

Safety Notices

- Caution: To reduce the risk of fire, use only No.26 AWG or larger telecommunication line cord.
- Do not use this product near water, for example, in a wet basement or near a swimming pool.
- Avoid using this product during an electrical storm. There may be a remote risk of electric shock from lightning.

Industry Canada Statement

This Class B digital apparatus complies with Canadian ICES-003.

Operation is subject to the following two conditions:

1. This device may not cause interference and
2. This device must accept any interference, including interference that may cause undesired operation of the device.

Avis d'Industrie Canada

Cet appareil numérique de la classe B est conforme à la norme NMB-003 du Canada.

Le fonctionnement est soumis aux conditions suivantes :

1. Ce périphérique ne doit pas causer d'interférences;
2. Ce périphérique doit accepter toutes les interférences reçues, y compris celles qui risquent d'entraîner un fonctionnement indésirable.

EC Declaration of Conformity (Europe)

In compliance with the EMC Directive 89/336/EEC, Low Voltage Directive 73/23/EEC, and Amendment Directive 93/68/EEC, this product meets the requirements of the following standards:

- EN55022 Emission
- EN55024 Immunity
- EN60950 Safety

User Information for Consumer Products Covered by EU Directive 2002/96/EC on Waste Electric and Electronic Equipment (WEEE)

This document contains important information for users with regards to the proper disposal and recycling of Linksys products. Consumers are required to comply with this notice for all electronic products bearing the following symbol:



English - Environmental Information for Customers in the European Union

European Directive 2002/96/EC requires that the equipment bearing this symbol  on the product and/or its packaging must not be disposed of with unsorted municipal waste. The symbol indicates that this product should be disposed of separately from regular household waste streams. It is your responsibility to dispose of this and other electric and electronic equipment via designated collection facilities appointed by the government or local authorities. Correct disposal and recycling will help prevent potential negative consequences to the environment and human health. For more detailed information about the disposal of your old equipment, please contact your local authorities, waste disposal service, or the shop where you purchased the product.

Български (Bulgarian) - Информация относно опазването на околната среда за потребители в Европейския съюз

Европейска директива 2002/96/EC изисква уредите, носещи този символ  върху изделието и/или опаковката му, да не се изхвърлят с несортирани битови отпадъци. Символът обозначава, че изделието трябва да се изхвърля отделно от сметосъбирането на обикновените битови отпадъци. Вашата отговорност е този и другите електрически и електронни уреди да се изхвърлят в предварително определени от държавните или общински органи специализирани пунктове за събиране. Правилното изхвърляне и рециклиране ще спомогнат да се предотвратят евентуални вредни за околната среда и здравето на населението последствия. За по-подробна информация относно изхвърлянето на вашите стари уреди се обърнете към местните власти, службите за сметосъбиране или магазина, от който сте закупили уреда.

Čeština (Czech) - Informace o ochraně životního prostředí pro zákazníky v zemích Evropské unie

Evropská směrnice 2002/96/ES zakazuje, aby zařízení označené tímto symbolem  na produktu anebo na obalu bylo likvidováno s netříděným komunálním odpadem. Tento symbol udává, že daný produkt musí být likvidován odděleně od běžného komunálního odpadu. Odpovídáte za likvidaci tohoto produktu a dalších elektrických a elektronických zařízení prostřednictvím určených sběrných míst stanovených vládou nebo místními úřady. Správná likvidace a recyklace pomáhá předcházet potenciálním negativním dopadům na životní prostředí a lidské zdraví. Podrobnější informace o likvidaci starého vybavení si laskavě vyžádejte od místních úřadů, podniku zabývajícího se likvidací komunálních odpadů nebo obchodu, kde jste produkt zakoupili.

Dansk (Danish) - Miljøinformation for kunder i EU

EU-direktiv 2002/96/EF kræver, at udstyr der bærer dette symbol  på produktet og/eller emballagen ikke må bortskaffes som usorteret kommunalt affald. Symbolet betyder, at dette produkt skal bortskaffes adskilt fra det almindelige husholdningsaffald. Det er dit ansvar at bortskaffe dette og andet elektrisk og elektronisk udstyr via bestemte indsamlingssteder udpeget af staten eller de lokale myndigheder. Korrekt bortskaffelse og genvinding vil hjælpe med til at undgå mulige skader for miljøet og menneskers sundhed. Kontakt venligst de lokale myndigheder, renovationstjenesten eller den butik, hvor du har købt produktet, angående mere detaljeret information om bortskaffelse af dit gamle udstyr.

Deutsch (German) - Umweltinformation für Kunden innerhalb der Europäischen Union

Die Europäische Richtlinie 2002/96/EC verlangt, dass technische Ausrüstung, die direkt am Gerät und/oder an der Verpackung mit diesem Symbol versehen ist , nicht zusammen mit unsortiertem Gemeindeabfall entsorgt werden darf. Das Symbol weist darauf hin, dass das Produkt von regulärem Haushaltsmüll getrennt entsorgt werden sollte. Es liegt in Ihrer Verantwortung, dieses Gerät und andere elektrische und elektronische Geräte über die dafür zuständigen und von der Regierung oder örtlichen Behörden dazu bestimmten Sammelstellen zu entsorgen. Ordnungsgemäßes Entsorgen und Recyceln trägt dazu bei, potentielle negative Folgen für Umwelt und die menschliche Gesundheit zu vermeiden. Wenn Sie weitere Informationen zur Entsorgung Ihrer Altgeräte benötigen, wenden Sie sich bitte an die örtlichen Behörden oder städtischen Entsorgungsdienste oder an den Händler, bei dem Sie das Produkt erworben haben.

Eesti (Estonian) - Keskkonnaalane informatsioon Euroopa Liidus asuvatele klientidele

Euroopa Liidu direktiivi 2002/96/EÜ nõuete kohaselt on seadmeid, millel on tootel või pakendil käesolev sümbol , keelatud kõrvaldada koos sorteerimata olmejäätmetega. See sümbol näitab, et toode tuleks kõrvaldada eraldi tavalistest olmejäätmevoogudest. Olete kohustatud kõrvaldama käesoleva ja ka muud elektri- ja elektroonikaseadmed riigi või kohalike ametiasutuste poolt ette nähtud kogumispunktide kaudu. Seadmete korrektn kõrvaldamine ja ringlussevõtt aitab vältida võimalikke negatiivseid tagajärgi keskkonnale ning inimeste tervisele. Vanade seadmete kõrvaldamise kohta täpsema informatsiooni saamiseks võtke palun ühendust kohalike ametiasutustega, jäätmekäitlusfirmaga või kauplusega, kust te toote ostsite.

Español (Spanish) - Información medioambiental para clientes de la Unión Europea

La Directiva 2002/96/CE de la UE exige que los equipos que lleven este símbolo  en el propio aparato y/o en su embalaje no deben eliminarse junto con otros residuos urbanos no seleccionados. El símbolo indica que el producto en cuestión debe separarse de los residuos domésticos convencionales con vistas a su eliminación. Es responsabilidad suya desechar este y cualesquiera otros aparatos eléctricos y electrónicos a través de los puntos de recogida que ponen a su disposición el gobierno y las autoridades locales. Al desechar y reciclar correctamente estos aparatos estará contribuyendo a evitar posibles consecuencias negativas para el medio ambiente y la salud de las personas. Si desea obtener información más detallada sobre la eliminación segura de su aparato usado, consulte a las autoridades locales, al servicio de recogida y eliminación de residuos de su zona o pregunte en la tienda donde adquirió el producto.

Ελληνικά (Greek) - Στοιχεία περιβαλλοντικής προστασίας για πελάτες εντός της Ευρωπαϊκής Ένωσης

Σύμφωνα με την Κοινοτική Οδηγία 2002/96/ΕΚ, ο εξοπλισμός που φέρει αυτό το σύμβολο  στο προϊόν ή/και τη συσκευασία του δεν πρέπει να απορρίπτεται μαζί με τα μη διαχωρισμένα αστικά απορρίμματα. Το σύμβολο υποδεικνύει ότι αυτό το προϊόν θα πρέπει να απορρίπτεται ξεχωριστά από τα συνήθη οικιακά απορρίμματα. Είστε υπεύθυνος για την απόρριψη του παρόντος και άλλου ηλεκτρικού και ηλεκτρονικού εξοπλισμού μέσω των καθορισμένων εγκαταστάσεων συγκέντρωσης απορριμμάτων, οι οποίες ορίζονται από το κράτος ή τις αρμόδιες τοπικές αρχές. Η σωστή απόρριψη και ανακύκλωση συμβάλλει στην πρόληψη ενδεχόμενων αρνητικών επιπτώσεων στο περιβάλλον και την υγεία. Για περισσότερες πληροφορίες σχετικά με την απόρριψη του παλαιού σας εξοπλισμού, επικοινωνήστε με τις τοπικές αρχές, τις υπηρεσίες αποκομιδής απορριμμάτων ή το κατάστημα από το οποίο αγοράσατε το προϊόν.

Français (French) - Informations environnementales pour les clients de l'Union européenne

La directive européenne 2002/96/CE exige que l'équipement sur lequel est apposé ce symbole  sur le produit et/ou son emballage ne soit pas jeté avec les autres ordures ménagères. Ce symbole indique que le produit doit être éliminé dans un circuit distinct de celui pour les déchets des ménages. Il est de votre responsabilité de jeter ce matériel ainsi que tout autre matériel électrique ou électronique par les moyens de collecte indiqués par le gouvernement et les pouvoirs publics des collectivités territoriales. L'élimination et le recyclage en bonne et due forme ont pour but de lutter contre l'impact néfaste potentiel de ce type de produits sur l'environnement et la santé publique. Pour plus d'informations sur le mode d'élimination de votre ancien équipement, veuillez prendre contact avec les pouvoirs publics locaux, le service de traitement des déchets, ou l'endroit où vous avez acheté le produit.

Italiano (Italian) - Informazioni relative all'ambiente per i clienti residenti nell'Unione Europea

La direttiva europea 2002/96/EC richiede che le apparecchiature contrassegnate con questo simbolo  sul prodotto e/o sull'imballaggio non siano smaltite insieme ai rifiuti urbani non differenziati. Il simbolo indica che questo prodotto non deve essere smaltito insieme ai normali rifiuti domestici. È responsabilità del proprietario smaltire sia questi prodotti sia le altre apparecchiature elettriche ed elettroniche mediante le specifiche strutture di raccolta indicate dal governo o dagli enti pubblici locali. Il corretto smaltimento ed il riciclaggio aiuteranno a prevenire conseguenze potenzialmente negative per l'ambiente e per la salute dell'essere umano. Per ricevere informazioni più dettagliate circa lo smaltimento delle vecchie apparecchiature in Vostro possesso, Vi invitiamo a contattare gli enti pubblici di competenza, il servizio di smaltimento rifiuti o il negozio nel quale avete acquistato il prodotto.

Latviešu valoda (Latvian) - Ekoloģiska informācija klientiem Eiropas Savienības jurisdikcijā

Direktīvā 2002/96/EK ir prasība, ka aprīkojumu, kam pievienota zīme  uz paša izstrādājuma vai uz tā iesaiņojuma, nedrīkst izmest nešķīrotā veidā kopā ar komunālajiem atkritumiem (tiem, ko rada vietēji iedzīvotāji un uzņēmumi). Šī zīme nozīmē to, ka šī ierīce ir jāizmet atkritumos tā, lai tā nenonāktu kopā ar parastiem mājsaimniecības atkritumiem. Jūsu pienākums ir šo un citas elektriskas un elektroniskas ierīces izmest atkritumos, izmantojot īpašus atkritumu savākšanas veidus un līdzekļus, ko nodrošina valsts un pašvaldību iestādes. Ja izmešana atkritumos un pārstrāde tiek veikta pareizi, tad mazinās iespējamais kaitējums dabai un cilvēku veselībai. Sīkākas ziņas par novecojuša aprīkojuma izmešanu atkritumos jūs varat saņemt vietējā pašvaldībā, atkritumu savākšanas dienestā, kā arī veikalā, kur iegādājāties šo izstrādājumu.

Lietuvškai (Lithuanian) - Aplinkosaugos informacija, skirta Europos Sąjungos vartotojams

Europos direktyva 2002/96/EC numato, kad įrangos, kuri ir  kurios pakuotė yra pažymėta šiuo simboliu (įveskite simbolį), negalima šalinti kartu su nerūšiuotomis komunalinėmis atliekomis. Šis simbolis rodo, kad gaminį reikia šalinti atskirai nuo bendro buitinių atliekų srauto. Jūs privalote užtikrinti, kad ši ir kita elektros ar elektroninė įranga būtų šalinama per tam tikras nacionalinės ar vietinės valdžios nustatytas atliekų rinkimo sistemas. Tinkamai šalinant ir perdirbant atliekas, bus išvengta galimos žalos aplinkai ir žmonių sveikatai. Daugiau informacijos apie jūsų senos įrangos šalinimą gali pateikti vietinės valdžios institucijos, atliekų šalinimo tarnybos arba parduotuvės, kuriose įsigijote tą gaminį.

Malti (Maltese) - Informazzjoni Ambjentali għal Kliġenti fl-Unjoni Ewropea

Id-Direttiva Ewropea 2002/96/KE titlob li t-tagħmir li jkun fih is-simbolu  fuq il-prodott u/jew fuq l-ippakkjar ma jistax jintrema ma' skart muniċipali li ma għex isseparat. Is-simbolu jindika li dan il-prodott għandu jintrema separatament minn ma' l-iskart domestiku regolari. Hija responsabbiltà tiegħek li tarmi dan it-tagħmir u kull tagħmir ieħor ta' l-elettriku u elettroniku permezz ta' faċilitajiet ta' għbir appuntati apposta mill-gvern jew mill-awtoritajiet lokali. Ir-rimi b'mod korrett u r-riċiklaġġ għin jipprevjeni konsegwenzi negattivi potenzjali għall-ambjent u għas-saħħa tal-bniedem. Għal aktar informazzjoni dettaljata dwar ir-rimi tat-tagħmir antik tiegħek, jekk jogħġbok ikkuntattja lill-awtoritajiet lokali tiegħek, is-servizzi għar-rimi ta' l-iskart, jew il-ħanut minn fejn xtrajt il-prodott.

Magyar (Hungarian) - Környezetvédelmi információ az európai uniós vásárlók számára

A 2002/96/EC számú európai uniós irányelv megkívánja, hogy azokat a termékeket, amelyeken, és/vagy amelyek csomagolásán az alábbi címke  megjelenik, tilos a többi szelektálatlan lakossági hulladékkal együtt kidobni. A címke azt jelöli, hogy az adott termék kidobásakor a szokványos háztartási hulladékészállítás rendszerektől elkülönített eljárást kell alkalmazni. Az Ön felelőssége, hogy ezt, és más elektromos és elektronikus berendezéseit a kormányzati vagy a helyi hatóságok által kijelölt gyűjtőredszereken keresztül számolja fel. A megfelelő hulladékfeldolgozás segít a környezetre és az emberi egészségre potenciálisan ártalmas negatív hatások megelőzésében. Ha elavult berendezéseinek felszámolásához további részletes információra van szüksége, kérjük, lépjen kapcsolatba a helyi hatóságokkal, a hulladékfeldolgozási szolgálattal, vagy azzal üzlettel, ahol a terméket vásárolta.

Nederlands (Dutch) - Milieu-informatie voor klanten in de Europese Unie

De Europese Richtlijn 2002/96/EC schrijft voor dat apparatuur die is voorzien van dit symbool  op het product of de verpakking, niet mag worden ingezameld met niet-gescheiden huishoudelijk afval. Dit symbool geeft aan dat het product apart moet worden ingezameld. U bent zelf verantwoordelijk voor de vernietiging van deze en andere elektrische en elektronische apparatuur via de daarvoor door de landelijke of plaatselijke overheid aangewezen inzamelingskanalen. De juiste vernietiging en recycling van deze apparatuur voorkomt mogelijke negatieve gevolgen voor het milieu en de gezondheid. Voor meer informatie over het vernietigen van uw oude apparatuur neemt u contact op met de plaatselijke autoriteiten of afvalverwerkingsdienst, of met de winkel waar u het product hebt aangeschaft.

Norsk (Norwegian) - Miljøinformasjon for kunder i EU

EU-direktiv 2002/96/EF krever at utstyr med følgende symbol  avbildet på produktet og/eller pakningen, ikke må kastes sammen med usortert avfall. Symbolet indikerer at dette produktet skal håndteres atskilt fra ordinær avfallsinnsamling for husholdningsavfall. Det er ditt ansvar å kvitte deg med dette produktet og annet elektrisk og elektronisk avfall via egne innsamlingsordninger slik myndighetene eller kommunene bestemmer. Korrekt avfallshåndtering og gjenvinning vil være med på å forhindre mulige negative konsekvenser for miljø og helse. For nærmere informasjon om håndtering av det kasserte utstyret ditt, kan du ta kontakt med kommunen, en innsamlingsstasjon for avfall eller butikken der du kjøpte produktet.

Polski (Polish) - Informacja dla klientów w Unii Europejskiej o przepisach dotyczących ochrony środowiska

Dyrektywa Europejska 2002/96/EC wymaga, aby sprzęt oznaczony symbolem  znajdującym się na produkcie i/lub jego opakowaniu nie był wyrzucany razem z innymi niesortowanymi odpadami komunalnymi. Symbol ten wskazuje, że produkt nie powinien być usuwany razem ze zwykłymi odpadami z gospodarstw domowych. Na Państwu spoczywa obowiązek wyrzucania tego i innych urządzeń elektrycznych oraz elektronicznych w punktach odbioru wyznaczonych przez władze krajowe lub lokalne. Pozbywanie się sprzętu we właściwy sposób i jego recykling pomogą zapobiec potencjalnie negatywnym konsekwencjom dla środowiska i zdrowia ludzkiego. W celu uzyskania szczegółowych informacji o usuwaniu starego sprzętu, prosimy zwrócić się do lokalnych władz, służb oczyszczania miasta lub sklepu, w którym produkt został nabyty.

Português (Portuguese) - Informação ambiental para clientes da União Europeia

A Directiva Europeia 2002/96/CE exige que o equipamento que exibe este símbolo  no produto e/ou na sua embalagem não seja eliminado junto com os resíduos municipais não separados. O símbolo indica que este produto deve ser eliminado separadamente dos resíduos domésticos regulares. É da sua responsabilidade eliminar este e qualquer outro equipamento eléctrico e electrónico através das instalações de recolha designadas pelas autoridades governamentais ou locais. A eliminação e reciclagem correctas ajudarão a prevenir as consequências negativas para o ambiente e para a saúde humana. Para obter informações mais detalhadas sobre a forma de eliminar o seu equipamento antigo, contacte as autoridades locais, os serviços de eliminação de resíduos ou o estabelecimento comercial onde adquiriu o produto.

Română (Romanian) - Informații de mediu pentru clienții din Uniunea Europeană

Directiva europeană 2002/96/CE impune ca echipamentele care prezintă acest simbol  pe produs și/sau pe ambalajul acestuia să nu fie casate împreună cu gunoiul menajer municipal. Simbolul indică faptul că acest produs trebuie să fie casat separat de gunoiul menajer obișnuit. Este responsabilitatea dvs. să cașiți acest produs și alte echipamente electrice și electronice prin intermediul unităților de colectare special desemnate de guvern sau de autoritățile locale. Casarea și reciclarea corecte vor ajuta la prevenirea potențialelor consecințe negative asupra sănătății mediului și a oamenilor. Pentru mai multe informații detaliate cu privire la casarea acestui echipament vechi, contactați autoritățile locale, serviciul de salubritate sau magazinul de la care ați achiziționat produsul.

Slovenčina (Slovak) - Informácie o ochrane životného prostredia pre zákazníkov v Európskej únii

Podľa európskej smernice 2002/96/ES zariadenie s týmto symbolom  na produkte a/alebo jeho balení nesmie byť likvidované spolu s netriedeným komunálnym odpadom. Symbol znamená, že produkt by sa mal likvidovať oddelene od bežného odpadu z domácností. Je vašou povinnosťou likvidovať toto i ostatné elektrické a elektronické zariadenia prostredníctvom špecializovaných zberných zariadení určených vládou alebo miestnymi orgánmi. Správna likvidácia a recyklácia pomôže zabrániť prípadným negatívnym dopadom na životné prostredie a zdravie ľudí. Ak máte záujem o podrobnejšie informácie o likvidácii starého zariadenia, obráťte sa, prosím, na miestne orgány, organizácie zaoberajúce sa likvidáciou odpadov alebo obchod, v ktorom ste si produkt zakúpili.

Slovenščina (Slovene) - Okoljske informacije za stranke v Evropski uniji

Evropska direktiva 2002/96/ES prepoveduje odlaganje opreme s tem simbolom  – na izdelku in/ali na embalaži z nesortiranimi komunalnimi odpadki. Ta simbol opozarja, da je treba izdelek zavreči ločeno od preostalih gospodinjskih odpadkov. Vaša odgovornost je, da to in preostalo električno in elektronsko opremo oddate na posebna zbirališča, ki jih določijo državne ustanove ali lokalne oblasti. S pravilnim odlaganjem in recikliranjem boste preprečili morebitne škodljive vplive na okolje in zdravje ljudi. Če želite izvedeti več o odlaganju stare opreme, se obrnite na lokalne oblasti, odlagališče odpadkov ali trgovino, kjer ste izdelek kupili.

Suomi (Finnish) - Ympäristöä koskevia tietoja EU-alueen asiakkaille

EU-direktiivi 2002/96/EY edellyttää, että jos laitteistossa on tämä symboli  itse tuotteessa ja/tai sen pakkauksessa, laitteistoa ei saa hävittää lajittelemattoman yhdyskuntajätteen mukana. Symboli merkitsee sitä, että tämä tuote on hävitettävä erillään tavallisesta kotitalousjätteestä. Sinun vastuullasi on hävittää tämä elektroniikkatuote ja muut vastaavat elektroniikkatuotteet viemällä tuote tai tuotteet viranomaisten määräämään keräyspisteeseen. Laitteiston oikea hävittäminen estää mahdolliset kielteiset vaikutukset ympäristöön ja ihmisten terveyteen. Lisätietoja vanhan laitteiston oikeasta hävitystavasta saa paikallisilta viranomaisilta, jätteenhävityspalvelusta tai siitä myymälästä, josta ostit tuotteen.

Svenska (Swedish) - Miljöinformation för kunder i Europeiska unionen

Det europeiska direktivet 2002/96/EC kräver att utrustning med denna symbol  på produkten och/eller förpackningen inte får kastas med osorterat kommunalt avfall. Symbolen visar att denna produkt bör kastas efter att den avskiljts från vanligt hushållsavfall. Det faller på ditt ansvar att kasta denna och annan elektrisk och elektronisk utrustning på fastställda samlingsplatser utsedda av regeringen eller lokala myndigheter. Korrekt kassering och återvinning skyddar mot eventuella negativa konsekvenser för miljön och personhälsa. För mer detaljerad information om kassering av din gamla utrustning kontaktar du dina lokala myndigheter, avfallshanteringen eller butiken där du köpte produkten.



WEB: For additional information, please visit www.linksys.com/international

Appendix D: Software License Agreement

Software in Linksys Products

This product from Cisco-Linksys LLC or from one of its affiliates Cisco Systems-Linksys (Asia) Pte Ltd. or Cisco-Linksys K.K. ("Linksys") contains software (including firmware) originating from Linksys and its suppliers and may also contain software from the open source community. Any software originating from Linksys and its suppliers is licensed under the Linksys Software License Agreement contained at Schedule 1 below. You may also be prompted to review and accept that Linksys Software License Agreement upon installation of the software

Any software from the open source community is licensed under the specific license terms applicable to that software made available by Linksys at www.linksys.com/gpl or as provided for in Schedules 2, 3 and 4 below.

Where such specific license terms entitle you to the source code of such software, that source code is upon request available at cost from Linksys for at least three years from the purchase date of this product and may also be available for download from www.linksys.com/gpl. For detailed license terms and additional information on open source software in Linksys products please look at the Linksys public web site at: www.linksys.com/gpl/ or Schedules 2, 3 or 4 below as applicable.

BY DOWNLOADING OR INSTALLING THE SOFTWARE, OR USING THE PRODUCT CONTAINING THE SOFTWARE, YOU ARE CONSENTING TO BE BOUND BY THE SOFTWARE LICENSE AGREEMENTS BELOW. IF YOU DO NOT AGREE TO ALL OF THESE TERMS, THEN YOU MAY NOT DOWNLOAD, INSTALL OR USE THE SOFTWARE. YOU MAY RETURN UNUSED SOFTWARE (OR, IF THE SOFTWARE IS SUPPLIED AS PART OF ANOTHER PRODUCT, THE UNUSED PRODUCT) FOR A FULL REFUND UP TO 30 DAYS AFTER ORIGINAL PURCHASE, SUBJECT TO THE RETURN PROCESS AND POLICIES OF THE PARTY FROM WHICH YOU PURCHASED SUCH PRODUCT OR SOFTWARE.

Software Licenses

The software Licenses applicable to software from Linksys are made available at the Linksys public web site at: www.linksys.com. For your convenience of reference, a copy of the Linksys Software License Agreement and the main open source code licenses used by Linksys in its products are contained in the Schedules below.

Schedule 1 - Linksys Software License Agreement

THIS LICENSE AGREEMENT IS BETWEEN YOU AND CISCO-LINKSYS LLC OR ONE OF ITS AFFILIATES CISCO SYSTEMS-LINKSYS (ASIA) PTE LTD. OR CISCO-LINKSYS K.K. ("LINKSYS") LICENSING THE SOFTWARE INSTEAD OF CISCO-LINKSYS LLC. BY DOWNLOADING OR INSTALLING THE SOFTWARE, OR USING THE PRODUCT CONTAINING THE SOFTWARE, YOU ARE CONSENTING TO BE BOUND BY THIS AGREEMENT. IF YOU DO NOT AGREE TO ALL OF THESE TERMS, THEN YOU MAY NOT DOWNLOAD, INSTALL OR USE THE SOFTWARE. YOU MAY RETURN UNUSED SOFTWARE (OR, IF THE SOFTWARE IS SUPPLIED AS PART OF ANOTHER PRODUCT, THE UNUSED PRODUCT) FOR A FULL REFUND UP TO 30 DAYS AFTER ORIGINAL PURCHASE, SUBJECT TO THE RETURN PROCESS AND POLICIES OF THE PARTY FROM WHICH YOU PURCHASED SUCH PRODUCT OR SOFTWARE.

License. Subject to the terms and conditions of this Agreement, Linksys grants the original end user purchaser of the Linksys product containing the Software ("You") a nonexclusive license to use the Software solely as embedded in or (where authorized in the applicable documentation) for communication with such product. This license may not be sublicensed, and is not transferable except to a person or entity to which you transfer ownership of the complete Linksys product containing the Software, provided you permanently transfer all rights under this Agreement and do not retain any full or partial copies of the Software, and the recipient agrees to the terms of this Agreement.

"Software" includes, and this Agreement will apply to (a) the software of Linksys or its suppliers provided in or with the applicable Linksys product, excluding technology from the open source community, and (b) any upgrades, updates, bug fixes or modified versions ("Upgrades") or backup copies of the Software supplied to You by Linksys or an authorized reseller, provided you already hold a valid license to the original software and have paid any applicable fee for the Upgrade.

Protection of Information. The Software and documentation contain trade secrets and/or copyrighted materials of Linksys or its suppliers. You will not copy or modify the Software or decompile, decrypt, reverse engineer or disassemble the Software (except to the extent expressly permitted by law notwithstanding this provision), and You will not disclose or make available such trade secrets or copyrighted material in any form to any third party. Title to and ownership of the Software and documentation and any portion thereof, will remain solely with Linksys or its suppliers.

Collection and Processing of Information. You agree that Linksys and/or its affiliates may, from time to time, collect and process information about your Linksys product and/or the Software and/or your use of either in order (i) to enable Linksys to offer you Upgrades; (ii) to ensure that

your Linksys product and/or the Software is being used in accordance with the terms of this Agreement; (iii) to provide improvements to the way Linksys delivers technology to you and to other Linksys customers; (iv) to enable Linksys to comply with the terms of any agreements it has with any third parties regarding your Linksys product and/or Software and/or (v) to enable Linksys to comply with all applicable laws and/or regulations, or the requirements of any regulatory authority or government agency. Linksys and/ or its affiliates may collect and process this information provided that it does not identify you personally. Your use of your Linksys product and/or the Software constitutes this consent by you to Linksys and/ or its affiliates' collection and use of such information and, for EEA customers, to the transfer of such information to a location outside the EEA.

Software Upgrades etc. If the Software enables you to receive Upgrades, you may elect at any time to receive these Upgrades either automatically or manually. If you elect to receive Upgrades manually or you otherwise elect not to receive or be notified of any Upgrades, you may expose your Linksys product and/or the Software to serious security threats and/or some features within your Linksys product and/or Software may become inaccessible. There may be circumstances where we apply an Upgrade automatically in order to comply with changes in legislation, legal or regulatory requirements or as a result of requirements to comply with the terms of any agreements Linksys has with any third parties regarding your Linksys product and/or the Software. You will always be notified of any Upgrades being delivered to you. The terms of this license will apply to any such Upgrade unless the Upgrade in question is accompanied by a separate license, in which event the terms of that license will apply.

Open Source Software. The GPL or other open source code incorporated into the Software and the open source license for such source code are available for free download at <http://www.linksys.com/gpl>. If You would like a copy of the GPL or other open source code in this Software on a CD, Linksys will mail to You a CD with such code for \$9.99 plus the cost of shipping, upon request.

Term and Termination. You may terminate this License at any time by destroying all copies of the Software and documentation. Your rights under this License will terminate immediately without notice from Linksys if You fail to comply with any provision of this Agreement.

Limited Warranty. The warranty terms and period specified in the applicable Linksys Product User Guide shall also apply to the Software.

Disclaimer of Liabilities. IN NO EVENT WILL LINKSYS OR ITS SUPPLIERS BE LIABLE FOR ANY LOST DATA, REVENUE OR PROFIT, OR FOR SPECIAL, INDIRECT, CONSEQUENTIAL, INCIDENTAL OR PUNITIVE DAMAGES, REGARDLESS OF CAUSE (INCLUDING NEGLIGENCE), ARISING OUT OF

OR RELATED TO THE USE OF OR INABILITY TO USE THE SOFTWARE, EVEN IF LINKSYS HAS BEEN ADVISED OF THE POSSIBILITY OF SUCH DAMAGES. IN NO EVENT WILL LINKSYS' LIABILITY EXCEED THE AMOUNT PAID BY YOU FOR THE PRODUCT. The foregoing limitations will apply even if any warranty or remedy under this Agreement fails of its essential purpose. Some jurisdictions do not allow the exclusion or limitation of incidental or consequential damages, so the above limitation or exclusion may not apply to You.

Export. Software, including technical data, may be subject to U.S. export control laws and regulations and/or export or import regulations in other countries. You agree to comply strictly with all such laws and regulations.

U.S. Government Users. The Software and documentation qualify as "commercial items" as defined at 48 C.F.R. 2.101 and 48 C.F.R. 12.212. All Government users acquire the Software and documentation with only those rights herein that apply to non-governmental customers.

General Terms. This Agreement will be governed by and construed in accordance with the laws of the State of California, without reference to conflict of laws principles. The United Nations Convention on Contracts for the International Sale of Goods will not apply. If any portion of this Agreement is found to be void or unenforceable, the remaining provisions will remain in full force and effect. This Agreement constitutes the entire agreement between the parties with respect to the Software and supersedes any conflicting or additional terms contained in any purchase order or elsewhere.

END OF SCHEDULE 1

Schedule 2

If this Linksys product contains open source software licensed under Version 2 of the "GNU General Public License" then the license terms below in this Schedule 2 will apply to that open source software. The license terms below in this Schedule 2 are from the public web site at <http://www.gnu.org/copyleft/gpl.html>

GNU GENERAL PUBLIC LICENSE

Version 2, June 1991

Copyright © 1989, 1991 Free Software Foundation, Inc.

51 Franklin Street, Fifth Floor, Boston, MA 02110-1301, USA

Everyone is permitted to copy and distribute verbatim copies of this license document, but changing it is not allowed.

Preamble

The licenses for most software are designed to take away your freedom to share and change it. By contrast, the

GNU General Public License is intended to guarantee your freedom to share and change free software—to make sure the software is free for all its users. This General Public License applies to most of the Free Software Foundation’s software and to any other program whose authors commit to using it. (Some other Free Software Foundation software is covered by the GNU Lesser General Public License instead.) You can apply it to your programs, too.

When we speak of free software, we are referring to freedom, not price. Our General Public Licenses are designed to make sure that you have the freedom to distribute copies of free software (and charge for this service if you wish), that you receive source code or can get it if you want it, that you can change the software or use pieces of it in new free programs; and that you know you can do these things.

To protect your rights, we need to make restrictions that forbid anyone to deny you these rights or to ask you to surrender the rights. These restrictions translate to certain responsibilities for you if you distribute copies of the software, or if you modify it.

For example, if you distribute copies of such a program, whether gratis or for a fee, you must give the recipients all the rights that you have. You must make sure that they, too, receive or can get the source code. And you must show them these terms so they know their rights.

We protect your rights with two steps: (1) copyright the software, and (2) offer you this license which gives you legal permission to copy, distribute and/or modify the software.

Also, for each author’s protection and ours, we want to make certain that everyone understands that there is no warranty for this free software. If the software is modified by someone else and passed on, we want its recipients to know that what they have is not the original, so that any problems introduced by others will not reflect on the original authors’ reputations.

Finally, any free program is threatened constantly by software patents. We wish to avoid the danger that redistributors of a free program will individually obtain patent licenses, in effect making the program proprietary. To prevent this, we have made it clear that any patent must be licensed for everyone’s free use or not licensed at all.

The precise terms and conditions for copying, distribution and modification follow.

TERMS AND CONDITIONS FOR COPYING, DISTRIBUTION AND MODIFICATION

0. This License applies to any program or other work which contains a notice placed by the copyright holder saying it may be distributed under the terms of this General Public License. The “Program”, below, refers to any such program or work, and a “work based on the Program” means either the Program or any derivative work under copyright law: that is to say, a work containing the Program or a portion of it, either verbatim or with modifications and/or translated into another language. (Hereinafter, translation is included without limitation in the term “modification”.) Each licensee is addressed as “you”.

Activities other than copying, distribution and modification are not covered by this License; they are outside its scope. The act of running the Program is not restricted, and the output from the Program is covered only if its contents constitute a work based on the Program (independent of having been made by running the Program). Whether that is true depends on what the Program does.

1. You may copy and distribute verbatim copies of the Program’s source code as you receive it, in any medium, provided that you conspicuously and appropriately publish on each copy an appropriate copyright notice and disclaimer of warranty; keep intact all the notices that refer to this License and to the absence of any warranty; and give any other recipients of the Program a copy of this License along with the Program.

You may charge a fee for the physical act of transferring a copy, and you may at your option offer warranty protection in exchange for a fee.

2. You may modify your copy or copies of the Program or any portion of it, thus forming a work based on the Program, and copy and distribute such modifications or work under the terms of Section 1 above, provided that you also meet all of these conditions:

- a. You must cause the modified files to carry prominent notices stating that you changed the files and the date of any change.
- b. You must cause any work that you distribute or publish, that in whole or in part contains or is derived from the Program or any part thereof, to be licensed as a whole at no charge to all third parties under the terms of this License.

- c. If the modified program normally reads commands interactively when run, you must cause it, when started running for such interactive use in the most ordinary way, to print or display an announcement including an appropriate copyright notice and a notice that there is no warranty (or else, saying that you provide a warranty) and that users may redistribute the program under these conditions, and telling the user how to view a copy of this License. (Exception: if the Program itself is interactive but does not normally print such an announcement, your work based on the Program is not required to print an announcement.)

These requirements apply to the modified work as a whole. If identifiable sections of that work are not derived from the Program, and can be reasonably considered independent and separate works in themselves, then this License, and its terms, do not apply to those sections when you distribute them as separate works. But when you distribute the same sections as part of a whole which is a work based on the Program, the distribution of the whole must be on the terms of this License, whose permissions for other licensees extend to the entire whole, and thus to each and every part regardless of who wrote it.

Thus, it is not the intent of this section to claim rights or contest your rights to work written entirely by you; rather, the intent is to exercise the right to control the distribution of derivative or collective works based on the Program.

In addition, mere aggregation of another work not based on the Program with the Program (or with a work based on the Program) on a volume of a storage or distribution medium does not bring the other work under the scope of this License.

3. You may copy and distribute the Program (or a work based on it, under Section 2) in object code or executable form under the terms of Sections 1 and 2 above provided that you also do one of the following:
 - a. Accompany it with the complete corresponding machine-readable source code, which must be distributed under the terms of Sections 1 and 2 above on a medium customarily used for software interchange; or,
 - b. Accompany it with a written offer, valid for at least three years, to give any third party, for a charge no more than your cost of physically performing source distribution, a complete machine-readable copy of the corresponding source code, to be distributed under the terms of Sections 1 and 2 above on a medium customarily used for software interchange; or,

- c. Accompany it with the information you received as to the offer to distribute corresponding source code. (This alternative is allowed only for noncommercial distribution and only if you received the program in object code or executable form with such an offer, in accord with Subsection b above.)

The source code for a work means the preferred form of the work for making modifications to it. For an executable work, complete source code means all the source code for all modules it contains, plus any associated interface definition files, plus the scripts used to control compilation and installation of the executable. However, as a special exception, the source code distributed need not include anything that is normally distributed (in either source or binary form) with the major components (compiler, kernel, and so on) of the operating system on which the executable runs, unless that component itself accompanies the executable.

If distribution of executable or object code is made by offering access to copy from a designated place, then offering equivalent access to copy the source code from the same place counts as distribution of the source code, even though third parties are not compelled to copy the source along with the object code.

4. You may not copy, modify, sublicense, or distribute the Program except as expressly provided under this License. Any attempt otherwise to copy, modify, sublicense or distribute the Program is void, and will automatically terminate your rights under this License. However, parties who have received copies, or rights, from you under this License will not have their licenses terminated so long as such parties remain in full compliance.
5. You are not required to accept this License, since you have not signed it. However, nothing else grants you permission to modify or distribute the Program or its derivative works. These actions are prohibited by law if you do not accept this License. Therefore, by modifying or distributing the Program (or any work based on the Program), you indicate your acceptance of this License to do so, and all its terms and conditions for copying, distributing or modifying the Program or works based on it.
6. Each time you redistribute the Program (or any work based on the Program), the recipient automatically receives a license from the original licensor to copy, distribute or modify the Program subject to these terms and conditions. You may not impose any further restrictions on the recipients' exercise of the rights granted herein. You are not responsible for enforcing compliance by third parties to this License.

7. If, as a consequence of a court judgment or allegation of patent infringement or for any other reason (not limited to patent issues), conditions are imposed on you (whether by court order, agreement or otherwise) that contradict the conditions of this License, they do not excuse you from the conditions of this License. If you cannot distribute so as to satisfy simultaneously your obligations under this License and any other pertinent obligations, then as a consequence you may not distribute the Program at all. For example, if a patent license would not permit royalty-free redistribution of the Program by all those who receive copies directly or indirectly through you, then the only way you could satisfy both it and this License would be to refrain entirely from distribution of the Program.

If any portion of this section is held invalid or unenforceable under any particular circumstance, the balance of the section is intended to apply and the section as a whole is intended to apply in other circumstances.

It is not the purpose of this section to induce you to infringe any patents or other property right claims or to contest validity of any such claims; this section has the sole purpose of protecting the integrity of the free software distribution system, which is implemented by public license practices. Many people have made generous contributions to the wide range of software distributed through that system in reliance on consistent application of that system; it is up to the author/donor to decide if he or she is willing to distribute software through any other system and a licensee cannot impose that choice.

This section is intended to make thoroughly clear what is believed to be a consequence of the rest of this License.

8. If the distribution and/or use of the Program is restricted in certain countries either by patents or by copyrighted interfaces, the original copyright holder who places the Program under this License may add an explicit geographical distribution limitation excluding those countries, so that distribution is permitted only in or among countries not thus excluded. In such case, this License incorporates the limitation as if written in the body of this License.
9. The Free Software Foundation may publish revised and/or new versions of the General Public License from time to time. Such new versions will be similar in spirit to the present version, but may differ in detail to address new problems or concerns.

Each version is given a distinguishing version number. If the Program specifies a version number of this License which applies to it and "any later version", you have the option of following the terms and conditions either of that version or of any later version published by the Free Software Foundation. If the Program does

not specify a version number of this License, you may choose any version ever published by the Free Software Foundation.

10. If you wish to incorporate parts of the Program into other free programs whose distribution conditions are different, write to the author to ask for permission. For software which is copyrighted by the Free Software Foundation, write to the Free Software Foundation; we sometimes make exceptions for this. Our decision will be guided by the two goals of preserving the free status of all derivatives of our free software and of promoting the sharing and reuse of software generally.

NO WARRANTY

11. BECAUSE THE PROGRAM IS LICENSED FREE OF CHARGE, THERE IS NO WARRANTY FOR THE PROGRAM, TO THE EXTENT PERMITTED BY APPLICABLE LAW. EXCEPT WHEN OTHERWISE STATED IN WRITING THE COPYRIGHT HOLDERS AND/OR OTHER PARTIES PROVIDE THE PROGRAM "AS IS" WITHOUT WARRANTY OF ANY KIND, EITHER EXPRESSED OR IMPLIED, INCLUDING, BUT NOT LIMITED TO, THE IMPLIED WARRANTIES OF MERCHANTABILITY AND FITNESS FOR A PARTICULAR PURPOSE. THE ENTIRE RISK AS TO THE QUALITY AND PERFORMANCE OF THE PROGRAM IS WITH YOU. SHOULD THE PROGRAM PROVE DEFECTIVE, YOU ASSUME THE COST OF ALL NECESSARY SERVICING, REPAIR OR CORRECTION.
12. IN NO EVENT UNLESS REQUIRED BY APPLICABLE LAW OR AGREED TO IN WRITING WILL ANY COPYRIGHT HOLDER, OR ANY OTHER PARTY WHO MAY MODIFY AND/OR REDISTRIBUTE THE PROGRAM AS PERMITTED ABOVE, BE LIABLE TO YOU FOR DAMAGES, INCLUDING ANY GENERAL, SPECIAL, INCIDENTAL OR CONSEQUENTIAL DAMAGES ARISING OUT OF THE USE OR INABILITY TO USE THE PROGRAM (INCLUDING BUT NOT LIMITED TO LOSS OF DATA OR DATA BEING RENDERED INACCURATE OR LOSSES SUSTAINED BY YOU OR THIRD PARTIES OR A FAILURE OF THE PROGRAM TO OPERATE WITH ANY OTHER PROGRAMS), EVEN IF SUCH HOLDER OR OTHER PARTY HAS BEEN ADVISED OF THE POSSIBILITY OF SUCH DAMAGES.

END OF TERMS AND CONDITIONS

END OF SCHEDULE 2

Schedule 3

If this Linksys product contains open source software licensed under Version 2.1 of the "GNU Lesser General Public License" then the license terms below in this Schedule 3 will apply to that open source software. The license terms below in this Schedule 3 are from the public web site at <http://www.gnu.org/licenses/old-licenses/lgpl-2.1.html>.

GNU LESSER GENERAL PUBLIC LICENSE

Version 2.1, February 1999

Copyright (C) 1991, 1999 Free Software Foundation, Inc.

51 Franklin Street, Fifth Floor, Boston, MA 02110-1301, USA

Everyone is permitted to copy and distribute verbatim copies of this license document, but changing it is not allowed.

[This is the first released version of the Lesser GPL. It also counts as the successor of the GNU Library Public License, version 2, hence the version number 2.1.]

Preamble

The licenses for most software are designed to take away your freedom to share and change it. By contrast, the GNU General Public Licenses are intended to guarantee your freedom to share and change free software—to make sure the software is free for all its users.

This license, the Lesser General Public License, applies to some specially designated software packages—typically libraries—of the Free Software Foundation and other authors who decide to use it. You can use it too, but we suggest you first think carefully about whether this license or the ordinary General Public License is the better strategy to use in any particular case, based on the explanations below.

When we speak of free software, we are referring to freedom of use, not price. Our General Public Licenses are designed to make sure that you have the freedom to distribute copies of free software (and charge for this service if you wish); that you receive source code or can get it if you want it; that you can change the software and use pieces of it in new free programs; and that you are informed that you can do these things.

To protect your rights, we need to make restrictions that forbid distributors to deny you these rights or to ask you to surrender these rights. These restrictions translate to certain responsibilities for you if you distribute copies of the library or if you modify it.

For example, if you distribute copies of the library, whether gratis or for a fee, you must give the recipients all the rights that we gave you. You must make sure that they, too, receive or can get the source code. If you link other code with the library, you must provide complete object files to the recipients, so that they can relink them with the library after making changes to the library and recompiling it. And you must show them these terms so they know their rights.

We protect your rights with a two-step method: (1) we copyright the library, and (2) we offer you this license, which gives you legal permission to copy, distribute and/or modify the library.

To protect each distributor, we want to make it very clear that there is no warranty for the free library. Also, if the library is modified by someone else and passed on, the recipients should know that what they have is not the original version, so that the original author's reputation will not be affected by problems that might be introduced by others.

Finally, software patents pose a constant threat to the existence of any free program. We wish to make sure that a company cannot effectively restrict the users of a free program by obtaining a restrictive license from a patent holder. Therefore, we insist that any patent license obtained for a version of the library must be consistent with the full freedom of use specified in this license.

Most GNU software, including some libraries, is covered by the ordinary GNU General Public License. This license, the GNU Lesser General Public License, applies to certain designated libraries, and is quite different from the ordinary General Public License. We use this license for certain libraries in order to permit linking those libraries into non-free programs.

When a program is linked with a library, whether statically or using a shared library, the combination of the two is legally speaking a combined work, a derivative of the original library. The ordinary General Public License therefore permits such linking only if the entire combination fits its criteria of freedom. The Lesser General Public License permits more lax criteria for linking other code with the library.

We call this license the “Lesser” General Public License because it does Less to protect the user's freedom than the ordinary General Public License. It also provides other free software developers Less of an advantage over competing non-free programs. These disadvantages are the reason we use the ordinary General Public License for many libraries. However, the Lesser license provides advantages in certain special circumstances.

For example, on rare occasions, there may be a special need to encourage the widest possible use of a certain library, so that it becomes a de-facto standard. To achieve this, non-free programs must be allowed to use the library. A more frequent case is that a free library does the same job as widely used non-free libraries. In this case, there is little to gain by limiting the free library to free software only, so we use the Lesser General Public License.

In other cases, permission to use a particular library in non-free programs enables a greater number of people to use a large body of free software. For example, permission to use the GNU C Library in non-free programs enables many more people to use the whole GNU operating system, as well as its variant, the GNU/Linux operating system.

Although the Lesser General Public License is Less protective of the users' freedom, it does ensure that the user of a program that is linked with the Library has the

freedom and the wherewithal to run that program using a modified version of the Library.

The precise terms and conditions for copying, distribution and modification follow. Pay close attention to the difference between a “work based on the library” and a “work that uses the library”. The former contains code derived from the library, whereas the latter must be combined with the library in order to run.

GNU LESSER GENERAL PUBLIC LICENSE

TERMS AND CONDITIONS FOR COPYING, DISTRIBUTION AND MODIFICATION

0. This License Agreement applies to any software library or other program which contains a notice placed by the copyright holder or other authorized party saying it may be distributed under the terms of this Lesser General Public License (also called “this License”). Each licensee is addressed as “you”.

A “library” means a collection of software functions and/or data prepared so as to be conveniently linked with application programs (which use some of those functions and data) to form executables.

The “Library”, below, refers to any such software library or work which has been distributed under these terms. A “work based on the Library” means either the Library or any derivative work under copyright law: that is to say, a work containing the Library or a portion of it, either verbatim or with modifications and/or translated straightforwardly into another language. (Hereinafter, translation is included without limitation in the term “modification”.)

“Source code” for a work means the preferred form of the work for making modifications to it. For a library, complete source code means all the source code for all modules it contains, plus any associated interface definition files, plus the scripts used to control compilation and installation of the library.

Activities other than copying, distribution and modification are not covered by this License; they are outside its scope. The act of running a program using the Library is not restricted, and output from such a program is covered only if its contents constitute a work based on the Library (independent of the use of the Library in a tool for writing it). Whether that is true depends on what the Library does and what the program that uses the Library does.

1. You may copy and distribute verbatim copies of the Library’s complete source code as you receive it, in any medium, provided that you conspicuously and appropriately publish on each copy an appropriate copyright notice and disclaimer of warranty; keep intact all the notices that refer to this License and to the absence of any warranty; and distribute a copy of this License along with the Library.

You may charge a fee for the physical act of transferring a copy, and you may at your option offer warranty protection in exchange for a fee.

2. You may modify your copy or copies of the Library or any portion of it, thus forming a work based on the Library, and copy and distribute such modifications or work under the terms of Section 1 above, provided that you also meet all of these conditions:

- a) The modified work must itself be a software library.
- b) You must cause the files modified to carry prominent notices stating that you changed the files and the date of any change.
- c) You must cause the whole of the work to be licensed at no charge to all third parties under the terms of this License.
- d) If a facility in the modified Library refers to a function or a table of data to be supplied by an application program that uses the facility, other than as an argument passed when the facility is invoked, then you must make a good faith effort to ensure that, in the event an application does not supply such function or table, the facility still operates, and performs whatever part of its purpose remains meaningful.

(For example, a function in a library to compute square roots has a purpose that is entirely well-defined independent of the application. Therefore, Subsection 2d requires that any application-supplied function or table used by this function must be optional: if the application does not supply it, the square root function must still compute square roots.)

These requirements apply to the modified work as a whole. If identifiable sections of that work are not derived from the Library, and can be reasonably considered independent and separate works in themselves, then this License, and its terms, do not apply to those sections when you distribute them as separate works. But when you distribute the same sections as part of a whole which is a work based on the Library, the distribution of the whole must be on the terms of this License, whose permissions for other licensees extend to the entire whole, and thus to each and every part regardless of who wrote it.

Thus, it is not the intent of this section to claim rights or contest your rights to work written entirely by you; rather, the intent is to exercise the right to control the distribution of derivative or collective works based on the Library.

In addition, mere aggregation of another work not based on the Library with the Library (or with a work based on the Library) on a volume of a storage or distribution medium does not bring the other work under the scope of this License.

3. You may opt to apply the terms of the ordinary GNU General Public License instead of this License to a given copy of the Library. To do this, you must alter all the notices that refer to this License, so that they refer to the ordinary GNU General Public License, version 2, instead of to this License. (If a newer version than version 2 of the ordinary GNU General Public License has appeared, then you can specify that version instead if you wish.) Do not make any other change in these notices.

Once this change is made in a given copy, it is irreversible for that copy, so the ordinary GNU General Public License applies to all subsequent copies and derivative works made from that copy.

This option is useful when you wish to copy part of the code of the Library into a program that is not a library.

4. You may copy and distribute the Library (or a portion or derivative of it, under Section 2) in object code or executable form under the terms of Sections 1 and 2 above provided that you accompany it with the complete corresponding machine-readable source code, which must be distributed under the terms of Sections 1 and 2 above on a medium customarily used for software interchange.

If distribution of object code is made by offering access to copy from a designated place, then offering equivalent access to copy the source code from the same place satisfies the requirement to distribute the source code, even though third parties are not compelled to copy the source along with the object code.

5. A program that contains no derivative of any portion of the Library, but is designed to work with the Library by being compiled or linked with it, is called a “work that uses the Library”. Such a work, in isolation, is not a derivative work of the Library, and therefore falls outside the scope of this License.

However, linking a “work that uses the Library” with the Library creates an executable that is a derivative of the Library (because it contains portions of the Library), rather than a “work that uses the library”. The executable is therefore covered by this License. Section 6 states terms for distribution of such executables.

When a “work that uses the Library” uses material from a header file that is part of the Library, the object code for the work may be a derivative work of the Library even though the source code is not. Whether this is true is especially significant if the work can be linked without the Library, or if the work is itself a library. The threshold for this to be true is not precisely defined by law.

If such an object file uses only numerical parameters, data structure layouts and accessors, and small macros and small inline functions (ten lines or less in length), then the use of the object file is unrestricted, regardless of whether it is legally a derivative work. (Executables containing this object code plus portions of the Library will still fall under Section 6.)

Otherwise, if the work is a derivative of the Library, you may distribute the object code for the work under the terms of Section 6. Any executables containing that work also fall under Section 6, whether or not they are linked directly with the Library itself.

6. As an exception to the Sections above, you may also combine or link a “work that uses the Library” with the Library to produce a work containing portions of the Library, and distribute that work under terms of your choice, provided that the terms permit modification of the work for the customer’s own use and reverse engineering for debugging such modifications.

You must give prominent notice with each copy of the work that the Library is used in it and that the Library and its use are covered by this License. You must supply a copy of this License. If the work during execution displays copyright notices, you must include the copyright notice for the Library among them, as well as a reference directing the user to the copy of this License. Also, you must do one of these things:

- a) Accompany the work with the complete corresponding machine-readable source code for the Library including whatever changes were used in the work (which must be distributed under Sections 1 and 2 above); and, if the work is an executable linked with the Library, with the complete machine-readable “work that uses the Library”; as object code and/or source code, so that the user can modify the Library and then relink to produce a modified executable containing the modified Library. (It is understood that the user who changes the contents of definitions files in the Library will not necessarily be able to recompile the application to use the modified definitions.)

- b) Use a suitable shared library mechanism for linking with the Library. A suitable mechanism is one that (1) uses at run time a copy of the library already present on the user's computer system, rather than copying library functions into the executable, and (2) will operate properly with a modified version of the library, if the user installs one, as long as the modified version is interface-compatible with the version that the work was made with.
- c) Accompany the work with a written offer, valid for at least three years, to give the same user the materials specified in Subsection 6a, above, for a charge no more than the cost of performing this distribution.
- d) If distribution of the work is made by offering access to copy from a designated place, offer equivalent access to copy the above specified materials from the same place.
- e) Verify that the user has already received a copy of these materials or that you have already sent this user a copy.

For an executable, the required form of the "work that uses the Library" must include any data and utility programs needed for reproducing the executable from it. However, as a special exception, the materials to be distributed need not include anything that is normally distributed (in either source or binary form) with the major components (compiler, kernel, and so on) of the operating system on which the executable runs, unless that component itself accompanies the executable.

It may happen that this requirement contradicts the license restrictions of other proprietary libraries that do not normally accompany the operating system. Such a contradiction means you cannot use both them and the Library together in an executable that you distribute.

- 7. You may place library facilities that are a work based on the Library side-by-side in a single library together with other library facilities not covered by this License, and distribute such a combined library, provided that the separate distribution of the work based on the Library and of the other library facilities is otherwise permitted, and provided that you do these two things:
 - a) Accompany the combined library with a copy of the same work based on the Library, uncombined with any other library facilities. This must be distributed under the terms of the Sections above.
 - b) Give prominent notice with the combined library of the fact that part of it is a work based on the Library, and explaining where to find the accompanying uncombined form of the same work.

- 8. You may not copy, modify, sublicense, link with, or distribute the Library except as expressly provided under this License. Any attempt otherwise to copy, modify, sublicense, link with, or distribute the Library is void, and will automatically terminate your rights under this License. However, parties who have received copies, or rights, from you under this License will not have their licenses terminated so long as such parties remain in full compliance.
- 9. You are not required to accept this License, since you have not signed it. However, nothing else grants you permission to modify or distribute the Library or its derivative works. These actions are prohibited by law if you do not accept this License. Therefore, by modifying or distributing the Library (or any work based on the Library), you indicate your acceptance of this License to do so, and all its terms and conditions for copying, distributing or modifying the Library or works based on it.
- 10. Each time you redistribute the Library (or any work based on the Library), the recipient automatically receives a license from the original licensor to copy, distribute, link with or modify the Library subject to these terms and conditions. You may not impose any further restrictions on the recipients' exercise of the rights granted herein. You are not responsible for enforcing compliance by third parties with this License.
- 11. If, as a consequence of a court judgment or allegation of patent infringement or for any other reason (not limited to patent issues), conditions are imposed on you (whether by court order, agreement or otherwise) that contradict the conditions of this License, they do not excuse you from the conditions of this License. If you cannot distribute so as to satisfy simultaneously your obligations under this License and any other pertinent obligations, then as a consequence you may not distribute the Library at all. For example, if a patent license would not permit royalty-free redistribution of the Library by all those who receive copies directly or indirectly through you, then the only way you could satisfy both it and this License would be to refrain entirely from distribution of the Library.

If any portion of this section is held invalid or unenforceable under any particular circumstance, the balance of the section is intended to apply, and the section as a whole is intended to apply in other circumstances.

It is not the purpose of this section to induce you to infringe any patents or other property right claims or to contest validity of any such claims; this section has the sole purpose of protecting the integrity of the free software distribution system which is implemented by public license practices. Many people have made generous contributions to the wide range of

software distributed through that system in reliance on consistent application of that system; it is up to the author/donor to decide if he or she is willing to distribute software through any other system and a licensee cannot impose that choice.

This section is intended to make thoroughly clear what is believed to be a consequence of the rest of this License.

12. If the distribution and/or use of the Library is restricted in certain countries either by patents or by copyrighted interfaces, the original copyright holder who places the Library under this License may add an explicit geographical distribution limitation excluding those countries, so that distribution is permitted only in or among countries not thus excluded. In such case, this License incorporates the limitation as if written in the body of this License.
13. The Free Software Foundation may publish revised and/or new versions of the Lesser General Public License from time to time. Such new versions will be similar in spirit to the present version, but may differ in detail to address new problems or concerns.

Each version is given a distinguishing version number. If the Library specifies a version number of this License which applies to it and "any later version", you have the option of following the terms and conditions either of that version or of any later version published by the Free Software Foundation. If the Library does not specify a license version number, you may choose any version ever published by the Free Software Foundation.
14. If you wish to incorporate parts of the Library into other free programs whose distribution conditions are incompatible with these, write to the author to ask for permission. For software which is copyrighted by the Free Software Foundation, write to the Free Software Foundation; we sometimes make exceptions for this. Our decision will be guided by the two goals of preserving the free status of all derivatives of our free software and of promoting the sharing and reuse of software generally.

NO WARRANTY

15. BECAUSE THE LIBRARY IS LICENSED FREE OF CHARGE, THERE IS NO WARRANTY FOR THE LIBRARY, TO THE EXTENT PERMITTED BY APPLICABLE LAW. EXCEPT WHEN OTHERWISE STATED IN WRITING THE COPYRIGHT HOLDERS AND/OR OTHER PARTIES PROVIDE THE LIBRARY "AS IS" WITHOUT WARRANTY OF ANY KIND, EITHER EXPRESSED OR IMPLIED, INCLUDING, BUT NOT LIMITED TO, THE IMPLIED WARRANTIES OF MERCHANTABILITY AND FITNESS FOR A PARTICULAR PURPOSE. THE ENTIRE RISK AS TO THE QUALITY AND PERFORMANCE OF THE LIBRARY IS WITH YOU. SHOULD THE LIBRARY PROVE DEFECTIVE, YOU ASSUME THE COST OF ALL NECESSARY SERVICING, REPAIR OR CORRECTION.
16. IN NO EVENT UNLESS REQUIRED BY APPLICABLE LAW OR AGREED TO IN WRITING WILL ANY COPYRIGHT HOLDER, OR ANY OTHER PARTY WHO MAY MODIFY AND/OR REDISTRIBUTE THE LIBRARY AS PERMITTED ABOVE, BE LIABLE TO YOU FOR DAMAGES, INCLUDING ANY GENERAL, SPECIAL, INCIDENTAL OR CONSEQUENTIAL DAMAGES ARISING OUT OF THE USE OR INABILITY TO USE THE LIBRARY (INCLUDING BUT NOT LIMITED TO LOSS OF DATA OR DATA BEING RENDERED INACCURATE OR LOSSES SUSTAINED BY YOU OR THIRD PARTIES OR A FAILURE OF THE LIBRARY TO OPERATE WITH ANY OTHER SOFTWARE), EVEN IF SUCH HOLDER OR OTHER PARTY HAS BEEN ADVISED OF THE POSSIBILITY OF SUCH DAMAGES.

END OF TERMS AND CONDITIONS

END OF SCHEDULE 3

Schedule 4

If this Linksys product contains open source software licensed under the OpenSSL license:

This product includes software developed by the OpenSSL Project for use in the OpenSSL Toolkit. (<http://www.openssl.org/>).

This product includes cryptographic software written by Eric Young (eay@cryptsoft.com).

This product includes software written by Tim Hudson (tjh@cryptsoft.com).

In addition, if this Linksys product contains open source software licensed under the OpenSSL license then the license terms below in this Schedule 3 will apply to that open source software. The license terms below in this Schedule 3 are from the public web site at <http://www.openssl.org/source/license.html>.

The OpenSSL toolkit stays under a dual license, i.e. both the conditions of the OpenSSL License and the original SSLeay license apply to the toolkit. See below for the actual license texts. Actually both licenses are BSD-style Open Source licenses. In case of any license issues related to OpenSSL please contact openssl-core@openssl.org.

OpenSSL License

Copyright © 1998-2007 The OpenSSL Project. All rights reserved.

Redistribution and use in source and binary forms, with or without modification, are permitted provided that the following conditions are met:

1. Redistributions of source code must retain the above copyright notice, this list of conditions and the following disclaimer.
2. Redistributions in binary form must reproduce the above copyright notice, this list of conditions and the following disclaimer in the documentation and/or other materials provided with the distribution.
3. All advertising materials mentioning features or use of this software must display the following acknowledgment: "This product includes software developed by the OpenSSL Project for use in the OpenSSL Toolkit. (<http://www.openssl.org/>)"
4. The names "OpenSSL Toolkit" and "OpenSSL Project" must not be used to endorse or promote products derived from this software without prior written permission. For written permission, please contact openssl-core@openssl.org.
5. Products derived from this software may not be called "OpenSSL" nor may "OpenSSL" appear in their names without prior written permission of the OpenSSL Project.
6. Redistributions of any form whatsoever must retain the following acknowledgment: "This product includes software developed by the OpenSSL Project for use in the OpenSSL Toolkit (<http://www.openssl.org/>)"

THIS SOFTWARE IS PROVIDED BY THE OpenSSL PROJECT "AS IS" AND ANY EXPRESSED OR IMPLIED WARRANTIES, INCLUDING, BUT NOT LIMITED TO, THE IMPLIED WARRANTIES OF MERCHANTABILITY AND FITNESS FOR A PARTICULAR PURPOSE ARE DISCLAIMED. IN NO EVENT SHALL THE OpenSSL PROJECT OR ITS CONTRIBUTORS BE LIABLE FOR ANY DIRECT, INDIRECT, INCIDENTAL, SPECIAL, EXEMPLARY, OR CONSEQUENTIAL DAMAGES (INCLUDING, BUT NOT LIMITED TO, PROCUREMENT OF SUBSTITUTE GOODS OR SERVICES; LOSS OF USE, DATA, OR PROFITS; OR BUSINESS INTERRUPTION) HOWEVER CAUSED AND ON ANY THEORY OF LIABILITY, WHETHER IN CONTRACT, STRICT LIABILITY, OR TORT (INCLUDING NEGLIGENCE OR OTHERWISE) ARISING IN ANY WAY OUT OF THE USE OF THIS SOFTWARE, EVEN IF ADVISED OF THE POSSIBILITY OF SUCH DAMAGE.

This product includes cryptographic software written by Eric Young (ey@cryptsoft.com). This product includes software written by Tim Hudson (tjh@cryptsoft.com).

Original SSLeay License

Copyright © 1995-1998 Eric Young (ey@cryptsoft.com) All rights reserved.

This package is an SSL implementation written by Eric Young (ey@cryptsoft.com).

The implementation was written so as to conform with Netscape's SSL.

This library is free for commercial and non-commercial use as long as the following conditions are adhered to. The following conditions apply to all code found in this distribution, be it the RC4, RSA, lhash, DES, etc., code; not just the SSL code. The SSL documentation included with this distribution is covered by the same copyright terms except that the holder is Tim Hudson (tjh@cryptsoft.com).

Copyright remains Eric Young's, and as such any Copyright notices in the code are not to be removed.

If this package is used in a product, Eric Young should be given attribution as the author of the parts of the library used. This can be in the form of a textual message at program startup or in documentation (online or textual) provided with the package.

Redistribution and use in source and binary forms, with or without modification, are permitted provided that the following conditions are met:

1. Redistributions of source code must retain the copyright notice, this list of conditions and the following disclaimer.
2. Redistributions in binary form must reproduce the above copyright notice, this list of conditions and the following disclaimer in the documentation and/or other materials provided with the distribution.
3. All advertising materials mentioning features or use of this software must display the following acknowledgement: "This product includes cryptographic software written by Eric Young (ey@cryptsoft.com)"
The word 'cryptographic' can be left out if the routines from the library being used are not cryptographic related.
4. If you include any Windows specific code (or a derivative thereof) from the apps directory (application code) you must include an acknowledgement: "This product includes software written by Tim Hudson (tjh@cryptsoft.com)"

THIS SOFTWARE IS PROVIDED BY ERIC YOUNG "AS IS" AND ANY EXPRESS OR IMPLIED WARRANTIES, INCLUDING, BUT NOT LIMITED TO, THE IMPLIED WARRANTIES OF MERCHANTABILITY AND FITNESS FOR A PARTICULAR PURPOSE ARE DISCLAIMED. IN NO EVENT SHALL THE AUTHOR OR CONTRIBUTORS BE LIABLE FOR ANY

DIRECT, INDIRECT, INCIDENTAL, SPECIAL, EXEMPLARY, OR CONSEQUENTIAL DAMAGES (INCLUDING, BUT NOT LIMITED TO, PROCUREMENT OF SUBSTITUTE GOODS OR SERVICES; LOSS OF USE, DATA, OR PROFITS; OR BUSINESS INTERRUPTION) HOWEVER CAUSED AND ON ANY THEORY OF LIABILITY, WHETHER IN CONTRACT, STRICT LIABILITY, OR TORT (INCLUDING NEGLIGENCE OR OTHERWISE) ARISING IN ANY WAY OUT OF THE USE OF THIS SOFTWARE, EVEN IF ADVISED OF THE POSSIBILITY OF SUCH DAMAGE.

The license and distribution terms for any publicly available version or derivative of this code cannot be changed. i.e. this code cannot simply be copied and put under another distribution license [including the GNU Public License.]

END OF SCHEDULE 4