

# HomePlug to Ethernet Bridge

---

*User Manual (GHPB21)*





## Welcome

Thank you for purchasing one of the most user-friendly networking devices on the market. IOGEAR's HomePlug to Ethernet Bridges are first-class networking devices designed to network your computers at home (or in your small office). This device allows you to set up your home network via the most pervasive medium in your house – the home power lines. It is easy to set up, and it doesn't require any additional wiring in the house.

To better serve you, IOGEAR offers an array of additional USB 2.0, USB 1.1, FireWire, KVM, and other peripheral products. For more information or to purchase additional IOGEAR products, visit us at [www.IOGEAR.com](http://www.IOGEAR.com)

We hope you enjoy using your IOGEAR HomePlug to Ethernet Bridge, another first-rate connectivity solution from IOGEAR.

©2003 IOGEAR. All Rights Reserved. PKG-M0066

IOGEAR, the IOGEAR logo, MiniView, VSE are trademarks or registered trademarks of IOGEAR, Inc. Microsoft and Windows are registered trademarks of Microsoft Corporation. IBM is a registered trademark of International Business Machines, Inc. Macintosh, G3/G4 and iMac are registered trademarks of Apple Computer, Inc. IOGEAR makes no warranty of any kind with regards to the information presented in this document. All information furnished here is for informational purposes only and is subject to change without notice. IOGEAR, Inc. assumes no responsibility for any inaccuracies or errors that may appear in this document.

## Table of Contents

Overview . . . . .	02	Technical Support. . . . .	67
Features . . . . .	03	Product Specifications . . . . .	69
Requirements . . . . .	04	Limited Warranty, . . . . .	70
Introduction . . . . .	05		
Installation . . . . .	07		
Network Configuration . . . . .	14		
Networking Basics . . . . .	27		
- Network Setup Wizard. . . . .	27		
- Checking IP Address . . . . .	38		
- Assign a Static IP address . . . . .	40		
- Sharing Disks/Folders . . . . .	43		
- Sharing Printers . . . . .	48		
- Accessing the Internet, . . . . .	59		
Troubleshooting . . . . .	63		

IOGEAR's HomePlug Powerline Network Ethernet Bridge allows you to network your home computers through the electric power lines in the house. Setting up a home network has never been so simple, just connect your computer to the HomePlug Bridge via the CAT5 patch cable provided in the package, and then plug the power end to your AC power outlet, you are connected!

This unit is compliant to HomePlug Powerline Specification 1.0 and offers up to 14 Mbps bandwidth while being less prone to interference. By offering 56-bit DES encryption, it is also much more secure than other home networking technologies such as wireless Ethernet.

## Features

- No extra wires, using the most pervasive medium in your home - power lines
- Allows multiple computers to share Internet access, printers, and other resources through the power lines
- Very easy and intuitive to set up and install
- HomePlug Powerline Specification 1.0 compliant
- Up to 14 Mbps bandwidth
- Up to 990' distance through the power lines, far enough for most households
- Worldwide compatibility
- Low risk of interference by other RF sources
- 56-bit DES encryption assures data security
- Signal will not pass power meter, thus keeping the data safe in the house
- Encryption done by hardware, with no sacrifice on bandwidth
- Most reliable home networking technology

### **System Requirements**

- Available AC power outlets in the room.
- Standard home power line wiring.
- Computers with 10/100Base-T adapters, or 10/100Base-T switch/hub.
- When used as a node: Windows 98SE, ME, 2000, XP.
- When used as a bridge: any operating system (OS transparent).

## Introduction

IOGEAR's HomePlug to Ethernet Bridge allows you to network your computers via your existing home power lines. It offers a data transmission speed of up to 14 Mbps, and reaches up to 990 feet through standard power lines.

### Package contents:

1. HomePlug to Ethernet Bridge
2. CAT5 patch cable
3. Power cable
4. User Manual
5. Warranty Registration Card

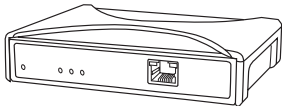

1.

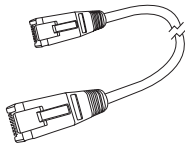

2.

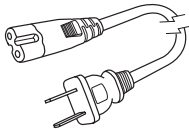

3.



### Front View: (Drawing)

1. Power LED - lights up in green when plugged into a power outlet
2. Collision LED - lights up in green whenever there is collision
3. Link LED - lights up in green after plugged into a power outlet
4. ACT LED - blinks in green when there is network activity
5. LINK/ACT LED - blinks when data is sent through Homeplug Connection
6. Ethernet port - connecting to the computer

### Back View:

1. Power port - connecting to the wall outlet

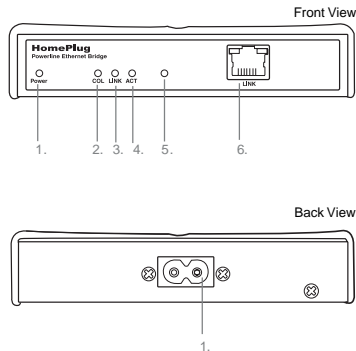

## Installation

There are several ways to network your computers using the HomePlug Bridge. Before we get started, please NOTE:

Do not place HomePlug devices under direct sunlight or near high heat emitting devices;

Do not place HomePlug devices near water or wet surfaces to avoid electric hazards;

Do not place HomePlug devices on any moving or unstable surfaces;

It is recommended that you plug the HomePlug devices directly into the wall outlets, not to any power adapters, surge protectors or any device that filters signals.

**If you plan to use this unit as a BRIDGE, not as a NODE; there is a limitation of having sixteen BRIDGES PER NETWORK, (refer to the Network Terms for details):**

1. Remove the HomePlug Bridge, the power cord, the CAT5 cable and the installation CD from the package.
2. Allocate a space for the adapter's placement. Make sure you avoid the places mentioned above.
3. Plug one end of the CAT5 cable into the Ethernet port on the computer, and the other end into the Ethernet port of the bridge.
4. Plug the power cord into the HomePlug bridge and wall outlet.
5. At this point, the Power and Link LED should be on, and you should see the ACT (Activity) LED start blinking.
6. Turn on your computer and set up your networks (refer to Network Basics for more information).

**If you plan to use this unit as a NODE, not as a BRIDGE (refer to the Network Terms for details):**

1. Remove the HomePlug Bridge, the power cord, the CAT5 cable and the installation CD from the package.
2. Allocate a space for the adapter's placement. Make sure you avoid the places mentioned on the previous page.
3. Make sure that your HomePlug bridge is **NOT CONNECTED TO THE COMPUTER** before you install the driver.
4. Insert the installation CD. If CD does not automatically load, run (CD Drive Letter):\setup.exe.
5. Click Next.



**(Note: When used as node, the bridge uses the same driver as the homeplug USB adapter.)**

## Installation

6. Read, understand and accept the License Agreement and Continue by clicking Next.

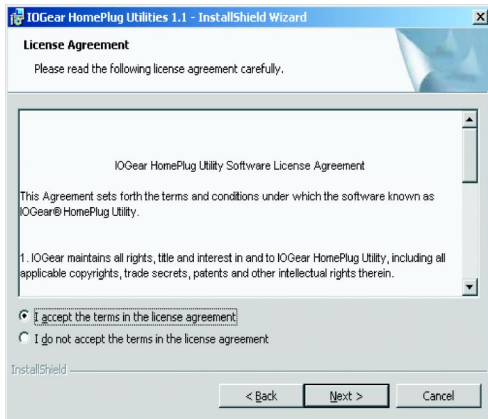

7. Enter a username and organization name, and continue installation. (Username and Organization have no importance in device operation. This window might look slightly different on other platforms.)

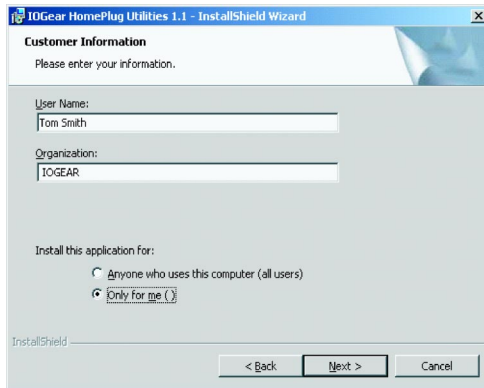

## Installation

- Click Install to start the Installation Wizard:

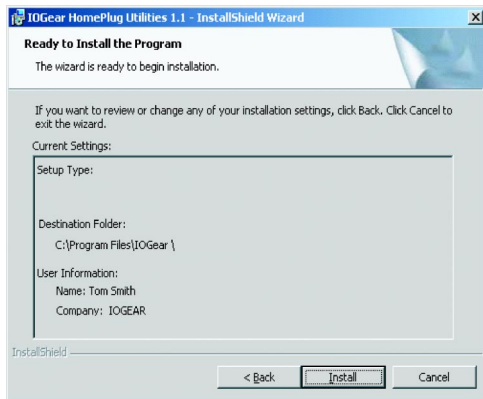

9. After the installation is successful, a window will pop up prompting for the installation of the HomePlug Bridge. Plug in the CAT5 cable, one end into the Ethernet port on the HomePlug Bridge, the other end into an available network port on your computer. Please verify that the green Power LED and Link LED on the HomePlug Bridge light up.

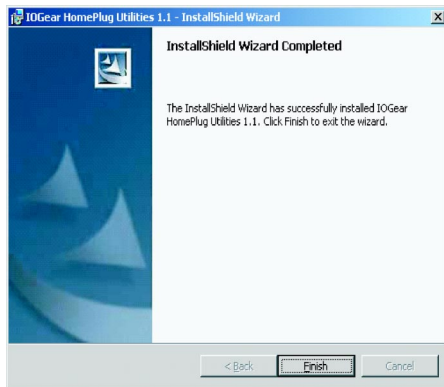

## Installation



10. You have reached the end of your installation. Please restart your computer for changes to go into effect.

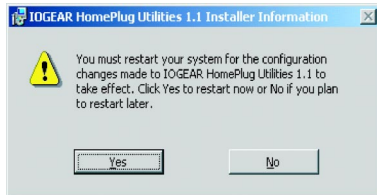



## Network Configuration

After restarting the computer, you can see the HomePlug utility icon.

1. Double click the icon to start the HomePlug Configuration utility. The utility is used to configure the HomePlug.

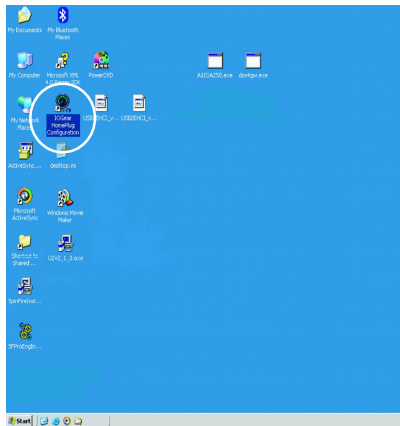

## Network Configuration

2. Once the utility starts, it will display the MAC address of the device your computer is connected to as well as the signal strength.

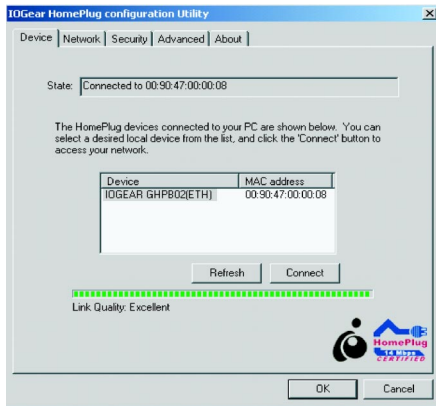

## Network Configuration

- The Network tab displays the additional HomePlug devices on the network. Click on the “Scan” button to scan for additional devices on the HomePlug network.

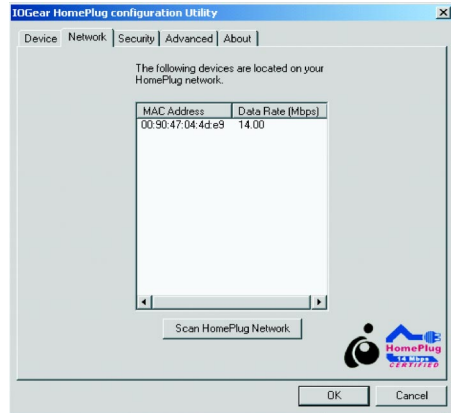

## Network Configuration

- The Security tab displays the Network Password. The default Network Password is HomePlug.

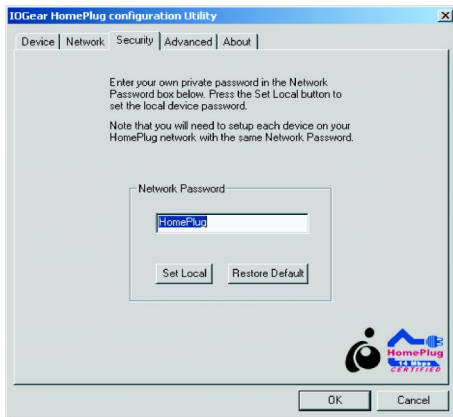

## Network Configuration

5. The Advanced tab is where you can set the Network Password on all of the HomePlug devices at once. This way, you don't have to connect to each device and set the password one by one.

**Network Password** – Displays the Network Password.

**Device Password** – This is where you enter the password located on the bottom of you HomePlug device. Once you enter the password and click “Add.” This will add that device to the “Remote Passwords” field.

**Remote Passwords** – This field displays the password for devices you added. Once you've finished adding all the HomePlug devices on your network, press the “Set All” button. This will change the Network Password on all the devices listed.

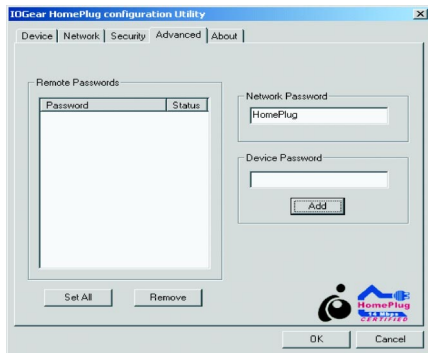

## Network Configuration

- This screen displays the version number of the utility. Click OK to complete the configuration.

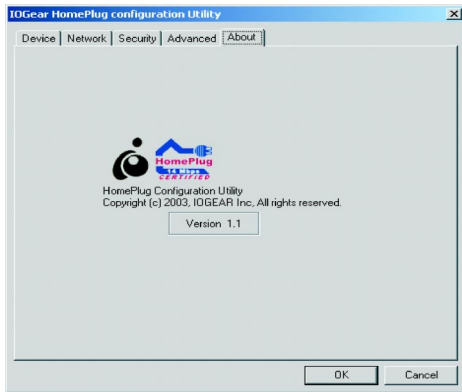

## Network Configuration

7. Go to network connection, you can see that the CAT5 connection is enabled and that the ACT LED in the unit blinks.

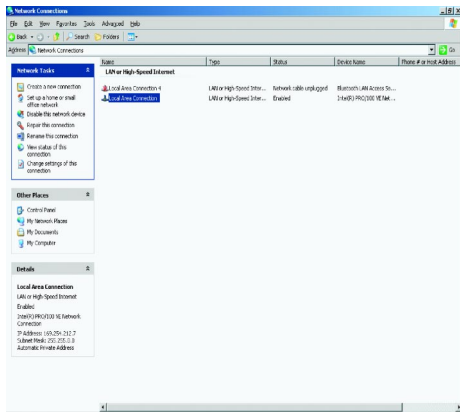

## Network Configuration

### Network Terms

What is a node?

A node is any given device that resides or is connected onto an existing network. A computer with a network card connected to a switch is a node. The same thing applies to a Mac connected to a hub.

What is a bridge?

A bridge is used when connecting one side of the network with another network. Previously, connecting every computer together with the other network would mean having cables all over the place. Instead a bridge was brought in to have 1 connection between the networks instead of 20. The bridge in the HomePlug terms functions like a concentration device that connects many computers onto the HomePlug network using 1 HomePlug device.

How do I know if I require a node or a Bridge?

If you want to connect only one computer to the Power line network, you need a node. If you plan to connect a group of computers currently not HomePlug ready to the Power line network, you need a bridge. The HomePlug USB adapter can only be used as a node. The HomePlug Ethernet Bridge can be used as either a node or bridge. It is designed as a bridge in default; the only way to turn it off is to install the utility software that comes with the unit. That will turn the bridge into a node. If used as bridge, there is a limitation of having sixteen bridges on the same Power line network.



You will have to use bridges to connect two Macintoshes, because the utility software is only compatible with Windows-based computers.

Can I use both in the same network?

Yes. It is possible to have both nodes and bridges on a network as long as there is only a maximum of 16 bridges. It is also fine to have USB nodes on the same network with Ethernet nodes.

How do I decide whether I need a USB adapter or Ethernet bridge as a node?

It should be determined by the available connection on the computer that you plan to connect to the HomePlug network. If the computer comes with a 10/100 Base-T network card, use the bridge; if the computer comes with USB port, use the USB adapter. If the computer comes with both, you can decide which one to use based upon your unique situation.

For Macintosh and other non-Windows based computers, the Ethernet Bridge is the only choice.

### **HomePlug Network Topologies**

There are various ways to connect your computers via HomePlug. If all HomePlug units are used as nodes, the topology is usually BUS. If bridges are used to connect two networks together, there maybe both BUS and STAR. The following are several examples.

## Network Configuration

### a. Using the HomePlug to USB Adapter ONLY

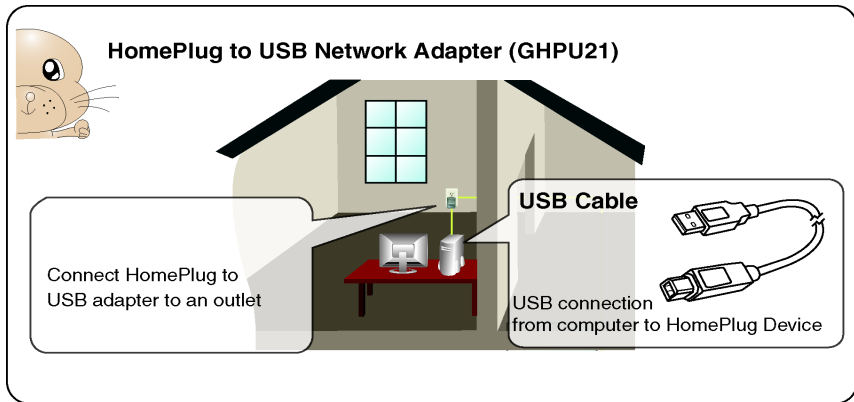

- b. Using the HomePlug Ethernet Bridge (Node Mode)  
(Several HomePlug Bridges can be used)

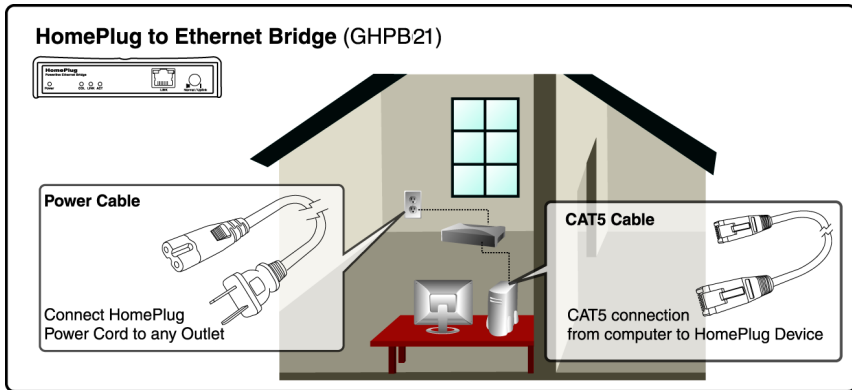

## Network Configuration

c. Using the HomePlug USB Adapter AND Ethernet Bridge (Node Mode)

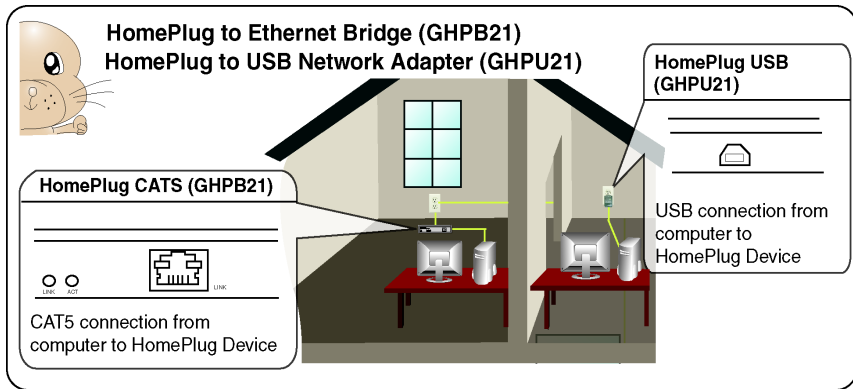

- d. Using the HomePlug Ethernet bridge to make a sub network HomePlug ready to communicate with the other HomePlug nodes. (Maximum 16 Homeplug Bridges can be used.)

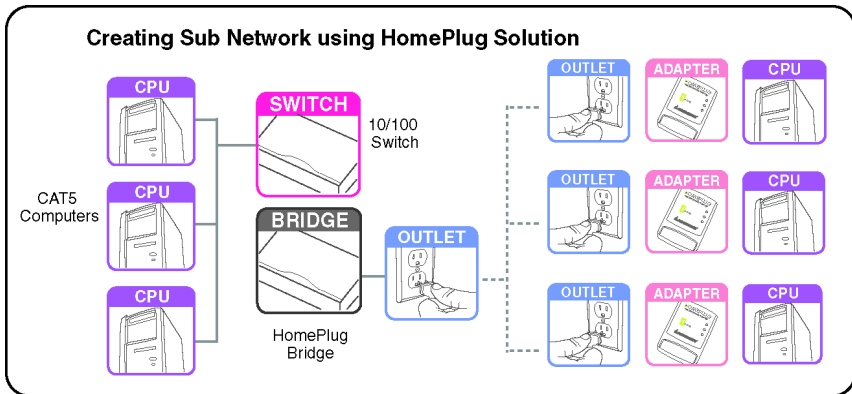

## Networking Basics

Prior to installing HomePlug, you may have had some ideas about using your new network. This section will help you get started on those ideas or even give you some new ones. It will go through the process of sharing files, printing from any computer on the network, or accessing the Internet on multiple computers with one connection. Please note that this section is just an outline of a few networking basics and not intended to be a comprehensive guide to networking.

### **Topic 1: Using Network Setup Wizard in Windows XP/2000**

In the following section, you will learn how to set up a network at a home or business, using Microsoft Windows XP/2000.

Go to My Computer>Control Panel>Network Connections.  
Select "Set up a home or small office network".

Click "Next" in the window(right) for the Network Setup Wizard.

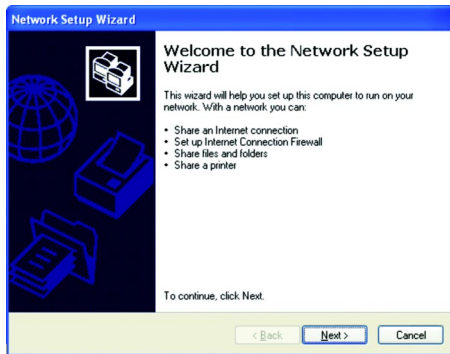

## Networking Basics

Read and follow the instructions in the following window and then click "Next".

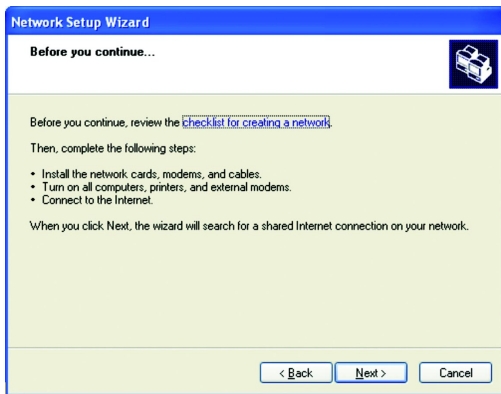



In the following window, select among the 3 options which best describe this computer and then click "Next". If your computer connects to a broadband router/gateway, select the second option.

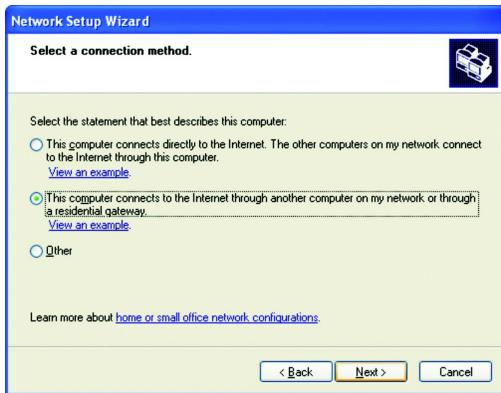

The screenshot shows a window titled "Network Setup Wizard" with a blue header bar. Below the header, the text "Select a connection method." is displayed next to a printer icon. The main area contains the instruction "Select the statement that best describes this computer:" followed by three radio button options. The second option is selected and highlighted with a dashed border. At the bottom, there are three buttons: "< Back", "Next >" (which is highlighted with a yellow border), and "Cancel".

**Network Setup Wizard**

Select a connection method.

Select the statement that best describes this computer:

- This computer connects directly to the Internet. The other computers on my network connect to the Internet through this computer.  
[View an example.](#)
- This computer connects to the Internet through another computer on my network or through a residential gateway.  
[View an example.](#)
- Other

Learn more about [home or small office network configurations.](#)

< Back   Next >   Cancel

## Networking Basics

Fill in the information in the following window as you desire and then click "Next".

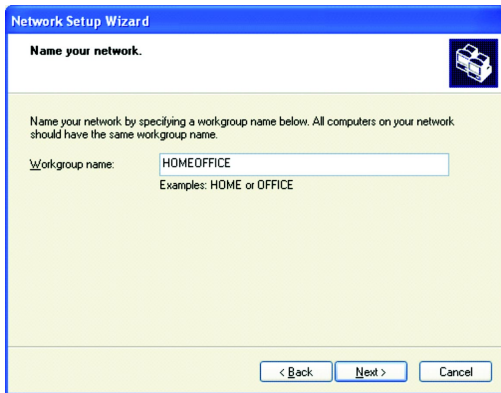

The screenshot shows a Windows dialog box titled "Network Setup Wizard". The main heading is "Name your network." with a printer icon in the top right corner. Below the heading, there is a text instruction: "Name your network by specifying a workgroup name below. All computers on your network should have the same workgroup name." A text input field labeled "Workgroup name:" contains the text "HOMEOFFICE". Below the input field, it says "Examples: HOME or OFFICE". At the bottom of the dialog, there are three buttons: "< Back", "Next >", and "Cancel".

**Network Setup Wizard**

**Name your network.**

Name your network by specifying a workgroup name below. All computers on your network should have the same workgroup name.

Workgroup name:

Examples: HOME or OFFICE

< Back    Next >    Cancel

Enter the Workgroup name as you wish and then click "Next". (Very important: All computers on your network should have the same Workgroup).

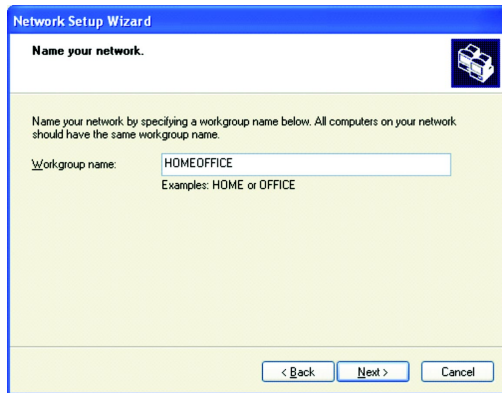

The screenshot shows a Windows dialog box titled "Network Setup Wizard". The main heading is "Name your network." with a printer icon in the top right corner. Below the heading, there is a text instruction: "Name your network by specifying a workgroup name below. All computers on your network should have the same workgroup name." A label "Workgroup name:" is followed by a text input field containing "HOMEOFFICE". Below the input field, it says "Examples: HOME or OFFICE". At the bottom of the dialog, there are three buttons: "< Back", "Next >", and "Cancel".

## Networking Basics

Review the setting in the following screen, and click "Next" to continue. If you want to change any settings, you need to click "Back" and start over again.

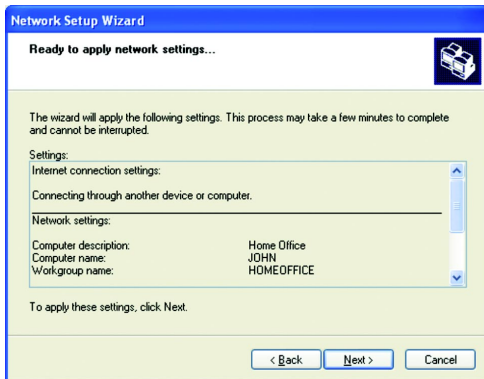

Please wait while the Network Setup Wizard applies the changes and configures the computer.



## Networking Basics

When the configuration is done, the following screen will come up. Select one of the 4 options according to your needs. (In this example, the last choice was selected.) Click “Next.”

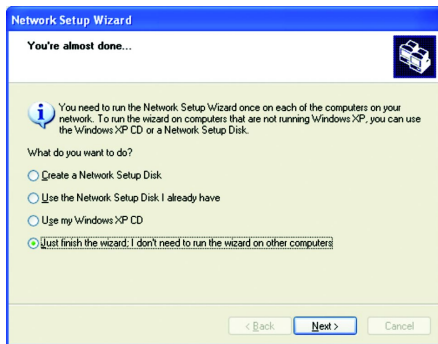

Then click "Finish" on this next window.

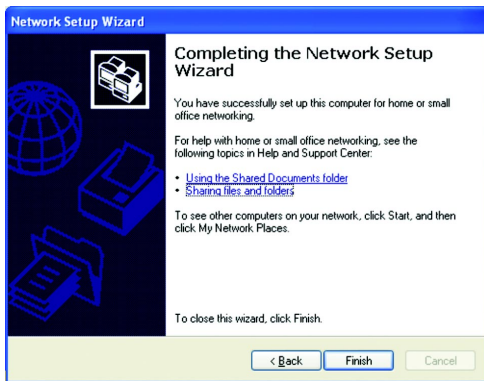

## Networking Basics

The new setting will take effect after you restart the computer. Click "Yes" to restart the computer.

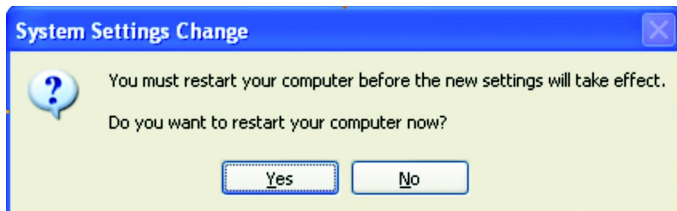

Congratulations, you have completed configuring this computer! After setting up networks on all your computers on the network, you will be able to use your HomePlug network to share files, printers, and Internet connections.



### Topic 2: Checking IP addresses in Windows XP/ 2000

Go to  
Start>Programs>Accessories>  
Command Prompt.

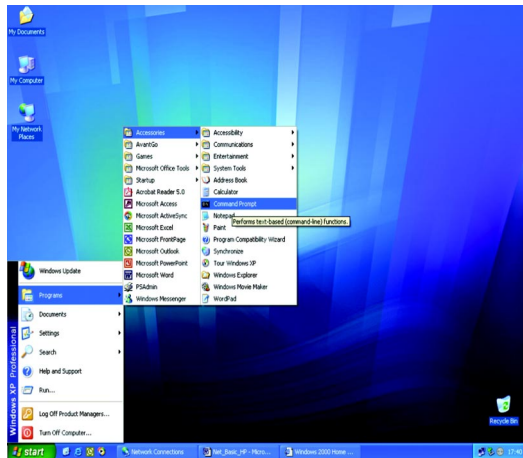

## Networking Basics

Type "ipconfig" at the prompt, then press Enter.  
You will see the IP address of this computer.

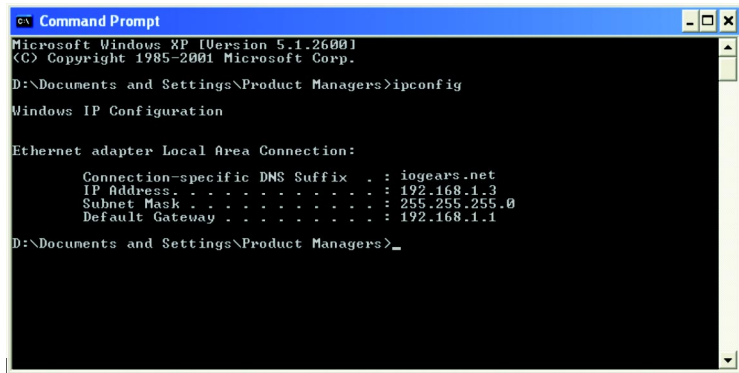

```
Command Prompt
Microsoft Windows XP [Version 5.1.2600]
(C) Copyright 1985-2001 Microsoft Corp.

D:\Documents and Settings\Product Managers>ipconfig

Windows IP Configuration

Ethernet adapter Local Area Connection:

    Connection-specific DNS Suffix  . : iogears.net
    IP Address. . . . . : 192.168.1.3
    Subnet Mask . . . . . : 255.255.255.0
    Default Gateway . . . . . : 192.168.1.1

D:\Documents and Settings\Product Managers>_
```

### Topic 3: Assigning a Static IP Address

(Note: If you use DHCP-capable gateway/router, you don't need to assign any static IP addresses because the gateway/router will automatically assign IP addresses to the computers on the network.)

Go to Start>Settings>Control Panel>Network Connections>Local Area Connection

Right click on Local Area Connection, then double click on Properties, you will see a window similar to this:

Select "Internet Protocol (TCP/IP)" and then click on Properties.

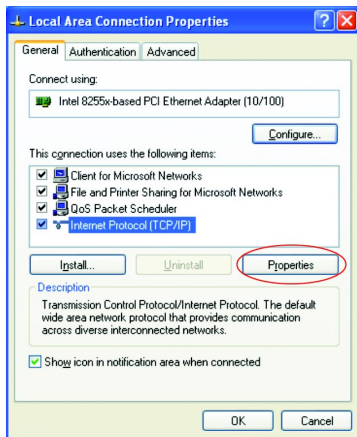

## Networking Basics

At the following window, select "Use the following IP address:", and fill in the desired IP address and subnet mask (it is recommended to use the default subnet mask as shown in the following window. Subnet mask must be the same for all the computers on the network.)

If you need to enter DNS address, you must enter the address of the default gateway.

Click on "OK".

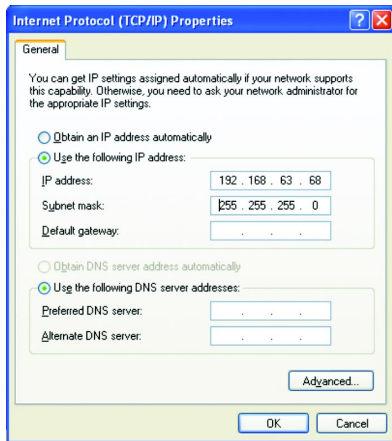

## Networking Basics

Click "Close" on the Local Area Connection Properties window.

You have completed static IP address assignment.

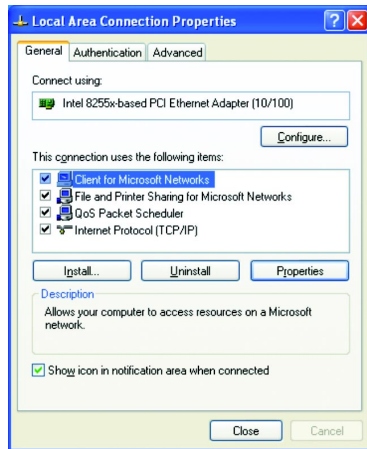

## Networking Basics

### Topic 4. Sharing Disks/Folders

Once the network has been checked / configured, you can access other systems via "My Network Places". To allow other systems to access data on your disks / in your folders, you have to give permission to share your disks and/or folders.

1. Select the disk (or the folder) to be shared (for example in "My Computer") and right-click on the icon of the disk to get the Context / popup-menu; select "Sharing and Security."

It is recommended to share only folders instead of the disk drive to avoid any security related issues.

## Networking Basics

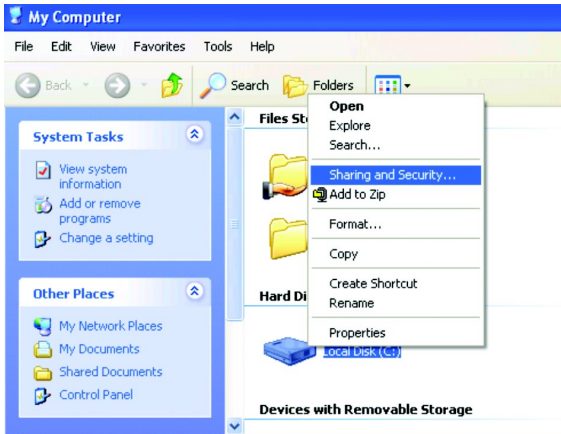

*Once you have selected the folder to be shared, right-click to select “sharing and security.”*

## Networking Basics

2. In the following window, click to select "Share this folder". Then click on "Permission".

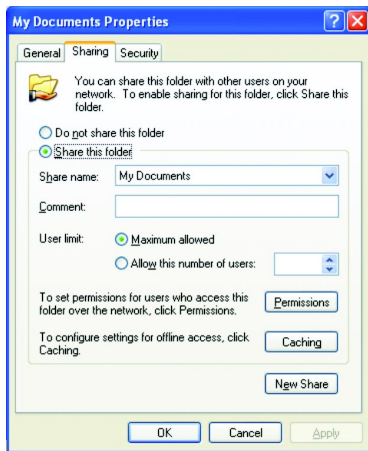



- Please note that by default, all users defined on your XP Professional system will have full permissions. You can reduce the permissions (for example to allow only Read-access) and/or you could add a different group of users to have access permission (but then you should delete the group "Everyone" from this list).

In the following Permission settings, make sure you are giving the right permissions and then click OK to accept the settings.

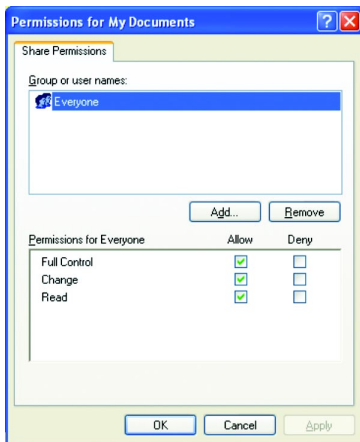

## Networking Basics

4. Click OK on the original Sharing and Security window to conclude the process.

5. Once a disk or folder is shared, the icon will show it via the "holding hand."

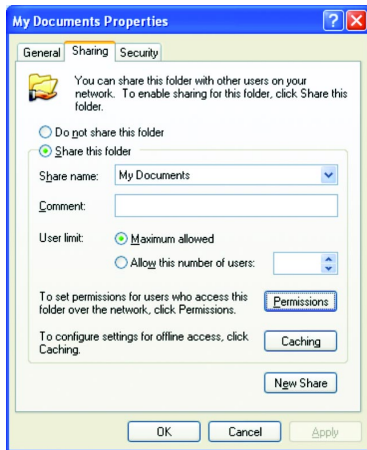

### Topic 5. Share Printers

You may now share any installed printers connected to this computer with other computers on your network.

1. Using the computer that has the printer already connected to it, go to: Start > Control Panel > Printers and Faxes.

Click on the printer you want to share with others on the network and select "Share this printer".

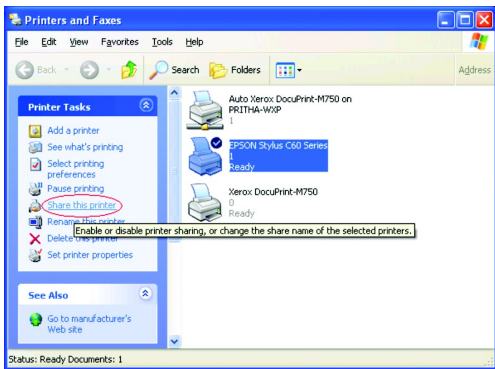

## Networking Basics

2. In the following window, click on "Share this Printer" and type in the share name you would like. After this is done, click on "Apply" and then "OK".

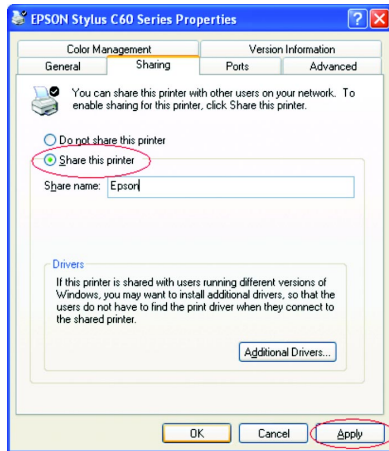

Now when you go to "Printers and Faxes" in the Control Panel, you will see the supporting hand underneath the printer, which means that the printer is being shared in the network.

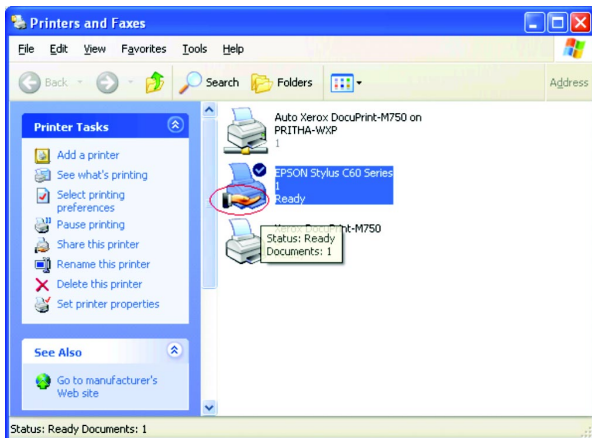

## Networking Basics

*For a computer to access a Network Printer, the device driver or software for that printer must be installed and pointed to the proper location of the printer. This is done similarly to the way you installed the printer on the computer it is connected to.*

1. Go to a computer that is not connected to the printer and select "Start" from the Task Bar "Control Panel" then "Printers and other Hardware".

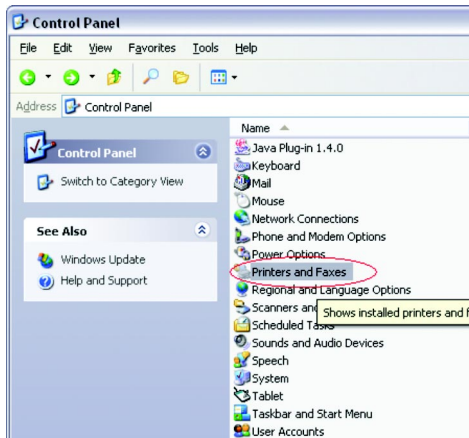

2. Click on "Add a printer".

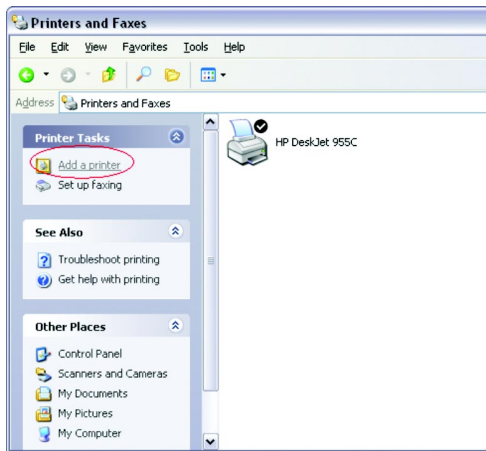

## Networking Basics

3. *Select the network printer option and click Next.*

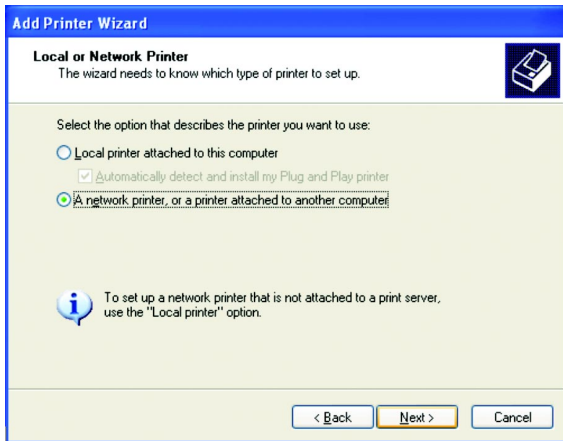



- Find the printer you would like to share and click Next.

**Add Printer Wizard**

**Specify a Printer**  
If you don't know the name or address of the printer, you can search for a printer that meets your needs.



What printer do you want to connect to?

Browse for a printer

Connect to this printer (or to browse for a printer, select this option and click Next):

Name:

Example: \\server\printer

Connect to a printer on the Internet or on a home or office network:

URL:

Example: http://server/printers/myprinter/.printer

< Back   Next >   Cancel

## Networking Basics

*Decide if you would like to choose this printer as a default printer and click Next.*



You have now added the printer to your computer, click Finish.

*Now you may use the Network Printer as if it was directly connected to the computer. Make sure that the computer which is directly connected to the printer is on.*

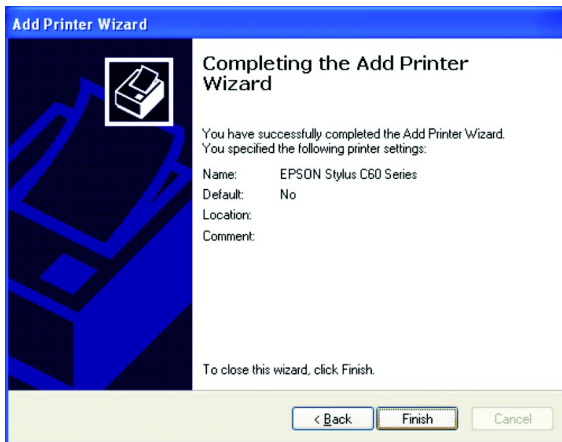

## Sharing Internet Access

### Topic 6. Sharing Internet Access

So how can the Internet connection be shared among other computers on the HomePlug network?

Since neither the HomePlug Bridge nor USB Adapter are capable of routing at this time, a router is necessary in order to share an Internet connection. Future versions of the HomePlug Bridge or USB Adapter may feature built-in routing capabilities.

The following items are required for successfully sharing the Internet connection:

- One (1) Router

- One (1) HomePlug Bridge

- One (1) DSL/Cable Modem

- Active ISP Service for the DSL/Cable Modem

- CAT5 Cables

- Also all computers that share the Internet connection must be connected to a

## Sharing Internet Access

HomePlug to USB Adapter or a HomePlug Bridge.

Please note that sixteen HomePlug Bridges are allowed on one network if used as bridges (without installation of the software).

Please follow these steps for setting up Internet Sharing:

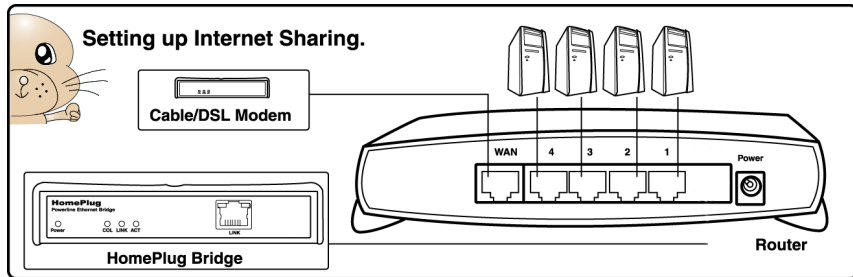

## Sharing Internet Access

- a. Make sure that the DSL/Cable modem is connected to the Router (using the WAN port on the router.)
- b. Connect the HomePlug Bridge to the Router (using the Uplink port on the router.)
- c. Check the link light on the HomePlug Bridge. It must light up green.
- d. Make sure that the computers that need access to the Internet via the HomePlug network are each connected to a HomePlug Adapter or a HomePlug Bridge and reside on the same power grid.

### **Checking Router Settings:**

Please make sure that the following settings on your router are set:

(The setup windows will depend on the router manufacturer's software.)

- A) The IP should be obtained automatically;**
- B) DHCP must be enabled;**
- C) Release DHCP and then Renew DHCP to reset the IP Addresses. It is recommended that you verify that IP Addresses are obtained.**

Once all the above steps have been completed, all HomePlug connected computers will be able to access the Internet.

## Troubleshooting

### Frequently Asked Questions/Troubleshooting

1. Will HomePlug work in my house or apartment?

If the house or apartment was built under U.S. building standards using copper wiring, then it will work.

2. What types of security problems will I be facing?

If your house is on the same power grid as your neighbor, then there is a potential for a hacker to get in through your neighbor's house. However, this is easily remedied by activating the encryption key on the HomePlug device.

3. Will HomePlug work with Mac?

There is currently no software that supports Macs. However, the HomePlug Ethernet Bridge will work with Mac when used as a bridge. Also, by installing Virtual PC software on a Mac, you will be able to install the windows based software under Virtual PC and have this Mac communicate with other PCs on HomePlug network.



#### 4. What is the difference between bridge mode and node mode in the HomePlug Ethernet Bridge (GHPB21)?

Bridge mode operates without software installation and can work with any 10/100Base-T or 10Base-T Ethernet connections. By connecting the bridge to a router, switch, or Ethernet based device (XBOX, PlayStation, Web Tablet, PocketPC, Computer, etc.), you will be able to make these devices bridge onto the HomePlug network.

Node mode operates by connecting the HomePlug USB adapter (GHPU21) or Ethernet bridge (GHPB21) to one computer (ONLY) and installing drivers onto the computer, allowing it to set the device into Node Mode. The advantage with Node Mode operation is there is no limitation to the number of nodes that can operate on a HomePlug network.

## Troubleshooting

### 5. Will HomePlug operate on different Circuit Breakers?

Yes. Circuit breakers do not affect performance of HomePlug devices, however the signal will not pass through the power transformers outside your house.

### 6. Can Neighbors get my HomePlug signal?

It is possible for your immediate (next door) neighbor to receive residual signal from your HomePlug adapter. Unlikely, but possible. To prevent your neighbors from hacking your network, the best thing you can do is type a different encryption password into your device when setting the encryption password. Note: All devices must have the same password to be on one network. If devices do not have the same encryption password, they will not be able to communicate with each other.

7. What OS does the HomePlug utility software fully support?  
Windows 98SE, ME, XP, and 2000. Windows NT and Mac are only supported by the HomePlug Ethernet Bridge (Without installing the HomePlug software with default operating mode as BRIDGE, not NODE)
8. What is the Range of HomePlug?  
Approximately 990 feet (300 meters) in wall power lines.
9. How does 56bit-DES compare with Wireless 802.11b 128bit-WEP encryption?  
56bit-DES is superior because of its DES type Encryption. Just because 802.11B uses 128bit-WEP with more bits doesn't mean the encryption is better. Also, the IOGEAR HomePlug devices use hardware 56bit-DES encryption. With hardware encryption the signal is almost impossible to crack. The hardware encryption process does not affect bandwidth, and the encryption is enabled at all times.

## Getting Technical Support

To help IOGEAR® customers obtain the highest level of performance from their HomePlug devices, the IOGEAR® Service Support team is available to answer your technical questions. Do not hesitate to call if you are having trouble getting your device to work correctly. IOGEAR® Service Support can be reached by phone from 9am to 5pm Pacific Standard Time, Monday through Friday or at the following address:

Toll Free 866-9-IOGEAR (USA)  
Phone: 949-453-8782

23 Hubble  
Irvine, CA 92618

You may also reach us online at [www.iogear.com/support](http://www.iogear.com/support) 24 hours a day. Please be ready to give a brief description of the problem, and what you were doing when the problem occurred, before calling Service Support. The Service Support representative will be able to serve you much quicker if you are prepared to answer the nine questions listed below.

## Getting Technical Support

- 1) What is the purchase date and serial number of the product?
- 2) Were any messages displayed on the screen when the error occurred? If so, what was the exact wording of the message?
- 3) What type of Computer are you using?
- 4) When does the problem occur?
- 5) Can the problem be reproduced? If so, what are the steps necessary to reproduce the problem?
- 6) What version of the OS are you using?
- 7) Are you on a network? If so, what type of network is it?
- 8) What have you already tried to get the problem resolved?

## Product Specifications

Function	GHPB21
<b>Computer Interface</b>	IEEE 802.3
<b>Data Rate</b>	14 Mbps
<b>Dimensions</b>	
Depth	3.75"
Height	1"
Width	5.25"
<b>Housing</b>	
Case	Metal/Plastic
<b>Humidity</b>	5% - 90%
<b>LEDs</b>	
ACT (Activity)	1
COL (Collision)	1
Link	1
Link/Act	1
Power On	1
<b>Network Interface</b>	<u>HomePlug Powerline</u>
<b>Package Dimensions</b>	
Depth	6.75"
Height	1.5"
Width	9"
<b>Power Consumption</b>	3.5 Watts
<b>Security</b>	56-bit DES Encryption
<b>Weight</b>	1.05 Lbs

### Limited Warranty

IN NO EVENT SHALL THE DIRECT VENDOR'S LIABILITY FOR DIRECT, INDIRECT, SPECIAL, INCIDENTAL OR CONSEQUENTIAL DAMAGES RESULTING FROM THE USE OF THE PRODUCT, DISK, OR ITS DOCUMENTATION EXCEED THE PRICE PAID FOR THE PRODUCT.

The direct vendor makes no warranty or representation, expressed, implied, or statutory with respect to the contents or use of this documentation, and especially disclaims its quality, performance, merchantability, or fitness for any particular purpose.

The direct vendor also reserves the right to revise or update the device or documentation without obligation to notify any individual or entity of such revisions, or updates. For further inquiries please contact your direct vendor.



© 2003 IOGEAR® All Rights Reserved. PKG-M0066

IOGEAR and the IOGEAR logo are trademarks or registered trademarks of IOGEAR Inc. Microsoft and Windows are registered trademarks of Microsoft Corporation. IBM is a registered trademark of International Business Machines, Inc. FireWire, MAC, Macintosh, G3, G4, iMac, Apple are registered trademarks of Apple Computer, Inc. Classic is a registered trademark, licensed to Apple Computer, Inc. Finder is a trademark of Apple Computer, Inc. All other brand and product names are trademarks or registered trademarks of their respective holders. IOGEAR makes no warranty of any kind with regards to the information presented in this document. All information furnished here is for informational purposes only and is subject to change without notice. IOGEAR assumes no responsibility for any inaccuracies or errors that may appear in this document. Reproduction in whole or part without permission is prohibited.







**Contact info.**

---

23 Hubble • Irvine, CA 92618 • (P) 949.453.8782 • (F) 949.453.8785 • [www.iogear.com](http://www.iogear.com)