

SFP Bi-Directional Transceiver Module for Fast Ethernet, ATM, SONET OC-3/SDH STM-1



FEATURES

- RoHS compliant
- SFF-8472 MSA compliant
- Simplex LC connector
- 1310nm Transmitter, 1550nm Receiver
- Single + 3.3V power supply and TTL logic interface
- Commercial and Industrial temperature available
- Bellcore GR-468 compliant
- Laser class 1 product which comply with the requirements of IEC 60825-1 and IEC 60825-2

Description

The SPBD-155xxxx series are hot pluggable 3.3V Small-Form-Factor (SFP) Bi-Directional transceiver module designed expressly for high-speed communication applications that require rates of up to 155Mbit/sec. It is compliant with the Fast Ethernet, ATM, SONET OC-3/SDH STM-1 standards, as well as the SFP Multisource Agreement (MSA).

The SPBD-155xxxx transceivers provide with the LC receptacle that is compatible with the industry standard LC connector. The transceiver is also compatible with industry standard RFT connector and cage. It also includes a LOS (Loss Of Signal) circuit that provides a TTL logic-high output when an unusable optical signal level is detected.

The module includes 1310nm un-cool FP laser, InGaAs PIN, Preamplifier and WDM filter in a high-integrated optical assembly for high-density system application. The SFP Bi-Directional transceiver can upgrade transmission capacity very convenient without installing new fibers.

Application

- TTC TS-1000
- IEEE 802.3ah 100BASE-BX
- SONET OC-3/SDH STM-1
- FTTx WDM Broadband Access
- 100Base Fast Ethernet

Performance

- SPBD-155E4J1R data link up to 15km in 9/125um single mode fiber.

1. Absolute Maximum Ratings

Parameter	Symbol	Min.	Typ.	Max.	Unit	Note
Storage Temperature	Ts	-40		85	°C	
Operating Ambient Temperature	Ta	-10		80	°C	
Storage Ambient Humidity	HA	5		95	%	
Power Supply Voltage	Vcc	0		5	V	
Signal Input Voltage		-0.3		Vcc+0.3	V	
Optical Input Power (Peak)				4	dBm	

2. Recommended Operating Conditions

Parameter	Symbol	Min.	Typ.	Max.	Unit	Note
Ambient Operating Temperature	TA	0		70	°C	
Ambient Humidity	HA	5		85	%	Non-condensing
Power Supply Voltage	Vcc	3.135	3.3	3.465	V	
Power Supply Current	ICC			250	mA	
Power Supply Noise Rejection				100	mVp-p	100Hz to 1MHz
Data Rate		10		155.52	Mbps	
Transmission Distance				15	km	

3. Specification of Transmitter

Parameter	Symbol	Min.	Typ.	Max.	Unit	Note
Average Launched Power	P _O	-14		-8	dBm	Note (1)
Optical Extinction Ratio	ER	10			dB	
Center Wavelength	λ_c	1260	1310	1360	nm	FP Laser
Spectrum Width (RMS)	σ			6	nm	
Transmitter OFF Output Power	P _{Off}			-45	dBm	
Optical Rise/Fall Time	t _r /t _f			1.3	ns	Note (2)
Total Jitter	TJ			1	ns	Note (3)
Optical Return Loss Tolerance	ORLT			14	dB	
Relative Intensity Noise	RIN			-116	dB/Hz	
Dispersion Penalty	TDP			1	dB	
Output Eye Mask	Compliant with Bellcore TR-NWT-000253 and ITU recommendation G.957					Note (4)

Note (1). Launched power (avg.) is power coupled into a single mode fiber.

Note (2). These are unfiltered 20-80% values.

Note (3). Measure at 2²³-1 NRZ PRBS pattern.

Note (4). Eye Mask definition

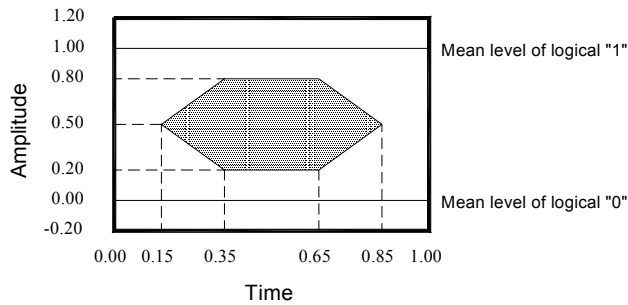

Optical Pulse Mask with Bessel Filter Specified in ITU-T G.957

4. Specification of Receiver

Parameter	Symbol	Min.	Typ.	Max.	Unit	Note
Input Optical Wavelength	λ_{IN}	1480		1600	nm	PIN-PD
Receiver Sensitivity	P_{IN}			-31	dBm	Note (1)
Input Saturation Power (Overload)	P_{SAT}	-3			dBm	
LOS-Deassert Power	P_A	-		-32	dBm	
LOS-Assert Power	P_D	-44			dBm	Note (2)
LOS Hysteresis	$P_A - P_D$	0.5	2	5	dB	
Optical Reflectance				-14	dB	Note (3)
Output Data Rise/Fall time	t_r/t_f			1.5	ns	Note (4)
S/X Endurance				10	dB	Note (5)
Optical Isolation		25			dB	Note (6)

Note (1). Measured with 1520nm, ER=10dB; BER = $<10^{-10}$ @ PRBS = $2^{23}-1$ NRZ

Note (2). When LOS asserted, the data output is Low-level (fixed)

Note (3). When the terminal is viewed from the optical path, the reflection toward the optical path of the optical signal with a central wavelength of 1480nm to 1580nm transmitted to terminal.

Note (4). These are 20%~80% values

Note (5). X=10 MHz, Rectangular BER = 10^{-10}

Note (6). Receiver isolation between 1260nm ~1360nm

5. Electrical Interface Characteristics

Parameter	Symbol	Min.	Typ.	Max.	Unit	Note
Transmitter						
Total Supply Current	I_{CC}			A	mA	Note (1)
Differential Data Input Swing	VDT	500		2400	mV _{p-p}	
Differential line input Impedance	R_{IN}	80	100	120	Ohm	
Data Input Voltage- High	$V_{IH}-V_{CC}$	-1.165		-0.880	V	
Data Input Voltage- Low	$V_{IL}-V_{CC}$	-1.810		-1.475	V	
Transmitter Disable Input-High	V_{DISH}	2		V_{CC}	V	
Transmitter Disable Input-Low	V_{DISL}	0		0.8	V	
Transmitter Fault Output-High	V_{TXFH}	2		$V_{CC}+0.3$	V	
Transmitter Fault Output-Low	V_{TXFL}	0		0.8	V	
Transmitter Fault Pull up Resistor	R_{TX_FAULT}	4.7		10	k Ω	Note (2)
Receiver						
Total Supply Current	I_{CC}			B	mA	Note (1)
Differential Data Output Swing	VDR	400		2000	mV _{p-p}	Note (3)
Data Output Voltage-High	$V_{OH}-V_{CC}$	-1.085		-0.880	V	
Data Output Voltage-Low	$V_{OL}-V_{CC}$	-1.830		-1.555	V	
LOS Output Voltage-High	V_{LOSH}	2		$V_{CC}+0.3$	V	
LOS Output Voltage-Low	V_{LOSL}	0		0.8	V	
Receiver LOS Load	R_{RXLOS}	4.7		10	k Ω	Note (2)

Note (1). A (TX)+ B (RX) = 250mA (Not include termination circuit)

Note (2). Pull up to V_{CC} on host Board.

Note (3). Internally AC coupled, but requires a 100Ohm differential termination at or internal to Serializer/ Deserializer.

6. Timing of Control and Status I/O

Parameter	Symbol	Min.	Max.	Unit	Unit Conditions
TX_DISABLE Assert Time	t _{off}		10	μ sec	Time from rising edge of TX_DISABLE to when the optical output falls below 10% of nominal
TX_DISABLE Negate Time	t _{on}		1	msec	Time from falling edge of TX_DISABLE to when the modulated optical output rises above 90% of nominal
Time to initialize, including reset of TX_FAULT	t _{init}		300	msec	From power on or negation of TX_Fault using TX_Disable.
TX_Fault Assert Time	t _{fault}		100	μ sec	Time from fault to TX_Fault on.
TX_DISABLE to reset	t _{rest}	10		μ sec	Time TX_Disable must be held high to reset TX_Fault
LOS Assert Time	t _{loss_on}		100	μ sec	Time from LOS state to Rx LOS assert
LOS Deassert Time	t _{loss_off}		100	μ sec	Time from non-LOS state to Rx LOS deassert
Serial ID Clock Rate	f _{serial_clock}		100	kHz	

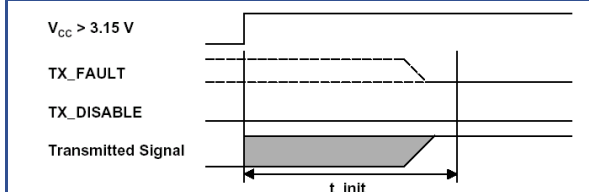
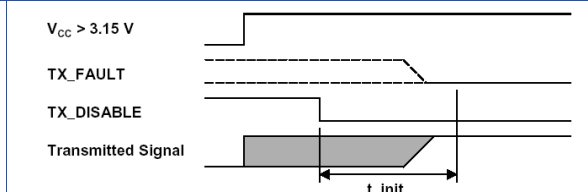
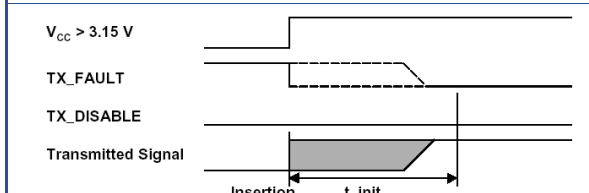
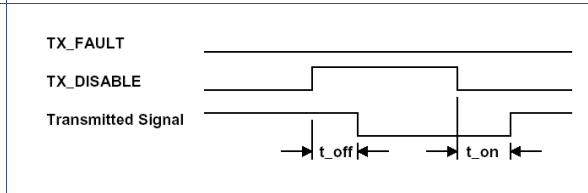
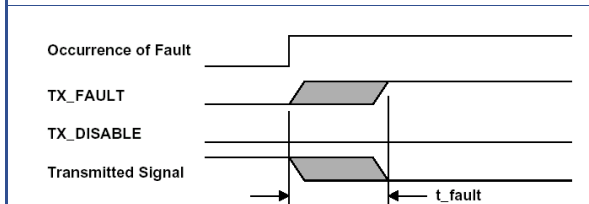
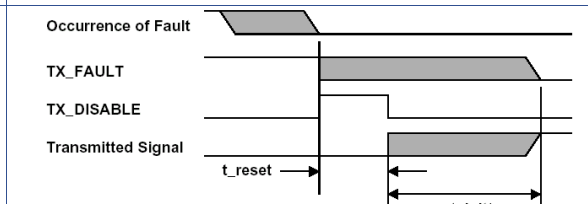
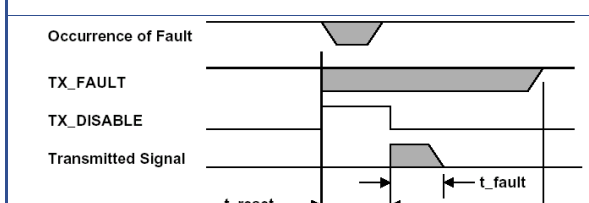
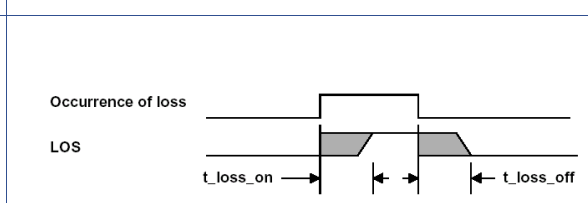
Timing Parameters Definition	
<p>$V_{CC} > 3.15\text{ V}$</p> 	<p>$V_{CC} > 3.15\text{ V}$</p> 
Power on initialization of SFP transceiver, TX_DISABLE negated	Power on initialization of SFP, TX_DISABLE asserted Initialization during hot plugging of SFP TRANSCEIVER.
<p>$V_{CC} > 3.15\text{ V}$</p> 	
Example of initialization during hot plugging, TX_DISABLE negated.	SFP TX_DISABLE timing during normal operation.
	 <p><small>*SFP shall clear TX_FAULT in $< t_{init}$ if the failure is transient</small></p>
Detection of transmitter safety fault condition	Successful recovery from transient safety fault condition
 <p><small>*SFP shall clear TX_FAULT in $< t_{init}$ if the failure is transient</small></p>	
Unsuccessful recovery from safety fault condition	Timing of LOS detection

7. Pin Description

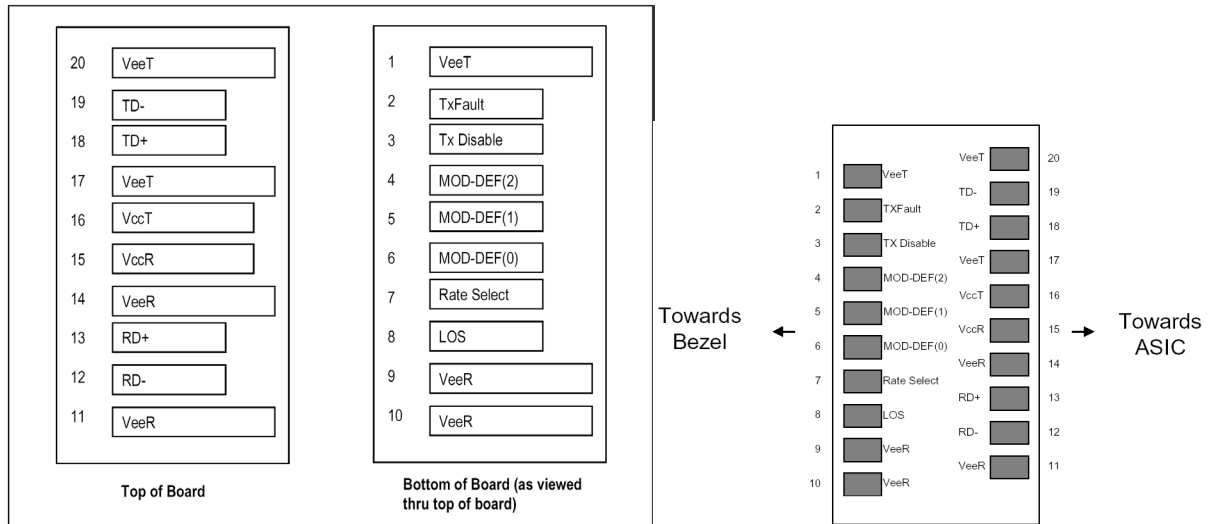

SFP Transceiver Electrical Pad Layout

Host Board Connector Pad Layout

Pin Function Definitions

Pin Num.	Name	Function	Plug Seq.	Notes
1	VeeT	Transmitter Ground	1	Note (1)
2	TX Fault	Transmitter Fault Indication	3	Note (2)
3	TX Disable	Transmitter Disable	3	Note (3)
4	MOD-DEF2	Module Definition 2	3	Note (4), 2 wire serial ID interface
5	MOD-DEF1	Module Definition 1	3	Note (4), 2 wire serial ID interface
6	MOD-DEF0	Module Definition 0	3	Note (4), Grounded in Module
7	Rate Select	Not Connect	3	Function not available
8	LOS	Loss of Signal	3	Note (5)
9	VeeR	Receiver Ground	1	
10	VeeR	Receiver Ground	1	
11	VeeR	Receiver Ground	1	
12	RD-	Inv. Received Data Out	3	Note (6)
13	RD+	Received Data Out	3	Note (6)
14	VeeR	Receiver Ground	1	
15	VccR	Receiver Power	2	Note (7)
16	VccT	Transmitter Power	2	Note (7)
17	VeeT	Transmitter Ground	1	
18	TD+	Transmit Data In	3	Note (8)
19	TD-	Inv. Transmit Data In	3	Note (8)
20	VeeT	Transmitter Ground	1	

Plug Seq.: Pin engagement sequence during hot plugging.

Notes:

- 1) Circuit ground is internally isolated from frame (chassis) ground. Tx GND and Rx GND may be internally isolated within the TRx module.
- 2) TX Fault is an open collector/drain output, which should be pulled up with a 4.7K~10K Ω resistor on the host board. Pull up voltage between 2.0V and VccT+0.3V. The output indicates Low when the transmitter is operating normally, and High with a laser fault including laser end-of-life. In the low state, the output will be pulled to less than 0.8V.
- 3) TX disable is an input that is used to shut down the transmitter optical output. It is pulled up within the module with a 4.7 – 10 K Ω resistor. Its states are:

Low (0 – 0.8V):	Transmitter on
(>0.8, < 2.0V):	Undefined
High (2.0 – 3.465V):	Transmitter Disabled
Open:	Transmitter Disabled
- 4) Mod-Def 0,1,2. These are the module definition pins. They should be pulled up with a 4.7K – 10K Ω resistor on the host board. The pull-up voltage shall be VccT or VccR.
Mod-Def 0 is grounded by the module to indicate that the module is present
Mod-Def 1 is the clock line of two-wire serial interface for serial ID
Mod-Def 2 is the data line of two-wire serial interface for serial ID
- 5) LOS (Loss of Signal) is an open collector/drain output, which should be pulled up with a 4.7K – 10K Ω resistor. Pull up voltage between 2.0V and VccR+0.3V. When high, this output indicates the received optical power is below the worst-case receiver sensitivity. Low indicates normal operation. In the low state, the output will be pulled to less than 0.8V.
- 6) RD-/+ : These are the differential receiver outputs. They are AC coupled 100 Ω differential lines which should be terminated with 100 Ω (differential) at the user SERDES. The AC coupling is done inside the module and is thus not required on the host board. The voltage swing on these lines will be between 400 and 2000 mV differential (200 – 1000 mV single ended) when properly terminated.
- 7) VccR and VccT are the receiver and transmitter power supplies. They are defined as 3.3V \pm 5% at the SFP connector pin. Recommended host board power supply filtering is shown below page. Inductors with DC resistance of less than 1 Ohm should be used in order to maintain the required voltage at the SFP input pin with 3.3V supply voltage. When the recommended supply-filtering network is used, hot plugging of the SFP transceiver module will result in an inrush current of no more than 30 mA greater than the steady state value.
- 8) TD-/+ : These are the differential transmitter inputs. They are AC-coupled, differential lines with 100 Ω differential termination inside the module. The AC coupling is done inside the module and is thus not required on the host board. The inputs will accept differential swings of 500 – 2400 mV (250 – 1200 mV single-ended), though it is recommended that values between 500 and 1200 mV differential (250 – 600 mV single-ended) be used for best EMI performance.

8. Recommend Interface Circuit

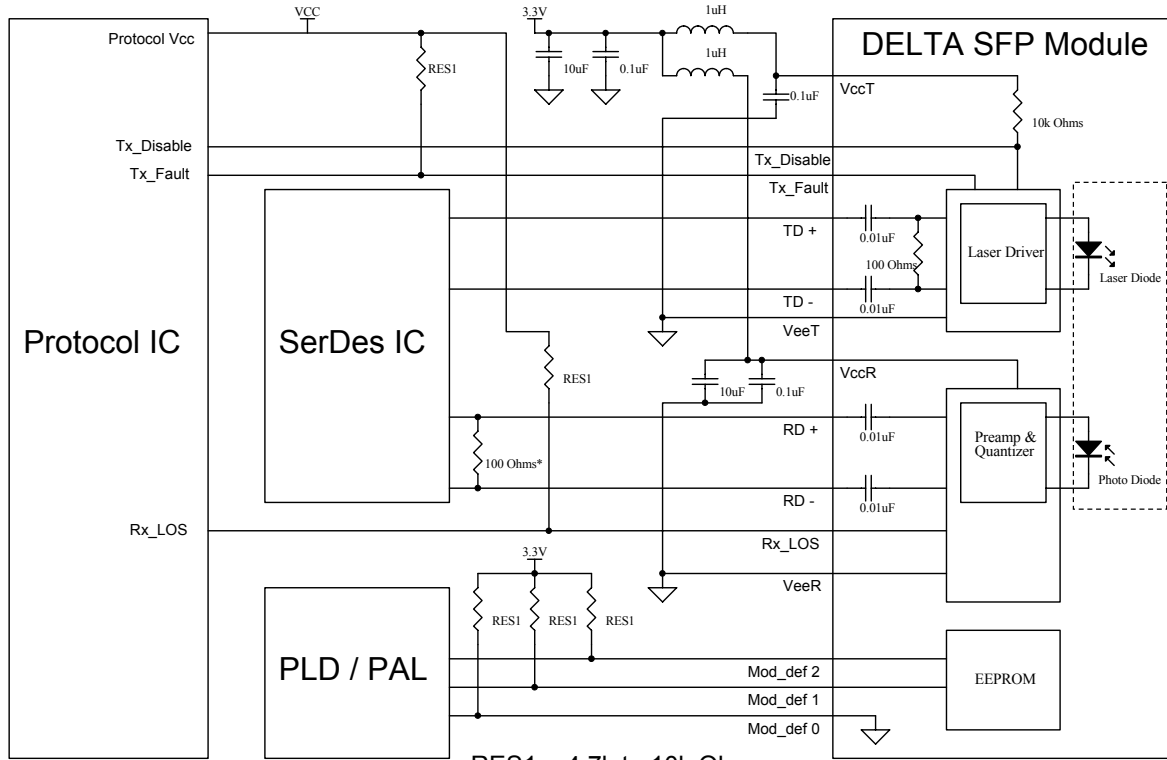

RES1 = 4.7k to 10k Ohms

* Depends on SerDes IC used

SFP Host Board Schematic

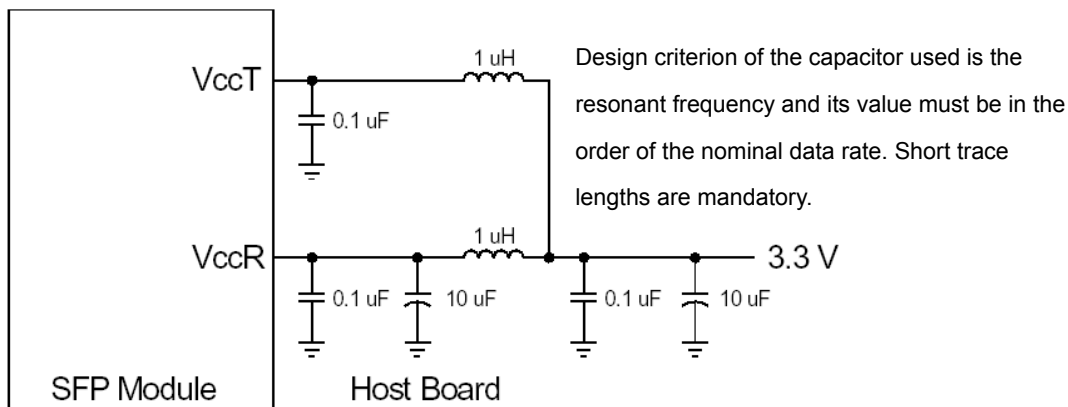

Design criterion of the capacitor used is the resonant frequency and its value must be in the order of the nominal data rate. Short trace lengths are mandatory.

Recommended Host Board Supply Filtering Network

9. Outline Dimensions

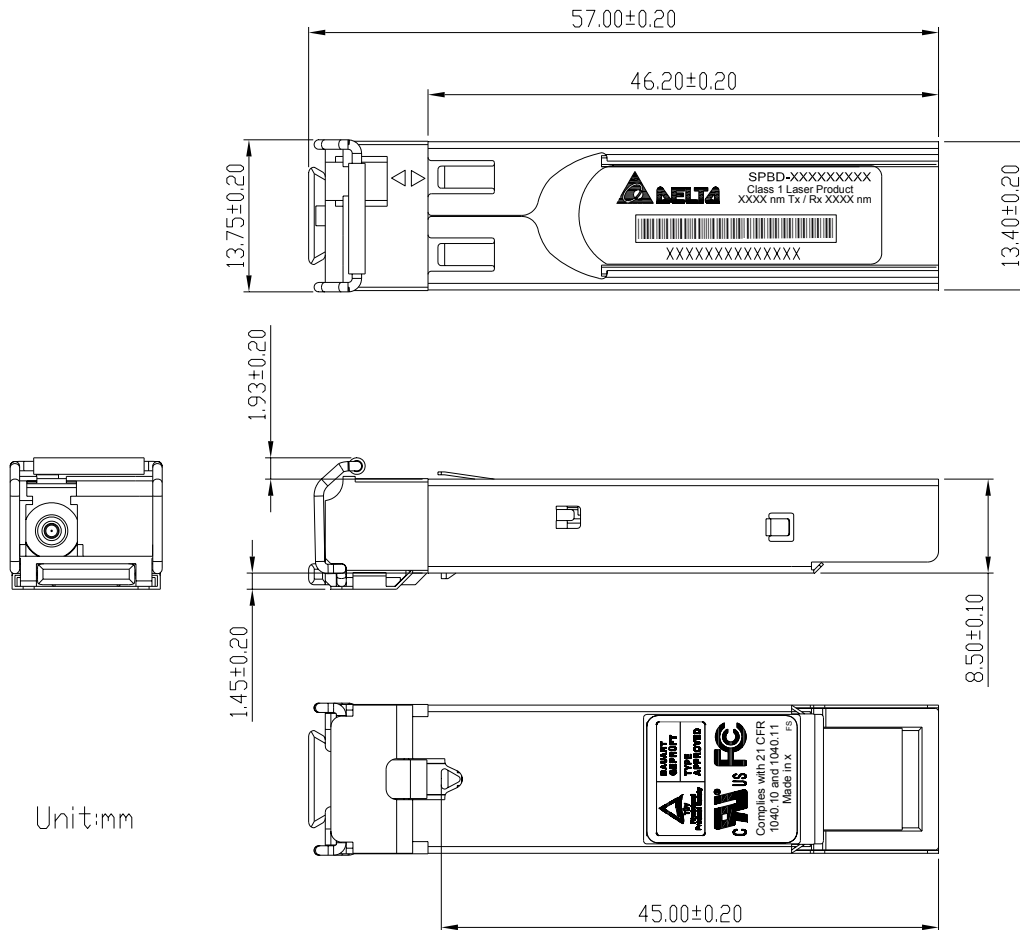

Unit:mm

S/N

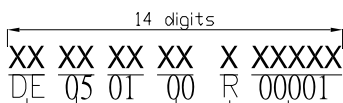

- S/N : (00001~99999)
- Rework : Rework=R or No-rework=0
- Vender NOTE : Free or 00
- Week (52Weeks/Year) : 1月2日=01
- Year : 2005=05
- Vender CODE : DELTA=DE

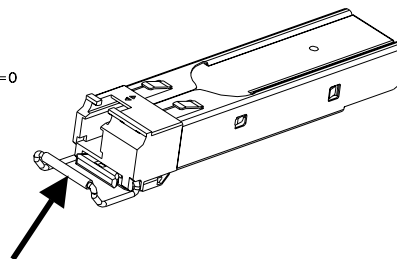

Transmitter Wavelength	Latch Color Identifier
1310nm	Black
1550nm	Yellow

10. EEPROM Serial ID Memory Contents (2-Wire Address A0h)

Address	Hex	ASCII	Address	Hex	ASCII	Address	Hex	ASCII	Address	Hex	ASCII	Address	Hex	ASCII
00	03		25	20		50	4A	J	75	SN		100	00	
01	04		26	20		51	31	1	76	SN		101	00	
02	07		27	20		52	52	R	77	SN		102	00	
03	00		28	20		53	20		78	SN		103	00	
04	10		29	20		54	20		79	SN		104	00	
05	02		30	20		55	20		80	SN		105	00	
06	40		31	20		56	30		81	SN		106	00	
07	00		32	20		57	30		82	SN		107	00	
08	00		33	20		58	30		83	SN		108	00	
09	00		34	20		59	30		84	DC	Note 3	109	00	
10	00		35	20		60	05		85	DC		110	00	
11	03		36	00		61	1E		86	DC		111	00	
12	02		37	00		62	00		87	DC		112	00	
13	00		38	00		63	CS1	Note 1	88	DC		113	00	
14	0F		39	00		64	00		89	DC		114	00	
15	96		40	53	S	65	1A		90	DC		115	00	
16	00		41	50	P	66	05		91	DC		116	00	
17	00		42	42	B	67	05		92	00		117	00	
18	00		43	44	D	68	SN	Note 2	93	00		118	00	
19	00		44	2D	-	69	SN		94	00		119	00	
20	44	D	45	31	1	70	SN		95	CS2	Note 4	120	00	
21	45	E	46	35	5	71	SN		96	00		121	00	
22	4C	L	47	35	5	72	SN		97	00		122	00	
23	54	T	48	45	E	73	SN		98	00		123	00	
24	41	A	49	34	4	74	SN		99	00		124	00	
												125	00	
												126	00	
												127	00	
												128	00	Reserved
												~	00	for future
												255	00	use.

Notes:

- 1) Byte 63(CS1): Check sum of bytes 0-62.
- 2) Byte 68-83 (SN): Serial number.
- 3) Byte 84-91 (DC): Date code.
- 4) Byte 95 (CS2): Check sum of bytes 64-94.

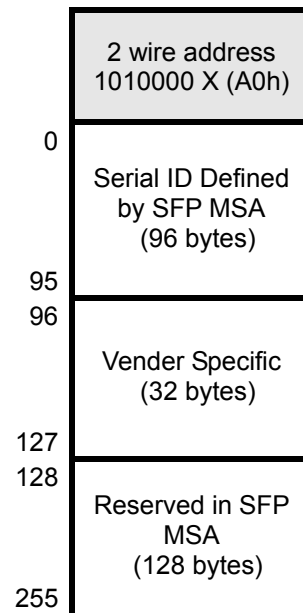

11. Regulatory Compliance

Feature	Test Method	Reference	Performance
Electrostatic Discharge (ESD) to the Electrical Pins	Human Body Model (HBM)	MIL-STD-883E Method 3015.7 EIA-JESD22-A114	(1) Satisfied with electrical characteristics of product spec. (2) No physical damage
	Machine Model (MM)	EIA-JESD22-A115	
Electrostatic Discharge (ESD) to the Simplex Receptacle	Contact Discharge	IEC/EN 61000-4-2	
	Air Discharge	IEC/EN 61000-4-2	
Radio Frequency Electromagnetic Field Immunity		IEC/EN 61000-4-3	
Electromagnetic Interference (EMI)		FCC Part 15 Class B EN 55022 Class B (CISPR 22A)	
Laser Eye Safety	FDA/CDRH	FDA 21CFR 1040.10, 1040.11	CDRH File # 0420993
	TUV	IEC/EN 60825-1 IEC/EN 60825-2	TUV Certificate # R50032471
Component Recognition	TUV	IEC/EN 60950	
	UL/CSA	UL 60950	UL File # E239394

Appendix A. Document Revision

Version No.	Date	Description
S0	2006-03-28	Preliminary datasheet
S1	2006-09-20	1. Update receiver differential data output swing to min. 400mV. 2. Add barcode on product label