

## Digital Automatic Blood Pressure Monitor Model i-C10

- Instruction Manual
- Mode d'emploi
- Gebrauchsanweisung
- Manuale di istruzioni
- Manual de instrucciones
- Gebruiksaanwijzing
- РУКОВОДСТВО ПО ЭКСПЛУАТАЦИИ

EN

FR

DE

IT

ES

NL

RU

AR

• كتيب الإرشادات



All for Healthcare

# Contents

## **Before using the unit**

<b>Introduction .....</b>	<b>3</b>
<b>Important Safety Information .....</b>	<b>4</b>
<b>1. Overview .....</b>	<b>6</b>
<b>2. Preparation .....</b>	<b>10</b>
2.1 Installing/Replacing the Batteries .....	10
2.2 Setting the Date and Time .....	12

## **Operating instructions**

<b>3. Using the Unit.....</b>	<b>16</b>
3.1 How to Sit Correctly When Taking a Measurement.....	16
3.2 Applying the Arm Cuff.....	18
3.3 Taking a Reading.....	21
3.4 Instructions for Special Conditions .....	31
3.5 Using the Memory Function.....	32
<b>4. Quick Reference Guide .....</b>	<b>39</b>

## **Care and maintenance**

<b>5. Handling Errors and Problems .....</b>	<b>40</b>
5.1 Error Messages .....	40
5.2 Troubleshooting.....	41
<b>6. Maintenance and Storage .....</b>	<b>42</b>
<b>7. Optional Parts .....</b>	<b>43</b>
<b>8. Technical Data.....</b>	<b>44</b>
<b>9. Some Useful Information about Blood Pressure .....</b>	<b>46</b>

## Introduction

Thank you for purchasing the OMRON i-C10 Intellisense Upper Arm Blood Pressure Monitor.

The OMRON i-C10 Intellisense is a fully automatic blood pressure monitor, operating on the oscillometric principle. It measures your blood pressure and pulse rate simply and quickly. For comfortable controlled inflation without the need for pressure pre-setting or re-inflation the device uses its advanced “Intellisense” technology.

The monitor stores measurement results for two people and features morning and evening averages. The auto mode allows for three consecutive measurements with timed intervals for an average reading.



**Please read this instruction manual thoroughly before using the unit. For specific information about your own blood pressure, CONSULT YOUR DOCTOR.**

## Important Safety Information

Consult your doctor during pregnancy, arrhythmia and arteriosclerosis. Please read this section carefully before using the unit.

### **Warning:**

Indicates a potentially hazardous situation which, if not avoided, could result in death or serious injury.

#### **(General Usage)**

- Always consult your doctor. Self-diagnosis of measurement results and selftreatment are dangerous.
- People with severe blood flow problems, or blood disorders, should consult a doctor before using the unit. Cuff inflation can cause internal bleeding.

#### **(Battery Usage)**

- If battery fluid should get in your eyes, immediately rinse with plenty of clean water. Consult a doctor immediately.

#### **(Optional AC Adapter Usage)**

- Never plug in or unplug the power cord from the electric outlet with wet hands.

### **Caution:**

Indicates a potentially hazardous situation which, if not avoided, may result in minor or moderate injury to the user or patient or damage to the equipment or other property.

#### **(General Usage)**

- Do not leave the unit unattended with infants or persons who cannot express their consent.
- Do not use the unit for any purpose other than measuring blood pressure.
- Do not disassemble the unit or arm cuff.
- Do not inflate the arm cuff over 299 mmHg.
- Do not use a mobile phone, or other devices that emit electromagnetic fields, near the unit. This may result in incorrect operation of the unit.
- Do not operate unit in a moving vehicle (car, airplane).

**(Optional AC Adapter Usage)**

- Use only the original AC adapter designed for this unit. Use of unsupported adapters may damage and/or may be hazardous to the unit.
- Plug the AC adapter into the appropriate voltage outlet.
- Do not use the AC adapter if the unit or the power cord is damaged. Turn off the power and unplug the power cord immediately.

**(Battery Usage)**

- If battery fluid should get on your skin or clothing, immediately rinse with plenty of clean water.
- Use only four “AA” alkaline batteries with this unit. Do not use other types of batteries.
- Do not insert the batteries with their polarities incorrectly aligned.
- Replace old batteries with new ones immediately. Replace all four batteries at the same time.
- Remove the batteries if the unit will not be used for three months or more.
- When the batteries are replaced, you may need to reset the date and time. If the year is flashing on the display screen, refer to “2.2 Setting the Date and Time”.
- Do not use new and used batteries together.

**General Safety Precautions**



- Do not forcibly bend the arm cuff or bend the air tube excessively.
- When removing the air tube, pull on the air plug at the connection with the main unit not the tube itself.
- Do not inflate the arm cuff when it is not wrapped around your arm.
- Do not apply strong shocks and vibrations to or drop the unit.
- Do not take measurements after bathing, drinking alcohol, smoking, exercising or eating.
- Do not wash the arm cuff or immerse it in water.
- Read and follow the “Important information regarding Electro Magnetic Compatibility (EMC)” in the Technical Data Section.
- Read and follow the “Correct Disposal of This Product” in the Technical Data Section when disposing of the device and any used accessories or optional parts.

**Save these instructions for future reference.**

# 1. Overview

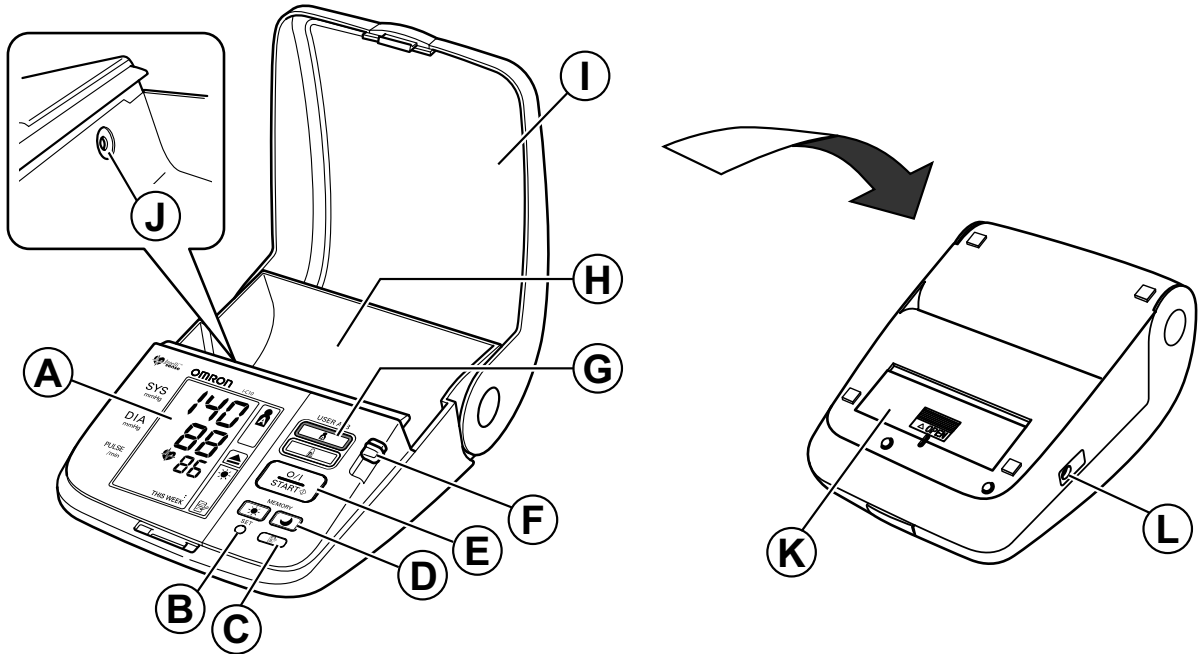
## Main Unit



- A. Display
- B. SET button
- C. MEMORY button (  )
- D. Morning/Evening Average buttons (  /  )
- E. O/I START button
- F. User ID selection switch (A or B)

- G. User ID symbol (A or B)
- H. Cuff compartment
- I. Monitor cover
- J. Air jack
- K. Battery compartment
- L. AC adapter jack (for optional AC adapter)

## Arm Cuff

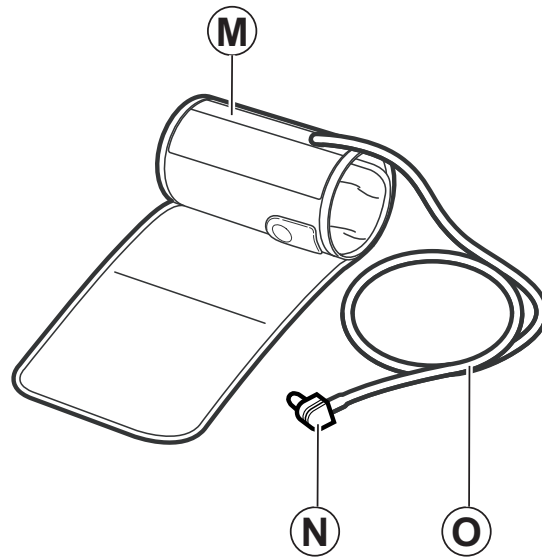

- M. Arm cuff  
(Medium cuff: arm circumference 22-42 cm)
- N. Air Plug
- O. Air Tube

## Display

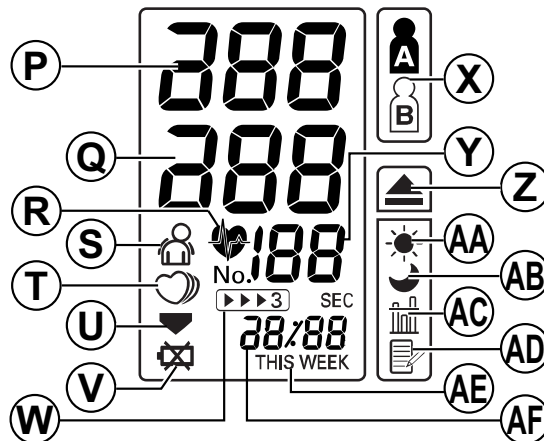

- |  |   |
|--|---|
| <ul style="list-style-type: none"> <li>P. Systolic blood pressure</li> <li>Q. Diastolic blood pressure</li> <li>R. Heartbeat symbol             <ul style="list-style-type: none"> <li>1. (Flashes during measurement)</li> <li>2. (If flashing after measurement completed indicates blood pressure out of recommended range)</li> </ul> </li> <li>S. Movement symbol<br/>(Displayed if you move your body during the measurement.)</li> <li>T. Irregular heartbeat symbol</li> <li>U. Deflation symbol</li> <li>V. Battery low symbol</li> <li>W. Auto mode symbol<br/>(Displayed when Auto Mode is set.)</li> </ul> | <ul style="list-style-type: none"> <li>X. User ID symbol (A or B)<br/>(Indicates user A or user B as selected by the user to take a measurement or when using the memory function.)</li> <li>Y. Pulse display</li> <li>Z. Early morning hypertension symbol<br/>(Displayed if the morning average reading for a week is above 135 for the systolic blood pressure value and/or 85 for the diastolic blood pressure value.)</li> <li>AA. Morning average symbol<br/>(Displayed when viewing morning averages using the memory function.)</li> <li>AB. Evening average symbol<br/>(Displayed when viewing evening averages using the memory function.)</li> <li>AC. Average value symbol<br/>(Displayed when viewing value for the last three measurements)</li> <li>AD. Memory symbol<br/>(Displayed when viewing values stored in memory)</li> <li>AE. Week display</li> <li>AF. Date/Time display</li> </ul> |
|--|---|



## Package Contents

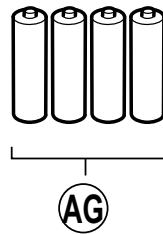

AG. Four "AA" alkaline (LR6) batteries

- Instruction manual
- Guarantee card
- Blood pressure pass
- Blood Pressure Monitor unit

## 2. Preparation

### 2.1 Installing/Replacing the Batteries

---

1. Turn the main unit upside down.

---

2. Slide the battery cover in the direction of the arrow while pressing the ribbed part of the cover.

---

3. Install or replace four “AA” size batteries so that the + (positive) and - (negative) polarities match the polarities indicated on the battery compartment.

---

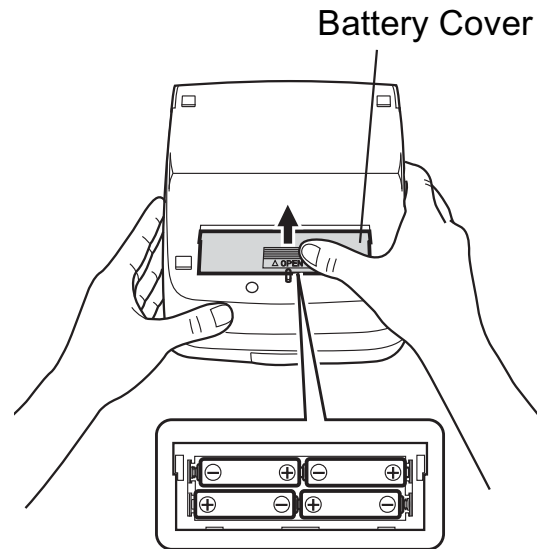

---

4. Put the battery cover back in place.

Slide the battery cover as indicated, until it clicks into place.

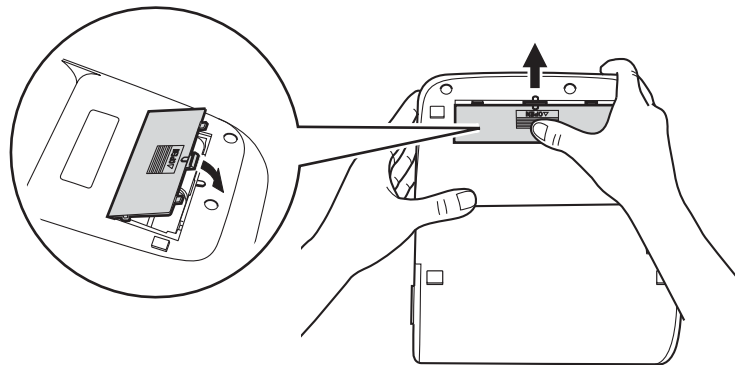

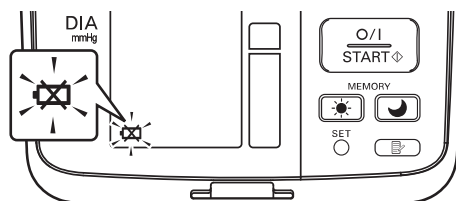

**Note:** The measurement values continue to be stored in memory even after the batteries are replaced.

## Battery Life & Replacement



If the battery low symbol (  ) appears on the display, replace all four batteries at the same time.

- When the battery low symbol (  ) starts to blink, you will still be able to use the unit for a short while. You should replace the batteries with new ones ahead of time.
- When the symbol (  ) remains lit, the batteries are exhausted. You should replace the batteries with new ones at once. Turn the unit off before replacing the batteries.
- Remove the batteries if the unit will not be used for three months or more.
- If the batteries have been removed for more than 30 seconds, the Date/Time setting will need to be reset. See Chapter 2.2 for details.
- Dispose of batteries according to applicable local regulations.

Four new “AA” alkaline batteries will last for approximately 1400 measurements, when used to take six measurements a day.

Since the supplied batteries are for monitoring use only, they may have a shorter life and not last for 1400 measurements.

## 2.2 Setting the Date and Time

Your blood pressure monitor automatically stores up to 84 individual measurement values with the date and time.

To make use of the memory and average values functions:

- Set the unit to the correct date and time before taking a measurement for the first time.
- If the batteries have been removed for more than 30 seconds, the Date/Time setting will need to be reset.

1. When the O/I START button is pressed to turn the unit on for the first time after inserting batteries, the year digits (2007) will flash on the display.

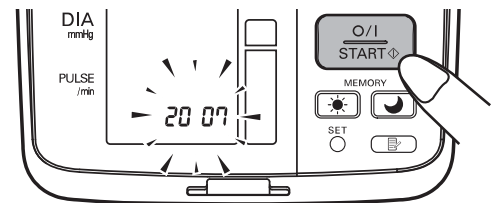

2. Press the MEMORY button (  ) to advance the digits one at a time.

**Notes:**

- The range for the year setting is 2007 to 2030. If the year reaches 2030, it will return to 2007.
- If you hold down the MEMORY button (  ), the digits will advance rapidly.

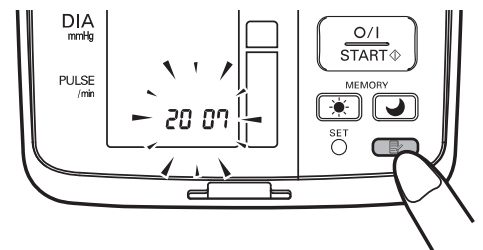

3. Press the SET button to confirm the setting when the desired number appears on the display.

The year is set and the month digits flash on the display.

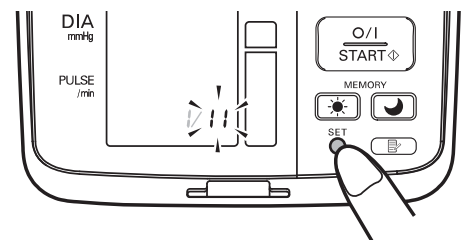

- 4.** Repeat steps 2 and 3 to set the month.

The month is set and the day digits flash on the display.

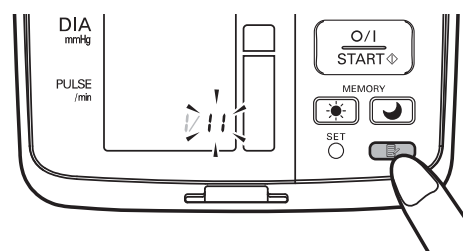

- 5.** Repeat steps 2 and 3 to set the day.

The day is set and the hour digits flash on the display.

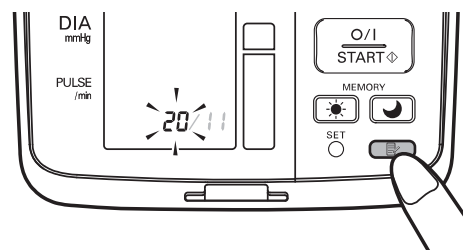

- 6.** Repeat steps 2 and 3 to set the hour.

The hour is set and the minutes digits flash on the display.

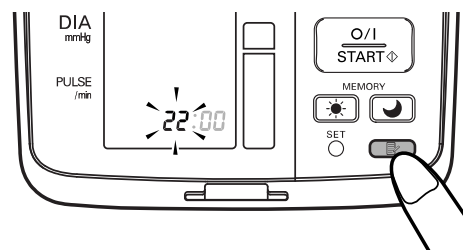

- 7.** Repeat steps 2 and 3 to set the minutes.

The minutes settings is set.

The unit automatically turns itself off after the minute setting has been set.

To adjust the date and time, press and hold the SET button while the unit is turned off.

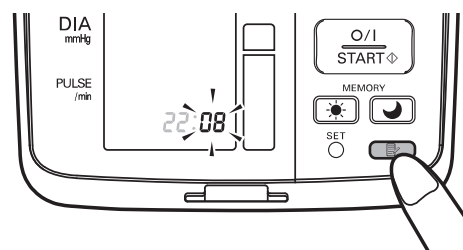

## Notes on Adjusting the Date and Time Setting

If you need to adjust the date and time for some reason, or if the date and time has been reset after replacing the batteries, adjust the date and time between 10:00 and 18:59. This will avoid problems with morning and evening weekly averages stored in memory.

To adjust the date or time at a later stage, start the unit in the off position. Follow the steps below.

- 
1. Press and hold the SET button.

The auto mode symbol  and the current setting (**on** or **oFF**) will appear on the display for the user ID selected.

If the year is not flashing, press the SET button once or twice until the year is flashing.

The year flashes on the display.

- 
2. Refer to Chapter 2.2.2 to start setting the date and time.

With this manual setting of date and time the unit needs to be manually shut off. It will not automatically turn off after the minutes have been set.

**Notes:**

- Please ensure that the date and time have been set correctly so that the weekly averages will be displayed correctly. If the Date/Time settings have been accidentally set incorrectly, press the SET button to circle through the settings in order to adjust to their correct values.
- In the case where the time displays incorrectly after a long period of non-use of the unit, reset the Date and Time (refer to Chapter 2.2 for instructions on setting the clock values). Erase the recorded values when reusing the unit (refer to Chapter 3.5 for directions on erasing the recorded values).

## 3. Using the Unit

### 3.1 How to Sit Correctly When Taking a Measurement

You can take a measurement on either your left or right arm.

#### Notes:

- Measurements should be taken in a quiet place and you should be in a relaxed, seated position. Make sure that the room is not too hot or cold.
- Avoid eating, smoking, or exercising for at least 30 minutes before taking a measurement.
- Do not move or talk during measurement.

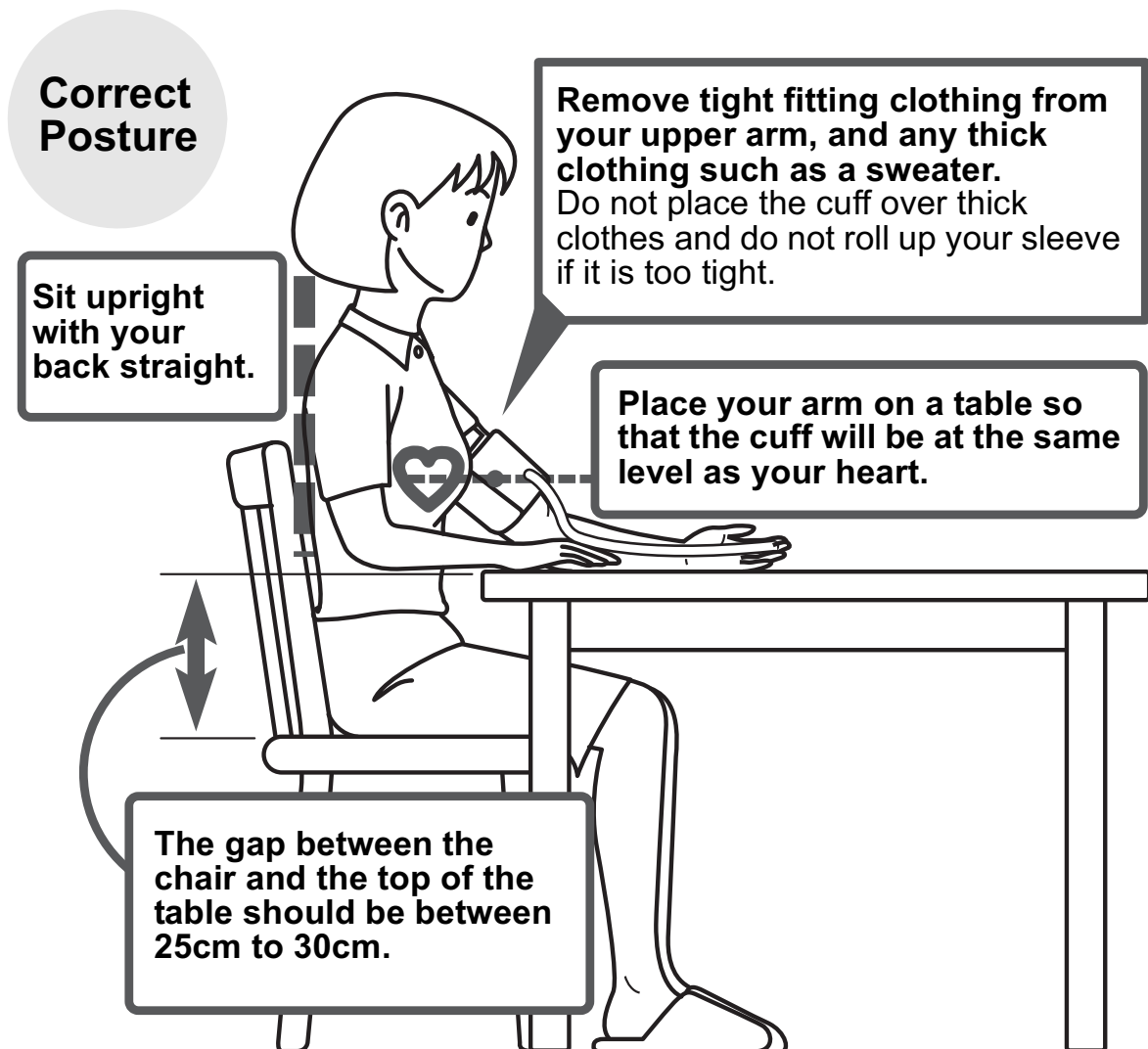



**Notes:**

- Correct posture during measurement is necessary to get accurate results.
- You should also try to measure your blood pressure at the same time each day. (Within 1 hour after waking up is recommended.)

**Incorrect Posture**

- **Arched back (leaning forwards)**
- **Sitting cross-legged**
- **Sitting on a sofa or at a low table so that you tend to lean forward**



These situations could lead to higher blood pressure values due to strain or the arm cuff being lower than the heart.

If the arm cuff is at a lower position than your heart use cushions etc., to adjust the height of your arm.

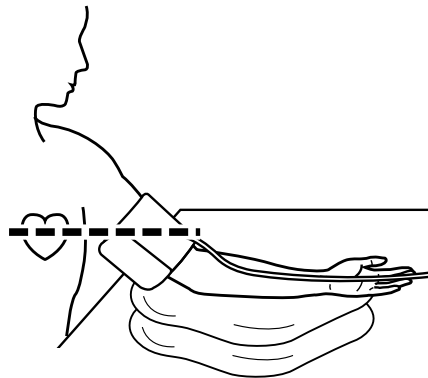

## 3.2 Applying the Arm Cuff

You can wrap the cuff either on your right or left arm.

- Remove tight-fitting clothing from your upper arm.
- Do not place the cuff over thick clothes and do not roll up your sleeve if it is too tight.

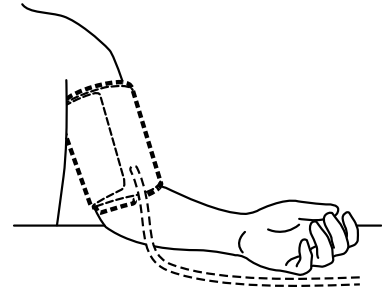

### Taking Measurements on the Left Arm

1. Insert the air plug into the air jack (inside the Cuff Compartment of the device).

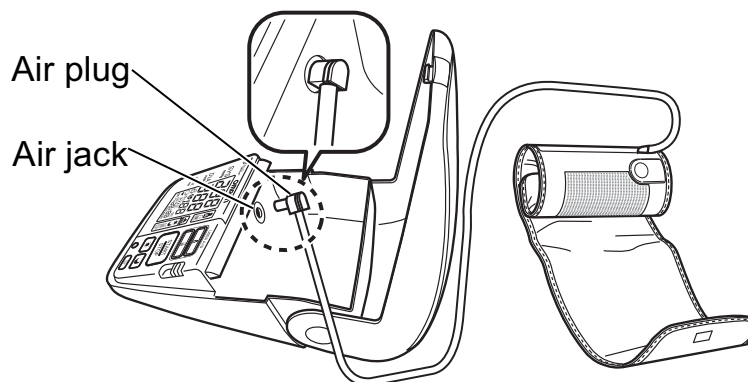

The cuff must be fully deflated when it is inserted into the air jack.

2. Sit on a chair with your feet flat on the floor and place your arm on a table so that the cuff will be at the same level as your heart.

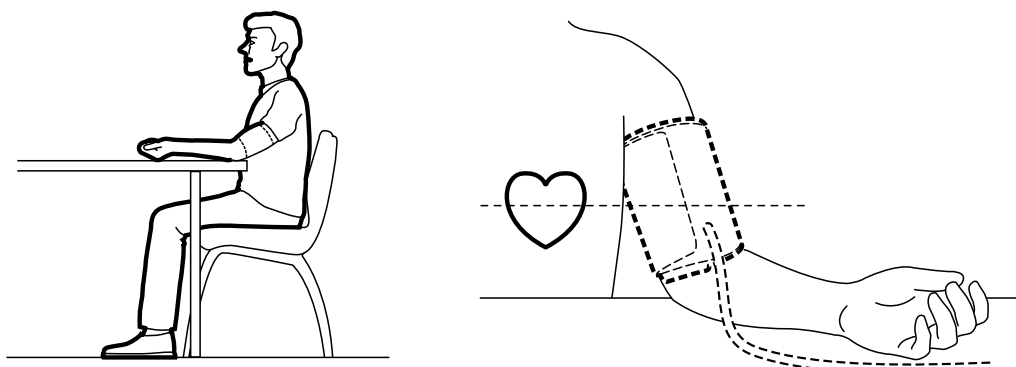

- 3.** Hold the grip on the cuff securely with your hand.

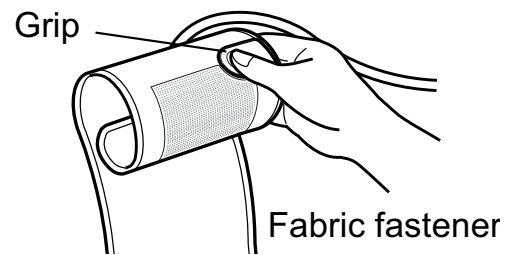

- 4.** Turn the palm of your hand upward.

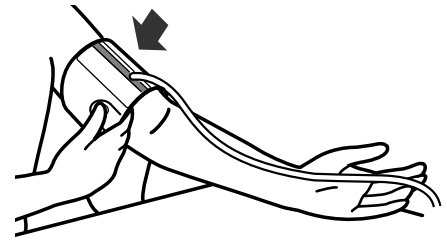

- 5.** Apply the cuff to your upper arm so that the blue strip is centred on the middle of your inner arm and points down the inside of the arm. The air tube should run down the inside of your forearm and be in line with your middle finger.

The bottom of the cuff should be approximately 1 to 2 cm above the elbow.

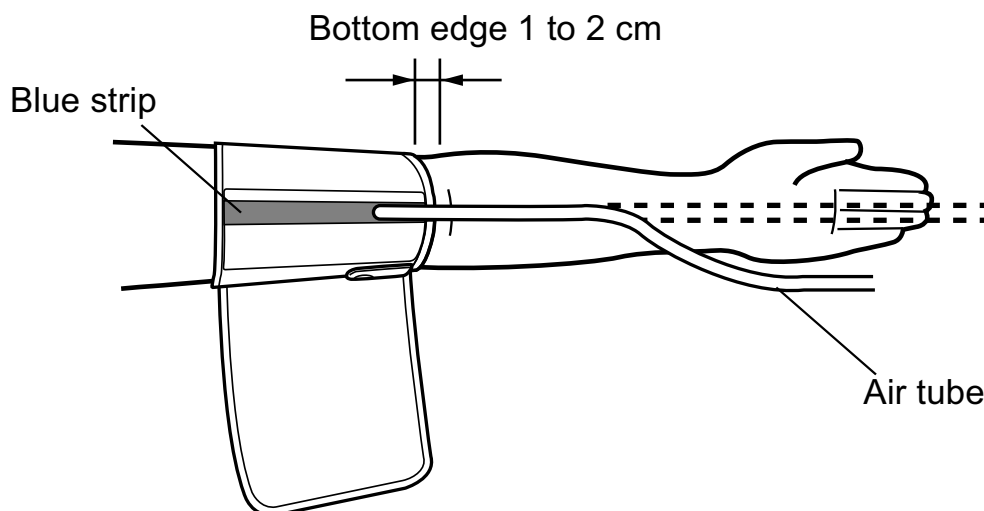

- 6.** When the cuff is positioned correctly, close the fabric fastener **FIRMLY**.

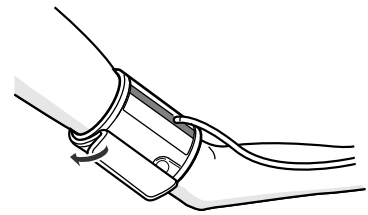

**Notes:**

- Make certain the cuff fits snugly around your arm.
- The cuff should make good contact with your skin. You should be able to fit your index finger between the cuff and your arm easily, so you can pull the cuff off and on.
- Make sure that there are no kinks in the air tubing.

## Taking Measurements on the Right Arm

Please note the following points when applying the cuff to your right arm. Apply the cuff so that the air tube is at the side of your elbow.

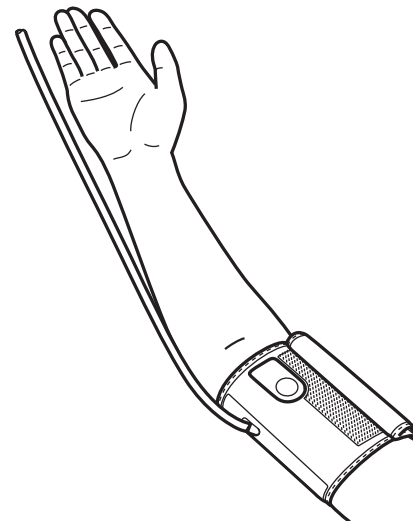

**Notes:**

- Be careful not to rest your arm on the air tube, or otherwise restrict the flow of air to the cuff.
- Apply the arm cuff so that no part of the cuff is positioned over the elbow joint. The cuff should be 1 to 2 cm above the elbow.
- If used 2 times per day, the cuff will last for 3 years.
- The blood pressure can differ between the right arm and the left arm, and therefore also the measured blood pressure values can be different. Omron recommends to always use the same arm for measurement. If the values between the two arms differ substantially, please check with your physician which arm to use for your measurement.

### 3.3 Taking a Reading

The unit is designed to take measurements and store the measurement values in the memory for two people using user ID A and user ID B.

The unit can also be used to take a single measurement for other persons using the guest mode. The user ID symbol is not displayed when using the guest mode. Measurements taken using the guest mode are not stored in the memory.

#### Using the Guest Mode

1. Press and hold the O/I START button until the A and B user symbols disappear from the display.

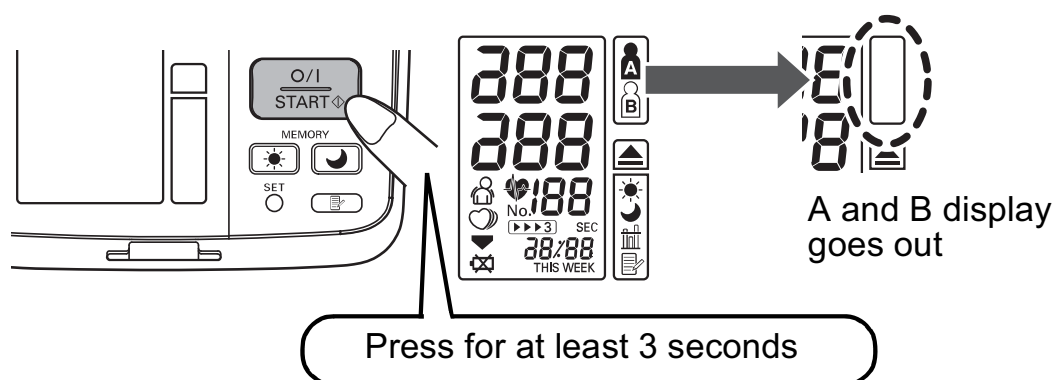

2. Release the O/I START button.

The cuff starts to inflate automatically.

**Note:** To stop the inflation press and release the O/I START button. The unit will stop inflating, start deflation and turn off.

3. Inflation stops and the measurement is started. When the measurement is completed, your blood pressure and pulse rate appear on the display.

## Selecting the User ID

Select your user ID. Always use the same user ID when taking a measurement. The unit stores the measurement values in the memory by the user ID selected. These measurement values are used to calculate the morning averages and evening averages.

Slide the user ID selection switch up or down to select user A or B.

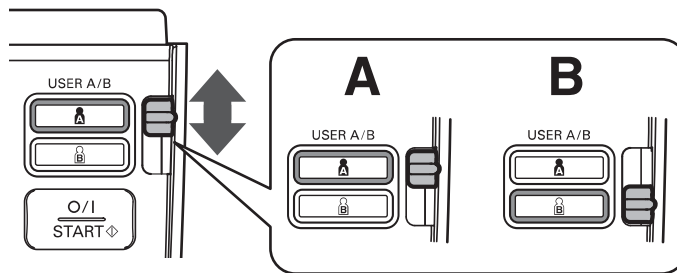

## Using the User ID

When you select a user ID the unit can be set to take one measurement using the single mode or three consecutive measurements using the auto mode when you press the O/I START button.

**Note:** The default value is set to the single mode to take one measurement.

The auto mode takes three consecutive measurements. The unit will inflate the cuff and take three measurements separated by a short interval of time between each measurement.

## Using the Single Mode

1. Select your user ID (A or B).

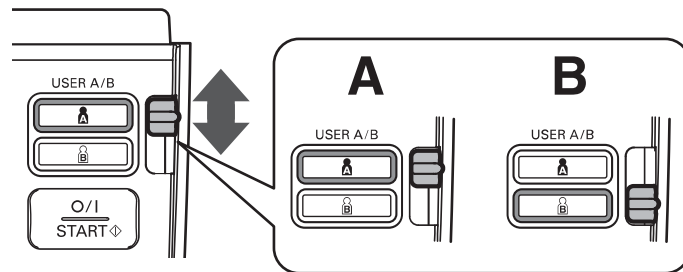

2. Press the O/I START button.

All symbols appear on the display. The user ID symbol you selected flashes on the display.

The cuff starts to inflate automatically. As the cuff inflates, the unit automatically determines your ideal inflation level. This unit detects the pulse during inflation. Do not move your arm and remain still until the entire measurement process is completed.

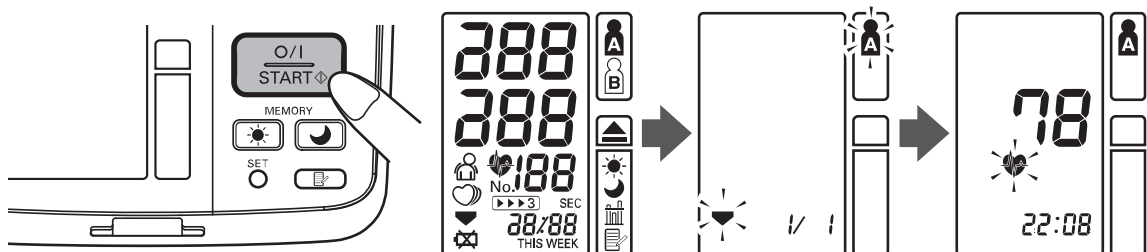

**Note:** To stop the inflation or measurement, press and release the O/I START button. The unit will stop inflating, start deflating and will turn off.

**3.** Inflation stops automatically and the measurement is started.

As the cuff deflates, decreasing numbers appear on the display. The heartbeat symbol (  ) flashes at every heartbeat.

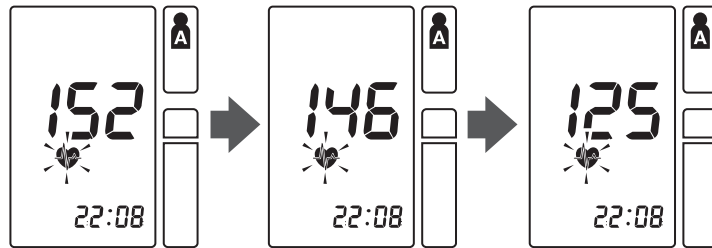

**4.** When the measurement is complete, the arm cuff completely deflates. Your blood pressure and pulse rate are displayed.

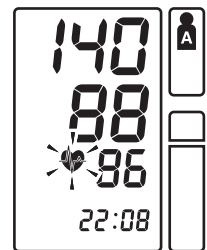

**5.** Press the O/I START button to turn the unit off.

**Note:** If you forget to turn the monitor off, it will automatically turn off after five minutes.

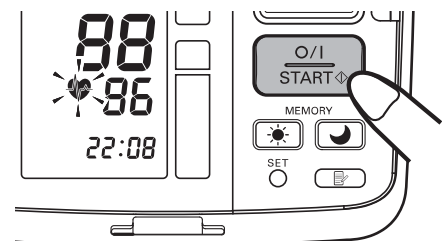

**Notes:**

- Self-diagnosis of measured results and treatment are dangerous. Please follow the instructions of your doctor.
- Wait 2-3 minutes before taking another blood pressure measurement. Waiting between readings allows the arteries to return to the condition prior to taking the blood pressure measurement.



## Selecting the Auto Mode

Auto Mode may be selected for either A or B user.

1. Make sure the unit is powered off.
2. Select your user ID (A or B).

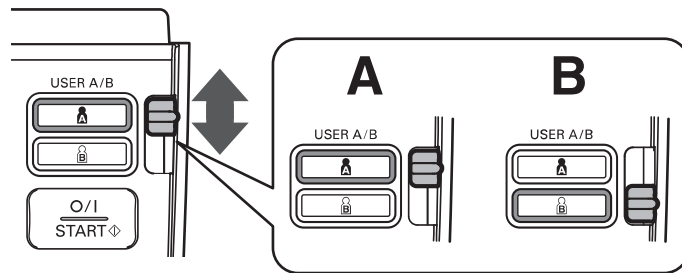

3. Press and hold the SET button.

The auto mode symbol (▶▶▶3) and the **oFF** setting appears on the display.

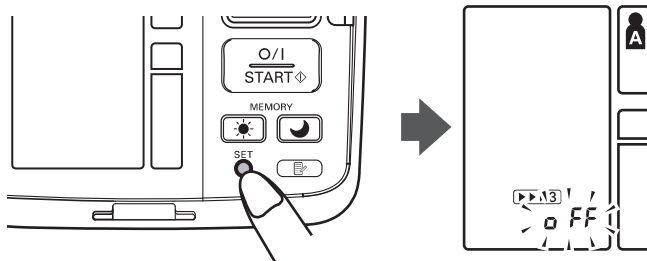

4. Press the MEMORY button (📄) to select **on**.

**Note:** Press the MEMORY button (📄) to alternate between **on** and **oFF**.

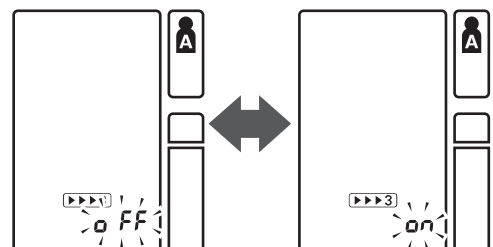

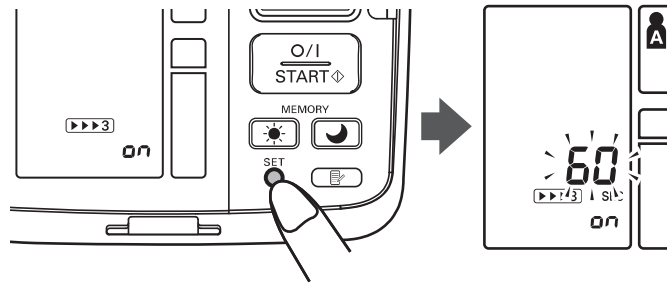

- 
5. Press the SET button to confirm the change.



The number of seconds between each measurement is displayed.

**Note:** The default value between each measurement is 60 seconds.

- 
6. Press the MEMORY button (  ) to change the interval of time between each measurement.

The interval can be set to 15 seconds, 30 seconds, 60 seconds or 120 seconds. Continue to press the MEMORY button (  ) until the desired interval appears on the display.

- 
7. Press the SET button to confirm the setting.

The year flashes on the display.

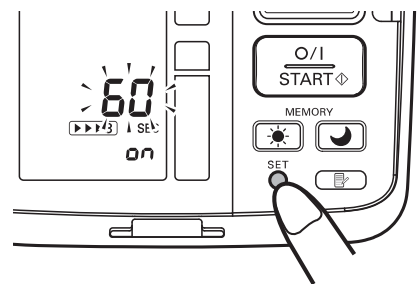

- 
8. Press the O/I START button to turn the unit off.

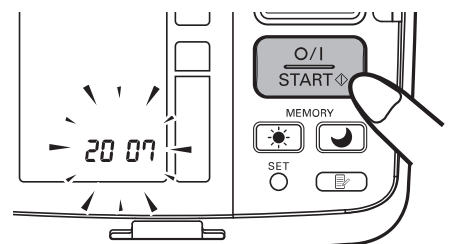

## Using the Auto Mode

1. Select your user ID (A or B).

2. Press the O/I START button.

All symbols appear on the display. The user ID Symbol you selected flashes on the display. The cuff starts to inflate automatically.

**Note:** To stop the inflation or measurement, press the O/I START button. The unit will stop inflating, start deflating and will turn off.

3. Inflation stops automatically and the measurement is started.

As the cuff deflates, decreasing numbers appear on the display. The heartbeat symbol (  ) flashes at every heartbeat. When the measurement is complete, the arm cuff completely deflates.

**Note:** Do not move your arm and remain still until the entire measurement process is completed.

4. Check the progress of the consecutive measurements.

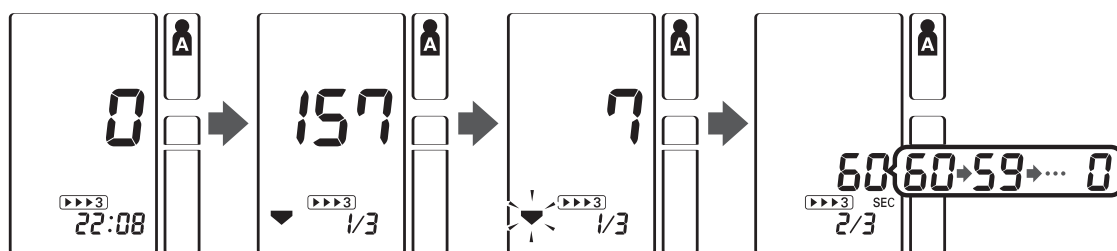

The first measurement is complete, waiting to start the next measurement. The interval of time set between each measurement will appear on the display.

The second measurement starts automatically.

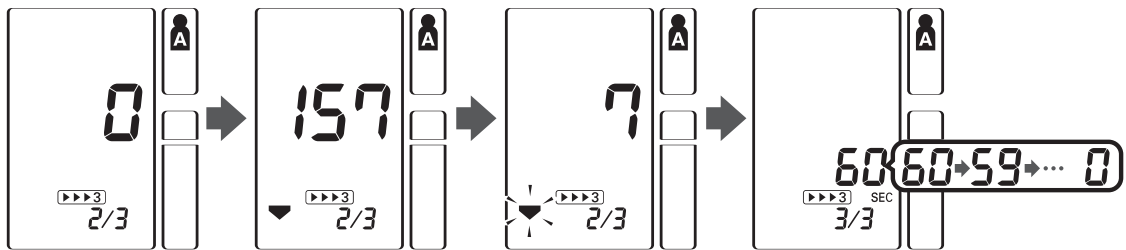

The second measurement is complete, waiting to start the next measurement.

The third measurement starts automatically.

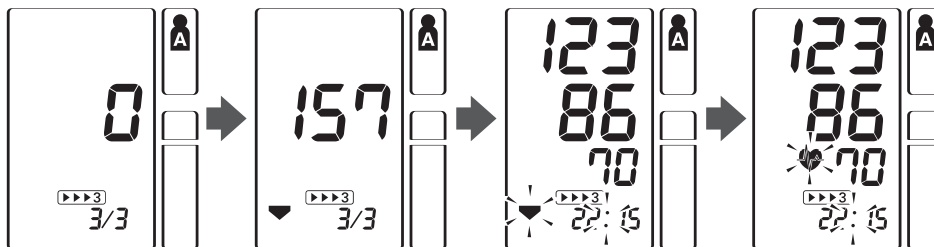

The consecutive measurements are complete. The average for the three measurements appears on the display.

The three individual measurement results are not displayed while Auto Mode is taking the measurements. However, the results for each individual measurement can be displayed after all the measurements have been completed.

**Note:** During the Auto Mode the unit will repeat the measurement in case of an error. After 3 errors the unit will stop taking further measurements. If only two measurements are successful the average of these two measurements will be displayed. If only one measurement is successful, this result will be displayed.

5. Press the SET button to display the blood pressure and pulse rate for the first measurement. Press the SET button again to display the next measurement.
6. Press the O/I START button to turn the unit off.

**Important:**

- If your systolic or diastolic pressure is outside the standard range, the heartbeat symbol will blink when the measurement result is displayed.

Recent research suggests that the following values can be used as a guide to high blood pressure for measurements taken at home.

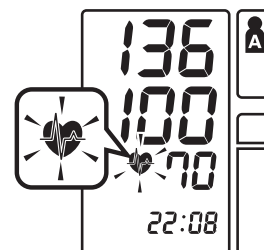

Systolic Blood Pressure	Above 135 mmHg
Diastolic Blood Pressure	Above 85 mmHg

This criteria is for home blood pressure measurement.

For professional office blood pressure measurement criteria, please refer to Chapter 9.

- Your blood pressure monitor includes an irregular heartbeat feature. Irregular heartbeats can influence the results of the measurement. The irregular heartbeat algorithm automatically determines if the measurement is usable or needs to be repeated. If the measurement results are affected by irregular heartbeats but the result is valid, the result is shown together with the irregular heartbeat icon. If the irregular heartbeats cause the measurement to be invalid, no result is shown. If the irregular heartbeat symbol (  ) is shown after you have taken a measurement, repeat the measurement. If the irregular heartbeat icon is shown frequently, please make your doctor aware of it.

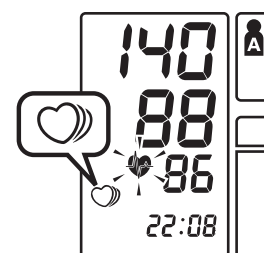

### What is Irregular Heartbeat?

An irregular heartbeat is a heartbeat rhythm that varies by more than 25% from the average heartbeat rhythm detected while the unit is measuring the systolic and diastolic blood pressure.

If such an irregular rhythm is detected more than twice during measurement, the irregular heartbeat symbol (  ) appears on the symbol when the measurement results are displayed.

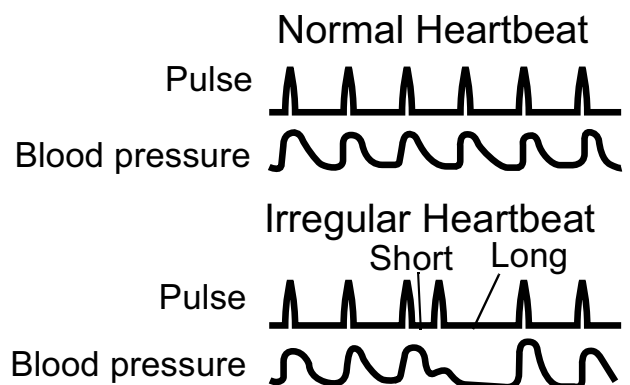

### What is Arrhythmia?

A heartbeat is stimulated by electrical signals that cause the heart to contract.

Arrhythmia is a condition where the heartbeat rhythm is abnormal due to flaws in the bio-electrical system that drives the heartbeat. Typical symptoms are skipped heartbeats, premature contraction, an abnormally rapid (tachycardia) or slow (bradycardia) pulse. This can be caused by heart disease, aging, physical predisposition, stress, lack of sleep, fatigue etc. Arrhythmia can only be diagnosed by a doctor through a special examination.

Whether the appearance of the irregular heartbeat symbol (  ) in the results indicates arrhythmia or not can only be determined by an examination and diagnosis by your doctor.

If the irregular heartbeat symbol (  ) is shown frequently, please make your doctor aware of it. Conducting self-diagnosis and treatment based on measurement results is dangerous. Be sure to follow the instructions of your doctor.

## 3.4 Instructions for Special Conditions

If your systolic pressure is known to be more than 220 mmHg, press and hold the O/I START button until the arm cuff inflates 30 to 40 mmHg higher than your suspected systolic pressure.

1. Press the O/I START button to turn the unit on.

Measurement starts.

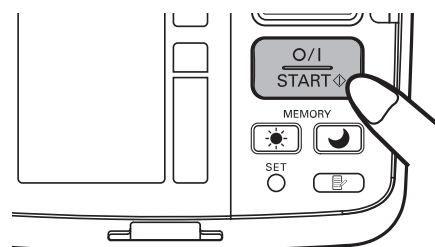

2. When the cuff starts to inflate, press the O/I START button and keep it pressed until the pressure is 30 to 40 mmHg higher than your suspected systolic pressure.

**Note:** You cannot inflate the cuff above 299 mmHg. (An error will be displayed if you try to inflate the cuff above 300 mmHg.)

3. Release the O/I START button when the cuff has been inflated to the desired pressure.

The cuff starts to deflate and measurement starts.

4. The rest of the procedure is the same as for normal measurement. Refer to Chapter 3.3.

**Note:** Do not apply more pressure than necessary.

## 3.5 Using the Memory Function

The unit is designed to store the blood pressure and the pulse rate in the memory for two people (user A and user B) every time a measurement is completed.

The unit automatically stores up to 84 sets of measurement values (blood pressure and pulse rate) for each user (A and B). When 84 sets of measurement values are stored, the oldest record is deleted to save the most recent values. The unit also stores 8 weeks of morning averages and 8 weeks of evening averages for each user (A and B).



### Average Function

The unit calculates the average reading based on the three most recent sets of measurement values taken within 10 minutes of the most recent reading.

**Note:** If two sets of measurement values are stored in the memory for the 10 minutes period, the average is based on the two sets of measurement values. If one set of measurement values is stored, this is displayed as the average.

### To Display the Measurement Values

1. Select your user ID (A or B).
2. Press the MEMORY button (  ).

The average value is shown and the average symbol (  ) appears above the memory symbol (  ) on the display.

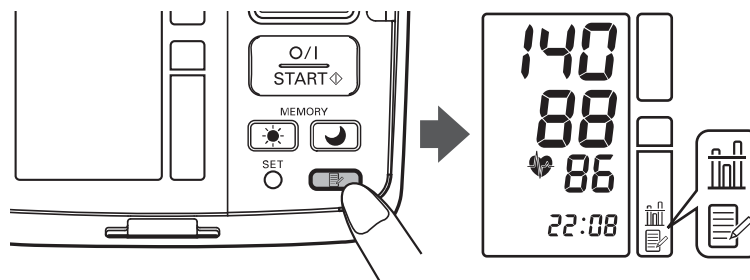



3. Press the MEMORY button (  ) to display the most recent set of individual measurement values on the screen. The values are displayed from the most recent to the oldest.

**Note:** The date and time are alternately displayed with the measurement values.

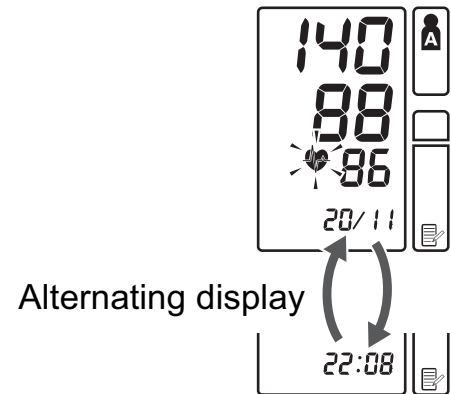

Press the MEMORY button (  ) to display the next set of values.

Press and hold the MEMORY button (  ) to display the values faster.

### **Auto mode**

The average for the consecutive measurements appears on the display with the auto mode symbol (  ). To display the values for the individual measurements press the SET button while the average is displayed.

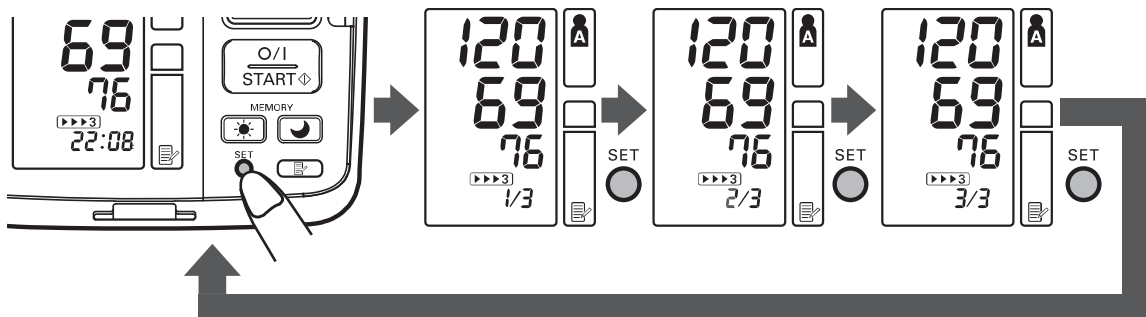

4. Press the O/I START button to turn the unit off.

## Morning and Evening Averages

The unit calculates and displays a weekly average for measurements taken in the morning (☀) and evening (☾). The unit stores 8 weeks of morning averages and 8 weeks of evening averages for each user (A and B).

**Note:** The week begins Sunday at 4:00.

### Morning Averages

Morning averages are based on the first average reading using the auto mode or the first reading using the single mode.

Measurement times must be between:

**4:00 and 9:59**

### Evening Averages

Evening averages are based on the last average reading using the auto mode or the last reading using the single mode.

Measurement times must be between:

**19:00 and 1:59**

## About the Weekly Averages

### Morning Weekly Average

This is the average for measurements taken during the morning (4:00-9:59) between Sunday and Saturday. An average for each day is calculated for up to three measurements taken within 10 minutes of the first measurement of the morning.

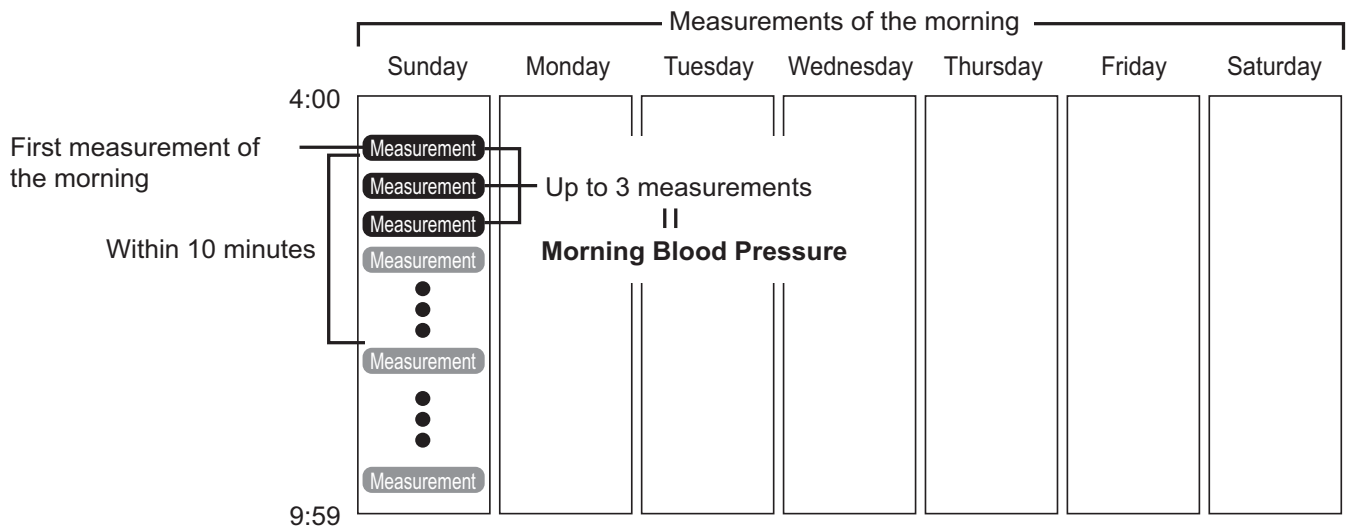

### Evening Weekly Average

This is the average for measurements taken during the evening (19:00-1:59) between Sunday and Saturday. An average for each day is calculated for up to three measurements taken within 10 minutes of the last measurement of the evening.

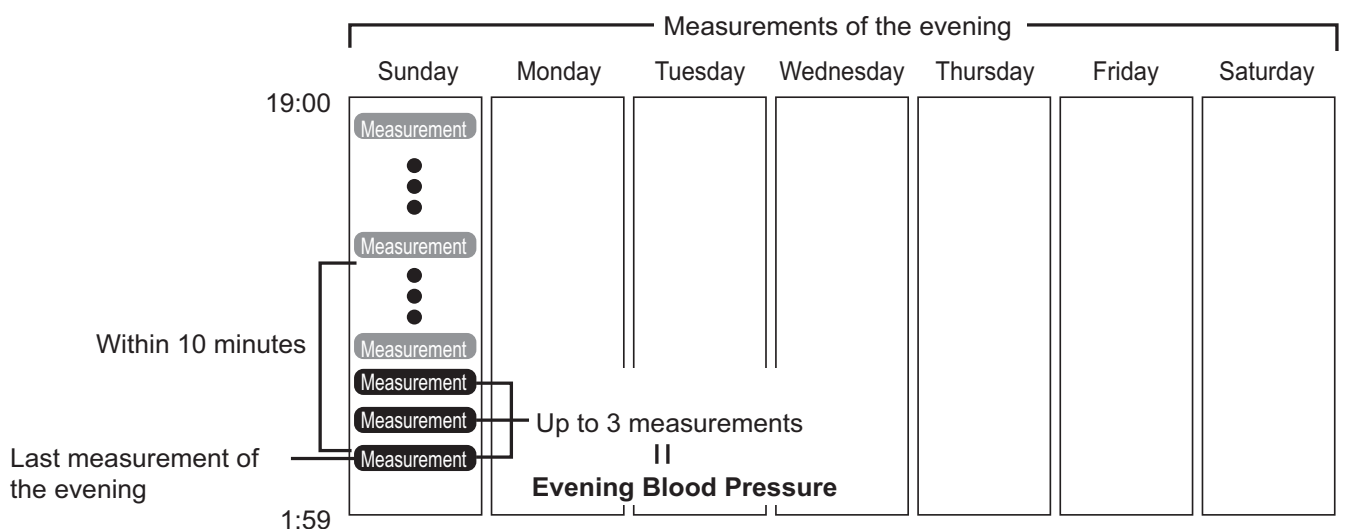

## To Display Morning and Evening Averages

---

1. Select your user ID (A or B).

---

2. Press the morning average button (☀️) or the evening average button (🌙).

The average for the current week “THIS WEEK” appears on the display.

The morning and evening average value of the same week can be displayed by pressing the morning average button (☀️) or the evening average button (🌙). It is important to check both morning and evening average of the same week.

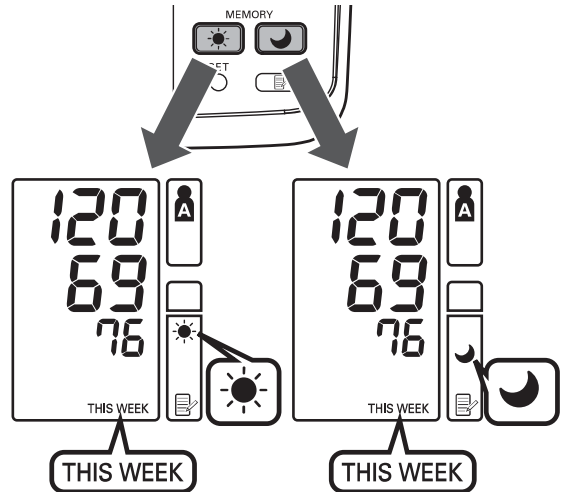

---

3. Continue to press the morning average button (☀️) or the evening average button (🌙) to display the previous weeks. The unit displays “-1 WEEK” for the previous week to “-7 WEEK” for the oldest set of averages.

**Note:** If there are not enough measurements taken in a week to calculate the average the display will appear as illustrated.

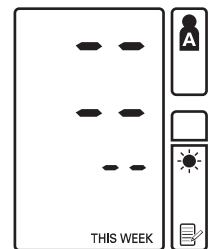

---

4. Press the O/I START button to turn the unit off.

## Notes on Display Combinations

In addition to the morning average and evening average symbols, the unit may also display the morning hypertension symbol if the morning average for that week is above the home blood pressure guideline. (See Chapter 3 “Using the Unit - Important information” for details.) Depending on your measurement results, these may be displayed in the following combinations.

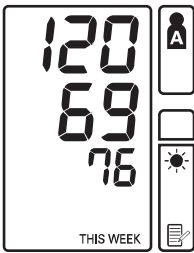
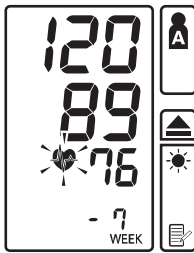
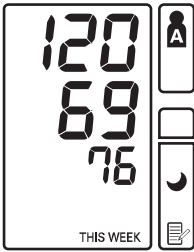
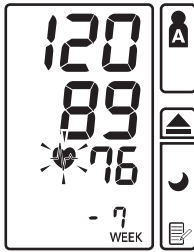
	Display	
<b>Morning Average</b>	 <p>Morning average from This Week with Morning Average Symbol</p>	 <p>Morning average from 7 weeks ago with Morning Average Symbol + blinking heartbeat Symbol + Morning Hypertension Symbol</p>
<b>Evening average</b>	 <p>Evening average from This Week with Evening Average Symbol</p>	 <p>Evening average from 7 weeks ago with Evening Average Symbol + blinking Heartbeat Symbol + Morning Hypertension Symbol</p>
	<b>Average within home blood pressure guideline</b>	<b>Average above home blood pressure guideline + Morning Hypertension</b>

The morning hypertension symbol (▲) appears if the weekly average for morning measurements is above 135/85.

In this case the morning hypertension symbol (▲) is displayed when the evening average is displayed, regardless of the values for the evening average.

## To Delete All Values Stored in the Memory

The values stored in the memory are deleted by user ID.

You cannot partially delete values stored in the memory. All values for the user you select will be deleted.

1. Select your ID (A or B).
2. While holding the MEMORY button (  ) press the O/I START button simultaneously for more than 2 seconds and all values will be deleted.

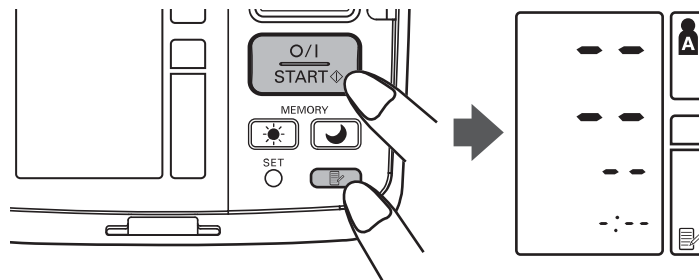

## 4. Quick Reference Guide

This Quick Reference Guide is for reference only. Please read the entire manual before using the unit for the first time.

To help ensure a reliable reading, avoid eating, smoking, or exercising for at least 30 minutes before taking a measurement.

**Note:** Remove any tight-fitting clothing from your upper arm.

1. Sit on a chair with your feet flat on the floor and place your arm on a table so that the arm cuff will be at the same level as your heart.

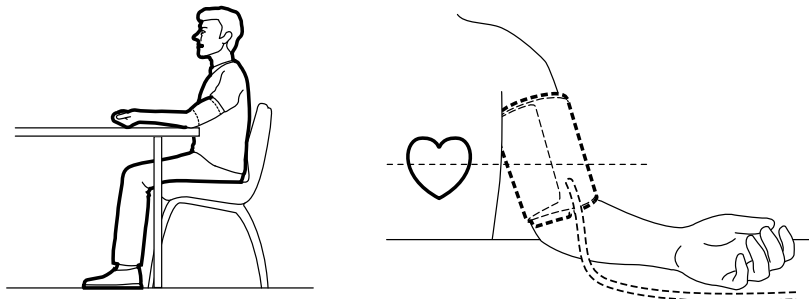

2. Secure the cuff around your arm using the fabric fastener strip.

3. Select your user ID (A or B).

4. Press the O/I START button.

When measurement is complete, the unit displays your blood pressure and pulse rate, and automatically deflates the cuff.

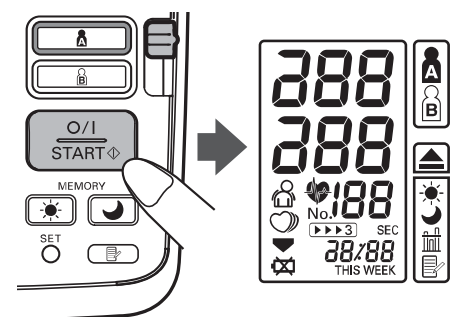



### Notes:

- Always wait at least 2-3 minutes before taking another blood pressure measurement.
- Please note that all measurement results are stored in the memory. If different people take measurements using the same device, make sure that you are aware of this fact.

## 5. Handling Errors and Problems

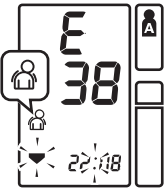
### 5.1 Error Messages

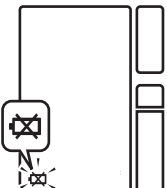
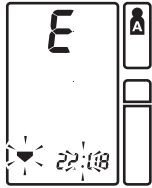
Error Display	Cause	Remedy
	Cuff is under inflated.	Carefully read and repeat the steps listed under Chapter 3.3.
	Movement during measurement.	
	Cuff over inflated.	
 Blinks or appears continuously.	Batteries have run down.	Replace all four "AA" batteries with new ones. Refer to Chapter 2.1.
	Movement, sound.	Carefully read and repeat the steps listed under Chapter 3.3.
	Cuff leaks air.	Replace with a new cuff.



## 5.2 Troubleshooting

Problem	Cause	Remedy
No display appears when the O/I START button is pressed.	The batteries are empty.	Replace the batteries.
Cannot measure or readings are too high.	Is the cuff wrapped correctly around the arm?	Attach the arm cuff correctly.
	The cuff pressure does not rise although the pump motor can be heard.	Check that the air plug is properly connected to the unit. Push the air plug firmly into the air jack.
The blood pressure is different each time. The reading is extremely low (or high).	Blood pressure readings constantly vary with time of measurement and nervous condition. Take deep breaths to relax before taking a measurement.	

## 6. Maintenance and Storage

To protect your unit from damage, please observe the following:

- Do not subject your unit and cuff to extreme temperatures, humidity, moisture or direct sunlight.
- Do not fold the cuff or tubing tightly.
- Do not disassemble the unit.
- Do not carry out repairs of any kind yourself. If a defect occurs, consult the OMRON distributor or Customer Services as mentioned on the packaging, or seek the advice of your surgical appliance stockist or pharmacist.
- The OMRON i-C10 is a precision measuring device. It is important that the accuracy remains within the specifications. It is recommended that you have the unit inspected every two years to ensure it is accurate and functioning correctly. Consult the OMRON distributor or Customer Services as mentioned on the packaging for further details.
- Do not subject the unit to strong shocks or vibrations (for example, dropping the unit on the floor.)
- Do not use volatile liquids to clean the unit. **THE UNIT SHOULD BE CLEANED WITH A SOFT, DRY CLOTH.**
- Do not wash the arm cuff or immerse it in water.
- Use a soft, moistened cloth and soap to clean the arm cuff.

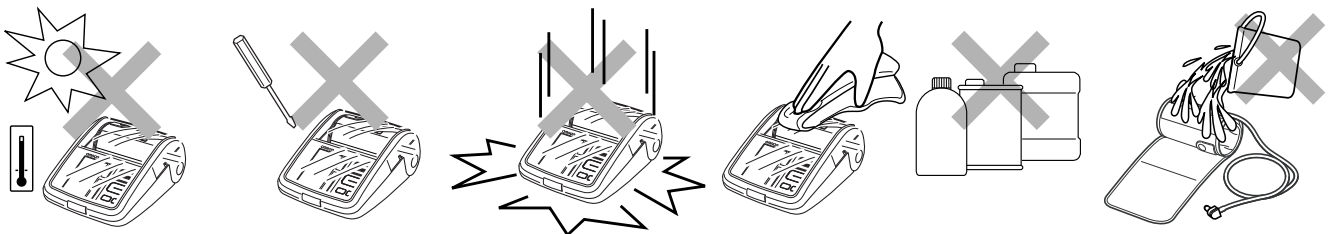

### Storage

Close the monitor cover when not in use.

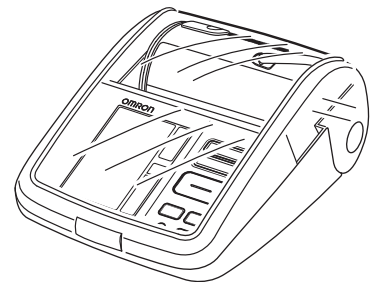

## 7. Optional Parts

AC Adapter "R"

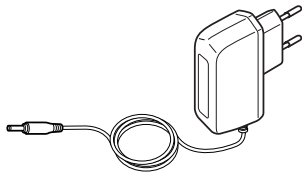

R Adapter-9997605-0

AC Adapter "Q"

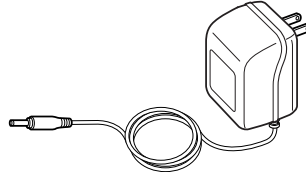

Q Adapter-1098336-8

Arm Cuff

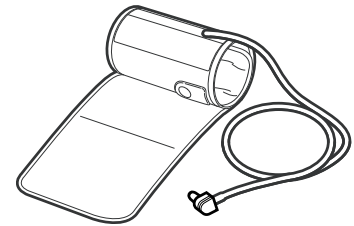

Order No. 9956685-4

### Using the Optional AC Adapter

Insert batteries into the battery compartment even when using the AC adapter.

#### Notes:

- Never plug in or unplug the power cord from the electric outlet with wet hands.
- Use only the original AC adapter designed for this unit. Use of unsupported adapters may damage the unit.
- When storing the AC adapter with the main unit, be careful not to damage the main unit or cuff.

1. Insert the AC adapter plug into the AC adapter jack on the left side of the main unit.

2. Plug the AC adapter into an electrical outlet.

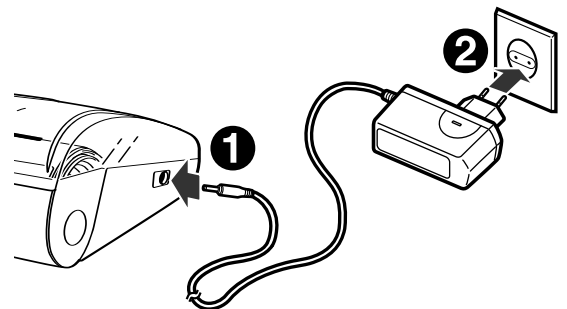

EN

To disconnect the AC adapter, unplug the AC adapter from the electrical outlet first and then immediately remove the AC adapter plug from the main unit.

## 8. Technical Data

<b>Product Description</b>	Digital Automatic Blood Pressure Monitor
<b>Model</b>	OMRON i-C10 (HEM-7070-E)
<b>Display</b>	LCD Digital Display
<b>Measurement Method</b>	Oscillometric method
<b>Measurement Range</b>	Pressure: 0 mmHg to 299 mmHg Pulse: 40 to 180/min.
<b>Accuracy</b>	Pressure: $\pm 3$ mmHg Pulse: $\pm 5\%$ of display reading
<b>Inflation</b>	Fuzzy-logic controlled by electric pump
<b>Deflation</b>	Automatic pressure release valve
<b>Pressure Detection</b>	Capacitive pressure sensor
<b>Memory</b>	84 Measurements with date and time for each user (A and B)
<b>Power Source</b>	4 "AA" batteries 1.5V or AC/ DC adapter (6V = 4W)
<b>Battery Life</b>	Capacity of new alkaline batteries is approx. 1400 measurements when used 6 times a day with 4 new alkaline batteries
<b>Operating temperature/ Humidity</b>	+10°C to +40°C Maximum: 30 to 90% RH
<b>Storage temperature/ Humidity/Air Pressure</b>	-20°C to +60°C Maximum: 10 to 95% RH 700 - 1060 hPa
<b>Console Weight</b>	Approximately 960g without batteries
<b>Cuff Weight</b>	Approximately 240g
<b>Outer Dimensions</b>	Approximately 249 (l) mm $\times$ 178 (w) mm $\times$ 110 (h) mm
<b>Cuff Dimensions</b>	Approximately 152 mm $\times$ 600 mm (Cuff: arm circumference 22 to 42 cm)
<b>Package Content</b>	Cuff, instruction manual, battery set, guarantee card, blood pressure pass

**Note:** Subject to technical modification without prior notice.



= Type B

CE 0197

- This device fulfils the provisions of EC directive 93/42/EEC (Medical Device Directive).
- This blood pressure monitor is designed according to the European Standard EN1060, Non-invasive sphygmomanometers Part 1: General Requirements and Part 3: Supplementary requirements for electromechanical blood pressure measuring systems.
- This OMRON product is produced under the strict quality system of OMRON Healthcare Co. Ltd., Japan. The Core component for OMRON blood pressure monitors, which is the Pressure Sensor, is produced in Japan for assembly.

### Important information regarding Electro Magnetic Compatibility (EMC)

With the increased number of electronic devices such as PC's and mobile (cellular) telephones, medical devices in use may be susceptible to electromagnetic interference from other devices. Electromagnetic interference may result in incorrect operation of the medical device and create a potentially unsafe situation. Medical devices should also not interfere with other devices.

In order to regulate the requirements for EMC (Electro Magnetic Compatibility) with the aim to prevent unsafe product situations, the EN60601-1-2 standard has been implemented. This standard defines the levels of immunity to electromagnetic interferences as well as maximum levels of electromagnetic emissions for medical devices.

This medical device manufactured by OMRON Healthcare conforms to this EN60601-1-2:2001 standard for both immunity and emissions.

Nevertheless, special precautions need to be observed:

- Do not use mobile (cellular) telephones and other devices, which generate strong electrical or electromagnetic fields, near the medical device. This may result in incorrect operation of the unit and create a potentially unsafe situation. Recommendation is to keep a minimum distance of 7 m. Verify correct operation of the device in case the distance is shorter.

Further documentation in accordance with EN60601-1-2:2001 is available at OMRON Healthcare Europe at the address mentioned in this instruction manual. Documentation is also available at [www.omron-healthcare.com](http://www.omron-healthcare.com).

### Correct Disposal of This Product (Waste Electrical & Electronic Equipment)

This marking shown on the product or its literature, indicates that it should not be disposed of, with other household wastes at the end of its working life. To prevent possible harm to the environment or human health from uncontrolled waste disposal, please separate this from other types of wastes and recycle it responsibly to promote the sustainable reuse of material resources.



Household users should contact either the retailer where they purchased this product, or their local government office, for details of where and how they can take this item for environmentally safe recycling.

Business users should contact their supplier and check the terms and conditions of the purchase contract. This product should not be mixed with other commercial wastes for disposal.

This product does not contain any hazardous substances.

## 9. Some Useful Information about Blood Pressure

### What is Blood Pressure?

Blood pressure is a measure of the force of blood flowing against the walls of the arteries. Arterial blood pressure is constantly changing during the course of the heart's cycle.

The highest pressure in the cycle is called the *Systolic Blood Pressure*; the lowest is the *Diastolic Blood Pressure*.

Both pressure readings, the *Systolic* and *Diastolic*, are necessary to enable a doctor to evaluate the status of a patient's blood pressure.

### Why is it a Good Thing to Measure Blood Pressure at Home?

Having your blood pressure measured by a doctor can cause anxiety which is itself a cause of high blood pressure. As a variety of conditions affect blood pressure, a single measurement may not be sufficient for an accurate diagnosis.

Many factors such as physical activity, anxiety, or the time of day, can influence your blood pressure. Thus it is best to try and measure your blood pressure at the same time each day, to get an accurate indication of any changes in blood pressure. Blood pressure is typically low in the morning and increases from afternoon to evening. It is lower in the summer and higher in the winter.

Blood pressure is measured in millimetres of mercury (mmHg) and measurements are written with the systolic pressure before the diastolic e.g. A blood pressure written as 140/90, is referred to as 140 over 90 mmHg.

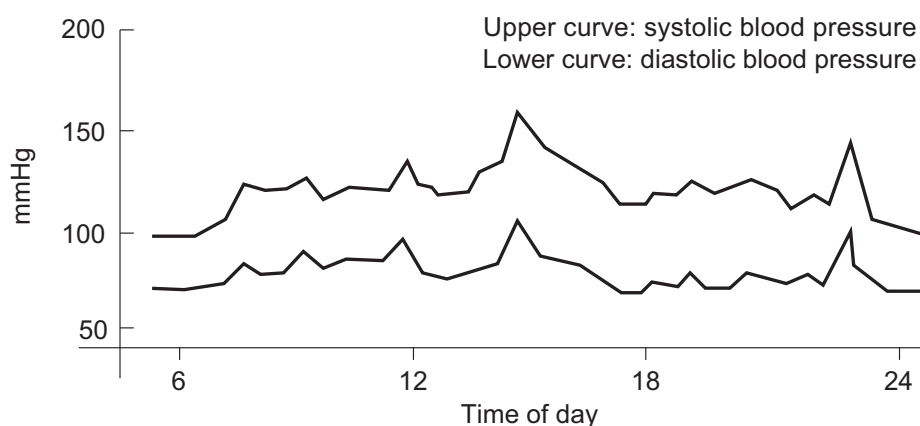

Example: fluctuation within a day (male, 35 years old)

## Classification of Blood Pressure by the World Health Organization

The World Health Organization (WHO) and the International Society of Hypertension (ISH) developed the Blood Pressure Classification shown in this figure.

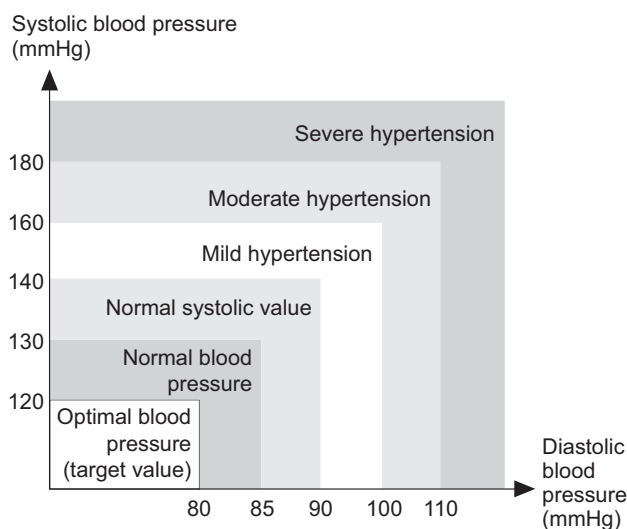

This classification is based on the blood pressure values measured on people in a sitting position in outpatient departments of hospitals.

**Note:** There is no universally accepted definition of hypotension. However, those having the systolic pressure below 100 mmHg are assumed as hypotensive.

## 9. Some Useful Information about Blood Pressure

<b>Manufacturer</b> 	<b>OMRON HEALTHCARE Co., Ltd.</b> 53, Kunotsubo, Terado-cho, Muko, Kyoto, 617-0002 JAPAN		
<b>EU-representative</b> <table border="1" data-bbox="129 517 357 613"> <tr> <td data-bbox="129 517 240 613">EC</td> <td data-bbox="240 517 357 613">REP</td> </tr> </table>	EC	REP	<b>OMRON HEALTHCARE EUROPE B.V.</b> Scorpius 33, 2132 LR Hoofddorp, THE NETHERLANDS <a href="http://www.omron-healthcare.com">www.omron-healthcare.com</a>
EC	REP		
<b>Production facility</b>	<b>OMRON (DALIAN) CO., LTD.</b> Dalian, CHINA		
<b>Subsidiary</b>	<b>OMRON HEALTHCARE UK LTD.</b> Opal Drive, Fox Milne, Milton Keynes, MK15 0DG, U.K.		
	<b>OMRON MEDIZINTECHNIK          HANDELSGESELLSCHAFT mbH</b> John-Deere-Str. 81a, 68163 Mannheim, GERMANY <a href="http://www.omron-medizintechnik.de">www.omron-medizintechnik.de</a>		
	<b>OMRON SANTÉ FRANCE SAS</b> 14, rue de Lisbonne, 93561 Rosny-sous-Bois Cedex, FRANCE		

Made in China