

Isys® Tilt Touchpanels overview

When Crestron introduced the world's first touchpanel-based control system 15 years ago, the AV industry was changed forever. That spirit of innovation has never ceased and today Crestron offers the most advanced and comprehensive line of touchpanels available. Crestron's tilt touchpanel models combine modern styling and cutting-edge technology with the ingenuity and sensibility that only comes with 35+ years of experience.

The **TPS Series** of Isys touchpanels ranges from the compact 6.4" TPS-3000 to the spectacular 17" widescreen TPS-17B. Bright, high-contrast displays and a choice of 16-Bit or 24-Bit graphics and video deliver industry-leading touchpanel performance, while every TPS model represents an incredible value compared to previous and current competitive models. The **TPS-G Series** adds dual-window display of both high-definition video and high-res RGB signals. High-speed Ethernet

is also standard on most models, supporting dynamic graphics, Internet connectivity, and enhanced performance and flexibility as part of any sized control network.

Crestron's ground-breaking **Isys i/O TPMC Touchpanel Media Centers** come in either 15" standard or 17" widescreen sizes, and feature the Windows XP Embedded operating system. This powerful platform enables onboard PC capabilities including Web browsing, streaming media, multimedia presentation, and Voice over IP, while also unleashing a host of immensely useful design features like new Dynamic Menu Objects and support for Yahoo! Widgets.

Whether controlling a single boardroom or home theater, or commanding a large facility full of equipment, Crestron tilt touchpanels can deliver a perfect solution for every control application and budget.

Typical Isys Tilt Touchpanel Application using QuickMedia

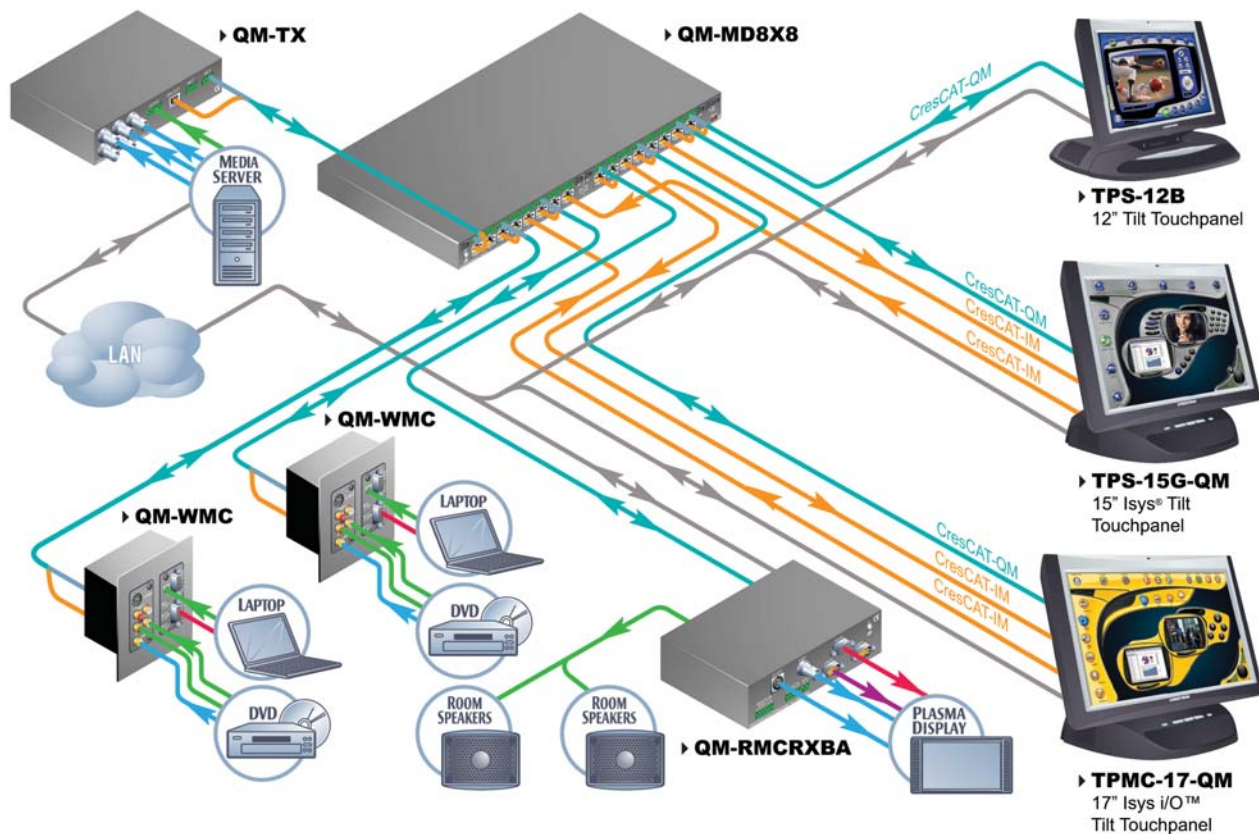

See end of section for additional diagrams

Isys® Tilt Touchpanels cross reference

	Isys Tilt Touchpanels				
	TPS-17B (or W)	TPS-15B (or W)	TPS-12B (or W)	TPS-4000	TPS-3000
Touchscreen Display					
Display Size	17"	15"	12"	10.4"	6.4"
Aspect Ratio	15:9 WXGA	4:3 XGA	4:3 SVGA	4:3 VGA	4:3 VGA
Resolution	1280 x 768	1024 x 768	800 x 600	640 x 480	640 x 480
Color Depth	24-bit 16.7M	24-bit 16.7M	18-bit 16.7M	18-bit 256k	18-bit 256k
Touchpanel Graphics					
Color Depth	24-bit 16.7M	24-bit 16.7M	24-bit 16.7M	16-bit 64k	16-bit 64k
8-bit Alpha Channel Transparency	•	•	•		
Synapse Image Rendering and Multimode Objects	•	•	•	•	•
Dynamic Text and Animation	•	•	•	•	•
Dynamic Graphics and PNG Translucency	•	•	•		
Dynamic Menu Graphics					
Memory					
RAM	128MB	128MB	128MB	8MB	8MB
Flash	64MB	64MB	64MB	8MB	8MB
Memory Card Slot	up to 4GB	up to 4GB	up to 4GB		
Maximum Project Size	160MB	160MB	160MB	7MB	7MB
Annotation & PC					
Windows XP Embedded OS					
Web Browser and Media Player, Remote Desktop, VoIP, NetMeeting, Yahoo! Widgets, MS Office and Adobe Document Viewers ⁴					
Annotation					
Keyboard/Mouse Input					
Touch-the-PC					
Video/RGB					
Scalable Windows	1	1	1	1	1
Hardware Connections	QM, CH, BNC ¹	QM, CH, BNC ¹	QM, CH, BNC ¹	CH ¹ , BNC ¹	CH ¹ , BNC ¹
Composite	•	•	•	•	•
S-Video	•	•	•	•	•
Component	•	•	•		
HDTV up to 1080i					
RGB up to 1600 x 1200					
Streaming Motion-JPEG					
Media Player (Multiple Formats)					
Display Output					
Audio					
Amplified Speakers and Microphone	•	•	•	•	•
WAV Sound File Audio Feedback	•	•	•	•	•
Network					
Cresnet	•	•	•	•	•
Ethernet	•	•	•		
Wi-Fi ²					
Buttons					
Backlit Softkeys	4	4	4		
Enclosure					
Tiltcase	•	•	•	•	•
Slimline Base	•	•	•	•	•
Integral Rear Cover with Strain Relief	•	•	•	• ³	• ³
Available White Finish	•	•	•		

¹ Connections via outboard IMC interface module (included)

² Wireless NIC required

³ Accessory sold separately

⁴ See product spec for a complete list of embedded applications

Isys G-Series Tilt Touchpanels

Isys i/O Tilt Touchpanel Media Centers

TPS-15G-QM	TPS-12G-QM	TPMC-17-QM	TPMC-15-QM	TPMC-17-CH	TPMC-15-CH
15"	12"	17"	15"	17"	15"
4:3 XGA	4:3 SVGA	15:9 WXGA	4:3 XGA	15:9 WXGA	4:3 XGA
1024 x 768	800 x 600	1280 x 768	1024 x 768	1280 x 768	1024 x 768
24-bit 16.7M	18-bit 256k	24-bit 16.7M	24-bit 16.7M	24-bit 16.7M	24-bit 16.7M
24-bit 16.7M	24-bit 16.7M	24-bit 16.7M	24-bit 16.7M	24-bit 16.7M	24-bit 16.7M
•	•	•	•	•	•
•	•	•	•	•	•
•	•	•	•	•	•
•	•	•	•	•	•
•	•	•	•	•	•
128MB	128MB	512MB	512MB	512MB	512MB
64MB	64MB	512MB	512MB	512MB	512MB
up to 4GB	up to 4GB	up to 4GB	up to 4GB	up to 4GB	up to 4GB
160MB	160MB	190MB	190MB	190MB	190MB
		•	•	•	•
		•	•	•	•
Live Only	Live Only	MediaMarker	MediaMarker	MediaMarker	MediaMarker
USB Mouse	USB Mouse	USB	USB	USB	USB
•	•	•	•		
2	2	2	2	2	2
QM	QM	QM	QM	CH, BNC ¹	CH, BNC ¹
•	•	•	•	•	•
•	•	•	•	•	•
•	•	•	•	•	•
•	•	•	•	•	•
•	•	•	•	•	•
•	•	•	•	•	•
•	•	•	•	•	•
•	•	•	•	•	•
•	•	•	•	•	•
•	•	•	•	•	•
•	•	•	•	•	•
•	•	•	•	•	•
•	•	•	•	•	•
•	•	•	•	•	•
•	•	•	•	•	•
•	•	•	•	•	•
•	•	•	•	•	•
•	•	•	•	•	•
•	•	•	•	•	•
4	4	4	4	4	4
•	•	•	•	•	•
•	•	•	•	•	•

ISYS® TILT TOUCHPANELS

→ Isys® Tilt Touchpanels

TPS-17B/TPS-17W Isys® 17" Widescreen Tilt Touchpanel



tilt touchpanels

Crestron's new Isys touchpanels deliver a higher level of performance to meet the demands of today's sophisticated control and automation applications. Incorporating modern styling in a versatile tiltcase design, the Isys TPS-17B (and TPS-17W) features a spectacular 17" WXGA widescreen display offering an extra wide viewing angle with exceptional brightness and contrast for stunning control graphics, high-resolution images, and full-motion video.

Crestron touchpanels offer an ideal user-interface for multimedia presentation, videoconferencing, home automation, and much more, providing a wide-open canvas for the creation of custom control screens tailored to the needs of the end-user. Touchpanels do away with piles of remote controls, cryptic control panels and cluttered wall switches, simultaneously expanding and simplifying control over a broad range of complex devices and systems.

Isys®—Isys power and beauty are infused throughout Crestron's entire touchpanel lineup. Under the hood, the TPS-17B offers vibrant 24-bit color depth with 8-bit alpha channel transparency to produce incredible 3D graphics and high-res images. The Isys engine supports dynamic graphics and text, full-motion animations, multimode objects, and PNG translucency - all with astonishing speed.

Synapse™—Crestron's exclusive Synapse Image Rendering Algorithm enables system programmers to produce amazing graphics - faster and easier. Advanced antialiasing delivers crisper, sharper objects and text. Enhanced 3D effects add new depth and style. And because Synapse is native to the touchpanel, memory requirements and upload time are substantially reduced.

High-Performance Video—The TPS-17B can display full-motion video from an external AV source, either full screen or in a scalable window. Motion adaptive deinterlacing brings out the highest detail, minimizing visible scan lines and motion artifacts for a truly remarkable picture. Advanced gamma correction and built-in time base correction ensure accurate color reproduction and a jitter-free image.

High-Quality Audio—The built-in amplified speaker system provides amplification for external AV sources, and supports intercom functionality in combination with the integrated microphone. Customized WAV files can be loaded on the touchpanel to add dimension to the touchscreen graphics with personalized sounds, button feedback, and voice prompts.

Crestron Home® CAT5 AV—Connecting audio and video sources to the TPS-17B is facilitated using inexpensive CAT5 wire, enabling direct connection to Crestron's popular CAT5 balanced audio and video distribution switchers. A single video input port accepts signals from composite, S-Video, and standard-definition component sources over wiring distances of up to 750 feet. A bidirectional audio port receives stereo program audio and intercom signals, and outputs audio from the internal microphone. To facilitate the connection of conventional video and audio devices, an external interface module is included.

QuickMedia™—The TPS-17B is also equipped with a single QuickMedia input port. Through QuickMedia (QM), the TPS-17B interfaces directly with Crestron's QM-based MediaManager products using a single CAT5e type cable. Over wiring distances of up to 300 feet, the QM Input port accepts video signals from composite, S-Video, and standard-definition component sources along with discrete audio signals from one (1) stereo program source and up to two (2) microphones.

High-Speed Connectivity—Both Cresnet and high-speed Ethernet are standard on the TPS-17B, providing for easy network integration and seamless communications with Crestron control systems.

Slimline Tiltcase Design—The stylish tiltcase housing allows smooth tilt adjustment from 45 to 90 degrees, and features an integral cable strain relief system and rear cover to secure and hide the connections at the back of the touchpanel. Four backlit pushbuttons are also provided, allowing for quick access to commonly used functions.

ISYS® TILT TOUCHPANELS

► Isys® Tilt Touchpanels

Isys® 17" Widescreen Tilt Touchpanel **TPS-17B/TPS-17W**

- ▶ 17" widescreen active matrix touchscreen display | 1280 x 768 resolution
- ▶ 24-Bit Isys graphics | Synapse™ image rendering algorithm
- ▶ Full-motion video with gamma correction and motion adaptive deinterlacing
- ▶ Built-in amplified speaker system and microphone
- ▶ QuickMedia and Crestron Home CAT5 AV connectivity
- ▶ High-speed Ethernet and Cresnet communications
- ▶ Tiltcase housing with integral rear cover and cable strain relief
- ▶ Available in black or white
- ▶ Backlit "Softkey" pushbuttons

AVAILABLE MODELS

TPS-17B

Isys® 17" Widescreen Tilt Touchpanel, Black

TPS-17W

Isys® 17" Widescreen Tilt Touchpanel, White

TPS-17B using CAT5 AV Interface Module

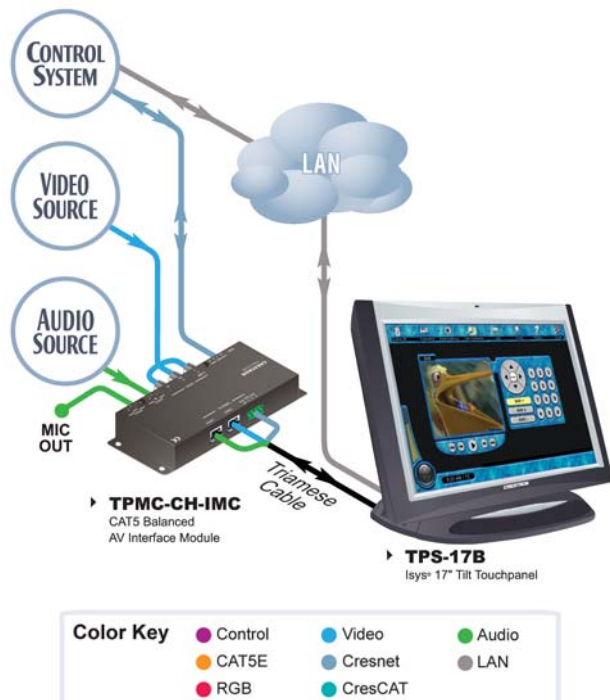

SPECIFICATIONS

Touchscreen Display

Display Type: TFT Active matrix color LCD
Size: 17 inch (43.2 cm) diagonal widescreen
Aspect Ratio: 15:9 WXGA
Resolution: 1280 x 768 pixels
Brightness: 450 nits (cd/m²)
Contrast: 400:1
Color Depth: 24-bit, 16.7M colors
Illumination: Backlit fluorescent
Viewing Angle: ±88° horizontal, ±88° vertical
Touchscreen: Resistive membrane

Processor

CPU: 32-bit Freescale ColdFire® Microprocessor

Memory

DDR RAM: 128 MB
Flash: 64 MB
Compact Flash: Accepts up to 4GB Type II CF (not included)
Maximum Project Size: 160 MB

Graphic Engine

Isys engine, 24-bit non-palette graphics + 8-bit alpha channel transparency, 16.7 million colors, Synapse image rendering algorithm, multi-mode objects, dynamic graphics, PNG translucency, full-motion (60 fps) animation, transition effects, color key video windowing

Ethernet

10BaseT/100BaseTX, auto-switching, auto-negotiating, full/half duplex, TCP/IP, UDP/IP, CIP, IEEE 802.3U compliant

Video

Signal Types: Auto-detecting composite, S-Video, or component
Formats: NTSC 480i or PAL 576i
Color Depth: 24-bit, 16.7M colors
Features: Single-window scalable to full-screen, input switching between QM and VIDEO inputs, time base correction, gamma correction, line doubling, motion adaptive deinterlacing, reverse 3:2/2:2 pulldown

Audio

Hardware Features: Built-in microphone and amplified speakers, stereo headphone output, internal volume control and audio mixer
Audio Feedback (WAV): 8-bit PCM, mono, 8 kHz sampling rate
D-A Conversion (QM only): 24-bit, 48 kHz
Amplification: Mono, 5 Watts x 2

Buttons

- (4) Backlit "softkey" buttons, programmable
- (1) Miniature recessed hard reset button, reboots the touchpanel

tilt touchpanels

> continued

TPS-17B/TPS-17W Isys® 17" Widescreen Tilt Touchpanel (continued)

TPS-17B using QuickMedia

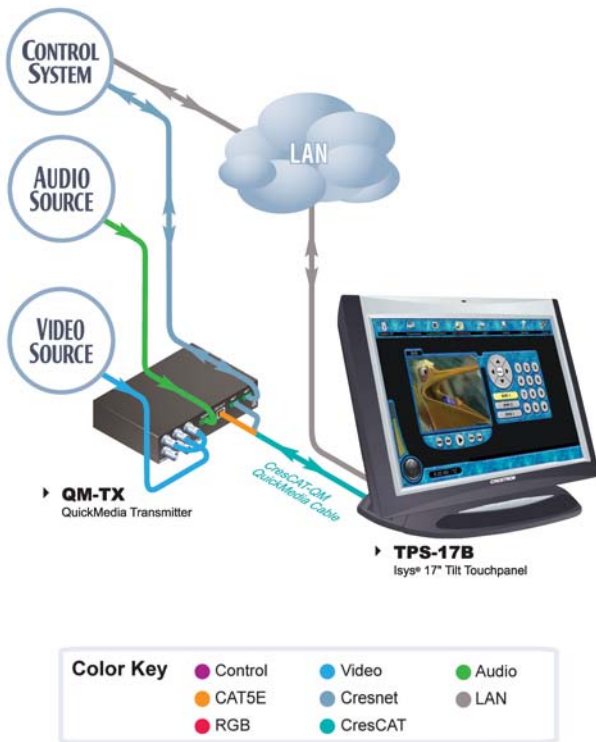

Connectors

QM IN: (1) 8-wire RJ45 female, QuickMedia input port
Signal Types: Auto-detecting component (YP_BP_R), S-Video (Y/C), or composite video with stereo program audio and (2) mic channels;
Video Formats: NTSC 480i or PAL 576i
Connects to QM output port of a QM-TX or other QuickMedia device via CresCAT-QM or CresCAT-IM cable;
Maximum Cable Length: 300 ft (aggregate distance from QM origination)

VIDEO IN: (1) 8-wire RJ45 female, CAT5 balanced video input port
Signal Types: Auto-detecting component (YP_BP_R), S-Video (Y/C), or composite;
Formats: NTSC 480i or PAL 576i
Input Impedance: 100 ohms balanced
Connects to any Crestron CAT5 balanced video source via CresCAT cable, or TPMC-CH-IMC interface module (included) via 15 foot "triamese" cable provided;
Maximum Cable Length: 500 feet for component, 750 feet for composite/S-Video

AUDIO I/O: (1) 8-wire RJ45 female
Bidirectional CAT5 balanced audio port
Signal Types: Receives (1) balanced stereo audio signal, and transmits (1) balanced stereo audio signal from internal microphone;
Maximum Input Level: 4 V_{RMS}
Maximum Output Level: 2 V_{RMS}
Input/Output Impedance: 600 ohms
Connects to any other Crestron CAT5 balanced audio port via CresCAT cable, or TPMC-CH-IMC interface module (included) via 15 foot "triamese" cable provided;
Maximum Cable Length: 1000 feet

HEADPHONES: (1) 3.5 mm TRS mini phone jack
Output Power: 12mW per channel
Minimum Impedance: 32 ohms

USB: (1) USB Type B female (reserved for future applications)

NET: (1) 4-pin 3.5mm detachable terminal block
Cresnet Slave Port, connects to Cresnet control network, or TPMC-CH-IMC interface module (included) via 15 foot "triamese" cable provided

LAN: (1) 8-wire RJ45 with 2 LED indicators
10BaseT/100BaseTX Ethernet port
Green LED indicates link status
Yellow LED indicates Ethernet activity

RS-232: (1) 6-pin RJ11 female
Computer console, touch output or mouse input port
Bidirectional RS-232 up to 115.2k baud
Hardware and software handshaking support

G: (1) 6-32 screw, chassis ground lug

MEMORY EXPANSION: (1) Type II Compact Flash card slot for memory expansion

Power Requirements

Cresnet Power Usage: 74 Watts (3.1 Amps @ 24 Volts DC)

Environmental

Temperature: 41° to 113°F (5° to 45°C)

Humidity: 10% to 90% RH (non-condensing)

Enclosure

Construction: High impact injection-molded case, tilt screen with adjustable tension, integral rear cover and cable strain relief in base

Screen Tilt: Adjustable 45 to 90 degrees

Dimensions

Height: 13.78 in (35.01 cm)

Width: 17.63 in (44.79 cm)

Depth: 12.40 in (31.50 cm)

Weight

18.10 lbs (8.21 kg)

ISYS® TILT TOUCHPANELS

→ Isys® Tilt Touchpanels

Isys® 17" Widescreen Tilt Touchpanel **TPS-17B/TPS-17W**

INCLUDED ACCESSORIES

TPMC-CH-IMC

CAT5 Balanced AV Interface Module + 15 ft triamese cable
(See TPMC-CH-IMC specifications for complete information)

TPS-17B in a CH CAT5 AV Distribution System

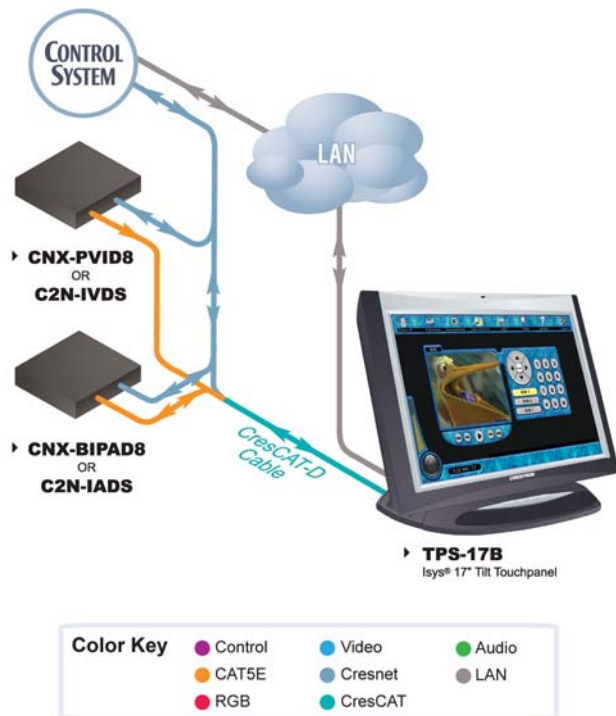

tilt touchpanels

AVAILABLE ACCESSORIES

- | | | | |
|---|---|---|--|
| ▶ TPMC-CH-IMW
CAT5 Balanced AV Interface Wall Plate | ▶ QM-TX
QuickMedia Transmitter | ▶ ST-PK
Programming Cable Kit | ▶ CresCAT®QM
QuickMedia™ Cable |
| ▶ TPS/TPMC-CBL-T
Triamese Interface Cables | ▶ SMK-12/15/17
Swivel Mount Kit | ▶ CresCAT®D
Crestron Home® CAT5 Balanced AV Cable | ▶ CresCAT®IM
iMedia Cable |

ISYS® TILT TOUCHPANELS

→ Isys® Tilt Touchpanels

TPS-15B/TPS-15W Isys® 15" Tilt Touchpanel



Crestron's new Isys touchpanels deliver a higher level of performance to meet the demands of today's sophisticated control and automation applications. Incorporating modern styling in a versatile tiltcase design, the Isys TPS-15B (and TPS-15W) features a spectacular 15" XGA true-color display offering an extra wide viewing angle with exceptional brightness and contrast for stunning control graphics, high-resolution images, and full-motion video.

Crestron touchpanels offer an ideal user-interface for multimedia presentation, videoconferencing, home automation, and much more, providing a wide-open canvas for the creation of custom control screens tailored to the needs of the end-user. Touchpanels do away with piles of remote controls, cryptic control panels and cluttered wall switches, simultaneously expanding and simplifying control over a broad range of complex devices and systems.

Isys®—Isys power and beauty are infused throughout Crestron's entire touchpanel lineup. Under the hood, the TPS-15B offers vibrant 24-bit color depth with 8-bit alpha channel transparency to produce incredible 3D graphics and high-res images. The Isys engine supports dynamic graphics and text, full-motion animations, multimode objects, and PNG translucency - all with astonishing speed.

Synapse™—Crestron's exclusive Synapse Image Rendering Algorithm enables system programmers to produce amazing graphics - faster and easier. Advanced antialiasing delivers crisper, sharper objects and text. Enhanced 3D effects add new depth and style. And because Synapse is native to the touchpanel, memory requirements and upload time are substantially reduced.

High-Performance Video—The TPS-15B can display full-motion video from an external AV source, either full screen or in a scalable window. Motion adaptive deinterlacing brings out the highest detail, minimizing visible scan lines and motion artifacts for a truly remarkable picture. Advanced gamma correction and built-in time base correction ensure accurate color reproduction and a jitter-free image.

High-Quality Audio—The built-in amplified speaker system provides amplification for external AV sources, and supports intercom functionality in combination with the integrated microphone. Customized WAV files can be loaded on the touchpanel to add dimension to the touchscreen graphics with personalized sounds, button feedback, and voice prompts.

Crestron Home® CAT5 AV—Connecting audio and video sources to the TPS-15B is facilitated using inexpensive CAT5 wire, enabling direct connection to Crestron's popular CAT5 balanced audio and video distribution switchers. A single video input port accepts signals from composite, S-Video, and standard-definition component sources over wiring distances of up to 750 feet. A bidirectional audio port receives stereo program audio and intercom signals, and outputs audio from the internal microphone. To facilitate the connection of conventional video and audio devices, an external interface module is included.

QuickMedia™—The TPS-15B is also equipped with a single QuickMedia input port. Through QuickMedia (QM), the TPS-15B interfaces directly with Crestron's QM-based MediaManager products using a single CAT5e type cable. Over wiring distances of up to 300 feet, the QM Input port accepts video signals from composite, S-Video, and standard-definition component sources along with discrete audio signals from one (1) stereo program source and up to two (2) microphones.

High-Speed Connectivity—Both Cresnet and high-speed Ethernet are standard on the TPS-15B, providing for easy network integration and seamless communications with Crestron control systems.

Slimline Tiltcase Design—The stylish tiltcase housing allows smooth tilt adjustment from 45 to 90 degrees, and features an integral cable strain relief system and rear cover to secure and hide the connections at the back of the touchpanel. Four backlit pushbuttons are also provided, allowing for quick access to commonly used functions.

ISYS® TILT TOUCHPANELS

► Isys® Tilt Touchpanels

Isys® 15" Tilt Touchpanel **TPS-15B/TPS-15W**

- ▶ 15" active matrix touchscreen display | 1024 x 768 resolution
- ▶ 24-Bit Isys graphics | Synapse image rendering algorithm
- ▶ Full-motion video with gamma correction and motion adaptive deinterlacing
- ▶ Built-in amplified speaker system and microphone
- ▶ QuickMedia and Crestron Home CAT5 AV connectivity
- ▶ High-speed Ethernet and Cresnet communications
- ▶ Tiltcase housing with integral rear cover and cable strain relief
- ▶ Available in black or white
- ▶ Backlit "Softkey" pushbuttons

AVAILABLE MODELS

TPS-15B

Isys® 15" Tilt Touchpanel, Black

TPS-15W

Isys® 15" Tilt Touchpanel, White

TPS-15B using CAT5 AV Interface Module

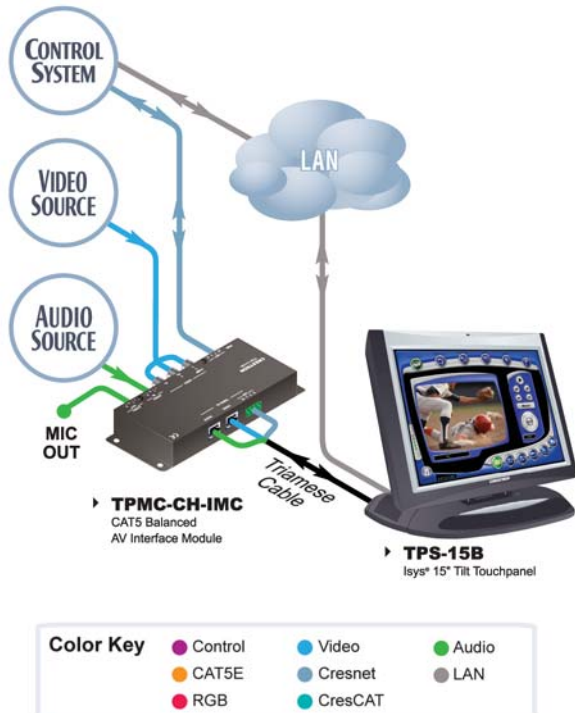

SPECIFICATIONS

Touchscreen Display

Display Type: TFT Active matrix color LCD
Size: 15 inch (38.1 cm) diagonal
Aspect Ratio: 4:3 XGA
Resolution: 1024 x 768 pixels
Brightness: 350 nits (cd/m²)
Contrast: 700:1
Color Depth: 24-bit, 16.7M colors
Illumination: Backlit fluorescent
Viewing Angle: ±85° horizontal, ±85° vertical
Touchscreen: Resistive membrane

Processor

CPU: 32-bit Freescale ColdFire® Microprocessor

Memory

DDR RAM: 128 MB
Flash: 64 MB
Compact Flash: Accepts up to 4GB Type II CF (not included)
Maximum Project Size: 160MB

Graphic Engine

Isys engine, 24-bit non-palette graphics + 8-bit alpha channel transparency, 16.7 million colors, Synapse image rendering algorithm, multi-mode objects, dynamic graphics, PNG translucency, full-motion (60 fps) animation, transition effects, color key video windowing

Ethernet

10BaseT/100BaseTX, auto-switching, auto-negotiating, full/half duplex, TCP/IP, UDP/IP, CIP, IEEE 802.3U compliant

Video

Signal Types: Auto-detecting composite, S-Video, or component
Formats: NTSC 480i or PAL 576i
Color Depth: 24-bit, 16.7M colors
Features: Single-window scalable to full-screen, input switching between QM and VIDEO inputs, time base correction, gamma correction, line doubling, motion adaptive deinterlacing, reverse 3:2/2:2 pulldown

Audio

Hardware Features: Built-in microphone and amplified speakers, stereo headphone output, internal volume control and audio mixer
Audio Feedback (WAV): 8-bit PCM, mono, 8 kHz sampling rate
D-A Conversion (QM only): 24-bit, 48 kHz
Amplification: Mono, 5 Watts x 2

Buttons

- (4) Backlit "softkey" buttons, programmable
- (1) Miniature recessed hard reset button, reboots the touchpanel

tilt touchpanels

> continued

ISYS® TILT TOUCHPANELS

→ Isys® Tilt Touchpanels

TPS-15B/TPS-15W Isys® 15" Tilt Touchpanel (continued)

Connectors

QM IN: (1) 8-wire RJ45 female, QuickMedia input port
Signal Types: Auto-detecting component (YPbPr), S-Video (Y/C), or composite video with stereo program audio and (2) mic channels;
Video Formats: NTSC 480i or PAL 576i
Connects to QM output port of a QM-TX or other QuickMedia device via CresCAT-QM or CresCAT-IM cable;
Maximum Cable Length: 300 ft (aggregate distance from QM origination)

VIDEO IN: (1) 8-wire RJ45 female, CAT5 balanced video input port
Signal Types: Auto-detecting component (YPbPr), S-Video (Y/C), or composite;
Formats: NTSC 480i or PAL 576i
Input Impedance: 100 ohms balanced
Connects to any Crestron CAT5 balanced video source via CresCAT cable, or TPMC-CH-IMC interface module (included) via 15 foot "triamese" cable provided;
Maximum Cable Length: 500 feet for component, 750 feet for composite/S-Video

AUDIO I/O: (1) 8-wire RJ45 female
Bidirectional CAT5 balanced audio port
Signal Types: Receives (1) balanced stereo audio signal, and transmits (1) balanced stereo audio signal from internal microphone;
Maximum Input Level: 4 V_{RMS}
Maximum Output Level: 2 V_{RMS}
Input/Output Impedance: 600 ohms

Connects to any other Crestron CAT5 balanced audio port via CresCAT cable, or TPMC-CH-IMC interface module (included) via 15 foot "triamese" cable provided;
Maximum Cable Length: 1000 feet

HEADPHONES: (1) 3.5 mm TRS mini phone jack
Output Power: 12mW per channel
Minimum Impedance: 32 ohms

USB: (1) USB Type B female (reserved for future applications)

NET: (1) 4-pin 3.5mm detachable terminal block
Cresnet Slave Port, connects to Cresnet control network, or TPMC-CH-IMC interface module (included) via 15 foot "triamese" cable provided

LAN: (1) 8-wire RJ45 with 2 LED indicators
10BaseT/100BaseTX Ethernet port
Green LED indicates link status
Yellow LED indicates Ethernet activity

RS-232: (1) 6-pin RJ11 female
Computer console, touch output or mouse input port
Bidirectional RS-232 up to 115.2k baud
Hardware and software handshaking support

G: (1) 6-32 screw, chassis ground lug

MEMORY EXPANSION: (1) Type II Compact Flash card slot for memory expansion

Power Requirements

Cresnet Power Usage: 65 Watts (2.7 Amps @ 24 Volts DC)

Environmental

Temperature: 41° to 113°F (5° to 45°C)
Humidity: 10% to 90% RH (non-condensing)

Enclosure

Construction: High impact injection-molded case, tilt screen with adjustable tension, integral rear cover and cable strain relief in base
Screen Tilt: Adjustable 45 to 90 degrees

Dimensions

Height: 13.68 in (34.75 cm)
Width: 14.94 in (37.95 cm)
Depth: 12.40 in (31.50 cm)

Weight

14.55 lbs (6.60 kg)

INCLUDED ACCESSORIES

TPMC-CH-IMC

CAT5 Balanced AV Interface Module + 15 ft triamese cable
(See TPMC-CH-IMC specifications for complete information)

tilt touchpanels

TPS-15B using QuickMedia

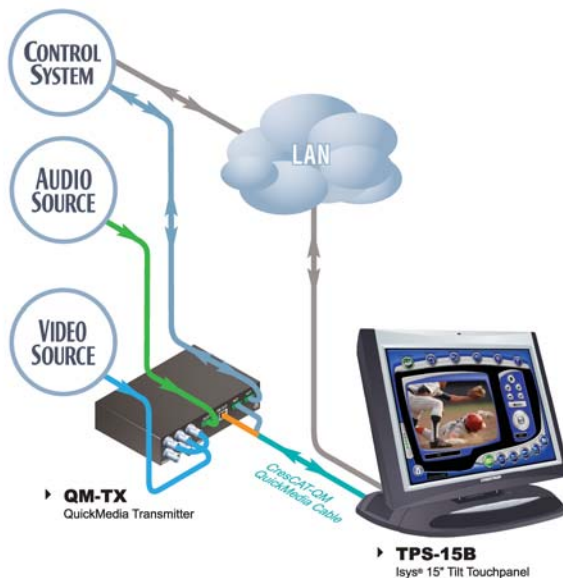

Color Key	
Control	Video
CAT5E	Cresnet
RGB	CresCAT
	LAN

ISYS® TILT TOUCHPANELS

→ Isys® Tilt Touchpanels

Isys® 15" Tilt Touchpanel **TPS-15B/TPS-15W**

TPS-15B in a CH CAT5 AV Distribution System

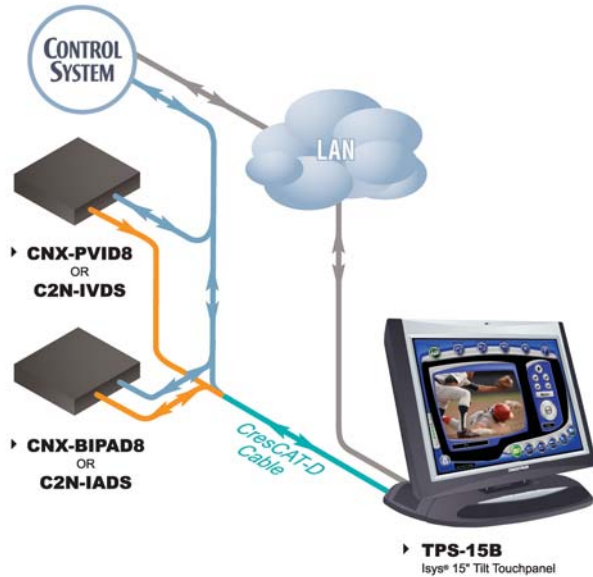

Color Key		
● Control	● Video	● Audio
● CAT5E	● Cresnet	● LAN
● RGB	● CresCAT	

tilt touchpanels

AVAILABLE ACCESSORIES

- ▶ **TPMC-CH-IMW**
CAT5 Balanced AV Interface Wall Plate
- ▶ **QΜ-TX**
QuickMedia Transmitter
- ▶ **ST-PK**
Programming Cable Kit
- ▶ **CresCAT®QM**
QuickMedia™ Cable
- ▶ **TPS/TPMC-CBL-T**
Triamese Interface Cables
- ▶ **SMK-12/15/17**
Swivel Mount Kit
- ▶ **CresCAT®D**
Crestron Home® CAT5 Balanced AV Cable
- ▶ **CresCAT®IM**
iMedia Cable

ISYS® TILT TOUCHPANELS

→ Isys® Tilt Touchpanels

TPS-12B/TPS-12W Isys® 12" Tilt Touchpanel



tilt touchpanels

Crestron's new Isys touchpanels deliver a higher level of performance to meet the demands of today's sophisticated control and automation applications. Incorporating modern styling in a versatile tiltcase design, the Isys TPS-12B (and TPS-12W) features a spectacular 12" SVGA display offering a wide viewing angle with exceptional brightness and contrast for stunning control graphics, high-resolution images, and full-motion video.

Crestron touchpanels offer an ideal user-interface for multimedia presentation, videoconferencing, home automation, and much more, providing a wide-open canvas for the creation of custom control screens tailored to the needs of the end-user. Touchpanels do away with piles of remote controls, cryptic control panels and cluttered wall switches, simultaneously expanding and simplifying control over a broad range of complex devices and systems.

Isys®—Isys power and beauty are infused throughout Crestron's entire touchpanel lineup. Under the hood, the TPS-12B offers vibrant 24-bit color depth with 8-bit alpha channel transparency to produce incredible 3D graphics and high-res images. The Isys engine supports dynamic graphics and text, full-motion animations, multimode objects, and PNG translucency - all with astonishing speed.

Synapse™—Crestron's exclusive Synapse Image Rendering Algorithm enables system programmers to produce amazing graphics - faster and easier. Advanced antialiasing delivers crisper, sharper objects and text. Enhanced 3D effects add new depth and style. And because Synapse is native to the touchpanel, memory requirements and upload time are substantially reduced.

High-Performance Video—The TPS-12B can display full-motion video from an external AV source, either full screen or in a scalable window. Motion adaptive deinterlacing brings out the highest detail, minimizing visible scan lines and motion artifacts for a truly remarkable picture. Advanced gamma correction and built-in time base correction ensure accurate color reproduction and a jitter-free image.

High-Quality Audio—The built-in amplified speaker system provides amplification for external AV sources, and supports intercom functionality in combination with the integrated microphone. Customized WAV files can be loaded on the touchpanel to add dimension to the touchscreen graphics with personalized sounds, button feedback, and voice prompts.

Crestron Home® CAT5 AV—Connecting audio and video sources to the TPS-12B is facilitated using inexpensive CAT5 wire, enabling direct connection to Crestron's popular CAT5 balanced audio and video distribution switchers. A single video input port accepts signals from composite, S-Video, and standard-definition component sources over wiring distances of up to 750 feet. A bidirectional audio port receives stereo program audio and intercom signals, and outputs audio from the internal microphone. To facilitate the connection of conventional video and audio devices, an external interface module is included.

QuickMedia™—The TPS-12B is also equipped with a single QuickMedia input port. Through QuickMedia (QM), the TPS-12B interfaces directly with Crestron's QM-based MediaManager products using a single CAT5e type cable. Over wiring distances of up to 300 feet, the QM Input port accepts video signals from composite, S-Video, and standard-definition component sources along with discrete audio signals from one (1) stereo program source and up to two (2) microphones.

High-Speed Connectivity—Both Cresnet and high-speed Ethernet are standard on the TPS-12B, providing for easy network integration and seamless communications with Crestron control systems.

Slimline Tiltcase Design—The stylish tiltcase housing allows smooth tilt adjustment from 45 to 90 degrees, and features an integral cable strain relief system and rear cover to secure and hide the connections at the back of the touchpanel. Four backlit pushbuttons are also provided, allowing for quick access to commonly used functions.

ISYS® TILT TOUCHPANELS

→ Isys® Tilt Touchpanels

Isys® 12" Tilt Touchpanel **TPS-12B/TPS-12W**

- ▶ 12" active matrix touchscreen display | 800 x 600 resolution
- ▶ 24-Bit Isys graphics | Synapse image rendering algorithm
- ▶ Full-motion video with gamma correction and motion adaptive deinterlacing
- ▶ Built-in amplified speaker system and microphone
- ▶ QuickMedia and Crestron Home CAT5 AV connectivity
- ▶ High-speed Ethernet and Cresnet communications
- ▶ Tiltcase housing with integral rear cover and cable strain relief
- ▶ Available in black or white
- ▶ Backlit "Softkey" pushbuttons

AVAILABLE MODELS

TPS-12B

Isys® 12" Tilt Touchpanel, Black

TPS-12W

Isys® 12" Tilt Touchpanel, White

TPS-12B using CAT5 AV Interface Module

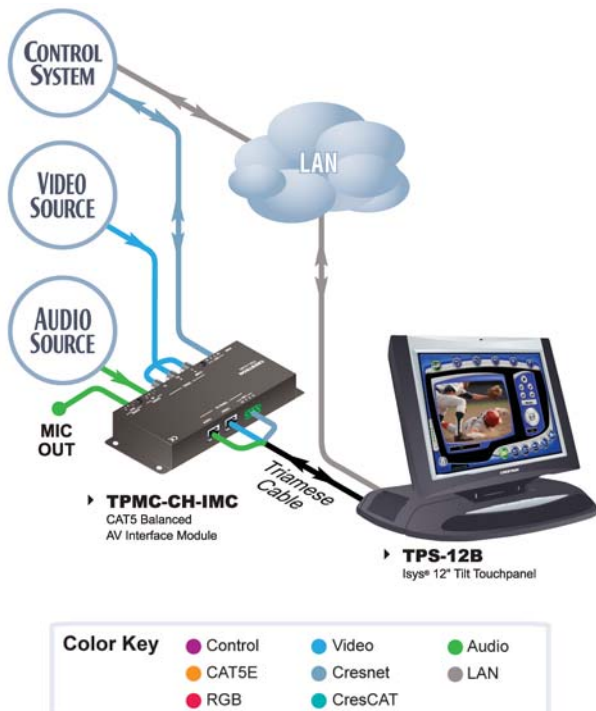

SPECIFICATIONS

Touchscreen Display

Display Type: TFT Active matrix color LCD

Size: 12 inch (30.5 cm) diagonal

Aspect Ratio: 4:3 SVGA

Resolution: 800 x 600 pixels

Brightness: 400 nits (cd/m²)

Contrast: 300:1

Color Depth: 18-bit, 256k colors

Illumination: Backlit fluorescent

Viewing Angle: ±70° horizontal, +45/-55° vertical

Touchscreen: Resistive membrane

Processor

CPU: 32-bit Freescale ColdFire® Microprocessor

Memory

DDR RAM: 128 MB

Flash: 64 MB

Compact Flash: Accepts up to 4GB Type II CF (not included)

Maximum Project Size: 160 MB

Graphic Engine

Isys engine, 24-bit non-palette graphics + 8-bit alpha channel transparency, 16.7 million colors, Synapse image rendering algorithm, multi-mode objects, dynamic graphics, PNG translucency, full-motion (60 fps) animation, transition effects, color key video windowing

Ethernet

10BaseT/100BaseTX, auto-switching, auto-negotiating, full/half duplex, TCP/IP, UDP/IP, CIP, IEEE 802.3U compliant

Video

Signal Types: Auto-detecting composite, S-Video, or component

Formats: NTSC 480i or PAL 576i

Color Depth: 24-bit, 16.7M colors

Features: Single-window scalable to full-screen, input switching between QM and VIDEO inputs, time base correction, gamma correction, line doubling, motion adaptive deinterlacing, reverse 3:2/2:2 pull-down

Audio

Hardware Features: Built-in microphone and amplified speakers, stereo headphone output, internal volume control and audio mixer

Audio Feedback (WAV): 8-bit PCM, mono, 8 kHz sampling rate

D-A Conversion (QM only): 24-bit, 48 kHz

Amplification: Mono, 5 Watts x 2

Buttons

(4) Backlit "softkey" buttons, programmable

(1) Miniature recessed hard reset button, reboots the touchpanel

tilt touchpanels

> continued

ISYS® TILT TOUCHPANELS

► Isys® Tilt Touchpanels

TPS-12B/TPS-12W Isys® 12" Tilt Touchpanel (continued)

Connectors

QM IN: (1) 8-wire RJ45 female, QuickMedia input port
Signal Types: Auto-detecting component (YPbPr), S-Video (Y/C), or composite video with stereo program audio and (2) mic channels;
Video Formats: NTSC 480i or PAL 576i
Connects to QM output port of a QM-TX or other QuickMedia device via CresCAT-QM or CresCAT-IM cable;
Maximum Cable Length: 300 ft (aggregate distance from QM origination)

VIDEO IN: (1) 8-wire RJ45 female
CAT5 balanced video input port
Signal Types: Auto-detecting component (YPbPr), S-Video (Y/C), or composite;
Formats: NTSC 480i or PAL 576i
Input Impedance: 100 ohms balanced
Connects to any Crestron CAT5 balanced video source via CresCAT cable, or TPMC-CH-IMC interface module (included) via 15 foot "triamese" cable provided;
Maximum Cable Length: 500 feet for component, 750 feet for composite/S-Video

AUDIO I/O: (1) 8-wire RJ45 female
Bidirectional CAT5 balanced audio port
Signal Types: Receives (1) balanced stereo audio signal, and transmits (1) balanced stereo audio signal from internal microphone;
Maximum Input Level: 4 V_{RMS}
Maximum Output Level: 2 V_{RMS}
Input/Output Impedance: 600 ohms
Connects to any other Crestron CAT5 balanced audio port via CresCAT cable, or TPMC-CH-IMC interface module (included) via 15 foot "triamese" cable provided;
Maximum Cable Length: 1000 feet

HEADPHONES: (1) 3.5 mm TRS mini phone jack
Output Power: 12mW per channel
Minimum Impedance: 32 ohms

USB: (1) USB Type B female (reserved for future applications)

NET: (1) 4-pin 3.5mm detachable terminal block
Cresnet Slave Port, connects to Cresnet control network, or TPMC-CH-IMC interface module (included) via 15 foot "triamese" cable provided

LAN: (1) 8-wire RJ45 with 2 LED indicators
10BaseT/100BaseTX Ethernet port
Green LED indicates link status
Yellow LED indicates Ethernet activity

RS-232: (1) 6-pin RJ11 female
Computer console, touch output or mouse input port
Bidirectional RS-232 up to 115.2k baud
Hardware and software handshaking support

G: (1) 6-32 screw, chassis ground lug

MEMORY EXPANSION: (1) Type II Compact Flash card slot for memory expansion

Power Requirements

Cresnet Power Usage: 43 Watts (1.8 Amps @ 24 Volts DC)

Environmental

Temperature: 41° to 113°F (5° to 45°C)

Humidity: 10% to 90% RH (non-condensing)

Enclosure

Construction: High impact injection-molded case, tilt screen with adjustable tension, integral rear cover and cable strain relief in base

Screen Tilt: Adjustable 45 to 90 degrees

Dimensions

Height: 12.15 in (30.86 cm)

Width: 12.85 in (32.64 cm)

Depth: 12.40 in (31.50 cm)

Weight

12.95 lbs (5.88 kg)

INCLUDED ACCESSORIES

TPMC-CH-IMC

CAT5 Balanced AV Interface Module + 15 ft triamese cable
(See TPMC-CH-IMC specifications for complete information)

TPS-12B using QuickMedia

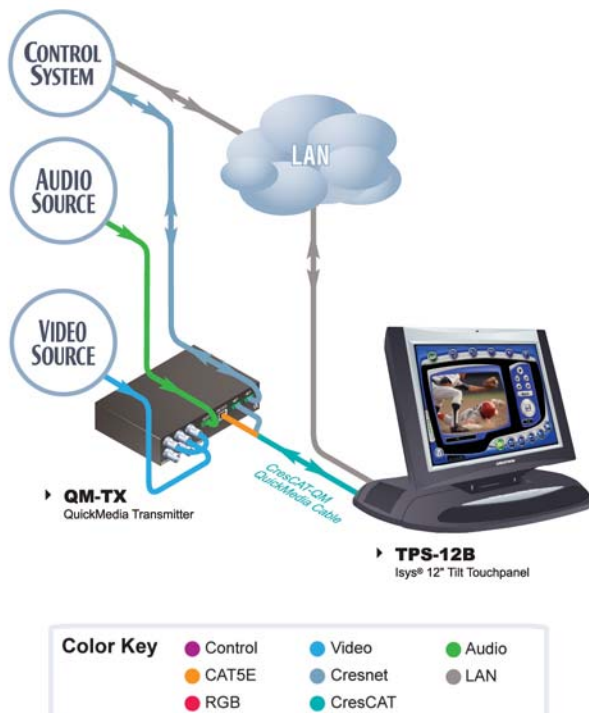

ISYS® TILT TOUCHPANELS

→ Isys® Tilt Touchpanels

Isys® 12" Tilt Touchpanel **TPS-12B/TPS-12W**

TPS-12B in a CH CAT5 AV Distribution System

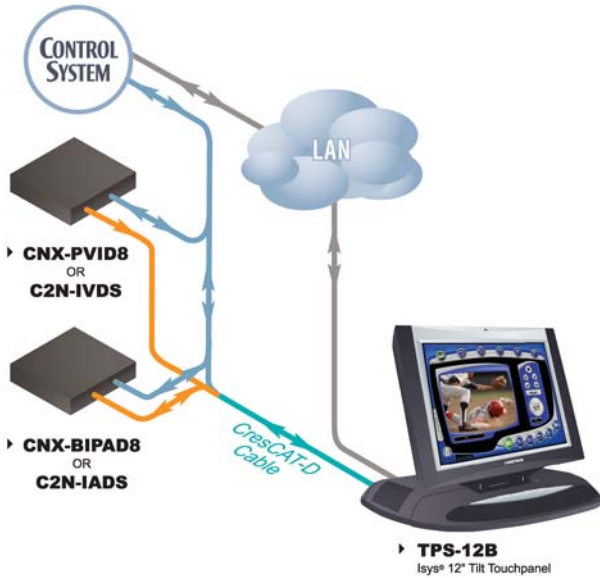

Color Key		
Control	Video	Audio
CAT5E	Cresnet	LAN
RGB	CresCAT	

tilt touchpanels

AVAILABLE ACCESSORIES

- | | | | |
|--|---|--|--|
| ▶ TPMC-CH-IMW
CAT5 Balanced AV
Interface Wall Plate | ▶ QM-TX
QuickMedia Transmitter | ▶ ST-PK
Programming Cable Kit | ▶ CresCAT®QM
QuickMedia™ Cable |
| ▶ TPS/TPMC-CBL-T
Triamese Interface Cables | ▶ SMK-12/15/17
Swivel Mount Kit | ▶ CresCAT®D
Crestron Home® CAT5
Balanced AV Cable | ▶ CresCAT®IM
iMedia Cable |

ISYS® TILT TOUCHPANELS

→ Isys® Tilt Touchpanels

TPS-4000 Isys® 10.4" Tilt Touchpanel



The Isys TPS-4000 presents a stylish state-of-the-art touchpanel solution complete with integrated video and audio. A vibrant 640 x 480 10.4" touchscreen display delivers exceptional graphical performance to support a host of control applications.

Crestron touchpanels offer an ideal user-interface for multimedia presentation, videoconferencing, lighting, climate control, and much more, providing a wide-open canvas for the creation of custom control screens perfectly tailored to the needs of the end-user. Touchpanels do away with piles of remote controls, cryptic front panels, and cluttered wall switches, affording true "one-touch" control over a broad range of complex devices and systems.

Isys®—Isys power and beauty are infused throughout Crestron's entire touchpanel lineup. Under the hood, the Isys engine produces astonishing full-color graphics with lightning-fast performance and incredible versatility. A 32-bit Freescale ColdFire® Microprocessor combines with an ingenious and ultra efficient operating system to support high-resolution graphics and images, dynamic text, full-motion video, animations, multimode objects (buttons, frames, gauges, and sliders), popup/dropdown subpages, and more.

Synapse™—Crestron's exclusive Synapse Image Rendering Algorithm enables system programmers to produce amazing graphics - faster and easier. Advanced antialiasing delivers crisper, sharper objects and text. Enhanced 3D effects add new depth and style. And because Synapse is native to the touchpanel, memory requirements and upload time are substantially reduced.

Video with Advanced Gamma Correction—

Video capability is standard in the TPS-4000, accepting any NTSC/PAL composite or S-Video source, scalable for display in any sized window or full screen. Advanced gamma correction and built-in time base correction ensure accurate color reproduction and a jitter-free image.

Built-in Audio—Audio features include built-in amplified stereo speakers, volume control, line-level stereo input, and a microphone with automatic gain control and line-level output. The speakers may be used to amplify signals from TV and video sources, or to support programmable intercom functionality in combination with the microphone. Customized WAV files can be loaded on the touchpanel to add dimension to the touchscreen graphics with personalized sounds, button feedback, and voice prompts.

Cresnet®—Cresnet communication ensures compatibility with Crestron's complete product line.

Tiltcase Design—The TPS-4000 features an ergonomic tiltcase design that is easily adjustable for any angle of inclination between 30 and 80 degrees. Numerous versatile wiring and mounting options are also available.

- ▶ 10.4" Active Matrix Touchscreen Display
- ▶ 640 x 480 Resolution
- ▶ Isys Graphics Engine
- ▶ Synapse Image Rendering Algorithm
- ▶ High-Performance Video with Gamma Correction
- ▶ Built-in Amplified Speakers and Microphone
- ▶ Cresnet Communications
- ▶ Versatile Tiltcase Design

SPECIFICATIONS

Touchscreen Display

Display Type: TFT Active matrix color LCD
Size: 10.4 inch (26.4 cm) diagonal
Aspect Ratio: 4:3 VGA
Resolution: 640 x 480 pixels
Brightness: 450 nits (cd/m²)
Contrast: 600:1
Color Depth: 18-bit, 256k colors
Illumination: Edgelit fluorescent
Viewing Angle: ±70° horizontal, +45°/-55° vertical
Touchscreen: Resistive membrane

Processor

CPU: 32-bit Freescale ColdFire® Microprocessor

ISYS® TILT TOUCHPANELS

→ Isys® Tilt Touchpanels

Isys® 10.4" Tilt Touchpanel **TPS-4000**

Memory

DRAM: 8 MB

Flash: 8 MB

Maximum Project Size: 7 MB

Graphic Engine

Isys engine, 16-bit non-palette graphics; 65,536 colors; Synapse image rendering algorithm; multi-mode objects, color key video windowing

Video

Signal Types: Auto-detecting composite/S-Video

Formats: NTSC 480i or PAL 576i

Color Depth: 18-bit; 262,144 colors

Features: Single-window scalable to full-screen, time base correction, gamma correction

Audio

Hardware Features: Built-in microphone with defeatable AGC, built-in amplified stereo speakers, headphone output, internal volume control and audio mixer

Audio Feedback (WAV): 8-bit PCM, mono, 8 kHz sampling rate

Amplification: 2 Watts per channel for built-in stereo speakers

Connectors

NET/VIDEO: (1) 10-pin RJ45 female, shielded

Connects to interface module via 15 foot "siamese" cable provided
Contains Cresnet data, 24 Volts DC power, ground, and video signals

AUDIO: (1) 8-pin RJ45 female, shielded

Connects to interface module via 15 foot "siamese" cable provided
Contains stereo audio input and mic out signals

RS-232: (1) 6-pin RJ11 female

Serial connection to PC for loading screen files

Touchscreen output to PC or Telestrator

Bidirectional RS-232 up to 115.2k baud

Hardware and software handshaking support

HEADPHONES: (1) 3.5 mm TRS mini phone jack

Connects to stereo headphones (not included)

Output Power: 12mW

Minimum Impedance: 32 ohms

Power Requirements

22 Watts (0.92 Amp @ 24 Volts DC)

PW-2420RU power supply sold separately

Cresnet Power Usage: 22 Watts (0.92 Amp @ 24 Volts DC)

If power is applied to the 24VDC jack and the NET port (on TPS-IMPC) simultaneously, power will be drawn from whichever is highest.

Environmental

Temperature: 50° to 113°F (10° to 45°C)

Humidity: 10% to 90% RH (non-condensing)

Enclosure

Construction: High impact black/silver injection-molded case

Screen Tilt: Adjustable 30 to 80 degrees

Dimensions

Height: 10.03 in (25.48 cm)

Width: 10.96 in (27.83 cm)

Depth: 9.32 in (23.67 cm)

Weight

4.66 lbs (2.11 kg)

INCLUDED ACCESSORIES

TPS-IMPC

Interface Module + 15 ft siamese cable

(See TPS-IMPC specifications for complete information)

TPS-4000 in a CH CAT5 AV Distribution System

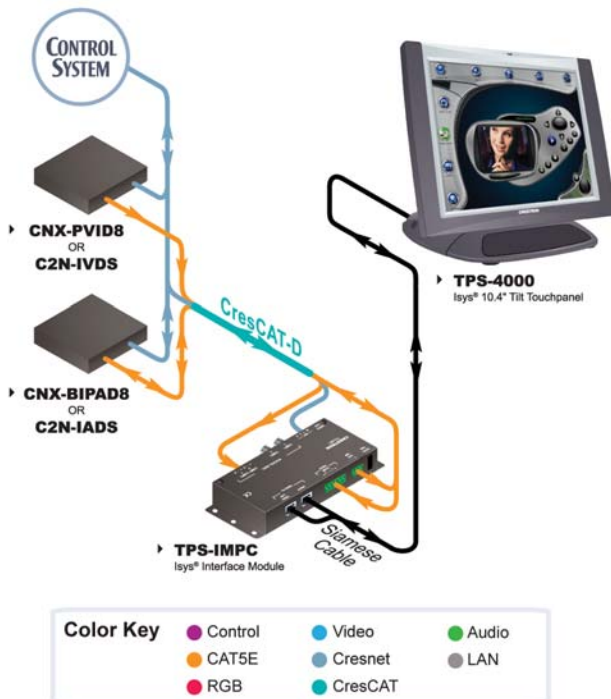

tilt touchpanels

> continued

ISYS® TILT TOUCHPANELS

→ Isys® Tilt Touchpanels

TPS-4000 Isys® 10.4" Tilt Touchpanel (continued)

TPS-4000 using conventional AV sources

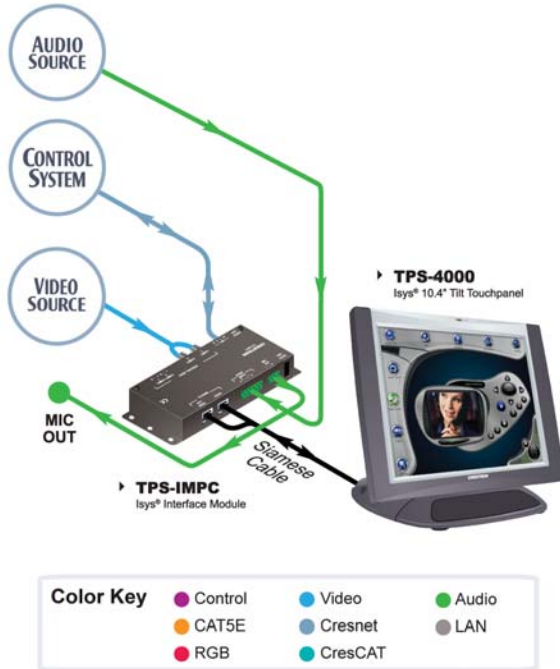

tilt touchpanels

AVAILABLE ACCESSORIES

- | | | | |
|---|--|--|--|
| ▶ PW-2420RU
50 Watt Regulated
Universal Power Supply | ▶ TPS-IMW
Wall Mount Interface Module | ▶ TPS-CBL
Interface Cable | ▶ ST-PK
Programming Cable Kit |
| ▶ HBK-3000
Hatchback Rear Cover | ▶ TPS-4500IMPC
Interface Module without Audio | ▶ TPS-CBL-S
Siamese Interface Cable | ▶ CresCAT®D
Crestron Home® CAT5
Balanced AV Cable |
| ▶ SMK-3000
Swivel Mount Kit
(includes HBK-3000) | ▶ TPS-4500IMW
Wall Mount Interface
Module without Audio | ▶ TPSBLOCK-10
Panel Mount 10-pin
Connector Solution | |

Isys® 6.4" Tilt Touchpanel **TPS-3000**

The Isys TPS-3000 presents a stylish state-of-the-art touchpanel solution complete with integrated video and audio. A vibrant 640 x 480 6.4" touchscreen display delivers exceptional graphical performance to support a host of control applications.

Crestron touchpanels offer an ideal user-interface for multimedia presentation, videoconferencing, lighting, climate control, and much more, providing a wide-open canvas for the creation of custom control screens perfectly tailored to the needs of the end-user. Touchpanels do away with piles of remote controls, cryptic front panels, and cluttered wall switches, affording true "one-touch" control over a broad range of complex devices and systems.

Isys®—Isys power and beauty are infused throughout Crestron's entire touchpanel lineup. Under the hood, the Isys engine produces astonishing full-color graphics with lightning-fast performance and incredible versatility. A 32-bit Freescale ColdFire® Microprocessor combines with an ingenious and ultra efficient operating system to support high-resolution graphics and images, dynamic text, full-motion video, animations, multimode objects (buttons, frames, gauges, and sliders), popup/dropdown subpages, and more.

Synapse™—Crestron's exclusive Synapse Image Rendering Algorithm enables system programmers to produce amazing graphics - faster and easier. Advanced antialiasing delivers crisper, sharper objects and text. Enhanced 3D effects add new depth and style. And because Synapse is native to the touchpanel, memory requirements and upload time are substantially reduced.

Video with Advanced Gamma Correction—

Video capability is standard in the TPS-3000, accepting any NTSC/PAL composite or S-Video source, scalable for display in any sized window or full screen. Advanced gamma correction and built-in time base correction ensure accurate color reproduction and a jitter-free image.

Built-in Audio—Audio features include built-in amplified stereo speakers, volume control, line-level stereo input, and a microphone with automatic gain control and line-level output. The speakers may be used to amplify signals from TV and video sources, or to support programmable intercom functionality in combination with the microphone. Customized WAV files can be loaded on the touchpanel to add dimension to the touchscreen graphics and pushbuttons with personalized sounds, button feedback, and voice prompts.



Cresnet®—Cresnet communication ensures compatibility with Crestron's complete product line.

Tiltcase Design—The TPS-3000 features an ergonomic tiltcase design that is easily adjustable for any angle of inclination between 30 and 80 degrees. Numerous versatile wiring and mounting options are also available.

- ▶ [6.4" Active Matrix Touchscreen Display](#)
- ▶ [640 x 480 Resolution](#)
- ▶ [Isys Graphics Engine](#)
- ▶ [Synapse Image Rendering Algorithm](#)
- ▶ [High-Performance Video with Gamma Correction](#)
- ▶ [Built-in Amplified Speakers and Microphone](#)
- ▶ [Cresnet Communications](#)
- ▶ [Versatile Tiltcase Design](#)

SPECIFICATIONS

Touchscreen Display

Display Type: TFT Active matrix color LCD
Size: 6.4 inch (16.3 cm) diagonal
Aspect Ratio: 4:3 VGA
Resolution: 640 x 480 pixels
Brightness: 400 nits (cd/m²)
Contrast: 250:1
Color Depth: 18-bit, 256k colors
Illumination: Edgelit fluorescent
Viewing Angle: ±60° horizontal, +40°/-55° vertical
Touchscreen: Resistive membrane

Processor

CPU: 32-bit Freescale ColdFire® Microprocessor

> continued

ISYS® TILT TOUCHPANELS

→ Isys® Tilt Touchpanels

TPS-3000 Isys® 6.4" Tilt Touchpanel (continued)

Memory

DRAM: 8MB
Flash: 8MB
Maximum Project Size: 7MB

Graphic Engine

Isys engine, 16-bit non-palette graphics; 65,536 colors; Synapse image rendering algorithm; multi-mode objects, color key video windowing

Video

Signal Types: Auto-detecting composite/S-Video
Formats: NTSC 480i or PAL 576i
Color Depth: 18-bit; 262,144 colors
Features: Single-window scalable to full-screen, time base correction, gamma correction

Audio

Hardware Features: Built-in microphone with defeatable AGC, built-in amplified stereo speakers, headphone output, internal volume control and audio mixer
Audio Feedback (WAV): 8-bit PCM, mono, 8 kHz sampling rate
Amplification: 2 Watts per channel for built-in stereo speakers

Connectors

NET/VIDEO: (1) 10-pin RJ45 female, shielded
Connects to interface module via 15 foot "siamese" cable provided
Contains Cresnet data, 24 Volts DC power, ground, and video signals

AUDIO: (1) 8-pin RJ45 female, shielded
Connects to interface module via 15 foot "siamese" cable provided
Contains stereo audio input and mic out signals

RS-232: (1) 6-pin RJ11 female
Serial connection to PC for loading screen files
Touchscreen output to PC or Telestrator
Bidirectional RS-232 up to 115.2k baud
Hardware and software handshaking support

HEADPHONES: (1) 3.5 mm TRS mini phone jack
Connects to stereo headphones (not included)
Output Power: 12mW
Minimum Impedance: 32 ohms

Power Requirements

22 Watts (0.92 Amp @ 24 Volts DC)
PW-2420RU power supply sold separately

Cresnet Power Usage: 22 Watts (0.92 Amp @ 24 Volts DC)
If power is applied to the 24VDC jack and the NET port (on TPS-IMPC) simultaneously, power will be drawn from whichever is highest.

Environmental

Temperature: 50° to 113°F (10° to 45°C)
Humidity: 10% to 90% RH (non-condensing)

Enclosure

Construction: High impact black/silver injection-molded case
Screen Tilt: Adjustable 30 to 80 degrees

Dimensions

Height: 7.56 in (19.20 cm)
Width: 8.40 in (21.34 cm)
Depth: 7.27 in (18.47 cm)

Weight

3.44 lbs (1.56 kg)

INCLUDED ACCESSORIES

TPS-IMPC
Interface Module + 15 ft siamese cable
(See TPS-IMPC specifications for complete information)

tilt touchpanels

TPS-3000 in a CH CAT5 AV Distribution System

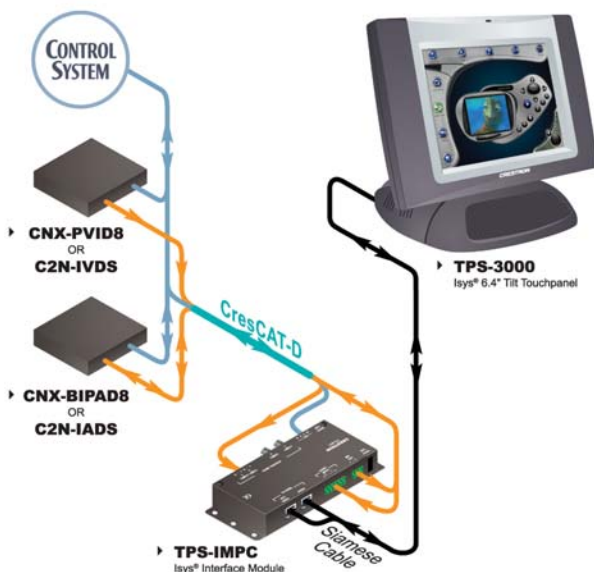

Color Key		
Control	Video	Audio
CAT5E	Cresnet	LAN
RGB	CresCAT	

ISYS® TILT TOUCHPANELS

→ Isys® Tilt Touchpanels

Isys® 6.4" Tilt Touchpanel **TPS-3000**

TPS-3000 using conventional AV sources

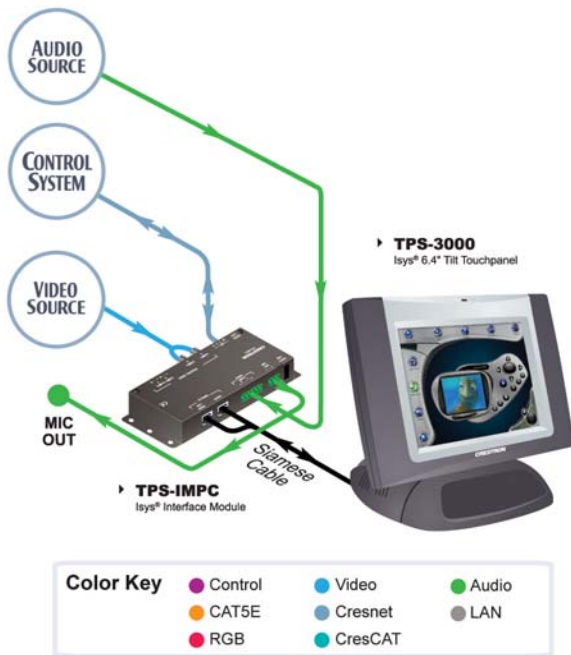

tilt touchpanels

AVAILABLE ACCESSORIES

- | | | | |
|---|--|--|--|
| ▶ PW-2420RU
50 Watt Regulated
Universal Power Supply | ▶ TPS-IMW
Wall Mount Interface Module | ▶ TPS-CBL
Interface Cable | ▶ ST-PK
Programming Cable Kit |
| ▶ HBK-3000
Hatchback Rear Cover | ▶ TPS-4500IMPC
Interface Module
without Audio | ▶ TPS-CBL-S
Siamese Interface Cable | ▶ CresCAT®D
Crestron Home® CAT5
Balanced AV Cable |
| ▶ SMK-3000
Swivel Mount Kit
(includes HBK-3000) | ▶ TPS-4500IMW
Wall Mount Interface
Module without Audio | ▶ TPSBLOCK-10
Panel Mount 10-pin
Connector Solution | |

ISYS® TILT TOUCHPANELS

→ Isys® G-Series Tilt Touchpanels

TPS-15G-QM Isys® G-Series 15" Tilt Touchpanel w/QuickMedia™



Dual-Window HD Video and RGB²—The TPS-15G-QM can simultaneously display two fully-scalable, full-motion video windows, each supporting standard video, HDTV, and high-resolution RGB signals from external AV and computer sources. Discrete video scalers with motion adaptive deinterlacing bring out the highest detail, minimizing visible scan lines and motion artifacts for a truly remarkable picture. Advanced gamma correction and built-in time base correction ensure accurate color reproduction and a jitter-free image.

Touch-the-PC—Crestron's exclusive "Touch-the-PC" technology allows real-time touchpanel navigation of any Windows PC through a direct high-speed serial connection.

Built-in Annotation—Built-in annotation capability allows presenters to write or draw over computer and video images on the touchscreen using a finger or stylus, and output the image live for audience display.

High-Quality Audio²—The high-powered bi-amplified speaker system provides amplification for external AV sources, and supports intercom functionality in combination with the integrated microphone. Customized WAV files can be loaded on the touchpanel to add dimension to the touchscreen graphics with personalized sounds, button feedback, and voice prompts.

QuickMedia™—All audio and video connections are facilitated using Crestron's revolutionary QuickMedia transport, providing a flexible yet remarkably simple wiring solution. Through QuickMedia (QM), the TPS-15G-QM interfaces directly with other QM-based products using inexpensive CAT5e type cable.

The two QM Input ports each support non-interlaced RGB up to 1600 X 1200 pixels, as well as composite, S-Video, and component video signals. QM Input #1 includes software-adjustable compensation for cable runs up to 450 feet; Input #2 allows up to 300 feet for video and HDTV, and shorter distances for RGB computer signals. Both QM Inputs receive audio signals from external microphone and stereo line level sources.

The QM Output port allows RGB output of the touchpanel screen image to feed a display device for audience presentation. A 24-bit digital audio signal is also present for distribution of the internal microphone signal.

High-Speed Connectivity—Both Cresnet and high-speed Ethernet are standard on the TPS-15G-QM, providing for easy network integration and seamless communications with Crestron control systems. USB connectivity is also

Crestron's Isys G-Series touchpanels deliver a higher level of performance with dual-window video, RGB, and HDTV display to meet the demands of today's sophisticated control and automation applications. Incorporating modern styling in a versatile tiltcase design, the Isys TPS-15G-QM features a spectacular 15" XGA display offering a wide viewing angle with exceptional brightness and contrast for stunning control graphics, high-resolution images, and full-motion HD video.

Crestron touchpanels offer an ideal user-interface for multimedia presentation, videoconferencing, home automation, and much more, providing a wide-open canvas for the creation of custom control screens tailored to the needs of the end-user. Touchpanels do away with piles of remote controls, cryptic control panels and cluttered wall switches, simultaneously expanding and simplifying control over a broad range of complex devices and systems.

Isys®—Isys power and beauty are infused throughout Crestron's entire touchpanel lineup. Under the hood, the TPS-15G-QM offers vibrant 24-bit color depth with 8-bit alpha channel transparency to produce incredible 3D graphics and high-res images. The Isys engine supports dynamic graphics and text, full-motion animations, multimode objects, and PNG translucency – all with astonishing speed.

Synapse™—Crestron's exclusive Synapse Image Rendering Algorithm enables system programmers to produce amazing graphics - faster and easier. Advanced antialiasing delivers crisper, sharper objects and text. Enhanced 3D effects add new depth and style. And because Synapse is native to the touchpanel, memory requirements and upload time are substantially reduced.

ISYS® TILT TOUCHPANELS

→ Isys® G-Series Tilt Touchpanels

Isys® G-Series 15" Tilt Touchpanel w/QuickMedia™ **TPS-15G-QM**

included for connection of an external mouse, touchscreen, or similar pointing device¹.

Functional Tiltcase Design—The stylish tiltcase housing allows smooth tilt adjustment from 45 to 90 degrees, and features an integral cable strain relief system and rear cover to secure and hide the connections at the back of the touchpanel. Five backlit pushbuttons are also provided, allowing for quick access to commonly used functions.

- ▶ 15" active matrix touchscreen display | 1024 x 768 resolution
- ▶ 24-Bit Isys graphics | Synapse image rendering algorithm
- ▶ Dual-window full-motion video, HDTV and RGB display²
- ▶ Built-in biamplified speaker system and microphone²
- ▶ QuickMedia AV connectivity | audience presentation output²
- ▶ High-speed Ethernet and Cresnet communications
- ▶ Tiltcase housing with integral rear cover and cable strain relief
- ▶ Built-in real-time annotation
- ▶ Backlit "Softkey" pushbuttons

TPS-15G-QM using a single QuickMedia Transmitter



SPECIFICATIONS

Touchscreen Display

Display Type: TFT Active matrix color LCD
Size: 15 inch (38.1 cm) diagonal
Aspect Ratio: 4:3 XGA
Resolution: 1024 x 768 pixels
Brightness: 350 nits (cd/m²)
Contrast: 700:1
Color Depth: 24-bit, 16.7M colors
Illumination: Backlit fluorescent
Viewing Angle: ±85° horizontal, ±85° vertical
Touchscreen: Resistive membrane

Processor

CPU: 32-bit Freescale ColdFire® Microprocessor

Memory

DDR RAM: 128 MB
Flash: 64 MB
Compact Flash: Accepts up to 4GB Type II CF (not included)
Maximum Project Size: 160 MB

Graphic Engine

Isys engine, 24-bit non-palette graphics + 8-bit alpha channel transparency, 16.7 million colors, Synapse image rendering algorithm, multi-mode objects, dynamic graphics, PNG translucency, full-motion (60 fps) animation, transition effects, color key video windowing

Ethernet

10BaseT/100BaseTX, auto-switching, auto-negotiating, full/half duplex, TCP/IP, UDP/IP, CIP, IEEE 802.3U compliant

Video/RGB²

Signal Types: RGB and auto-detecting composite, S-Video, or component video
Formats: SDTV 480i (NTSC) & 576i (PAL), EDTV 480p & 576p, HDTV 720p & 1080i; RGB(VGA) up to UXGA 1600 x 1200
Color Depth: 24-bit, 16.7M colors
Features: Dual-window each scalable to full-screen, time base correction, gamma correction, line doubling, motion adaptive deinterlacing, reverse 3:2/2:2 pulldown

Audio²

Hardware Features: Built-in microphone and biamplified speakers, stereo headphone output, internal volume control and audio mixer
Audio Feedback (WAV): 8-bit PCM, mono, 8 kHz sampling rate
D-A Conversion (QM): 24-bit, 48 kHz
Amplification: Bi-amplified, mono, 5 Watts for high-frequency, 5 Watts for low-frequency

Buttons

- (4) Backlit "softkey" buttons, programmable
- (1) Backlit hard reset button, reboots the touchpanel

> continued

tilt touchpanels

TPS-15G-QM Isys® G-Series 15" Tilt Touchpanel w/QuickMedia™ (continued)

Connectors

QM IN 1: (1) 8-wire RJ45 female, QuickMedia input port
Signal Types: Dynamically configurable under system control as:
(1) RGB input with stereo program audio and (2) mic channels, or
(1) Auto-detecting component (YPbPr), S-Video (Y/C),
or composite video input with stereo program audio
and (2) mic channels;

RGB Format: RGBHV

RGB Input Resolution, Non-interlaced: 640 x 480 minimum to 1600 x 1200 maximum (60 Hz limit at 1600 x 1200);

Video/HDTV Formats: 480i (NTSC), 576i (PAL), 480p, 576p, 720p and 1080i;

Horizontal Frequency: 15 to 100 kHz

Vertical Frequency: 50 to 85 Hz

Delay Skew Compensation: 0 - 22 nS

Connects to QM output port of a QM-TX or other QuickMedia device via CresCAT-QM or CresCAT-IM cable;

Maximum Cable Length: 450 ft (aggregate distance from QM origination)

QM IN 2: (1) 8-wire RJ45 female, QuickMedia input port
Signal Types: Dynamically configurable under system control as:
(1) RGB input with stereo program audio and (2) mic channels, or
(1) Auto-detecting component (YPbPr), S-Video (Y/C),
or composite video input with stereo program audio
and (2) mic channels;

RGB Format: RGBHV

RGB Input Resolution, Non-interlaced: 640 x 480 minimum to 1600 x 1200 maximum (60 Hz limit at 1600 x 1200);

Video/HDTV Formats: 480i (NTSC), 576i (PAL), 480p, 576p, 720p and 1080i;

Horizontal Frequency: 15 to 100 kHz

Vertical Frequency: 50 to 85 Hz

Delay Skew Compensation: none

Connects to QM output port of a QM-TX or other QuickMedia device via CresCAT-QM or CresCAT-IM cable;

Maximum Cable Length (Video/HDTV): 300 ft (aggregate distance from QM origination);

Maximum Cable Length (RGB @ 60Hz): 216 ft for 640x480, 140 ft for 800x600, 84 ft for 1024x768, 70 ft for 1280x768, 30 ft for 1600x1200 (using CresCAT-QM or CresCAT-IM cable)

QM OUT 1: (1) 8-wire RJ45 female, QuickMedia output port containing RGB (same as touchscreen), WAV file audio, and internal microphone signals;

RGB Format: RGBHV

RGB Output Resolution, Non-interlaced: 1024 x 768 pixels @ 60Hz

Connects to QM input port of any QuickMedia device via CresCAT-QM or CresCAT-IM cable

HEADPHONES: (1) 3.5 mm TRS mini phone jack

Output Power: 12mW per channel

Minimum Impedance: 32 ohms

RS-232: (1) 6-pin RJ11 female

Computer console, touch output, or mouse/touch input port¹

Bidirectional RS-232 up to 115.2k baud

Hardware and software handshaking support

LAN: (1) 8-wire RJ45 with 2 LED indicators

10BaseT/100BaseTX Ethernet port

Green LED indicates link status

Yellow LED indicates Ethernet activity

24VDC: (1) 2.1mm barrel DC power jack

Do not use

NET: (1) 4-pin 3.5mm detachable terminal block

Cresnet Slave Port, connects to Cresnet control network

USB: (2) USB Type A female

USB 1.1 ports for mouse or touchscreen input¹

GND: (1) 6-32 screw, chassis ground lug

MEMORY EXP.: (1) Type II Compact Flash card slot for memory expansion

PC CARD A - B: (2) Type II PC Card slots (reserved for future applications)¹

Power Requirements

Cresnet Power Usage: 75 Watts (3.13 Amps @ 24 Volts DC)

Note: The 24VDC power jack should not be used.

Environmental

Temperature: 41° to 113°F (5° to 45°C)

Humidity: 10% to 90% RH (non-condensing)

Enclosure

Construction: High impact black/silver injection-molded case, tilt screen with adjustable tension, integral rear cover and cable strain relief in base

Screen Tilt: Adjustable 45 to 90 degrees

Dimensions

Height: 14.17 in (36.00 cm)

Width: 14.94 in (37.95 cm)

Depth: 13.75 in (34.93 cm)

Weight

15.2 lbs (6.9 kg)

¹ See Web site or contact Crestron for a current list of compatible devices.

² One or more QuickMedia devices are required to facilitate the input and output of audio, video, and RGB signals. See the "MediaManager" section of this catalog or visit the Crestron Website for more information about QuickMedia.

ISYS® TILT TOUCHPANELS

► Isys® G-Series Tilt Touchpanels

Isys® G-Series 15" Tilt Touchpanel w/QuickMedia™ **TPS-15G-QM**

TPS-15G-QM in a QuickMedia system

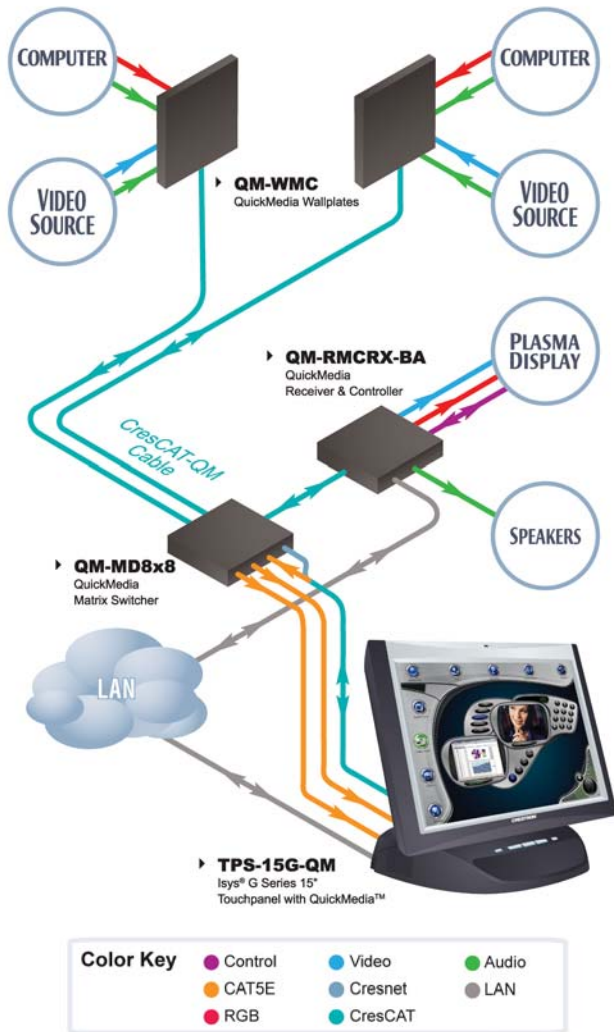

tilt touchpanels

AVAILABLE ACCESSORIES

- ▶ QM-TX QuickMedia Transmitter
- ▶ SMK-12/15/17 Swivel Mount Kit
- ▶ CresCAT®QM QuickMedia™ Cable
- ▶ CresCAT®IM iMedia Cable
- ▶ TPS/TPMC-CBL-T Triamase Interface Cables
- ▶ ST-PK Programming Cable Kit

ISYS® TILT TOUCHPANELS

→ Isys® G-Series Tilt Touchpanels

TPS-12G-QM Isys® G-Series 12" Tilt Touchpanel w/QuickMedia™



Dual-Window HD Video and RGB²—The TPS-12G-QM can simultaneously display two fully-scalable, full-motion video windows, each supporting standard video, HDTV, and high-resolution RGB signals from external AV and computer sources. Discrete video scalers with motion adaptive deinterlacing bring out the highest detail, minimizing visible scan lines and motion artifacts for a truly remarkable picture. Advanced gamma correction and built-in time base correction ensure accurate color reproduction and a jitter-free image.

Touch-the-PC—Crestron's exclusive "Touch-the-PC" technology allows real-time touchpanel navigation of any Windows PC through a direct high-speed serial connection.

Built-in Annotation—Built-in annotation capability allows presenters to write or draw over computer and video images on the touchscreen using a finger or stylus, and output the image live for audience display.

High-Quality Audio²—The high-powered biamplified speaker system provides amplification for external AV sources, and supports intercom functionality in combination with the integrated microphone. Customized WAV files can be loaded on the touchpanel to add dimension to the touchscreen graphics with personalized sounds, button feedback, and voice prompts.

QuickMedia™—All audio and video connections are facilitated using Crestron's revolutionary QuickMedia transport, providing a flexible yet remarkably simple wiring solution. Through QuickMedia (QM), the TPS-12G-QM interfaces directly with other QM-based products using inexpensive CAT5e type cable.

The two QM Input ports each support non-interlaced RGB up to 1600 X 1200 pixels, as well as composite, S-Video, and component video signals. QM Input #1 includes software-adjustable compensation for cable runs up to 450 feet; Input #2 allows up to 300 feet for video and HDTV, and shorter distances for RGB computer signals. Both QM Inputs receive audio signals from external microphone and stereo line level sources.

The QM Output port allows RGB output of the touchpanel screen image to feed a display device for audience presentation. A 24-bit digital audio signal is also present for distribution of the internal microphone signal.

High-Speed Connectivity—Both Cresnet and high-speed Ethernet are standard on the TPS-12G-QM, providing for easy network integration and seamless communications

Crestron's Isys G-Series touchpanels deliver a higher level of performance with dual-window video, RGB, and HDTV display to meet the demands of today's sophisticated control and automation applications. Incorporating modern styling in a versatile tiltcase design, the Isys TPS-12G-QM features a spectacular 12" SVGA display offering a wide viewing angle with exceptional brightness and contrast for stunning control graphics, high-resolution images, and full-motion HD video.

Crestron touchpanels offer an ideal user-interface for multimedia presentation, videoconferencing, home automation, and much more, providing a wide-open canvas for the creation of custom control screens tailored to the needs of the end-user. Touchpanels do away with piles of remote controls, cryptic control panels and cluttered wall switches, simultaneously expanding and simplifying control over a broad range of complex devices and systems.

Isys®—Isys power and beauty are infused throughout Crestron's entire touchpanel lineup. Under the hood, the TPS-12G-QM offers vibrant 24-bit color depth with 8-bit alpha channel transparency to produce incredible 3D graphics and high-res images. The Isys engine supports dynamic graphics and text, full-motion animations, multimode objects, and PNG translucency – all with astonishing speed.

Synapse™—Crestron's exclusive Synapse Image Rendering Algorithm enables system programmers to produce amazing graphics - faster and easier. Advanced antialiasing delivers crisper, sharper objects and text. Enhanced 3D effects add new depth and style. And because Synapse is native to the touchpanel, memory requirements and upload time are substantially reduced.

ISYS® TILT TOUCHPANELS

→ Isys® G-Series Tilt Touchpanels

Isys® G-Series 12" Tilt Touchpanel w/QuickMedia™ **TPS-12G-QM**

with Crestron control systems. USB connectivity is also included for connection of an external mouse, touchscreen, or similar pointing device¹.

Functional Tiltcase Design—The stylish tiltcase housing allows smooth tilt adjustment from 45 to 90 degrees, and features an integral cable strain relief system and rear cover to secure and hide the connections at the back of the touchpanel. Five backlit pushbuttons are also provided, allowing for quick access to commonly used functions.

- ▶ 12" active matrix touchscreen display | 800 x 600 resolution
- ▶ 24-Bit Isys graphics | Synapse image rendering algorithm
- ▶ Dual-window full-motion video, HDTV and RGB display²
- ▶ Built-in biamplified speaker system and microphone²
- ▶ QuickMedia AV connectivity | audience presentation output²
- ▶ High-speed Ethernet and Cresnet communications
- ▶ Tiltcase housing with integral rear cover and cable strain relief
- ▶ Built-in real-time annotation
- ▶ Backlit "Softkey" pushbuttons

TPS-12G-QM using a single QuickMedia Transmitter



SPECIFICATIONS

Touchscreen Display

Display Type: TFT Active matrix color LCD
Size: 12 inch (30.5 cm) diagonal
Aspect Ratio: 4:3 SVGA
Resolution: 800 x 600 pixels
Brightness: 400 nits (cd/m²)
Contrast: 300:1
Color Depth: 18-bit, 256k colors
Illumination: Backlit fluorescent
Viewing Angle: ±70° horizontal, +45/-55° vertical
Touchscreen: Resistive membrane

Processor

CPU: 32-bit Freescale ColdFire® Microprocessor

Memory

DDR RAM: 128 MB
Flash: 64 MB
Compact Flash: Accepts up to 4GB Type II CF (not included)
Maximum Project Size: 160 MB

Graphic Engine

Isys engine, 24-bit non-palette graphics + 8-bit alpha channel transparency, 16.7 million colors, Synapse image rendering algorithm, multi-mode objects, dynamic graphics, PNG translucency, full-motion (60 fps) animation, transition effects, color key video windowing

Ethernet

10BaseT/100BaseTX, auto-switching, auto-negotiating, full/half duplex, TCP/IP, UDP/IP, CIP, IEEE 802.3U compliant

Video/RGB²

Signal Types: RGB and auto-detecting composite, S-Video, or component video
Formats: SDTV 480i (NTSC) & 576i (PAL), EDTV 480p & 576p, HDTV 720p & 1080i; RGB(VGA) up to UXGA 1600 x 1200
Color Depth: 24-bit, 16.7M colors
Features: Dual-window each scalable to full-screen, time base correction, gamma correction, line doubling, motion adaptive deinterlacing, reverse 3:2/2:2 pulldown

Audio²

Hardware Features: Built-in microphone and biamplified speakers, stereo headphone output, internal volume control and audio mixer
Audio Feedback (WAV): 8-bit PCM, mono, 8 kHz sampling rate
D-A Conversion (QM): 24-bit, 48 kHz
Amplification: Bi-amplified, mono, 5 Watts for high-frequency, 5 Watts for low-frequency

Buttons

(4) Backlit "softkey" buttons, programmable
(1) Backlit hard reset button, reboots the touchpanel

> continued

tilt touchpanels

TPS-12G-QM Isys® G-Series 12" Tilt Touchpanel w/QuickMedia™ (continued)

Connectors

QM IN 1: (1) 8-wire RJ45 female, QuickMedia input port
Signal Types: Dynamically configurable under system control as:
(1) RGB input with stereo program audio and (2) mic channels, or
(1) Auto-detecting component (YPbPr), S-Video (Y/C),
or composite video input with stereo program audio
and (2) mic channels;

RGB Format: RGBHV

RGB Input Resolution, Non-interlaced: 640 x 480 minimum to 1600 x 1200 maximum (60 Hz limit at 1600 x 1200);

Video/HDTV Formats: 480i (NTSC), 576i (PAL), 480p, 576p, 720p and 1080i;

Horizontal Frequency: 15 to 100 kHz

Vertical Frequency: 50 to 85 Hz

Delay Skew Compensation: 0 - 22 nS

Connects to QM output port of a QM-TX or other QuickMedia device via CresCAT-QM or CresCAT-IM cable;

Maximum Cable Length: 450 ft (aggregate distance from QM origination)

QM IN 2: (1) 8-wire RJ45 female, QuickMedia input port
Signal Types: Dynamically configurable under system control as:
(1) RGB input with stereo program audio and (2) mic channels, or
(1) Auto-detecting component (YPbPr), S-Video (Y/C),
or composite video input with stereo program audio
and (2) mic channels

RGB Format: RGBHV

RGB Input Resolution, Non-interlaced: 640 x 480 minimum to 1600 x 1200 maximum (60 Hz limit at 1600 x 1200);

Video/HDTV Formats: 480i (NTSC), 576i (PAL), 480p, 576p, 720p and 1080i;

Horizontal Frequency: 15 to 100 kHz

Vertical Frequency: 50 to 85 Hz

Delay Skew Compensation: none

Connects to QM output port of a QM-TX or other QuickMedia device via CresCAT-QM or CresCAT-IM cable;

Maximum Cable Length (Video/HDTV): 300 ft (aggregate distance from QM origination);

Maximum Cable Length (RGB @ 60Hz): 216 ft for 640x480, 140 ft for 800x600, 84 ft for 1024x768, 70 ft for 1280x768, 30 ft for 1600x1200 (using CresCAT-QM or CresCAT-IM cable)

QM OUT 1: (1) 8-wire RJ45 female, QuickMedia output port containing RGB (same as touchscreen), WAV file audio, and internal microphone signals;

RGB Format: RGBHV

RGB Output Resolution, Non-interlaced: 800 x 600 pixels @ 60Hz

Connects to QM input port of any QuickMedia device via CresCAT-QM or CresCAT-IM cable

HEADPHONES: (1) 3.5 mm TRS mini phone jack

Output Power: 12mW per channel

Minimum Impedance: 32 ohms

RS-232: (1) 6-pin RJ11 female

Computer console, touch output, or mouse/touch input port¹

Bidirectional RS-232 up to 115.2k baud

Hardware and software handshaking support

LAN: (1) 8-wire RJ45 with 2 LED indicators

10BaseT/100BaseTX Ethernet port

Green LED indicates link status

Yellow LED indicates Ethernet activity

24VDC: (1) 2.1mm barrel DC power jack

24V DC power input (power supply sold separately)

NET: (1) 4-pin 3.5mm detachable terminal block

Cresnet Slave Port, connects to Cresnet control network

USB: (2) USB Type A female

USB 1.1 ports for mouse or touchscreen input¹

GND: (1) 6-32 screw, chassis ground lug

MEMORY EXP.: (1) Type II Compact Flash card slot for memory expansion

PC CARD A - B: (2) Type II PC Card slots (reserved for future applications)¹

Power Requirements

24VDC: 50 Watts (2.08 Amps) @ 24 Volts DC (PW-2420RU power supply sold separately)

Cresnet Power Usage: 50 Watts (2.08 Amps @ 24 Volts DC)

Note: Power should only be applied to the 24VDC power jack OR the NET port, not both.

Environmental

Temperature: 41° to 113°F (5° to 45°C)

Humidity: 10% to 90% RH (non-condensing)

Enclosure

Construction: High impact black/silver injection-molded case, tilt screen with adjustable tension, integral rear cover and cable strain relief in base

Screen Tilt: Adjustable 45 to 90 degrees

Dimensions

Height: 12.45 in (31.63 cm)

Width: 12.85 in (32.64 cm)

Depth: 13.75 in (34.93 cm)

Weight

13.8 lbs (6.2 kg)

¹ See Web site or contact Crestron for a current list of compatible devices.

² One or more QuickMedia devices are required to facilitate the input and output of audio, video, and RGB signals. See the "MediaManager" section of this catalog or visit the Crestron Website for more information about QuickMedia.

ISYS® TILT TOUCHPANELS

► Isys® G-Series Tilt Touchpanels

Isys® G-Series 12" Tilt Touchpanel w/QuickMedia™ **TPS-12G-QM**

TPS-12G-QM in a QuickMedia system

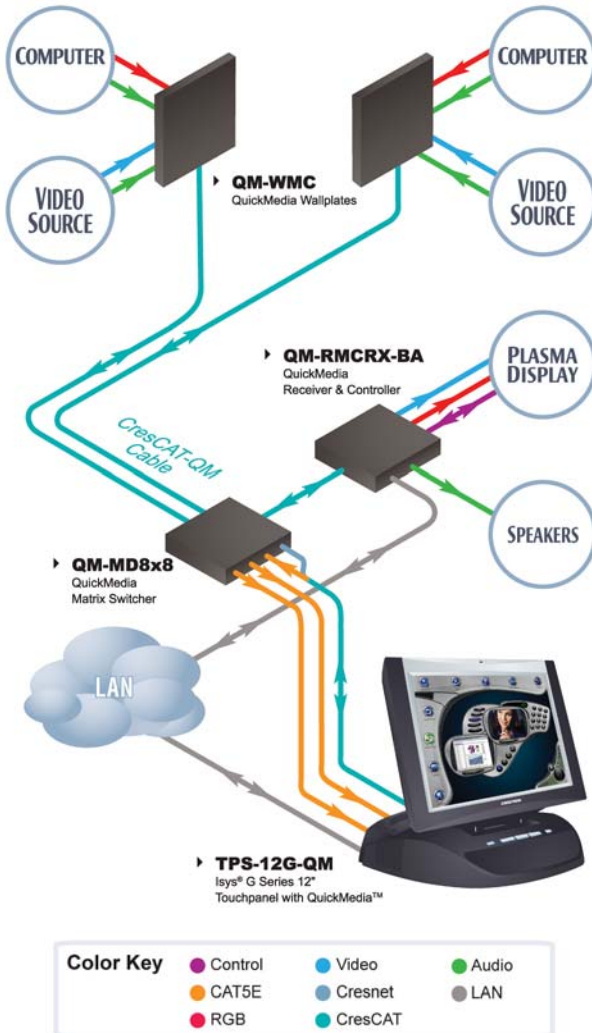

tilt touchpanels

AVAILABLE ACCESSORIES

- ▶ PW-2420RU Power Supply
- ▶ TPS/TPMC-CBL-T Triamase Interface Cables
- ▶ ST-PK Programming Cable Kit
- ▶ CresCAT®IM iMedia Cable
- ▶ QM-TX QuickMedia Transmitter
- ▶ SMK-12/15/17 Swivel Mount Kit
- ▶ CresCAT®QM QuickMedia™ Cable

ISYS® TILT TOUCHPANELS

► Isys i/O™ Tilt Touchpanel Media Centers

TPMC-17-QM Isys i/O™ 17" Tilt Touchpanel Media Center w/QuickMedia™



With built-in Windows Media® Player, RealPlayer®, and Internet Explorer, plus viewers for Word, Excel, PowerPoint®, and Adobe® Acrobat®, the TPMC-17-QM serves as a complete multimedia presentation source without necessitating a separate computer. You can also access data and run applications on other computers via Remote Desktop, and use NetMeeting® and Skype™ for interactive conferencing and voice-over-IP (VoIP) communications – right on the touchpanel. Plus, support for Yahoo! Widgets affords an easy solution for integrating everything from calendars and clocks to stock tickers, weather forecasts, news feeds, and thousands of other fun and useful utilities.

MediaMarker™ Annotation—Built-in annotation allows presenters to write or draw electronically on the touchscreen using a finger or stylus. Whether drawing freehand on a whiteboard screen, highlighting points on a spreadsheet, or making notes over motion video or still images, MediaMarker facilitates crystal clear visual communications.

Dual-Window HD Video and RGB²—In addition to its internal PC and streaming video applications, the TPMC-17-QM can also simultaneously display two fully-scalable, full-motion video windows. Each window supports standard video, HDTV, and high-resolution RGB signals from external AV and computer sources. Discrete video scalars with motion adaptive deinterlacing bring out the highest detail, minimizing visible scan lines and motion artifacts for a truly remarkable picture. Advanced gamma correction and built-in time base correction ensure accurate color reproduction and a jitter-free image.

High-Quality Audio²—An integrated microphone, bi-amplified speakers, stereo headphone output, and PC audio output are all built into the touchpanel to support full AV, intercom, desktop conferencing, and multimedia computer capabilities. Customized WAV files can be loaded on the touchpanel to add dimension to the touchscreen graphics with personalized sounds, button feedback, and voice prompts.

QuickMedia™—All audio and video connections are facilitated using Crestron's revolutionary QuickMedia transport, providing a flexible yet remarkably simple wiring solution. Through QuickMedia (QM), the TPMC-17-QM interfaces directly with other QM-based products using inexpensive CAT5e type cable.

The two QM Input ports each support non-interlaced RGB up to 1600 X 1200 pixels, as well as composite, S-Video, and component video signals. QM Input #1 includes software-

Isys i/O ingeniously integrates touchpanel control with embedded PC functionality, delivering a unified multimedia presentation solution. Incorporating modern styling in a versatile tiltcase design, the TPMC-17-QM Touchpanel Media Center features a spectacular 17" WXGA widescreen display offering an extra wide viewing angle with exceptional brightness and contrast for stunning control graphics, high-res images, embedded PC applications, and full-motion HD video.

Touchpanel Control and Presentation—In every sense, the TPMC-17-QM is a true Crestron touchpanel, offering vibrant 24-bit color depth with 8-bit alpha channel transparency to produce incredible 3D graphics using new dynamic menu objects, dynamic graphics, full-motion animations, multimode objects, PNG translucency, and exclusive Synapse™ image rendering – all with astonishing speed. But more than a touchpanel, the TPMC-17-QM is also a dynamic presentation source, outputting high-resolution graphics and audio to any sized audience via integrated QuickMedia transport technology.

Embedded PC—The power of Isys i/O is in its embedded PC engine, combining rock solid touchpanel performance with enhanced capabilities for surfing the Internet, streaming digital media, and viewing online documents. Running the Microsoft® Windows® XP Embedded operating system, Isys i/O delivers a powerful and secure platform for touchpanel control with integrated PC functionality. Programmatic control erases the lines between control system and PC, allowing programmers to customize each application's behavior within the touchpanel environment to create a truly powerful and user-friendly interface.

ISYS® TILT TOUCHPANELS

► Isys i/O™ Tilt Touchpanel Media Centers

Isys i/O™ 17" Tilt Touchpanel Media Center w/QuickMedia™ **TPMC-17-QM**

adjustable compensation for cable runs up to 450 feet; Input #2 allows up to 300 feet for video and HDTV, and shorter distances for RGB computer signals. Both QM Inputs receive audio signals from external microphone and stereo line level sources.

High-resolution RGB graphics and 24-bit digital audio are output from the internal PC and microphone via the QM Output port for audience presentation and intercom purposes.

Connectivity and Expansion—Both Cresnet and high-speed Ethernet are standard on the TPMC-17-QM, providing for seamless communications with Crestron control systems, computers, digital media servers, and other IP-based devices. Wi-Fi wireless networking and memory expansion are easily added through two PC card slots, and two USB ports enable the connection of an external mouse and keyboard (not included), as well as USB cameras, CD ROM drives, and memory devices.¹

Functional Tiltcase Design—The stylish tiltcase housing allows smooth tilt adjustment from 45 to 90 degrees, and features an integral cable strain relief system and rear cover to secure and hide the connections at the back of the touchpanel. Five backlit pushbuttons are also provided, allowing for quick access to commonly used functions.

TPMC-17-QM using a single QuickMedia Transmitter

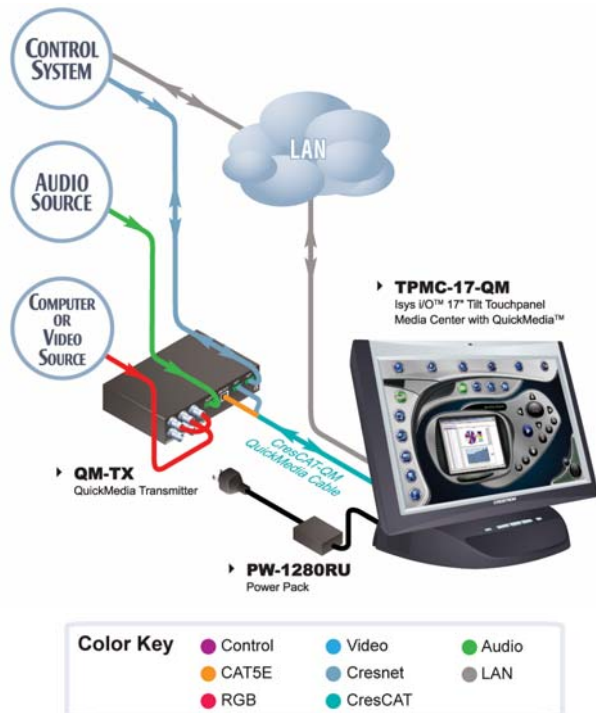

- 17" active matrix touchscreen display | 1280 x 768 resolution
- 24-Bit Isys i/O graphics | Synapse image rendering algorithm
- Windows XP Embedded operating system
- Onboard PC applications for Web browsing, streaming media, conferencing, VoIP, remote desktop, and digital media presentation - no computer required!
- Built-in real-time annotation using Crestron MediaMarker
- Dual-window HD video and RGB display²
- Built-in 10 watt biamplified speaker system and microphone²
- QuickMedia AV connectivity | audience presentation output²
- Secure high-speed Ethernet and Cresnet communications
- Tiltcase housing with integral rear cover and cable strain relief

SPECIFICATIONS

Touchscreen Display

Display Type: TFT Active matrix color LCD
Size: 17 inch (43.2 cm) diagonal widescreen
Aspect Ratio: 15:9 WXGA
Resolution: 1280 x 768 pixels
Brightness: 450 nits (cd/m²)
Contrast: 400:1
Color Depth: 24-bit, 16.7M colors
Illumination: Backlit fluorescent
Viewing Angle: ±88° horizontal, ±88° vertical
Touchscreen: Resistive membrane

Processor

VIA Eden™ 667 MHz CPU

Memory

SDRAM: 512 MB
Flash: 512 MB
PC Card: Accepts up to (2) 4GB Type II PC Cards (not included)
Maximum Project Size: 190 MB

Operating System

Microsoft® Windows® XP Embedded

Graphic Engine

Isys i/O engine, VIA Unichrome™ CLE266 chipset, 24-bit non-palette graphics + 8-bit alpha channel transparency, 16.7 million colors, Synapse image rendering algorithm, multi-mode objects, dynamic menu objects, dynamic graphics, PNG translucency, full-motion (60 fps) animation, transition effects, color key video windowing

Embedded Software Applications¹

Microsoft Internet Explorer w/Macromedia® Flash® plug-in, Windows Media® Player, RealPlayer®, Axis® Media Control, Crestron MediaMarker™, Remote Desktop, NetMeeting®, Skype™, Java™ Runtime, DirectX®, Yahoo! Widgets®, Adobe® Acrobat® Reader, and viewers for MS Word, Excel, and PowerPoint®

> continued

tilt touchpanels

TPMC-17-QM Isys i/O™ 17" Tilt Touchpanel Media Center w/QuickMedia™ (continued)

Ethernet

10BaseT/100BaseTX, auto-negotiating, full/half duplex TCP/IP, UDP/IP, DHCP, CIP, IEEE 802.3U compliant

Wireless

Wireless Ethernet capable using third-party 802.11 PC card¹
(Wired connections required for power, audio, video and RGB)

Video/RGB²

Signal Types: RGB and auto-detecting composite, S-Video, or component video

Formats: SDTV 480i (NTSC) & 576i (PAL), EDTV 480p & 576p, HDTV 720p & 1080i; RGB(VGA) up to UXGA 1600 x 1200

Color Depth: 24-bit, 16.7M colors

Features: Dual-window each scalable to full-screen, time base correction, gamma correction, line doubling, motion adaptive deinterlacing, reverse 3:2/2:2 pulldown

Streaming/File Formats: MPEG4 and MJPEG via Axis Media Control plus all formats supported by the embedded media player applications¹

Audio²

Hardware Features: Built-in microphone and amplified speakers, stereo headphone output, internal volume control and audio mixer

Streaming/File Formats: All formats supported by the embedded media player applications¹

Audio Feedback (WAV): 8 & 16 bit PCM, mono & stereo, 8 – 44 kHz sampling rates

D-A / A-D Conversion (QM): Burr Brown 24-bit, 48 kHz

Amplification: Bi-amplified, mono, 5 Watts for high-frequency, 5 Watts for low-frequency

Buttons

(4) Backlit "softkey" buttons, programmable

(1) Backlit hard reset button, reboots the touchpanel system

Connectors

QM IN 1: (1) 8-wire RJ45 female, QuickMedia input port

Signal Types: Dynamically configurable under system control as:

(1) RGB input with stereo program audio and (2) mic channels, or

(1) Auto-detecting component (YPbPr), S-Video (Y/C),

or composite video input with stereo program audio

and (2) mic channels;

RGB Format: RGBHV

RGB Input Resolution, Non-interlaced: 640 x 480 minimum to 1600 x 1200 maximum (60 Hz limit at 1600 x 1200);

Video/HDTV Formats: 480i (NTSC), 576i (PAL), 480p, 576p, 720p and 1080i;

Horizontal Frequency: 15 to 100 kHz

Vertical Frequency: 50 to 85 Hz

Delay Skew Compensation: 0 – 22 nS

Connects to QM output port of a QM-TX or other QuickMedia device via CresCAT-QM or CresCAT-IM cable;

Maximum Cable Length: 450 ft (aggregate distance from QM origination)

QM IN 2: (1) 8-wire RJ45 female, QuickMedia input port

Signal Types: Dynamically configurable under system control as:

(1) RGB input with stereo program audio and (2) mic channels, or

(1) Auto-detecting component (YPbPr), S-Video (Y/C),

or composite video input with stereo program audio

and (2) mic channels;

RGB Format: RGBHV

RGB Input Resolution, Non-interlaced: 640 x 480 minimum to 1600 x 1200 maximum (60 Hz limit at 1600 x 1200);

Video/HDTV Formats: 480i (NTSC), 576i (PAL), 480p, 576p, 720p and 1080i;

Horizontal Frequency: 15 to 100 kHz

Vertical Frequency: 50 to 85 Hz

Delay Skew Compensation: none

Connects to QM output port of a QM-TX or other QuickMedia device via CresCAT-QM or CresCAT-IM cable;

Maximum Cable Length (Video/HDTV): 300 ft

(aggregate distance from QM origination);

Maximum Cable Length (RGB @ 60Hz): 216 ft for 640x480, 140 ft for 800x600, 84 ft for 1024x768, 70 ft for 1280x768, 30 ft for 1600x1200

(using CresCAT-QM or CresCAT-IM cable)

QM OUT 1: (1) 8-wire RJ45 female, QuickMedia output port

containing RGB output with stereo audio from internal PC and

(2) discrete channels from internal mic;

RGB Format: RGBHV

RGB Output Resolution, Non-interlaced: 1280 x 768 pixels @ 60 Hz

Connects to QM input port of any QuickMedia device via

CresCAT-QM or CresCAT-IM cable

HEADPHONES: (1) 3.5 mm TRS mini phone jack

Output Power: 105 mW per channel

Minimum Impedance: 8 ohms

USB: (2) USB Type A female, USB 1.1 ports for mouse, keyboard, and storage devices¹

RS-232: (1) 6-pin RJ11 female, computer console port

Bidirectional RS-232 up to 115.2k baud

Hardware and software handshaking support

PC CARD A – B: (2) Type II PC Card slots for memory expansion, project upload, and wireless NIC¹

ETHERNET: (1) 8-wire RJ45 with 2 LED indicators

10BaseT/100BaseTX Ethernet port

Green LED indicates network speed

Yellow LED indicates Ethernet activity

NET: (1) 4-pin 3.5mm detachable terminal block

Cresnet Slave Port (data only; 24V terminal not used)

Connects to Cresnet control network

PWR: (1) 4-pin DC power jack, 12.5V DC power input

(external power supply included)

GND: (1) 6-32 screw, chassis ground lug

Power Requirements

TPMC-17-QM: 8.4 Amps @ 12.5 Volts DC

External Power Supply (included): 2.2 Amps @ 100–250 Volts AC, 50/60 Hz

Cresnet Power Usage: 0 Watt @ 24 Volts DC

ISYS® TILT TOUCHPANELS

► Isys i/O™ Tilt Touchpanel Media Centers

Isys i/O™ 17" Tilt Touchpanel Media Center w/QuickMedia™ **TPMC-17-QM**

TPMC-17-QM in a QuickMedia system

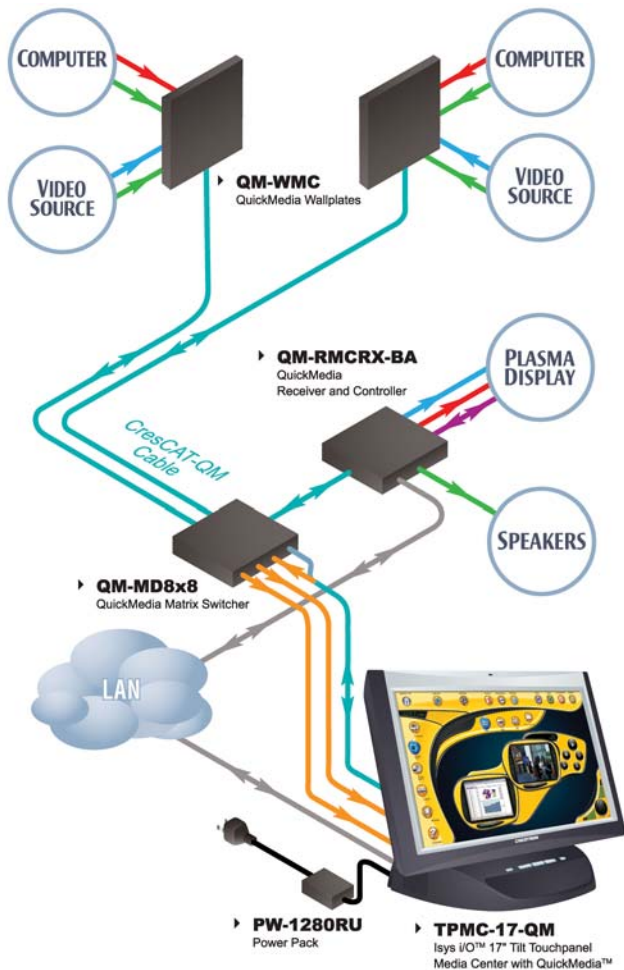

Environmental

Temperature: 50° to 113°F (10° to 45°C)
Humidity: 10% to 90% RH (non-condensing)

Enclosure

Construction: High impact black/silver injection-molded case with integral rear cover and cable strain relief
Screen Tilt: Adjustable 45 to 90 degrees

Dimensions

Height: 14.17 in (35.99 cm)
Width: 17.63 in (44.77 cm)
Depth: 13.74 in (34.90 cm)

Weight

19.4 lbs (8.8 kg)

INCLUDED ACCESSORIES

PW-1280RU
 Power Supply

¹ See Web site or contact Crestron for a current list of compatible devices and embedded applications. To ensure reliable performance, new device drivers and applications are available only from Crestron through firmware updates.

² One or more QuickMedia devices are required to facilitate the input and output of audio, video, and RGB signals. See the "MediaManager" section of this catalog or visit the Crestron Website for more information about QuickMedia.

tilt touchpanels

AVAILABLE ACCESSORIES

- ▶ **QM-TX**
QuickMedia Transmitter
- ▶ **SMK-12/15/17**
Swivel Mount Kit
- ▶ **CresCAT®QM**
QuickMedia™ Cable
- ▶ **CresCAT®IM**
iMedia Cable
- ▶ **TPS/TPMC-CBL-T**
Triamase Interface Cables

ISYS® TILT TOUCHPANELS

→ Isys i/O™ Tilt Touchpanel Media Centers

TPMC-15-QM Isys i/O™ 15" Tilt Touchpanel Media Center w/QuickMedia™



tilt touchpanels

Isys i/O ingeniously integrates touchpanel control with embedded PC functionality, delivering a unified multimedia presentation solution. Incorporating modern styling in a versatile tiltcase design, the TPMC-15-QM Touchpanel Media Center features a spectacular 15" XGA display offering an extra wide viewing angle with exceptional brightness and contrast for stunning control graphics, high-res images, embedded PC applications, and full-motion HD video.

Touchpanel Control and Presentation—In every sense, the TPMC-15-QM is a true Crestron touchpanel, offering vibrant 24-bit color depth with 8-bit alpha channel transparency to produce incredible 3D graphics using new dynamic menu objects, dynamic graphics, full-motion animations, multimode objects, PNG translucency, and exclusive Synapse™ image rendering – all with astonishing speed. But more than a touchpanel, the TPMC-15-QM is also a dynamic presentation source, outputting high-resolution graphics and audio to any sized audience via integrated QuickMedia transport technology.

Embedded PC—The power of Isys i/O is in its embedded PC engine, combining rock solid touchpanel performance with enhanced capabilities for surfing the Internet, streaming digital media, and viewing online documents. Running the Microsoft® Windows® XP Embedded operating system, Isys i/O delivers a powerful and secure platform for touchpanel control with integrated PC functionality. Programmatic control erases the lines between control system and PC, allowing programmers to customize each application's behavior within the touchpanel environment to create a truly powerful and user-friendly interface.

With built-in Windows Media® Player, RealPlayer®, and Internet Explorer, plus viewers for Word, Excel, PowerPoint®,

and Adobe® Acrobat®, the TPMC-15-QM serves as a complete multimedia presentation source without necessitating a separate computer. You can also access data and run applications on other computers via Remote Desktop, and use NetMeeting® and Skype™ for interactive conferencing and voice-over-IP (VoIP) communications – right on the touchpanel. Plus, support for Yahoo! Widgets® affords an easy solution for integrating everything from calendars and clocks to stock tickers, weather forecasts, news feeds, and thousands of other fun and useful utilities.

MediaMarker™ Annotation—Built-in annotation allows presenters to write or draw electronically on the touchscreen using a finger or stylus. Whether drawing freehand on a whiteboard screen, highlighting points on a spreadsheet, or making notes over motion video or still images, MediaMarker facilitates crystal clear visual communications.

Dual-Window HD Video and RGB²—In addition to its internal PC and streaming video applications, the TPMC-15-QM can also simultaneously display two fully-scalable, full-motion video windows. Each window supports standard video, HDTV, and high-resolution RGB signals from external AV and computer sources. Discrete video scalers with motion adaptive deinterlacing bring out the highest detail, minimizing visible scan lines and motion artifacts for a truly remarkable picture. Advanced gamma correction and built-in time base correction ensure accurate color reproduction and a jitter-free image.

High-Quality Audio²—An integrated microphone, biamplified speakers, stereo headphone output, and PC audio output are all built into the touchpanel to support full AV, intercom, desktop conferencing, and multimedia computer capabilities. Customized WAV files can be loaded on the touchpanel to add dimension to the touchscreen graphics with personalized sounds, button feedback, and voice prompts.

QuickMedia™—All audio and video connections are facilitated using Crestron's revolutionary QuickMedia transport, providing a flexible yet remarkably simple wiring solution. Through QuickMedia (QM), the TPMC-15-QM interfaces directly with other QM-based products using inexpensive CAT5e type cable.

The two QM Input ports each support non-interlaced RGB up to 1600 X 1200 pixels, as well as composite, S-Video, and component video signals. QM Input #1 includes software-adjustable compensation for cable runs up to 450 feet; Input #2 allows up to 300 feet for video and HDTV, and shorter distances for RGB computer signals. Both QM Inputs receive audio signals from external microphone and stereo line level sources.

ISYS® TILT TOUCHPANELS

► Isys i/O™ Tilt Touchpanel Media Centers

Isys i/O™ 15" Tilt Touchpanel Media Center w/QuickMedia™ **TPMC-15-QM**

High-resolution RGB graphics and 24-bit digital audio are output from the internal PC and microphone via the QM Output port for audience presentation and intercom purposes.

Connectivity and Expansion—Both Cresnet and high-speed Ethernet are standard on the TPMC-15-QM, providing for seamless communications with Crestron control systems, computers, digital media servers, and other IP-based devices. Wi-Fi wireless networking and memory expansion are easily added through two PC card slots, and two USB ports enable the connection of an external mouse and keyboard (not included), as well as USB cameras, CD ROM drives, and memory devices.¹

Functional Tiltcase Design—The stylish tiltcase housing allows smooth tilt adjustment from 45 to 90 degrees, and features an integral cable strain relief system and rear cover to secure and hide the connections at the back of the touchpanel. Five backlit pushbuttons are also provided, allowing for quick access to commonly used functions.

TPMC-15-QM using a single QuickMedia Transmitter

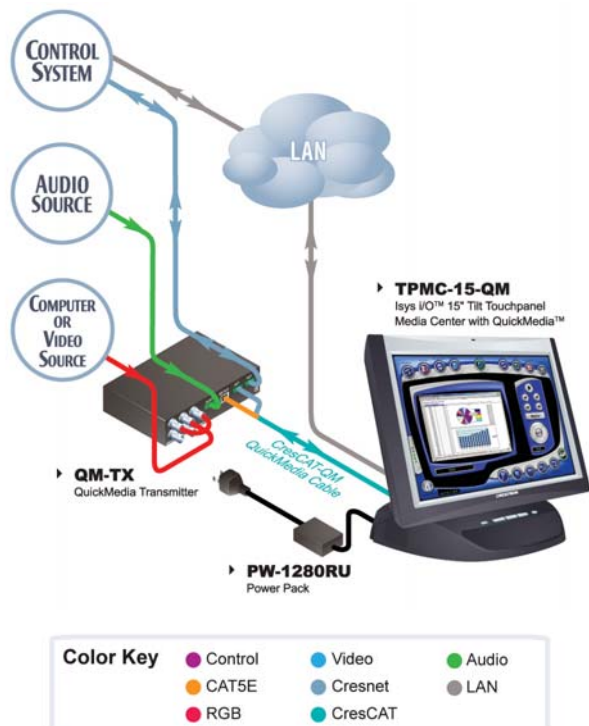

- 15" active matrix touchscreen display | 1024 x 768 resolution
- 24-Bit Isys i/O graphics | Synapse image rendering algorithm
- Windows XP Embedded operating system
- Onboard PC applications for Web browsing, streaming media, conferencing, VoIP, remote desktop, and digital media presentation - no computer required!
- Built-in real-time annotation using Crestron MediaMarker
- Dual-window HD video and RGB display²
- Built-in 10 watt biamplified speaker system and microphone²
- QuickMedia AV connectivity | audience presentation output²
- Secure high-speed Ethernet and Cresnet communications
- Tiltcase housing with integral rear cover and cable strain relief

SPECIFICATIONS

Touchscreen Display

Display Type: TFT Active matrix color LCD
Size: 15 inch (38.12 cm) diagonal
Aspect Ratio: 4:3 XGA
Resolution: 1024 x 768 pixels
Brightness: 350 nits (cd/m²)
Contrast: 700:1
Color Depth: 24-bit, 16.7M colors
Illumination: Backlit fluorescent
Viewing Angle: ±85° horizontal, ±85° vertical
Touchscreen: Resistive membrane

Processor

VIA Eden™ 667 MHz CPU

Memory

SDRAM: 512 MB
Flash: 512 MB
PC Card: Accepts up to (2) 4GB Type II PC Cards (not included)
Maximum Project Size: 190 MB

Operating System

Microsoft® Windows® XP Embedded

Graphic Engine

Isys i/O engine, VIA Unichrome™ CLE266 chipset, 24-bit non-palette graphics + 8-bit alpha channel transparency, 16.7 million colors, Synapse image rendering algorithm, multi-mode objects, dynamic menu objects, dynamic graphics, PNG translucency, full-motion (60 fps) animation, transition effects, color key video windowing

Embedded Software Applications¹

Microsoft Internet Explorer w/Macromedia® Flash® plug-in, Windows Media® Player, RealPlayer®, Axis® Media Control, Crestron MediaMarker™, Remote Desktop, NetMeeting®, Skype™, Java™ Runtime, DirectX®, Yahoo! Widgets®, Adobe® Acrobat® Reader, and viewers for MS Word, Excel, and PowerPoint®

> continued

tilt touchpanels

TPMC-15-QM Isys i/O™ 15" Tilt Touchpanel Media Center w/QuickMedia™ (continued)

Ethernet

10BaseT/100BaseTX, auto-switching, auto-negotiating, full/half duplex, TCP/IP, UDP/IP, CIP, DHCP, IEEE 802.3U compliant

Wireless

Wireless Ethernet capable using third-party 802.11 PC card¹ (Wired connections required for power, audio, video and RGB)

Video/RGB²

Signal Types: RGB and auto-detecting composite, S-Video, or component video

Formats: SDTV 480i (NTSC) & 576i (PAL), EDTV 480p & 576p, HDTV 720p & 1080i; RGB(VGA) up to UXGA 1600 x 1200

Color Depth: 24-bit, 16.7M colors

Features: Dual-window each scalable to full-screen, time base correction, gamma correction, line doubling, motion adaptive deinterlacing, reverse 3:2/2:2 pulldown

Streaming/File Formats: MPEG4 and MJPEG via Axis Media Control plus all formats supported by the embedded media player applications¹

Audio²

Hardware Features: Built-in microphone and amplified speakers, stereo headphone output, internal volume control and audio mixer

Streaming/File Formats: All formats supported by the embedded media player applications¹

Audio Feedback (WAV): 8 & 16 bit PCM, mono & stereo, 8 – 44 kHz sampling rates

D-A / A-D Conversion (QM): Burr Brown 24-bit, 48 kHz

Amplification: Bi-amplified, mono, 5 Watts for high-frequency, 5 Watts for low-frequency

Buttons

(4) Backlit "softkey" buttons, programmable

(1) Backlit hard reset button, reboots the touchpanel system

Connectors

QM IN 1: (1) 8-wire RJ45 female, QuickMedia input port

Signal Types: Dynamically configurable under system control as:

(1) RGB (VGA) input with stereo program audio and (2) mic channels, or

(1) Auto-detecting component (YPbPr), S-Video (Y/C), or composite video input with stereo program audio and (2) mic channels;

RGB Format: RGBHV

RGB Input Resolution, Non-interlaced: 640 x 480 minimum to 1600 x 1200 maximum (60 Hz limit at 1600 x 1200);

Video/HDTV Formats: 480i (NTSC), 576i (PAL), 480p, 576p, 720p and 1080i;

Horizontal Frequency: 15 to 100 kHz

Vertical Frequency: 50 to 85 Hz

Delay Skew Compensation: 0 – 22 ns

Connects to QM output port of a QM-TX or other QuickMedia device via CresCAT-QM or CresCAT-IM cable;

Maximum Cable Length: 450 ft (aggregate distance from QM origination)

QM IN 2: (1) 8-wire RJ45 female, QuickMedia input port

Signal Types: Dynamically configurable under system control as:

(1) RGB (VGA) input with stereo program audio and (2) mic channels, or

(1) Auto-detecting component (YPbPr), S-Video (Y/C), or composite video input with stereo program audio and (2) mic channels;

RGB Format: RGBHV

RGB Input Resolution, Non-interlaced: 640 x 480 minimum to 1600 x 1200 maximum (60 Hz limit at 1600 x 1200);

Video/HDTV Formats: 480i (NTSC), 576i (PAL), 480p, 576p, 720p and 1080i;

Horizontal Frequency: 15 to 100 kHz

Vertical Frequency: 50 to 85 Hz

Delay Skew Compensation: none

Connects to QM output port of a QM-TX or other QuickMedia device via CresCAT-QM or CresCAT-IM cable;

Maximum Cable Length (Video/HDTV): 300 ft (aggregate distance from QM origination);

Maximum Cable Length (RGB @ 60Hz): 216 ft for 640x480, 140 ft for 800x600, 84 ft for 1024x768, 70 ft for 1280x768, 30 ft for 1600x1200 (using CresCAT-QM or CresCAT-IM cable)

QM OUT 1: (1) 8-wire RJ45 female, QuickMedia output port

containing RGB output with stereo audio from internal PC and (2) discrete channels from internal mic;

RGB Format: RGBHV

RGB Output Resolution, Non-interlaced: 1024 x 768 pixels @ 60 Hz

Connects to QM input port of any QuickMedia device via

CresCAT-QM or CresCAT-IM cable

HEADPHONES: (1) 3.5 mm TRS mini phone jack

Output Power: 105 mW per channel

Minimum Impedance: 8 ohms

USB: (2) USB Type A female, USB 1.1 ports for mouse, keyboard, and storage devices¹

RS-232: (1) 6-pin RJ11 female, computer console port

Bidirectional RS-232 up to 115.2k baud

Hardware and software handshaking support

PC CARD A – B: (2) Type II PC Card slots for memory expansion, project upload, and wireless NIC¹

ETHERNET: (1) 8-wire RJ45 with 2 LED indicators

10BaseT/100BaseTX Ethernet port

Green LED indicates network speed

Yellow LED indicates Ethernet activity

NET: (1) 4-pin 3.5mm detachable terminal block

Cresnet Slave Port (data only; 24V terminal not used)

Connects to Cresnet control network

PWR: (1) 4-pin DC power jack, 12.5V DC power input

(external power supply included)

GND: (1) 6-32 screw, chassis ground lug

ISYS® TILT TOUCHPANELS

► Isys i/O™ Tilt Touchpanel Media Centers

Isys i/O™ 15" Tilt Touchpanel Media Center w/QuickMedia™ **TPMC-15-QM**

TPMC-15-QM in a QuickMedia system

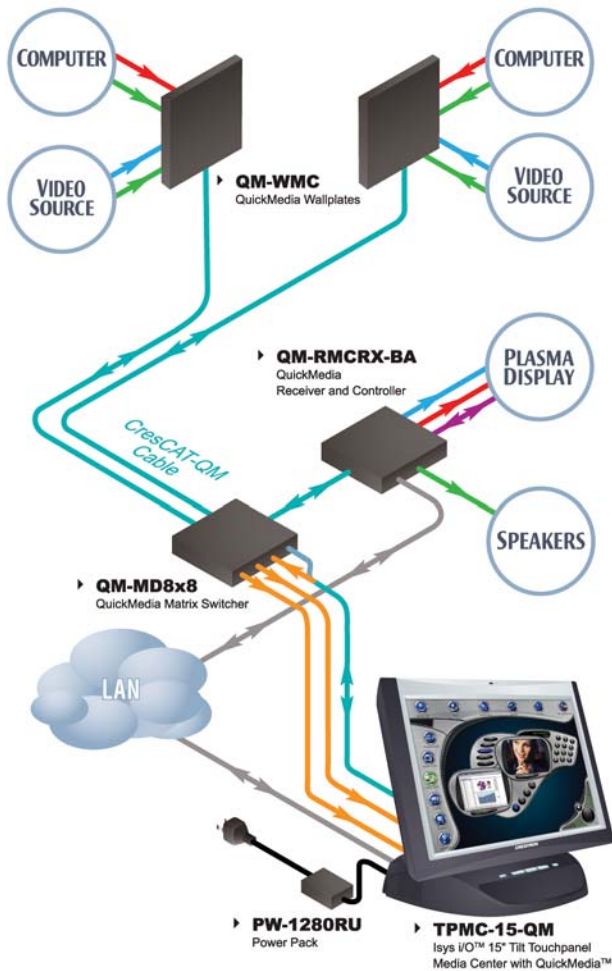

Power Requirements

TPMC-15-QM: 8.4 Amps @ 12.5 Volts DC
External Power Supply (included): 2.2 Amps @ 100–250 Volts AC, 50/60 Hz
Cresnet Power Usage: 0 Watt @ 24 Volts DC

Environmental

Temperature: 50° to 113°F (10° to 45°C)
Humidity: 10% to 90% RH (non-condensing)

Enclosure

Construction: High impact black/silver injection-molded case with integral rear cover and cable strain relief
Screen Tilt: Adjustable 45 to 90 degrees

Dimensions

Height: 14.17 in (35.99 cm)
Width: 14.94 in (37.95 cm)
Depth: 13.74 in (34.90 cm)

Weight

15.8 lbs (7.1 kg)

INCLUDED ACCESSORIES

PW-1280RU
 Power Supply

¹ See Web site or contact Crestron for a current list of compatible devices and embedded applications. To ensure reliable performance, new device drivers and applications are available only from Crestron through firmware updates.

² One or more QuickMedia devices are required to facilitate the input and output of audio, video, and RGB signals. See the "MediaManager" section of this catalog or visit the Crestron Website for more information about QuickMedia.

tilt touchpanels

AVAILABLE ACCESSORIES

- ▶ **QM-TX**
QuickMedia Transmitter
- ▶ **SMK-12/15/17**
Swivel Mount Kit
- ▶ **CresCAT®QM**
QuickMedia™ Cable
- ▶ **CresCAT®IM**
iMedia Cable
- ▶ **TPS/TPMC-CBL-T**
Triamase Interface Cables

ISYS® TILT TOUCHPANELS

► Isys i/O™ Tilt Touchpanel Media Centers

TPMC-17-CH Isys i/O™ 17" Tilt Touchpanel Media Center w/CH CAT5 AV



With built-in Windows Media® Player, RealPlayer®, and Internet Explorer, plus viewers for Word, Excel, PowerPoint®, and Adobe® Acrobat®, the TPMC-17-CH provides everything needed for viewing Web pages, enjoying online music and movies, and downloading documents without necessitating a separate computer. You can also access data and run applications on other computers via Remote Desktop, and use NetMeeting® and Skype™ for interactive conferencing and voice-over-IP (VoIP) communications – right on the touchpanel. Plus, support for Yahoo! Widgets affords an easy solution for integrating everything from calendars and clocks to stock tickers, weather forecasts, news feeds, and thousands of other fun and useful utilities.

Dual-Window HD Video²—In addition to its internal PC and streaming video applications, the TPMC-17-CH can also simultaneously display two fully-scalable, full-motion video windows. Each window supports standard video and HDTV formats from external sources. Discrete video scalers with motion adaptive deinterlacing bring out the highest detail, minimizing visible scan lines and motion artifacts for an incredible picture. Advanced gamma correction and built-in time base correction ensure accurate color reproduction and a jitter-free image.

High-Quality Audio—An integrated microphone, bi-amplified speakers, stereo headphone output, and PC audio output are all built into the touchpanel to support full AV, intercom, desktop conferencing, and multimedia computer capabilities. Customized WAV files can be loaded on the touchpanel to add dimension to the touchscreen graphics with personalized sounds, button feedback, and voice prompts.

Crestron Home® CAT5 AV—All audio and video connections are facilitated using inexpensive CAT5 wire, enabling direct connection to Crestron's popular CAT5 balanced audio and video distribution switchers. Two video input ports are provided, each supporting composite, S-Video, and HDTV/component formats over wiring distances of up to 500 feet. A bidirectional audio port receives stereo program audio and intercom signals, and outputs audio from the internal microphone and PC for intercom and whole-house audio distribution. To facilitate the connection of conventional video and audio devices, an external interface module is included.

Connectivity and Expansion—Both Crestron and high-speed Ethernet are standard on the TPMC-17-CH, providing for seamless communications with Crestron control systems, computers, digital media servers, and other IP-based devices. Wi-Fi wireless networking and memory expansion

Isys i/O ingeniously integrates touchpanel control with embedded PC functionality, delivering a unified solution for controlling AV and home automation, browsing the Internet, and streaming digital media. Incorporating modern styling in a versatile tiltcase design, the TPMC-17-CH Touchpanel Media Center features a spectacular 17" WXGA widescreen display offering an extra wide viewing angle with exceptional brightness and contrast for stunning control graphics, high-res images, embedded PC applications, and full-motion HD video.

Enhanced Touchpanel Control—In every sense, the TPMC-17-CH is a true Crestron touchpanel, offering vibrant 24-bit color depth with 8-bit alpha channel transparency to produce incredible 3D graphics using new dynamic menu objects, dynamic graphics, full-motion animations, multimode objects, PNG translucency, and exclusive Synapse™ image rendering – all with astonishing speed. But more than a touchpanel, the TPMC-17-CH is also a dynamic resource for managing routine online tasks and enjoying streaming music and video, and a high-resolution video monitor with performance rivaling the best LCD flat-panel displays available.

Embedded PC—The power of Isys i/O is in its embedded PC engine, combining rock solid touchpanel performance with enhanced capabilities for surfing the Internet, streaming digital media, and viewing online documents. Running the Microsoft® Windows® XP Embedded operating system, Isys i/O delivers a powerful and secure platform for touchpanel control with integrated PC functionality. Programmatic control erases the lines between control system and PC, allowing programmers to customize each application's behavior within the touchpanel environment to create a truly powerful and user-friendly interface.

ISYS® TILT TOUCHPANELS

► Isys i/O™ Tilt Touchpanel Media Centers

Isys i/O™ 17" Tilt Touchpanel Media Center w/CH CAT5 AV **TPMC-17-CH**

are easily added through two PC card slots, and two USB ports enable the connection of an external mouse and keyboard (not included), as well as USB cameras, CD ROM drives, and memory devices.¹

Functional Tiltcase Design—The stylish tiltcase housing allows smooth tilt adjustment from 45 to 90 degrees, and features an integral cable strain relief system and rear cover to secure and hide the connections at the back of the touchpanel. Five backlit pushbuttons are also provided, allowing for quick access to commonly used functions.

- ▶ 17" active matrix touchscreen display | 1280 x 768 resolution
- ▶ 24-Bit Isys i/O graphics | Synapse image rendering algorithm
- ▶ Windows XP Embedded operating system
- ▶ Onboard PC applications for Web browsing, streaming media, conferencing, VoIP, and remote desktop – no computer required!
- ▶ High-performance dual-window HD video display²
- ▶ Built-in 10 watt bi-amplified speaker system and microphone
- ▶ Crestron Home CAT5 AV connectivity
- ▶ Secure high-speed Ethernet and Cresnet communications
- ▶ Tiltcase housing with integral rear cover and cable strain relief

TPMC-17-CH using CAT5 AV Interface Module



SPECIFICATIONS

Touchscreen Display

Display Type: TFT Active matrix color LCD
Size: 17 inch (43.2 cm) diagonal widescreen
Aspect Ratio: 15:9 WXGA
Resolution: 1280 x 768 pixels
Brightness: 450 nits (cd/m²)
Contrast: 400:1
Color Depth: 24-bit, 16.7M colors
Illumination: Backlit fluorescent
Viewing Angle: ±88° horizontal, ±88° vertical
Touchscreen: Resistive membrane

Processor

VIA Eden™ 667 MHz CPU

Memory

SDRAM: 512 MB
Flash: 512 MB
PC Card: Accepts up to (2) 4GB Type II PC Cards (not included)
Maximum Project Size: 190 MB

Operating System

Microsoft® Windows® XP Embedded

Graphic Engine

Isys i/O engine, VIA Unichrome™ CLE266 chipset, 24-bit non-palette graphics + 8-bit alpha channel transparency, 16.7 million colors, Synapse image rendering algorithm, multi-mode objects, dynamic menu objects, dynamic graphics, PNG translucency, full-motion (60 fps) animation, transition effects, color key video windowing

Embedded Software Applications¹

Microsoft Internet Explorer w/Macromedia® Flash® plug-in, Windows Media® Player, RealPlayer®, Axis® Media Control, Crestron MediaMarker™, Remote Desktop, NetMeeting®, Skype™, Java™ Runtime, DirectX®, Yahoo! Widgets, Adobe® Acrobat® Reader, and viewers for MS Word, Excel, and PowerPoint®

Ethernet

10BaseT/100BaseTX, auto-negotiating, full/half duplex TCP/IP, UDP/IP, CIP, DHCP, IEEE 802.3U compliant

Wireless

Wireless Ethernet capable using third-party 802.11 PC card¹ (Wired connections required for power, audio, and video)

Video

Signal Types: Auto-detecting composite, S-Video, or component
Formats: SDTV 480i (NTSC) & 576i (PAL), EDTV 480p & 576p, HDTV 720p & 1080i
Color Depth: 24-bit, 16.7M colors
Features: Dual-window² each scalable to full-screen, time base correction, gamma correction, line doubling, motion adaptive deinterlacing, reverse 3:2/2:2 pulldown

> continued

tilt touchpanels

TPMC-17-CH Isys i/O™ 17" Tilt Touchpanel Media Center w/CH CAT5 AV (continued)

Streaming/File Formats: MPEG4 and MJPEG via Axis Media Control plus all formats supported by the embedded media player applications¹

Audio

Hardware Features: Built-in microphone and biamplified speakers, stereo headphone output, internal volume control and audio mixer

Streaming/File Formats: All formats supported by the embedded media player applications¹

Audio Feedback (WAV): 8 & 16 bit PCM, mono & stereo, 8 – 44 kHz sampling rates

Amplification: Bi-amplified, mono, 5 Watts for high-frequency, 5 Watts for low-frequency

Buttons

(4) Backlit "softkey" buttons, programmable

(1) Backlit hard reset button, reboots the touchpanel system

Connectors

CH VIDEO IN 1 – 2: (2) 8-wire RJ45 female

CAT5 balanced video input ports

Signal Types: Auto-detecting component (YPbPr), S-Video (Y/C), or composite video;

Formats: SDTV 480i (NTSC) & 576i (PAL), EDTV 480p & 576p, HDTV 720p & 1080i;

Input Impedance: 100 ohms balanced

Connect to any Crestron CAT5 balanced video source(s) via CresCAT cable, or TPMC-CH-IMC interface module (included) via 15 foot "triamese" cable provided;

Maximum Cable Length: 500 feet for component/HDTV, 750 feet for composite/S-Video

CH AUDIO I/O: (1) 8-wire RJ45 female

Bidirectional CAT5 balanced audio port

Signal Types: Receives (1) balanced stereo audio signal, and transmits (1) balanced stereo audio signal from internal PC or microphone (dynamically selectable);

Maximum Input Level: 4 V_{RMS}

Maximum Output Level: 2 V_{RMS}

Input/Output Impedance: 600 ohms

Connects to any other Crestron CAT5 balanced audio port via CresCAT cable, or TPMC-CH-IMC interface module (included) via 15 foot "triamese" cable provided;

Maximum Cable Length: 1000 feet

HEADPHONES: (1) 3.5 mm TRS mini phone jack

Output Power: 105 mW per channel

Minimum Impedance: 8 ohms

USB: (2) USB Type A female, USB 1.1 ports for mouse, keyboard, and storage devices¹

RS-232: (1) 6-pin RJ11 female, computer console port

Bidirectional RS-232 up to 115.2k baud

Hardware and software handshaking support

PC CARD A – B: (2) Type II PC Card slots for memory expansion, project upload, and wireless NIC¹

ETHERNET: (1) 8-wire RJ45 with 2 LED indicators

10BaseT/100BaseTX Ethernet port

Green LED indicates network speed

Yellow LED indicates Ethernet activity

NET: (1) 4-pin 3.5mm detachable terminal block

Cresnet Slave Port (data only; 24V terminal not used)

Connects to Cresnet control network, or TPMC-CH-IMC interface module (included) via 15 foot "triamese" cable provided

PWR: (1) 4-pin DC power jack, 12.5V DC power input

(external power supply included)

GND: (1) 6-32 screw, chassis ground lug

Power Requirements

TPMC-17-CH: 8.4 Amps @ 12.5 Volts DC

External Power Supply (included): 2.2 Amps @ 100-250 Volts AC, 50/60 Hz

Cresnet Power Usage: 0 Watt @ 24 Volts DC

Environmental

Temperature: 50° to 113°F (10° to 45°C)

Humidity: 10% to 90% RH (non-condensing)

Enclosure

Construction: High impact black/silver injection-molded case with integral rear cover and cable strain relief

Screen Tilt: Adjustable 45 to 90 degrees

Dimensions

Height: 14.17 in (35.99 cm)

Width: 17.63 in (44.77 cm)

Depth: 13.74 in (34.90 cm)

Weight

19.4 lbs (8.8 kg)

INCLUDED ACCESSORIES

(See individual product specifications for complete information.)

TPMC-CH-IMC

CAT5 Balanced AV Interface Module + 15 ft triamese cable

PW-1280RU

Power Supply

¹See Web site or contact Crestron for a current list of compatible devices and embedded applications. To ensure reliable performance, new device drivers and applications are available only from Crestron through firmware updates.

² Additional CAT5 Balanced AV equipment is required to facilitate the input of more than one external video signal. See the "Audio Video Distribution and Surround Sound" section of this catalog or visit the Crestron Website for more information about Crestron Home CAT5 Balanced AV.

ISYS® TILT TOUCHPANELS

► Isys i/O™ Tilt Touchpanel Media Centers

Isys i/O™ 17" Tilt Touchpanel Media Center w/CH CAT5 AV **TPMC-17-CH**

TPMC-17-CH in a CAT5 AV Distribution System

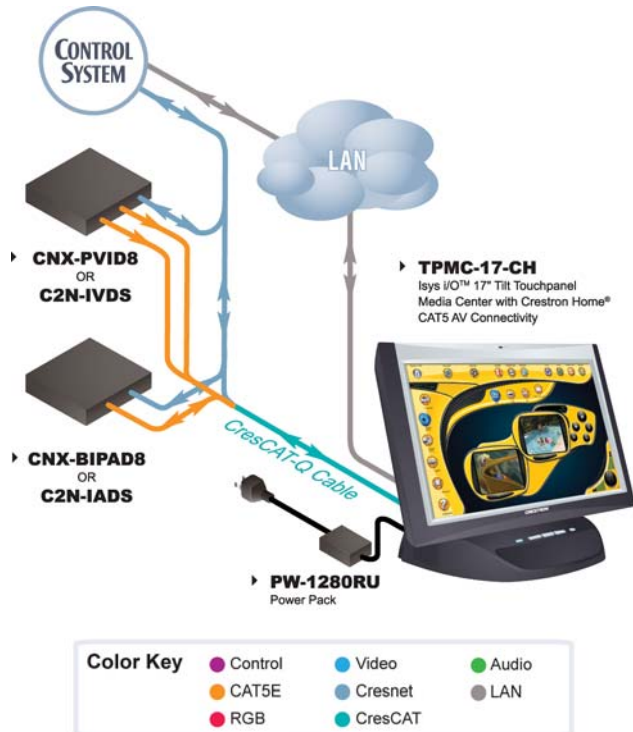

tilt touchpanels

AVAILABLE ACCESSORIES

- ▶ **TPMC-CH-IMW**
CAT5 Balanced AV Interface Wall Plate
- ▶ **TPS/TPMC-CBL-T**
Triamese Interface Cables
- ▶ **SMK-12/15/17**
Swivel Mount Kit
- ▶ **CresCAT®Q**
Crestron Home® CAT5 AV Cable

ISYS® TILT TOUCHPANELS

► Isys i/O™ Tilt Touchpanel Media Centers

TPMC-15-CH Isys i/O™ 15" Tilt Touchpanel Media Center w/CH CAT5 AV



With built-in Windows Media® Player, RealPlayer®, and Internet Explorer, plus viewers for Word, Excel, PowerPoint®, and Adobe® Acrobat®, the TPMC-15-CH provides everything needed for viewing Web pages, enjoying online music and movies, and downloading documents without necessitating a separate computer. You can also access data and run applications on other computers via Remote Desktop, and use NetMeeting® and Skype™ for interactive conferencing and voice-over-IP (VoIP) communications – right on the touchpanel. Plus, support for Yahoo! Widgets affords an easy solution for integrating everything from calendars and clocks to stock tickers, weather forecasts, news feeds, and thousands of other fun and useful utilities.

Dual-Window HD Video²—In addition to its internal PC and streaming video applications, the TPMC-15-CH can also simultaneously display two fully-scalable, full-motion video windows. Each window supports standard video and HDTV formats from external sources. Discrete video scalers with motion adaptive deinterlacing bring out the highest detail, minimizing visible scan lines and motion artifacts for an incredible picture. Advanced gamma correction and built-in time base correction ensure accurate color reproduction and a jitter-free image.

High-Quality Audio—An integrated microphone, biamplified speakers, stereo headphone output, and PC audio output are all built into the touchpanel to support full AV, intercom, desktop conferencing, and multimedia computer capabilities. Customized WAV files can be loaded on the touchpanel to add dimension to the touchscreen graphics with personalized sounds, button feedback, and voice prompts.

Crestron Home® CAT5 AV Distribution—All audio and video connections are facilitated using inexpensive CAT5 wire, enabling direct connection to Crestron's popular CAT5 balanced audio and video distribution switchers. Two video input ports are provided, each supporting composite, S-Video, and HDTV/component formats over wiring distances of up to 500 feet. A bidirectional audio port receives stereo program audio and intercom signals, and outputs audio from the internal microphone and PC for intercom and whole-house audio distribution. To facilitate the connection of conventional video and audio devices, an external interface module is included.

Connectivity and Expansion—Both Cresnet and high-speed Ethernet are standard on the TPMC-15-CH, providing for seamless communications with Crestron control systems, computers, digital media servers, and other IP-based devices. Wi-Fi wireless networking and memory expansion

Isys i/O ingeniously integrates touchpanel control with embedded PC functionality, delivering a unified solution for controlling AV and home automation, browsing the Internet, and streaming digital media. Incorporating modern styling in a versatile tiltcase design, the TPMC-15-CH Touchpanel Media Center features a spectacular 15" XGA display offering an extra wide viewing angle with exceptional brightness and contrast for stunning control graphics, high-res images, embedded PC applications, and full-motion HD video.

Enhanced Touchpanel Control—In every sense, the TPMC-15-CH is a true Crestron touchpanel, offering vibrant 24-bit color depth with 8-bit alpha channel transparency to produce incredible 3D graphics using new dynamic menu objects, dynamic graphics, full-motion animations, multimode objects, PNG translucency, and exclusive Synapse™ image rendering – all with astonishing speed. But more than a touchpanel, the TPMC-15-CH is also a dynamic resource for managing routine online tasks and enjoying streaming music and video, and a high-resolution video monitor with performance rivaling the best LCD flat-panel displays available.

Embedded PC—The power of Isys i/O is in its embedded PC engine, combining rock solid touchpanel performance with enhanced capabilities for surfing the Internet, streaming digital media, and viewing online documents. Running the Microsoft® Windows® XP Embedded operating system, Isys i/O delivers a powerful and secure platform for touchpanel control with integrated PC functionality. Programmatic control erases the lines between control system and PC, allowing programmers to customize each application's behavior within the touchpanel environment to create a truly powerful and user-friendly interface.

ISYS® TILT TOUCHPANELS

→ Isys i/O™ Tilt Touchpanel Media Centers

Isys i/O™ 15" Tilt Touchpanel Media Center w/CH CAT5 AV **TPMC-15-CH**

are easily added through two PC card slots, and two USB ports enable the connection of an external mouse and keyboard (not included), as well as USB cameras, CD ROM drives, and memory devices.¹

Functional Tiltcase Design—The stylish tiltcase housing allows smooth tilt adjustment from 45 to 90 degrees, and features an integral cable strain relief system and rear cover to secure and hide the connections at the back of the touchpanel. Five backlit pushbuttons are also provided, allowing for quick access to commonly used functions.

- ▶ 15" active matrix touchscreen display | 1024 x 768 resolution
- ▶ 24-Bit Isys i/O graphics | Synapse image rendering algorithm
- ▶ Windows XP Embedded operating system
- ▶ Onboard PC applications for Web browsing, streaming media, conferencing, VoIP, and remote desktop – no computer required!
- ▶ High-performance dual-window HD video display²
- ▶ Built-in 10 watt bi-amplified speaker system and microphone
- ▶ Crestron Home CAT5 AV connectivity
- ▶ Secure high-speed Ethernet and Cresnet communications
- ▶ Tiltcase housing with integral rear cover and cable strain relief

TPMC-15-CH using CAT5 AV Interface Module

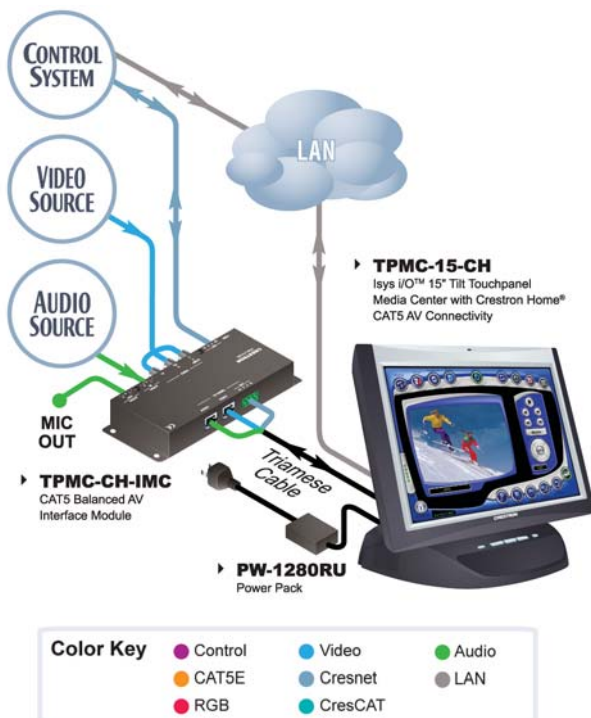

SPECIFICATIONS

Touchscreen Display

Display Type: TFT Active matrix color LCD
Size: 15 inch (38.1 cm) diagonal
Aspect Ratio: 4:3 XGA
Resolution: 1024 x 768 pixels
Brightness: 350 nits (cd/m²)
Contrast: 700:1
Color Depth: 24-bit, 16.7M colors
Illumination: Backlit fluorescent
Viewing Angle: ±85° horizontal, ±85° vertical
Touchscreen: Resistive membrane

Processor

VIA Eden™ 667 MHz CPU

Memory

SDRAM: 512 MB
Flash: 512 MB
PC Card: Accepts up to (2) 4GB Type II PC Cards (not included)
Maximum Project Size: 190 MB

Operating System

Microsoft® Windows® XP Embedded

Graphic Engine

Isys i/O engine, VIA Unichrome™ CLE266 chipset, 24-bit non-palette graphics + 8-bit alpha channel transparency, 16.7 million colors, Synapse image rendering algorithm, multi-mode objects, dynamic menu objects, dynamic graphics, PNG translucency, full-motion (60 fps) animation, transition effects, color key video windowing

Embedded Software Applications¹

Microsoft Internet Explorer w/Macromedia Flash_ plug-in, Windows Media® Player, RealPlayer®, Axis® Media Control, Crestron MediaMarker™, Remote Desktop, NetMeeting®, Skype™, Java, Runtime, DirectX®, Yahoo! Widgets, Adobe® Acrobat® Reader, and viewers for MS Word, Excel, and PowerPoint®

Ethernet

10BaseT/100BaseTX, auto-negotiating, full/half duplex TCP/IP, UDP/IP, CIP, DHCP, IEEE 802.3U compliant

Wireless

Wireless Ethernet capable using third-party 802.11 PC card¹ (Wired connections required for power, audio, and video)

Video

Signal Types: Auto-detecting composite, S-Video, or component
Formats: SDTV 480i (NTSC) & 576i (PAL), EDTV 480p & 576p, HDTV 720p & 1080i
Color Depth: 24-bit, 16.7M colors
Features: Dual-window² each scalable to full-screen, time base correction, gamma correction, line doubling, motion adaptive deinterlacing, reverse 3:2/2:2 pulldown

> continued

tilt touchpanels

TPMC-15-CH Isys i/O™ 15" Tilt Touchpanel Media Center w/CH CAT5 AV (continued)

Streaming/File Formats: MPEG4 and MJPEG via Axis Media Control plus all formats supported by the embedded media player applications¹

Audio

Hardware Features: Built-in microphone and biamplified speakers, stereo headphone output, internal volume control and audio mixer

Streaming/File Formats: All formats supported by the embedded media player applications¹

Audio Feedback (WAV): 8 & 16 bit PCM, mono & stereo, 8 – 44 kHz sampling rates

Amplification: Bi-amplified, mono, 5 Watts for high-frequency, 5 Watts for low-frequency

Buttons

- (4) Backlit "softkey" buttons, programmable
- (1) Backlit hard reset button, reboots the touchpanel system

Connectors

CH VIDEO IN 1 – 2: (2) 8-wire RJ45 female CAT5 balanced video input ports
Signal Types: Auto-detecting component (YPbPr), S-Video (Y/C), or composite video;
Formats: SDTV 480i (NTSC) & 576i (PAL), EDTV 480p & 576p, HDTV 720p & 1080i;
Input Impedance: 100 ohms balanced

Connect to any Crestron CAT5 balanced video source(s) via CresCAT cable, or TPMC-CH-IMC interface module (included) via 15 foot "triamese" cable provided;
Maximum Cable Length: 500 feet for component/HDTV, 750 feet for composite/S-Video

CH AUDIO I/O: (1) 8-wire RJ45 female Bidirectional CAT5 balanced audio port
Signal Types: Receives (1) balanced stereo audio signal, and transmits (1) balanced stereo audio signal from internal PC or microphone (dynamically selectable);
Maximum Input Level: 4 V_{RMS}
Maximum Output Level: 2 V_{RMS}
Input/Output Impedance: 600 ohms
Connects to any other Crestron CAT5 balanced audio port via CresCAT cable, or TPMC-CH-IMC interface module (included) via 15 foot "triamese" cable provided;
Maximum Cable Length: 1000 feet

HEADPHONES: (1) 3.5 mm TRS mini phone jack
Output Power: 105 mW per channel
Minimum Impedance: 8 ohms

USB: (2) USB Type A female, USB 1.1 ports for mouse, keyboard, and storage devices¹

RS-232: (1) 6-pin RJ11 female, computer console port
Bidirectional RS-232 up to 115.2k baud
Hardware and software handshaking support

PC CARD A – B: (2) Type II PC Card slots for memory expansion, project upload, and wireless NIC¹

ETHERNET: (1) 8-wire RJ45 with 2 LED indicators
10BaseT/100BaseTX Ethernet port
Green LED indicates network speed
Yellow LED indicates Ethernet activity

NET: (1) 4-pin 3.5mm detachable terminal block
Cresnet Slave Port (data only; 24V terminal not used)
Connects to Cresnet control network, or TPMC-CH-IMC interface module (included) via 15 foot "triamese" cable provided

PWR: (1) 4-pin DC power jack, 12.5V DC power input (external power supply included)

GND: (1) 6-32 screw, chassis ground lug

Power Requirements

TPMC-15-CH: 8.4 Amps @ 12.5 Volts DC

External Power Supply (included): 2.2 Amps @ 100-250 Volts AC, 50/60 Hz

Cresnet Power Usage: 0 Watt @ 24 Volts DC

Environmental

Temperature: 50° to 113°F (10° to 45°C)

Humidity: 10% to 90% RH (non-condensing)

Enclosure

Construction: High impact black/silver injection-molded case with integral rear cover and cable strain relief

Screen Tilt: Adjustable 45 to 90 degrees

Dimensions

Height: 14.17 in (35.99 cm)

Width: 14.94 in (37.95 cm)

Depth: 13.74 in (34.90 cm)

Weight

15.8 lbs (7.1 kg)

INCLUDED ACCESSORIES

(See individual product specifications for complete information.)

TPMC-CH-IMC

CAT5 Balanced AV Interface Module + 15 ft triamese cable

PW-1280RU

Power Supply

¹ See Web site or contact Crestron for a current list of compatible devices and embedded applications. To ensure reliable performance, new device drivers and applications are available only from Crestron through firmware updates.

² Additional CAT5 Balanced AV equipment is required to facilitate the input of more than one external video signal. See the "Audio Video Distribution and Surround Sound" section of this catalog or visit the Crestron Website for more information about Crestron Home CAT5 Balanced AV.

ISYS® TILT TOUCHPANELS

► Isys i/O™ Tilt Touchpanel Media Centers

Isys i/O™ 15" Tilt Touchpanel Media Center w/CH CAT5 AV **TPMC-15-CH**

TPMC-15-CH in a CAT5 AV Distribution System

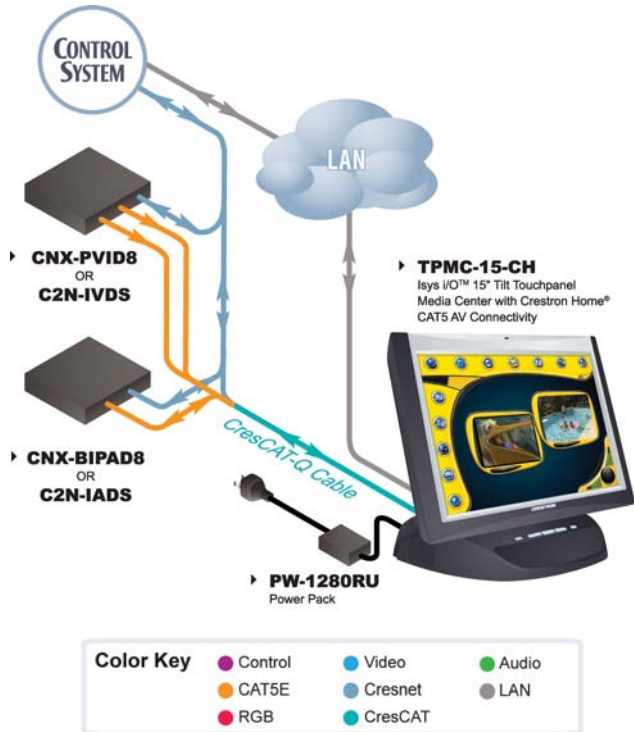

tilt touchpanels

AVAILABLE ACCESSORIES

- **TPMC-CH-IMW**
CAT5 Balanced AV Interface Wall Plate
- **TPS/TPMC-CBL-T**
Triamese Interface Cables
- **SMK-12/15/17**
Swivel Mount Kit
- **CresCAT®Q**
Crestron Home® CAT5 AV Cable

POWER SUPPLIES

PW-1280RU Regulated Universal Power Pack 12.5V DC, 8A

The PW-1280RU is the universal regulated power pack that is included as standard with every Isys i/O 15" and 17" Touchpanel Media Center. Designed for US/International use.

SPECIFICATIONS

Connections

AC Input: (1) IEC320 male socket
Mates with removable 120V AC power cord, included

DC Output: (1) Attached 8 ft. (2.44 m) cable with 4-pin DC power plug, male

Output: 7.92 Amps minimum @ 12.5 Volts DC, regulated
Connects to PWR jack of touchpanel, or PWR IN jack of TPMC-L-IMC if used

Power Requirements

2.2 Amps @ 100-250 Volts AC, 50/60 Hz

Enclosure

Black plastic, desktop



PW-2420RU Regulated Universal Power Pack 24VDC, 2A (50 Watts)

The PW-2420RU is a 2 Amp regulated power supply designed to provide 24 Volts DC to power some models of Crestron control systems and touchpanels. Generally, the PW-2420RU may be used to power nearly any Cresnet device(s) provided the total combined power factor does not exceed 50 Watts. For US/International use.

SPECIFICATIONS

Connectors

AC Input: (1) IEC320 male socket
Mates with removable 120V AC power cord, included

DC Output: (1) Attached cable with 2.1mm barrel-type DC connector, male; center pin +

Output: 50 Watts (2 Amp @ 24 Volts DC) regulated

Power Requirements

100-250 Volts AC, 50/60 Hz

Enclosure

Black plastic, desktop



INTERFACE MODULES AND CABLES

QM-TX QuickMedia™ Transmitter

The QM-TX provides a low-cost multimedia interface solution for QuickMedia-based Touchpanels and MediaManager systems. Portable or rack-mounted, the QM-TX can be used to send audio, video, and computer signals to any QM-equipped touchpanel via Crestron's exclusive single-wire QuickMedia transport.

Five BNC's are provided on the QM-TX to accept composite, S-Video, component, HDTV, or RGB signals (up to 1600 x 1200 at 60 Hz). Balanced stereo line-level audio signals are transmitted simultaneously with 24-bit digital resolution. Video formats can be switched dynamically and automatically under system control. The QM-TX is 1/2-space rack-mountable using the optional ST-RMK kit.

SPECIFICATIONS

Video

Gain: 0dB (75 ohm termination)
Bandwidth: 100MHz (-3dB) at unity gain
Formats: Supports standard definition and HDTV up to 720p and 1080i

RGB

Gain: 0dB (75 ohm termination)
Maximum Resolution: 1600x1200 @ 60Hz (at unity gain) with cable length of 100 meters and maximum compensation at receiver (touchpanel)

Audio

A-D Conversion: Burr Brown 24-bit, 48 kHz
Frequency Response: 20Hz to 20kHz

Connectors

R/C/P_R, G/Y/Y, B/COMP/P_B, H, V: (5) BNC female RGB/Video input
 Formats: RGBHV, RGBS, RGsB, YPbPr, S-Video (Y/C), composite;
 Input Impedance: 75 ohms (R/C/P_R, G/Y/Y, & B/COMP/P_B)
 Sync Impedance: 620 ohms (H and V)
 Maximum Input Voltage: 0.7 V_{P-P} for RGB and C of S-Video; 1 V_{P-P} for composite and Y of S-Video; 5 V_{P-P} for H and V Sync;
 Video signal sensing on Y, COMP, and H

AUDIO: (1) 5-pin 3.5mm detachable terminal block
 Balanced/unbalanced stereo line-level audio input
 Maximum Input Level: 4 V_{RMS} balanced, 2 V_{RMS} unbalanced
 Input Impedance: 10k ohms balanced, 5k ohms unbalanced

QM OUT: (1) 8-wire RJ45 female, QuickMedia output port
 Connects to QM input port of touchpanel of other QuickMedia device via CresCAT-QM or CresCAT-IM cable*



NET: (2) 4-pin 3.5mm detachable terminal blocks
 Cresnet slave ports, paralleled
 Connect to Cresnet control network

G: (1) 6-32 screw, chassis ground lug

LED Indicators

PWR: (green) Indicates DC power supplied from Cresnet network
NET: (yellow) Indicates communication with Cresnet system
VIDEO ACT: (red) Indicates presence of a valid video input signal
SETUP (rear): (red) Used for touch-settable ID (TSID)

Controls

SETUP: (1) Button for touch-settable ID (TSID)

Power Requirements

Cresnet Power Usage: 5 Watts (0.21 Amp @ 24 Volts DC)

Environmental

Temperature: 41° to 104°F (5° to 40°C)
Humidity: 10% to 90% RH (non-condensing)

Enclosure

Black metal, 0.5U 19" rack mountable using optional ST-RMK (sold separately)

Dimensions

Height: 1.80 in (4.57 cm)
Width: 7.07 in (17.96 cm)
Depth: 7.02 in (17.83 cm)

Weight

2.05 lbs (0.93 kg)

AVAILABLE ACCESSORIES

ST-RMK

Rack Mount Kit

* For QuickMedia wiring use CresCAT-QM or CresCAT-IM cable; the maximum aggregate cable length and delay skew between any QM transmitter (origination point) and QM receiver (endpoint) is 450 ft (137 m) and 22 nS.

INTERFACE MODULES AND CABLES

TPMC-CH-IMC CAT5 Balanced AV Interface Module

The TPMC-CH-IMC is an audio/video interface module that is included as standard with many Isys touchpanels that utilize Crestron Home (CH) CAT5 AV connectivity*. The interface module can connect to the touchpanel using a “triamese” interface cable (included with tilt model touchpanels) or using CresCAT-D cable (sold separately). Installed neatly out of view near the touchpanel, or mounted remotely in the central equipment cabinet, the TPMC-CH-IMC provides connections for Cresnet, bidirectional audio, and (1) video input signal. The balanced CAT5 AV outputs support cable runs up to 300 feet (observe distance limitations based upon power consumption for the touchpanel in use).

Additional interface modules may be purchased and installed to facilitate connectivity for a single movable touchpanel at multiple locations. The TPMC-CH-IMC can also be used as a CAT5 balanced AV interface for use with other Crestron CAT5 AV products.

SPECIFICATIONS

Connectors

NET: (1) 4-pin 3.5mm detachable terminal block
Cresnet slave port, Connects to Cresnet control network

VIDEO COMP/Y/Y, C/Pb, Pr: (3) BNC female
Provides (1) composite, S-Video, or component video input
Input Impedance: 75 ohms
Input Level: 1 V_{P-P} nominal, 1.5 V_{P-P} maximum
Maximum DC Offset: 1.5 Volts

AUDIO IN: (1) 5-pin 3.5mm detachable terminal block
Balanced/unbalanced stereo line-level input
Input Impedance: 20k ohm balanced, 10k ohm unbalanced
Maximum Input Level: 4 V_{RMS} balanced, 2 V_{RMS} unbalanced

AUDIO OUT: (1) 5-pin 3.5mm detachable terminal block
Balanced stereo line-level output (unbuffered pass-thru from AUDIO TO PANEL)

AUDIO TO PANEL: (1) 8-pin RJ45 female
Bidirectional CAT5 balanced stereo audio port
Output Impedance: 100 ohms balanced
Maximum Output Level: 2 V_{RMS}
Input Impedance: Infinite (unbuffered pass-thru to AUDIO OUT)

VIDEO TO PANEL: (1) 8-pin RJ45 female
CAT5 balanced video output port
Output Impedance: 100 ohms balanced

NET TO PANEL: (1) 4-pin 3.5mm detachable terminal block
Pass-thru from NET port



LED Indicators

PWR: (green) Indicates DC power supplied from Cresnet network

Power Requirements

Cresnet Power Usage: 2 Watts
(0.08 Amps @ 24 Volts DC)

Environmental

Temperature: 41° to 122°F (5° to 50°C)
Humidity: 10% to 90% RH (non-condensing)

Enclosure

Black metal, surface mount box with (2) integral mounting flanges

Dimensions

Height: 1.29 in (3.28 cm)
Width: 7.30 in (18.54 cm)
Depth: 3.95 in (10.03 cm)

Weight

9.7 oz (0.28 kg)

**The TPMC-CH-IMC is not compatible with QuickMedia or 10-pin RJ45 based systems.*

INTERFACE MODULES AND CABLES

TPMC-CH-IMW CAT5 Balanced AV Interface Wall Plate

The TPMC-CH-IMW is a wall plate version of the TPMC-CH-IMC interface module, providing a wall plate connection for new Isys® TPS and TPMC-CH series touchpanels that utilize Crestron Home® (CH) CAT5 Balanced AV connectivity*. It mounts into a 2-gang electrical box and includes front panel connections for a single “triamese” cable (provided with the touchpanel or sold separately). Several TPMC-CH-IMW wall plates may be installed to facilitate connectivity for a single movable touchpanel at multiple locations.

Wired as part of a complete Crestron Home CAT5 AV distribution system, the TPMC-CH-IMW requires just a single CresCAT-D cable, carrying Cresnet, bidirectional audio, and (1) video signal up to 500 feet within a single bundled cable (observe distance limitations based upon power consumption for the touchpanel in use). The TPMC-CH-IMW can also be connected to conventional audio and coaxial video sources.



Maximum Input Level: 4 V_{RMS} balanced, 2 V_{RMS} unbalanced
Connects to any Crestron CAT5 Audio port via CresCAT cable, or a conventional audio source

AUDIO OUT: (1) 5-pin 3.5mm detachable terminal block
Balanced stereo line-level output (unbuffered pass-thru from front AUDIO port);

Connects to any Crestron CAT5 Audio port via CresCAT cable, or a conventional balanced audio input

LED Indicators

PWR: (green) Indicates DC power supplied from Cresnet network

Power Requirements

Cresnet Power Usage: 2 Watts
(0.08 Amps @ 24 Volts DC)

Environmental

Temperature: 41° to 122°F (5° to 50°C)
Humidity: 10% to 90% RH (non-condensing)

Enclosure

2-gang mountable in a standard electrical box (2.5 inch deep minimum); includes black metal front panel Decora® inserts; requires Decora faceplate (provided by others)

Dimensions

Height: 4.11 in (10.44 cm)
Width: 3.50 in (8.89 cm)
Depth: 1.66 in (4.22 cm)

Weight

7.5 oz (0.21 kg)

*The TPMC-CH-IMW is not compatible with QuickMedia or 10-pin RJ45 based systems.

SPECIFICATIONS

Connectors - Front Panel

NET: (1) 4-pin 3.5mm detachable terminal block
Pass-thru from rear NET port

AUDIO: (1) 8-pin RJ45 female
Bidirectional CAT5 balanced stereo audio port
Output Impedance: 100 ohms balanced
Maximum Output Level: 2 V_{RMS}
Input Impedance: Infinite (unbuffered pass-thru to rear AUDIO OUT port)

VIDEO: (1) 8-pin RJ45 female
CAT5 balanced video output port
Output Impedance: 100 ohms balanced

Connectors - Rear Panel

NET: (1) 4-pin 5mm detachable terminal block
Cresnet slave port, Connects to Cresnet control network

VIDEO COMP/Y/Y, C/Pb, Pr: (1) 9-pin 3.5mm detachable terminal block providing (1) composite, S-Video, or component video input
Input Impedance: 100 ohms balanced (also accepts 75 ohm unbalanced);
Input Level: 1 V_{P-P} nominal, 1.5 V_{P-P} maximum
Maximum DC Offset: 1.5 Volts
Connects to any Crestron CAT5 Video Out port via CresCAT cable, or a conventional coax video source

AUDIO IN: (1) 5-pin 3.5mm detachable terminal block
Balanced/unbalanced stereo line-level input
Input Impedance: 20k ohm balanced, 10k ohm unbalanced

INTERFACE MODULES AND CABLES

TPS/TPMC-CBL-T Triamese Cables for New Isys Touchpanels

The TPS/TPMC-CBL-T series of “triamese” cables provides a clean, flexible cable solution for Crestron’s new series of Isys 12”, 15” and 17” touchpanels. Available in 3, 6 and 9 foot lengths, these cables are designed primarily for use in combination with the TPMC-CH-IMC interface module. A single TPS/TPMC-CBL-T cable may be used in place of the 15 ft cable furnished with certain tilt model touchpanels, and is also compatible with comparable wall mount models wherever a short pre-made cable solution is called for.

Each triamese cable is composed of a single Cresnet cable terminated on each end with a 3.5mm terminal block connector, and two (2) CAT5e cables each terminated with 8-pin RJ45 connectors, providing connections for Cresnet data and power, plus bidirectional audio and (1) video signal between the module and the touchpanel.

TPS/TPMC-CBL-T cables may also be used with QuickMedia-based touchpanels to provide a clean cable solution between the touchpanel and any compatible QuickMedia interface device. These cables are not compatible with older 10-pin RJ45 based touchpanels or interface modules.



AVAILABLE MODELS

TPS/TPMC-CBL-T3-B

3 foot (0.9 meters) Triamese Cable, Black

TPS/TPMC-CBL-T3-W

3 foot (0.9 meters) Triamese Cable, White

TPS/TPMC-CBL-T6-B

6 foot (1.8 meters) Triamese Cable, Black

TPS/TPMC-CBL-T6-W

6 foot (1.8 meters) Triamese Cable, White

TPS/TPMC-CBL-T9-B

9 foot (2.7 meters) Triamese Cable, Black

TPS/TPMC-CBL-T9-W

9 foot (2.7 meters) Triamese Cable, White

INTERFACE MODULES AND CABLES

TPS-IMPC Isys® Interface Module

The TPS-IMPC is an interface module that is included as standard with every Isys TPS-3000 and TPS-4000 tilt touchpanel. Additional interface modules may be purchased and installed to facilitate connectivity for a single non-stationary touchpanel at multiple locations.

The interface module connects to the touchpanel using a “siamese” interface cable (included with the touchpanel or sold separately). Installed neatly out of view near the touchpanel, the interface module provides all of the conventional connections for power, Cresnet, audio, and video signals.



SPECIFICATIONS

Connectors

NET: (1) 4-pin 5mm detachable terminal block
Connects to Cresnet control network

24VDC: (1) 24 Volt DC power jack (PW-2420RU power supply optional, sold separately);
Powers touchpanel and module in lieu of Cresnet power

NET/VIDEO TO PANEL: (1) 10-pin RJ45 female, shielded
Connects to touchpanel via “siamese” cable (included with touchpanel);
Contains Cresnet data, 24 Volts DC power, ground, and video signals

AUDIO TO PANEL: (1) 8-pin RJ45 female, shielded
Connects to touchpanel via “siamese” cable (included with touchpanel);
Contains stereo audio input and mic out signals

AUDIO INPUT: (1) 6-pin 3.5mm detachable terminal block
Balanced/unbalanced stereo line-level input
Input Impedance: 20k ohms balanced, 10k ohms unbalanced;
Maximum Input Level: 4 V_{RMS} balanced, 2 V_{RMS} unbalanced

MIC OUT: (1) 3-pin 3.5mm detachable terminal block
Balanced/unbalanced mono line-level output
Output Impedance: 600 ohms balanced, 300 ohms unbalanced;
Maximum Output Level: 2 V_{RMS} balanced, 1 V_{RMS} unbalanced

NTSC/PAL VIDEO (Coaxial): (2) BNC female
Comprises (1) composite or S-Video input
Input Impedance: 75 ohms

NTSC/PAL VIDEO (Balanced): (1) 6-pin 3.5mm detachable terminal block;
Comprises (1) composite or S-Video input, balanced
Connects to any Crestron CAT5 balanced video source
Input Impedance: 100 ohms

DIP Switches

BAL/COAX: Selects between balanced or coaxial video inputs

Power Requirements

24VDC: <1 Watt @ 24 Volts DC – not including touchpanel (PW-2420RU power supply sold separately)

Cresnet Power Usage: <1 Watt @ 24 Volts DC – not including touchpanel

Note: If power is applied to the 24VDC jack and the NET port simultaneously, power will be drawn from whichever is highest.

Environmental

Temperature: 41° to 113°F (5° to 45°C)

Humidity: 10% to 90% RH (non-condensing)

Enclosure

Black metal, surface mount box with (2) integral mounting flanges

Dimensions

Height: 1.25 in (3.18 cm)

Width: 5.82 in (14.79 cm)

Depth: 3.50 in (8.89 cm)

Weight

12.5 oz (0.36 kg)

INTERFACE MODULES AND CABLES

TPS-4500IMPC Isys® Interface Module without Audio

The TPS-4500IMPC is an interface module that may be used with an Isys TPS-3000 or TPS-4000 tilt touchpanel whenever the touchpanel's built-in microphone and speakers are not being used. Multiple interface modules may be purchased and installed to facilitate connectivity for a single non-stationary touchpanel at multiple locations.

The interface module connects to the touchpanel using a 10-pin interface cable (included with the touchpanel or sold separately). Installed neatly out of view near the touchpanel, the interface module provides all of the conventional connections for power, Cresnet, and video signals.



Environmental

Temperature: 41° to 113°F (5° to 45°C)

Humidity: 10% to 90% RH (non-condensing)

Enclosure

Black metal, surface mount box with (2) integral mounting flanges

Dimensions

Height: 1.25 in (3.18 cm)

Width: 5.82 in (14.79 cm)

Depth: 3.50 in (8.89 cm)

Weight

12.4 oz (0.36 kg)

SPECIFICATIONS

Connectors

NET: (1) 4-pin 5mm detachable terminal block
Connects to Cresnet control network

24VDC: (1) 24 Volt DC power jack
(PW-2420RU power supply optional, sold separately)
Powers touchpanel and module in lieu of Cresnet power

NET/VIDEO TO PANEL: (1) 10-pin RJ45 female, shielded
Connects to touchpanel via "siamese" cable (included with touchpanel);
Contains Cresnet data, 24 Volts DC power, ground, and video signals

NTSC/PAL VIDEO (Coaxial): (2) BNC female
Comprises (1) composite or S-Video input
Input Impedance: 75 ohms

NTSC/PAL VIDEO (Balanced): (1) 6-pin 3.5mm detachable terminal block;
Comprises (1) composite or S-Video input, balanced
Input Impedance: 100 ohms
Connects to any Crestron CAT5 balanced video source

DIP Switches

BAL/COAX: Selects between balanced or coaxial video inputs

Power Requirements

24VDC: <1 Watt @ 24 Volts DC – not including touchpanel
(PW-2420RU power supply sold separately)

Cresnet Power Usage: <1 Watt @ 24 Volts DC – not including touchpanel

If power is applied to the 24VDC jack and the NET port simultaneously, power will be drawn from whichever is highest.

INTERFACE MODULES AND CABLES

TPS-IMW Isys® Interface Module Wall Plate

The TPS-IMW is a wall plate version of the TPS-IMPC interface module, providing a flush wall plate connection for any Isys TPS-3000 or TPS-4000 tilt touchpanel. The TPS-IMW mounts into a 2-gang electrical box (2.5" minimum depth) and includes front panel RJ45 connections for the siamese type cable (provided with the touchpanel or sold separately). Several interface module wall plates may be installed to facilitate touchpanel connectivity at multiple locations.

SPECIFICATIONS

Connectors - Front Panel

NET/VIDEO: (1) 10-pin RJ45 female, shielded
Connects to touchpanel via "siamese" cable (included with touchpanel);
Contains Cresnet data, 24 Volts DC power, ground, and video signals

AUDIO: (1) 8-pin RJ45 female, shielded
Connects to touchpanel via "siamese" cable (included with touchpanel);
Contains stereo audio input and mic out signals

Connectors - Rear Panel

NET: (1) 4-pin 5mm detachable terminal block
Connects to Cresnet control network

NTSC/PAL VIDEO: (1) 6-pin 3.5mm detachable terminal block comprising (1) composite or S-Video input, balanced or unbalanced;
Input Impedance: 100 ohms (will accept 75 ohm coaxial video)

AUDIO INPUT: (1) 6-pin 3.5mm detachable terminal block
Balanced/unbalanced stereo line-level input
Input Impedance: 20k ohms balanced, 10k ohms unbalanced
Maximum Input Level: 4 V_{RMS} balanced, 2 V_{RMS} unbalanced

MIC OUT: (1) 3-pin 3.5mm detachable terminal block
Balanced/unbalanced mono line-level output
Output Impedance: 600 ohms balanced, 300 ohms unbalanced;
Maximum Output Level: 2 V_{RMS} balanced, 1 V_{RMS} unbalanced

Power Requirements

Cresnet Power Usage: <1 Watt @ 24 Volts DC - not including touchpanel

Environmental

Temperature: 41° to 113°F (5° to 45°C)

Humidity: 10% to 90% RH (non-condensing)



Enclosure

2-gang mountable in a standard electrical box; includes black metal front panel Decora® inserts; requires Decora faceplate (provided by others)

Dimensions

Height: 4.11 in (10.44 cm)

Width: 3.50 in (8.89 cm)

Depth: 1.51 in (3.82 cm)

Weight

0.48 lb (0.22 kg)

INTERFACE MODULES AND CABLES

TPS-4500IMW Isys® Interface Module Wall Plate without Audio

The TPS-4500IMW is a wall plate version of the TPS-4500IMPC interface module, providing a flush wall plate connection for any Isys TPS-3000 or TPS-4000 tilt touchpanel whenever the touchpanel's built-in microphone and speakers are not being used. The TPS-4500IMW mounts into a single-gang electrical box (2.5" minimum depth) and includes one front panel RJ45 connection for the 10-pin cable that connects to the touchpanel (provided with the touchpanel or sold separately). Several interface module wall plates may be installed to facilitate touchpanel connectivity at multiple locations.



SPECIFICATIONS

Connectors - Front Panel

NET/VIDEO: (1) 10-pin RJ45 female, shielded
Connects to touchpanel via "siamese" cable (included with touchpanel);
Contains Cresnet data, 24 Volts DC power, ground, and video signals

Connectors - Rear Panel

NET: (1) 4-pin 5mm detachable terminal block
Connects to Cresnet control network

COMP/Y: (1) 4-pin 3.5mm detachable terminal block comprising (1) composite or 'Y' of (1) S-Video input, balanced or unbalanced;
Input Impedance: 100 ohms balanced, 75 ohms unbalanced

C: (1) 4-pin 3.5mm detachable terminal block 'C' of (1) S-Video input, balanced or unbalanced
Input Impedance: 100 ohms balanced, 75 ohms unbalanced

Power Requirements

Cresnet Power Usage: <1 Watt @ 24 Volts DC – not including touchpanel

Environmental

Temperature: 41° to 113°F (5° to 45°C)
Humidity: 10% to 90% RH (non-condensing)

Enclosure

1-gang mountable in a standard electrical box; includes black metal front panel Decora® insert; requires Decora faceplate (provided by others)

Dimensions

Height: 4.27 in (10.85 cm)
Width: 2.51 in (6.36 cm)
Depth: 1.49 in (3.77 cm)

Weight

0.32 lb (0.14 kg)

INTERFACE MODULES AND CABLES

TPS-CBL-S Siamese Cable for Isys® Tilt Touchpanels

Isys TPS-CBL-S “siamese” cables are designed for use with Isys TPS-3000 and TPS-4000 tilt touchpanels. Available in a variety of lengths, a TPS-CBL-S cable may be used in place of the longer 15' cable provided with the touchpanel, carrying Cresnet, video, and audio signals between the touchpanel base and interface module in a singular lightweight, flexible cable assembly.

AVAILABLE MODELS

TPS-CBL-S3

Length: 3 foot (0.9 meters)

TPS-CBL-S6

Length: 6 foot (1.8 meters)

TPS-CBL-S9

Length: 9 foot (2.7 meters)

SPECIFICATIONS

Connectors

(2) 10-pin RJ45 male, shielded

(2) 8-pin RJ45 male, shielded

Carries Cresnet data, 24 Volts DC power, ground, video, and audio signals



TPS-CBL Cable for Isys® Tilt Touchpanels

Isys TPS-CBL cables are designed for use with Isys TPS-3000 and TPS-4000 tilt touchpanels whenever the touchpanel’s built-in microphone and speakers are not being used. Available in a variety of lengths, a TPS-CBL cable may be used in place of the longer 15' cable provided with the touchpanel, carrying Cresnet and video signals between the touchpanel base and interface module in a single lightweight, flexible cable.

AVAILABLE MODELS

TPS-CBL-3

Length: 3 foot (0.9 meters)

TPS-CBL-6

Length: 6 foot (1.8 meters)

TPS-CBL-9

Length: 9 foot (2.7 meters)

SPECIFICATIONS

Connectors

(2) 10-pin RJ45 male, shielded

Carries Cresnet data, 24 Volts DC power, ground, and video signals



INTERFACE MODULES AND CABLES

TPSBLOCK-10 10-Pin Connector Block for Isys® Tilt Touchpanels

The TPSBLOCK-10 provides a simplified connectivity solution for Isys TPS-3000 and TPS-4000 tilt touchpanels. This chassis-mount 10-pin RJ45 jack is suitable for installation on any custom panel, or in standard adapter plates offered from other manufacturers. An integral 10' cable is included, terminated at the other end with a 10-pin RJ45 male connector.

The TPSBLOCK-10 is compatible with Crestron TPS-IMPC and TPS-4500IMPC interface modules, allowing the installer to hide the interface module beneath a tabletop or inside a lectern while providing a convenient, clean-looking connection above surface for the touchpanel.



SPECIFICATIONS

Connectors

- (1) 10-pin RJ45 female, chassis-mount, shielded
- (1) 10-pin RJ45 male, shielded

Length

10 ft (3.05 m)

ST-PK Programming Cable Kit

It is used only for loading touchpanel files, updating firmware, and configuring the touchpanel prior to operation. The ST-PK may also be used to update firmware and adjust the digital audio signal processing in Crestron's 7.1 surround sound processors and room solution boxes.



SPECIFICATIONS

Cables

3.5mm to RJ11 Cable Assembly (CNSP-585):

Provides connection between a SmarTouch wireless touchpanel and the control processor via a RJ11 Cresnet port; may require an additional CNRJ11, ST-CNB, or C2N-HBLOCK accessory.

RJ11-to-RJ11 Cable plus RJ11-to-DB9F Adapter (STCP-502):

Provides connection between an Isys touchpanel, surround processor, or room solution box RS-232 port and PC COM port.

SWIVEL BASES AND HATCHBACK

HBK-3000 Hatchback for Isys® 6.4" and 10.4" Tilt Touchpanels

The HBK-3000 hatchback is an optional rear cover accessory for Isys TPS-3000 and TPS-6000 tilt touchpanels. The hatchback is designed to conceal the connections at the back of the touchpanel base, preventing disconnection and providing cable strain relief.



SMK-3000 Swivel Mount for Isys® 6.4" and 10.4" Tilt Touchpanels

The SMK-3000 swivel mount is an optional mounting accessory for Isys TPS-3000 and TPS-4000 tilt touchpanels. The swivel mount provides a means of permanently mounting the touchpanel base to a flat countertop or tabletop surface* while still allowing for optimal positioning with 330-degree rotation. Once installed, the swivel mount may be locked in position if desired.

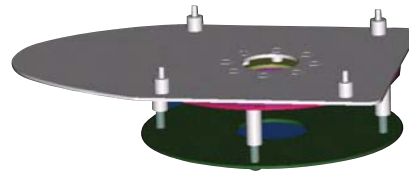

The swivel mount kit includes an HBK-3000 hatchback to conceal the connections at the back of the touchpanel base. Cables may be passed out the back of the cover, or ideally routed down through the center of the swivel mechanism for a completely hidden solution.

**Surface thickness must be 3/4-inch minimum to 1 3/8-inches maximum using the hardware provided.*

SMK-12/15/17 Swivel Mount for Isys® 12", 15", and 17" Tilt Touchpanels

The SMK-12/15/17 swivel mount is an optional mounting accessory for new Isys 12, 15, and 17 inch tilt touchpanels including TPS, TPS-G, and TPMC series. The swivel mount provides a means of permanently mounting the touchpanel base to a flat countertop or tabletop surface* while still allowing for optimal positioning with 330-degree rotation. Cables may be passed out the back of the touchpanel, or routed down through the center of the swivel mechanism** for a completely hidden solution.



**Surface thickness must be 3/4-inch minimum to 1 3/8-inches maximum using the hardware provided.*

***The touchpanel must include a notch at the rear of the bottom plate to allow for cable pass-thru.*

Isys Tilt Touchpanels diagrams

Typical Isys Tilt Touchpanel Application using Crestron Home CAT5 AV

