



CS7000 Controller

Hardware Overview Manual

With Ethernet/CCM Information

for use with

177 and 277 Series Electric Fastening Tools

CP Ref. / N° : 6159939130
Techmotive P/N : 39-30-41365

December 2005

**24-Hour
Technical Support
Toll Free in the U.S. and Canada:
1-877-224-7377**

**All other countries:
(001) 248-348-6280
between 8 a.m. and 5 p.m.
Eastern Standard Time (EST)**

NOTE: Chicago Pneumatic Tool Company (CP) in 2005 acquired and changed the name of GSE tech-motive tool to CP Techmotive. Product Information may be found on www.cp.com.

NOTE: The part number for the Visual Supervisor (VS) software program is 464000-03330 (CP part number 6150040915)

NOTE: A variety of related **technical manuals** in .pdf format may be downloaded from www.cp.com. Click on **the Technical Info link** on the left column. Select *Technical Documentation*. Scroll through the list to find the title of the product you require, and click!

CP Techmotivemanufactures products under the CP, CP Techmotive, and *tech-motive tool*[®] brand names
Information and technical diagrams in this manual are **subject to change without notice**. *techmotive tool* is a registered trademark. Products and services referred to in this book may be either trademarks and/or registered trademarks of their respective owners.

LIMITED WARRANTY

CP Techmotive warrants its PRODUCTS to be free from defects in materials and workmanship for the lesser of (1) one year from the date of shipment from the manufacturing facility in Michigan, U.S.A. OR (2) one-million cycles except for the products noted below:

CP Techmotive crowfoot, tubenut and hold & drive heads	250,000 cycles
3 rd -party crowfoot, tubenut, hold-and-drive torque multiplier or other heads	manufacturer's warranty
56 and 116 Series nutrunners	500,000 cycles

PRODUCTS include CP Techmotive brand fastening tools, controllers and cables, GSE brand sensors and instruments, and anti-lock brake testing systems. Fuses and batteries are not covered under warranty.

For PRODUCTS verified as defective at CP Techmotive's manufacturing facility, CP Techmotive shall have the option, in its sole discretion, to repair or replace the products or components. CP Techmotive shall not be liable for any installation charges, expenses of the Buyer for repairs or replacement, damages from delay or loss of use, or other indirect or consequential damages of any kind. The warranty does not cover any product that has been modified without the approval of CP Techmotive, used for a purpose other than that for which it was intended, used in a manner inconsistent with any instructions, subjected to unusual physical stress, environmental or electrical conditions, or whose original identification marks have been removed or altered.

Whenever the PRODUCTS are to be incorporated in a system, the design of which originated with the Buyer, CP Techmotive only that the PRODUCTS shall be free of defects in materials and workmanship and offers no other warranty.

In the event that a product is repaired or replaced under the terms of the warranty, the warranty period for the repaired or replacement product shall be limited to the remaining portion of the original warranty.

Any warranty extended by the original manufacturer of peripheral equipment, such as printers, recorders, plotters, etc., included with a CP Techmotive product or system shall be extended to the Buyer and shall be the only warranty offered.

Transportation charges for materials shipped to the manufacturing facility for warranty repair are to be paid by the Buyer. CP Techmotive will pay for shipping to return items repaired or replaced under warranty.

THIS LIMITED WARRANTY IS EXCLUSIVE, AND CP Techmotive MAKES NO OTHER WARRANTY OF ANY KIND WHATSOEVER, WHETHER EXPRESSED, IMPLIED OR STATUTORY, WITH RESPECT TO THE PRODUCTS OR PARTS MANUFACTURED BY IT, WHETHER AS TO MERCHANTABILITY, FITNESS FOR A PARTICULAR PURPOSE OR ANY OTHER MATTER OR WARRANTY OF ANY KIND. No agent, employee or representative of CP Techmotive has the authority to bind CP Techmotive in any affirmation, representation, or warranty concerning the Products or parts except as stated herein.

THIS REMEDY SHALL BE THE EXCLUSIVE REMEDY AVAILABLE FOR ANY NONCONFORMITIES IN MATERIALS OR WORKMANSHIP, OR FOR ANY DAMAGES RESULTING FROM ANY OTHER CAUSE WHATSOEVER. CP Techmotive SHALL NOT, IN ANY EVENT, BE LIABLE FOR ANY SPECIAL, INDIRECT, INCIDENTAL OR CONSEQUENTIAL DAMAGES OF ANY KIND, NATURE OR DESCRIPTION, WHETHER FOR NONCONFORMITIES IN MATERIALS OR WORKMANSHIP UNDER ANY WARRANTY, IN CONTRACT, TORT, NEGLIGENCE, STRICT LIABILITY, OR FOR ANY OTHER REASON.

CUSTOMER SATISFACTION

Please Read This!

As a valued customer, your opinion and satisfaction are important to CP Techmotive. Please let us know what you think of our product(s).

Write the part number and serial number of the product(s) you have purchased before you begin our brief online survey. The numbers are located on a sticker affixed to the handle of the nutrunner or screwdriver, and exterior or interior of the controller.

Tool Label

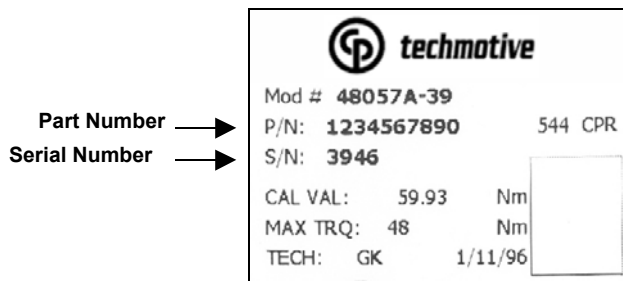

Controller Label

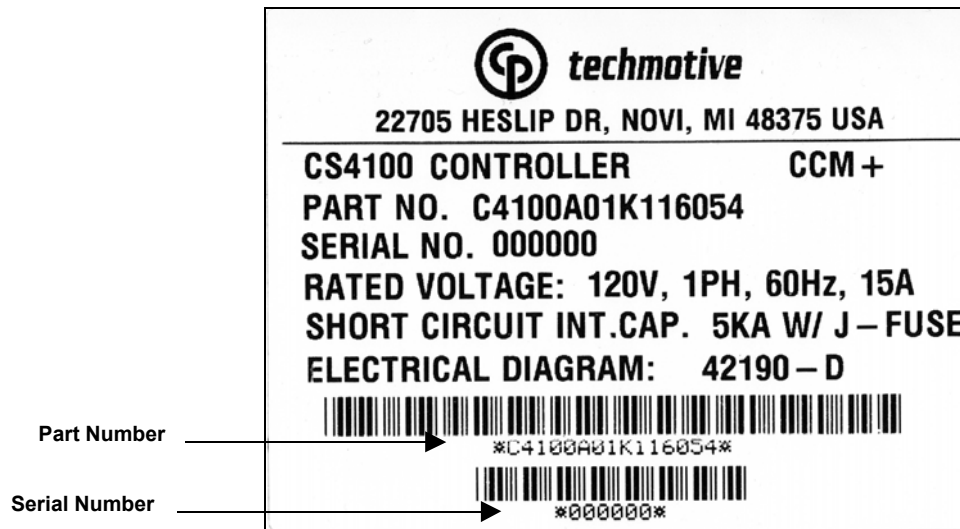

To complete the survey:

1. Visit our website www.cp.com and click www.gsetechmotive.com
2. Click the Customer Satisfaction Survey link located below the gray buttons in the red, left-hand frame.
3. Fill in the fields and click the appropriate choices.
4. Click the Submit to GSE tech-motive tool button

Preface

The CS7000 Controller manufactured by CP techmotive is a component of one of the most powerful DC electric nutrunner fastening control systems available. The system uses 100% digital technology to ensure accurate and reliable fastening and data acquisition. Microprocessors in both the fastening tool and the controller's tool control module (TCM) enable the system to perform to levels of accuracy while providing easy set-up and operation previously unattainable.

With Intelligent tool technology you no longer need to enter tool identification, calibration, angle counts, speed and other information. You simply plug in the tool, power on the system, program the desired tightening specifications and begin production.

A complete nutrunner fastening control system is made up of the CS7000 Controller, a cable and a CP techmotive 177 or 277 Series nutrunner. The powerful CP techmotive Visual Supervisor software program is used for system setup, fastening, data collection, and diagnostics.

Who Should Use This Manual

This manual is written for the engineers, technicians and users who will set-up and/or operate the CS7000 Controller with any of the Intelligent (177 and 277 Series) nutrunners.

How to Use This Manual

This manual provides installation, maintenance and technical information about the CS7000 Controllers.

This Preface provides conventions and abbreviations used throughout this manual.

If you have never used a CS7000 Controller, read this manual entirely. The first two chapters will help you become familiar with safety requirements, the location of components, software and features.

If you are already familiar with the CS7000 Controller, look over *Chapter 3. Installing the CS7000 Controller* and *Chapter 4. Technical Information*, which describe the power requirements, details of the I/O wiring and connectors, replacement parts and fuses.

Conventions

The following conventions are used throughout this manual for the safety of personnel, equipment, software, and data. The conventions include warnings, cautions and notes, as follows:

WARNING! *It can be dangerous to personnel and/or machine systems, if operating instructions are not followed. The information appears in a box in italicized boldface type.*

CAUTION! *There may be damage to equipment, and loss of software and data, if operating instructions are not followed. The information is indented and in italicized boldface type.*

NOTE: *Information that adds to your knowledge of the equipment and/or software. The information is indented and italicized.*

Abbreviations

Some of the most common abbreviations used throughout this manual include the following:

API	application program interface
ESD	electro-static discharge
GFCI	ground fault circuit interrupter
I/O	input/output
IEC	International Electrotechnical Commission
IEEE	Institute of Electrical and Electronic Engineers
IP	internet protocol
kbps	kilo-bits per second
kVA	kilovolt-ampere
LAN	local area network
LED	light emitting diode
mbps	million bits per second
PCI	peripheral component interconnect
TCM	tool control module
TCP/IP	transmission control protocol/internet protocol
RAM	random access memory
SDLC	synchronous data link control
STM	standard test method
TINI	tiny internet interface
V	volts
VS	Visual Supervisor is the setup, fastening, data collection, and diagnostics software program designed by CP techmotive

(This page is left blank intentionally.)



Contents

Who Should Use This Manual.....	i
How to Use This Manual.....	i
Conventions.....	ii
Abbreviations.....	iii
Contents.....	v
Figures.....	vii
Tables.....	vii
1. Think Safety First!	1-1
General Machine Safety.....	1-1
Electrical Safety.....	1-3
2. Identifying the Components.....	2-1
Front Panel	2-2
Latch.....	2-3
Rotary Actuator.....	2-3
Parameter Select Switch.....	2-3
LED Display.....	2-3
Top Panel.....	2-4
Bottom Panel.....	2-4
Tool Connector.....	2-5
Input AC Power.....	2-5
Printer/Barcode Connector.....	2-5
RS-232 Connector (VS Setup).....	2-5
SDLC/485 I/O Network Connector (Optional).....	2-5
Ethernet (10Base-T) and 9-pin D (Communications/Diag) Setup.....	2-5
I/O Connector.....	2-6
Enclosure Interior.....	2-6
Gen2 Tool Control Module (TCM).....	2-8
Servo Amplifier.....	2-9
Gen2 Device Control Module (DCM).....	2-9
Communications Control Module (CCM) “Optional”.....	2-10
Backplane.....	2-11
Backplane Fuses.....	2-11
DIP Switch Settings.....	2-12
Power Supply.....	2-12
Ground Fault Circuit Interrupter (GFCI).....	2-12
Disconnect Switch.....	2-13
Circuit Breaker/Fuses.....	2-13
3. Installing the CS7000 Controller	3-1
Mounting the CS7000 Controller.....	3-1
Emissions and Susceptibility.....	3-2
Meeting the AC Input Power Requirements.....	3-3
Input Power Protection.....	3-3



Grounding	3-4
I/O Wiring	3-4
Connector Pinout Definitions	3-8
Tool Connector “26 pin” (Metal SMC) – Front View	3-8
I/O Connector – Front View	3-9
TCM (IN and OUT) Network Connectors – Front View	3-9
RS-232 Connector – Front View	3-9
Printer/Computer/Diagnostics (RS-232) Connector – Front View	3-10
Programming the CS7000 Controller (In General)	3-10
Programming the CS7000 with Ethernet (CCM)	3-10
4. Technical Information	4-1
Replacement Parts	4-1
Cleaning the Enclosure Window	4-1
Assembly Drawings	4-1
Contact Information	4-2
5. Index	5-1



Figures

Figure 2-1.	Front Panel View	2-2
Figure 2-2.	Turning the Rotary Actuator to the ON Position	2-3
Figure 2-3.	Top Panel View	2-4
Figure 2-4.	Bottom Panel View	2-4
Figure 2-5.	Components Inside the Enclosure of the CS7000 Controller	2-7
Figure 2-6.	Front View of the TCM	2-8
Figure 2-7.	Communications Control Module (CCM)	2-10
Figure 2-8.	CS7000 Controller Backplane	2-11
Figure 2-9.	Ground Fault Circuit Interrupter	2-12
Figure 3-1.	CS7000 Controller Dimensions of the Front and Bottom Panel.....	3-2
Figure 3-2.	Remote Input Circuit Schematics	3-7

Tables

Table 3-1.	19-Position Remote I/O Connector Pinout Signal Names and Descriptions	3-4
Table 3-2.	Guidelines for Proper Operation of the Controller I/O Signals	3-7
Table 4-1.	Replacement Parts	4-1

(This page is left blank intentionally.)



1. Think Safety First!

Working with fastening tools can be dangerous if safe and proper procedures are not followed. As with all machinery, certain hazards can be involved with the operation of the product. Using these tools with respect and caution will considerably lessen the possibility of personal injury. If, however, safety precautions are overlooked or ignored personal injury to the operator can result.

Always use common sense and exercise caution when using these tools. They can produce high torque that, unless properly compensated for, could cause personal injury. Remember, your personal safety is *your* responsibility.

If you are an operator or CP techmotive-qualified service technician, you should become familiar with the contents of this manual before operating, servicing, or maintaining any part of the CS7000 Controller. Familiarization with all components of the system can minimize the possibility that an accident or injury might occur.

CP techmotive assumes no responsibility for personal injury or damage to equipment resulting from misuse of these tools. After reviewing this manual you should also review all safety procedures provided by your company and the equipment installer.

WARNING! *Failure to follow these steps can result in serious personal injury.*



General Machine Safety

- FOR YOUR OWN SAFETY READ THE INSTRUCTION MANUAL THOROUGHLY PRIOR TO OPERATING THE TOOL.
- DO NOT WORK IN A DANGEROUS ENVIRONMENT. Do not use power tools in a damp or wet location or explosive atmosphere, or expose them to rain, oils, or corrosive fluids.
- KNOW THE LOCATION OF POWER DISCONNECTS AND EMERGENCY STOP BUTTONS PRIOR TO OPERATING THIS EQUIPMENT.
- KEEP ALL ELECTRICAL PANELS CLOSED DURING OPERATION. High voltage present inside enclosure panels can result in personal injury. Do NOT bypass or defeat electrical safety devices. Turn the power actuator to the OFF position prior to any servicing or maintenance of the controller.
- Observe all government and/or company power lockout standards.
- NEVER OPERATE SOLENOID VALVES, LIMIT SWITCHES OR RELAYS MANUALLY as this practice can create dangerous, unexpected machine movements.

- **SECURE THE TOOL.** Tools that develop torque can produce hazardous torque reactions. Always be sure that the tool is properly fixtured to absorb reaction as a fastener is tightened. Never operate a tool capable of high torque without proper fixturing.
- **SECURE WORK.** Avoid situations where the part being fastened breaks loose and can cause damage.
- **NEVER TOUCH OR ATTEMPT TO STOP MOVING MACHINERY OR PARTS WITH YOUR HANDS, OTHER PARTS OF YOUR BODY, OR MAKESHIFT DEVICES.**
- **DO NOT OPERATE THE TOOL WHILE UNDER THE INFLUENCE OF ALCOHOL, DRUGS OR MEDICATION THAT CAN IMPAIR YOUR JUDGMENT.**
- **REPORT ALL UNSAFE WORKING CONDITIONS OR PRACTICES TO YOUR SUPERVISOR AND / OR SAFETY DEPARTMENT FOR CORRECTION.**
- **WEAR APPROVED SAFETY GLASSES AT ALL TIMES.**
- **DO NOT WEAR JEWELRY,** especially bracelets and rings, while operating the fastening tools. Keep hands and fingers away from all rotating parts and avoid situations where clothing can become tangled in the tool. Secure loose fitting clothing, neckties, and long hair. Wear medical alert identification cautiously.
- **DO NOT OVERREACH.** Keep proper footing and balance at all times.
- **KEEP YOUR WORK AREA CLEAN.** Do not work on or near slippery floors or surfaces. Avoid situations where the tool reacts against unexpected obstacles. Do not operate electrical equipment while standing on a wet floor.
- **MAINTAIN TOOLS IN TOP CONDITION.** Keep tools properly lubricated and clean. If any wires become frayed or exposed, replace them immediately. Prevent dirt, grease or contaminants from getting into the tool.
- **REDUCE THE RISK OF UNINTENTIONAL STARTING.** Be careful how the tool is left unattended. Avoid resting it on its throttle lever to prevent false starts.
- **CONTROL THE DIRECTION OF ROTATION.** The reaction torque changes direction when going from forward to reverse. Always be aware in which direction the tool will rotate prior to using it. If the tool is not fixtured this will allow you to brace for the proper direction of torque reaction.
- **CHECK DAMAGED PARTS.** Before further use of a tool, any part of the tool that is damaged should be carefully checked to ensure that it will operate properly and perform its intended function. Check for alignment of moving parts, breakage of parts, mounting, and any other conditions that may affect its operation. Never operate a tool that has damaged or exposed wires. Never operate a tool that has any part of the powertrain, other than the output spindle, exposed.



Electrical Safety

Only qualified and properly trained personnel should perform electrical/electronic troubleshooting and repair. Consider the following electrical system safety guidelines:

- Before you troubleshoot or service a fastening system station, be sure you have an up-to-date and appropriate set of electrical drawings for that station.
- Remove metal items, such as rings, metal necklaces, wristwatches and jewelry, as these can create electrical hazards. Wear medical alert identification cautiously.
- Wear safety glasses, but avoid wearing those that have metal rims or metal side shields.
- It may be necessary to troubleshoot equipment while the power is ON. ONLY qualified, trained personnel should do this. During these instances, open only the panels, doors, or covers which need to be opened. Know the voltage present at all points before you begin troubleshooting.
- Use properly insulated tools when working on electrical equipment to reduce the possibility of shock. Make sure the insulation is adequate to safeguard against the high voltages present.
- If you must work on the electrical system, be sure the main disconnect switch on the power panel is in the OFF position and locked out with locks from each trade involved in the repair.
- Do not attempt to modify or repair the machine without the approval of the proper authorities.
- Use approved fuse pullers when changing fuses.
- Never use jumper wires or fuse substitutes to replace specified fuses.
- Always use fuses of a capacity smaller than or equal to the safe capacity of the line or the equipment it serves.
- Before you work on any circuit, check it with an appropriate testing device to be sure voltage is not present.
- Install temporary wiring as safely as possible and replace it with permanent wiring as soon as possible. Install grounding wherever it is needed in the installation. If modifications are made to the system wiring, drawings must be revised to illustrate this change.
- Know how to deal with electrical fires properly. Keep carbon dioxide and powder extinguishers handy.

(This page is left blank intentionally.)



2. Identifying the Components

This chapter is designed to familiarize you with the components of the CS7000 Controller. It has four sections to help you locate all the major components easily:

- Front Panel
- Top Panel
- Bottom Panel
- Enclosure Interior

Each section includes figures that call out the components. Descriptions of the components follow the figures.

Front Panel

Figure 2-1 shows the front panel components of the CS7000 Controller. Descriptions are provided in clockwise order, starting with the latch.

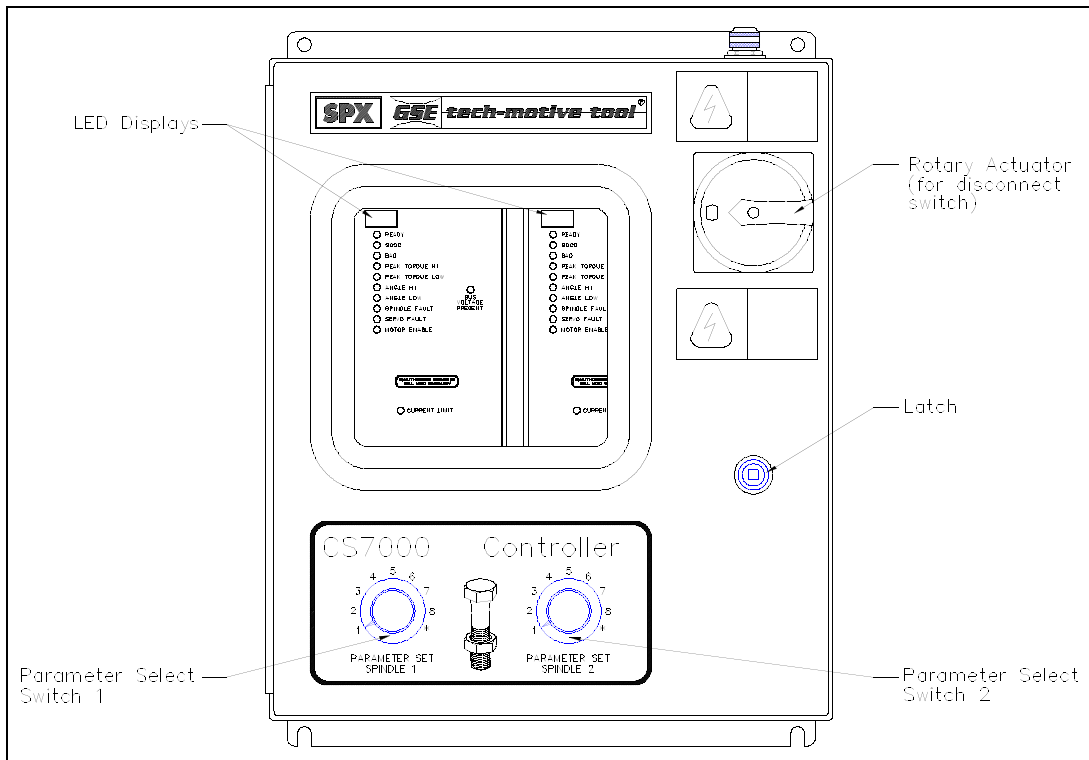

Figure 2-1. Front Panel View



Latch

The latch keeps the front panel of the controller closed. To open it you need a key (part number 31-80-0414).

Rotary Actuator

The rotary actuator is a safety device that allows you to open the enclosure door only when the disconnect switch is in the OFF position. The rotary actuator is mechanically interlocked with the disconnect switch, which is located inside the enclosure. The ON and OFF positions on the rotary actuator correspond to the ON and OFF positions of the disconnect switch.

Turn the rotary actuator clockwise to turn on power to the controller. The arrow on the rotary actuator must rotate 90 degrees from \leftarrow to \uparrow , as shown in Figure 2-2.

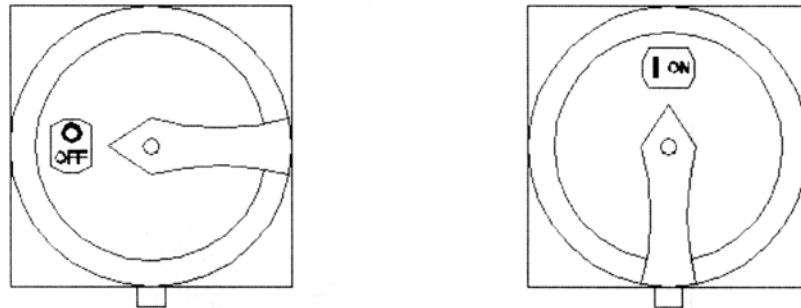

Figure 2-2. Turning the Rotary Actuator to the ON Position

Parameter Select Switch

The parameter select switch selects the next parameter set that will be used by the tool. The limits for the parameter set are specified using Visual Supervisor (VS). This switch lets you select up to 8 different parameter sets even though the controller is capable of more.

LED Display

The LED display shows you the torque, or torque and angle value for the most recent rundown. It also scrolls messages for the operator. For example, if a barcode scan is required before the next rundown, the operator sees a barcode prompt on the LED display.

Top Panel

Figure 2-3 shows the top panel components of the CS7000 Controller.

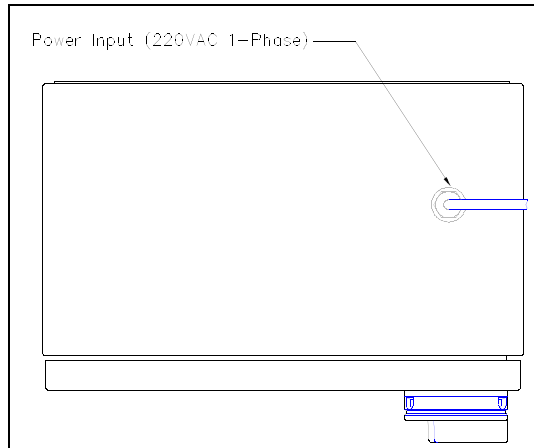

Figure 2-3. Top Panel View

Bottom Panel

Figure 2-4 shows the bottom panel components of a CS7000 Controller. Connector configurations will vary depending on the model.

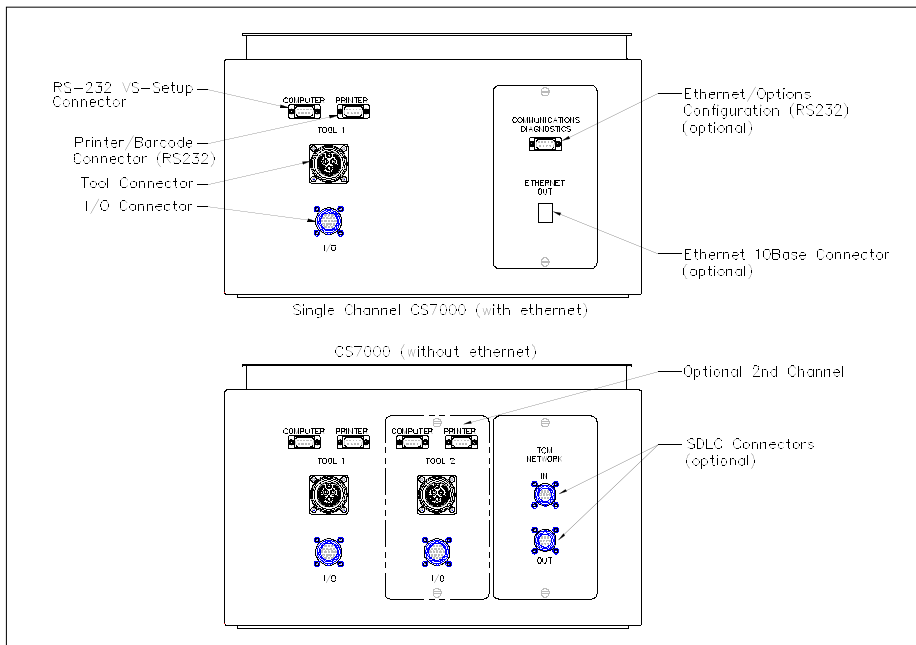

Figure 2-4. Bottom Panel View



Tool Connector

A 26 position metal (SMC) connector is the interface between the 177 and 277 Series nutrunner cable and control electronics. Refer to *Connector Pinout Definitions* in *Chapter 3. Installing the CS7000 Controller* for pinout details.

Input AC Power

The CS7000 Controller is shipped with a 6-ft power cable with Hubble connector 2321-CY. Power is 220 VAC. Refer to Chapter 3 for details.

Printer/Barcode Connector

The nine-position asynchronous RS-232 serial output connector allows you to use a printer. The printer can be used to generate hard copies of torque, or torque and angle readings upon command from the controller. This port can also be used to receive barcode information.

RS-232 Connector (VS Setup)

The nine-position asynchronous RS-232 serial output connector allows you to communicate with the controller using a laptop computer. The laptop computer runs the VS software program that allows you to program torque, or torque and angle limits and operating modes into the controller. Refer to the *Visual Supervisor User's Guide* (part number 39-30-34823) for details.

NOTE:  *The laptop computer also allows you to program (also referred to as 'flash') the latest device control module (DCM) and tool control module (TCM) firmware into the controller.*

SDLC/485 I/O Network Connector (Optional)

The 10-position female SDLC/485 connector enables a permanent network connection to and from the controller, other controllers in the network and a permanently connected computer

Ethernet (10Base-T) and 9-pin D (Communications/Diag) Setup

These connectors are available on some versions for providing Ethernet connectivity to a LAN as well as providing a port for configuring the Ethernet/communications functions. At present, the 9-pin-D is configured as an RS232 port running at 9600 baud (8 data, 1stop, no parity) and will interface directly with a terminal emulator program (hyperterminal etc.)

I/O Connector

The 19-position remote I/O connector provides the interface between external control/monitoring devices and the internal control electronics. CP techmotive accessories, such as sockettrays, are connected here.

The mating connector for this port is a 14-shell, 19-pin, strain relief (SR) connector (part number 23-10-5200). The mating connector enables connection of your own remote control and/or monitoring devices, such as external annunciator lamps or remote cycle-on contacts. Refer to *I/O Wiring* in *Chapter 3. Installing the CS7000 Controller* for pinout details.

Enclosure Interior

The enclosure interior for the CS7000 Controller includes the following components and sub-components:

- Sub-panel, that includes:
 - Disconnect switch
 - Power supply (24 VDC)
 - Circuit breaker/ Fuses
 - Ground fault circuit interrupter (GFCI)

- Backplane, that includes:
 - Address switch
 - DCM fuse (internal DCM power)
 - I/O power (24 VDC) fuses

- TCM, that includes:
 - DCM control card
 - Servo
 - Communications Control Module (CCM) optionally

See Figure 2-5 on page 2-7 and Figure 2-6 on page 2-8.

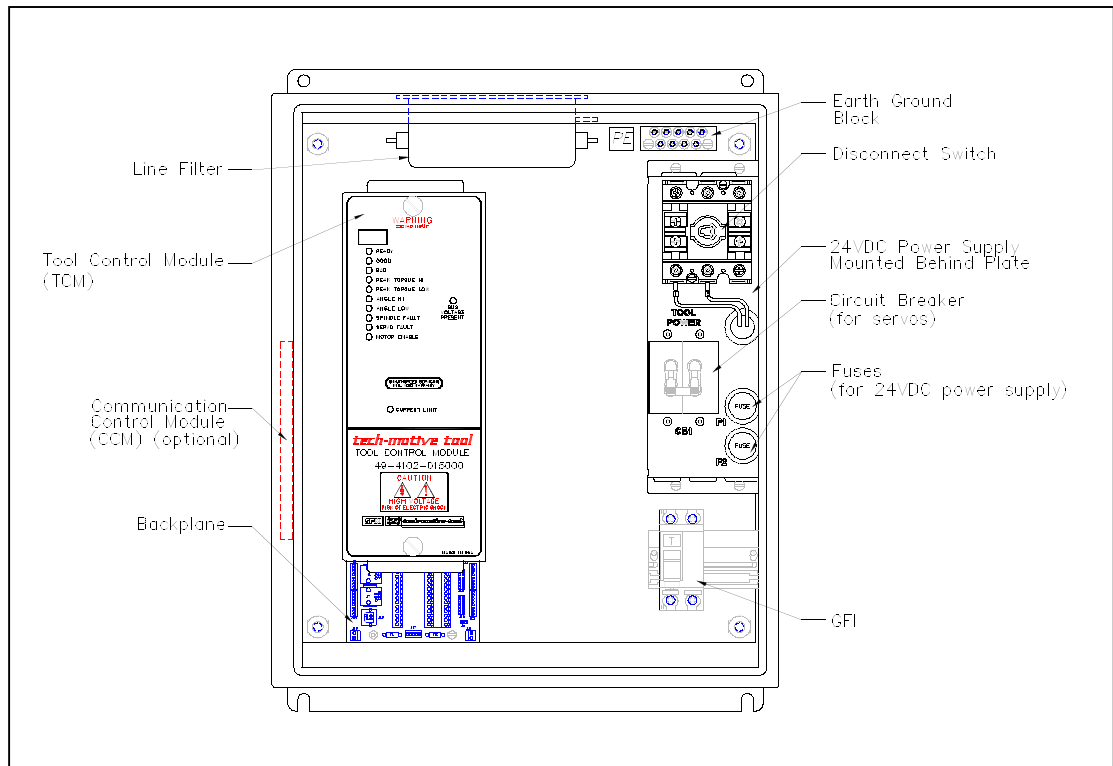

Figure 2-5. Components Inside the Enclosure of the CS7000 Controller

Gen2 Tool Control Module (TCM)

The TCM, shown in Figure 2-6, is a device that controls a single DC electric tool. The TCM and its attached tool are referred to as a spindle. The TCM houses both the servo amplifier and DCM.



Figure 2-6. Front View of the TCM

WARNING! *This servo contains a fast discharge circuit to discharge the internal capacitors within a few seconds. However, you should still be careful when handling the TCM. A “bus voltage present” light on the front of the unit will extinguish when the bus voltage has dropped below approximately 70VDC.*

The TCM has a small four-digit display, a column of nine indicator LEDs, and two potentiometers. The LEDs provide status and condition information about the connected nutrunner. The indicator LEDs are labeled:

- READY
- GOOD
- BAD
- PEAK TORQUE HI
- PEAK TORQUE LOW
- ANGLE HI
- ANGLE LOW
- SPINDLE FAULT
- SERVO FAULT
- MOTOR ENABLE
- BUS VOLTAGE PRESENT

To understand the meaning of these LEDs and potentiometers when they are lit, refer to *TCM Related Faults* in the *Visual Supervisor User's Guide* (part number 39-30-34823).

Servo Amplifier

The servo amplifier is a three-phase, brushless DC motor controller that provides electrical power to the nutrunner motor. It receives control signals from the DCM. Based on the state of these inputs, the servo amplifier energizes the motor windings to rotate the motor.

The servo amplifier serves as a closed-loop speed controller. It modulates the motor winding currents in order to maintain a constant motor speed despite changes in load. Additionally, the servo amplifier can stop the motor quickly by way of dynamic and/or 4-quadrant braking. The servo amplifier boards are paired with the DCM board and are housed inside the TCM.

Gen2 Device Control Module (DCM)

A 3V lithium battery is located on the DCM board. You must remove the DCM board from the TCM in order to replace this battery. A generic 3V lithium battery (Duracell DL 2430 or equivalent) can be used. A jumper JP1 located near the back of the TCM can be removed to disconnect the battery from the circuitry.

Communications Control Module (CCM) “Optional”

The CCM module provides Ethernet (10Base-T) connectivity from the CS7000 Controller. This interface may be to Visual Supervisor systems on the LAN or possibly custom interfaces to customer networks. In addition the CCM (in the future) be capable of various communications functions such as Fieldbus connections. The CCM module will also be capable of handling a keypad/display function.

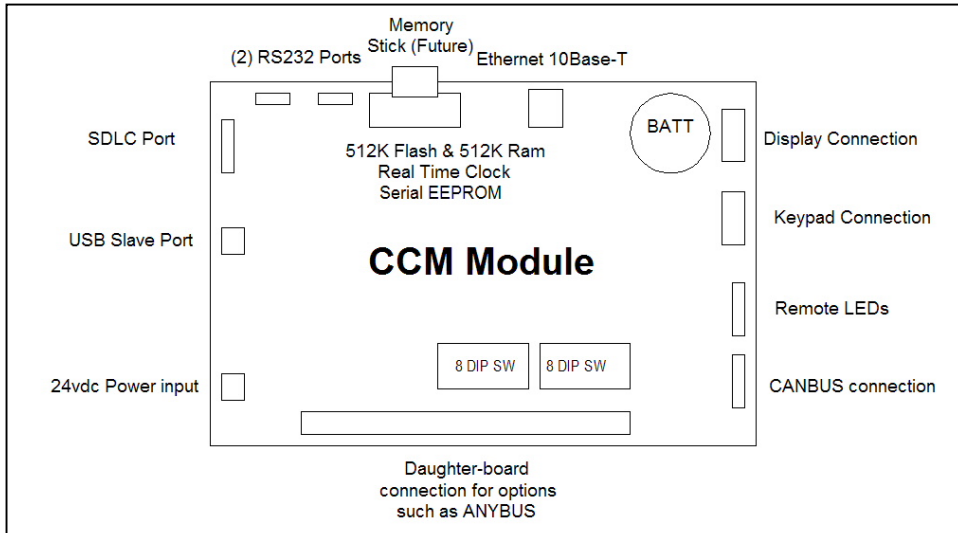

Figure 2-7. Communications Control Module (CCM)



Backplane

The backplane is a printed circuit board into which many of the internal component cables plug.

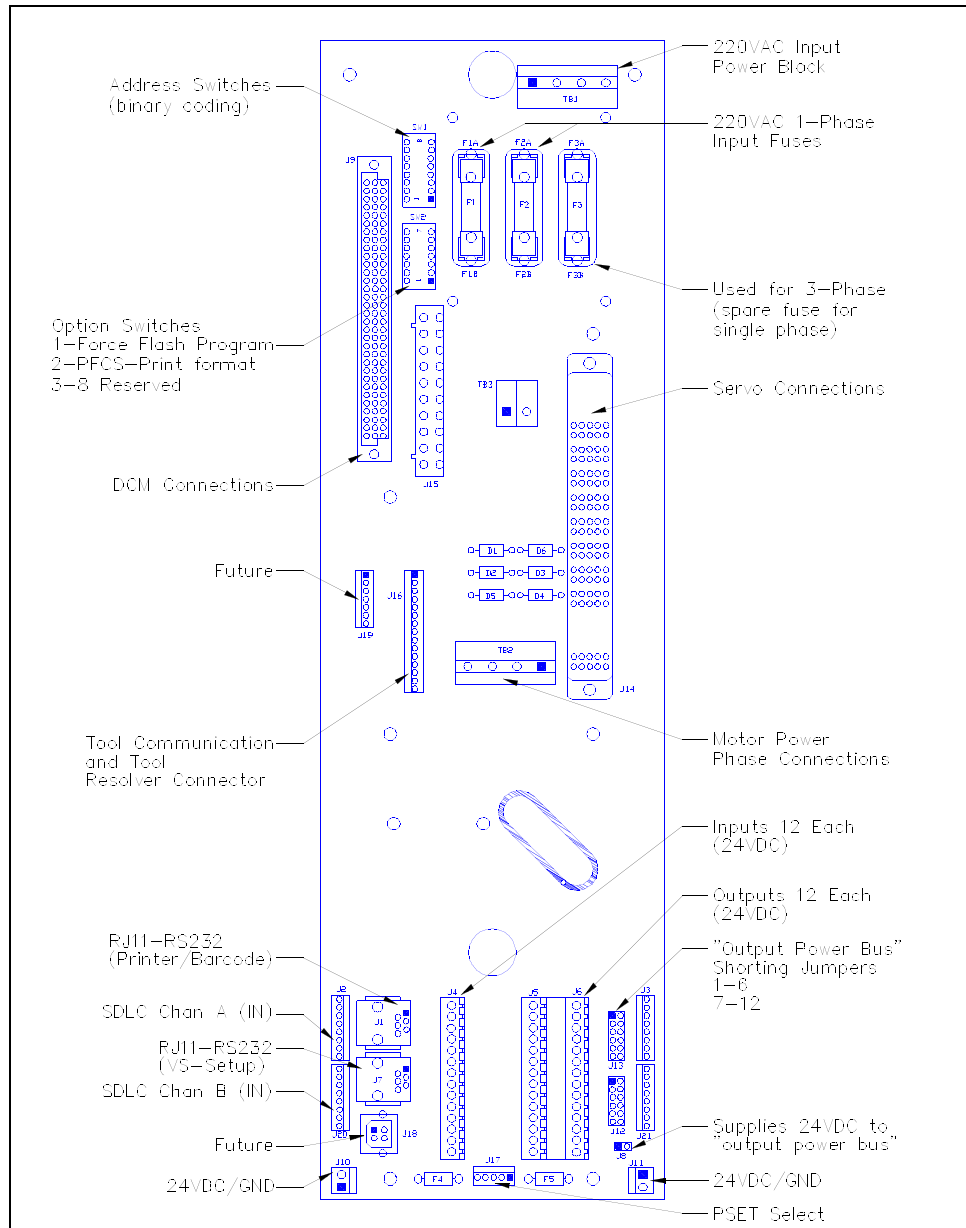

Figure 2-8. CS7000 Controller Backplane

Backplane Fuses

F1 and F2 are the main 220V line fuses (MDA-20).

F4 is a 1A Pico fuse used to protect the external 24 VDC. F5 is a spare fuse.

DIP Switch Settings

DIP switch block SW1 is used to configure the SDLC address. These are binary encoded to provide addresses 1 through 32 (zero is not a valid address). For Ethernet this address should be set to 1.

DIP switch block SW2 is for special options. Position #1 can force the unit into the FLASH program mode. Position #2 configures the printer port for DaimlerChrysler Plant Floor Communication System (PFCS) formatting.

Power Supply

A 1.3A, 24V power supply provides power for external I/O use.

Ground Fault Circuit Interrupter (GFCI)

The GFCI is wired in series from the AC power input to the servo amplifier. It monitors both AC power leads to the servo amplifier, ensuring that current flowing in one lead is the same as the current flowing out the other lead. If, due to a ground fault, the GFCI detects a net difference in the AC power exceeding 30 milliamps (30mA or .030 Amps), it shuts off the AC power to the servo amplifier automatically.

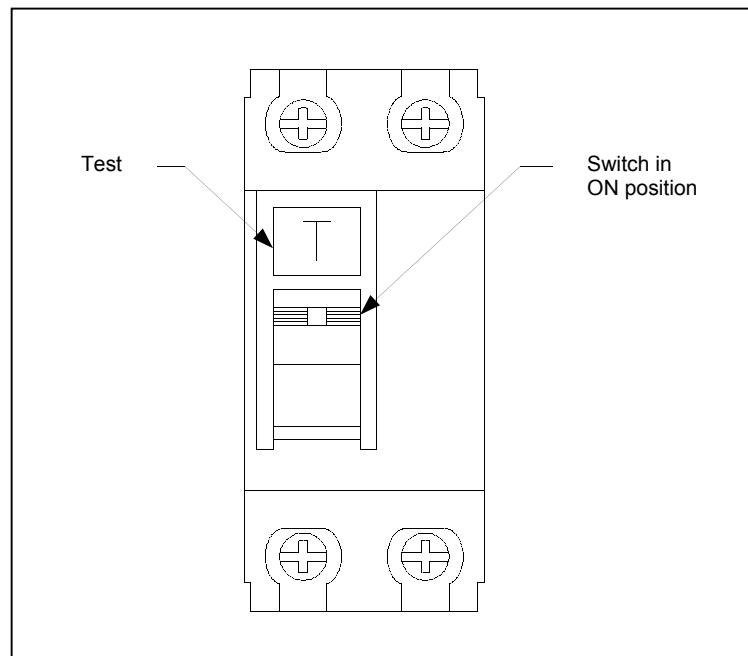

Figure 2-9. Ground Fault Circuit Interrupter

Disconnect Switch

The disconnect switch is mechanically interlocked with the rotary actuator to prevent the enclosure door from opening if the disconnect switch is in the ON position. Refer to *Front Panel* earlier in this chapter for details about the rotary actuator.

Circuit Breaker/Fuses

The circuit breaker/Fuses protects the controller circuitry during an overload condition.

(This page is left blank intentionally.)



3. Installing the CS7000 Controller

This chapter shows you how to mount the CS7000 Controller, discusses the basic issues involved in placing the CS7000 Controller in your facility and shows you how to wire it.

Mounting the CS7000 Controller

The CS7000 Controller is installed vertically with the back flat against the mounting surface. Allow sufficient space around the controller to attach the power cord, tool cable, I/O cable and printer cable. Also be sure to allow space to open the door on the enclosure.

CAUTION! *Mount the CS7000 Controller away from moving machinery and lift trucks on a structure that does not vibrate. Do not mount the CS7000 Controller near large electrical systems, motors, welding equipment, or in an area of temperature or moisture extremes.*



Figure 3-1 shows the dimensions of the CS7000 Controller (in inches).

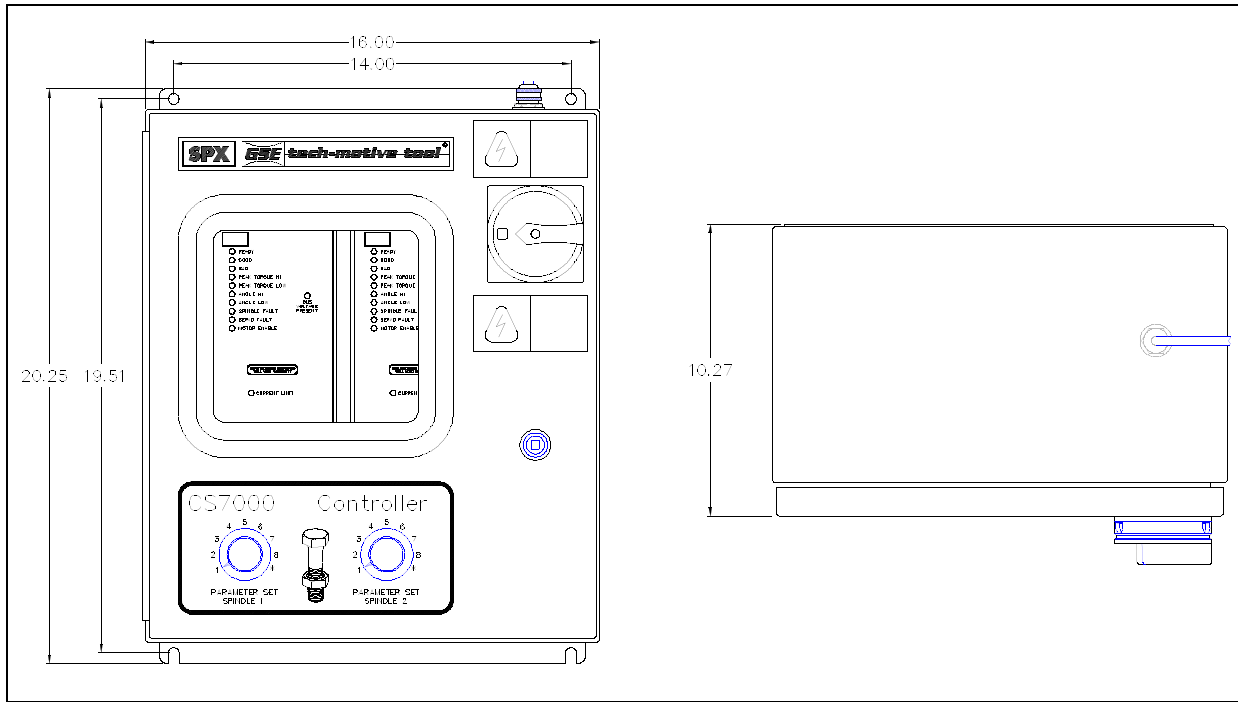

Figure 3-1. CS7000 Controller Dimensions of the Front and Bottom Panel

To mount the controller use four 1/4-20-in bolts or screws.

Emissions and Susceptibility

The CS7000 Controller meets the EC directives IEC 61000-6-2 (1999) and IEC 61000-6-4 (1997). It does not radiate excessive electromagnetic or noise radiation, or interfere with other controllers and/or electronic devices in its vicinity.

Meeting the AC Input Power Requirements

For proper operation, the controller must be connected to a stable power source. The supply source should be capable of delivering at least 1.5 kVA per channel at 220V for 177 Series tools. For the 277 Series tools, at least 2KVA per channel is recommended.

The voltage tolerance for 220V controllers is 208 to 250 VAC.

NOTE:



The maximum no-load speed of a nutrunner is based on a nominal AC input voltage of 220V depending on the type of controller; if the actual input voltage is lower, the maximum no load speed of the nutrunner will be lower than specified.

CAUTION!



Failure to provide the proper power source can cause the following problems in your CS7000 Fastening System:

- ***The nutrunner might shut down before it reaches the target torque during a rundown cycle.***
- ***The nutrunner might not operate when a cycle-on signal is applied to the system.***
- ***The maximum free speed of the nutrunner might be lower than specified.***

Input Power Protection

A circuit breaker or fuses positioned between the AC input and the servo amplifier provides the controller with short circuit protection.

Grounding

WARNING!  **The GFCI cannot protect you against any potential difference that exists between the nutrunner body and any other metal fixturing or machinery. You must observe the grounding requirements below as a safety protection. Failure to follow this safety guideline can result in serious personal injury.**

It is *extremely* important that you connect the CS7000 Controller enclosure properly to an earth ground. The CS7000 Controller has a ground prong on the power cord, (if supplied) but the AC outlet that will be used must be grounded properly, as well.

Also make sure that all other machinery, such as conveyors, which will transport or hold parts that will come in physical contact with the nutrunner, are properly grounded.

I/O Wiring

The CS7000 Controller is equipped with a 19-pin I/O connector for field I/O. The settings described in Table 3-1 are VS default settings. The CS7000 Controller is capable of 12 discrete inputs and 12 discrete outputs, however, the standard 19-pin I/O connector does not accommodate I/O 9 through 12. These extended I/O must be wired to the backplane directly if they are required. DCMII revision 3.00 or higher also supports 128 parameter sets and 16 sequences.

NOTE:  *The 14-shell, 19-pin strain relief mating connector for the I/O connector is part number 23-10-5200 [PT06A-14-19P (SR)].*

Table 3-1. 19-Position Remote I/O Connector Pinout Signal Names and Descriptions

Pin	Signal	Description
A	Cycle On/Cycle On Enable Clear Outputs (Black wire - internal) (Black wire - external)	<p>This is a dual-purpose input.</p> <p>When Set Defaults is clicked, VS sets this input to <i>Start</i>, this input functions as a <i>cycle on</i> input. This means a fastening cycle can be started by either pressing the throttle/trigger switch on the nutrunner OR by activating this input.</p> <p>When remote mode for the spindle is set to <i>enable</i>, this input functions as a <i>cycle on enable</i> input. This means a fastening cycle can be started only by pressing both the throttle/trigger switch on the nutrunner and activating this input.</p> <p>In addition, it is also set to Clear Outputs.</p> <p>This is a level-sensitive input. For the fastening cycle to proceed, this input must remain active. If this input becomes inactive at any time during the fastening cycle, the cycle will be aborted and the nutrunner will stop running.</p>

Table 3-1. 19-Position Remote I/O Connector Pinout Signal Names and Descriptions (Continued)

Pin	Signal	Description																																				
B	Forward/Reverse input (White wire - internal) (White wire - external)	When Set Defaults is clicked, VS sets this input to the direction the nutrunner turns in a fastening cycle: If this input is active when a fastening cycle is started, the nutrunner will run in the forward (fastening or tightening) direction. If this input is inactive when a fastening cycle is started, the nutrunner will run in the reverse (un-fastening or loosening) direction. After a fastening cycle has started, changing the state of this input has no effect on the fastening direction until the cycle on command (from either the nutrunner or the cycle on input or both) is de-activated. This means the input must be in the desired state BEFORE activation of the cycle start input.																																				
C	Discrete Input #7 (Gray wire - internal) (Red wire - external)	Defaults to "Manual Calibration."																																				
D	Discrete Input #8 (Yellow wire - internal) (Green wire - external)	Multi-purpose switch input "OR" function with switch on tool.																																				
E	Limit Set Select B0 input (Red wire - internal) (Orange wire - external)	When Set Defaults is clicked, VS sets these three inputs to select which of the eight internal limit (or parameter) sets are used for a fastening cycle, as follows:																																				
F	Limit Set Select B1 input (Green wire - internal) (Blue wire - external)	<table border="1"> <thead> <tr> <th>Limit Set</th> <th>B2 Input</th> <th>B1 Input</th> <th>B0 Input</th> </tr> </thead> <tbody> <tr><td>1</td><td>inactive</td><td>inactive</td><td>inactive</td></tr> <tr><td>2</td><td>inactive</td><td>inactive</td><td>active</td></tr> <tr><td>3</td><td>inactive</td><td>active</td><td>inactive</td></tr> <tr><td>4</td><td>inactive</td><td>active</td><td>active</td></tr> <tr><td>5</td><td>active</td><td>inactive</td><td>inactive</td></tr> <tr><td>6</td><td>active</td><td>inactive</td><td>active</td></tr> <tr><td>7</td><td>active</td><td>active</td><td>inactive</td></tr> <tr><td>8</td><td>active</td><td>active</td><td>active</td></tr> </tbody> </table>	Limit Set	B2 Input	B1 Input	B0 Input	1	inactive	inactive	inactive	2	inactive	inactive	active	3	inactive	active	inactive	4	inactive	active	active	5	active	inactive	inactive	6	active	inactive	active	7	active	active	inactive	8	active	active	active
Limit Set	B2 Input	B1 Input	B0 Input																																			
1	inactive	inactive	inactive																																			
2	inactive	inactive	active																																			
3	inactive	active	inactive																																			
4	inactive	active	active																																			
5	active	inactive	inactive																																			
6	active	inactive	active																																			
7	active	active	inactive																																			
8	active	active	active																																			
G	Limit Set Select B2 input (Orange wire - internal) (White/Black wire - external))	After a fastening cycle has started, changing the state of these inputs does not change which limit set the CS7000 Controller uses until the cycle on command (from either the nutrunner or the cycle on input or both) is de-activated. This means these inputs must be in the desired state BEFORE activation of the cycle start input.																																				
H	+24 VDC (Blue wire - internal) (Red/Black wire - external))	This pin (and pin T) is connected to the positive (+) terminal of the internal 24VDC I/O power supply and is normally used as the common connection for the input signals.																																				
J	Discrete output #1* (White/Black wire - internal) (Green/Black wire - external)	Pins J, K, L, M, N, P, and U are the programmable discrete outputs.																																				
K	Discrete output #2* (White/Red wire - internal) (Red/Black wire - external)	Any one of these outputs will become active when its programmed																																				
L	Discrete output #3* (White/Green wire - internal) (Blue/Black wire -external)	Output function becomes true. When Set Defaults is clicked, VS sets these outputs to:																																				



Table 3-1. 19-Position Remote I/O Connector Pinout Signal Names and Descriptions (Continued)

Pin	Signal	Description
M	Discrete output #4* (White/Violet wire - internal) (Black/White wire - external)	J = Cycle Finish, K = Cycle Good, L = Cycle Bad, N = In Cycle.
N	Discrete output #5* (White/Blue wire - internal) (Red/White wire - external)	
P	Discrete output #6 (White/Gray wire - internal) (Green/White wire - external)	
R	Synchronization in/out (White/Orange wire - internal) (Orange/Red wire - external)	<p>This bi-directional signal is used for synchronizing two or more spindles in a multi-spindle fastening application. It is connected to both the synchronization output (Discrete output #8) and the synchronization input (Discrete input #6).</p> <p>If Sync is set to <i>On</i>, the synchronization output becomes active when a fastening cycle is started. When the nutrunner output torque reaches the Control Reference level, the synchronization output is de-activated. At the same time, the state of the synchronization input is sampled. If it is still active because some other spindle has not reached the synchronization level yet, it stops the nutrunner and waits for the synchronization input to become inactive. Afterwards, it re-starts the nutrunner and finishes the fastening cycle.</p> <p>This pin should be connected to the synchronization in/out pin of all other spindles for which synchronization is desired.</p> <p>NOTE: <i>This feature only functions when JP8 and JP9 are set to defaults.</i></p> <p>?</p>
S	Output common (White/Brown wire - internal) (Blue/white wire - external)	<i>This feature only functions when JP8 and JP9 are set to defaults.</i>
T	+24 VDC (Blue wire - internal) (Black/Red wire - external)	This pin (and pin H) is connected to the positive (+) terminal of the internal 24VDC I/O power supply and is normally used as the common connection for the input signals.
U	Discrete output #7* (Brown wire - internal) (White/Red wire - external)	Pins U and J, K, L, M, N, and P are the programmable discrete outputs. Any one of these outputs will become active when its programmed output function becomes true. The functions of these outputs are set with VS set output.
V	Synchronization common (Violet wire - internal) (Blue/Red wire - external)	This is the common connection for the synchronization input/output. It should be connected to the synchronization common pin of all other spindles for which synchronization is desired.

NOTE: *Active means an input is connected to +24VDC. Inactive means an input is either not wired or is wired to common.*

?

A remote input circuit schematic is shown in Figure 3-2.

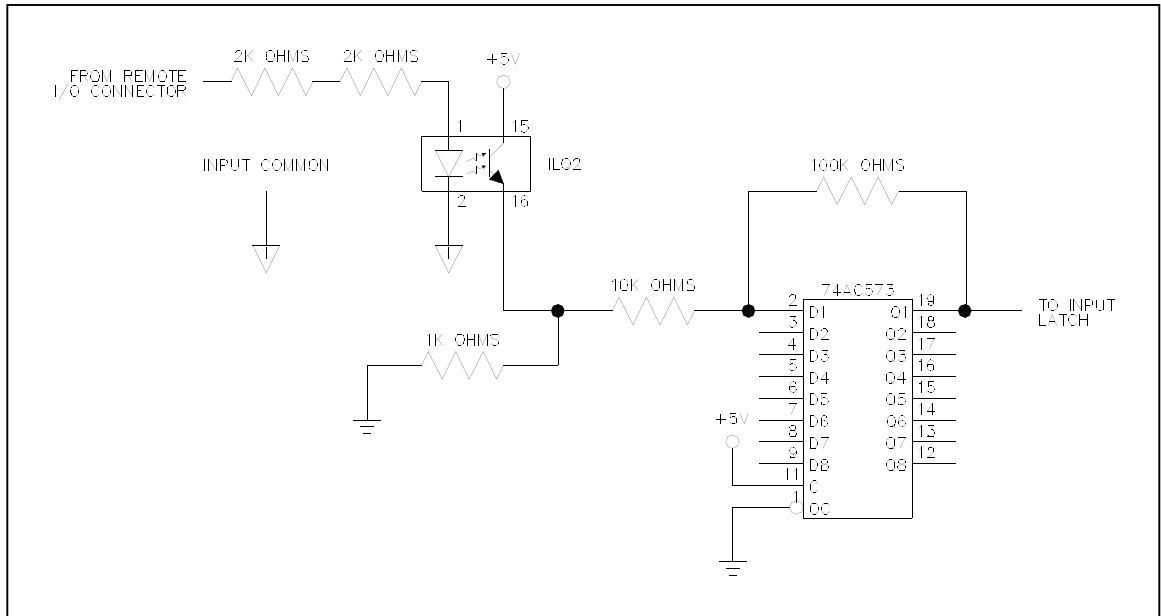

Figure 3-2. Remote Input Circuit Schematics

To ensure that you operate the fastening system properly, refer to Table 3-2 for input requirements.

Table 3-2. Guidelines for Proper Operation of the Controller I/O Signals

Discrete Inputs		Unit
	Highest permissible input voltage	30 V
	Lowest permissible input voltage	-5 V
	Minimum guaranteed input activation	10 V
	Maximum guaranteed input deactivation	1.5 V
Discrete outputs		Unit
	Maximum output current	360 mA
	Maximum voltage	28 Volts DC

NOTE: **?** Installing J8 (supplied 24 VDC to “output-common-bus” and each of the individual output (J12 and J13 jumpers) eliminates the need to wire 24VDC to the output terminals for sourcing.

Connector Pinout Definitions

Pinout definitions are provided for the tool, I/O, TCM network, RS-232 and printer connectors.

Tool Connector “26 pin” (Metal SMC) – Front View

Pin Designation	Wire Color (Ref)	Function
1	RED	POWER PHASE 2
5	ORN/WHT	+ 24 VOLTS
6	WHT/ORN	COMMON
12	WHT/BR	CLK -
13	BR/WHT	CLK +
14	BLU/WHT	TXD +
15	WHT/GRN	RXD -
16	GRN/WHT	RXD +
19	GRN	POWER SHIELD
20	WHT	POWER PHASE 1
21	BLK	POWER PHASE 3
22	GRN	RESOLVER SHIELD
23	GRN	SIG SHIELD
25	GRN-YEL	TOOL FRAME GRD
26	WHT/BLU	TXD -
Nos. not listed	--	No connection
10	WHT/RED	RESOLVER R1
11	WHT/BLK	R2
8	WHT	S1
24	WHT/GRN	S2
9	GRN	S3
7	WHT/YEL	S4

I/O Connector – Front View

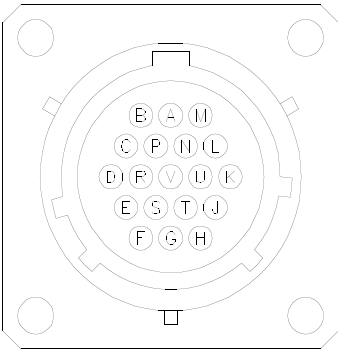
	Pin Designation	Wire Color (Ref)	Function
	A	BLK	CYCLE ON INPUT
B	WHT	FORWARD/REVERSE INPUT	
C	GRY	DISCRETE INPUT #7	
D	YEL	DISCRETE INPUT #8	
E	RED	LIMIT SET SELECT B0 INPUT	
F	GRN	LIMIT SET SELECT B1 INPUT	
G	ORN	LIMIT SET SELECT B2 INPUT	
H	BLU	+24V INPUT	
J	WHT/BLK	DISCRETE OUTPUT #1 (FINISHED)	
K	WHT/RED	DISCRETE OUTPUT #2 (ACCEPT)	
L	WHT/GRN	DISCRETE OUTPUT #3 (REJECT)	
M	WHT/YEL	DISCRETE OUTPUT #4	
N	WHT/BLU	DISCRETE OUTPUT #5	
P	WHT/GRY	DISCRETE OUTPUT #6	
R	WHT/GRN	SYNC IN/OUT	
S	WHT/BRN	OUTPUT COMMON	
T	BU	+24V	
U	BRN	DISCRETE OUTPUT #7	
V	VIO	SYNC COMMON	

TCM (IN and OUT) Network Connectors – Front View

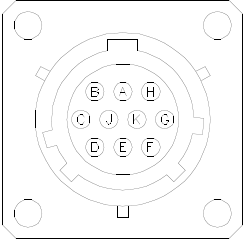
	Pin Designation	Wire Color (Ref)	Function
	A	BRN/WHT	TXD+ OUT
B	WHT/BRN	TXD- OUT	
C	ORN/WHT	RXD+ IN	
D	WHT/ORN	RXD- OUT	
E	GRN/WHT	CLK+ OUT	
F	WHT/GRN	CLK- OUT	
G	BLU/WHT	SHIELD COMMON	
H	GRN	SHIELD	

RS-232 Connector – Front View

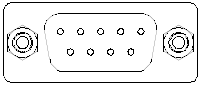
	Pin Designation	Wire Color (Ref)	Function
	2	BLU	RXD
3	GRN	TXD	
5	BLK	GND	
7	RED	RTS	
8	YEL	CTS	

Printer/Computer/Diagnostics (RS-232) Connector – Front View

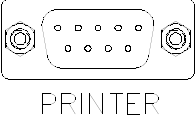
	Pin Designation	Wire Color (Ref)	Function
	2	BLU	RXD
	3	GRN	TXD
	5	BLK	GND
	7	RED	RTS
	8	YEL	CTS

Programming the CS7000 Controller (In General)

After you have mounted the controller and become familiar with its basic components, you must program it with the required fastening strategy and parameter set limits before you can begin fastening operations. Refer to the *Visual Supervisor User's Guide* (part number 39-30-34823) for connection and setup information.

Programming the CS7000 with Ethernet (CCM)

Adding a CCM board to the CS7000 provides ethernet capability and other future functions. The Initial release supports Visual Supervisor, and subsequent releases will provide interfaces to many Customer specific networks. Also future capabilities will include Fieldbus and Keypad/displays. A Null-modem cable that provides an RS-232 connection (Typically 9 pin-d female on both ends) will be required for setup of the CCM module. This cable will plug into the CS7000 communications/diagnostics port. If using Hyper-terminal, use 9600 baud, 8 data, no parity and one stop bit. Hit the <Enter key> and a > should appear. Hitting ? will show a list of available commands.

To configure the CS7000 Controller to link to Visual Supervisor, you must use the ipconfig command to establish the TCP/IP parameters (IP address etc.). At the Visual-Supervisor-Host, you must set up VsSystemSettings to use Ethernet and enter the IP address of this controller. Once that is saved, VS should start up and communicate normally with the controller. If problems occur, PING ommands and LED s on the CCM that should help guide the user to the problem. It is necessary to issue a commit command to permanently save settings.

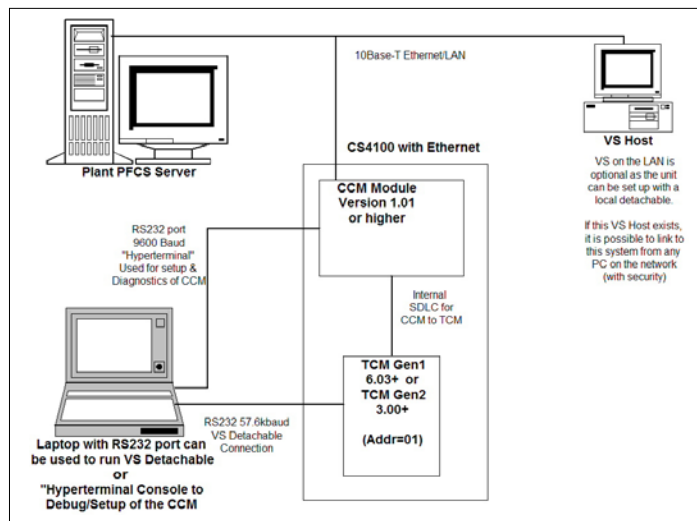

4. Technical Information

Maintenance of the CS7000 Controller consists of replacing fuses and cleaning the enclosure window.

Replacement Parts

If, at any time, you need to replace or order new parts for your CS7000 Controller.

Table 4-1. Replacement Parts

Qty.	Description	Part Number
1	50A TCM GEN2	49-4102-015000
1	+24V DC Power Supply	12-20-5007
1	Fuse 1A SB, Littelfuse 39001 5x20 mm	13-10-61001
2	Fuse 20A, MDA-20	13-10-0555

NOTE: *All part numbers used in Table 4-1 are CP techmotive part numbers unless otherwise specified.*

?

Cleaning the Enclosure Window

Use only water-based cleaners to clean the plastic window. Other solvents may damage the window.

Assembly Drawings

Assembly and wiring diagrams are available for the CS7000 Controller. To request an assembly or wiring diagram, contact the CP techmotive Technical Service Department. To contact CP techmotive, refer to *Contact Information* next.

Contact Information

NOTE:  *You will need to prefix American telephone numbers with the International Access Code for the U.S. when calling from another country.*

If you require additional technical information about the CS7000 Controller, call 1-877-224-7377 from inside the U.S. or Canada, or (001) 248-596-0600 from outside the U.S. or Canada, or visit our website at <http://www.gsetechmotive.com>.

Alternatively, you can also contact CP techmotive at:

42860, Nine Mile Road,
Novi, MI 48375-4122

5. Index

A

AC
 input, 3-3
 Input Receptacle, 2-5
 address switches, 2-6

B

backplane, 2-11
 battery, 2-9
 bottom panel, 2-1

C

circuit breaker, 2-6, 2-13
 Clear Outputs, 3-4
 connector
 I/O, 2-6, 3-9
 printer, 2-5, 3-10
 RS-232, 2-5, 3-9
 SDLC/485, 2-5, 3-9
 tool, 2-5, 3-8
 Cycle
 Bad, 3-6
 Finish, 3-6
 Good, 3-6

D

Device Control Module
 battery, 2-9
 disconnect switch, 1-3, 2-3, 2-6, 2-13
 dual-purpose input, 3-4

E

electrical
 drawings, 1-3
 fires, 1-3
 hazards, 1-3
 wiring, 1-3
 enclosure
 components, 2-7
 interior, 2-1
 window, 4-1
 extinguishers, 1-3

F

front panel, 2-1
 fuse, 1-3, 4-1
 pullers, 1-3
 substitutes, 1-3

G

ground fault circuit interrupter, 2-6, 2-12

I

I/O
 cable, 3-1
 connector, 2-6, 3-9
 Port, 2-6
 power, 2-6
 input
 active, 3-6
 inactive, 3-6
 Input AC Receptacle, 2-5

L

latch, 2-3
 LED, 2-9
 LED display, 2-3

M

Manual Calibration, 3-5
 multi purpose switch, 3-5

N

nutrunner, 3-4, 3-5

O

output current, 3-7

P

Panels
 Bottom, 2-4
 Top, 2-4
 Panels
 Front, 2-2
 Parameter Set Switch, 2-3
 parameter sets, 3-5
 PFCS, 2-12

pinout, 3-8
Plant Floor Communication System, 2-12
potentiometer, 2-9
power supply, 2-6, 2-12, 3-5, 4-1
printer cable, 3-1
printer connector, 2-5, 3-10
programmable discrete output, 3-6

R

remote input circuit schematic, 3-7
repairs, 1-3
rotary actuator, 2-3
RS-232
 connector, 2-5, 3-9
 port, 2-5

S

safety glasses, 1-3

safety,
 electrical, 1-1, 1-3
SDLC/485 I/O network connector, 2-5, 3-9
servo amplifier, 2-6, 2-9, 2-12
spindle, 2-8
synchronization input/output, 3-6
synchronization output, 3-6

T

tool cable, 3-1
Tool Connector, 2-5, 3-8
Tool Control Module, 2-8
top panel, 2-1

V

voltage, 1-3, 3-7

(This page left blank intentionally)



www.cp.com



Please find your local contact at: www.cp.com

 **Chicago
Pneumatic**

 **Desoutter**

 **GEORGES
RENAULT**

 **前哨
QIANSHAO**

 **SCANROTOR**

 **techmotive**

U.S. English
Printed in USA
Copyright 2005
CP techmotive, Novi, MI, USA