

V.92 56K Internal Modem User's Guide

FCC Notice “Declaration of Conformity Information”

This equipment has been tested and found to comply with the limits for a Class B digital device, pursuant to Part 15 of the FCC rules. These limits are designed to provide reasonable protection against harmful interference in a residential installation.

This equipment generates, uses and can radiate radio frequency energy and, if not installed and used in accordance with the instructions, it may cause harmful interference to radio communications. However, there is no guarantee that interference will not occur in a particular installation. If this equipment does cause harmful interference to radio or television reception, which can be determined by turning the equipment off and on, the user is encouraged to try to correct the interference by one or more of the following measures:

- ❖ Reorient or relocate the receiving antenna.
- ❖ Increase the separation between the equipment and receiver.
- ❖ Connect the equipment to an outlet on a circuit different from that to which the receiver is connected.
- ❖ Consult the dealer or an experienced radio/TV technician for help.



NOTE: Only peripherals complying with the FCC Class B limits may be attached to this modem. Operation with non-compliant peripherals or peripherals not recommended by Toshiba is likely to result in interference to radio and TV reception. Changes or modifications made to this equipment not expressly approved by Toshiba or parties authorized by Toshiba could void the user's authority to operate the equipment.

This device complies with Part 15 of the FCC Rules. Operation is subject to the following two conditions:

- ❖ This device may not cause harmful interference.
- ❖ This device must accept any interference received, including interference that may cause undesired operation.

Contact:

Toshiba America Information Systems, Inc.
9740 Irvine Blvd.
Irvine, CA 92618-1697
(949) 583-3000

Industry Canada Requirement

This Class B digital apparatus complies with Canadian ICES-003.

Cet appareil numérique de la classe B est conforme à la norme NMB-003 du Canada.

Pursuant to FCC CFR 47, Part 68:

When you are ready to install or use the modem, call your local telephone company and give them the following information:

- ❖ The telephone number of the line to which you will connect the modem
- ❖ The registration number that is located on the device

The FCC registration number of the modem will be found on either the device which is to be installed, or, if already installed, on the bottom of the computer outside of the main system label.

- ❖ The Ringer Equivalence Number (REN) of the modem can vary. For the REN of your modem, refer to your computer's user's guide.

The modem connects to the telephone line by means of a standard jack called the USOC RJ11C.

Type of service

Your modem is designed to be used on standard-device telephone lines. Connection to telephone company-provided coin service (central office implemented systems) is prohibited. Connection to party lines service is subject to state tariffs. If you have any questions about your telephone line, such as how many pieces of equipment you can connect to it, the telephone company will provide this information upon request.

Telephone company procedures

The goal of the telephone company is to provide you with the best service it can. In order to do this, it may occasionally be necessary for them to make changes in their equipment, operations, or procedures. If these changes might affect your service or the operation of your equipment, the telephone company will give you notice in writing to allow you to make any changes necessary to maintain uninterrupted service.

If problems arise

If any of your telephone equipment is not operating properly, you should immediately remove it from your telephone line, as it may cause harm to the telephone network. If the telephone company notes a problem, they may temporarily discontinue service. When practical, they will notify you

in advance of this disconnection. If advance notice is not feasible, you will be notified as soon as possible. When you are notified, you will be given the opportunity to correct the problem and informed of your right to file a complaint with the FCC. In the event repairs are ever needed on your modem, they should be performed by Toshiba Corporation or an authorized representative of Toshiba Corporation.

Disconnection

If you should ever decide to permanently disconnect your modem from its present line, please call the telephone company and let them know of this change.

Fax branding

The Telephone Consumer Protection Act of 1991 makes it unlawful for any person to use a computer or other electronic device to send any message via a telephone fax machine unless such message clearly contains in a margin at the top or bottom of each transmitted page or on the first page of the transmission, the date and time it is sent and an identification of the business, other entity or individual sending the message and the telephone number of the sending machine or such business, other entity or individual.

In order to program this information into your fax modem, you should complete the setup of your fax software before sending messages.

Instructions for IC CS-03 certified equipment

- 1 **NOTICE:** The Industry Canada label identifies certified equipment. This certification means that the equipment meets certain telecommunications network protective, operational and safety requirements as prescribed in the appropriate Terminal Equipment Technical Requirements document(s). The Department does not guarantee the equipment will operate to the user's satisfaction.

Before installing this equipment, users should ensure that it is permissible to be connected to the facilities of the local telecommunications company. The equipment must also be installed using an acceptable method of connection. The customer should be aware that compliance with the above conditions may not prevent degradation of service in some situations.

Repairs to certified equipment should be coordinated by a representative designated by the supplier. Any repairs or alterations made by the user to this equipment, or equipment malfunctions, may give the telecommunications company cause to request the user to disconnect the equipment.

Users should ensure for their own protection that the electrical ground connections of the power utility, telephone lines and internal metallic

water pipe system, if present, are connected together. This precaution may be particularly important in rural areas.

Caution: Users should not attempt to make such connections themselves, but should contact the appropriate electric inspection authority, or electrician, as appropriate.

- 2 The user's guide of analog equipment must contain the equipment's Ringer Equivalence Number (REN) and an explanation notice similar to the following:

The Ringer Equivalence Number (REN) of this device can vary. For the REN number of your modem, refer to your computer's user's guide.

NOTICE: The Ringer Equivalence Number (REN) assigned to each terminal device provides an indication of the maximum number of terminals allowed to be connected to a telephone interface. The termination on an interface may consist of any combination of devices subject only to the requirement that the sum of the Ringer Equivalence Numbers of all the devices does not exceed 5.

- 3 The standard connecting arrangement (telephone jack type) for this equipment is jack type(s): USOC RJ11C.

Copyright

This user's guide is copyrighted by Toshiba Corporation with all rights reserved. Under the copyright laws, this user's guide cannot be reproduced in any form without the prior written permission of Toshiba. No patent liability is assumed, however, with respect to the use of the information contained herein.

© 2002 by Toshiba Corporation. All rights reserved.

Export Administration Regulation

This document contains technical data that may be controlled under the U.S. Export Administration Regulations, and may be subject to the approval of the U.S. Department of Commerce prior to export. Any export, directly or indirectly, in contravention of the U.S. Export Administration Regulations is prohibited.

Disclaimer

This user's guide has been validated and reviewed for accuracy. The instructions and descriptions it contains are accurate for the Toshiba internal modem at the time of this user's guide's production. However, succeeding products and user's guides are subject to change without notice.

6

Toshiba assumes no liability for damages incurred directly or indirectly from errors, omissions or discrepancies between the modem and the user's guide.

Trademarks

Microsoft and Windows are registered trademarks of Microsoft Corporation.

Microcom and Microcom Networking Protocol are registered trademarks of Microcom, Inc.

Hayes is a registered trademark of Hayes Microcomputer Products Inc.

MNP is a trademark of Microcom Systems, Inc.

Contents

Introduction	12
Conventions	12
Features	14
Function charts	17
Chapter 1: Modem On Hold.....	19
Using Modem On Hold.....	20
Answering an incoming voice call.....	20
Placing an outgoing voice call.....	22
Viewing Call History	25
Configuring Modem On Hold	25
Configuring Modem On Hold settings.....	26
Enabling/Disabling the Modem On Hold autorun status.....	28
Adding and removing the Modem On Hold icon from the system tray	28
Locating the Modem On Hold application version..	29
Chapter 2: Function Check	31
Running diagnostics	31
Determining current connection protocol	38

Chapter 3: Using the Internal Modem	44
Connection procedures	44
Analog or digital?	45
Connecting the internal modem	45
Disconnecting the internal modem	46
Basic operation	47
Connecting to a telephone line	47
Direct access line	47
Extension line	48
Receiving a call	49
Terminating a call	49
Setting the data flow control	49
Facsimiles	50
Chapter 4: AT Commands	51
AT command formats	51
+++ Escape sequence	52
A/ Repeat last command	52
A Answer command	52
Bn Communication standard setting	52
Dn Dial	53
En Echo command	54
Hn Hook control	55
In Request ID information	55
Ln Monitor speaker volume	60
Mn Monitor speaker mode	60
Nn Modulation handshake	61
On Return online to data mode	61
P Select pulse dialing	62
Qn Result code control	62
T Select tone dialing	62
Vn DCE response format	62
Wn Result Code Option	63

Xn Result code selection, call progress monitoring	63
Extended result codes	64
Dial tone detect	64
Busy tone detect	64
Zn Recall stored profile	65
&Cn Data Carrier Detect (DCD) control	65
&Dn Data Terminal Ready (DTR) control	66
&F Load factory settings	66
&Gn V.22bis guard tone control	67
&Kn Local flow control selection	67
&Pn Select Pulse Dial Make/Break Ratio	68
&Tn Self-test commands	68
&V View active configuration and stored profile	69
&W Store current configuration	69
&Y Select stored profile for hardware reset	69
&Zn=x Store telephone number	70
\Nn Error control mode selection	70
Qn Local flow control selection	71
\Vn Protocol result code	71
%Cn Data compression control	72
-V.90=<n>	72
+DS44 V.44 Data Compression Command	73
+MS Command	74
+PCW Command	77
+PIG Command	78
+PMH Command	79
+VCID Command	79
Chapter 5: S-Registers	81
S-Register values	82
S0 Auto answer ring number	82
S1 Ring counter	82

S2 AT escape character (user-defined)	83
S3 Command line termination character (user-defined)	83
S4 Response formatting character (user-defined)	83
S5 Command line editing character (user defined)	84
S6 Wait before dialing	84
S7 Connection completion time-out.....	85
S8 Comma pause time	85
S11 DTMF dialing speed	85
S12 Escape guard time	86
S37 Dial line rate.....	86
AT command set result codes	87
Chapter 6: Test Function	92
Test description.....	92
Testing procedure	93
Chapter 7: MNP and V.42.....	95
Error-correction overview	95
MNP error correction	95
V.42 error correction	96
Operation modes	96
Normal mode	96
Reliable mode	96
Commands (\Nn)	97
Flow control	97
Serial port flow control	98
XON/XOFF flow control (software)	98
CTS/RTS two-way flow control (hardware)	99
Commands (\Qn, &Kn)	99
Modem port flow control	100
Data compression	100

Commands (%Cn)	100
Appendix A: Specifications	101
Network control unit (NCU)	101
Communication specifications	102
Appendix B: Communication Conditions	103
Communication parameters	103
Telephone line types	103
Connectable lines (2-wire)	104
Unconnectable lines (4-wire)	104
Dial modes	104
Glossary	105
Index	117

Introduction

Congratulations on becoming the owner of a V.92 56K-compliant internal modem offering advanced functions for fax and data communication. This user's guide provides detailed information on features, operation and technical specifications of your internal modem.

Conventions

This user's guide uses the following formats to describe, identify, and highlight terms and operating procedures.

Abbreviations

On first appearance, and whenever necessary for clarity, abbreviations are enclosed in parentheses following their definition; for example: Read Only Memory (ROM). Acronyms are also defined in the Glossary.

Keys

The keyboard keys are used in the text to describe many computer operations. A distinctive typeface identifies the key top symbols as they appear on the keyboard. For example, Enter identifies the Enter key.

Key operation

Some operations require you to simultaneously use two or more keys. We identify such operations by the key top symbols separated by a plus sign (+). For example, Ctrl + C means you must hold down Ctrl and at the same time press C. If three keys are used, hold down the first two and at the same time press the third.

ATDT Text you are to type in is represented in the type face you see to the left.

Display

ABC Text generated by the computer that appears on its display screen is presented in the type face you see to the left (bold).

Messages

Messages are used in this user's guide to bring important information to your attention. Each type of message is identified as shown below.



CAUTION: This icon indicates the existence of a hazard that could result in damage to equipment or property if the safety instruction is not observed.



NOTE: This icon indicates information that relates to the safe operation of the equipment or related items.

Features

The V.92 56K internal modem provides capability for facsimile transmissions and standard computer-to-computer data communications, at a rate of up to 53,000 bits per second (downstream). It supports the following V.92 features:

- ❖ **Fast Connect**—shortens connection times up to 25 percent, by storing phone line characteristics.
- ❖ **Modem On Hold (MOH)**—enables you to talk on the telephone while connected to the Internet, using the same telephone line. This feature requires ISP support and Call Waiting/Caller ID Service. It also requires the Modem On Hold application, which comes preinstalled on your computer.
- ❖ **PCM Upstream**—transmits up to 48,000 bits per second upstream to host modems that support the V.92 protocol.

-
- ❖ Data Compression—increases transmission speeds using the new V.44 compression algorithm, which is optimized for World Wide Web browsing. The modem also supports MNP5 and V.42bis data compression protocols.

The internal modem has a modem port (RJ11) for connecting to an analog telephone line.



CAUTION: Connect the internal modem ONLY to an analog line, not to a digital line. For more information, see “[Connection procedures](#)” on page 44.

Due to FCC limitations, speeds of 53 kbps are the maximum permissible transmission rates during downloads. Actual data transmission speeds will vary depending on line conditions. Many users will experience throughput in the range of 32 to 44 kbps under normal conditions, depending on telephone line quality.

To achieve a V.92 56K connection, both your modem and the host modem (typically at an ISP) must be V.92 56K modems. As many ISPs do not yet support the V.92 protocol, most connections will be V.90 56K connections.

V.92 connections also require a phone line that supports the V.92 protocol. Some phone lines will not support V.92 or V.90 56K connections at all, either because of quality impairments or additional analog-to-digital conversions (for example, PBX systems).

When a PCM upstream connection is not possible, the modem automatically uses the default V.34 protocol for “upstream” data transmission, which supports connection rates of up to 33,600 bits/second.

56K data communication	The internal modem uses the V.92 protocol to connect to host V.92 modems at data rates of up to 53,000 bits per second (bps). It uses the V.90 protocol to connect at data rates of up to 53,000 bps when connecting to a V.90 host modem. For connections that do not support either the V.90 or V.92 protocol, the internal modem uses the ITU standard V.34 protocol to connect at rates of up to 33,600 bits per second. The internal modem also supports all of the earlier, lower-speed ITU/CCITT modem protocols.
Fax capability	You can use the internal modem to transmit and receive facsimiles at rates of up to 14,400 bps. The internal modem supports Class 1 fax transmission.
Standard commands	The internal modem is compatible with the industry standard Hayes® AT commands and S-Register settings.
Error control	This feature assures accurate data transmission even over telephone lines subject to noise interference. The internal modem uses Microcom Networking Protocol® 4 (MNP4) and V.42 error correction.
Data compression	Compression can greatly increase data throughput. The internal modem supports the new V.44 compression protocol, which is optimized for World Wide Web browsing. It also supports MNP5 and V.42bis data compression protocols.
Serial port access	The internal modem frees your computer's serial port for connection of a serial mouse, serial printer or other serial device.

Ring indicator	The computer can be powered on automatically when the modem answers a call. This feature is available only when the computer is in Resume/Standby mode. Refer to your computer's documentation for details on ring indicator power on.
Standby/Hibernate	When the computer is set to Standby or Hibernate, the modem settings automatically resume when you turn on the power. Refer to your computer's documentation for details on Standby/Hibernate modes.
Modem On Hold	Enables you to talk on the telephone while connected to the Internet, using the same telephone line. This feature requires ISP support and Call Waiting/Caller ID Service. The phone line must support Type 2 Caller ID (CID).
Fast Connect	Shortens connection times up to 25 percent, by storing phone line characteristics.
PCM upstream	Transmits up to a maximum rate of 48,000 bits per second upstream to host V.92 modems that support this feature.

Function charts

The modem supports these communication protocols:

Functions available in all operating systems

<i>Function</i>	<i>Remarks</i>
Data V.92/V.90	From 32 Kbps to 56 Kbps
V.34	From 2400 bps to 33.6 Kbps
V.32bis	4800, 7200, 9600 bps, 12, 14.4 Kbps

Functions available in all operating systems (Continued)

<i>Function</i>	<i>Remarks</i>
V.32	4800, 9600 bps
V.22bis	1200, 2400 bps
V.22	1200 bps
V.23	75, 600, 1200 bps
V.21	300 bps
BELL212A	1200 bps
BELL103	300 bps
MNP5	Data compression
MNP4	Error control
V.44	Data compression
V.42bis	Data compression
V.42	Error control
Fax V.17	7200, 9600 bps, 12, 14.4 Kbps
V.29	7200, 9600 bps
V.27ter	2400, 4800 bps
V.21 ch2	300 bps
EIA-578	Class 1 command set for fax



Definition: bps stands for bits per second.

Chapter 1

Modem On Hold

Your computer comes with the Modem On Hold application preinstalled. This application enables you to answer incoming voice calls or make outgoing voice calls while maintaining your Internet connection, by putting the Internet connection on hold.

To use the Modem On Hold feature, you must have Call Waiting service and an ISP that supports the V.92 modem protocol. You must also have Caller ID service, if you want the application to display the identity of incoming calls. The phone line must support Type 2 Caller ID.

For V.90 connections, which do not support the Modem On Hold feature, the Modem On Hold application displays the incoming call information so that you can choose to either ignore it, or disconnect the Internet connection to answer the call. The application can also be configured to automatically disconnect your Internet connection so that you can answer incoming voice calls, in case you do not have Call Waiting service.

The Modem On Hold application comes configured to automatically launch when you start the computer, displaying an  icon on the system tray. However, you can change this configuration. See [“Configuring Modem On Hold”](#) on [page 25](#) for instructions.

Using Modem On Hold

The Modem On Hold application pops up the V.92 Modem On Hold dialog whenever an incoming voice call is detected, or you place an outgoing voice call while connected to the Internet. This dialog displays information about the call in a Call Status box.

Answering an incoming voice call

When the modem detects an incoming voice call during an Internet connection, the V.92 Modem on Hold dialog appears. The Call Status box indicates that a call is waiting. If you have Caller ID, the dialog also displays the phone number and identity of the incoming call.

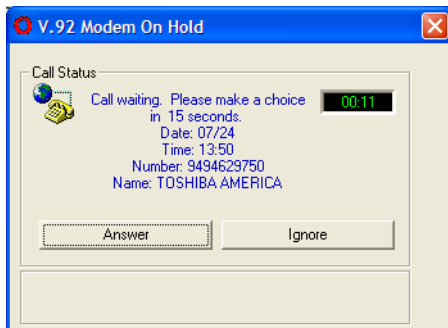

Sample Incoming voice call dialog box

- 1 To ignore an incoming call, click **Ignore**, or simply ignore the call.

If you ignore the call, it will continue to ring until the timer expires in 15 seconds.

- 2 To answer an incoming call, click **Answer**, then pick up your telephone handset.

The Call Status box indicates that the Internet connection is on hold while you complete your voice call.



Sample Modem On Hold in progress dialog box

- 3 To maintain the Internet connection, you must complete the voice call before the Modem On Hold timer expires.

The application displays the timer in the lower right corner. The timeout value is determined by your ISP.

- 4 To end your voice call and resume your Internet connection, click **Resume Data Call**.

A dialog displays, indicating that the Modem On Hold has been cancelled and instructing you to hang up.

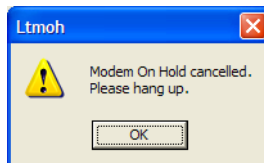

Sample Modem On Hold cancelled dialog box

- 5 Click **OK**.

The Call Status box indicates that it is resuming the modem (Internet) connection.



Sample Resuming modem connection dialog box

The modem connection is automatically renegotiated and your Internet connection resumes.



NOTE: A "Call Canceled" message may display. If this occurs, wait a few seconds while the modem automatically redials and reestablishes your Internet connection.

Placing an outgoing voice call

To use this function, your phone line must support three-way calling service.

- 1 Right-click the  icon, located on the system tray, to display the modem popup window.

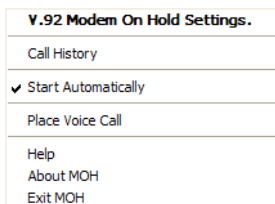

Sample modem popup window

- 2 Click **Place Voice Call**.

The V.92 Modem On Hold dialog appears, instructing you to click the Call button.



Sample Placing a voice call dialog box

- 3 Before the 15-second timer runs out, click **Call**. Otherwise, click **Ignore** to cancel the call.

The Call Status box indicates that the Internet connection is on hold while you complete your voice call.



Sample Modem On Hold in progress dialog box

- 4 Pick up your telephone handset and place your voice call.
- 5 To maintain the Internet connection, you must complete the voice call before the Modem On Hold timer expires.

The application displays the timer in the lower-right corner. The timeout value is determined by your ISP.

- To end your voice call and resume your Internet connection, wait until the incoming caller has hung up, then click **Resume Data Call**.

If you hang up before the incoming caller, a “Call Cancelled” message may display. If this occurs, wait a few seconds while the modem automatically redials and reestablishes your Internet connection.

A dialog displays, indicating that the Modem On Hold has been cancelled and instructing you to hang up.

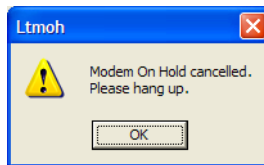

Sample Modem On Hold cancelled dialog box

- Click **OK**.

The Call Status box indicates that it is resuming the modem connection.

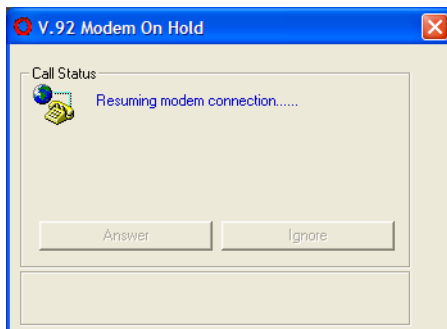

Sample Resuming modem connection dialog box

The modem connection is automatically renegotiated and your Internet connection resumes.

Viewing Call History

The Modem On Hold application provides a log of the last ten incoming calls. The log includes the date, time, phone number, and Caller ID (if you have Caller ID service).

- 1 To view the call history, right-click the  icon, located on the system tray, to display the modem popup window.

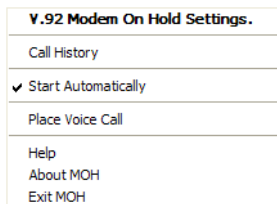

Sample modem popup window

- 2 Click **Call History** to display the Call History log.

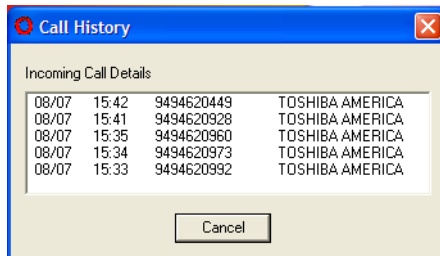

Sample Call History log

Configuring Modem On Hold

The Modem On Hold application comes preconfigured with Call Waiting, Caller ID, and the Modem On Hold Feature enabled. If your configuration does not match this, you can change the default configuration. You can also configure the application so that it does not automatically run when you start your computer.

Configuring Modem On Hold settings

You configure Modem On Hold settings from the V.92 MoH Settings dialog.

- 1 To open the V.92 MoH Settings dialog, double-click the  icon, located on the system tray in the lower-right corner of your desktop.

The V.92 MoH Settings dialog appears.

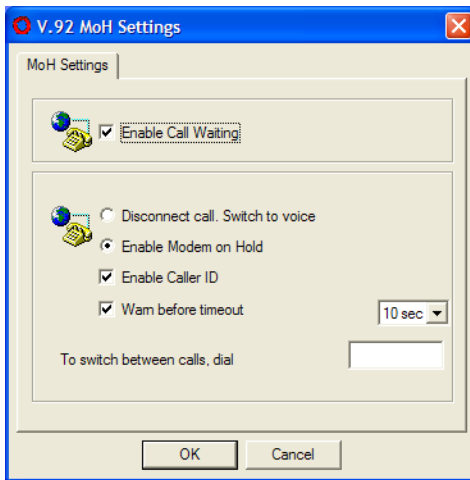

Sample V.92 MoH Settings dialog box

- 2 If you do not have Call Waiting service, clear the **Enable Call Waiting** check box.

All of the other settings in this dialog become unavailable. If you do not have Call Waiting, the modem will still display a message when it detects an incoming call during an Internet connection, however you will not be able to use the Modem On Hold feature to answer that call without losing the Internet connection.

- 3 If you do not want the Modem On Hold feature enabled, select **Disconnect call. Switch to voice.**

When the modem detects an incoming voice call during an Internet connection, it disconnects the Internet connection so that you can answer the voice call.

- 4 If Modem On Hold is enabled, you can select or clear the **Enable Caller ID** check box to match your telephone service.

- 5 To disable the warning that displays before the Modem On Hold timer expires (disconnecting an incoming or outgoing voice call if not completed), clear the **Warn before timeout** check box.

- 6 To change the Modem On Hold warning timer value, select a value from the **Warn before timeout** dropdown box.

You can set the timer from 10 to 60 seconds, in intervals of 10 seconds.

- 7 If your phone system requires a number to be dialed to switch between voice and data calls, enter that number in the **To switch between calls, dial** box.

If your phone system requires one number to switch from voice to data and a different number to switch from data to voice, enter both numbers in the box, separated by a comma.

- 8 Click **OK** to close the dialog and save your changes.

Enabling/Disabling the Modem On Hold autorun status

- 1 Right-click the  icon, located on the system tray, to display the modem popup window.

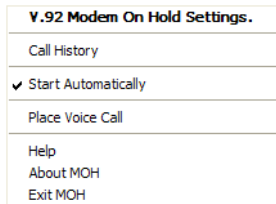

Sample modem popup window

- 2 If **Start Automatically** is checked, you can click it to clear the check mark.

The Modem On Hold application no longer launches automatically when you start your computer.

- 3 If **Start Automatically** is not checked, you can click it to select this option.

A check mark appears next to the option. The Modem On Hold application now launches automatically when you start your computer.

Adding and removing the Modem On Hold icon from the system tray

If you no longer wish to use the Modem On Hold application, you may want to remove it from your system tray. You can add the icon to the system tray at a later time.

Removing the icon

- 1 Right-click the  icon, located on the system tray, to display the modem popup window.

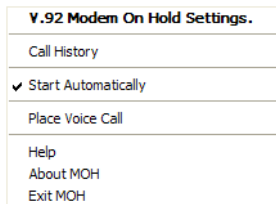

Sample modem popup window

- 2 Click **Exit MOH**.
A confirmation dialog appears.
- 3 Click **OK** to remove the icon from the system tray.

Adding the icon

From your desktop, click **Start, Programs, Toshiba Internal Modem, Modem on Hold**. The icon is added to the system tray.

Locating the Modem On Hold application version

- 1 Right-click the  icon, located on the system tray, to display the modem popup window.

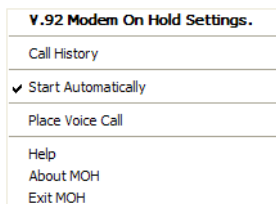

Sample modem popup window

- 2 Click **About MOH** to display the application version.

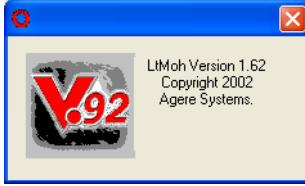

Sample About MOH

Chapter 2

Function Check

This chapter describes how to check the internal modem's functions. Use this procedure when the modem is not working properly, to help identify the problem and, in many cases, the solution.

Running diagnostics

If the modem is not working properly, running some simple diagnostics can help you determine if the modem drivers are installed correctly, or if the modem is not working due to a conflict with another application using the communications port.

To run modem diagnostics:

- 1 Double-click **Control Panel** on your computer's desktop to open the Control Panel.

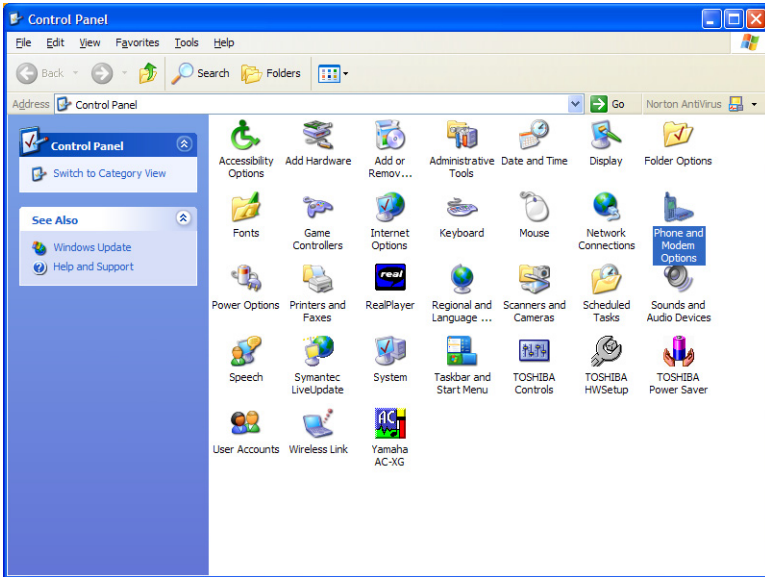

Sample Control Panel

- 2 Double-click **Phone and Modem Options** to open the Phone and Modem Options window.

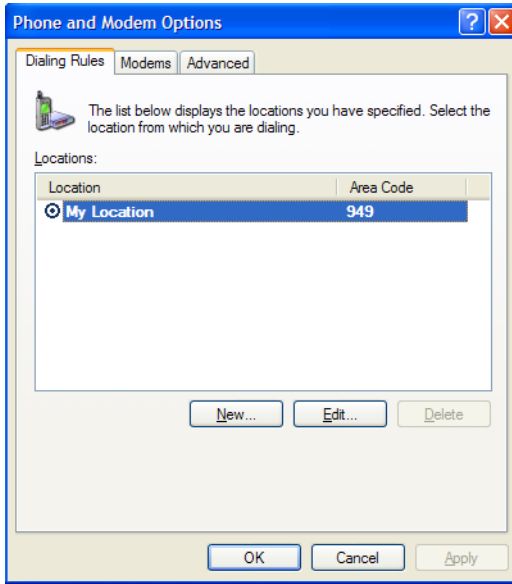

Sample Phone and Modem Options window

- 3 Click the **Modems** tab to display the installed modems.

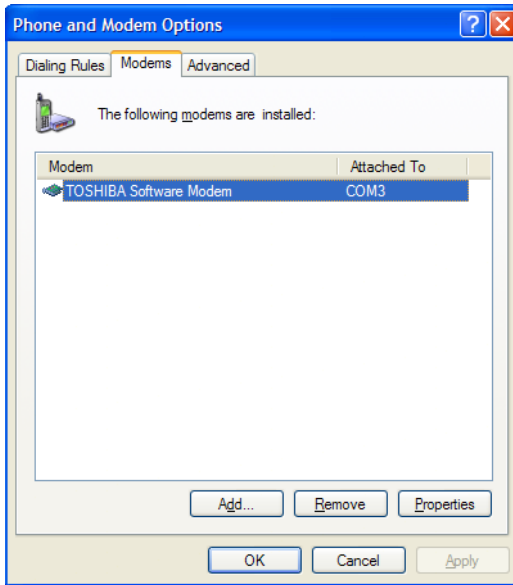

Sample Modems tab dialog box

- 4 If it is not already selected, click **Toshiba Software Modem**, then click **Properties** to open the Toshiba Software Modem Properties window.

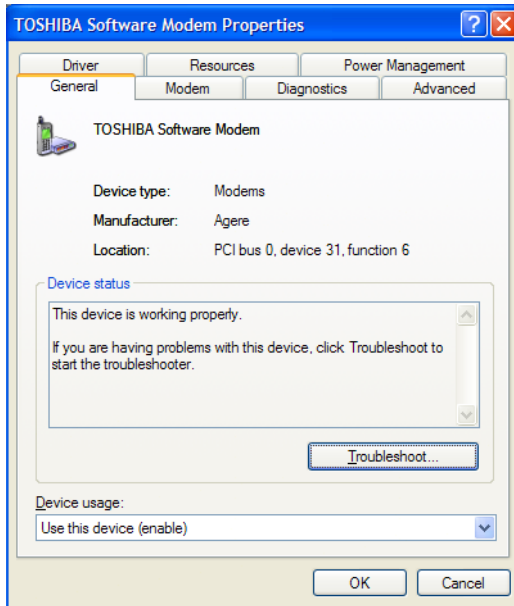

Sample Toshiba Software Modem Properties window

- 5 Click the **Diagnostics** tab.

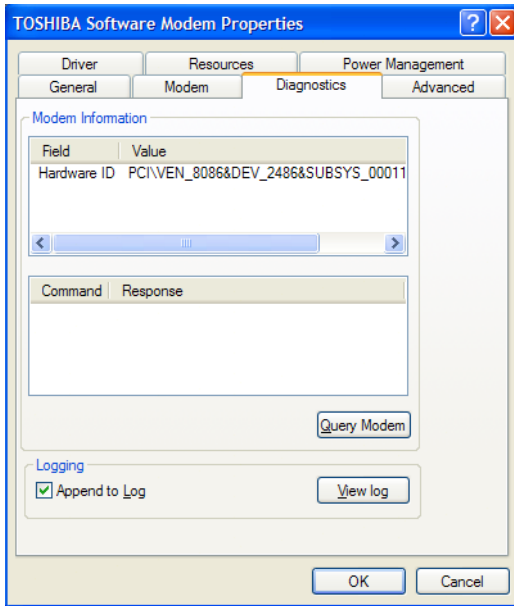

Sample Diagnostics tab

6 Click **Query Modem**.

The system executes an automatic operations test, displaying the following message while the test is in progress.

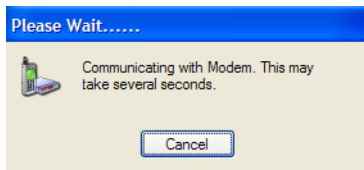

Sample Diagnostics test in progress message

If the diagnostic test runs successfully, a series of commands and the modem's response displays in the Modem Information box. The modem drivers are installed correctly.

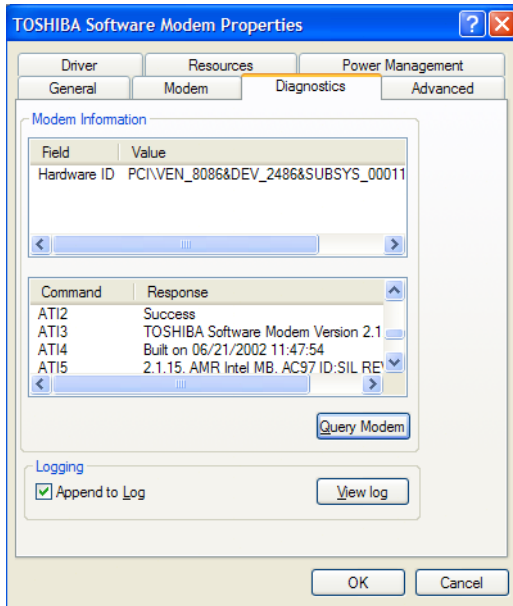

Sample Diagnostics results

If the diagnostics test fails, you may see a “Can’t Open Port” message. This indicates that another application is using the COM port, or the modem driver is not properly installed.

- 7 If the diagnostic test fails, and this is the first time you’ve run the test, restart the computer and repeat [step 1](#) through [step 6](#).
- 8 If the diagnostic test fails a second time, double-click **Control Panel** on your computer’s desktop to open the Control Panel.
- 9 Double-click **Add/Remove Programs** to open the Add/Remove programs window.
- 10 Select and remove the Toshiba Software Modem.
- 11 If prompted to do so, restart the computer.

- 12 Reinstall the Toshiba Software Modem driver.

If you do not have the latest driver, you can download it from www.toshiba.com.

- 13 Repeat [step 1](#) through [step 6](#) to run diagnostics again.

The issued AT commands, and the modem's response, appear in the Modem Information box. Use the scroll bar, if necessary, to locate the ATI3 command and its response.

- 14 Verify that the driver you installed in [step 12](#) is the currently installed driver.

Determining current connection protocol

If V.92 features do not appear to be functioning, verify that the connection is a V.92 connection using the following procedure.

- 1 Double-click **Control Panel** on your computer's desktop to open the Control Panel.

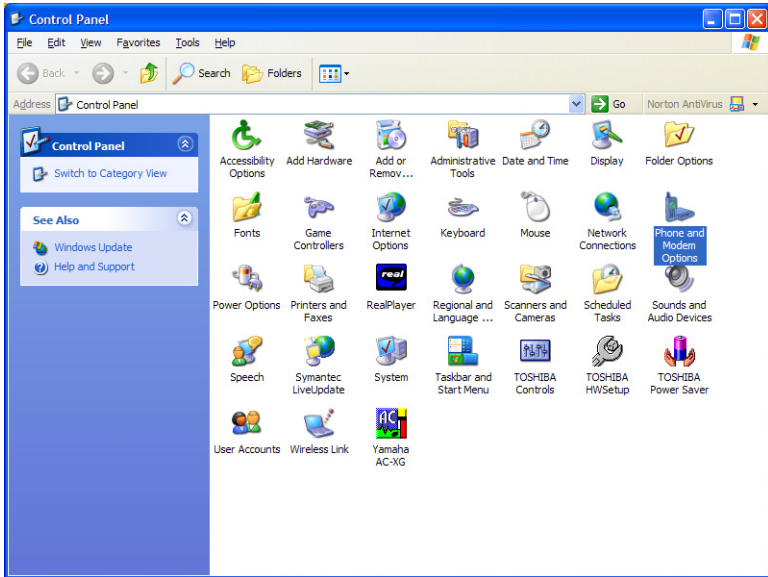
Determining current connection protocol

Sample Control Panel

- 2 Double-click **Phone and Modem Options** to open the Phone and Modem Options window.

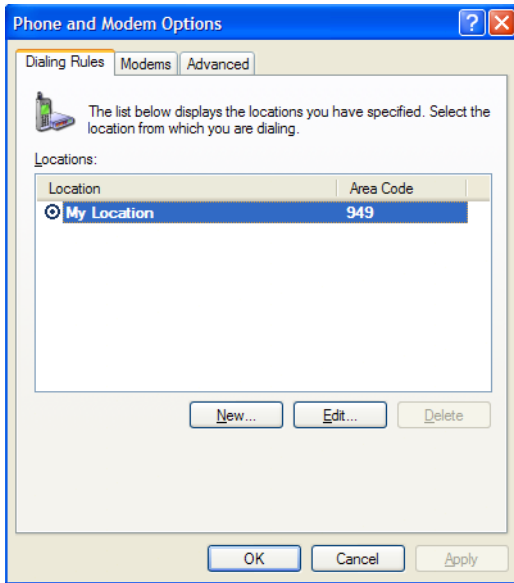

Sample Phone and Modem Options window

- 3 Click the **Modems** tab to display the installed modems.

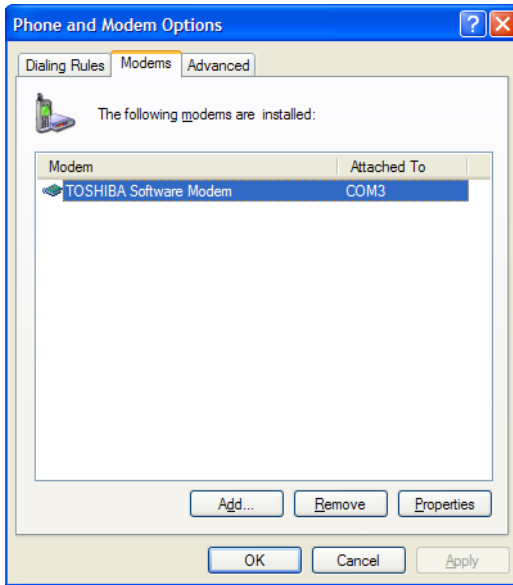
Determining current connection protocol*Sample Modems tab*

- 4 If it is not already selected, click **Toshiba Software Modem**, then click **Properties** to open the Toshiba Software Modem Properties window.

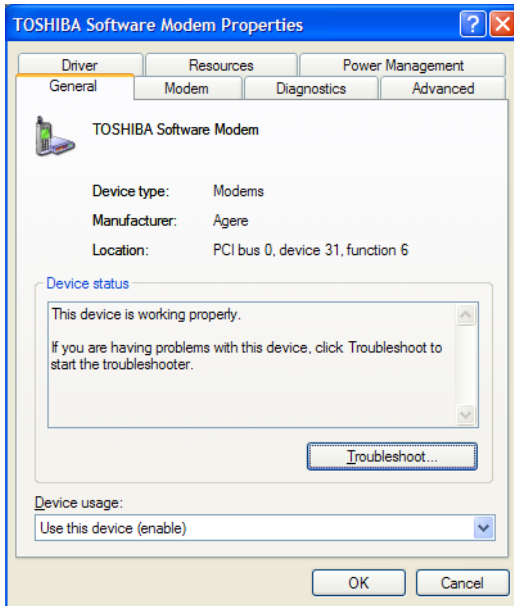

Sample Toshiba Software Modem Properties window

- 5 Click the **Diagnostics** tab.

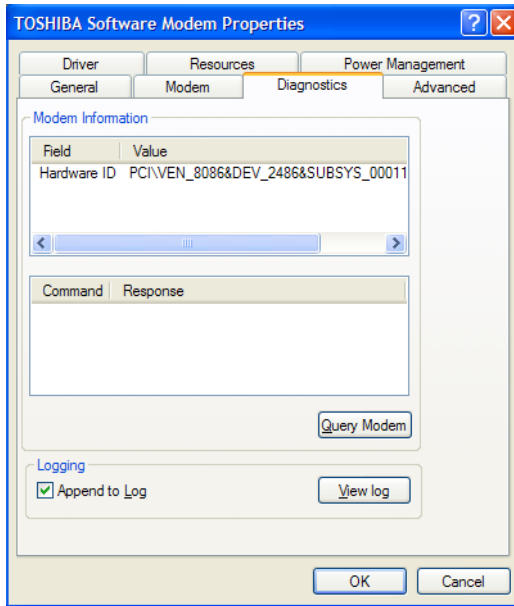
Determining current connection protocol*Sample Diagnostics tab*

- 6 Click **View log** to display connection information about the last call.
- 7 Locate the data compression format in the log. If it lists V.44 data compression, the connection was a V.92 connection.
- 8 To append connection information for future calls to the existing call log, on the Diagnostics tab select the **Append to Log** check box.

Chapter 3

Using the Internal Modem

This chapter describes connection procedures and basic operations.

Connection procedures

This section describes how to connect the internal modem to, and disconnect it from, a telephone jack.



CAUTION: The modem is designed for use with a standard analog telephone line. Do not connect the modem to a digital telephone line. A digital line may damage the modem. If you connect the modem to a digital telephone line, the modem will not dial, and will display the message NO DIAL TONE at the AT command line.

Analog or digital?

- ❖ If you are not sure which type of line a particular line jack offers, assume that it is digital and do not connect the internal modem to it.
- ❖ If the wall jack is known to be connected to a PBX (Private Branch Exchange) system, then the line is digital. Do not connect the modem to it.
- ❖ If a (working) telephone connected to the wall jack has an REN (Ringer Equivalency Number) printed on its label, then it is an analog phone. If the phone is working correctly, then the wall jack itself is analog.
- ❖ Telephones in an office environment are commonly connected to digital phone lines.
- ❖ Unfortunately, the wall jacks for both analog and digital phone lines use the familiar RJ11 connector as shown on page 46. If you are not sure that an RJ11 jack terminates an analog phone line, do not connect the modem to it.

Connecting the internal modem



CAUTION: In the event of a lightning storm, unplug the modem cable from the telephone jack.

A standard modular cable is supplied with the internal modem. Follow the steps below to connect the internal modem to a telephone jack.

- 1** Turn the connector so that the small connecting lever faces down.
- 2** Squeeze the lever and plug the connector into the computer's modem port.
- 3** Plug the other end of the cable into an RJ11 wall jack.

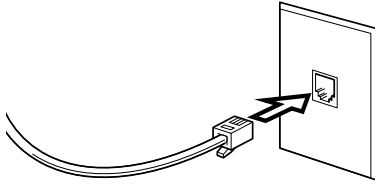

Connecting the internal modem



NOTE: When you connect the RJ11 jack, insert it until you hear a click.

Disconnecting the internal modem

When you need to disconnect the internal modem's modular cable:

- 1 Pinch the connecting lever on the connector in the telephone wall jack and pull out the connector.

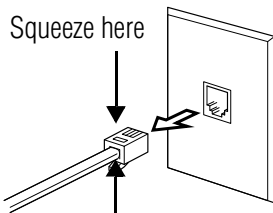

Disconnecting the cable from the wall jack

- 2 Disconnect the modular cable from the computer's modem port.

Basic operation

After you connect the modular cable to your internal modem and a telephone line, you are ready to run your communication software. Refer to your software documentation for instructions on operating your internal modem.

As examples, this section describes how to execute basic modem operations by typing AT commands directly into the communication software program. You must be in terminal mode to enter the AT commands. Refer to your software documentation or online help.

Connecting to a telephone line

The AT commands for connecting to a telephone line depend on whether you are using a direct line or an extension line, such as in an office building.

Direct access line

- ❖ To place a call using *tone* dialing, enter:

ATDT***** and press Enter.

The asterisks * indicate the number you are calling.

- ❖ To place a call using *pulse* dialing, enter:

ATDP***** and press Enter.

The asterisks * indicate the number you are calling.

Extension line

If you are calling from an extension line, such as in an office building, and need to dial nine or another number to gain external access, follow the steps below.

- ❖ To place a call using tone dialing, enter:

ATDT 9, ***** and press Enter.

The nine or other number is for line access; the comma (,) is for a pause (about 2 seconds with the default setting) to give time for a connection. The asterisks * indicate the number you are calling.

- ❖ To place a call using pulse dialing, enter:

ATDP 9, ***** and press Enter.

The nine or other number is for line access; the comma is for a pause (about 2 seconds with the default setting) to give time for a connection. The asterisks * indicate the number you are calling.

You can enter as many commas as you need. The following example will result in a six-second pause:

ATDT 9,,, ***** and press Enter.



*NOTE: If you are using a PBX connection that does not wait for a dial tone, add the X0, X1 or X3 to the AT command line. For example: ATX3DP 9, ***** and press Enter.*

Actual usage will vary according to the host system, so please check with the system manager.

Receiving a call

To set the number of rings before the internal modem automatically answers the phone, set the S0 register as follows:

ATS0=* and press Enter.

The asterisk * indicates the number of rings.

See “S-Register values” on page 82 for more details.

Terminating a call

The methods for terminating a call depend on the status of the connection.

- ❖ If the internal modem is dialing or has not yet gone online, you can terminate a call by pressing any key.
- ❖ If the terminal is online, enter the escape code (+++), then type: ATH and press Enter.
- ❖ If the remote party disconnects, the call will be automatically cut off.
- ❖ If the power to the computer is cut off, the call is terminated.

Setting the data flow control

Data flow control is used to start and stop data transmission according to the status of the data buffer (full or empty). The following describes how to set the data flow control method:

- ❖ CTS/RTS (hardware control)
- ❖ XON/XOFF (software)

Also, see “MNP and V.42” on page 95.

CTS/RTS control

This control method is hardware-dependent. To control data flow, the modem and computer transmit Clear To Send/Request To Send signals to each other. To set CTS/RTS control, enter the following AT command:

```
AT\Q3
```

XON/XOFF control

This control method is managed by software. The start/stop signals, that is transfer on/transfer off, are included in the data stream. To set XON/XOFF control, enter the following AT command:

```
AT\Q1
```

Please use any settings recommended in your communications software manual.

Facsimiles

Fax communication uses EIA-578 Class 1 commands and requires fax software. Communication is controlled by the fax software.



NOTE: Use only software compatible with EIA-578 Class 1. Do not use EIA-592 Class 2-compatible software.

Chapter 4

AT Commands

In most cases, you will not need to type AT commands manually. However, there may be some occasions when you will need to do so.

This chapter describes AT commands for data mode. Fax commands are issued by application software.

AT command formats

The format for entering AT commands is:

ATXn

where X is the AT command, and n is the specific value for some of the commands. After you type in the command, press Enter.

Any command issued is acknowledged with a response in either text or numeric values known as result codes.

All commands and command-values accepted by the modem are described in this section; any entry other than those listed results in an error.

If no value is entered for n, then the command defaults to a value of n=0.

+++ Escape sequence

The escape sequence allows the modem to exit *data mode* and enter *online command mode*. While in online command mode, you can communicate directly with your modem using AT commands. When you finish, you can return to data mode using the ATO command.

There must be a pause after you enter an escape sequence before any additional characters can be sent to the modem. The length of this pause is set by Escape Guard Time (S12). The pause prevents the modem from interpreting the escape sequence as data.

The value of the escape sequence character may be changed using register S2.

A/ Repeat last command

This command repeats the last command string entered. Do not precede this command with an AT prefix nor conclude it by pressing Enter.

A Answer command

This command instructs the modem to go off-hook and answer an incoming call.

Bn Communication standard setting

This command determines the communication standard—either CCITT or Bell.



NOTE: This command is only useful for matching the modem to slower modems. It is rarely used today.

B0 Selects CCITT V.22 mode when the modem is at 1200 bps.

B1	Selects Bell 212A when the modem is at 1200 bps.
B2	Unselects V.23 reverse channel.
B3	Unselects V.23 reverse channel.
B15	Selects V.21 when the modem is at 300 bps.
B16	Selects Bell 103J when the modem is at 300 bps.

Result Codes:

OK	n = 0,1,2,3,15,16
ERROR	Otherwise

Dn Dial

This command instructs the modem to dial a telephone number. Enter n (the telephone number and any modifiers) after the ATD command.

Any digit or symbol (0-9, *, #, A, B, C, D) may be dialed as touch-tone digits. Characters such as spaces, hyphens, and parentheses do not count. They are ignored by the modem, but you may want to include them to make the number and modifiers easier to read.

The following may be used as phone number modifiers:

P	Pulse dialing.
S=n	Dial using the string saved by &Zn command.
T	Touch-tone dialing (default).
,	Pause during dialing. Pause for time specified in Register S8 before processing the next character in the dial string.
W	Wait for dial tone. Modem waits for a second dial tone before processing the dial string.

- @ Wait for quiet answer. Wait for five seconds of silence after dialing the number. If silence is not detected, the modem sends a NO ANSWER result code back to the caller.
- ! Hook flash. Causes the modem to go on-hook for 0.5 seconds and then return to off-hook.
- ; Return to command mode. Causes the modem to return to command mode after dialing a number, without disconnecting the call.
- L Redials last number. Should be the first character following ATD; ignored otherwise.
- \$ Bong tone detection

En Echo command

This command controls whether or not the characters entered from your computer keyboard are displayed on your monitor (echoed) while the modem is in command mode.

- E0 Disables echo to the computer.
- E1 Enables echo to the computer (default).

Result Codes:

- OK n=0,1
- ERROR Otherwise

Hn Hook control

This command instructs the modem to go on-hook to disconnect a call, or off-hook to make the phone line busy.

H0 Modem goes on-hook (default).

H1 Modem goes off-hook.

Result Codes:

OK n=0,1

ERROR Otherwise

In Request ID information

This command displays product information about the modem.

I0 or I3 Returns the modem identity string and driver version number.

I1 Returns OK (no function).

I2 Returns OK (no function).

I4 Returns the driver build date.

I5 Returns the driver version, bus type (PCI, AC97), codec type, and country.

I6 Returns OK (no function).

I7 Returns the hardware version.

I8 Returns the codec type.

I9 Returns the country ID in English.

I10 Returns OK (no function).

I11 Returns connection information.

The following table contains an example of the connection information returned by the I11 command:

<i>Description</i>	<i>Status</i>
Last Connection	V.92
Initial Transmit Carrier Rate	24000
Initial Receive Carrier Rate	49333
Final Transmit Carrier Rate	24000
Final Receive Carrier rate	49333
Protocol Negotiation Result	LAPM
Data Compression Result	V.44
Estimated Noise Level	199
Receive Signal Power Level (-dBm)	26
Transmit Signal Power Level (-dBm)	13
Round Trip Delay (msec)	0
Near Echo Level (-dBm)	13
Far Echo level (-dBm)	73
Transmit Frame Count	0
Transmit Frame Error Count	0
Receive Frame Count	0
Receive Frame Error Count	0
Retrain by Local Modem	0
Retrain by Remote Modem	0
Rate Renegotiation by Local Modem	0
Rate Renegotiation by Remote Modem	0
Call Termination Cause	1
Robbed-Bit Signaling	0
Digital Loss (dB)	03
Remote Server ID	NA

Connection Time (sec) 19.968
OK

The AT+I1 command may be issued from online command mode or after the end of a call. After a call, some of the values are no longer valid. The following table defines each command result, and indicates if the result is valid only during the call:

<i>Description</i>	<i>Definition</i>
Last Connection	V.92, V.90, V.34, or V.32, depending on the type of connection negotiated.
Initial Transmit Carrier Rate	Initial upstream rate.
Initial Receive Carrier Rate	Initial downstream rate.
Final Transmit Carrier Rate	Current or final upstream rate.
Final Receive Carrier rate	Current or final downstream rate.
Protocol Negotiation Result	LAPM, MNP, or NONE, depending on V.42 negotiation.
Data Compression Result	V.44, V.42bis, MNP5 or NONE.
Estimated Signal/Noise Level	Signal-to-noise ratio with implied negative. Higher values indicate better conditions.
Receive Signal Power Level (-dBm)	The received signal power which, although labeled in -dBm, is only a relative measure for comparing calls to and from different locations. This value is valid only during a call.

Transmit Signal Power Level (-dBm)	The signal power transmitted upstream.
Round Trip Delay (msec)	The round trip delay, in milliseconds.
Near Echo Level (-dBm)	Near echo levels only.
Far Echo level (-dBm)	Far echo levels only.
Transmit Frame Count	The number of LAPM frames sent upstream during this call. The count wraps around at 65,535.
Transmit Frame Error Count	The number of REJ frames received at the analog client modem.
Receive Frame Count	The number of LAPM frames received by the client modem during this call. The count wraps around at 65,535.
Receive Frame Error Count	Number of frames received in error by the client modem.
Retrain by Local Modem	Number of retrains requested by the client modem.
Retrain by Remote Modem	Number of retrains requested by the remote modem.
Rate Renegotiation by Local Modem	Number of renegotiations requested by the client modem.
Rate Renegotiation by Remote Modem	Number of renegotiations requested by the remote modem.

Call Termination Cause	The reason the call ended. This value is valid only after the call ends. 0 local modem command; ATH, DTR drop. 1 remote modem command: cleardown, loss of signal. 2 no answer, busy, etc. 3 training failure (V.90 or V.34). 4 protocol failure, for example if required by V.4.
Robbed-Bit Signaling	For PCM connection only, a hexadecimal 6-bit pattern of T1 frames with robbed-bit signaling.
Digital Loss (dB)	For PCM connection only, the downstream digital loss.
Remote Server ID	NA
Connection Time (sec)	The time between the remote answer and the connect result, in seconds.

Result Codes:

As described n=0,1,2,3,4,5,6,7,8,9,11
ERROR Otherwise

Ln Monitor speaker volume

This command sets speaker volume to low, medium, or high.

- L0 Low volume
- L1 Low volume (Same as L0)
- L2 Medium volume (default)
- L3 High volume

Result Codes:

- OK n=0,1,2,3
- ERROR Otherwise

Mn Monitor speaker mode

This command turns the speaker on or off.

- M0 The speaker is off.
- M1 The speaker is on until the modem detects the carrier signal (default).
- M2 The speaker is always on when modem is off-hook.
- M3 The speaker is on until the carrier is detected, except when dialing.

Result Codes:

- OK n=0,1,2,3
- ERROR Otherwise

Nn Modulation handshake

This command controls whether or not the local modem performs a negotiated handshake at connection time with the remote modem when the communication speed of the two modems is different.

- | | |
|----|--|
| N0 | When originating or answering, this is for handshake only at the communication standard specified by S37 and the ATB command. |
| N1 | When originating or answering, begin the handshake at the communication standard specified by S37 and the ATB command (default). |

During handshake, a lower transmission speed may be selected.

Result Codes:

- | | |
|-------|-----------|
| OK | n=0,1 |
| ERROR | Otherwise |

On Return online to data mode

- | | |
|----|--|
| O0 | Instructs the modem to exit online command mode and return to data mode (see AT escape sequence, +++). |
| O1 | This command issues a retrain before returning to online data mode. |
| O3 | This command issues a rate renegotiation before returning to online data mode. |

Result Codes:

- | | |
|-------|-----------|
| OK | n=0,1,3 |
| ERROR | Otherwise |

P Select pulse dialing

This command configures the modem for pulse (non-touch-tone) dialing. Dialed digits are pulsed until a T command or dial modifier is received. Tone dial is the default setting.

Qn Result code control

Result codes are informational messages sent from the modem and displayed on your monitor. Basic result codes are OK, CONNECT, RING, NO CARRIER, and ERROR. The ATQ command allows the user to turn result codes on or off.

- Q0 Enables modem to send result codes to the computer (default).
- Q1 Disables modem from sending result codes to the computer.

Result Codes:

- OK n=0,1
- ERROR Otherwise

T Select tone dialing

This command instructs the modem to send DTMF tones while dialing. Dialed digits are tone dialed until a P command or dial modifier is received. This is the default setting.

Vn DCE response format

This command controls whether result codes (including call progress and negotiation progress messages) are displayed as words or their numeric equivalents.

- V0 Displays result codes as digits.
- V1 Displays result codes as text (default).

Result Codes:

OK n=0,1
 ERROR Otherwise

Wn Result Code Option

W0 CONNECT result code reports DTE speed.
 Disable protocol result codes.
 W1 CONNECT result code reports DTE speed.
 Enable protocol result codes.
 W2 CONNECT result code reports DCE speed.
 Enable protocol result codes (default).

Result Codes:

OK n=0,1,2
 ERROR Otherwise

Xn Result code selection, call progress monitoring

This command sets detection options for dial tones and busy signals, which is its primary function. However, it also enables or disables extended result codes.

<i>Command</i>	<i>Extended Result code</i>	<i>Dial tone Detect</i>	<i>Busy signal Detect</i>
X0	Disable	Disable	Disable
X1	Enable	Disable	Disable
X2	Enable	Enable	Disable
X3	Enable	Disable	Enable
X4 (default)	Enable	Enable	Enable
X5	Enable	Enable	Enable

Extended result codes

- Disabled:** Displays only the basic result codes: OK, CONNECT, RING, NO CARRIER, and ERROR.
- Enabled:** Displays basic result codes, along with the connect message and the modem's data rate, and an indication of the modem's error correction and data compression operation.

Dial tone detect

- Disabled:** The modem dials a call regardless of whether it detects a dial tone.
- Enabled:** The modem dials only upon detection of a dial tone, and disconnects the call if the dial tone is not detected within the specified time. The period of time the modem waits before dialing is specified in register S6.

Busy tone detect

- Disabled:** The modem ignores any busy tones it receives.
- Enabled:** The modem monitors for busy tones.
- Result Codes:**
- | | |
|-------|---------------|
| OK | n=0,1,2,3,4,5 |
| ERROR | Otherwise |

Zn Recall stored profile

The modem performs a soft reset and restores (recalls) a configuration profile according to the parameter supplied. You can store two configuration profiles. If no parameter is specified, zero is assumed.

- | | |
|----|-------------------------------------|
| Z0 | Reset and restore stored profile 0. |
| Z1 | Reset and restore stored profile 1. |

Result Codes:

- | | |
|-------|-----------|
| OK | n=0,1 |
| ERROR | Otherwise |

&Cn Data Carrier Detect (DCD) control

Data Carrier Detect is a signal from the modem to the computer indicating that a carrier signal is being received from a remote modem. DCD normally turns off when the modem no longer detects the carrier signal.

- | | |
|-----|---|
| &C0 | The state of the carrier from the remote modem is ignored. DCD circuit is always on. |
| &C1 | DCD turns on when the remote modem's carrier signal is detected, and off when the carrier signal is not detected (default). |

Result Codes:

- | | |
|-------|-----------|
| OK | n=0,1 |
| ERROR | Otherwise |

&Dn Data Terminal Ready (DTR) control

This command interprets how the modem responds to the state of the DTR signal and changes to the DTR signal.

- &D0 Ignore. The modem ignores the true status of DTR and treats it as always on. This should only be used if your communication software does not provide DTR to the modem.
- &D1 If the DTR signal is not detected while in online data mode, the modem enters command mode, issues an OK result code, and remains connected.
- &D2 If the DTR signal is not detected while in online data mode, the modem disconnects (default).
- &D3 Reset the modem on the on-to-off DTR transition.

Result Codes:

- OK n=0,1,2,3
- ERROR Otherwise

&F Load factory settings

This command loads the configuration stored and programmed at the factory. This operation replaces all of the command options and the S-Register settings in the active configuration with factory values.

- &F Recall factory setting as active configuration.

&Gn V.22bis guard tone control

This command determines which guard tone, if any, to transmit while transmitting in the high band (answer mode). This command is only used in V.22 and V.22bis mode. This option is not used from North America and is for international use only.

&G0 Guard tone disabled (default).

&G1 Sets guard tone to 550 Hz.

&G2 Sets guard tone to 1800 Hz.

Result Codes:

OK n=0,1,2

ERROR Otherwise

&Kn Local flow control selection

&K0 Disables flow control.

&K3 Enables RTS/CTS flow control (default).

&K4 Enables XON/XOFF flow control.

Result Codes:

OK n=0,3,4

ERROR Otherwise

&Pn Select Pulse Dial Make/Break Ratio

- &P0 Selects 39% - 61% make/break ratio at 10 pulses per second.
- &P1 Selects 33% - 67% make/break ratio at 10 pulses per second.
- &P2 Selects 33% - 67% make/break ratio at 20 pulses per second.

Result Codes:

- OK n=0 to 2
- ERROR Otherwise

&Tn Self-test commands

These tests can help to isolate problems if you experience periodic data loss or random errors.

- &T0 Abort. Stops any test in progress.
- &T1 Local analog loopback test, V.56 Loop 3. This test verifies modem operation, as well as the connection between the modem and computer. If the modem is online when this command is issued, the modem hangs up.

Result Codes:

- OK n=0
- CONNECT n=1
- ERROR Otherwise

&V View active configuration and stored profile

The modem maintains two stored profiles, in addition to the active profile. This command is used to display all three modem configurations, and any stored telephone numbers.

&V View all three configurations and any stored telephone numbers.

&W Store current configuration

This command saves the current (active) configuration (profile), including all S-Registers except S3, S4 and S5.

The current configuration comprises a list of storable parameters, which you can view using the &V command. These settings are restored to the active configuration upon receiving a Zn command or at power-up. Refer to “&V View active configuration and stored profile” on page 69.

&W0 Stores the current configuration as profile 0.

&W1 Stores the current configuration as profile 1.

Result Codes:

OK n = 0,1.

ERROR Otherwise

&Y Select stored profile for hardware reset

This command does not change the modem behavior, but is included for compatibility with applications that issue the &Y command.

Result Codes:

OK n = 0,1.

ERROR Otherwise

&Zn=x Store telephone number

This command is used to store up to four dialing strings in the modem's nonvolatile memory for later dialing. The format for the command is &Zn="stored number" where n is the location 0-3 to which the number should be written. The dial string may contain up to 34 characters. The ATDS=n command dials using the string stored in location n.

Result codes:

OK n = 0,1,2,3

ERROR Otherwise

\Nn Error control mode selection

This command determines the type of error control used by the modem when sending or receiving data.

- \N0 Buffer mode. No error control. (Also known as Normal Mode.)
- \N1 Direct mode.
- \N2 MNP or disconnect mode. The modem attempts to connect using MNP2-4 error control procedures. If this fails, the modem disconnects. This is also known as MNP-reliable mode.
- \N3 V.42, MNP, or buffer (default).
The modem attempts to connect in V.42 error control mode. If this fails, the modem attempts to connect in MNP mode. If this fails, the modem connects in buffer mode and continues operation. This is also known as V.42/MNP auto-reliable mode.
- \N4 V.42 or disconnect. The modem attempts to connect in V.42 error control mode. If this fails, the call will be disconnected.
- \N5 V.42. MNP or Buffer (same as \N3).

\N7 V.42. MNP or Buffer (same as \N3).

Result Codes:

OK n = 0,1,2,3,4,5,7
ERROR Otherwise

\Qn Local flow control selection

\Q0 Disable flow control.
\Q1 XON/XOFF software flow control.
\Q3 RTS/CTS to DTE (default).

Result Codes:

OK n = 0,1,3
ERROR Otherwise

\Vn Protocol result code

\V0 Disable protocol result code appended to DCE speed.
\V1 Enable protocol result code appended to DCE speed (default).

Result Codes

OK n = 0,1
ERROR Otherwise

%Cn Data compression control

This command determines the operation of V.42bis and MNP class 5 data compression. Online changes do not take effect until a disconnect occurs first.

%C0 V.42bis/MNP 5 disabled. No data compression.

%C1 V.42bis/MNP 5 enabled. Data compression enabled (default).

Result Codes:

OK n = 0, 1

ERROR Otherwise

-V.90=<n>

This command enables/disables V.90 and changes the downstream rate.

-V90=0 Disables V.90

-V90=1 Enables V.90 Auto rate (default value)

-V90=X Controls the downstream rate

-V90? Shows the current value

-V90=? Shows the range [0-21]

Possible values of n:

“AT-V90=X” *Downstream Rate*

0 V.90 disabled

1 Auto rate (Default)

2 28000 bps

3 29333 bps

4 30666 bps

5	32000 bps
6	33333 bps
7	34666 bps
8	36000 bps
9	37333 bps
10	38666 bps
11	40000 bps
12	41333 bps
13	42666 bps
14	44000 bps
15	45333 bps
16	46666 bps
17	48000 bps
18	49333 bps
19	50666 bps
20	52000 bps
21	53333 bps

+DS44 V.44 Data Compression Command

This command configures the V.44 data compression direction used by the modem. It can also be used to display the current data compression configuration, and the supported <direction> parameter values.

+DS44 = <direction>

Valid <direction> values are as follows:

- 0 Modem does not negotiate V.44 compression.

- 1 Modem negotiates V.44 compression for transmit only.
- 2 Modem negotiates V.44 compression for receive only.
- 3 Modem accepts V.44 compression in both or either direction (default).

Result Codes:

OK <direction> = 0,1,2,3

ERROR Otherwise

+DS44?

This command displays the current V.44 compression configuration.

+DS44=?

This command displays the supported +DS44 <direction> parameter values.

+MS Command

This command can be used to set protocol and connection speed parameters for the modem. Instead of having to change multiple S registers, this single command produces the same effect. The command can also be used to display the current modem protocol and maximum connection speed settings. In addition, it can be used to display all the supported +MS command parameter values.

+MS= <carrier>, <automode>, <min_rate>, <max_rate>,

This command is used to set the various parameters described below:

<carrier> The modem protocol. Valid values are:

<i>Value</i>	<i>Meaning</i>
V92	V.92 (default)
V90	V.90
V34	V.34
V32T	V.32ter
V32B	V.32bis
V32	V.32
V22B	V.22bis
V22	V.22
Bell212A	Bell 212A
V23C	V.23, constant carrier, asymmetric FDM
V21	V.21
Bell103	Bell 103

<automode> 0 Disables automatic modulation negotiation

1 Enables automatic modulation negotiation (default)

If a <max_rate> value is specified, <automode> is automatically disabled.

<min_rate> The minimum receive rate. Valid <min_rate> values are from 300 to 57333.

`<max_rate>` The maximum receive rate. If set to 0, then the max rate will be determined by the modulation means selected in the `<carrier>` and `<automode>` settings. Zero is the default. Valid `<max_rate>` values are from 300 to 57333. Maximum receive rates for each valid `<carrier>` are as follows, in bits per second:

V92	28000—57333 / steps of 1333
V90	28000—57333 / steps of 1333
V34	2400—33600 / steps of 2400
V32B	4800—19200 / steps of 2400
V32	4800—14400 / steps of 2400
V22bis	2400
V22	2200
Bell212A	1200
V23C	1200
V.21	300
Bell103	300

Example: `+MS=V92,1,0,0`

This sets the modulation to be V.92 and the speed negotiations to use automode. This is the modem default.

Example: `+MS=V90,0,0,45333`

This will limit the maximum speed to 45,333 bps in V.90 mode.

+MS?

This command displays the current `+MS` command configuration.

+MS=?

This command displays all supported values for each `+MS` command parameter.

+PCW Command

This command configures how the modem responds to a call waiting signal. The modem's response is also determined by the current configuration of the +VCID caller ID command (See “+VCID Command” on page 79 for information on this command). You can also use the +PCW command to display the current call waiting configuration, and to display the supported <call waiting> parameter values.

+PCW=<call waiting>

Valid <call waiting> parameter values are as follows:

- 0 Enables the call waiting detector. When a call waiting signal is detected, the modem responds to it according to the +VCID caller ID command configuration. This is the default.
- 1 Enables the call waiting detector. When a call waiting signal is detected, the modem hangs up the current call and answers the waiting call.
- 2 Disables the call waiting detector.

Result Codes:

- OK <call_waiting> = 0,1,2
- ERROR Otherwise

+PCW?

This command displays the current call waiting configuration.

+PCW=?

This command displays the supported <call_waiting> parameter values.

+PIG Command

This command enables or disables PCM upstream. You can also use this command to display the current PCM upstream configuration, and to display the supported +PIG command parameter values.

+PIG=<value>

Valid <value> parameter values are as follows:

- 0 Enables PCM upstream.
- 1 Disables PCM upstream. This is the default.

Result Codes:

- OK <value> = 0,1
- ERROR Otherwise

+PIG?

This command displays the current +PIG command configuration.

+PIG=?

This command displays the supported +PIG <value> parameter values.

+PMH Command

This command enables or disables the Modem On Hold feature. You can also use this command to display the current Modem on Hold configuration, and to display the supported +PMH command parameter values.

+PMH=<value>

Valid <value> parameter values are as follows:

- | | |
|---|---|
| 0 | Enables Modem On Hold. This is the default. |
| 1 | Disables Modem on Hold. |

Result Codes:

- | | |
|-------|---------------|
| OK | <value> = 0,1 |
| ERROR | Otherwise |

+PMH?

This command displays the current +PMH command configuration.

+PMH=?

This command displays the supported +PMH <value> parameter values.

+VCID Command

This command enables or disables caller ID. You can also use this command to display the current caller ID configuration, and to display the supported +VCID command parameter values.

+VCID=<value>

Valid <value> parameter values are as follows:

- 0 Disables caller ID. This is the default.
- 1 Enables caller ID, with formatted presentation.
- 2 Enables caller ID, without formatting.

Result Codes:

- OK <value> = 0,1,2
- ERROR Otherwise

+VCID?

This command displays the current caller ID configuration.

+VCID=?

This command displays the supported +VCID <value> parameter values.

Chapter 5

S-Registers

S-Registers contain the settings that determine how several functions of the internal modem operate, such as choosing how many times to let the telephone ring before the modem answers and how long to wait before it hangs up if a connection fails. You can also customize certain AT commands, such as the escape sequence and command line termination.

The contents of the registers are changed automatically when you modify corresponding settings in your communication software. If you choose, however, you can display and edit the contents of the registers manually when the modem is in command mode. If the value is outside the acceptable range, an error is generated.

This chapter describes the settings for each S-Register.

S-Register values

- ❖ The format for displaying the value of an S-Register is:

ATSn?

where n is the register number. After you type in the register press Enter.

- ❖ The format for modifying the value of an S-Register is:

ATSn=r

where n is the register number, and r is the new register value. After you type in the register number and its new value press Enter.

S0 Auto answer ring number

This register determines the number of rings the modem will count before automatically answering a call. Enter 0 (zero) if you do not want the modem to automatically answer at all. When disabled, the modem can only answer with an ATA command.

Range: 0-255

Default: 0

Units: rings

S1 Ring counter

This register is read-only. The value of S1 is incremented with each ring. If no ring occurs over a six-second interval, the register is cleared.

Range: 0-225

Default: 0

Units: rings

S2 AT escape character (user-defined)

This register determines the ASCII value used for an escape sequence. The default is the + character. The escape sequence allows the modem to exit data mode and enter command mode when online. Values greater than 127 disable the escape sequence.

Range:	0-255
Default:	43
Units:	ASCII

S3 Command line termination character (user-defined)

This register determines the ASCII values as the carriage return character. This character is used to end command lines and result codes.

Range:	0-127, ASCII decimal
Default:	13 (carriage return)
Units:	ASCII

S4 Response formatting character (user-defined)

This register determines the ASCII value used as the line feed character. The modem uses a line feed character in command mode when it responds to the computer.

Range:	0-127, ASCII decimal
Default:	10 (line feed)
Units:	ASCII

S5 Command line editing character (user defined)

This register sets the character recognized as a backspace and pertains to asynchronous transmission only. The modem will not recognize the backspace character if it is set to an ASCII value greater than 32. This character can be used to edit a command line. When the echo command is enabled, the modem echoes back to the local DTE the backspace character, an ASCII space character, and a second backspace character. This means a total of three characters are transmitted each time the modem processes the backspace character.

Range:	0-127, ASCII decimal
Default:	8 (backspace)
Units:	ASCII

S6 Wait before dialing

This register sets the length of time, in seconds, that the modem must wait (pause) after going off-hook before dialing the first digit of the telephone number. The modem always pauses for a minimum of two seconds, even if the value of S6 is less than two seconds. The wait for dial tone call progress feature (W dial modifier in the dial string) will override the value in register S6.

Range:	2-65
Default:	3
Units:	seconds

S7 Connection completion time-out

This register sets the time, in seconds, that the modem must wait before hanging up because the carrier is not detected. The timer is started when the modem finishes dialing (originate), or goes off-hook (answer). In originate mode, the timer is reset upon detection of an answer tone if allowed by county restriction. The timer also specifies the wait for silence time for the @ dial modifier in seconds. S7 is not associated with the W dial modifier.

Range:	1-255
Default:	50
Units:	seconds

S8 Comma pause time

This register sets the time, in seconds, that the modem must pause when it encounters a comma (,) in the dial command string.

Range:	0-65
Default:	2
Units:	seconds

S11 DTMF dialing speed

This register determines the dialing speed.

Range:	50-150
Default:	95
Units:	.001 seconds

S12 Escape guard time

This register sets the value (in 20 ms increments) for the required pause after the escape sequence (default 1 second).

Range:	0-255
Default:	50
Units:	.02 seconds

S37 Dial line rate

S37 = 0 (default)	maximum modem speed
S37 = 1	reserved
S37 = 2	1200/75 bps
S37 = 3	300 bps
S37 = 4	reserved
S37 = 5	1200 bps
S37 = 6	2400 bps
S37 = 7	4800 bps
S37 = 8	7200 bps
S37 = 9	9600 bps
S37 = 10	12000 bps
S37 = 11	14400 bps
S37 = 12	16800 bps
S37 = 13	19200 bps
S37 = 14	21600 bps
S37 = 15	24000 bps
S37 = 16	26400 bps
S37 = 17	28800 bps
S37 = 18	31200 bps
S37 = 19	33600 bps

AT command set result codes

The following table shows the result codes:

Command Set Result Codes Table

<i>Result Code</i>	<i>Numeric</i>	<i>Description</i>
OK	0	Command executed
CONNECT	1	Modem connected to line
RING	2	A ring signal has been detected
NO CARRIER	3	Modem lost carrier signal, or does not detect carrier signal, or does not detect answer tone
ERROR	4	Invalid command
CONNECT 1200 EC*	5	Connection at 1200 bps
NO DIAL TONE	6	No dial tone detected
BUSY	7	Busy signal detected
CONNECT 2400 EC*	10	Connection at 2400 bps
CONNECT 4800 EC*	11	Connection at 4800 bps

* EC appears only when the Extended Result Codes configuration option is enabled. EC is replaced by one of the following symbols, depending upon the error control method used:

V.44 - V.44 data compression with V.42 error control

V.42bis - V.42 error control and V.42bis data compression

V.42 - V.42 error control only

MNP 5 - MNP class 4 error control and MNP class 5 data compression

MNP 4 - MNP class 4 error control only

NoEC - No error control protocol



S-Registers

AT command set result codes

Command Set Result Codes Table (Continued)

Result Code	Numeric	Description
CONNECT 9600 EC*	12	Connection at 9600 bps
CONNECT 14400 EC*	13	Connection at 14400 bps
CONNECT 19200 EC*	14	Connection at 19200 bps
CONNECT 7200 EC*	24	Connection at 7200 bps
CONNECT 12000 EC*	25	Connection at 12000 bps
CONNECT 16800 EC*	86	Connection at 16800 bps
CONNECT 300 EC*	40	Connection at 300 bps
CONNECT 21600 EC*	55	Connection at 21600 bps
CONNECT 24000 EC*	56	Connection at 24000 bps
CONNECT 26400 EC*	57	Connection at 26400 bps
CONNECT 28800 EC*	58	Connection at 28800 bps
CONNECT 31200 EC*	59	Connection at 31200 bps
CONNECT 33600 EC*	60	Connection at 33600 bps
CONNECT 38400 EC*	28	Connection at 38400 bps (DTE rate)

* EC appears only when the Extended Result Codes configuration option is enabled. EC is replaced by one of the following symbols, depending upon the error control method used:

V.44 - V.44 data compression with V.42 error control

V.42bis - V.42 error control and V.42bis data compression

V.42 - V.42 error control only

MNP 5 - MNP class 4 error control and MNP class 5 data compression

MNP 4 - MNP class 4 error control only

NoEC - No error control protocol

Command Set Result Codes Table (Continued)

<i>Result Code</i>	<i>Numeric</i>	<i>Description</i>
CONNECT 57600 EC*	18	Connection at 57600 bps (DTE rate)
CONNECT 115200 EC*	87	Connection at 115200 bps (DTE rate)
CONNECT 32000 EC*	70	Connection at 32000 bps
CONNECT 34000 EC*	71	Connection at 34000 bps
CONNECT 36000 EC*	72	Connection at 36000 bps
CONNECT 38000 EC*	73	Connection at 38000 bps
CONNECT 40000 EC*	74	Connection at 40000 bps
CONNECT 42000 EC*	75	Connection at 42000 bps
CONNECT 44000 EC*	76	Connection at 44000 bps
CONNECT 46000 EC*	77	Connection at 46000 bps
CONNECT 48000 EC*	78	Connection at 48000 bps
CONNECT 50000 EC*	79	Connection at 50000 bps
CONNECT 52000 EC*	80	Connection at 52000 bps
CONNECT 54000 EC*	81	Connection at 54000 bps

* EC appears only when the Extended Result Codes configuration option is enabled. EC is replaced by one of the following symbols, depending upon the error control method used:

V.44 - V.44 data compression with V.42 error control

V.42bis - V.42 error control and V.42bis data compression

V.42 - V.42 error control only

MNP 5 - MNP class 4 error control and MNP class 5 data compression

MNP 4 - MNP class 4 error control only

NoEC - No error control protocol

Command Set Result Codes Table (Continued)

<i>Result Code</i>	<i>Numeric</i>	<i>Description</i>
CONNECT 56000 EC*	82	Connection at 56000 bps
CONNECT 28000 EC*	100	Connection at 28000 bps
CONNECT 29333 EC*	101	Connection at 29333 bps
CONNECT 30666 EC*	102	Connection at 30666 bps
CONNECT 33333 EC*	103	Connection at 33333 bps
CONNECT 34666 EC*	104	Connection at 34666 bps
CONNECT 37333 EC*	105	Connection at 37333 bps
CONNECT 38666 EC*	106	Connection at 38666 bps
CONNECT 41333 EC*	107	Connection at 41333 bps
CONNECT 42666 EC*	108	Connection at 42666 bps
CONNECT 45333 EC*	109	Connection at 45333 bps
CONNECT 46666 EC*	110	Connection at 46666 bps
CONNECT 49333 EC*	111	Connection at 49333 bps
CONNECT 50666 EC*	112	Connection at 50666 bps
CONNECT 53333 EC*	113	Connection at 53333 bps

* EC appears only when the Extended Result Codes configuration option is enabled. EC is replaced by one of the following symbols, depending upon the error control method used:

V.44 - V.44 data compression with V.42 error control

V.42bis - V.42 error control and V.42bis data compression

V.42 - V.42 error control only

MNP 5 - MNP class 4 error control and MNP class 5 data compression

MNP 4 - MNP class 4 error control only

NoEC - No error control protocol

Command Set Result Codes Table (Continued)

<i>Result Code</i>	<i>Numeric</i>	<i>Description</i>
CONNECT 54666 EC*	114	Connection at 54666 bps

* EC appears only when the Extended Result Codes configuration option is enabled. EC is replaced by one of the following symbols, depending upon the error control method used:

V.44 - V.44 data compression with V.42 error control

V.42bis - V.42 error control and V.42bis data compression

V.42 - V.42 error control only

MNP 5 - MNP class 4 error control and MNP class 5 data compression

MNP 4 - MNP class 4 error control only

NoEC - No error control protocol

Chapter 6

Test Function

Normally, data communications are executed by connecting your computer and modem to those of a remote station with a communication line. If any errors or malfunctions are encountered, it is necessary to check whether the cause is in the local station, the remote station or the communication line.

Test description

This internal modem has a local/analog/loopback test function that identifies the cause of a malfunction. You can use the test to check errors in data communications or to check operation following modem connection.

When conducting a test, use the `&T` command to select test mode and control. For details on the `&T` command, refer to “[&Tn Self-test commands](#)” on page 68.

In this test, data is transmitted from the computer, is looped back (analog/loopback) within the modem from the transmitter to the receiver, then sent back to the computer. The test enables you to check whether the computer and modem are working properly.

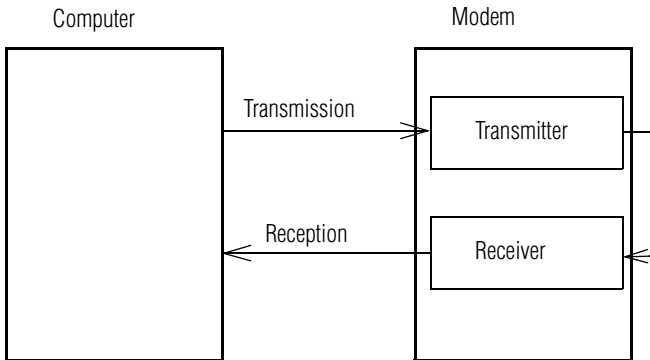

Local/analog/loopback test

Testing procedure

To conduct the loopback test:

- 1** Enter the following AT commands to set the modem to normal mode:
AT&FNO
Receive OK
- 2** Enter the following AT commands to select the local/analog/loopback test:
AT&T1
You are now in the online state.
- 3** Enter characters from the keyboard as desired.
The characters you enter should be displayed on the screen.

- 4 Enter the escape code as follows to return to the command state from the online state.

+++

Receive OK.

- 5 Enter the following AT commands to terminate the test:

AT&T0

Receive OK.

Chapter 7

MNP and V.42

The internal modem has built-in protocols MNP (Microcom Networking Protocol) Class 4 and V.42 for error correction and MNP class 5 and V.42bis for data compression.

Error-correction overview

Telephone line noise, or electrical interference, can cause errors in data communication. Noise is especially a problem at high speeds of 14,400 bps or greater.

The MNP and V.42 protocols were developed to ensure reliable data communications despite the high probability of error generation from line noise.

MNP error correction

MNP was developed by Microcom. MNP class 4 enables data correction of full-duplex communications and also provides asynchronous/synchronous conversion and data packet-size negotiation to increase throughput.

The protocol of both modems must be the same. Therefore, if the remote modem supports only class 3 or below, the protocol for the remote modem will be used. If the remote modem does not use MNP, the communication will be made at the speed of the remote modem.

V.42 error correction

The V.42 (ITU-T-Rec V.42) protocol is recommended by the ITU (International Telecommunications Union). V.42 specifies two kinds of protocols, LAP-M (Link Access Procedure for Modem) and MNP classes 2, 3, and 4. This protocol first tries to establish a link to the remote modem with LAP-M. If it is unsuccessful, it tries to connect with MNP. Although this modem uses class 4 correction, it can connect in class 5 to remote modems that support class 5.

Operation modes

The operation mode depends on whether an error-correction protocol is being used.

Normal mode

Errors are not corrected, even if communication speed is different between a personal computer and modem, or between modems, the buffers in the modem and the flow control function permit communication without changing communication speed.

Reliable mode

This mode is used with MNP or V.42 protocols to ensure error-free communication.

Commands (\Nn)

The following N modulation handshake commands are used to set the communication mode:

\N0, \N1	Remote modem unable to use MNP or V.42
\N2	Remote modem uses MNP
\N3	Uncertain if remote modem can use MNP or V.42
\N4	Remote modem uses V.42
\N5, \N7	Same as \N3

For details, refer to [“AT Commands” on page 51](#).

Flow control

In both normal mode and reliable mode, the buffers in the modem and its flow control function permit communication even if the speed is different between a personal computer and modem (serial port) or between modems (modem port).

If there is a speed difference between the serial port and modem port, the buffers in the modem will become full periodically. Therefore, the communication activity is controlled so that data transmission or reception is temporarily halted before the data exceeds buffer capacity, and transmission is resumed when the receiving buffers have room. This is the flow control function.

The modem card has two kinds of flow control:

- ❖ Serial port flow control
- ❖ Modem port flow control (only in reliable mode)

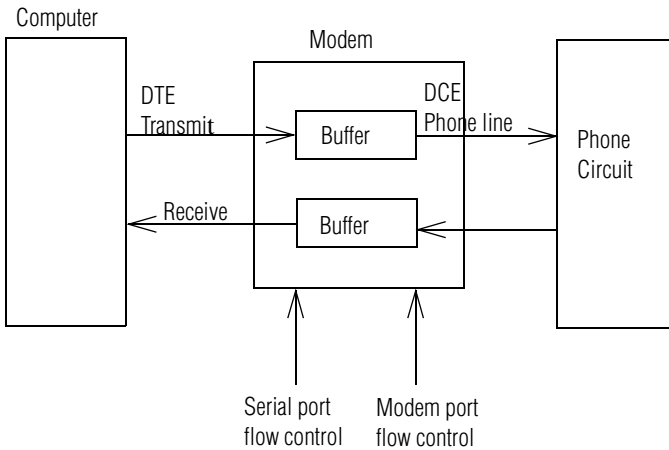

Flow control

Serial port flow control

Serial port data flow is controlled by the modem in its communication with a personal computer.

If the serial port speed is higher than the modem port speed, this control function sends a transmission halt request to the personal computer before the buffers in the modem are about to become full. When the buffers have room to receive data again, the transmission halt request is canceled and data transmission from the personal computer is resumed.

The internal modem provides three kinds of serial port flow control: one determined by software and two determined by hardware.

XON/XOFF flow control (software)

Flow control is performed by sending XON and XOFF control codes in the data stream. The XOFF code makes a transmission halt request. The XON code makes a transmission restart request.

Since these two codes, XON and XOFF, are used as flow control characters, binary data that includes these two codes cannot be transmitted or received.

CTS/RTS two-way flow control (hardware)

Flow control is performed by turning on and off the control lines CTS (clear to send) and RTS (request to send) between the modem and the computer. A transmission halt or restart request is made from the modem to the computer using the CTS signal.

A transmission halt or restart request is made from the personal computer to the modem using the RTS signal.

Commands (\Qn, &Kn)

Select flow control between the modem and computer (serial port) as follows:

- ❖ When CTS/RTS flow control is supported by the communication software
 \Q3, &K3 Communication in reliable mode or normal mode
- ❖ When XON/OFF flow control is only supported by the communication software
 \Q1, &K4 Communication in reliable mode or normal mode

For details, refer to [“AT Commands” on page 51](#).

Modem port flow control

Modem port flow control refers to flow control between the modems of the local station and remote station.

If data transmission from the modem under serial port flow control is interrupted because the computer cannot catch up with it, modem port flow control is applied to the remote modem so that transmitted data will not exceed buffer capacity. This flow control functions in normal mode only.

Data compression

Protocols MNP class 5 and V.42bis are included in the modem to compress data received from the computer. The receiving modem decompresses the received data and sends it to its own computer. This data compression function increases actual transmission speed up to twofold in communications using MNP5 or up to three or fourfold in communications using V.42bis. The compression ratio varies depending on the data. Actual speed will not always be raised close to the maximum compression ratio.

The V.44 compression standard provides more efficient data compression than V.42bis, significantly increasing the received throughput and reducing the download time for Web pages.

Commands (%Cn)

Select whether or not to compress data in communications by MNP class 5 or V.42bis as follows:

`%C1` Enables data compression

For details, refer to [“AT Commands” on page 51](#).

Appendix A

Specifications

This appendix summarizes the Toshiba internal modem's technical specifications.

Network control unit (NCU)

Type of NCU	AA
Type of line	General telephone line
Type of dialing	Pulse Tone
Control command	AT commands EIA-578 commands
Monitor function	Computer's speaker

Communication specifications

Communication system	Data:	Full duplex
	Fax:	Half duplex
Communication protocol	Data:	ITU-T-Rec V.21 / V.22 / V.22bis / V.32 / V.32bis / V.34 / 56K / V.90 / V.92 Bell 103/212A
	Fax:	ITU-T-Rec V.17 / V.29 / V.27ter (Former CCITT) / V.21 ch2
Communication speed	Data:	300 / 1200 / 2400 / 4800 / 7200 / 9600 / 12000 / 14400 /16800 / 19200 / 21600 / 24000 / 26400 / 28800 / 29333/30666/33333/34666/ 37333/38666/41333/42666/ 45333/46666/49333/50666/ 53333/54666 bps
	Fax:	2400 / 4800 / 7200 / 9600 / 12000 / 14400 bps

Transmitting level -10 dBm

Appendix B

Communication Conditions

Communication parameters

Select communication parameters from the table below.

<i>Start</i> (bit)	<i>Data length</i> (bit)	<i>Parity</i> (bit)	<i>Stop</i> (bit)
1	8	None	1 or more
1	7	0	1 or more
1	7	1	1 or more
1	7	Odd	1 or more
1	7	Even	1 or more
1	7	None	2

Telephone line types

This internal modem can be connected to 2-wire analog subscriber telephone lines (POTS lines) only.

Connectable lines (2-wire)

- ❖ Ordinary analog telephone lines with direct connection
- ❖ Corporate analog lines connected to a PBX
- ❖ Analog lines connected to a PBX, which, for example, provide dial tone when the handset is picked up and permit outgoing calls by dialing 9.

Unconnectable lines (4-wire)

- ❖ Business or home telephones that are connected to a key service unit or a PBX.
-



WARNING: These are digital lines that can damage the modem.

Lines that require pressing the (Line) button, for example “0,” before dialing.

Dial modes

There are two types of dial modes, pulse dial and tone dial. Generally, pulse dial lines are associated with rotary phones, but there may be cases where a push button phone is connected to a pulse dial line, so it is not possible to identify the type of line simply by looking at the phone. If you are not sure what type of line you are using, check an ordinary direct line by the following AT command, where n is the outside number:

```
ATDTn Enter
```

If you connect to the dialed number, the line is tone dial type. If you do not get a connection, it is pulse dial type.

The command ATDP will connect a pulse line.

Glossary

Acronyms

bps or *BPS*: Bits per Second

COM1: Communications Port 1 (serial port)

COM2: Communications Port 2 (serial port)

CPU: Central Processing Unit

FCC: Federal Communications Commission

FTP: File Transfer Protocol

GND: Ground

HDD: Hard Disk Drive

HTML: HyperText Markup Language

I/O: Input/Output

IRQ: Interrupt Request

ISA: Industry Standard Architecture

KB: Kilobyte

LAN: Local Area Network

LBA: Logical Block Addressing

LFB: Linear Frame Buffer

LPT1: Line Printer Port 1 (parallel port)

MB: Megabyte

MIPS: Millions of Instructions per Second

PBX: Private Branch Exchange

PCI: *Peripheral Component Interconnect*

PIO: Programmed Input/Output

RFI: Radio Frequency Interference

ROM: Read-Only Memory

RTC: Real-Time Clock

SIMM: Single Inline Memory Module

SPB: Synchronous Pipeline Burst (cache)

UART: Universal Asynchronous Receiver/Transmitter

URL: Universal Resource Locator

USB: Universal Serial Bus

VCR: Video Cassette Recorder

VESA: Video Electronics Standards Association

WSS: Windows Sound System

WWW: World Wide Web

A

Auto reliable mode: This mode connects to a remote station by MNP or V.42 if the remote modem accepts either of these protocols. Otherwise, it connects in normal mode.

address: A number that identifies a location in the computer's memory or on disk. It tells the computer where to find information such as the name of a file or a value for processing. A device may use a specific memory address to transfer information to and from the computer. See also *hexadecimal*.

alphanumeric: Consisting of numbers, symbols and letters you can type or print.

American National Standards Institute (ANSI) character set: The set of characters available in Microsoft® Windows® operating system (or other operating system). The character set includes letters, numbers, symbols and foreign language characters.

American Standard Code for Information Interchange (ASCII): A set of 256 binary codes that represent the most commonly used letters, numbers and symbols. See also *binary*.

animation: A technique of imparting motion to items, either drawings or inert objects.

application: A computer program that you use to perform tasks of a specific type. Applications include word processors, spreadsheets and database management systems. See also *program*.

asynchronous: A type of data transmission in which information is sent at variable time intervals. To indicate when a transmitted character begins and ends, it is preceded by a start bit and followed by an optional parity bit and one or two stop bits. See also *synchronous*.

B

baud (baud rate): The speed at which communications devices such as printers, terminals, and modems transmit information. Information travels as a series of electronic signals. The baud rate measures the rate of change in these signals. This is not necessarily the same as bits per second, although the two are related. It is named for Emil Baudot, a pioneer in printing telegraphy. See also *bits per second*.

Bell Standard: A series of communication procedures for telephone lines and other analog data transmission lines standardized by AT&T (American Telephone & Telegraph).

bit: The basic unit of information used by the computer, a bit may be either 1 or 0. While an individual bit cannot contain a significant amount of information, by combining bits into larger units, such as bytes (a group of eight connected bits), your computer can deal with huge blocks of data. See also *byte*.

bits per second (BPS): A way of measuring the speed at which information is passed between two devices. This is the basic measure used in modem communications. This is similar, but not identical, to the baud rate. See also *baud*.

buffer: An area of memory where information is held until it can be processed. Buffers are frequently used to compensate for the fact that some parts of the system are faster than others. For example, the computer sends information to a printer much faster than even the fastest printer can handle it. A print buffer stores printer information, enabling the computer to continue with other tasks. As the printer prints a page, it looks in the buffer to see what to do next.

bus: An electrical circuit that connects the microprocessor with other parts of the computer, such as the video adapter, disk drives and ports. It is the highway along which data flows from one device to another. See also *local bus*.

busy: A code indicating the number called is busy.

byte: A sequence of eight bits. A byte is the smallest addressable unit of data. Each byte represents an integer up to 255 in decimal (11111111 in binary, or FF in hexadecimal), or a character (such as a letter, numeral, or other symbol). See also *binary*, *bit*, *gigabyte*, *hexadecimal*, *kilobyte*, *megabyte*.

C

carrier: A modem converts the digital signals of the personal computer into analog signals to send them through the telephone line. The analog signals are “carrier,” because they transport the data. The analog frequency is determined by the individual communication specifications.

capacity: The amount of information that can be stored in a computer’s memory or on a storage device such as a hard disk, diskette, or CD-ROM. Capacity is usually measured in terms of kilobytes (KB), megabytes (MB) or gigabytes (GB). See also *gigabyte*, *kilobyte*, *megabyte*.

checksum: A method of checking data errors. Data is divided into blocks, and the total of the data in those blocks is checked to determine whether the data has been correctly transmitted. The total value is called checksum.

character: Any letter, number or symbol you can use on the computer. Some characters are non-printing characters, such as a paragraph break in a word-processing program. A character occupies one byte of computer storage.

Class 1: A standard for fax transmission. The Toshiba internal modem supports class 1.

choose: To use the mouse or keyboard to select a menu item, a button or an icon.

click: To press and release a mouse button. In the Windows® operating system, refers to the left mouse button, unless otherwise stated.

COM1 and COM2: Names that the operating system gives the computer's serial ports to distinguish between them.

commands: Instructions that tell the computer and its devices what to do. You can enter commands individually using the keyboard or pointing device or combine them into macros or programs.

Command state: A state in which data from the personal computer is received as commands to control the internal modem. Data from the personal computer will not be output to the telephone line.

Compression: The translation of data (video, audio, digital or a combination) to a more compact form for storage or transmission. In computer terms, files are compressed by removing repetitive and blank characters. Depending on the type of file, this can result in a size reduction of over 90%. Modems use compression to reduce the amount of time needed to send or receive a file.

Configuration: 1) The set of components in a computer system (such as memory, printers and disk drives). 2) How parts of the system are set up. For example, the configuration of the serial port includes the baud rate, parity, data bits and stop bits.

CTS signal: A Clear to Send signal is an RS-232C standard that indicates the modem is ready for transmission.

D

DAA: Data Access Arrangement is a circuit that isolates a device from phone lines.

data: Information that a computer can process. The word “data” is actually plural for “datum,” meaning a single piece of information.

data bits: A data communications parameter controlling the number of bits used to represent a character. If data bits = 7, the computer can generate 128 unique characters, if data bits = 8, the computer can generate 256 unique characters.

DCE (Data Communications Equipment or Data Circuit-terminating Equipment): A device that establishes, maintains and terminates a session on a network. It may also convert signals for transmission. It is typically the modem.

DCD signal: This signal tells the personal computer whether the modem is receiving the carrier from the opposite station

DTE (Data Terminating Equipment): A communications device that is the source or destination of signals on a network. It is typically a terminal or computer.

dial tone: The tone that is heard from the handset when it is picked up

dial mode: Dial mode covers pulse dial and tone dial. Pulse dial means turning the dial or pressing the buttons to send pulse signals to connect to the called party. Tone dial means pressing the button to send tone signals to connect the modem to the called party.

download: 1) To receive a file from another computer through a modem. 2) To transmit font data from the computer to a printer. See also *upload*.

DSP: A digital signal processor is a chip designed for real-time applications. DSP techniques are used in PC processors as well as media engines. For example, some high-end notebooks use a DSP chip to provide Sound Blaster emulation for the internal modem as well.

DSR signal: This signal tells the personal computer whether the modem is ready for communication.

DTR signal: This signal tells the modem whether the personal computer is ready for communication.

duplex: The method used to transmit data in both directions between two devices. Synonymous with full duplex. See also *half duplex*, *full duplex*.

E

echo: Displays keyboard entry on the computer terminal.

EIA: Electronic Industries Association is a manufacturers group that sets standards for data communications equipment.

error control: Detection of errors in data communication. Requests retransmission of data in which errors were found.

Error control: Detection of errors in data communication. Requests retransmission of data in which errors were found.

escape: 1) To cancel the task currently in progress. 2) A code (ASCII code 27, generated by the Esc key) telling the computer that what follows are commands, not data. Used with peripheral devices such as printers and modems.

Escape control: This code is used to return to the command state without disconnecting the line when the internal modem is online.

F

FIFO: First-In/First-Out means the first data that enters a buffer is the first to be retrieved.

Fallback: Reduction of a modem's speed. If the remote modem cannot communicate as fast as the local modem, the local modem will reduce its speed.

firmware: A set of instructions built into a chip to control its activities.

Flow control: Flow control ensures smooth data communication. If operating speed differs between the personal computer and modem or between your modem and a remote modem and if the remote station runs short of buffer capacity, a transmission halt request is sent from the receiver to the transmitter. When the receiver has enough buffer capacity to resume receiving data, a transmission restart request is sent. There are two ways of flow control, XON and OFF control codes and CTS and RTS signals.

frequency: The number of times a signal repeats an identical cycle within a certain time period.

full duplex: A type of data transmission in which data flows between two devices in both directions simultaneously. See also *half duplex*.

G

gigabyte (GB): A unit of data storage equal to 1,073,741,824 bytes (1024 x 1024 x 1024 bytes). See also *byte*.

Guard time: An interval before and after an escape sequence that prevents the modem from interpreting the escape sequence as data.

H

half duplex: A type of data transmission in which data flows between two devices in one direction at a time. See also *full duplex*.

handshake: After a telephone line is connected from one station to another, some signals are exchanged according to the ITU-T or Bell standard to confirm that the standard is the same between the calling and called stations prior to starting data communication between them. This exchange of signals is called handshake.

hangup: Hangup means disconnecting a telephone line to terminate communication

I

input: Information received by a computer from a storage device such as a disk, or an input device such as the keyboard.

input/output (I/O): Input and output are two of the three functions that computers perform (the other is processing). Input/Output describes the interrelated tasks of providing information to the computer and providing the results of processing to users. I/O devices include keyboards (input) and printers (output). A disk drive is both an input and an output device, since it can both provide information to the computer and receive information from the computer.

ITU-T Standard: A series of communication procedures for telephone lines and analog data transmission standardized by ITU (International Telecommunications Union, formerly CCITT).

K

keyboard: The device you use to type information into the computer. Each key on the keyboard is a switch that is activated when you press it. The switch sends a specific code, representing the character printed on the key, to the processor.

kilobyte (KB): A unit of data storage equal to 1024 bytes. Its abbreviations (K and KB) are taken from the Greek word *kilo*, meaning 1000, although the abbreviation refers to 1024, or 2 raised to the 10th power. See also *byte*.

M

megabyte (MB): A unit of data storage equal to 1024 KB. From the Greek work *mega* for million, one megabyte is actually 1,048,576 bytes (1024 x 1024 bytes). See also *byte*.

MIPS (Millions of Instructions Per Second): A computer processor's performance.

modem: A device for transmitting computer information over telephone lines. A modem converts (modulates) digital information for transmission and also converts (demodulates) information it receives back to digital format. Many modems also interpret and execute commands received from the computer.

modem port: The port to send and receive data to and from the modem of a remote station.

MNP: A protocol developed by Microcom[®], a modem manufacturer in the United States, which with an error correcting function built into the modem itself corrects errors in the modem.

N

Normal mode: Error correction is not made by MNP or V.42, but even if serial port speed is different from modem port speed, the buffers in the modem and its flow control function permit communication without changing their speeds.

O

on line: A functional state in which a device is ready to receive or transmit information.

online: Available through the computer. Online may refer to information on the hard disk, such as online documentation or online help, or a connection, through a modem, to another computer or the Internet.

On hook/Off hook: On hook means the “handset is on the telephone,” and off hook means it is off. The line is disconnected from the internal modem when the handset is on hook, and connected to the internal modem when it is off hook.

P

parity: A method in serial communications of making sure that the information received is the same as the information that was sent. It consists of adding an error detection bit to a group of data bits, making the sum of the bits either odd or even. When you’re using a modem to connect to another computer, you can set parity to none, odd or even. In general, you should set parity to none, unless you’re requested to do otherwise.

Private Branch Exchange (PBX): An automatic digital telephone switching system that enables users within an organization to place calls to each other without going through the public telephone network. Users can also place calls to outside numbers. ***Do not connect the Toshiba internal modem to a digital PBX line, or the modem may be damaged.***

protocol: A set of rules and conventions that makes it possible to transfer information between computers. If you’re transmitting a file, both modems must use the same protocol—just as two people talking on the telephone must speak the same language to communicate effectively. Examples of modem protocols are V.34, V.42, V.90 and V.92.

Public line: A line served by a telephone company to be connected to an opposite station via the exchange.

Pulse dialing: A dialing method that uses pulses instead of tones to generate a telephone number. Generally associated with rotary dial phones, although some push-button phones can be used on pulse lines.

R

Reliable mode: Reliable mode is for error-free communication by MNP or V.42.

Result code: This code returns to the computer the results of executing a command sent from it to the internal modem in characters or numeric values.

RJ11: A modular telephone connector used on most telephone networks and direct-connect modems.

RTS signal: A Request to Send signal is an RS-232C standard that indicates the modem is ready to receive data.

RS-232-C: The standard defining control, data and status signals for cables allowing asynchronous communication with computers, printers, and other peripheral devices.

S

serial: The handling of data bits one after the other.

serial communications: A communications technique that uses as few as two interconnecting wires to send bits one after another.

serial interface: An interface between systems or system components in which information is transmitted sequentially, one bit at a time. The transmitted bits are reassembled at the receiving component. A modem uses a serial interface.

serial port: A communications port (COM1 or COM2) to which you can connect a serial device, such as a modem, a mouse or a serial printer.

stop bit: In asynchronous serial communications, one or more bits indicating the end of a block of characters.

S-Register: The S-Register stores the parameters for various commands and modem operations.

synchronous: Having a constant time interval between successive bits, characters or events. Synchronous data transmission requires both the sending and receiving devices to use special synchronizing characters to correct variations in timing between the devices. See also *asynchronous*.

T

Test function: When normal communication is not possible, this function checks the modem, personal computer, and telephone lines to determine if they are normal.

Tone dialing: A dialing method that uses tones instead of pulses to generate a telephone number. Generally associated with push-button phones, although some push-button phones can be connected to pulse lines.

U

upload: To send a file to another computer through a modem. See also *download*.

UART: Universal Asynchronous Receiver Transmitter is the circuit interface between the modem and computer. It receives serial bit data from the modem and converts it into bytes for the computer; and it converts byte data from the computer into bit data for serial communication.

X

XON/XOFF flow control: A protocol used by devices receiving data. It uses two signals: transfer ON and transfer OFF. The signals are controlled by software.

Index

Numerics

56K technology 16

A

analog/loopback test 92

answering a call 20

AT command 52

AT command set

result codes 87

AT commands

answer command 52

Call Waiting 77

Caller ID enable/disable 79

communication standard setting

52

data carrier detect 65

data compression control 72

data terminal ready (DTR) 66

dial a telephone number 53

dial tone detect 64

display result codes 62

echo command 54

error control mode selection 70

escape sequence 52

extended result codes 64

format 51

guard tone control 67

hook control 55

load factory settings 66

local flow control selection 67, 71

Modem On Hold 79

monitor speaker mode 60

monitor speaker volume 60

MS command 74

N modulation handshake 61

PCM Upstream 78

protocol result code 71

repeat last command string 52

request ID information 55

result code control 62

result code option 63

result code selection 63

return to online data mode 61

select pulse dial make/break ratio
68

select pulse dialing 62

- select stored profile for hardware reset 69
- select tone dialing 62
- self-test commands 68
- store current configuration 69
- store telephone number 70
- V.44 data compression 73
- V.90 enable/disable 72
- view active configuration and stored profile 69

C

- call
 - receiving 49
 - terminating 49
- call cancelled error message 22
- call history 25
- Call Waiting
 - AT command 77
 - configuring 25
- Caller ID
 - AT command 79
 - configuring 25
- Clear To Send 50
- communication standard setting 52
- communications
 - dial mode types 104
 - facsimiles 50
 - handshake commands 97
 - modes 97
 - parameters 103
 - protocols supported 17
 - specifications 101
 - telephone line types 103
- configuring Modem On Hold 25
- connecting internal modem 44, 45
- connecting to a telephone line 47
- connection procedures 44
- CTS/RTS 50

D

- data carrier detect 65
- data compression 100
- data compression control 72
- data terminal ready (DTR) 66
- default settings 31
- diagnostics 31
- dial a telephone number 53
- dial tone detect 64
- disconnecting the internal modem 46
- display result codes 62

E

- echo command 54
- error control mode selection 70
- error messages
 - call cancelled 22
- escape sequence 52
- extended result codes 64

F

- Fast Connect 14
- fax communication 50
- flow control 97
 - computer to modem 97
 - modem port 97, 100
 - modem to modem 97
 - serial port 97
 - computer to modem 98
 - software 98
 - two-way 99

G

- guard tone control 67

H

- handshake 61
- handshake commands 97
- hardware setup 31

hook control 55

I

icons

definitions 14

internal modem

communications protocols 17

connecting 45

connection procedures 44

disconnecting 46

L

load factory settings 66

local flow control selection 67, 71

loopback test 93

M

MNP protocol 95

modem

connecting internal 44

flow control function 97

modem port 97

serial port 97

maximum connection speed 74

protocol settings 74

protocols 16

Modem On Hold 14

answering a call 20

application 19

AT command 79

autorun 28

configuring 25

icon 28

placing a call 22

timer 21

using 20

version 29

viewing call history 25

MS command 74

N

N modulation handshake 61

O

operation modes 96

normal 96

reliable 96

P

PCM Upstream 14, 78

placing a call 22

protocol result code 71

protocols

MNP 95

V.42 96

R

receiving a call 49

repeat last command string 52

request ID information 55

Request To Send 50

result code control 62

result code option 63

result code selection 63

return to online data mode 61

S

select pulse dial make/break ratio 68

select pulse dialing 62

select tone dialing 62

self-test commands 68

serial port

flow control 98

set protocol and connection speed

parameters 74

speaker on/off 60

speaker volume 60

specifications

Toshiba's internal modem 101

S-register values

- AT escape character 83
- Comma pause time 85
- Command line editing character 84
- Command line termination character 83
- Connection completion time-out 85
- Dial line rate 86
- DTMF dialing speed 85
- Escape guard time 86
- Response formatting character 83
- Wait before dialing 84

store current configuration 69

store telephone number 70

T

telephone line

- connecting to 47
- direct access line 47
- extension line 48

terminating a call 49

test

- description 92
- function 92
- methods 92

test function

- loopback test 93

transfer on/transfer off 50

V

V.42 protocol 96

V.44 data compression 15, 73

V.90 enable/disable 72

V.92

- connection requirements 15
- features 14
- verifying connection 38

view active configuration and stored profile 69

X

XON/XOFF control 50