



Operation/Reference Guide

NOVARA ControlPads & KeyPads

NOVARA 1000 Series ControlPads

NOVARA AxLink KeyPads

NOVARA KeyPads

AMX NOVARA DCS1000 Software

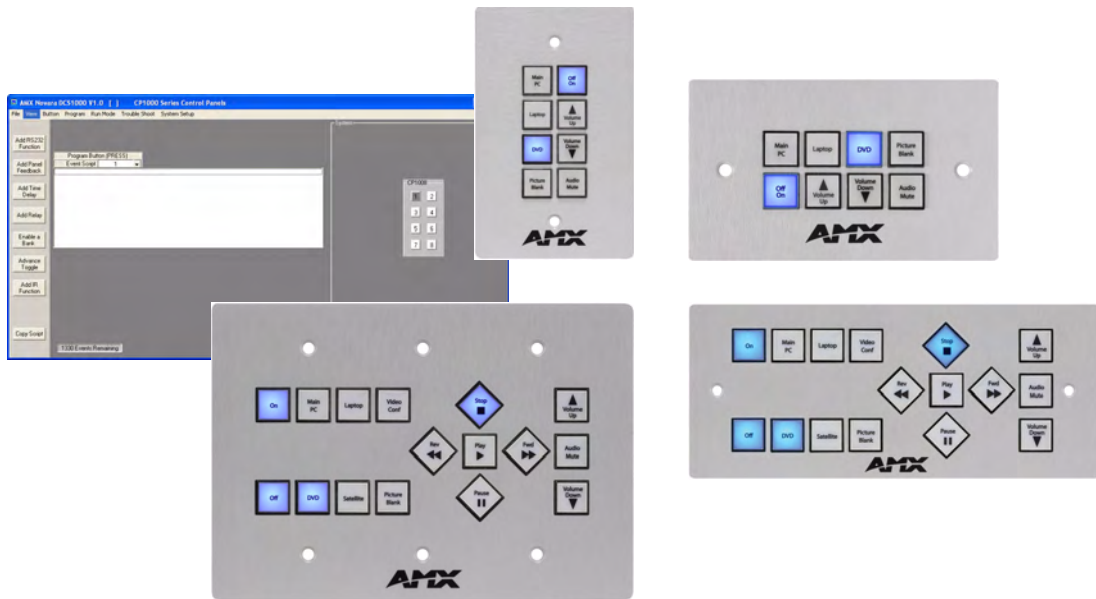

AMX Limited Warranty and Disclaimer

This Limited Warranty and Disclaimer extends only to products purchased directly from AMX or an AMX Authorized Partner which include AMX Dealers, Distributors, VIP's or other AMX authorized entity.

AMX warrants its products to be free of defects in material and workmanship under normal use for three (3) years from the date of purchase, with the following exceptions:

- Electroluminescent and LCD Control Panels are warranted for three (3) years, except for the display and touch overlay components are warranted for a period of one (1) year.
- Disk drive mechanisms, pan/tilt heads, power supplies, and MX Series products are warranted for a period of one (1) year.
- AMX lighting products are guaranteed to switch on and off any load that is properly connected to our lighting products, as long as the AMX lighting products are under warranty. AMX also guarantees the control of dimmable loads that are properly connected to our lighting products. The dimming performance or quality there of is not guaranteed, impart due to the random combinations of dimmers, lamps and ballasts or transformers.
- AMX software is warranted for a period of ninety (90) days.
- Batteries and incandescent lamps are not covered under the warranty.
- AMX AutoPatch Epica, Modula, Modula Series4, Modula CatPro Series and 8Y-3000 product models will be free of defects in materials and manufacture at the time of sale and will remain in good working order for a period of three (3) years following the date of the original sales invoice from AMX. The three-year warranty period will be extended to the life of the product (Limited Lifetime Warranty) if the warranty card is filled out by the dealer and/or end user and returned to AMX so that AMX receives it within thirty (30) days of the installation of equipment but no later than six (6) months from original AMX sales invoice date. The life of the product extends until five (5) years after AMX ceases manufacturing the product model. The Limited Lifetime Warranty applies to products in their original installation only. If a product is moved to a different installation, the Limited Lifetime Warranty will no longer apply, and the product warranty will instead be the three (3) year Limited Warranty.

All products returned to AMX require a Return Material Authorization (RMA) number. The RMA number is obtained from the AMX RMA Department. The RMA number must be clearly marked on the outside of each box. The RMA is valid for a 30-day period. After the 30-day period the RMA will be cancelled. Any shipments received not consistent with the RMA, or after the RMA is cancelled, will be refused. AMX is not responsible for products returned without a valid RMA number.

AMX is not liable for any damages caused by its products or for the failure of its products to perform. This includes any lost profits, lost savings, incidental damages, or consequential damages. AMX is not liable for any claim made by a third party or by an AMX Authorized Partner for a third party.

This Limited Warranty does not apply to (a) any AMX product that has been modified, altered or repaired by an unauthorized agent or improperly transported, stored, installed, used, or maintained; (b) damage caused by acts of nature, including flood, erosion, or earthquake; (c) damage caused by a sustained low or high voltage situation or by a low or high voltage disturbance, including brownouts, sags, spikes, or power outages; or (d) damage caused by war, vandalism, theft, depletion, or obsolescence.

This limitation of liability applies whether damages are sought, or a claim is made, under this warranty or as a tort claim (including negligence and strict product liability), a contract claim, or any other claim. This limitation of liability cannot be waived or amended by any person. This limitation of liability will be effective even if AMX or an authorized representative of AMX has been advised of the possibility of any such damages. This limitation of liability, however, will not apply to claims for personal injury.

Some states do not allow a limitation of how long an implied warranty last. Some states do not allow the limitation or exclusion of incidental or consequential damages for consumer products. In such states, the limitation or exclusion of the Limited Warranty may not apply. This Limited Warranty gives the owner specific legal rights. The owner may also have other rights that vary from state to state. The owner is advised to consult applicable state laws for full determination of rights.

EXCEPT AS EXPRESSLY SET FORTH IN THIS WARRANTY, AMX MAKES NO OTHER WARRANTIES, EXPRESSED OR IMPLIED, INCLUDING ANY IMPLIED WARRANTIES OF MERCHANTABILITY OR FITNESS FOR A PARTICULAR PURPOSE. AMX EXPRESSLY DISCLAIMS ALL WARRANTIES NOT STATED IN THIS LIMITED WARRANTY. ANY IMPLIED WARRANTIES THAT MAY BE IMPOSED BY LAW ARE LIMITED TO THE TERMS OF THIS LIMITED WARRANTY. EXCEPT AS OTHERWISE LIMITED BY APPLICABLE LAW, AMX RESERVES THE RIGHT TO MODIFY OR DISCONTINUE DESIGNS, SPECIFICATIONS, WARRANTIES, PRICES, AND POLICIES WITHOUT NOTICE.

Table of Contents

NOVARA ControlPads	1
Overview	1
Product Specifications	2
Mounting Specifications - 8-Button ControlPads	4
CP-1008-US	4
Minimum Internal Clearance for 1-Gang US Conduit Boxes	4
CP-1008-UK	5
CP-1008-EU	6
Mounting Specifications - 16-Button ControlPads	7
CP-1016-US	7
Minimum Internal Clearance for 3-Gang US Conduit Boxes	7
CP-1016-UK/EU	8
Wiring and Connections.....	9
NOVARA ControlPads - Rear Panel Connectors.....	9
Relay 1 / Relay 2 Connectors.....	10
RS232 Out Connector	11
IR Out Connector	11
Input Connector	12
Power Supply Connector.....	12
USB Program Port	13
Button Layout	13
NOVARA AxLink KeyPads	15
Overview	15
Product Specifications	16
Mounting Specifications - 8-Button KeyPads	17
SP-08-AX-US.....	17
Minimum Internal Clearance for 1-Gang US Conduit Boxes	17
SP-08-AX-UK	18
SP-08-AX-EU	19
Mounting Specifications - 16-Button KeyPads	20
SP-16-AX-TR-US	20
Minimum Internal Clearance for 3-Gang US Conduit Boxes	20
SP-16-AX-TR-UK	21
Wiring and Connections.....	22
ControlPads - Rear Panel Connectors.....	22
RS-232 Connections	22
Power Supply Connector.....	22

Daisy-Chaining KeyPads (RS232)	23
Daisy-Chaining KeyPads (AxLink).....	23
Button Layout	24
Setting DIP Switches to Assign Alternate Button Numbering	24
Alternate Button Numbering: 8-Button KeyPads	24
Alternate Button Numbering: 16-Button KeyPads	25
Setting the AxLink Address DIP Switch	25
Setting the AxLink Device Address	25
NOVARA KeyPads	27
Overview	27
Product Specifications	28
Mounting Specifications - 8-Button KeyPads	29
SP-08-US	29
Minimum Internal Clearance for 1-Gang US Conduit Boxes	29
SP-08-UK	30
SP-08-EU	31
Mounting Specifications - 16-Button KeyPads	32
SP-16-US	32
Minimum Internal Clearance for 3-Gang US Conduit Boxes	32
SP-16-UK/EU	33
Wiring and Connections.....	34
ControlPads - Rear Panel Connectors.....	34
RS-232 Connections	34
Power Supply Connector.....	34
Daisy-Chaining KeyPads.....	35
Button Layout	35
Setting DIP Switches to Assign Alternate Button Numbering	36
Alternate Button Numbering: 8-Button KeyPads	36
Alternate Button Numbering: 16-Button KeyPads	36
Button Labelling	37
Overview	37
Installing Acetate Button Labels and Key Caps - READ THIS FIRST!.....	37
Removing/Replacing Button Labels	39
Disassembling the NOVARA Keypad	39
Replacing Key Caps / Button Labels.....	40
Re-Assembling the Keypad	41
Exploded View - 8-Button US Version	41
Exploded View - 8-Button UK/EU Version	42
Exploded View - 16-Button US/UK/EU Version	42

AMX NOVARA DCS1000 Device Configuration Software	43
Installing the AMX NOVARA DCS1000 Application.....	43
Launching AMX NOVARA DSC1000	44
Overview	45
Downloading the Program to the ControlPad	46
Specifying Button Feedback	46
Adding Feedback to a Button Script (Example)	46
Button Feedback - On / All Buttons Off	48
Button Feedback - On / Group Off	48
Testing Grouped Feedback.....	49
Delay Time	49
Adding Delay Time to a Script (Example).....	49
RS232 Functions	50
Opening RS232 Library Files	50
Adding a RS232 Command to an Event	51
Viewing RS232 Libraries.....	52
Adding a New Device To a RS232 Library.....	53
Adding a New RS232 Function to a Device.....	53
Copying RS232 Functions From an Existing Device to a New Device	54
Testing RS232 Functions	54
Creating a Test Serial Cable	54
Verifying RS232 Commands	54
IR Commands	55
Opening IR Library Files	55
Adding an IR Command to an Event	55
AMX IR Libraries	56
Loading an Existing IR Library	56
Creating New IR Libraries	57
Importing AMX IR Library (IRL) Files	57
Downloading IR Files From www.AMX.com.....	58
Creating New IR Libraries Using an IRIS IR/Serial Data Capture Device.....	61
Importing IR HEX File Codes.....	62
Using IR HEX Codes To Create New IR Libraries.....	63
Testing IR Functions	64
Input Port Scripts.....	65
Changing a Button Action.....	65
Press.....	65
Release.....	65
Toggle.....	65
Bank Assign.....	66

Bank Enable.....	67
Using Bank Assign to Control Two Projectors - Example	70
Advance Toggle	73
Copy and Paste.....	74
Start Up	74
Time Out.....	75
File Menu	76
Run Mode	76
Downloading the Program.....	76
Downloading To an Auto-running panel.....	77
Adding a Relay Unit	77
NOVARA RS232 Codes	79
RS232 Protocol	79
RS232 Press/Release Codes	79
RS232 Function Codes	80

NOVARA ControlPads

Overview

NOVARA ControlPads offer the ability to easily control presentation devices such as projectors, projection screens, video displays and other audio visual equipment as well as a variety of serial or IR-controllable devices like lighting and window treatments.

NOVARA ControlPads are designed to be easily configurable allowing control of equipment by RS232 commands and IR.

The ControlPads are configured using the *AMX NOVARA DCS1000 Device Configuration Software* software application, available for download from www.amx.com. Refer to the *AMX NOVARA DCS1000 Device Configuration Software* section on page 43 for details.

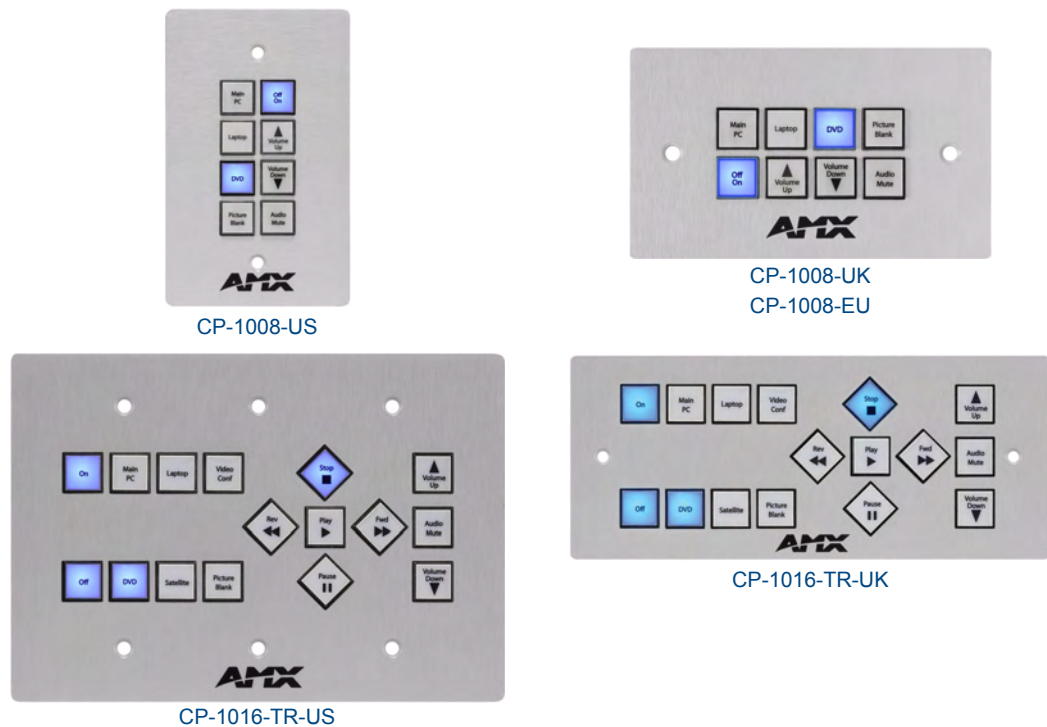

FIG. 1 NOVARA 1000 Series ControlPads

The NOVARA 1000 Series of ControlPads include:

NOVARA 1000 Series ControlPads		
Name	Description	Colors/FG#s
CP-1008-US 8-Button ControlPad	Fits 1-gang US conduit boxes. <i>Refer to the Minimum Internal Clearance for 1-Gang US Conduit Boxes section on page 4 for details.</i>	<ul style="list-style-type: none"> White: FG1301-08-SW Black: FG1301-08-SB Brushed Aluminum: FG1301-08-SA
CP-1008-UK 8-Button ControlPad	Fits standard 2-gang UK conduit box sizes	<ul style="list-style-type: none"> White: FG1301-08-KW Black: FG1301-08-KB Brushed Aluminum: FG1301-08-KA
CP-1008-EU 8-Button ControlPad	Fits standard 2-gang European conduit box sizes	<ul style="list-style-type: none"> White: FG1301-08-EW Black: FG1301-08-EB Brushed Aluminum: FG1301-08-EA

NOVARA 1000 Series ControlPads (Cont.)		
CP-1016-TR-US 16-Button ControlPad	Fits NEC-Compliant 3-gang US conduit boxes. <i>Refer to the Minimum Internal Clearance for 3-Gang US Conduit Boxes section on page 7 for details.</i>	<ul style="list-style-type: none"> • White: FG1301-16-SW • Black: FG1301-16-SB • Brushed Aluminum: FG1301-16-SA
CP-1016-TR-UK 16-Button ControlPad	Fits standard 3-gang UK conduit box sizes.	<ul style="list-style-type: none"> • White: FG1301-16-KW • Black: FG1301-16-KB • Brushed Aluminum: FG1301-16-KA

Product Specifications

NOVARA 1000 Series ControlPads	
Power Requirements:	<ul style="list-style-type: none"> • Min: 250mA @ 12 VDC • Max: 420mA @ 12 VDC (with all buttons illuminated to max brightness and 2 external devices attached to the RELAY 1/2 Ports in the ON state).
Button Layout:	<ul style="list-style-type: none"> • 8 or 16 buttons • Blue, backlit buttons with programmable feedback
Max number of events per ControlPad:	1330
Rear Panel Connectors:	<ul style="list-style-type: none"> • RELAY 2 - Output port: can be used to control external devices (i.e. the AMX UPC-20+ Universal Power/Motor Controller - not included). <i>This is a current sink (not a voltage driver).</i> Max current sink - 100mA @12V. • SHARED 12V - Common +12V. • RELAY 1 - Output port: can be used to control external devices (i.e. the AMX UPC-20+ Universal Power/Motor Controller- not included). <i>This is a current sink (not a voltage driver).</i> Max current sink - 100mA @12V. • RS232 OUT - RS232 output port: supports one-way RS-232 control (TX only). • GND - Ground • IR OUT - Connects to an IR Emitter to support one-way IR control (TX only). • GND - Ground • INPUT - Input detection: connects to an external switch (such as a PIR switch), for detecting a High to Low or Low to High state. • -VE - Connects to the included 12V power supply (-). • +VE - Connects to the included 12V power supply (+).
Top Panel Connector:	1 USB device configuration port.
Supported Baud Rates:	1200 - 115200
Dimensions (HWD):	<ul style="list-style-type: none"> • CP-1008-US: 4.685" x 2.913" x 1.059" (11.899 cm x 7.399 cm x 2.689 cm) • CP-1008-UK: 3.386" x 5.787" x 1.059" (8.600 cm x 14.698 cm x 2.689 cm) • CP-1008-EU: 3.150" x 5.984" x 1.059" (8.001 cm x 15.199 cm x 2.689 cm) • CP-1016-TR-US: 4.724" x 6.693" x 1.059" (11.998 cm x 17.000 cm x 2.689 cm) • CP-1016-TR-UK: 4.331" x 9.055" x 1.059" (11.000 cm x 22.999 cm x 2.689 cm) • CP-1016-TR-EU: 4.331" x 9.055" x 1.059" (11.000 cm x 22.999 cm x 2.689 cm)
Weight:	<ul style="list-style-type: none"> • CP-1008-US: 0.30 lbs (136.08 g) • CP-1008-UK: 0.35 lbs (158.76 g) • CP-1008-EU: 0.35 lbs (158.76 g) • CP-1016-TR-US: 0.55 lbs (249.48 g) • CP-1016-TR-UK: 0.65 lbs (294.84 g) • CP-1016-TR-EU: 0.65 lbs (294.84 g)

NOVARA 1000 Series ControlPads (Cont.)	
Included Accessories:	<ul style="list-style-type: none">• Button Kit - includes acetate sheet with 50 pre-cut button label inserts and clear plastic Key Caps• w/ 8 Key Caps: MA1301-01• w/ 16 Key Caps: MA1301-02• Installation Kit - includes 8-pin captive wire connector and mounting screws (KA1301-01).• External 12V Power Supply (57-1301-SA)
Other AMX Equipment:	<ul style="list-style-type: none">• 8 Button Kit (MA1301-01)• 16 Button Kit (MA1301-02)
Certifications:	<ul style="list-style-type: none">• IEC 60950• FCC/CE• RoHS compliant

Mounting Specifications - 8-Button ControlPads



NOTE

US version NOVARA ControlPads are designed to fit in NEC-Compliant wall boxes only. These devices will not fit properly in non-NEC-Compliant wall boxes.

CP-1008-US

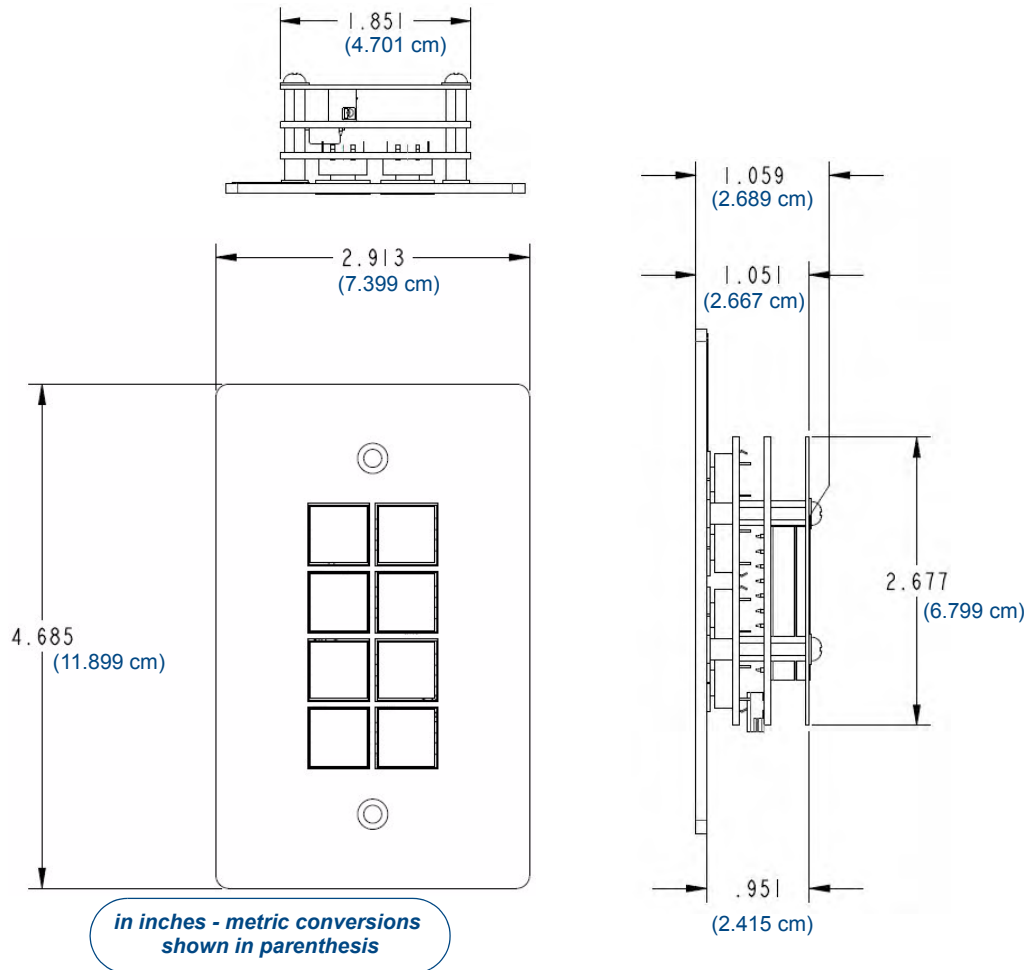

FIG. 2 Mounting Specifications - CP-1008-US

Minimum Internal Clearance for 1-Gang US Conduit Boxes

To ensure a proper fit with sufficient clearance, US-style NOVARA ControlPads require the following minimum internal dimensions within the conduit box:

US 1-Gang (HWD): 2.9" x 2.1" x 1.6" (7.36 cm x 5.33 cm x 4.06 cm)

These minimum interior dimensions will maintain a minimum .050" (1.27 cm)

CP-1008-UK

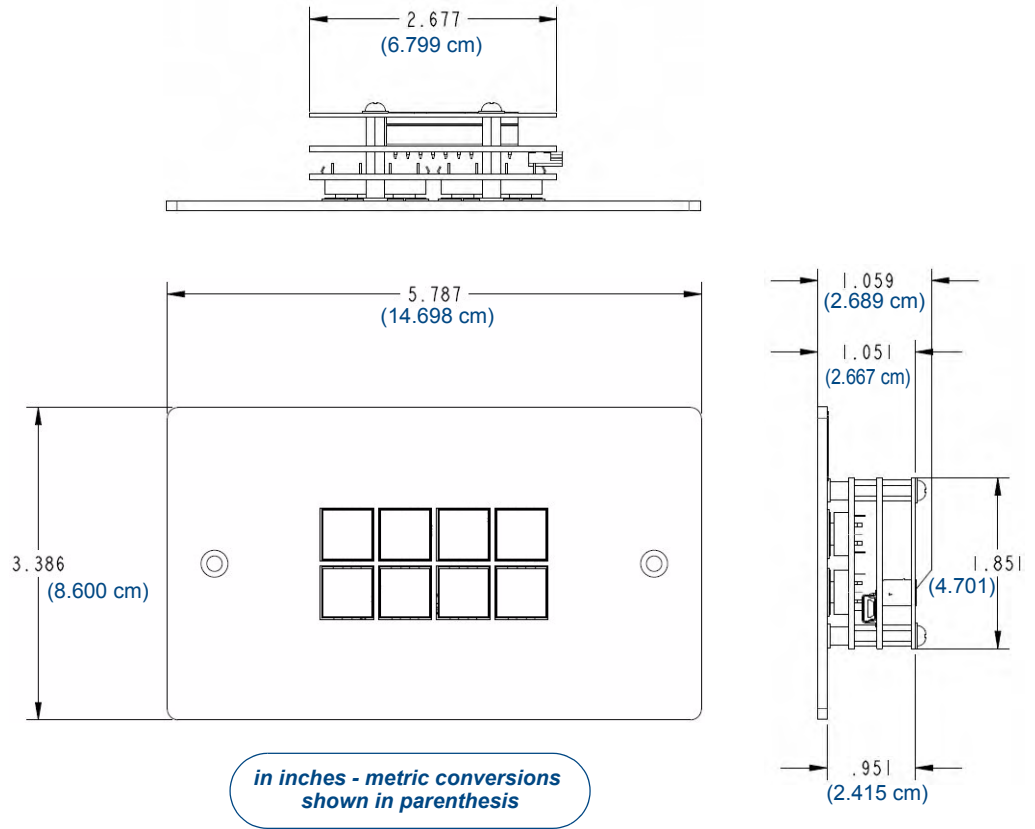

FIG. 3 Mounting Specifications - CP-1008-UK

CP-1008-EU

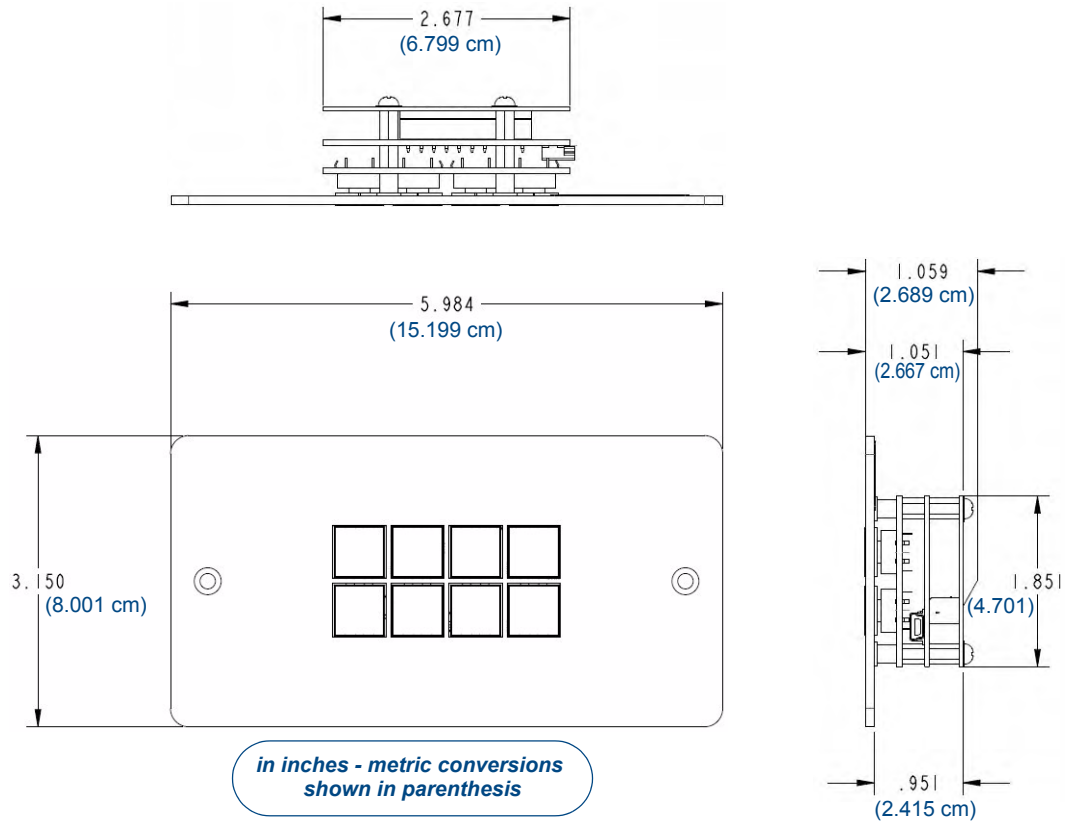

FIG. 4 Mounting Specifications - CP-1008-EU

Mounting Specifications - 16-Button ControlPads



NOTE

US version NOVARA ControlPads are designed to fit in NEC-Compliant wall boxes only. These devices will not fit properly in non-NEC-Compliant wall boxes.

CP-1016-US

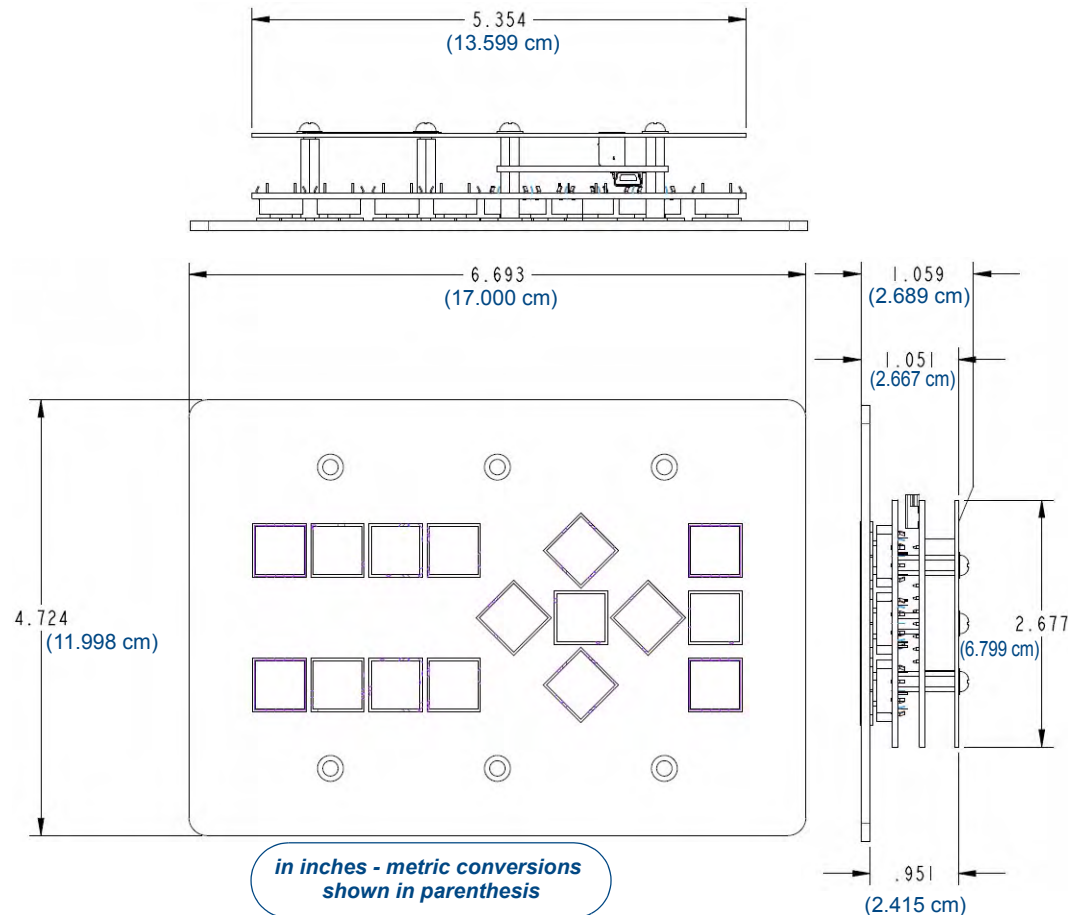

FIG. 5 Mounting Specifications - CP-1016-US

Minimum Internal Clearance for 3-Gang US Conduit Boxes

To ensure a proper fit with sufficient clearance, US-style NOVARA ControlPads require the following minimum internal dimensions within the conduit box:

US 3-Gang (HWD): 5.6" x 2.9" x 1.6" (14.22 cm x 5.33 cm x 4.06 cm)

These minimum interior dimensions will maintain a minimum .050" (1.27 cm)

CP-1016-UK/EU

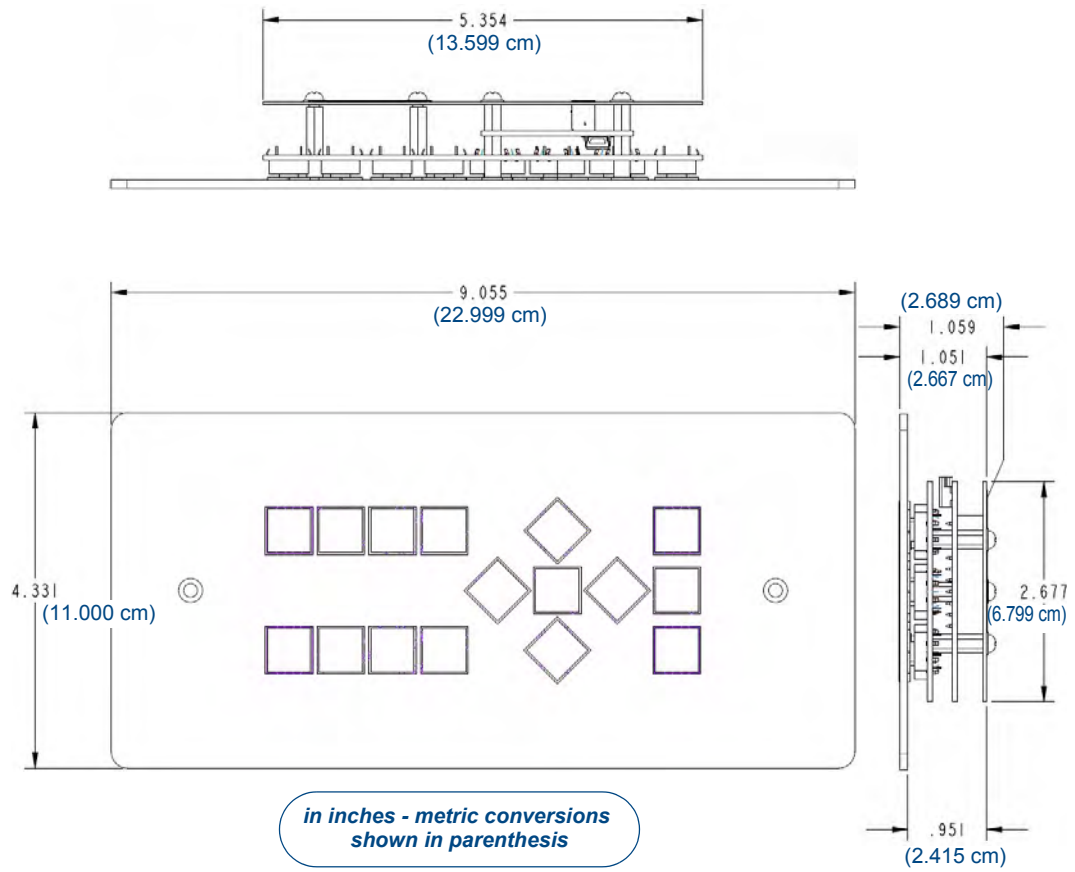

FIG. 6 Mounting Specifications - CP-1016-UK/CP-1016-EU

Wiring and Connections

NOVARA ControlPads - Rear Panel Connectors

FIG. 7 shows the rear panel connectors of the NOVARA ControlPads, and indicates a typical installation:

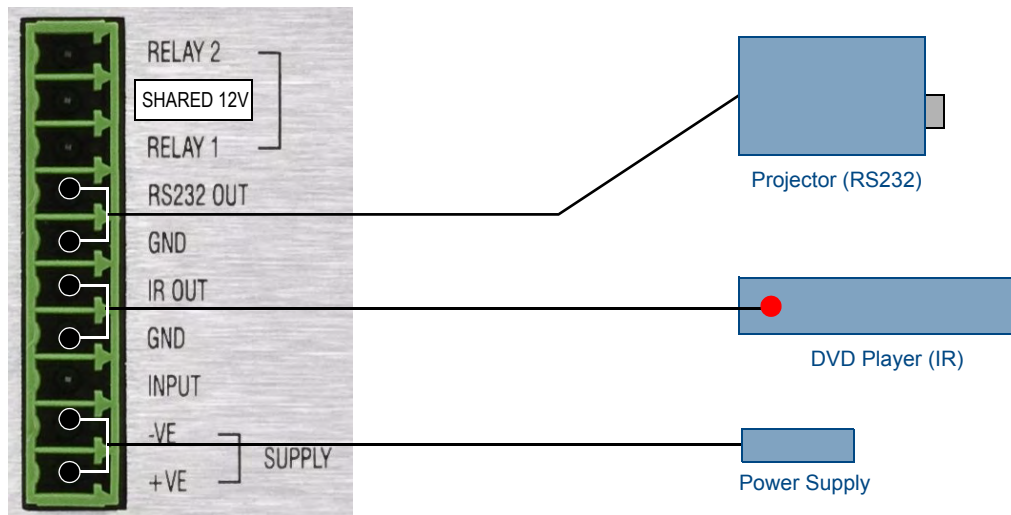

FIG. 7 NOVARA ControlPads - Rear Panel Connectors



The rear panel connector layout is identical for all NOVARA ControlPads.

Relay 1 / Relay 2 Connectors

The "Relay 1" and "Relay 2" *Output* ports each act as a switch to GND and are rated at 100 mA @ 12 VDC. These Output ports are used to control external devices (i.e. the PC1 Power Controller or AMX UPC-20+ Universal Power/Motor Controller - not included).

These Output ports do not function like "Relay" ports on other AMX equipment:

- The Relay 1 and Relay 2 output ports are *current sinks*, not voltage drivers, they switch the ports to GND.
- The "SHARED +12V" connector is common +12 VDC (*not Ground*).
- These Output ports use 5V logic, but can handle up to 12V on the input without harm - at higher voltages you run a higher risk of surge damage.



The Relay ports are for external relay control only.

FIG. 8 illustrates connecting the RELAY 1 (Output) Connectors to a **PC1 Power Controller**, in *momentary/latching* mode.

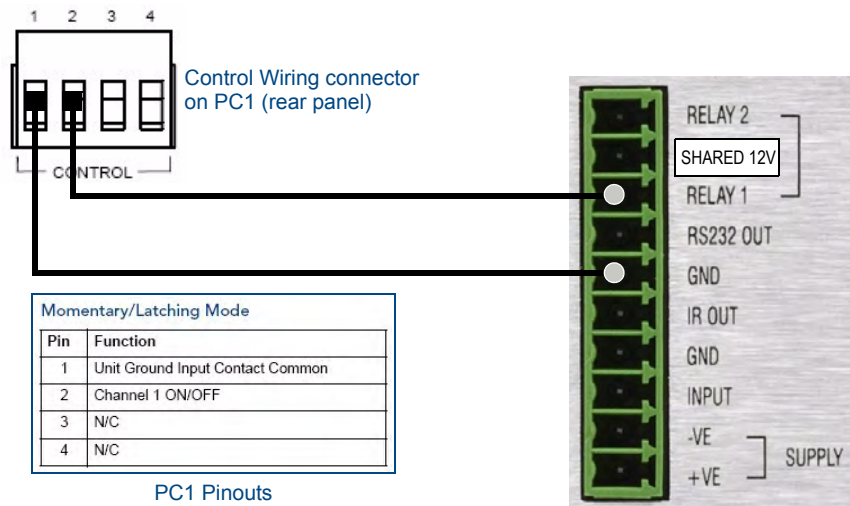

FIG. 8 Relay 1 / Relay 2 Connectors - Connected to PC1 Power Controller in momentary/latching mode

RS232 Out Connector

FIG. 9 illustrates connecting a 1000 Series ControlPad to RS232-controlled devices:

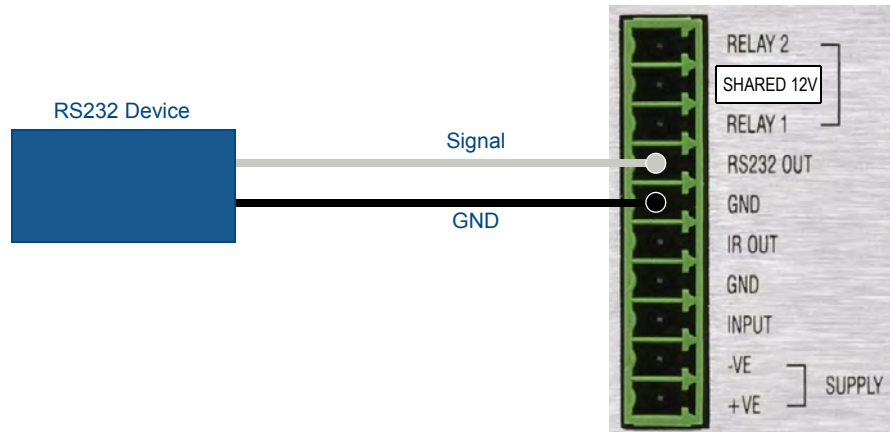

FIG. 9 RS232 Out Connector



NOTE

NOVARA ControlPads support one-way RS-232 control (RS-232 TX signals to the third-party device, not RS-232 RX signals from the controlled device).

IR Out Connector



NOTE

If using the CC-NIRC IR emitter with 2-pin phoenix connector (not included), be aware that the IR Emitter polarities on NOVARA ControlPads are opposite to that of other AMX equipment. This is not an issue if using the included 10-pin connector.

FIG. 10 illustrates connecting the IR transmitter heads to a 1000 Series ControlPad for IR-controlled devices:

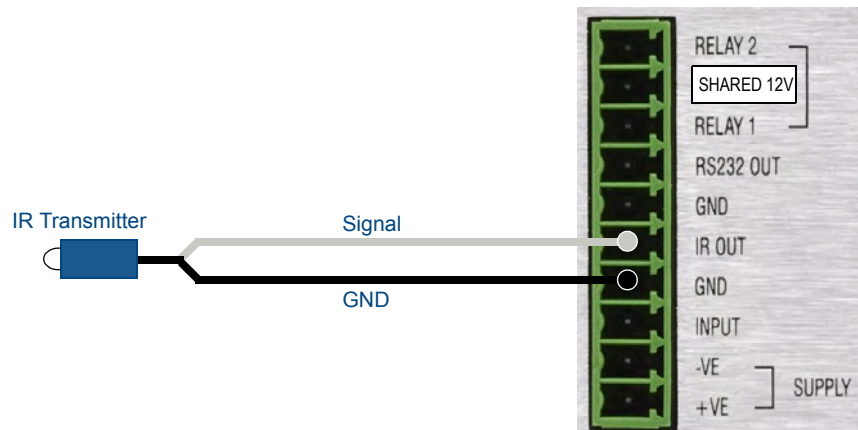

FIG. 10 IR OUT Connector



NOTE

The IR Transmitter must be placed directly in front of the controlled device's IR window.

Input Connector

FIG. 11 illustrates connecting the 1000 Series ControlPad to an external switch (such as a PIR switch), for detecting a High to Low or Low to High state.

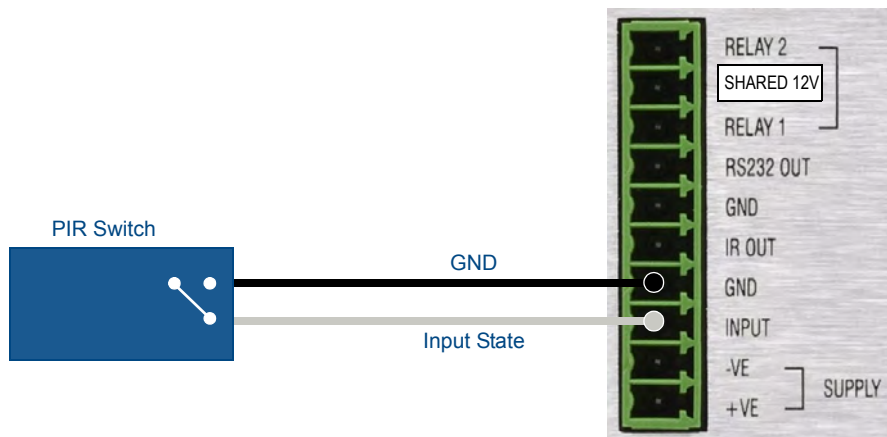

FIG. 11 Input Connector

If for example a PIR is attached to the Input, this will act as a trigger to reset the internal inactivity timer for Time Out routines.

Power Supply Connector



If using an AMX Power Supply with 2-pin phoenix connector (not included), be aware that the Power Supply polarities on NOVARA ControlPads are opposite to that of other AMX equipment. This is not issue if using the included 10-pin connector.

FIG. 12 illustrates connecting the 1000 Series ControlPad to the included power supply.

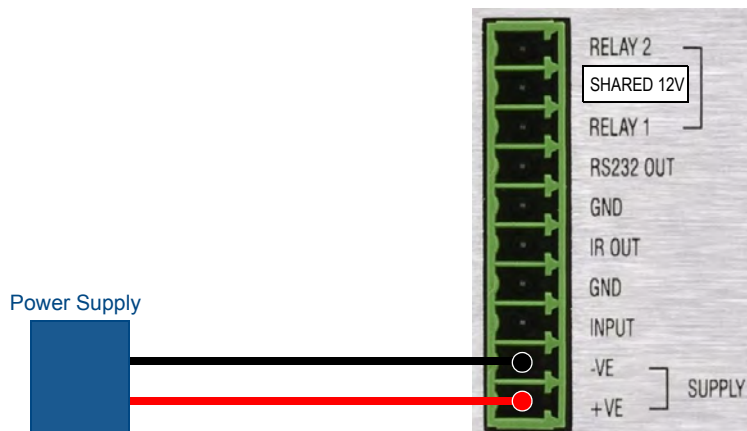

FIG. 12 Power Supply Connector

- Connect the White strip lead to the +VE terminal on the ControlPad,
- Connect the Black strip lead to the -VE terminal.

When the ControlPad is powered up or a program downloaded, button #2 will flash for 2 seconds then extinguish to indicate that the ControlPad has passed its self-test.

USB Program Port

To download a program to the ControlPad, connect the USB Programming cable to the ControlPad USB Port on the top panel, and the USB Port of the PC (FIG. 13).

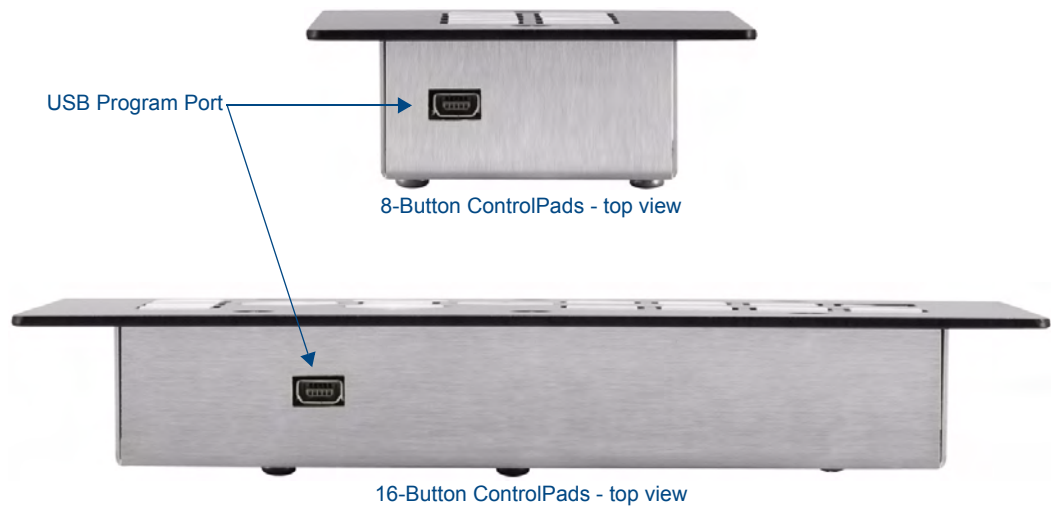

FIG. 13 USB Program Port

NOVARA 1000 Series ControlPads are configured using *AMX CP1000DCS* software (available for download at www.amx.com).

Refer to the *AMX NOVARA DCS1000 Device Configuration Software* section on page 43 for configuration instructions.

Button Layout

FIG. 14 indicates the button layout for 8 and 16 button ControlPads:

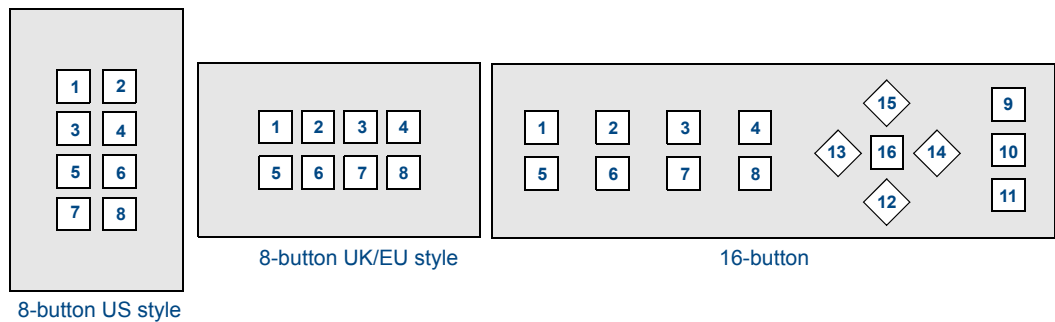

FIG. 14 1000 Series ControlPads Button Layout

- 8-Button ControlPad buttons are always numbered 1 - 8 for configuration purposes.
- 16-Button ControlPads are always numbered 1 - 16.

NOVARA AxLink KeyPads

Overview

NOVARA AxLink KeyPads can be used in both AxLink and Novara installations.

- NOVARA AxLink KeyPads feature a 4-pin AxLink connector and Status LED.
- NOVARA AxLink KeyPads feature one bi-directional RS-232 port, with accompanying loop-through port.
- 8 and 16 button layouts are available. Each button has LED feedback.

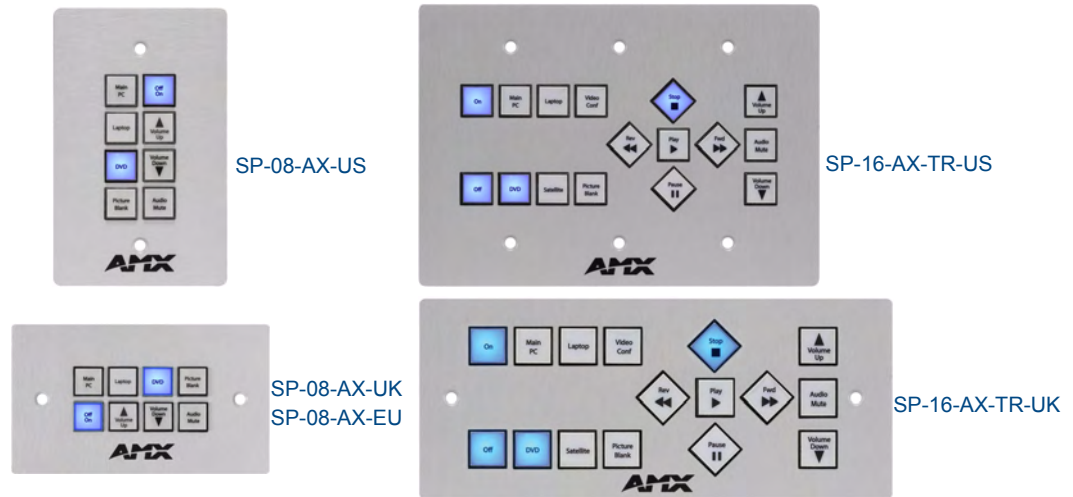

FIG. 1 NOVARA AxLink KeyPads

NOVARA AxLink KeyPads include:

NOVARA AxLink KeyPads		
Name	Description	Colors/FG#s
SP-08-AX-US 8-Button Keypad	Fits 1-gang US conduit boxes. See Mounting Specifications for details.	<ul style="list-style-type: none"> • Brushed Aluminum: FG1311-08-SA • Black: FG1311-08-SB • White: FG1311-08-SW
SP-08-AX-UK 8-Button Keypad	Fits standard 2-gang UK back box sizes.	<ul style="list-style-type: none"> • Brushed Aluminum: FG1311-08-KA • Black: FG1311-08-KB • White: FG1311-08-KW
SP-08-AX-EU 8-Button Keypad	Fits standard 2-gang European back box sizes.	<ul style="list-style-type: none"> • Brushed Aluminum: FG1311-08-EA • Black: FG1311-08-EB • White: FG1311-08-EW
SP-16-AX-TR-US 16-Button Keypad	Fits 3-gang US conduit boxes. See Mounting Specifications for details.	<ul style="list-style-type: none"> • Brushed Aluminum: FG1311-16-SA • Black: FG1311-16-SB • White: FG1311-16-SW
SP-16-AX-TR-UK 16-Button Keypad	Fits standard 3-gang UK back box sizes.	<ul style="list-style-type: none"> • Brushed Aluminum: FG1311-16-KA • Black: FG1311-16-KB • White: FG1311-16-KW

Product Specifications

NOVARA AxLink KeyPads	
Power Requirements:	<ul style="list-style-type: none"> • SP-08: Min: 80mA / Max: 130mA @ 12 VDC • SP-16: Min: 100mA / Max: 210mA @ 12 VDC
Button Layout:	<ul style="list-style-type: none"> • 8 and 16 button • Blue, backlit buttons with controllable feedback
Rear Panel Connectors:	<ul style="list-style-type: none"> • 4-pin AxLink connector/Status LED • RS-232 port, with accompanying loop-through port. • Power connectors
RS232 Protocol:	<ul style="list-style-type: none"> • Baud Rate: 9600 • Data Bits: 8 • Stop Bits: 1 • Parity: No Parity
Dimensions:	<ul style="list-style-type: none"> • SP-08-AX-US: 4.685" x 2.913" x 1.034" (11.899 cm x 7.399 cm x 2.626 cm) • SP-08-AX-UK: 3.386" x 5.787" x 1.034" (8.600 cm x 14.698 cm x 2.626 cm) • SP-08-AX-EU: 3.150" x 5.984" x 1.034" (8.001 cm x 15.199 cm x 2.626 cm) • SP-16-AX-TR-US: 4.724" x 6.693" x 1.037" (11.998 cm x 17.000 cm x 2.633 cm) • SP-16-AX-TR-UK: 4.331" x 9.055" x 1.037" (11.000 cm x 22.999 cm x 2.633 cm)
Weight:	<ul style="list-style-type: none"> • SP-08-AX-US: 0.30 lbs (136.08 g) • SP-08-AX-UK/EU: 0.35 lbs (158.76 g) • SP-16-AX-TR-US: 0.55 lbs (249.48 g) • SP-16-AX-TR-UK: 0.65 lbs (294.84 g)
Included Accessories:	<ul style="list-style-type: none"> • Button Kit - includes acetate sheet with 50 pre-cut button label inserts and clear plastic Key Caps w/ 8 Key Caps: MA1301-01 w/ 16 Key Caps: MA1301-02 • Installation Kit - includes 6-pin captive wire connector and mounting screws (KA1310-01)
Other AMX Equipment:	<ul style="list-style-type: none"> • 8 Button Kit (MA1301-01) • 16 Button Kit (MA1301-02) • External 12V Power Supply (57-1301-SA)
Certifications:	<ul style="list-style-type: none"> • IEC 60950 • FCC/CE • RoHS compliant

Mounting Specifications - 8-Button KeyPads



NOTE

NOVARA KeyPads are designed to fit in NEC-Compliant wall boxes only. These devices will not fit properly in non-NEC-Compliant wall boxes.

SP-08-AX-US

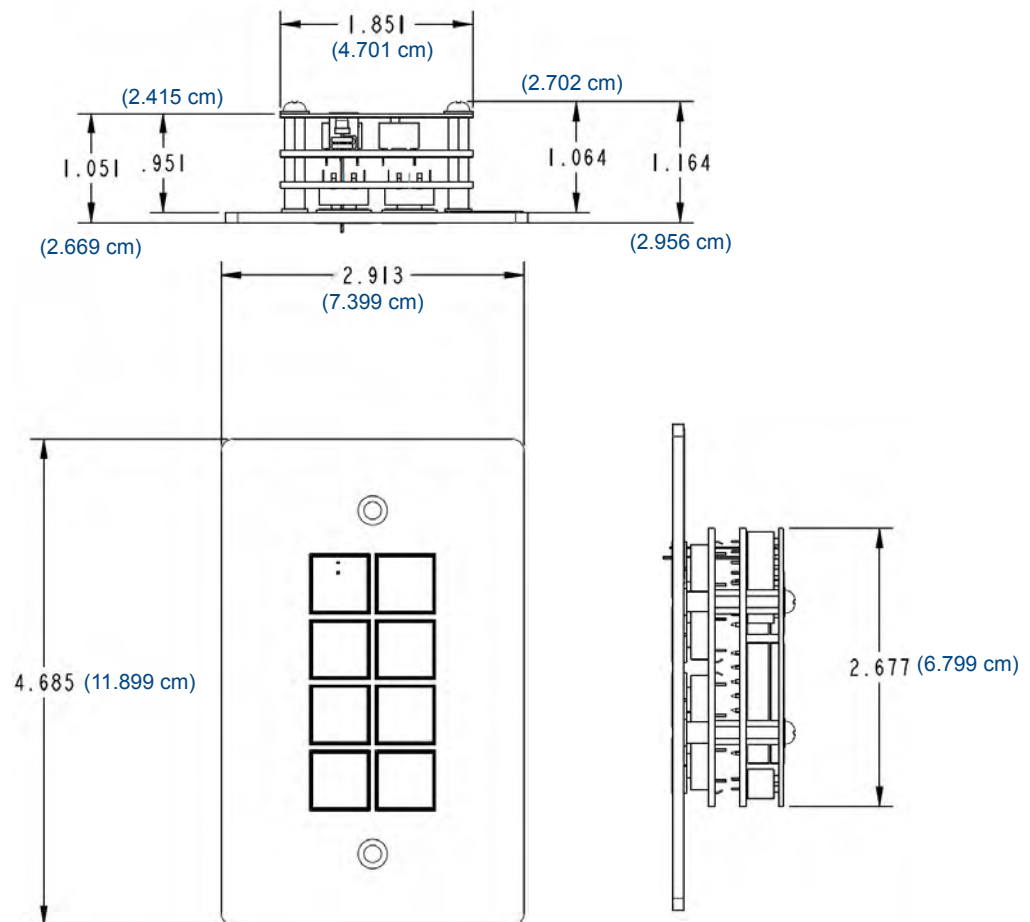

*in inches - metric conversions
shown in parenthesis*

FIG. 2 Mounting Specifications - SP-08-AX-US

Minimum Internal Clearance for 1-Gang US Conduit Boxes

To ensure a proper fit with sufficient clearance, US-style NOVARA ControlPads require the following minimum internal dimensions within the conduit box:

US 1-Gang (HWD): 2.9" x 2.1" x 1.6" (7.36 cm x 5.33 cm x 4.06 cm)

These minimum interior dimensions will maintain a minimum .050" (1.27 cm)

SP-08-AX-UK

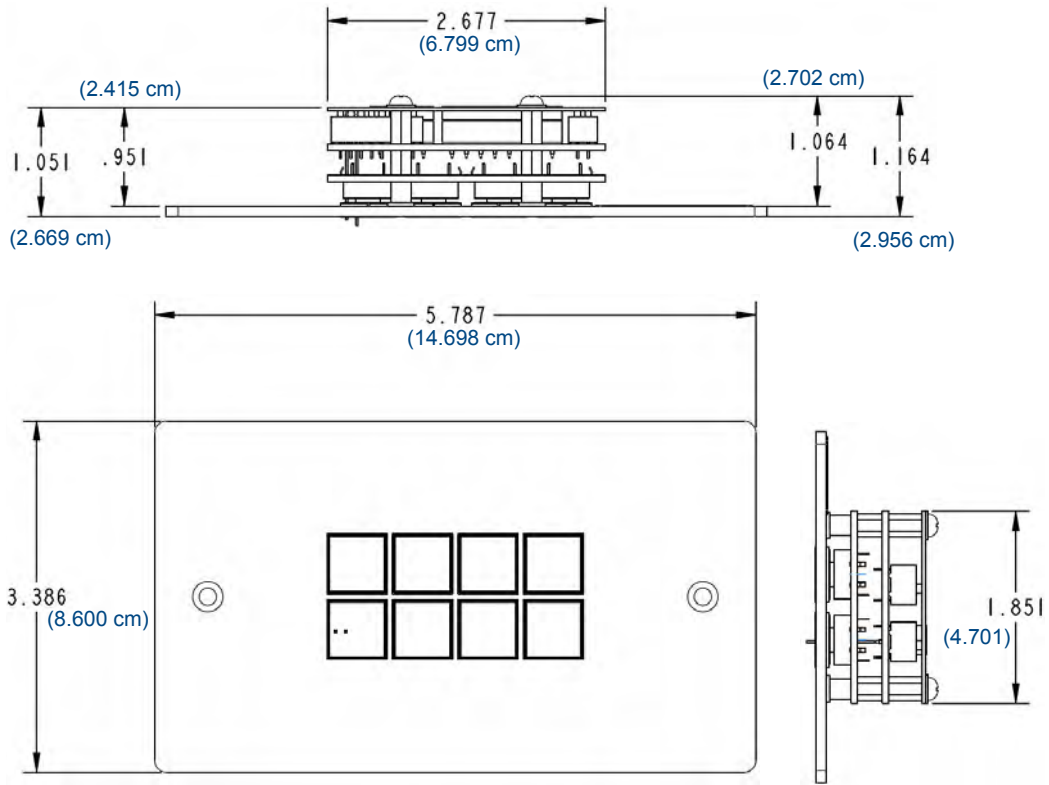

*in inches - metric conversions
shown in parenthesis*

FIG. 3 Mounting Specifications - SP-08-AX-UK

SP-08-AX-EU

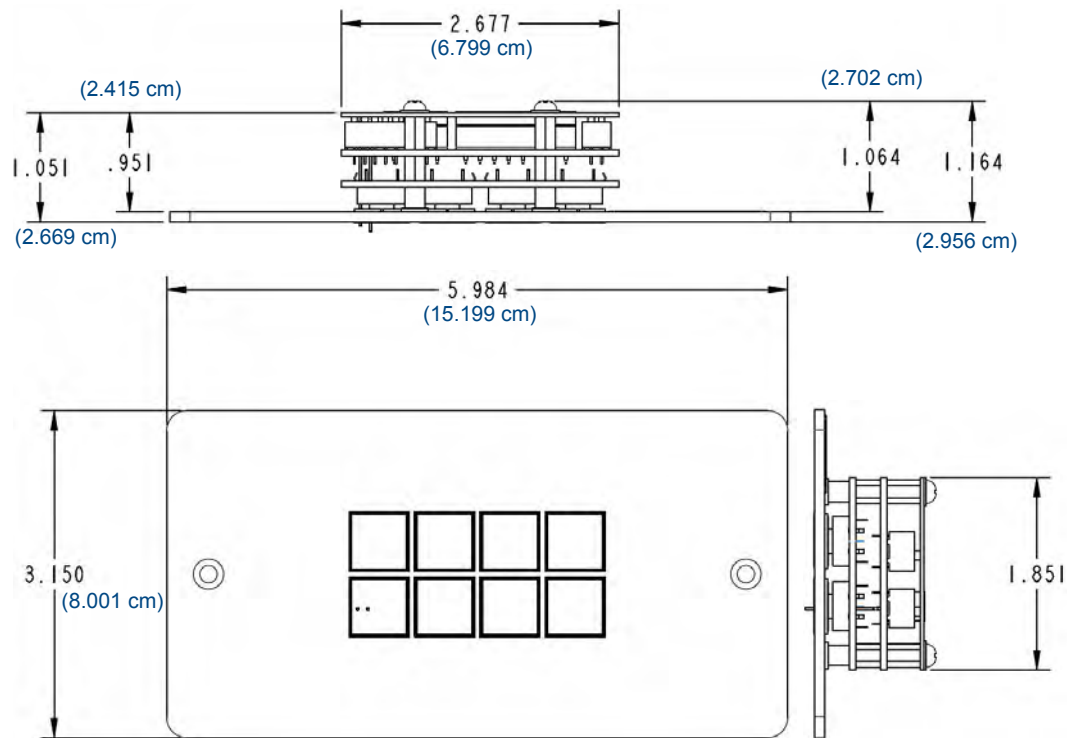

*in inches - metric conversions
shown in parenthesis*

FIG. 4 Mounting Specifications - SP-08-AX-EU

Mounting Specifications - 16-Button KeyPads



US version NOVARA KeyPads are designed to fit in NEC-Compliant wall boxes only. These devices will not fit properly in non-NEC-Compliant wall boxes.

SP-16-AX-TR-US

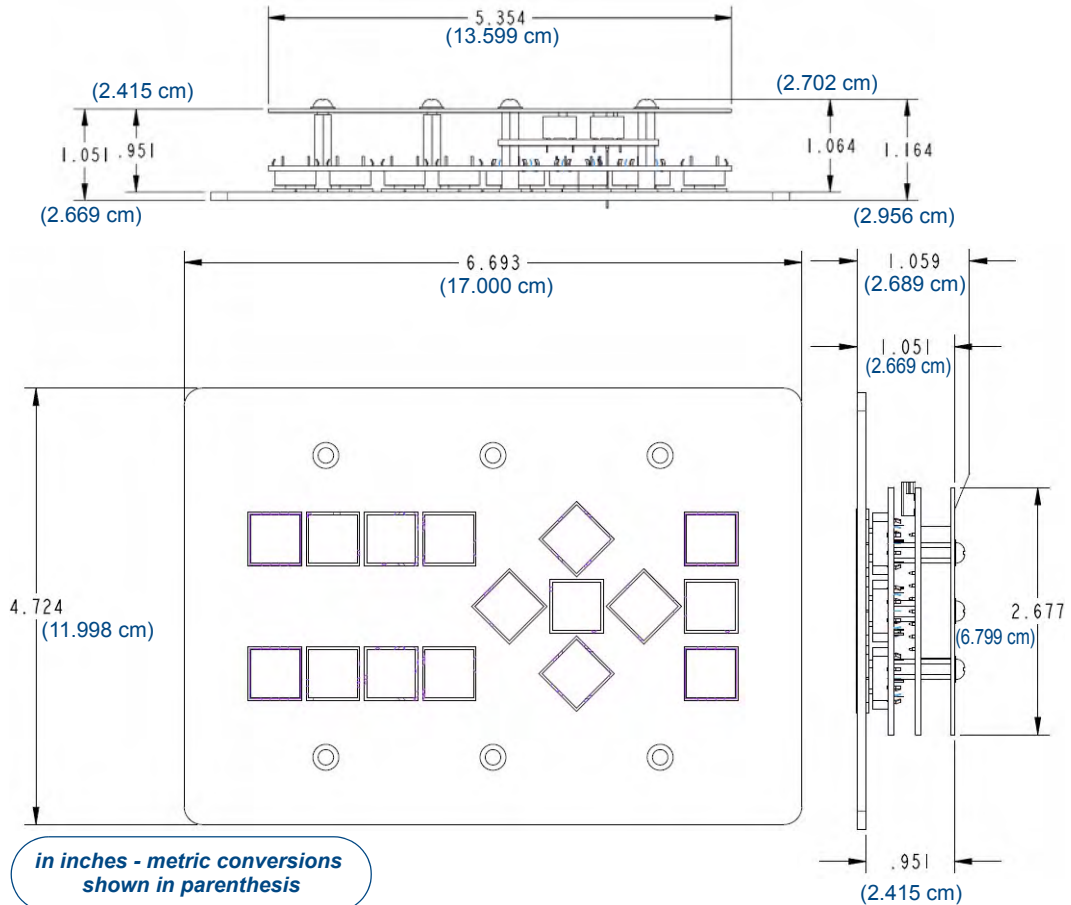

FIG. 5 Mounting Specifications - SP-16-AX-TR-US

Minimum Internal Clearance for 3-Gang US Conduit Boxes

To ensure a proper fit with sufficient clearance, US-style NOVARA ControlPads require the following minimum internal dimensions within the conduit box:

US 3-Gang (HWD): 5.6" x 2.9" x 1.6" (14.22 cm x 5.33 cm x 4.06 cm)

These minimum interior dimensions will maintain a minimum .050" (1.27 cm)

SP-16-AX-TR-UK

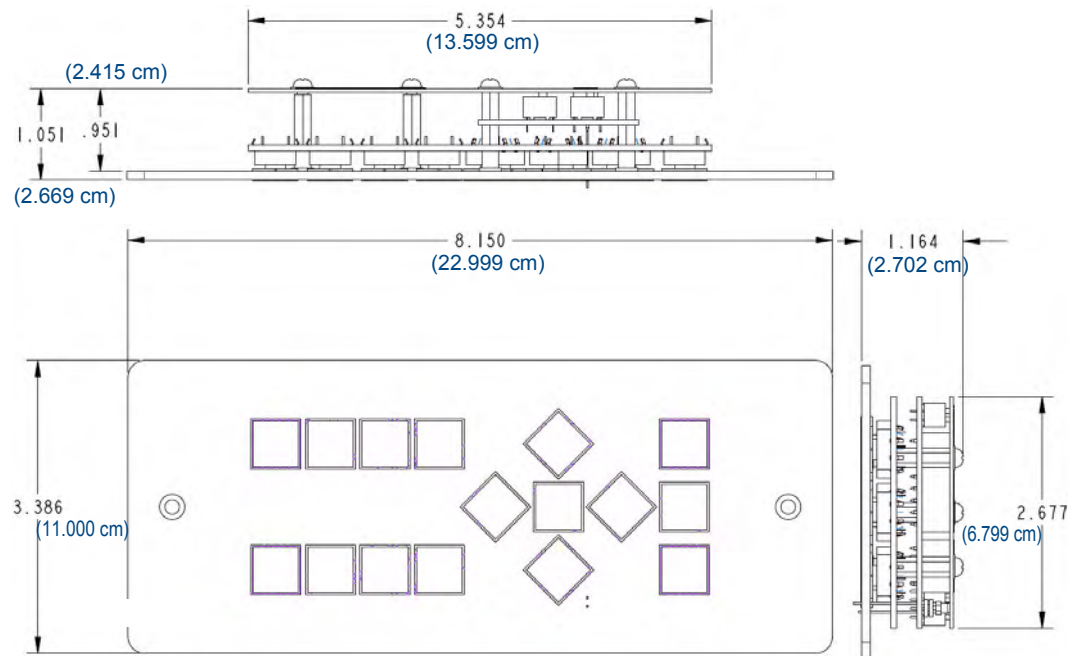

*in inches - metric conversions
shown in parenthesis*

FIG. 6 Mounting Specifications - SP-16-AX-TR-UK

Wiring and Connections

ControlPads - Rear Panel Connectors

FIG. 7 shows the rear panel connectors of the NOVARA AxLink KeyPads, and indicates a typical installation:



The rear panel connector layout is identical for all NOVARA AxLink KeyPads.

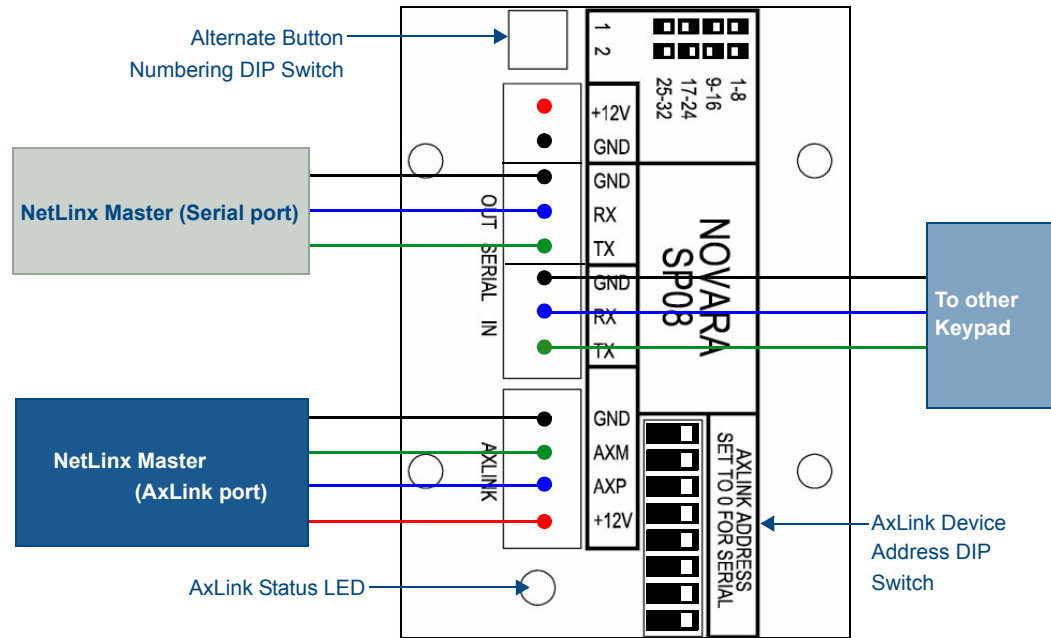

FIG. 7 NOVARA AxLink KeyPads - Rear Panel Connectors

RS-232 Connections



FIG. 8 RS232 Control - Connections

Power Supply Connector

NOVARA AxLink KeyPads can be powered by the AxLink bus. Optionally, an external 12V power supply can be used.



If using an external Power Supply, be aware that the Power Supply polarities on Novara KeyPads are opposite to that of other AMX equipment.

- Connect the White strip lead to the +VE terminal on the ControlPad
- Connect the Black strip lead to the -VE terminal

FIG. 9 illustrates connecting the Keypad to the included power supply.

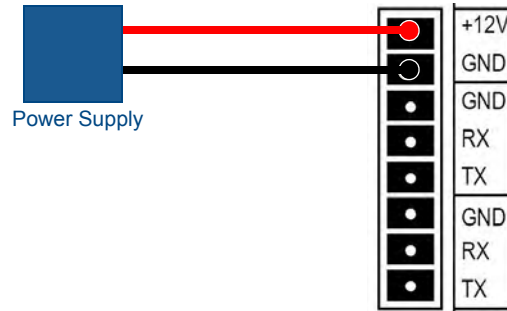

FIG. 9 Power Supply Connector

Daisy-Chaining KeyPads (RS232)

KeyPads can be daisy-chained as shown in FIG. 10.

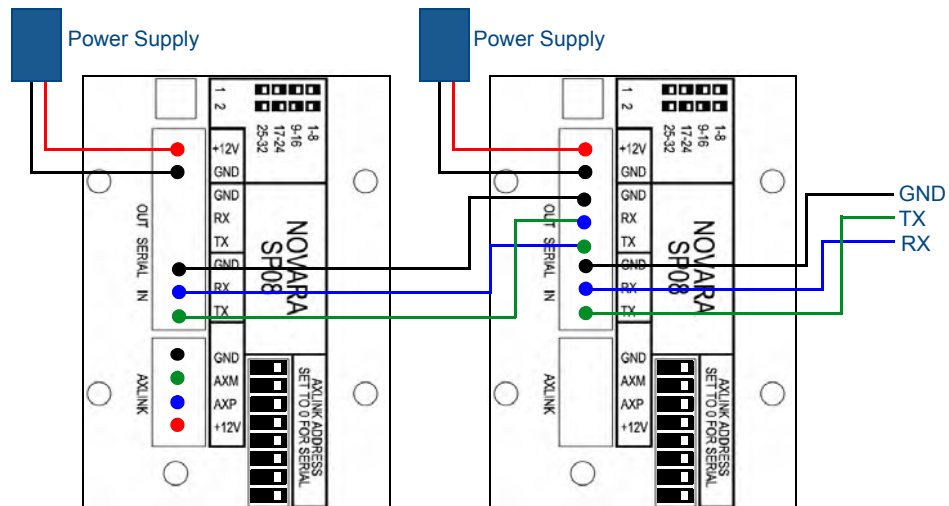

FIG. 10 Daisy-Chaining KeyPads

- Use screened cable to link units.
- Maximum cable length between panels should not exceed 50' (15.24 m).

Daisy-Chaining KeyPads (AxLink)

To daisy chain the KeyPads with AxLink, both KeyPads would be connected to the AxLink bus, and the RS232 is left unused. Either method can be used, but not a mixture of both.

Button Layout

FIG. 11 indicates the button layout for 8 and 16 button KeyPads:

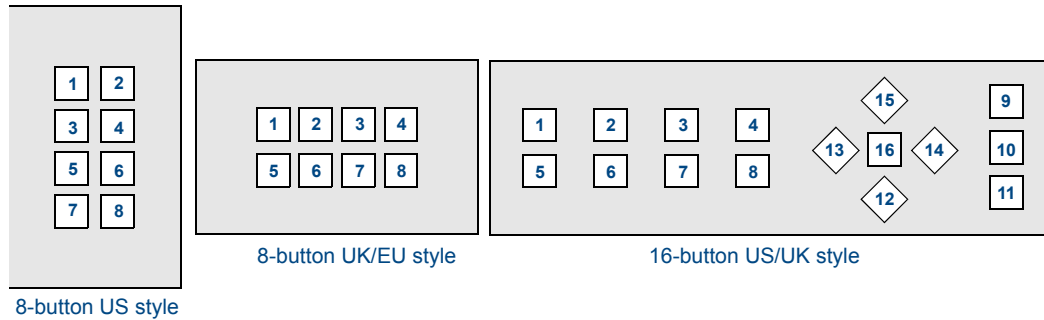

FIG. 11 KeyPads Button Layout

- 8-Button KeyPads can be configured for button numbers 1-8, 9-16, 17-24, or 25-32.
- 16-Button KeyPads can be configured for button numbers 1-16 or 17-32.

Setting DIP Switches to Assign Alternate Button Numbering

Use the 2-position DIP Switch on the rear panel of the KeyPads to specify alternate button numbers for each KeyPad, for cases in which you want to avoid having multiple KeyPads in the same system using the same button numbers.



Multiple KeyPads are allowed to share identical button numbers.

Alternate Button Numbering: 8-Button KeyPads

The DIP Switch settings for 8-button KeyPads are described in FIG. 12:

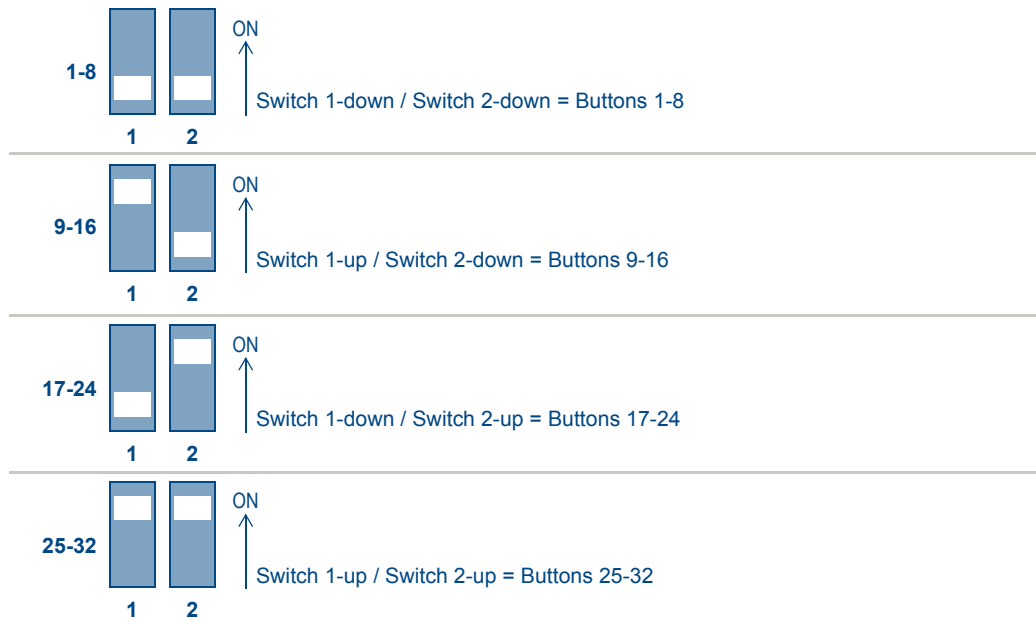

FIG. 12 DIP Switch Settings - Alternate Button Numbering: 8-Button KeyPads

Alternate Button Numbering: 16-Button KeyPads

The DIP Switch settings for 16-button KeyPads are described in FIG. 13:

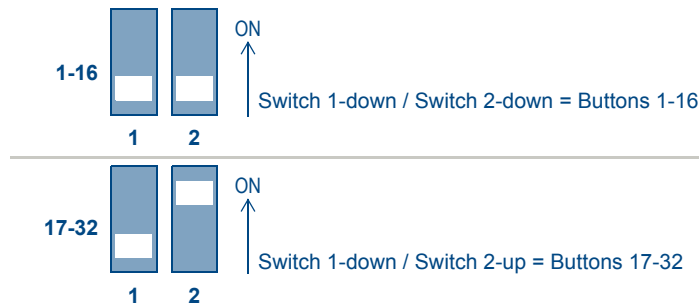

FIG. 13 DIP Switch Settings - Alternate Button Numbering: 16-Button KeyPads

Setting the AxLink Address DIP Switch

The AxLink Device Address DIP switch determines whether this KeyPad will function as an **AxLink** device or as a Serial device.

If the DIP Switch is set to anything other than zero, this KeyPad will be assigned an AxLink device address based on the switch settings.

Setting the AxLink Device Address

1. If connected, disconnect the power supply.
2. Locate the 8-position Device DIP switch on the rear panel.(FIG. 14).
3. Set the DIP switch according to the switch values shown below.

Switch	1	2	3	4	5	6	7	8
Value	1	2	4	8	16	32	64	128

The device number is set by the total value of DIP switch positions that are ON (up). As an example, the first DIP switch in FIG. 14 defines device number 129 (1+128=129).

If you later change the device number, remove and reconnect the AxLink power connector to enter the new device number into memory. Use AMX's Dip Switch2 application (available for download from www.amx.com) to assist in calculating Dip switch position values.

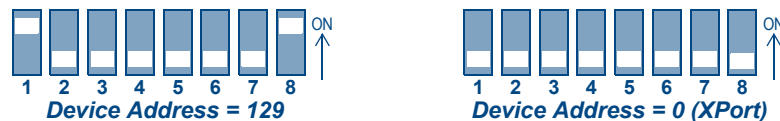

FIG. 14 Example Device DIP Switches

NOVARA KeyPads

Overview

NOVARA KeyPads can be daisy-chained to provide up to 32 buttons in any configuration, as well as connectivity to a NetLinx controller.

- NOVARA 00-Series KeyPads feature one bi-directional RS-232 port, with accompanying loop-through port. Refer to the *NOVARA RS232 Codes* section on page 79 for RS232 programming information.
- 8 and 16 button layouts are available. Each button has LED feedback.

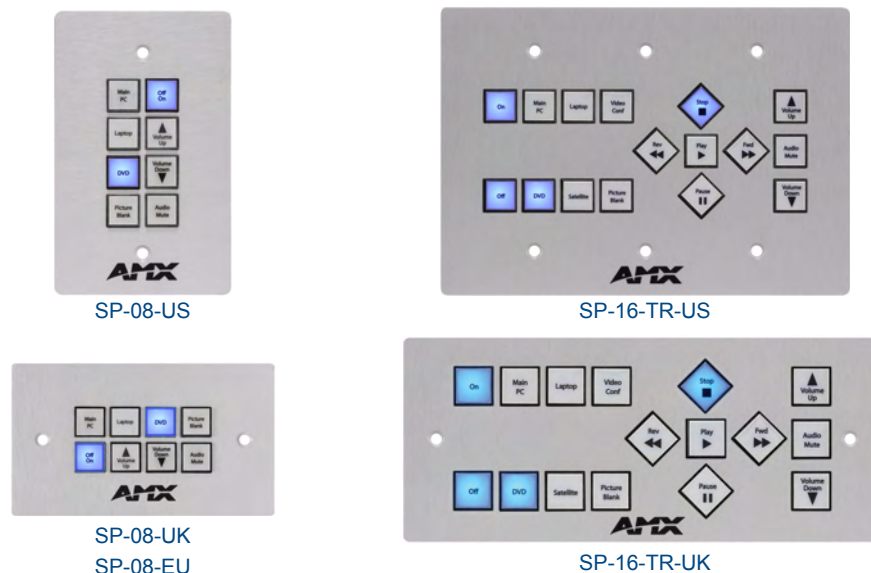

FIG. 1 NOVARA KeyPads

NOVARA 00-Series KeyPads include:

NOVARA 00-Series KeyPads		
Name	Description	Colors/FG#s
SP-08-US 8-Button KeyPad	Fits 1-gang US conduit boxes. <i>Refer to the Minimum Internal Clearance for 1-Gang US Conduit Boxes section on page 29 for details.</i>	<ul style="list-style-type: none"> • White: FG1310-08-SW • Black: FG1310-08-SB • Brushed Aluminum: FG1310-08-SA
SP-08-UK 8-Button KeyPad	Fits standard 2-gang UK conduit box sizes.	<ul style="list-style-type: none"> • White: FG1310-08-KW • Black: FG1310-08-KB • Brushed Aluminum: FG1310-08-KA
SP-08-EU 8-Button KeyPad	Fits standard 2-gang European conduit box sizes.	<ul style="list-style-type: none"> • White: FG1310-08-EW • Black: FG1310-08-EB • Brushed Aluminum: FG1310-08-EA
SP-16-TR-US 16-Button KeyPad	Fits NEC-Compliant 3-gang US conduit boxes. <i>Refer to the Minimum Internal Clearance for 3-Gang US Conduit Boxes section on page 32 for details.</i>	<ul style="list-style-type: none"> • White: FG1310-16-SW • Black: FG1310-16-SB • Brushed Aluminum: FG1310-16-SA
SP-16-TR-UK 16-Button KeyPad	Fits standard 3-gang UK conduit box sizes.	<ul style="list-style-type: none"> • White: FG1310-16-KW • Black: FG1310-16-KB • Brushed Aluminum: FG1310-16-KA

Product Specifications

NOVARA 1000-Series KeyPads	
Power Requirements:	<ul style="list-style-type: none"> • SP-08: Min: 80mA / Max: 130mA @ 12 VDC • SP-16: Min: 100mA / Max: 210mA @ 12 VDC
Button Layout:	<ul style="list-style-type: none"> • 8 and 16 button • Blue, backlit buttons with controllable feedback
Rear Panel Connectors:	<ul style="list-style-type: none"> • RS-232 port, with accompanying loop-through port. • Power connectors
RS232 Protocol:	<ul style="list-style-type: none"> • Baud Rate: 9600 • Data Bits: 8 • Stop Bits: 1 • Parity: No Parity
Dimensions:	<ul style="list-style-type: none"> • SP-08-US: 4.685" x 2.913" x 1.034" (11.899 cm x 7.399 cm x 2.626 cm) • SP-08-UK: 3.386" x 5.787" x 1.034" (8.600 cm x 14.698 cm x 2.626 cm) • SP-08-EU: 3.150" x 5.984" x 1.034" (8.001 cm x 15.199 cm x 2.626 cm) • SP-16-TR-US: 4.724" x 6.693" x 1.037" (11.998 cm x 17.000 cm x 2.633 cm) • SP-16-TR-UK: 4.331" x 9.055" x 1.037" (11.000 cm x 22.999 cm x 2.633 cm)
Weight:	<ul style="list-style-type: none"> • SP-08-US: 0.30 lbs (136.08 g) • SP-08-UK/EU: 0.35 lbs (158.76 g) • SP-16-TR-US: 0.55 lbs (249.48 g) • SP-16-TR-UK: 0.65 lbs (294.84 g)
Included Accessories:	<ul style="list-style-type: none"> • Button Kit - includes acetate sheet with 50 pre-cut button label inserts and clear plastic Key Caps w/ 8 Key Caps: MA1301-01 w/ 16 Key Caps: MA1301-02 • Installation Kit - includes 8-pin captive wire connector and mounting screws (KA1301-01). • External 12V Power Supply (57-1301-SA)
Other AMX Equipment:	<ul style="list-style-type: none"> • 8 Button Kit (MA1301-01) • 16 Button Kit (MA1301-02)
Certifications:	<ul style="list-style-type: none"> • UL/IEC 60950 • FCC/CE • RoHS compliant

Mounting Specifications - 8-Button KeyPads



NOVARA KeyPads are designed to fit in NEC-Compliant wall boxes only. These devices will not fit properly in non-NEC-Compliant wall boxes.

SP-08-US

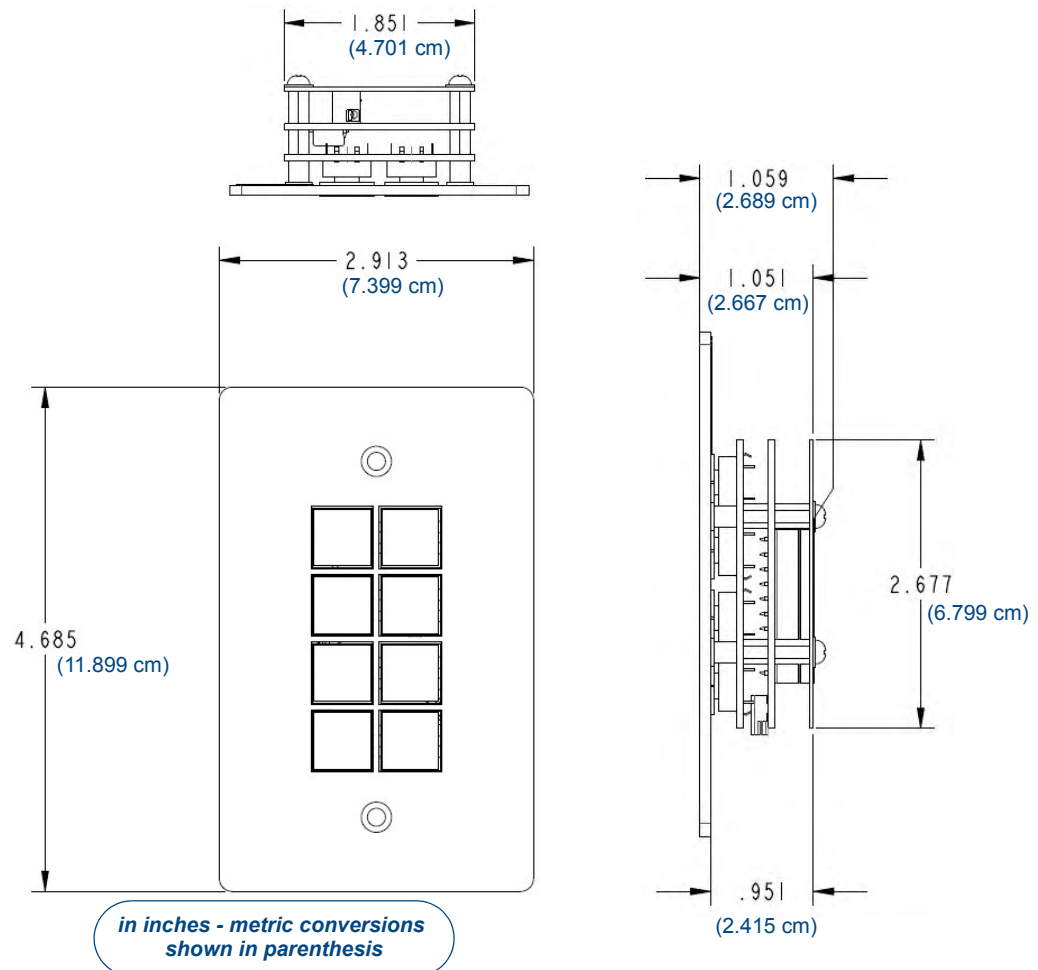

FIG. 2 Mounting Specifications - SP-08-US

Minimum Internal Clearance for 1-Gang US Conduit Boxes

To ensure a proper fit with sufficient clearance, US-style NOVARA ControlPads require the following minimum internal dimensions within the conduit box:

US 1-Gang (HWD): 2.9" x 2.1" x 1.6" (7.36 cm x 5.33 cm x 4.06 cm)

These minimum interior dimensions will maintain a minimum .050" (1.27 cm)

SP-08-UK

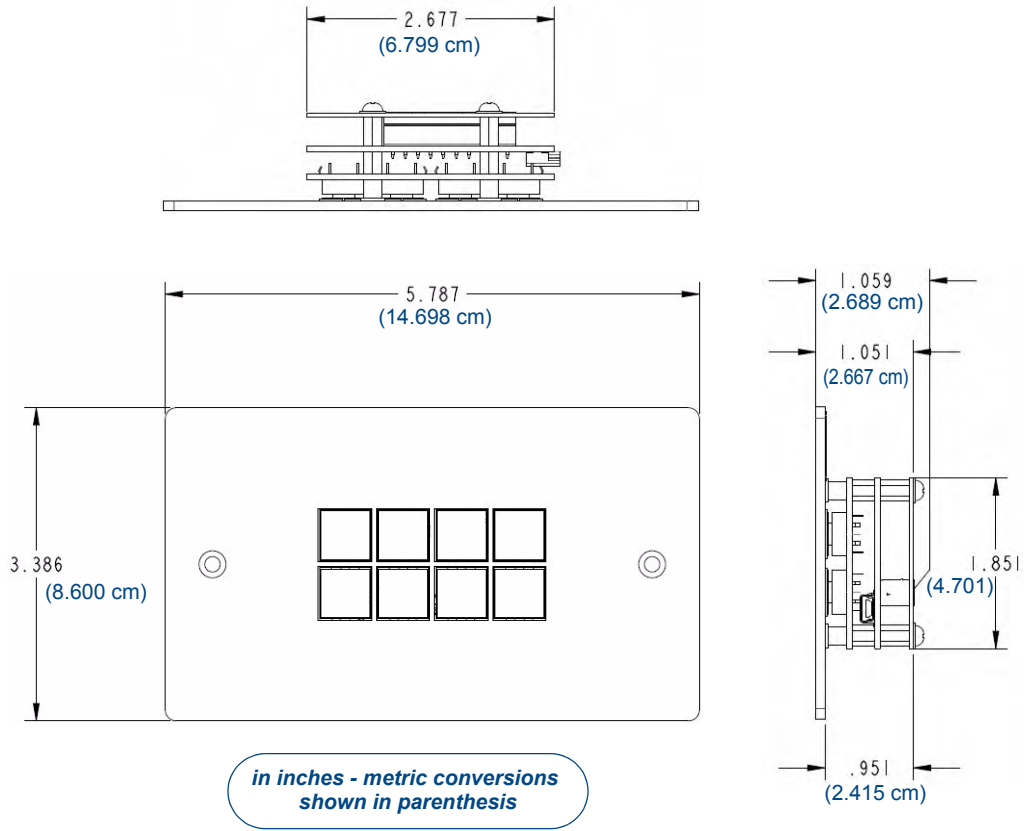

FIG. 3 Mounting Specifications - SP-08-UK

SP-08-EU

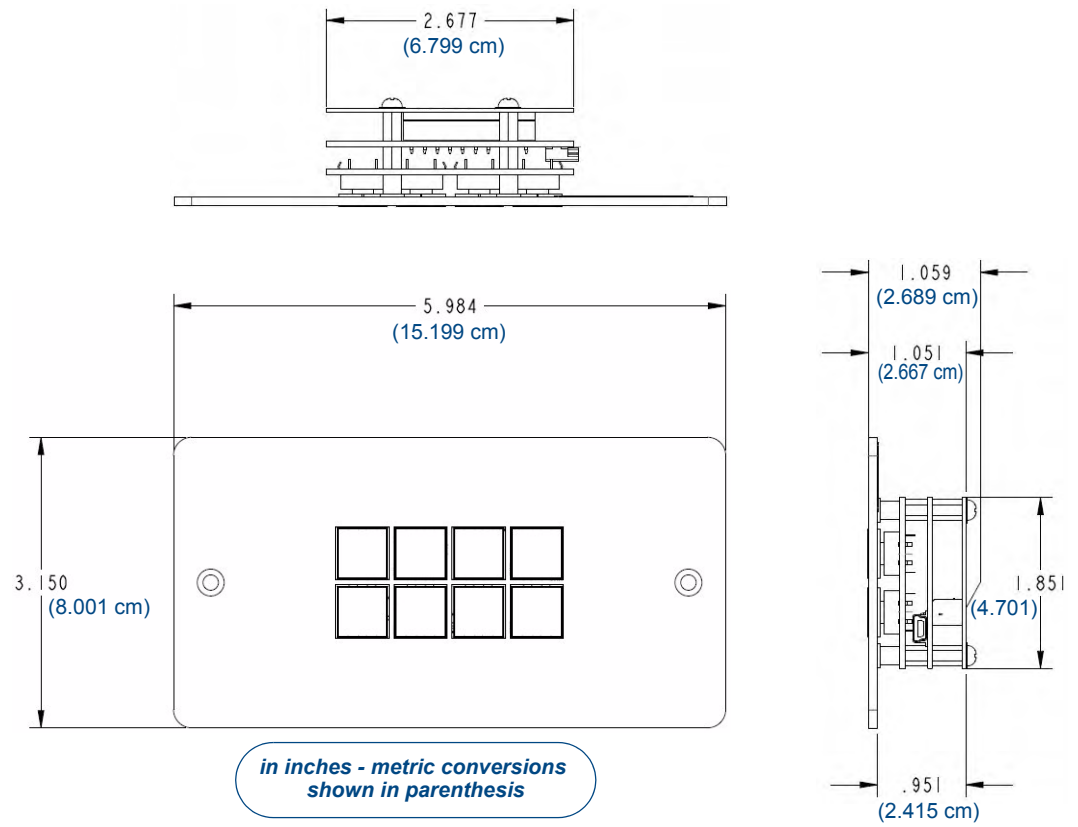

FIG. 4 Mounting Specifications - SP-08-EU

Mounting Specifications - 16-Button KeyPads



US version NOVARA KeyPads are designed to fit in NEC-Compliant wall boxes only. These devices will not fit properly in non-NEC-Compliant wall boxes.

SP-16-US

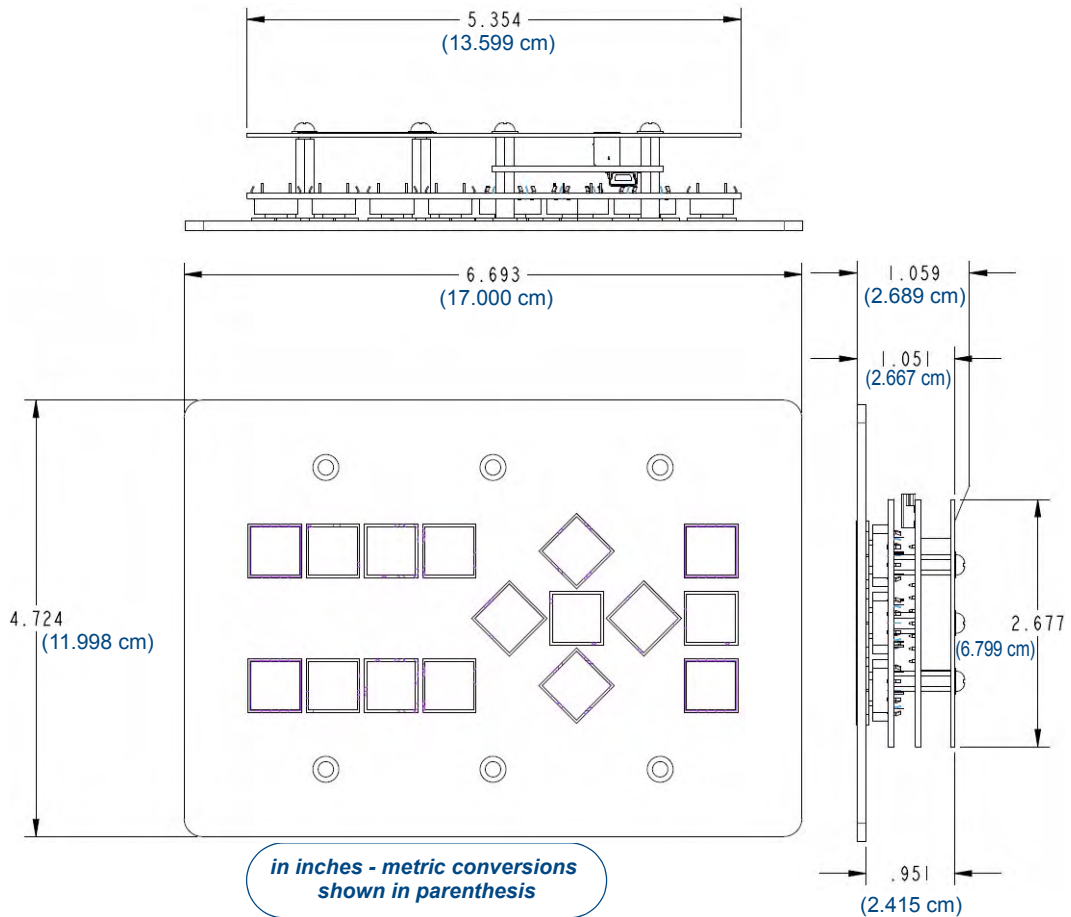

FIG. 5 Mounting Specifications - SP-16-US

Minimum Internal Clearance for 3-Gang US Conduit Boxes

To ensure a proper fit with sufficient clearance, US-style NOVARA ControlPads require the following minimum internal dimensions within the conduit box:

US 3-Gang (HWD): 5.6" x 2.9" x 1.6" (14.22 cm x 5.33 cm x 4.06 cm)

These minimum interior dimensions will maintain a minimum .050" (1.27 cm)

SP-16-UK/EU

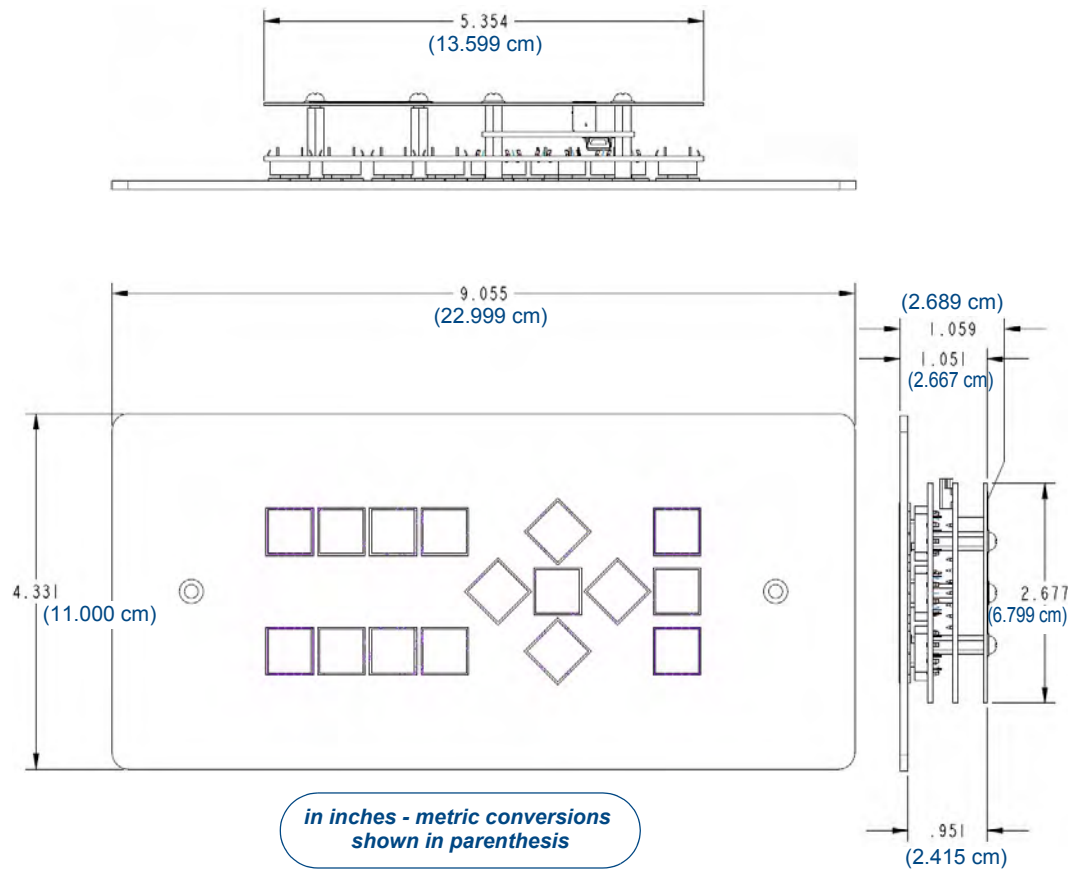

FIG. 6 Mounting Specifications - SP-16-UK/EU

Wiring and Connections

ControlPads - Rear Panel Connectors

FIG. 7 shows the rear panel connectors of the NOVARA KeyPads, and indicates a typical installation:

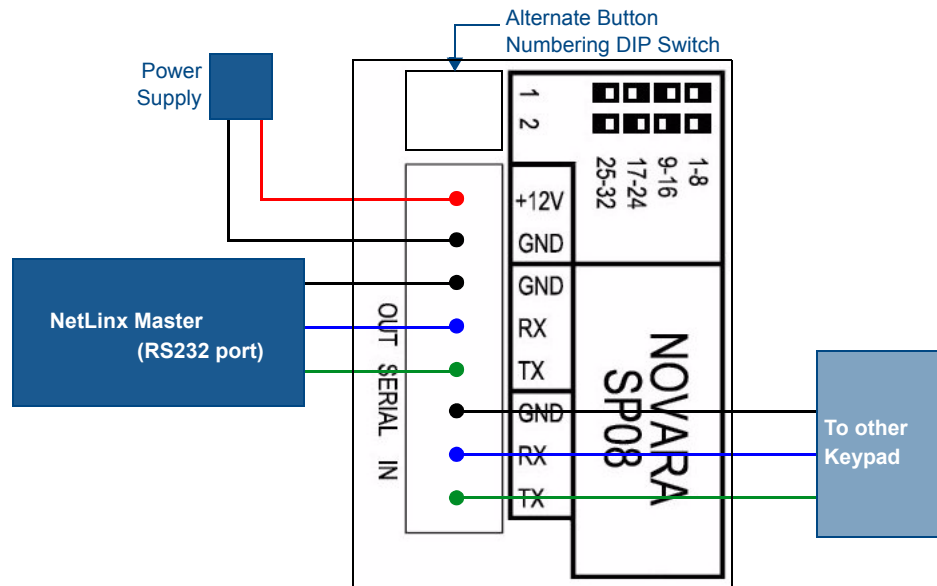

FIG. 7 NOVARA KeyPads - Rear Panel Connectors



The rear panel connector layout is identical for all NOVARA KeyPads.

RS-232 Connections



FIG. 8 RS232 Control - Connections

Power Supply Connector

FIG. 7 illustrates connecting the Keypad to the included power supply.



The Power Supply polarities on NOVARA KeyPads are opposite to that of other AMX equipment.

- Connect the White strip lead to the +VE terminal on the ControlPad
- Connect the Black strip lead to the -VE terminal

Daisy-Chaining KeyPads

KeyPads can be daisy-chained as shown in FIG. 9.

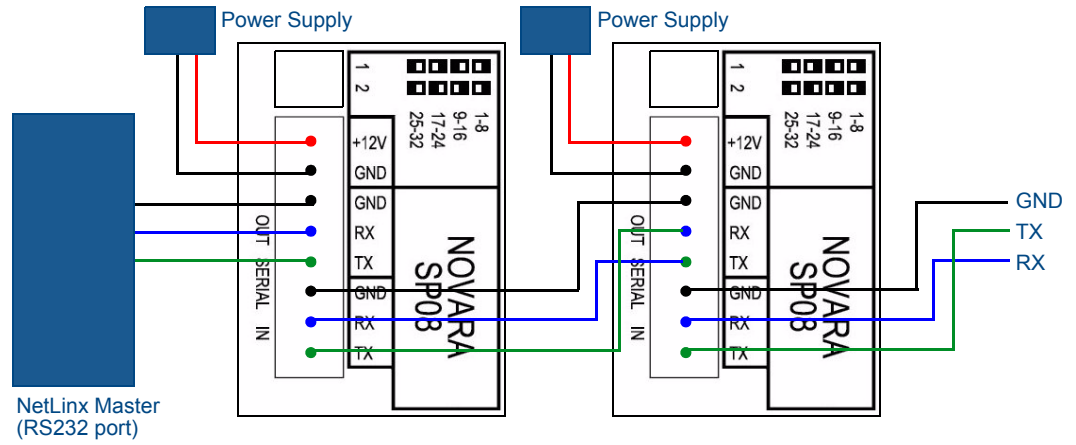

FIG. 9 Daisy-Chaining KeyPads

- Use screened cable to link units.
- Maximum cable length between panels should not exceed 50' (15.24 m).

Button Layout

FIG. 10 indicates the button layout for 8 and 16 button KeyPads:

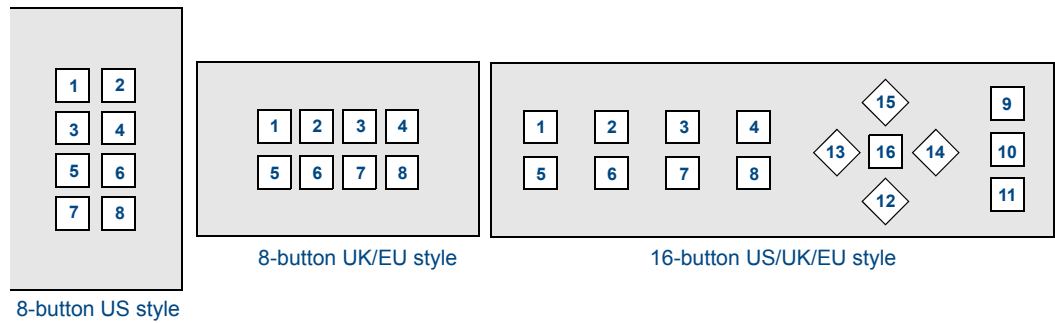

FIG. 10 KeyPads Button Layout

- 8-Button KeyPads can be configured for button numbers 1-8, 9-16, 17-24, or 25-32.
- 16-Button KeyPads can be configured for button numbers 1-16 or 17-32.

Setting DIP Switches to Assign Alternate Button Numbering

Use the 2-position DIP Switch on the rear panel of the KeyPads to specify alternate button numbers for each KeyPad, for cases in which you want to avoid having multiple KeyPads in the same system using the same button numbers.



NOTE

Multiple KeyPads are allowed to share identical button numbers.

Alternate Button Numbering: 8-Button KeyPads

The DIP Switch settings for 8-button KeyPads are described in FIG. 11:



FIG. 11 DIP Switch Settings - Alternate Button Numbering: 8-Button KeyPads

Alternate Button Numbering: 16-Button KeyPads

The DIP Switch settings for 16-button KeyPads are described in FIG. 12:

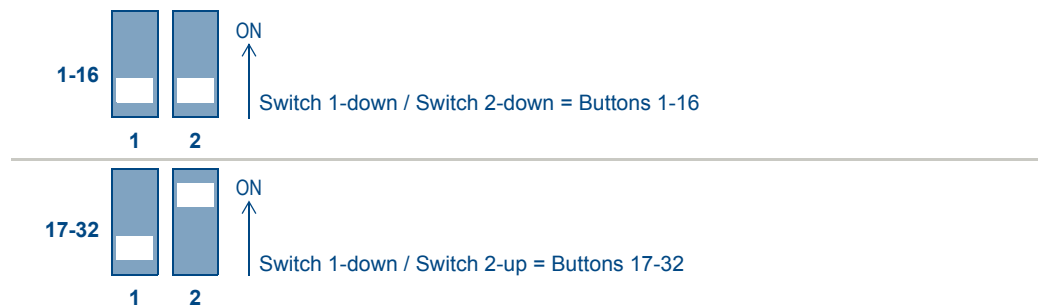

FIG. 12 DIP Switch Settings - Alternate Button Numbering: 16-Button KeyPads

Button Labelling

Overview

NOVARA ControlPads, KeyPads and AxLink KeyPads come with a set of clear plastic Key Caps, which are designed to fit tightly over the pushbuttons, and allow you to place a label on each button according to the requirements of your particular installation.

NOVARA ControlPads, KeyPads and AxLink KeyPads also come with a pre-printed acetate sheet with a range of 50 (pre-cut) button label inserts. The button labels provided will accommodate most installations, but it is also possible to print your own button labels on acetate for custom button labelling.

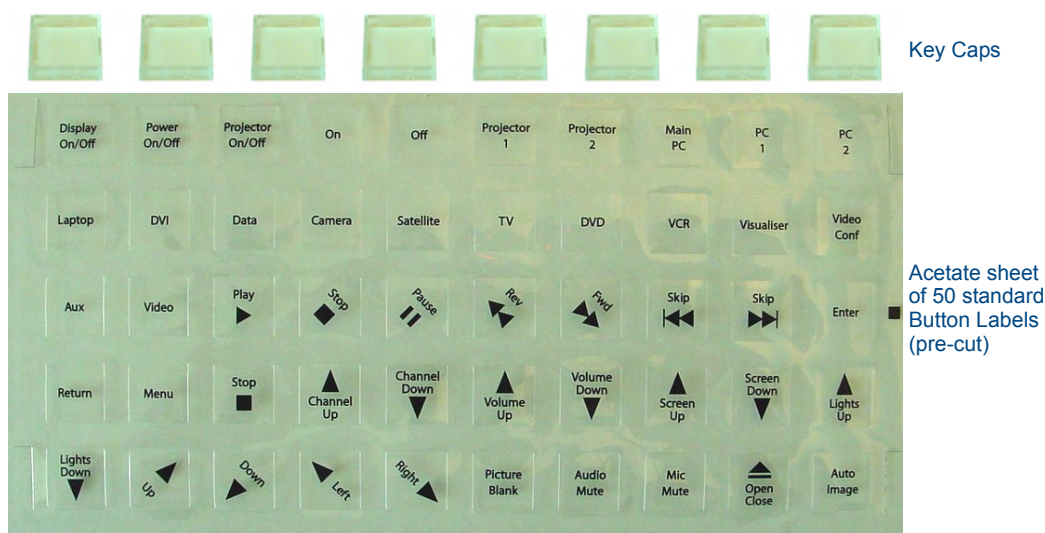

FIG. 1 Acetate Button Labels and plastic Key Caps

Installing Acetate Button Labels and Key Caps - READ THIS FIRST!

1. Punch out the desired Button Label from the included acetate sheet.
If you have printed your own custom button labels on acetate, cut each button label to fit inside the Key Caps.
 - Custom button labels must be cut to a **1.20cm (0.472") square** to fit securely inside the Key Caps.
 - The thickness of the acetate used must not exceed **.004" (0.10 mm)**.
2. Place the Key Cap face-down, and insert the Button Label into the bottom of the Key Cap (FIG. 2).

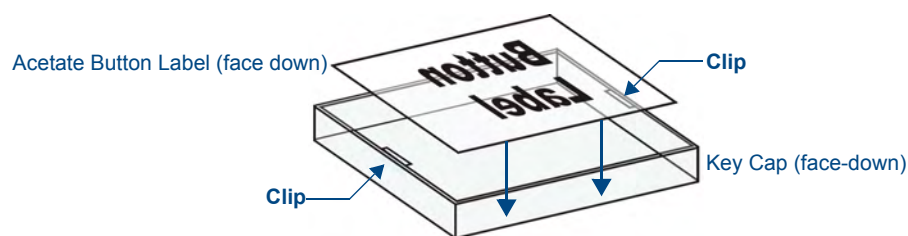

FIG. 2 Placing a Button Label inside a Key Cap

- Orient the Button Label inside the Key Cap so that the two clips are located on the left and right sides of the readable text on the Button Label, as indicated in FIG. 2.
- Be sure to place the Button Label face-down inside the Key Cap (see FIG. 2), otherwise the label will be seen in reverse once the Key Cap is installed.

3. Install the Key Cap on the pushbutton (FIG. 3):

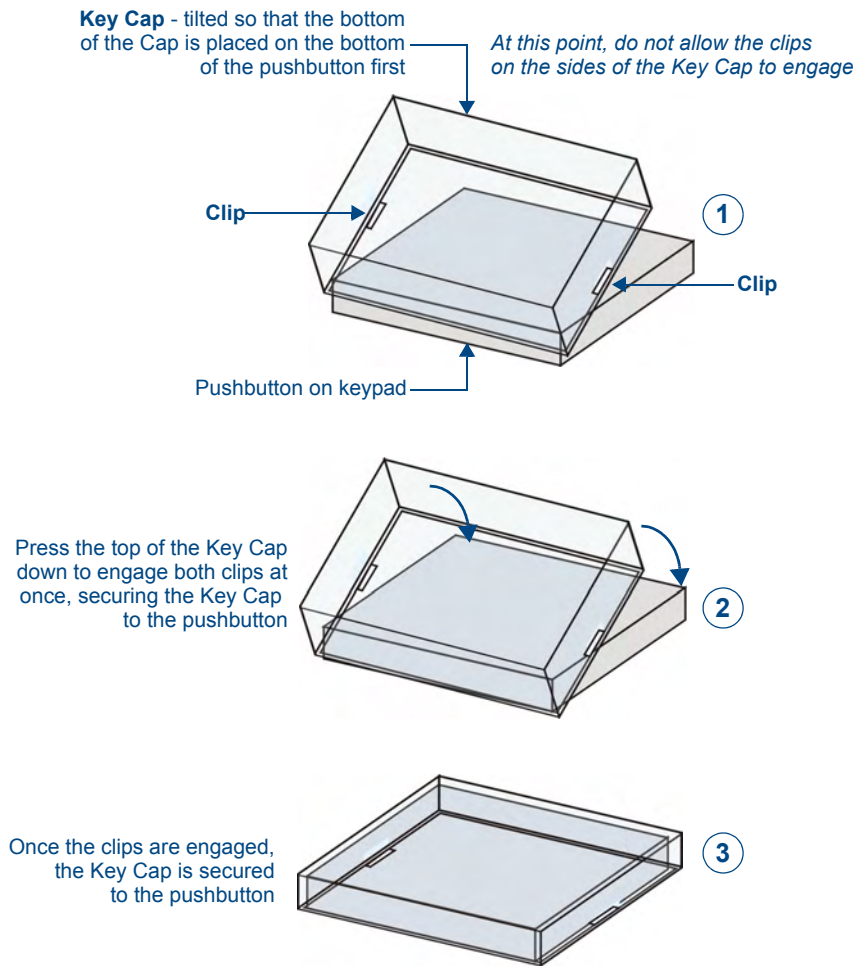

FIG. 3 Placing a Button Label inside a Key Cap



NOTE

Verify that the vertical orientation of the Button Label is correct relative to the keypad.

- a. Gently press the bottom of the Key Cap (no clip) onto the pushbutton. Do not allow the clips on either side to engage.
- b. With the bottom of the Key Cap secured, gently press the top of the Key Cap. This action will engage both clips simultaneously, and the Key Cap will snap into place on the push button.



NOTE

Be careful to follow these procedures closely - the bottom of the Key Cap must be installed on the pushbutton before the Key Cap clips engage, or there is a risk of the button being misaligned.

Also note that removing the Key Caps requires additional steps - see the Removing/Replacing Button Labels section on page 39 for details.

Removing/Replacing Button Labels

The button labels on NOVARA keypads are acetate inserts that fit inside the Key Caps installed on the pushbuttons. In order to change the inserts, the key caps need to be removed. Removing the Key Caps on NOVARA keypads requires disassembling the keypad, so that they can be accessed through the rear of the faceplate:

Disassembling the NOVARA Keypad



Remove power from the NOVARA keypad, and discharge any static electricity from your body by touching a grounded metal object before performing the following steps.

- This procedure will require a Phillips-head screwdriver and a 5mm wrench.
- Detailed exploded views of each NOVARA keypad type are included on the reverse.

1. On the rear panel of the NOVARA keypad, remove the screws that secure the metal enclosure to the faceplate.

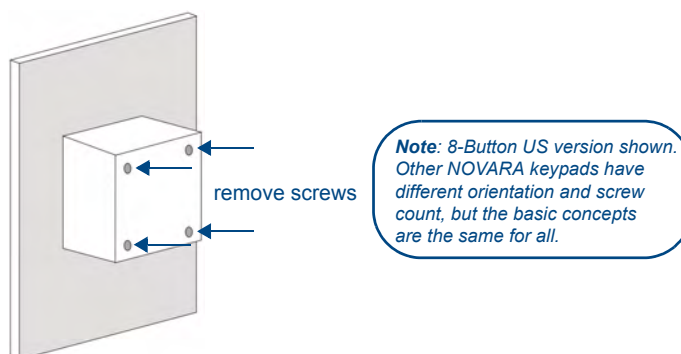

FIG. 4 Remove the metal enclosure to expose the circuit boards

- 8-Button keypads use 4 screws
 - 16-Button keypads use 6 screws
2. Remove the back enclosure to expose the circuit boards, mounted on stand-offs.
 3. Use a 5mm wrench to remove the first set of 5mm stand-offs.

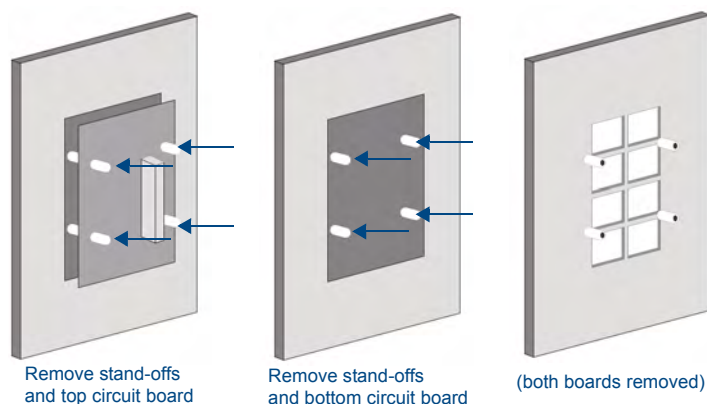

FIG. 5 Remove the first set of stand-offs (5mm)

4. Carefully pull the top circuit board straight up and off the standoffs.
 - This action also disengages two 4-pin connectors between the two boards.
Be careful not to bend the pins.
 - Note the orientation of the board - it must be oriented in the same direction when replaced.
The top is indicated by an UP arrow at the top center of the board.

The bottom is indicated by the AMX logo (FIG. 6).

5. Use a 5mm wrench to remove the second set of stand-offs.
6. Carefully pull the bottom circuit board straight up and off the standoffs.
 - The bottom board has the pushbuttons on the reverse side. Be careful not to damage the buttons when removing the board.
 - Note the orientation of the board - it must be oriented in the same direction when replaced.

The top of the is indicated by an UP arrow at the top center of the board.

The bottom is indicated by the AMX logo (FIG. 6).

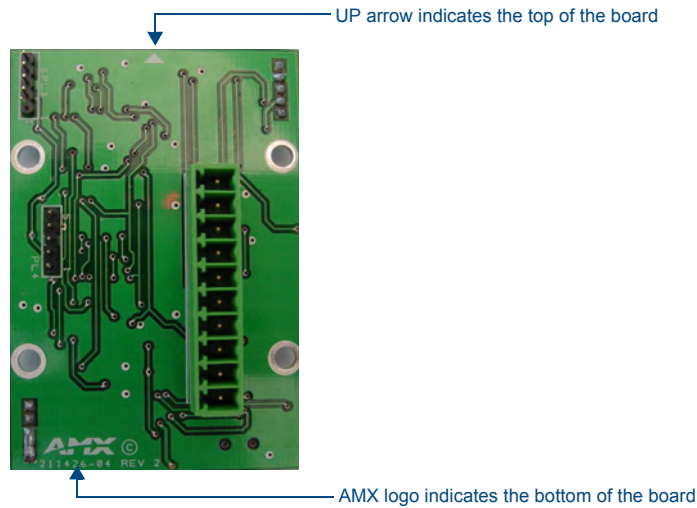

FIG. 6 Orientation marks on the circuit boards

Replacing Key Caps / Button Labels

Once the lower board has been removed, you have full access to the pushbuttons (with Key Caps installed, as shown in FIG. 7):

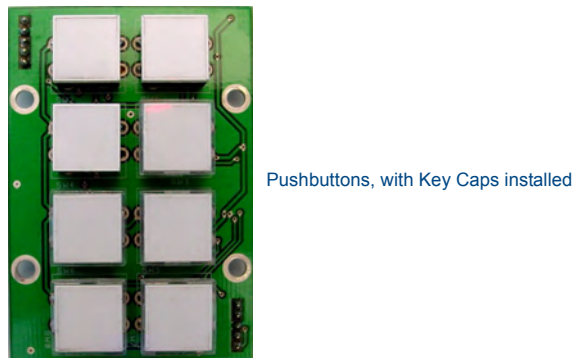

FIG. 7 Lower circuit board - pushbuttons

1. Carefully pry the Key Cap off of each pushbutton that you need to re-label.
2. Remove the existing acetate Button Label and Insert the replacement Label in each Key Cap. Be sure to place the Button Label face-down inside the Key Cap, otherwise the label will be seen in reverse once the Key Cap is installed.
3. Gently replace the Key Cap on the pushbutton:
 - Verify that the vertical orientation of the Button Label is correct relative to the NOVARA keypad.
 - Align the Key Cap with the target pushbutton, and gently push the Key Cap down over the pushbutton.
 - Once seated properly on the pushbutton, the Key Cap will snap into place.

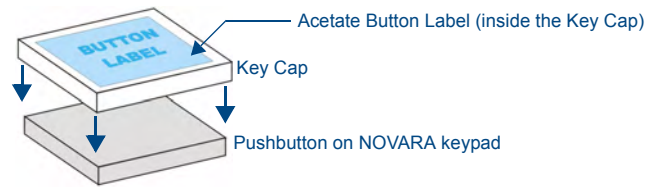

FIG. 8 Placing a Button Label inside a Key Cap

Re-Assembling the Keypad

Follow the steps in reverse to re-assemble the keypad. Take care of the following:

- Be certain that the circuit boards are oriented correctly (see FIG. 6)
- Be certain that both 4-pin connectors (between the two boards) are seated properly.

Exploded View - 8-Button US Version

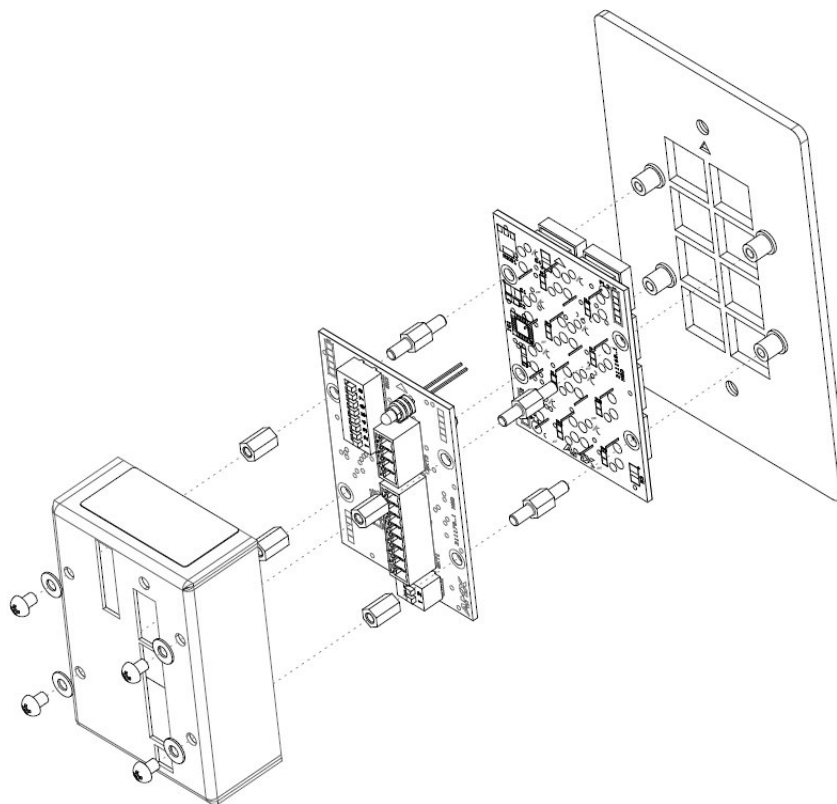

FIG. 9 8-Button US

Exploded View - 8-Button UK/EU Version

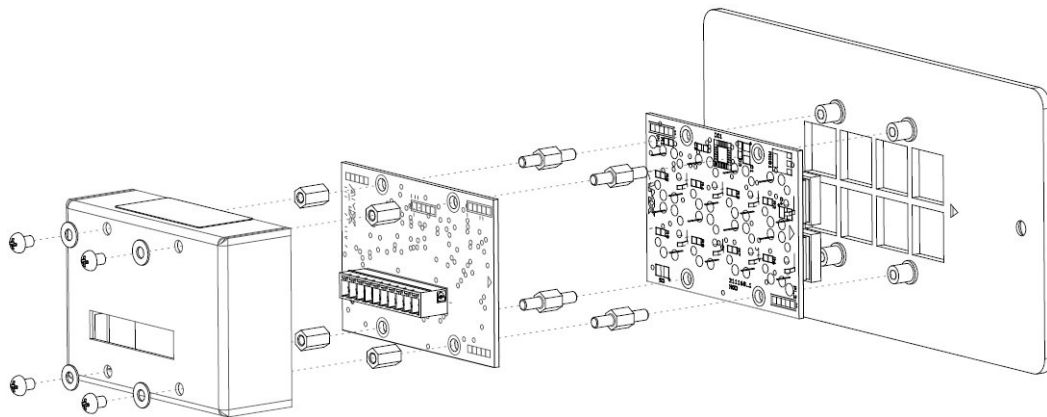

FIG. 10 8- Button UK/EU

Exploded View - 16-Button US/UK/EU Version

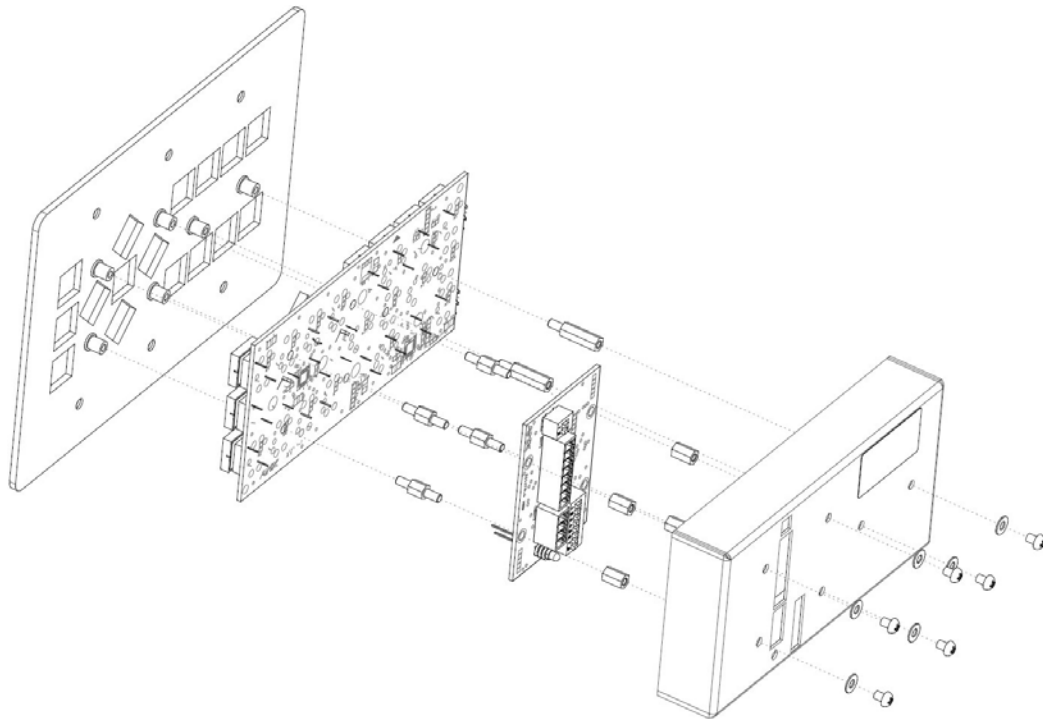

FIG. 11 16-Button US/UK/EU

AMX NOVARA DCS1000 Device Configuration Software

Installing the AMX NOVARA DCS1000 Application

1. Download the AMX NOVARA DCS1000 installation file from www.amx.com (go to the **Products** page and search for *DSC1000*).
2. Double-click the installation file to launch the *AMX DSC1000 Setup Wizard* (FIG. 12). Click **Next** to proceed.

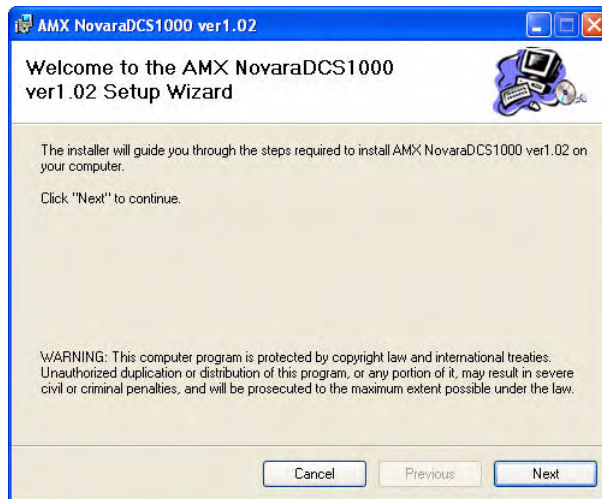

FIG. 12 AMX DSC1000 Setup Wizard

3. Read the *License Agreement* (FIG. 13), and click **I Agree** to accept the terms and proceed with the installation. (otherwise, click **Cancel**).

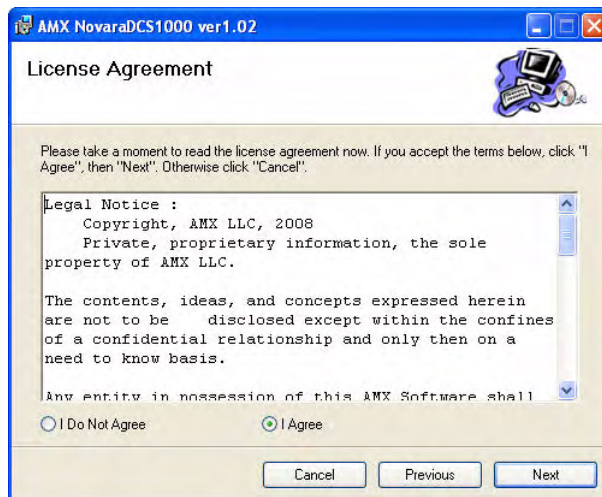

FIG. 13 AMX DSC1000 License Agreement

4. Click **Next** on each of the following dialogs to complete a standard installation (recommended).

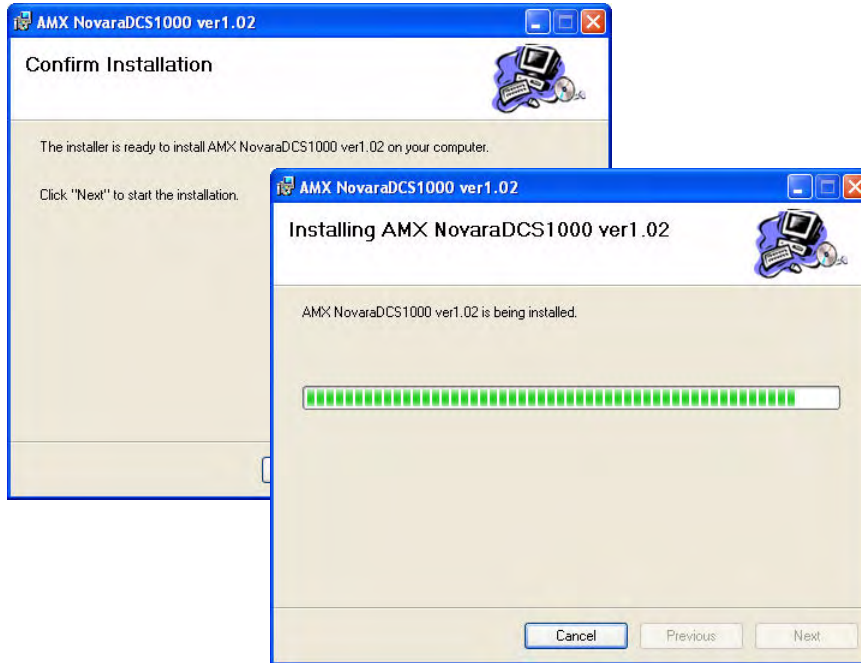

FIG. 14 AMX DCS1000 Standard Installation

5. In the *Installation Complete* dialog, click **Close** to finish (FIG. 15).

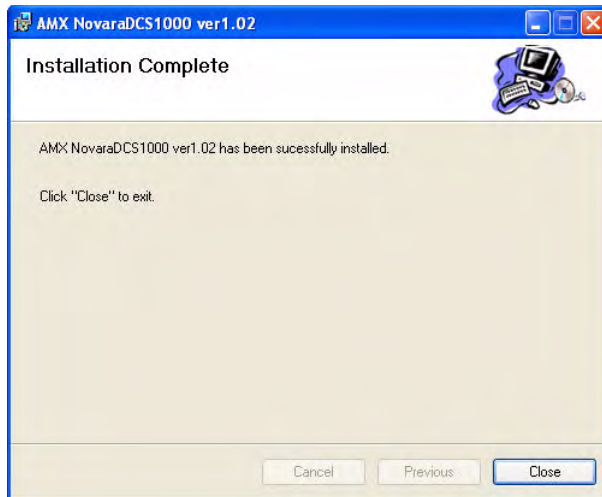

FIG. 15 Installation Complete dialog

Launching AMX NOVARA DCS1000

Assuming you followed the default installation procedures, launch the AMX NOVARA DCS1000 application by double-clicking the AMX NOVARA DCS1000 program icon on your desktop (FIG. 16).



FIG. 16 AMX NOVARA DCS1000 - Program icon



Alternatively, navigate to **Start > Programs > AMX NOVARA DCS**, and click on the program icon.

Overview

Novara ControlPads and KeyPads are configured using the *AMX NOVARA DCS1000* software application, available for download from www.amx.com (FIG. 17).

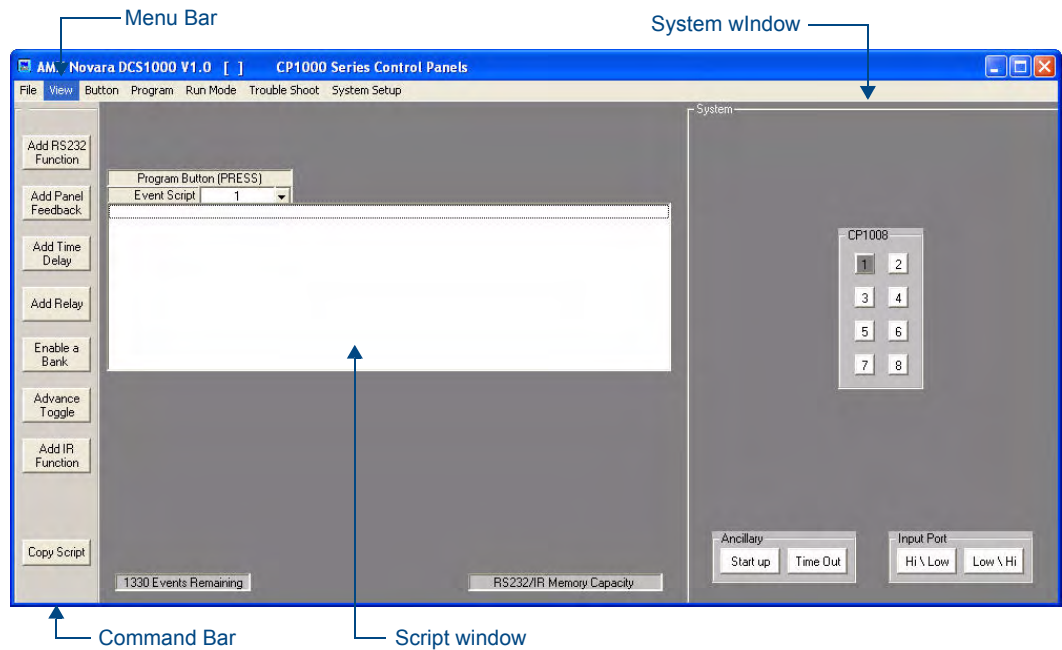

FIG. 17 AMX NOVARA DCS1000 software application (initial view)

The *AMX NOVARA DCS1000* application allows the ControlPad to perform various functions such as RS232/ IR control / Button Feedback /Delay Time / Relay Control / Time Out if a button press is not detected after a certain time period.

- Each button is configured individually; it can be made to execute on a Press or Release.
- Each button can be configured to Toggle for up to 4 Presses or it could be assigned to a Bank of buttons having the same function but controlling different equipment.
- A Script is written for each button containing events. A script can be written for events to execute when the ControlPad is powered up by selecting 'Start Up' from the system window.
- An Event could be an RS232 command, a button Feedback, a Delay Time etc.
- When any or all of the buttons have been configured, the information can be downloaded to the ControlPad.

Downloading the Program to the ControlPad

1. Connect the USB Programming Cable to a USB port on your PC, and to the **Program** (USB) port on the ControlPad.
2. Click on the **Program** menu bar item. This invokes the *Download Program* window (FIG. 18).

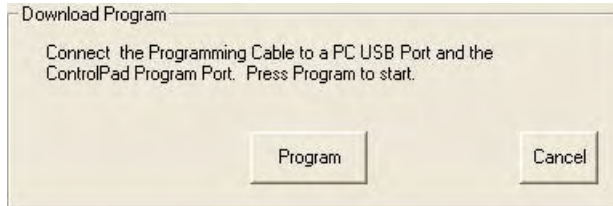

FIG. 18 Download Program window

3. Click the **Program** button to download the program to the ControlPad.

Specifying Button Feedback

A button LED has 3 possible states: *On*, *Off* and *Flash*. Use the **Add Panel Feedback** options to assign feedback to a selected button.



Buttons can be assigned to a group where only one LED of the group may be on at any time.

Adding Feedback to a Button Script (Example)

1. Select a button to configure from the *System* window (FIG. 19).

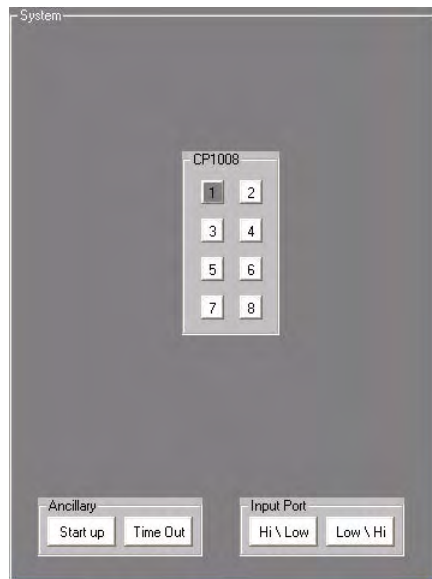

FIG. 19 System window - Button 1 selected

2. Click on the **Add Panel Feedback** button in the Command Bar to invoke the *Select Button Feedback* window (FIG. 20).

The selected button will be listed as the default although any button may be selected, via the drop-down menu on the left side of the window.

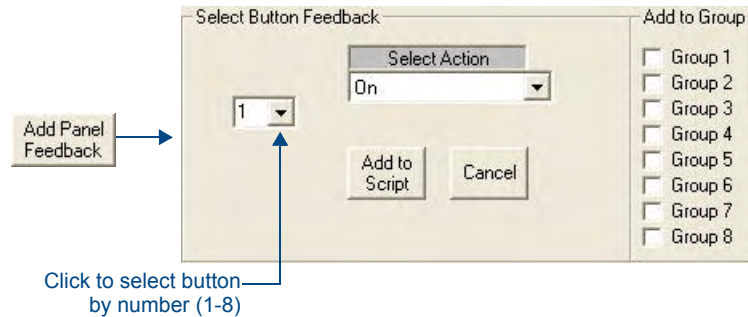

FIG. 20 Select Button Feedback window

3. Select '**On**' from the *Select Action* drop-down menu.
4. Click the **Add to Script** button. The *Event Script* window indicates **Event 1** as being the chosen button feedback: **On** (FIG. 21).

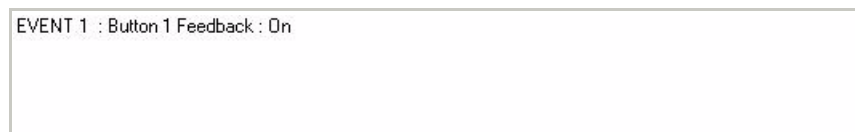

FIG. 21 Event Script window - Event 1

5. With button 2 selected, select **Flash** from the *Select Button Feedback* drop-down menu, and click on **Add To Script** add this feedback to the script. The *Event Script* will now show **Event 2** as **Button 2 Feedback: Flash** (FIG. 22).

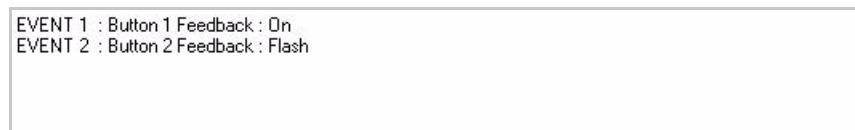

FIG. 22 Event Script window - Event 2

6. Download the program to the ControlPad - see the *Downloading the Program to the ControlPad* section on page 46.
7. When the panel has been loaded press the configured button on the ControlPad (in this example, button #1). The chosen button for Event1 will illuminate and the button for Event2 will flash.
8. Try configuring other buttons with On / Off / Flash actions.
9. To Save your program, select **File > Save** from the menu bar.



NOTE

AMX NOVARA DCS1000 data files are saved with the extension *.NVA.

Button Feedback - On / All Buttons Off

The *On / All Buttons Off* Button Feedback option will illuminate the chosen button, and turn off all other buttons on the ControlPad (FIG. 23).

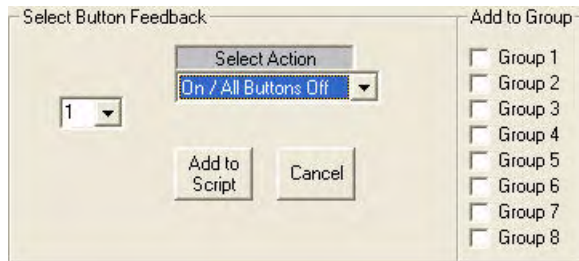

FIG. 23 Button Feedback - On / All Buttons Off

Button Feedback - On / Group Off

The *On / Group Off* Button Feedback option allows you to assign feedback to a Group, so that only one of the group may be illuminated at a time (FIG. 24).

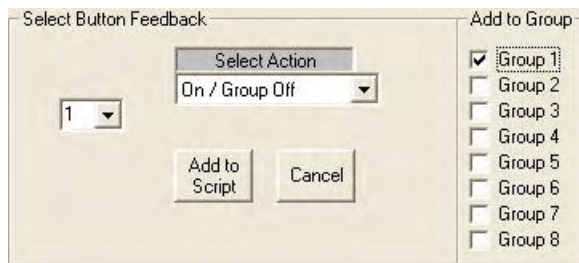

FIG. 24 Button Feedback - Button 1, On / Group Off, Group 1

For instance Play / Stop / Pause. An LED may be assigned to up to 8 groups.

1. Clear the program by selecting **File > New** from the menu bar.
2. Select Button 1 in the *System* window (see FIG. 19 on page 46).
3. Click on **Add Panel Feedback** to invoke the *Select Button Feedback* window (FIG. 20 on page 47).
4. From the *Select Action* drop-down menu, select **On/ Group Off**, and click **Group1** under **Add To Group** (as shown in FIG. 24).
Repeat for Buttons 2 to 4.
5. Select Button 5, click on **Add Panel Feedback**, select **On/ Group Off**, and click on **Group 2** (FIG. 25).

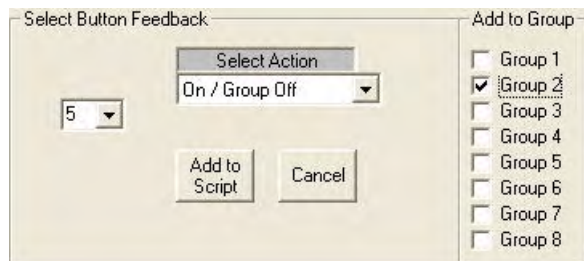

FIG. 25 Button Feedback - Button 5, On / Group Off, Group 2

Repeat for buttons 6 to 8.

6. To Save your program, select **File > Save** from the menu bar.

Testing Grouped Feedback

1. Download the program to the ControlPad (see the *Downloading the Program to the ControlPad* section on page 46).
2. Press Button 1 - the LED should illuminate.
3. Now press Button 2, this LED should illuminate, and extinguish Button 1.
 - Only the pressed button of 1 to 4 will stay illuminated.
 - Likewise only the pressed button of 5 to 8 will stay illuminated.

Delay Time

A delay time can be added in between events in a Script.

- Delays can range from 0.5 seconds up to 24hours.
- The delay is absolute and no other Event or Button press will be acknowledged until the time period has elapsed.

Adding Delay Time to a Script (Example)

1. Select a button, and add **Flash** feedback as Event 1 (FIG. 26).

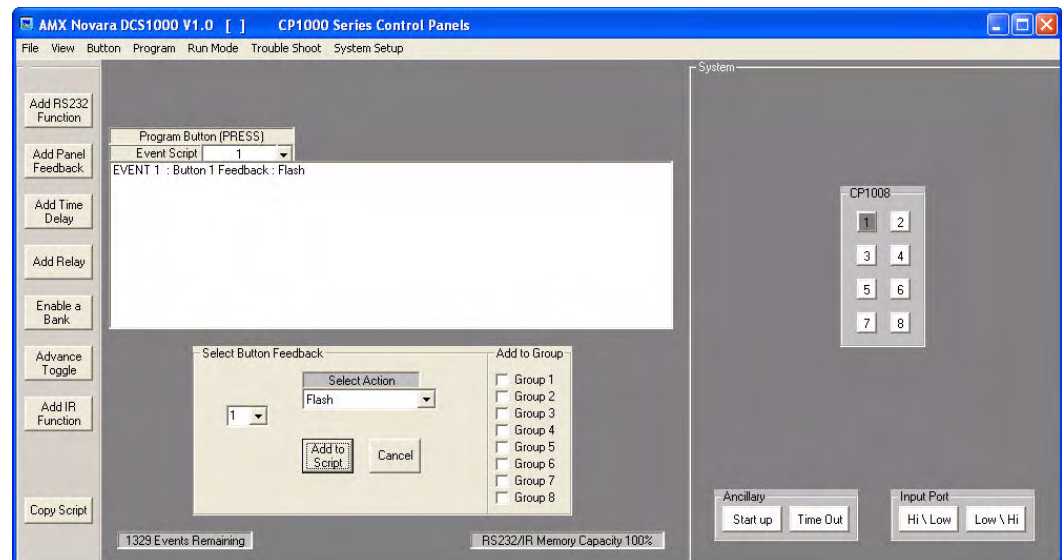

FIG. 26 Button 1 selected, "Flash" Button Feedback selected and added to Script as "Event 1"

2. Click **Add Time Delay** to invoke the *Set Time Delay* window (FIG. 27).



FIG. 27 Set Time Delay window

3. Use the left/right arrow buttons to specify a time period.
 - Click the arrows on the *Hours* field to adjust hours up/down, in one-hour increments.
 - Click the arrows on the *Minutes* field to adjust minutes up/down, in one-minute increments.
 - Click the arrows on the *Seconds* field to adjust seconds up/down, in one-half second increments.

For this example set the *Time Delay Between Events* period for 5 seconds (FIG. 28).



FIG. 28 Set Time Delay window - 5-second delay

4. Click **Add to Script** to add the Time Delay Between Events to the script, as **Event 2**.
5. Set the *Button Feedback* action to **On**, and add it to the script as **Event 3** (FIG. 29).

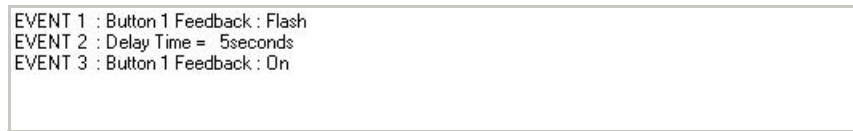

FIG. 29 Event Script window - Event 2 = Delay Time 5 seconds, Event 3 = Feedback On

6. Download the program (see the *Downloading the Program to the ControlPad* section on page 46).
7. Press the configured Button (in this case, Button #1).
8. The button will flash for 5 seconds, then stay On.

RS232 Functions

The ControlPad can be configured to output an RS232 command on a Button action.

All RS232 commands are contained in Library files.

Opening RS232 Library Files

1. Clear the program by selecting **File > New** from the menu bar.
2. Click the **Add RS232 Function** button in the Command Bar to invoke the *Select RS232 Function* window, indicating the currently selected RS232 Library (FIG. 30).

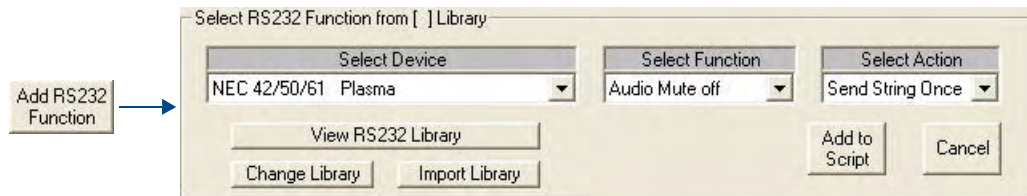

FIG. 30 Select RS232 Function window

If the Device to control is in a different RS232 Library, click the **Change Library** button and select the library to display (in the *Open* dialog).



NOTE

RS232 Library files use the file extension **PRR*.

Adding a RS232 Command to an Event

1. Select the device to control from the *Select Device* drop-down menu.
2. Select the desired function from the *Select Function* drop-down menu.
3. Select the desired action from the *Select Action* drop-down menu. Action options include:
 - **Send String Once** will send the command string one time only.
 - **Select Send No.** allows you to send a command up to 50 times.
Click the arrows on the *Select No. of Transmission Strings* field to specify the number of strings to send for this command.
Click the arrows on the *Select Delay Time between Strings* field to set a delay time between strings. (FIG. 31).

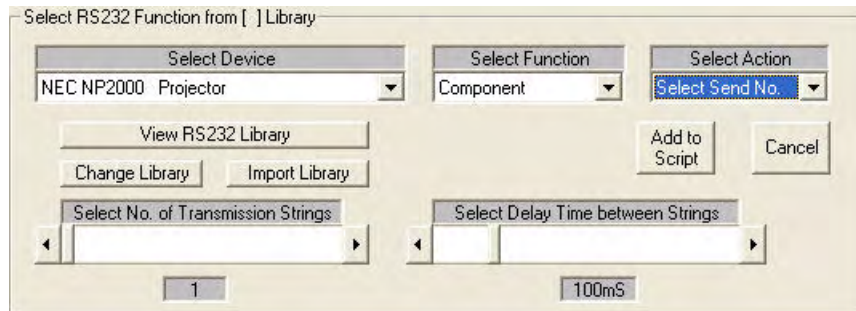

FIG. 31 Select RS232 Function window - Select Number of Strings/Delay Time between Strings

- **Send Continuous** sends continuous strings while a button is executed.
A delay time can be set between strings. This action is useful for Volume Up and Down commands. Setting a delay time of 150mS between strings gives a steady ramp up and down (FIG. 32).

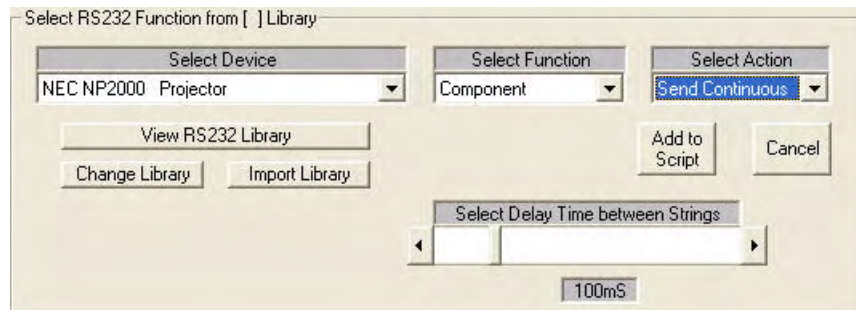

FIG. 32 Select RS232 Function window - Send Continuous/Delay Time between Strings

4. When the RS232 parameters have been set, click **Add to Script** to add this RS232 command to the script (FIG. 33).

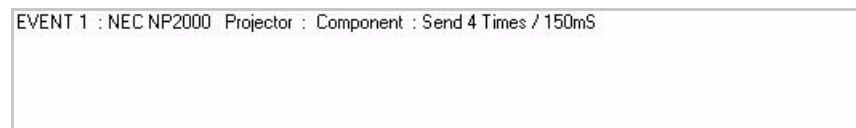

FIG. 33 Adding a RS232 Command to the Script

Viewing RS232 Libraries

To view the RS232 libraries, open the RS232 window then click the **View RS232 Library** button to open the *AMX RS232 Library* dialog (FIG. 34).

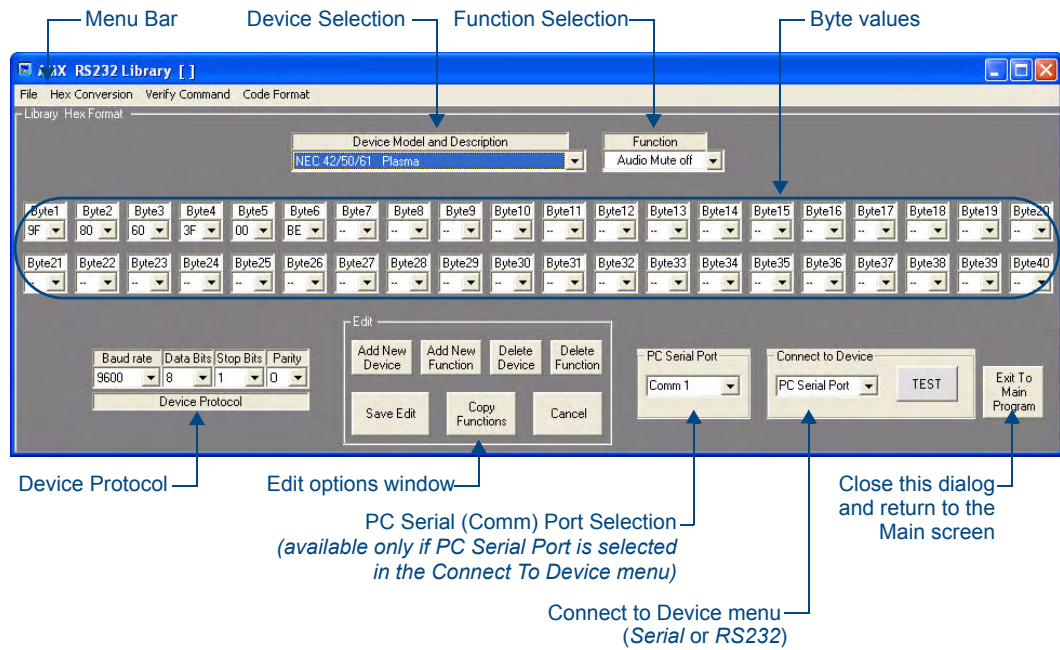

FIG. 34 AMX RS232 Library dialog

This dialog displays the currently selected RS232 Library contents

To view a functions' Protocol and string settings:

1. Select the device from the *Device Model and Description* drop-down menu
2. Select a function from the *Function* drop-down menu.

All the relevant information will be displayed.

- The *Device Protocol* can be changed by selecting new settings for **Baud rate**, **Data bits** and **Stop bits** from their respective drop-down menus.
- Command strings can be edited by changing Byte values via their individual drop-down menus (0-255).
- All Byte values are entered in Hex, Ascii or Decimal (selectable via the *Code Format* menu item).

When an edit is complete, click the **Save Edit** button to store the new values.

Adding a New Device To a RS232 Library

1. Click the **Add New Device** button in the *Edit* options (see FIG. 34) to invoke the *Add New Device* window (FIG. 35).

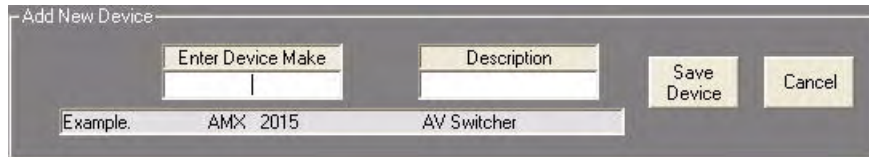

FIG. 35 AMX RS232 Library dialog - Add New Device window

2. Enter the *Device Make* and *Description*, then click **Save Device**. This opens a new *AMX RS232 Libraries* dialog for the new device (FIG. 36).

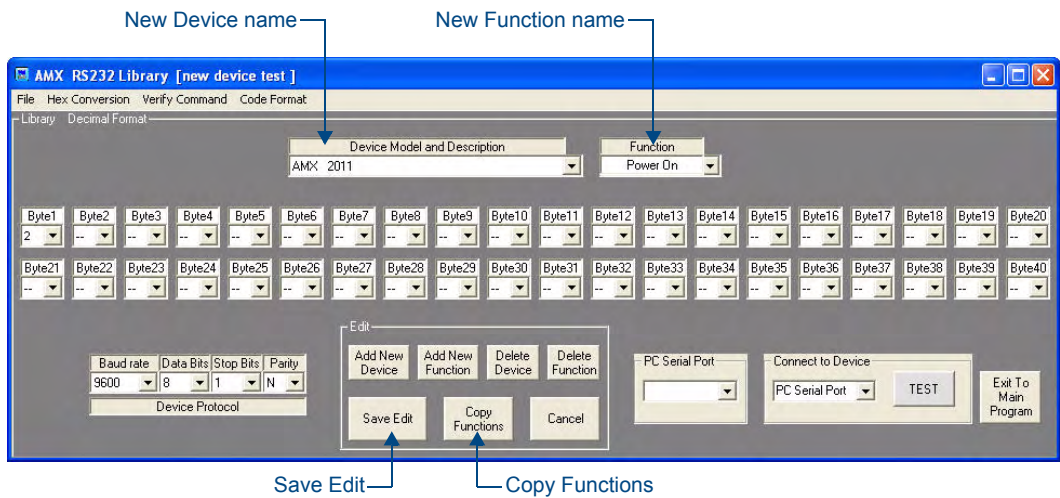

FIG. 36 AMX RS232 Library dialog (for a new device)

3. Enter a Function (in the *Enter Function* field).
4. Use the *Bytes* drop-down menus to enter the command string.
5. Specify the *Device Protocol* settings.
6. Click the **Save Edit** button (in the *Edit* options).

Adding a New RS232 Function to a Device

1. Click the **Add New Function** Command Bar button (see FIG. 30 on page 50). This opens the *AMX RS232 Libraries* dialog.
2. Select the relevant device, and fill in the function information as described above.
3. Click the **Save Function** button (in the *Edit* options) to save the new Function.

Copying RS232 Functions From an Existing Device to a New Device

1. Select the device to copy from then click on **Copy Functions** (in the *Edit* options - see FIG. 36). This invokes the *Add New Device* window (FIG. 37).

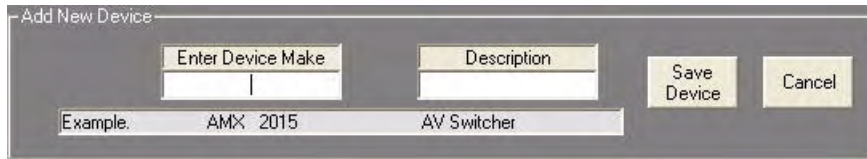

FIG. 37 AMX RS232 Library dialog - Add New Device window

2. Enter the *Device Make* and *Description*, then click **Save Device**.
3. This opens a new *AMX RS232 Libraries* dialog for the new device.
4. Edit the RS232 functions if necessary.



For easy finding of RS232 Functions it is recommended that groups of RS232 Libraries are made containing common Devices.

New RS232 Libraries can be created by clicking on New from the File Menu.

Save the Library using a relevant name, such as the equipment Brand name or Projector etc. Devices and Functions can be added to the Library as above.

Testing RS232 Functions

As a confidence check when editing or adding, a function can be tested by directly connecting the PC to the Device RS232 port or by testing directly through a panel port.

Select the PC serial port or panel port you are using from the *Connect To Device* drop-down menu.

Click the Test button.

The Device should then respond to the command sent.

Creating a Test Serial Cable

To connect to a Device to the PC a test cable can be made as follows:

PC Serial Port (female D9 connector) Pin 3 to Device (RX) / Pin 5 to Device (Gnd)

For testing through panel ports connect the Serial Programming Cable to the PC and to the panel's Program Port.

Verifying RS232 Commands

To check a command from a Panel Port use the *Verify RS232 Commands* dialog (FIG. 38).

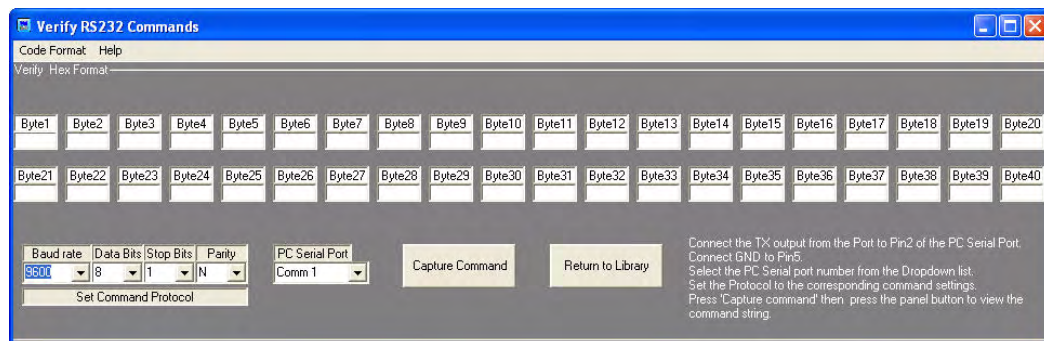

FIG. 38 Verify RS232 Commands dialog

1. In the *AMX RS232 Library* dialog's menu bar, select **Verify Command**, to invoke the *Verify RS232 Commands* dialog.
A cable will be required to connect the Panel port to the PC serial port. Connections are as follows:
 - Port TX to female D9 Pin 2
 - Port Gnd D9 Pin 5
2. From the *PC Serial Port* drop-down menu, select the PC serial port that the cable is connected to (*Comm 1 - Comm 8*).
3. In the *Set Command Protocol* window, set the **Baud rate**, **Data Bits** and **Stop bits** to match the command Protocol.
4. Click **Capture Command**.
5. Press the Panel button to transmit the command.

The captured string will appear in the Byte boxes. This should match the string in the Library.

IR Commands

The ControlPad can be configured to output an IR function on a Button action. All IR functions are contained within a Library.

Opening IR Library Files

1. Click the **Add IR Function** button in the Command Bar to invoke the *Select IR Function* window, indicating the currently selected IR Library (FIG. 30).

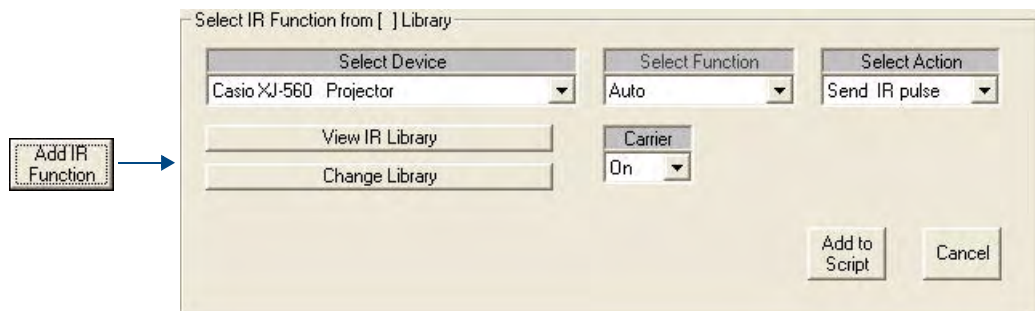

FIG. 39 Select IR Function window

If the Device to control is in a different IR Library, click the **Change Library** button and select the library to display (in the *Open* dialog).



NOTE

NOVARA IR Library files use the file extension *.PLR.

Adding an IR Command to an Event

1. Select the device to control from the *Select Device* drop-down menu.
2. Select the desired function from the *Select Function* drop-down menu.
3. Select the desired action from the *Select Action* drop-down menu. Action options include:
 - **Send IR Pulse** sends the IR function 4 times only.
 - **IR Pulse No.** allows you to send a function up to 120 times, selectable from a scroll bar.
 - **Send Continuous** sends continuous pulses while a button is executed. This action is useful for Volume Up and Down and Cursor functions.



When hard-wiring to a device the carrier may have to be turned off, refer to Manufacturers instructions, otherwise carrier must be left On.

- When the IR parameters have been set, click **Add to Script** to add this IR command to the script (FIG. 40).



FIG. 40 Adding an IR Command to the Script

AMX IR Libraries

To view the IR libraries, open the IR window then click the **View IR Library** button to open the *AMX IR Library* dialog (FIG. 41).

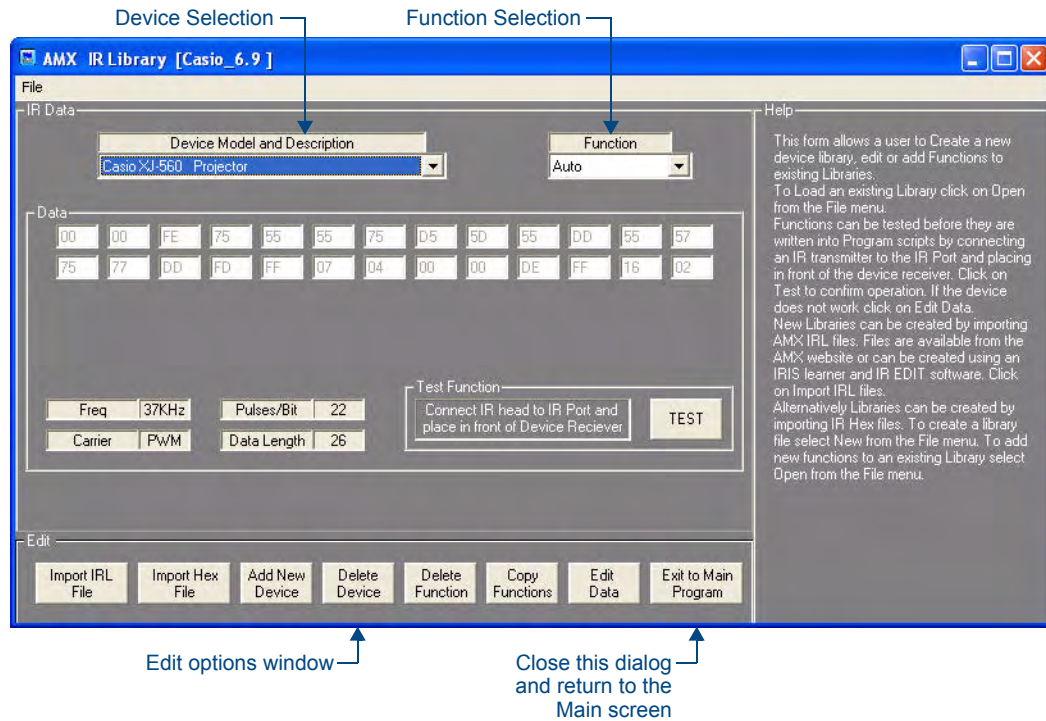

FIG. 41 AMX IR Library dialog

The options in this dialog allow you to create a new IR Device Library, as well as Edit or Add Functions to existing IR Libraries.

Loading an Existing IR Library

- Click **File > Open**. This invokes the Open dialog.
- Select an IR Library (Data) file.



NOVARA IR Library (Data) files use the file extension **PLR*.

It is recommended that all IR functions are tested before being written into program scripts (see the *Testing IR Functions* section on page 64).

Creating New IR Libraries

New IR Libraries can be created by importing AMX IR Library (IRL) files, by capturing IR functions via an IRIS IR Capture Unit, or by importing IR Hex files.

Importing AMX IR Library (IRL) Files

1. In the Edit Options window of the AMX Library Files dialog, click **Import IRL** (FIG. 42).

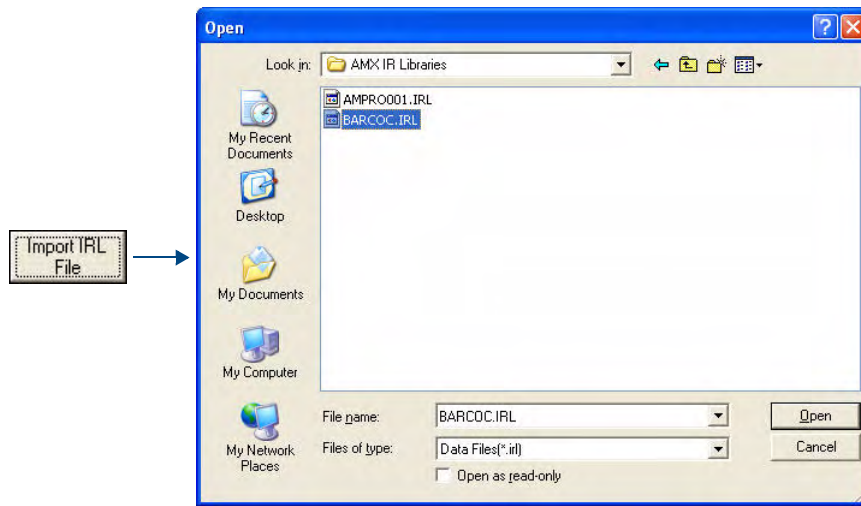

FIG. 42 Open dialog

2. In the Open dialog, select an IRL file, and click **Open**.
3. The selected IRL file is converted to the PLR format (FIG. 43).

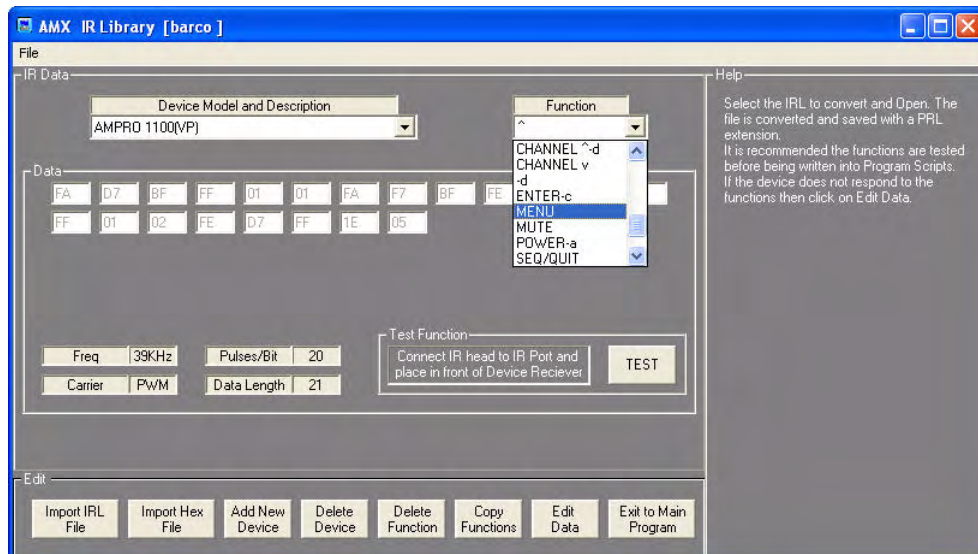

FIG. 43 AMX IR Library dialog - showing a converted IRL file

- The new file maintains the IRL name but with a PLR extension.
- Each IRL file only needs to be imported once.

Downloading IR Files From www.AMX.com

As a registered AMX Dealer, you can download AMX IR Library files directly from the *Partners* page of the www.amx.com website, as described below.



You must log into the website as a Dealer in order to access these files.

1. Click the **Partners** link at the top of the main www.amx.com website to access the *AMX Device Discovery Partners* page (FIG. 44).



FIG. 44 www.amx.com - AMX Device Discovery Partners page

2. In the menu on the left side of the page, click on **Search Devices** to access the *Search Devices* page (FIG. 45):

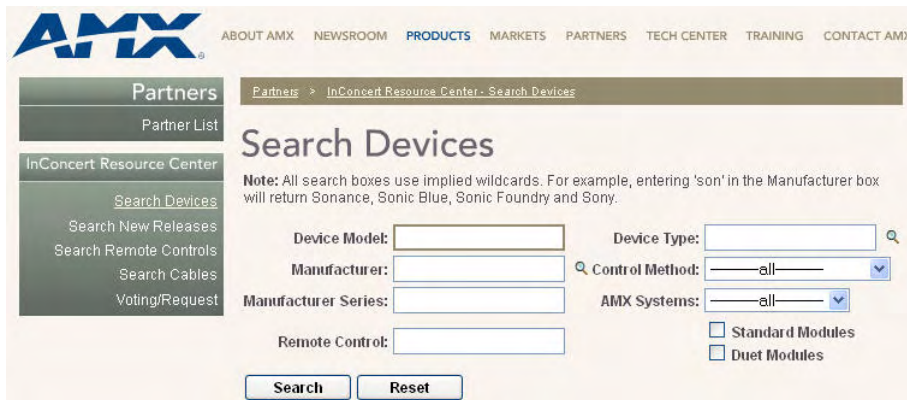

FIG. 45 www.amx.com - Search Devices page

3. Fill in the search fields with as much information as you can provide for the device for which you need an IR file.



All search boxes use implied wild cards. For example, entering 'son' in the *Manufacturer* box will return Sonance, Sonic Blue, Sonic Foundry and Sony.

- In the *Control Method* drop-down, select **IR** (FIG. 46).

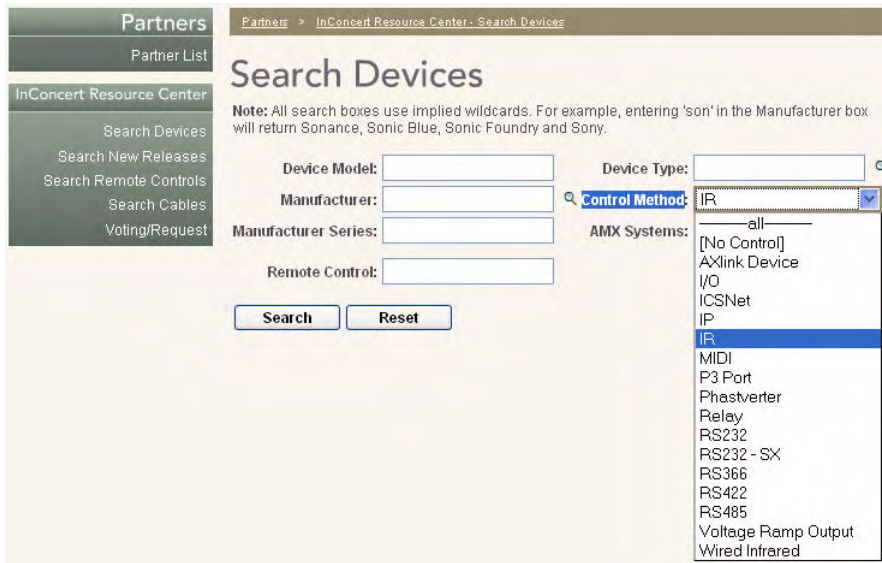

FIG. 46 Control Method drop-down menu

- Click **Search**. The results of the search are displayed (FIG. 47):

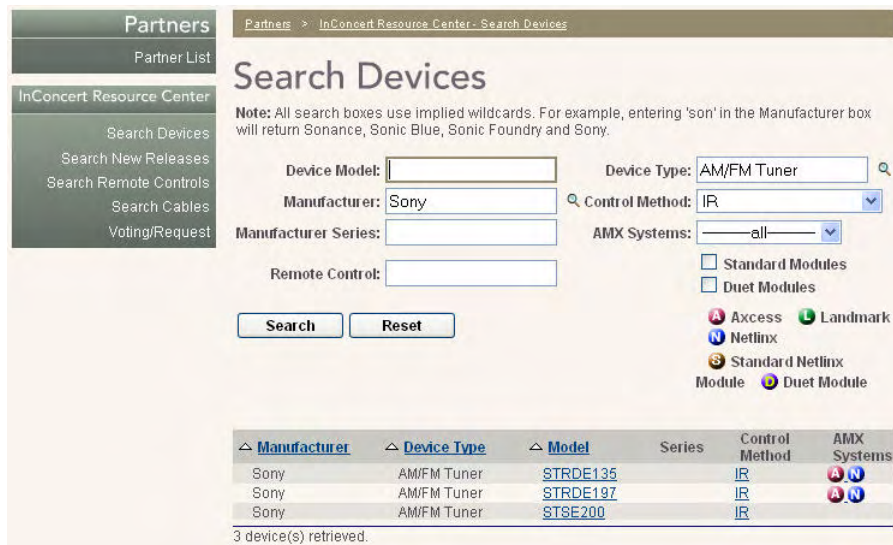

FIG. 47 Search results

- Click **IR** in the *Control Method* column of the search results list to access the *Device Model Details* dialog for the selected device (FIG. 48).

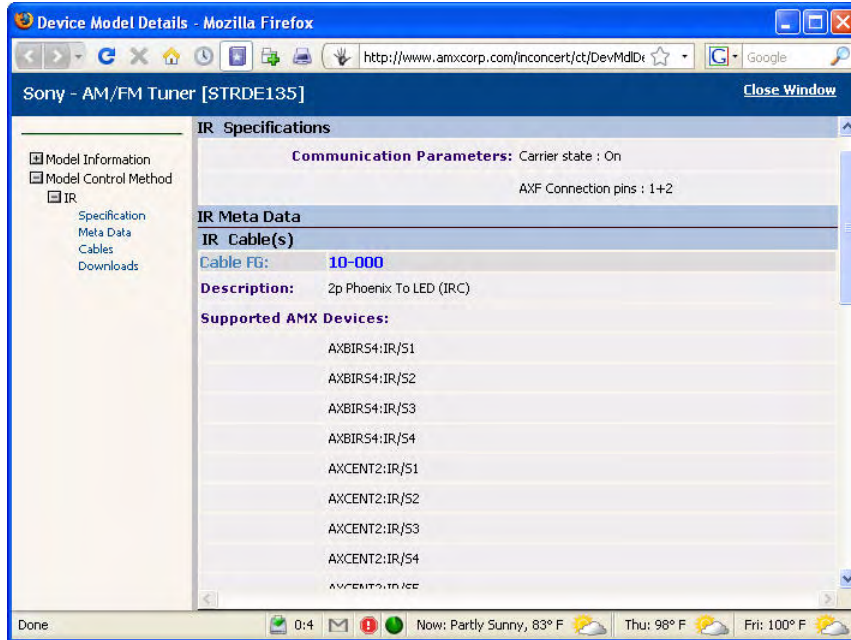

FIG. 48 Device Model Details dialog (IR Control Method)

7. In the left-hand menu bar under **Model Control Method > IR**, select **Downloads** to access the File(s) available for download for the selected device / control method (FIG. 49).

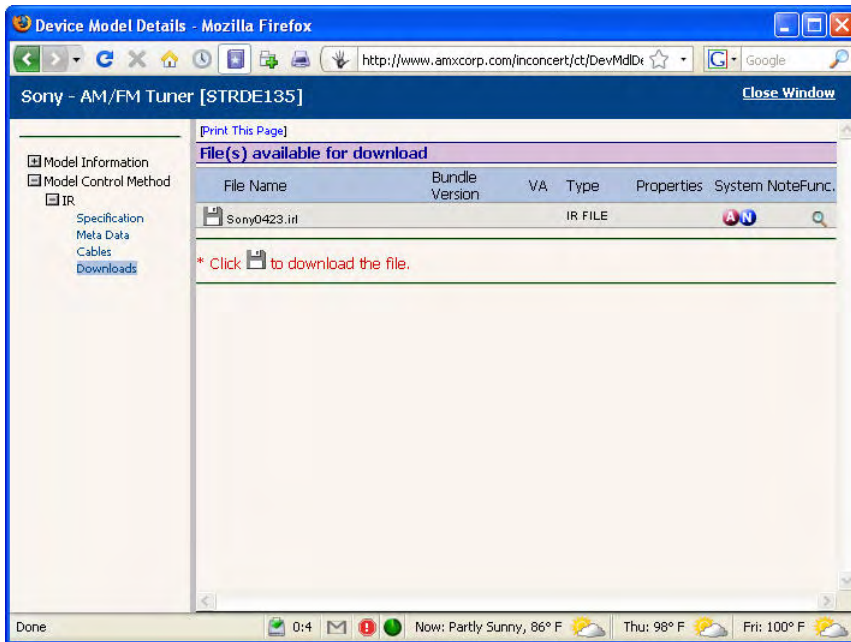

FIG. 49 Device Model Details dialog (Files Available for Download)

8. Click the file icon to download a file in the **File(s) available for download** list.

Creating New IR Libraries Using an IRIS IR/Serial Data Capture Device



The IRIS (FG5448) is a stand-alone, self-contained unit used to capture IR or wired function signals from a hand controller. Once captured and verified, the control functions are sent to a PC operating the IRLIB program. For details on using the IRIS, refer to the IRIS Operation/Reference Guide (available at www.amx.com).

To create new libraries using a manufacturers handset and an AMX IRIS Unit (FIG. 50):



FIG. 50 AMX IRIS IR Capture Unit

1. In the AMX IR Libraries dialog, select **File > New**.
2. In the Save As dialog, enter a name for the Library File and click **Save**.
3. In the AMX IR Libraries dialog, click **Add New Device** to invoke the *Add New Device* fields (FIG. 30):

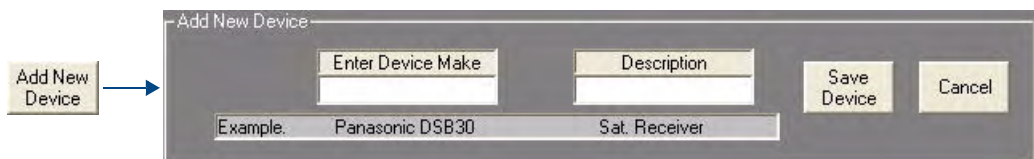

FIG. 51 AMX IR Library dialog - Add New Device fields

4. Enter the *Device Make* (model) and *Description*, and click **Save Device**.
5. Click on **Learn new function** to invoke the *Learn Function* fields (FIG. 52):

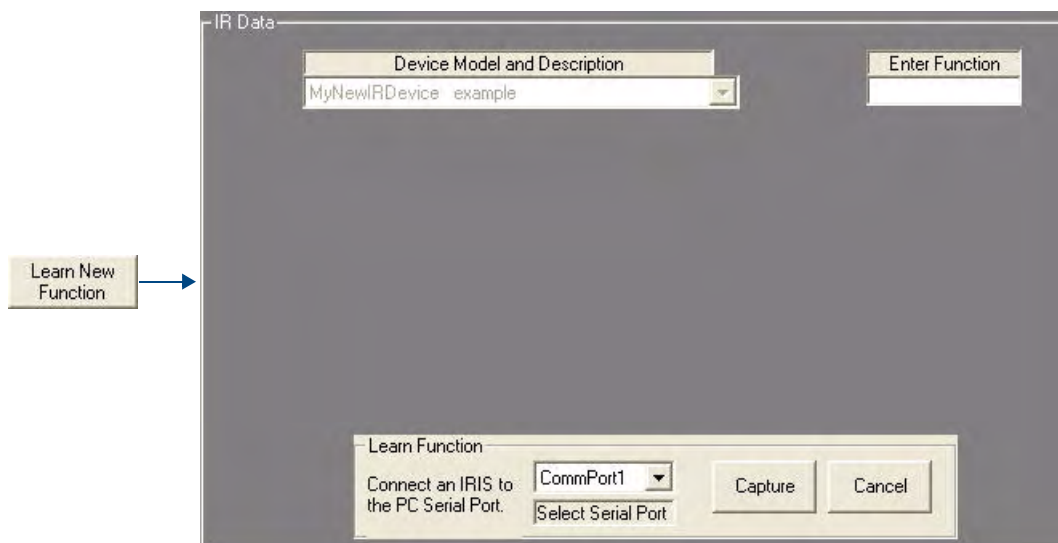

FIG. 52 AMX IR Library dialog - Learn New Functions fields

6. Connect the IRIS to your PC:
 - a. Connect an RS-232 cable to the DB-9 connector on the IRIS unit and an RS-232 port on your PC.
 - b. Set the baud rate in the IRIS unit to match the PC baud rate.

- c. Then, connect the 12 VDC or 12 VAC power supply to the 12 VDC connector on the IRIS unit.
- d. The READY LED lights and 01 appears in the display.
- 7. Enter a function name in the **Enter Function** text field.
- 8. Learn the code from the remote controller:
 - a. Hold the remote approximately 3-inches away from the IR capture window. Press and hold the first key on the HC to capture the first function. The SIGNAL LED will start blinking. Release the HC key as soon as the READY LED goes off.
 - b. The [] briefly appears in the display to indicate the HC function is captured. Then, 01 appears and the READY and VERIFY LEDs light. The LED will not light if P4 mode is active.
 - c. Hold the HC device approximately 3-inches away from the IR capture window. Press and hold the same key on the HC device again to verify the IR function was captured correctly by the IRIS unit. If the HC function is captured correctly, a pair of [] (brackets) will briefly flash in the display. The VERIFY LED goes off, 01 appears in the display, and the SEND pushbutton's LED lights. If an Er message appears in the display, repeat steps 3 and 5. Otherwise, go to step 6.
 - d. Press the SEND pushbutton to send the captured HC function to the PC running the IREdit software program.
 - e. Repeat steps C through E to capture all the HC functions on your list.
- 9. Click on Capture then press the Send button on the front panel of the IRIS. The function will be added to the current device library.

Refer to the *IREdit* instruction manual for information on to storing captured HC functions.

Importing IR HEX File Codes

Alternatively, IR Libraries can be created by importing IR HEX file codes.



AMX does not provide HEX codes, and therefore, cannot give any assurance that data provided by others is accurate or functional. There are a number of web sites that make IR HEX codes freely available. One such site is Remote Central, where you can search for your specific device and look for downloads with "text files with HEX codes".

1. In the Edit Options window of the AMX Library Files dialog, click **Import Hex File** to access the Hex data import and conversion options (FIG. 53).

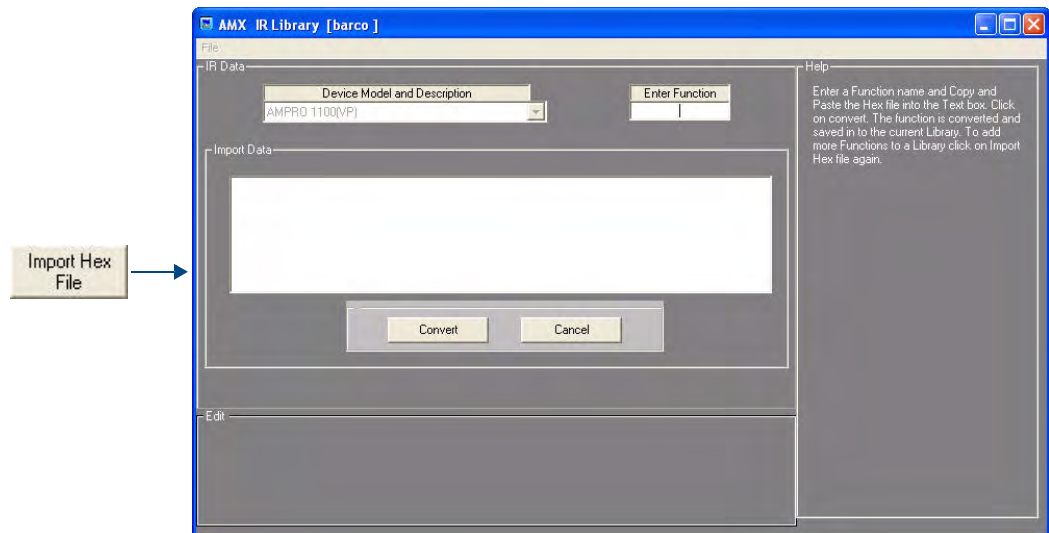

FIG. 53 AMX Library Files dialog - Hex data import and conversion options

2. Enter the name of the function that you want to import, in the *Enter Function* text field.

- Copy and paste the appropriate Hex code for this function in the *Import Data* text field (FIG. 54).

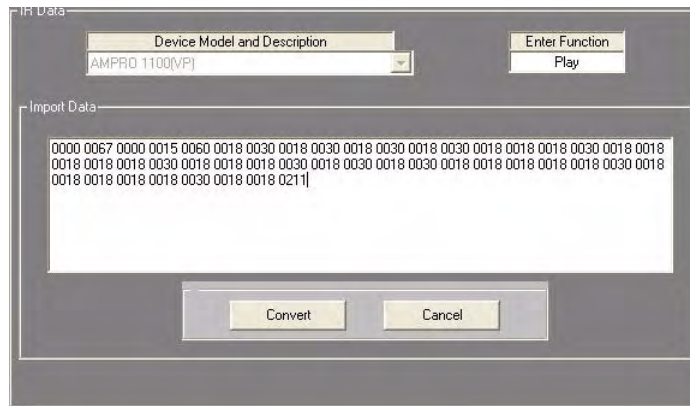

FIG. 54 AMX Library Files dialog - Hex data entered

- The data should be entered without any extra symbols.
 - No "double quotes" or <\$>, <0x>, or <0h> symbols are used to indicate HEX formatting.
- Click the **Convert** button to convert the Hex code and add it to the selected IR Library.
- It is recommended that all IR functions are tested before being written into program scripts (see the *Testing IR Functions* section on page 64).

Using IR HEX Codes To Create New IR Libraries

- In the AMX IR Libraries dialog, select **File > New**.
- In the Save As dialog, enter a name for the Library File and click **Save**.
- In the AMX IR Libraries dialog, click the **Add New Device** button to invoke the *Add New Device* fields (FIG. 55):

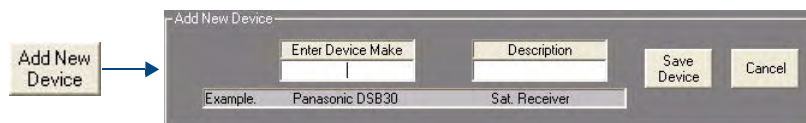

FIG. 55 AMX Library Files dialog - Add New Device fields

- Enter the Device model (*Make*) and *Description*, and click **Save Device**.
- In the Edit Options window of the AMX Library Files dialog, click **Import Hex File** to access the Hex data import and conversion options (FIG. 53).

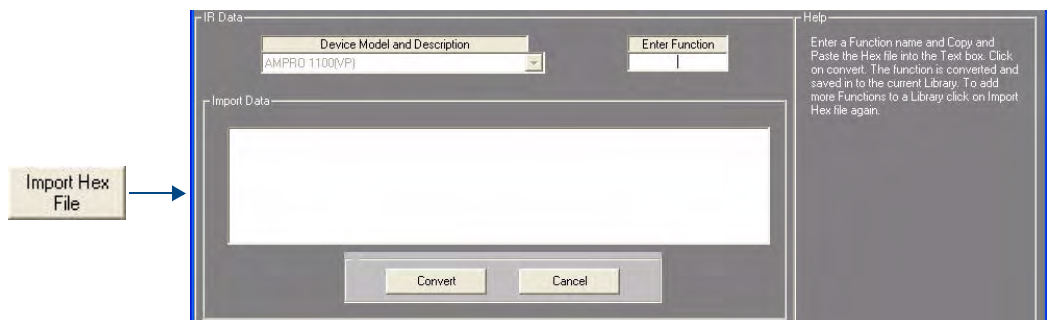

FIG. 56 AMX Library Files dialog - Hex data import and conversion options

- Enter the name of the function that you want to import, in the *Enter Function* text field.
- Copy and paste the appropriate Hex code for this function in the *Import Data* text field (see the *Importing IR HEX File Codes* section on page 62).

8. Click the **Convert** button to convert the Hex code and add it to the selected IR Library.

Testing IR Functions

It is recommended that all IR functions are tested before being written into program scripts:

1. In the AMX IR Libraries dialog, select the function to test from the *Function* drop-down menu (FIG. 57).

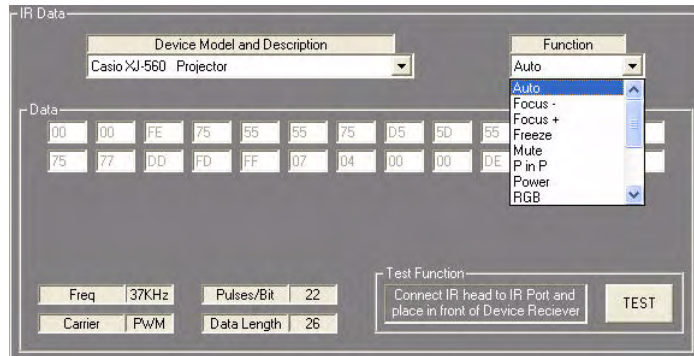

FIG. 57 AMX Library Files dialog - Selecting a Function for testing

2. Connect an IR Transmitter to the ControlPad’s IR Port, and place the IR Emitter directly in front of the device’s IR receiver.

3. Click the **TEST** button, and verify that the device responded appropriately.

If the device does not respond correctly, click the **Edit Data** button (in the Edit Options window) to access the IR Data for the selected function, to view and edit (FIG. 58):

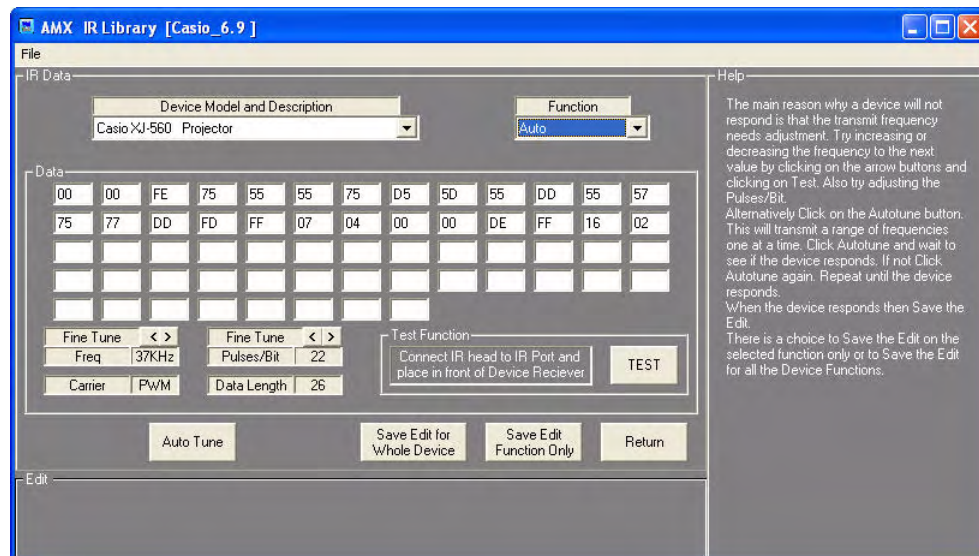

FIG. 58 AMX Library Files dialog - Edit IR Data

The main reason that a device will not respond is that the transmit frequency needs adjustment.

- Try increasing or decreasing the frequency to the next value by clicking on the **Fine Tune** arrow buttons. Also, try adjusting the Pulses/Bit value. Click on **TEST** to re-test the function (FIG. 59).

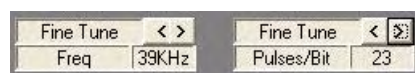

FIG. 59 AMX Library Files dialog - decreasing Frequency and Pulses/Bit values

Alternatively, use the *Auto Tune feature* to transmit a range of frequencies one at a time: Click **Auto Tune** and wait to see if the device responds. If not, click **Auto Tune** again. Repeat until the device responds. When the device responds, then Save the edit:

- Click **Save Edit For Whole Device** to save the edit for all of the Device Functions.
- Click **Save Edit Function Only** to save the edit on the selected function only.

Input Port Scripts

A script can be executed when a *High to Low* or *Low to High* state is detected on the Input Port. This is useful for external detection of a switch or PIR.

To write a script for the Input Port:

1. Click on either of the **Input Port** buttons in the System window (FIG. 60).



FIG. 60 Input Port buttons

2. Write a script as normal.

When the configured Input Port state is detected, the script will execute.

- If the ControlPad is busy when the state change occurs, the script will execute when the ControlPad is free.
- To return to the button list, select **Button > Press** from the menu bar.

Changing a Button Action

Button action can be changed via options in the **Button** menu (in the menu bar). Four options are available:

Press

A script is programmed for a button press.

Release

A script is programmed when a button is pressed then released.

Toggle

Up to four different scripts can be written for a button, using the *Toggle* option in the Button menu:

1. Choose a button to configure and select **Button > Toggle**. This invokes the *Toggle* window (FIG. 61):

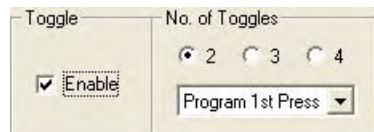

FIG. 61 Toggle window

2. Click on the **Enable** checkbox.
3. Select the number of toggle presses required for the button (2, 3 or 4).
4. Note that initially the Toggle window is set to configure the first press of the button. Program the script as normal for the first button press.
5. Next select **Program 2nd Press** from the drop-down menu.
6. Program the script for the second press.
7. Continue for each required button press.

When the panel is configured, the button will toggle on each button press, then loop to 1st press.

Bank Assign

A button can be assigned to one of three banks X, Y or Z. Each bank can have up to four different functions. This is useful if you have a common set of functions.

For example. You could have a single 'Play' button controlling up to four different devices (e.g. DVD, VCR, CD, MP3 player etc). To achieve this the button must be Bank Assigned.

1. Choose **Button 1** to configure (in the *System window*), and select **Button> Bank Assign**. This invokes the *Assign to Bank* window (FIG. 62):

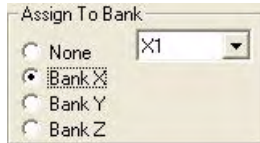

FIG. 62 Assign to Bank window

2. Select **Bank X**. Bank **X1** appears as default.
3. Write a script for Bank **X1** (e.g. DVD play - FIG. 63).

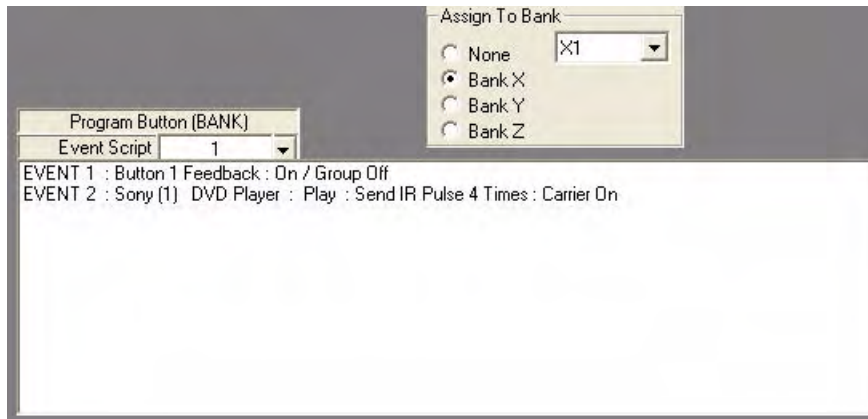

FIG. 63 Script for Bank X1 (DVD Play)

4. Select **X2** from the *Assign To Bank* drop-down menu and write a script (e.g. VCR play - FIG. 64).

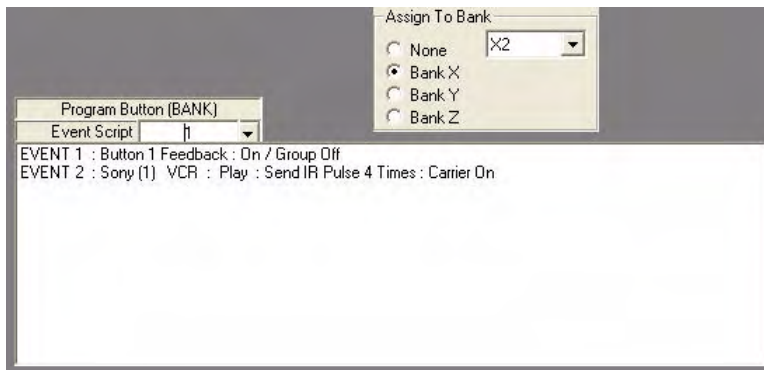

FIG. 64 Script for Bank X2 (VCR Play)

5. Select **X3** from the *Assign To Bank* drop-down menu and write a script for a CD player (FIG. 65).

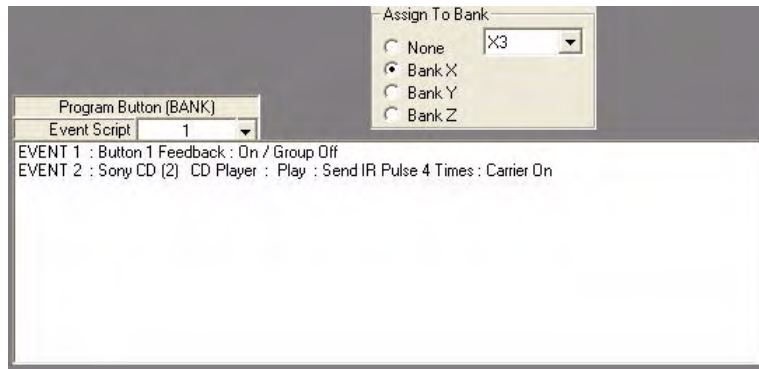

FIG. 65 Script for Bank X3 (CD Play)

6. Select **X4** from the *Assign To Bank* drop-down menu and write a script for a tuner (FIG. 66).

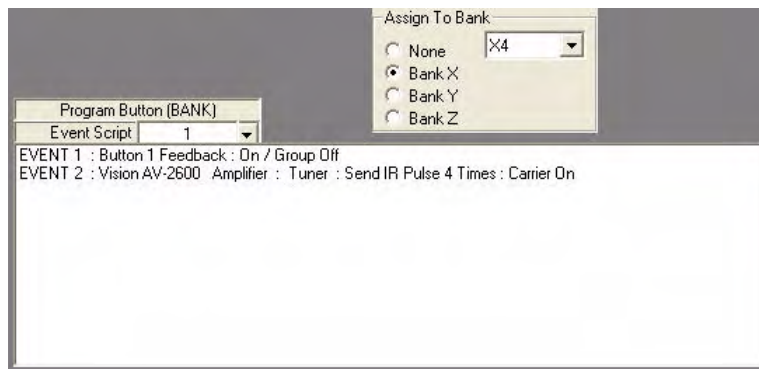

FIG. 66 Script for Bank X4 (Tuner On)

7. Select Button 2 (in the *System window*), and follow the above procedures writing 'Stop' scripts for bank levels X1 to X3 and a Tuner Off command for Bank X4.

To activate the Bank Levels the 'Bank Enable' function must be used (see below).

Bank Enable

This function is used to activate Bank levels on buttons that have been Bank Assigned.

Following the preceding Bank Assign example:

1. Select Button 5 (in the *System window*) to program. This would be the DVD select button.
2. Click the **Enable a Bank** command button to display the *Bank Enable* options (FIG. 67):

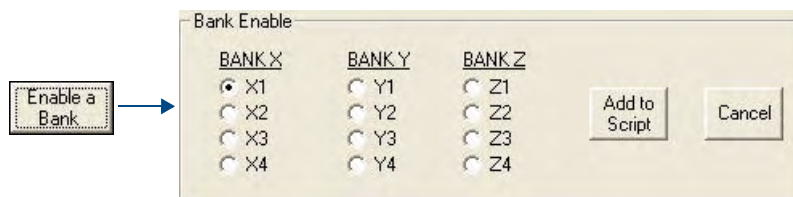

FIG. 67 Displaying the Bank Enable options

- Write a script for Button 5 and include Bank Enable **X1** (FIG. 68).

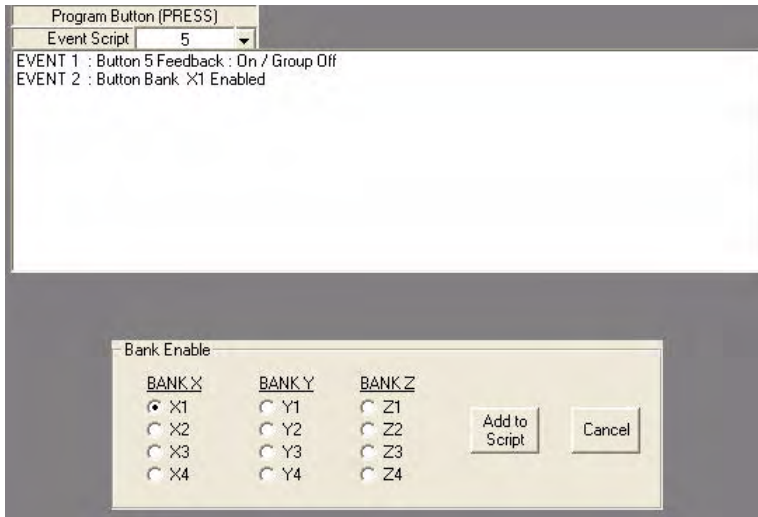

FIG. 68 Button 5 script, with Enable X1 Bank selected

- Select Button 6 (in the *System window*) to program. This would be the VCR select button.
- Write a Script for Button 6 and include Enable Bank **X2** (FIG. 69).

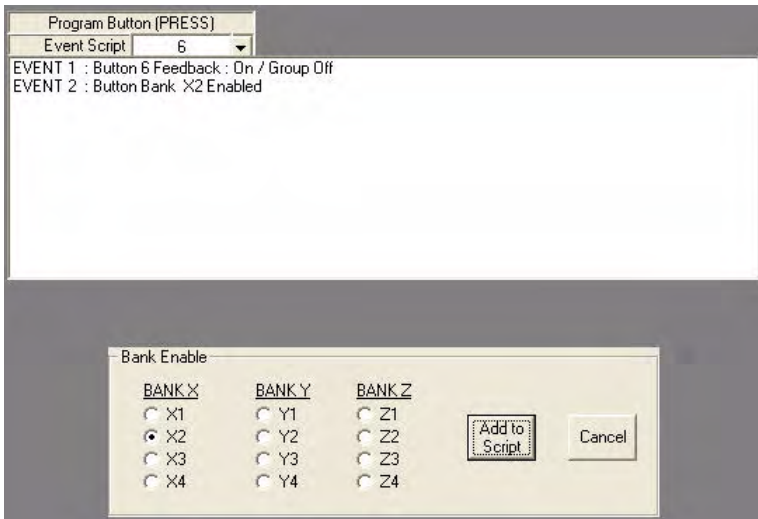

FIG. 69 Button 6 script, with Enable X2 Bank selected

- Select button 7 which would be the CD select button.

- Write a script and include Enable Bank X3 (FIG. 70).

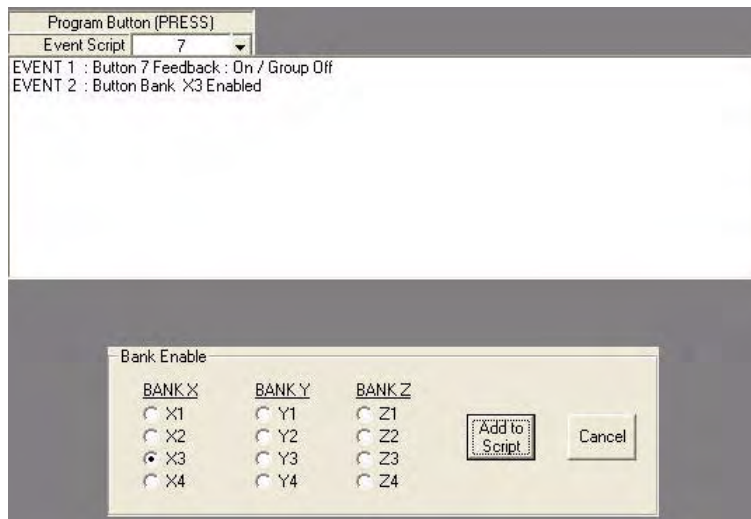

FIG. 70 Button 7 script, with Enable X3 Bank selected

- Select button 8 (in the *System window*) to program.
- Write a script for the Tuner select button including enable Bank X4 in the script (FIG. 71).

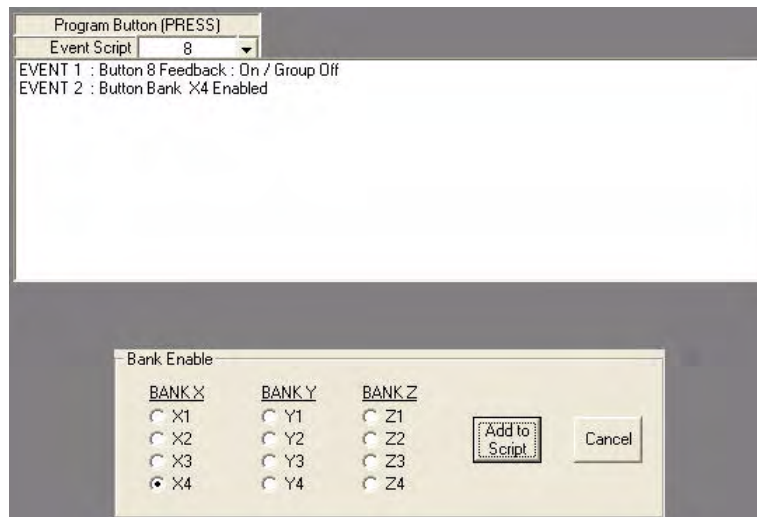

FIG. 71 Button 8 script, with Enable X4 Bank selected

The controlpad will now act in the following way.

When Button 5 is pressed this will activate Bank X1.

This means that whenever any button is pressed that is Bank X assigned the X1 script will run. So for our example, If button 1 is pressed the DVD Play script will run. If button 2 is pressed the DVD Stop script will run.

Now if Button 6 is pressed Bank X2 will activate so now if button 1 or 2 is pressed the VCR Play\Stop scripts will run.

Button 7 will activate Bank X3 and Button 8 will activate Bank X4 hence allowing control of a CD Player or Tuner.

There are 3 Banks X,Y or Z so for example Bank X could be used for a group of buttons with common Transport functions, Bank Y used for Common Menu functions etc.

Using Bank Assign to Control Two Projectors - Example

The following example illustrates using Bank Assign to control two Sony projectors using Volume Up/Down buttons:

1. Select **Button 1** to configure (FIG. 72):



FIG. 72 Button 1 - selected to configure

2. In the menu bar, select **Button > Bank assign**. This invokes the *Bank Assign* options (FIG. 73):

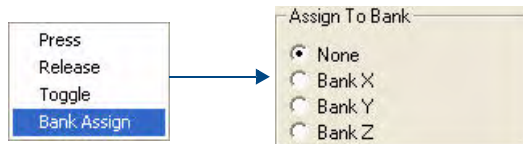

FIG. 73 Button > Bank assign

3. Select **Bank X** to enable the button press drop-down menu.
4. Select **X1** from the Button Press drop-down menu (FIG. 74):

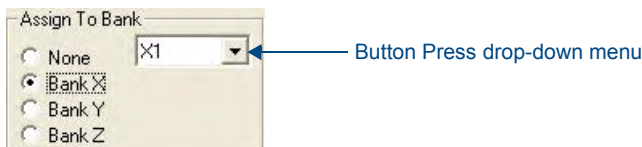

FIG. 74 Assign to Bank X, X1 selected

5. Click the **Add IR Function** button in the Command Bar.
6. Select the appropriate IR Library for the device manufacturer (via the **Change Library** button), and select the desired device (from the *Select Device* drop-down menu). In this example, we'll select the Sony PX32 Projector.
7. Choose the "Volume Down" command (in the *Select Function* drop-down menu) and click **Add To Script** to add it to the Event Script (FIG. 75):

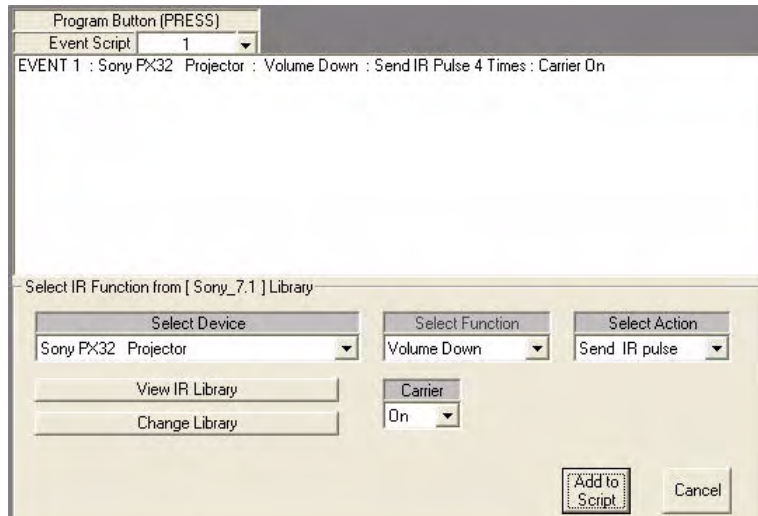

FIG. 75 Button 1 - Add Sony PX32 Projector "Volume Down" Command to Script

8. Select **X2** from the drop-down menu in the *Assign to Bank* window.
9. Click **Add RS232 Function** in the Command Bar.
10. Select the appropriate RS232 Library for the device manufacturer (via the **Change Library** button), and select the desired device (from the *Select Device* drop-down menu).
In this example, we'll select the Sony VPL PX11 LCD Projector.
11. Choose the "Volume Down" command (in the *Select Function* drop-down menu) and click **Add To Script** to add it to the Event Script (FIG. 76):

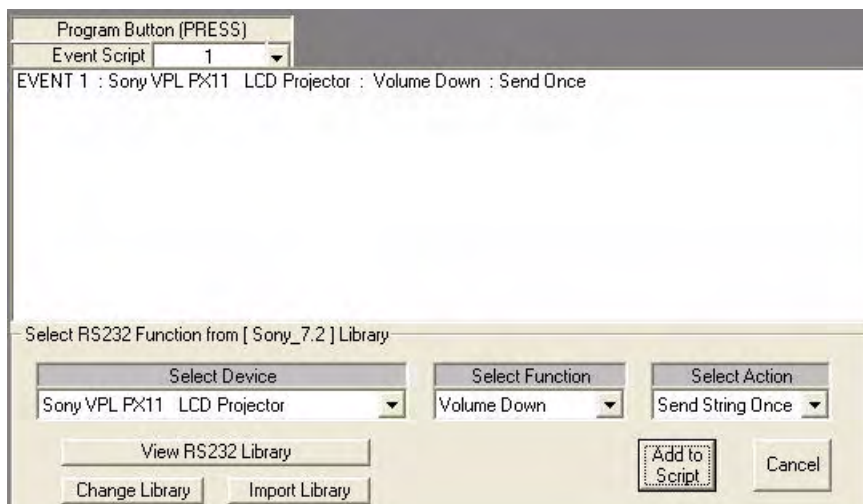

FIG. 76 Button 1 - Add Sony VPL PX11 LCD Projector "Volume Down" Command to Script

12. Select **Button 2** to configure. Repeat as above using Sony PX32 Projector and Sony VPL PX11 LCD Projector *Volume Up* commands.

13. Select **Button 3** to configure (FIG. 77).



FIG. 77 Button 3 selected to configure

14. Click **Enable a Bank** in the Command Bar; select **X1** and **Add to Script** (FIG. 78).

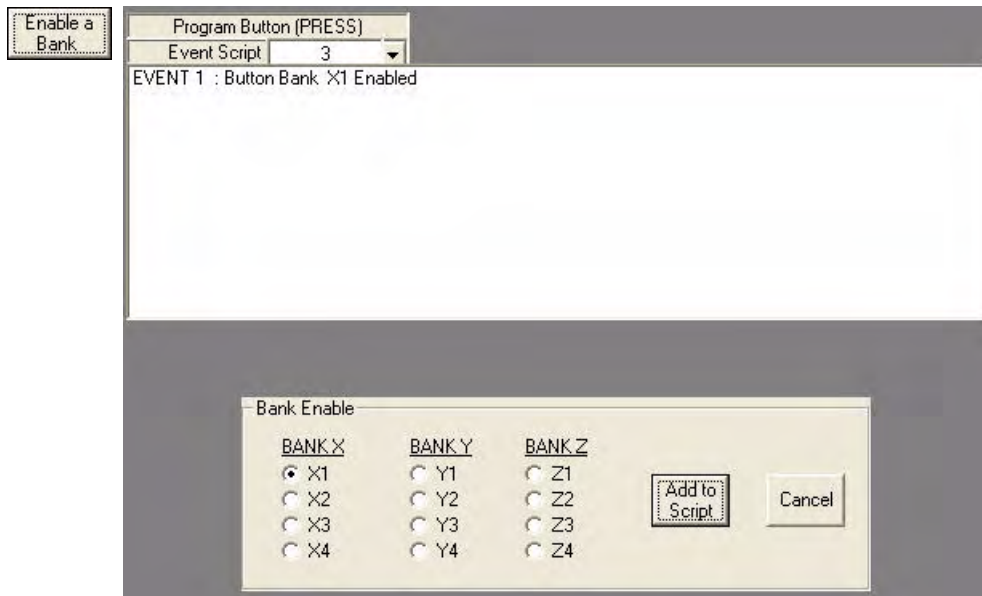

FIG. 78 Button 3 - Button Bank X1 Enabled

15. Select **Button 4** to configure (FIG. 79):



FIG. 79 Button 4 selected to configure

16. Click on **Enable a Bank** in the Command Bar; select **X2** and **Add to Script** (FIG. 80).

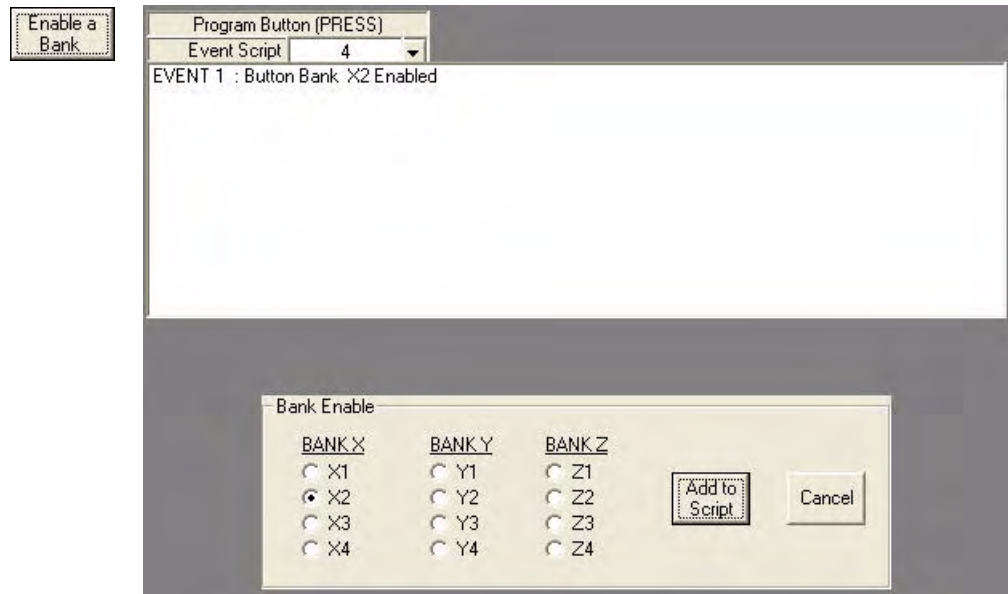

FIG. 80 Button 4 - Button Bank X2 Enabled

17. Download the program to the ControlPad (via the **Program** menu bar item).

- When Button 3 is pressed Buttons 1 and 2 will operate Volume Up/Down on the Sony PX32 Projector.
- When Button 4 is pressed Buttons 1 and 2 will operate Volume Up/Down on the Sony VPL PX11 LCD Projector.

Advance Toggle

The **Advance Toggle** feature allows a button to skip toggles.

For example, a button is configured to toggle a Device on and off, and the first press turns the Device on.

If the Device is also turned off by a Time Out function, then pressing the button a 2nd time will have no effect as the Device is already off.

- By programming an *Advance to Press 1* in the Time Out script, the Toggle button will then be set to switch the Device on again on the next press.

1. Click the **Advance Toggle** button in the Command Bar to open the *Advance Toggle* window (FIG. 81).

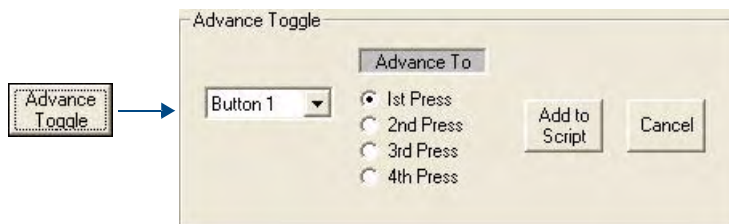

FIG. 81 Advance Toggle window

2. Select the Toggle button from the drop-down menu, and click on the Press number to advance to (*1st, 2nd, 3rd or 4th press*).

Copy and Paste

To Copy and Paste a Script:

1. Click on the **Copy Script** button in the Command Bar to invoke the *Copy and Paste* window, displaying the current button script (FIG. 82):

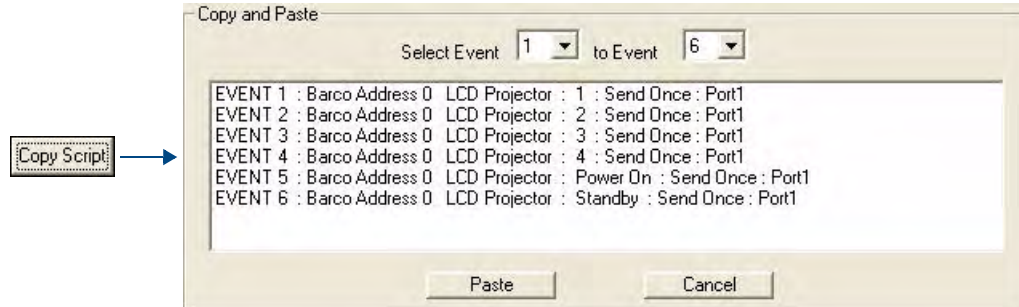

FIG. 82 Copy and Paste window



NOTE

The Script can be trimmed using the Select Event controls.

2. In the *System* window, select the button to copy to, and click **Paste**.
 - The copied events will be added to the new button script.
 - The paste window can be used to copy scripts to New and existing programs.

Start Up

A script can be written for button events to execute when the ControlPad is powered up:

1. From the *Ancillary* options (in the *System* window), select **Start Up** (FIG. 83):

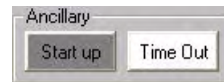

FIG. 83 Ancillary options - Start Up

2. This invokes the *Program Start Up Events (Event Script)* window (FIG. 84):

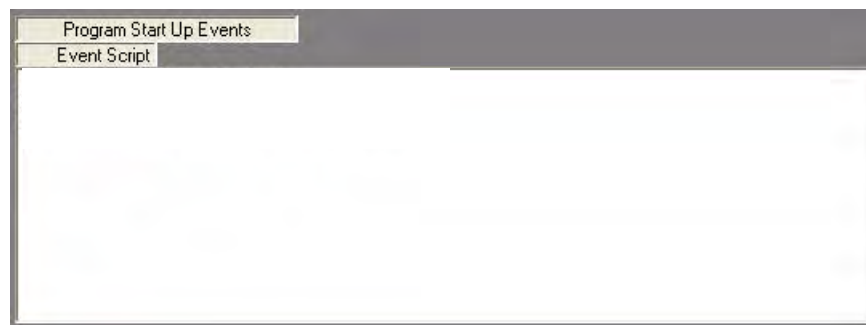

FIG. 84 Program Start Up Events (Event Script) window

3. Add commands to the Event Script to define the functions that you want the ControlPad to perform on startup (FIG. 86).
 - a. Select a button action from the *Select Action* drop-down menu (FIG. 85):

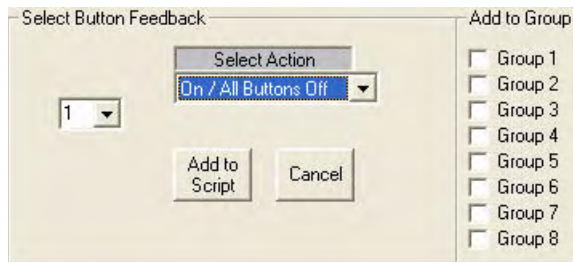

FIG. 85 Select Button Feedback - Select Action

- b. Click **Add To Script** to add the selected button action to the Start Up (Event) script.
 - c. Add other button actions as desired to the Start Up (Event) script (FIG. 86).

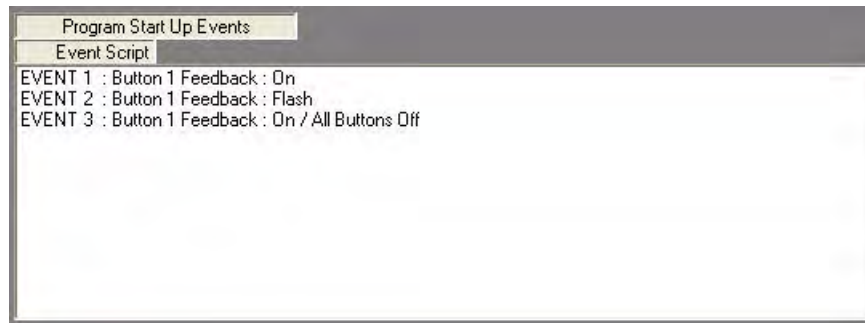

FIG. 86 Program Start Up Event Script

Time Out

A Script can be written to execute if a button press is not detected within a set time period. For example, switching equipment off that may have been left running overnight.

Three time periods can be set:

1. From the *Ancillary* options (in the *System* window), select **Time Out** (FIG. 87):

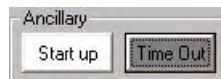

FIG. 87 Ancillary options - Time Out

2. This invokes the *Time Out* window (FIG. 88):

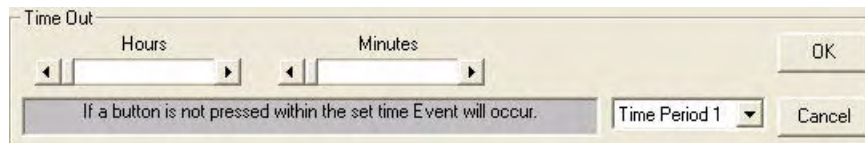

FIG. 88 Time Out window

3. Use the arrows on the *Hours* and *Minutes* fields to set a time for **Time Period 1**.
4. Write a script, as usual.

When the panel is configured and a button press is not detected within the time period then the script will execute.

- A 2nd period can be set to occur after the 1st period has elapsed. Again if a button press has still not occurred within that time then the 2nd period script will execute.
- A 3rd period can be set to occur after the 2nd period has elapsed. If a button press is detected at any time then the internal clock will be reset back to detect for a button press during the 1st period.

File Menu

The file menu gives the option to Save and Open program files.

- To clear the program for writing new programs click on 'New'
- Clicking on 'Print Script' will print out a hard copy of the Script.

Run Mode

There are two modes of operation, selectable via the **Run Mode** menu item:

- **Manual Mode** – normal configuration mode.
- **Auto-Run** – events in a script will start running 5 seconds after switch on.
Up to 1330 events can be programmed in a script and can be continually looped.
From the Run Mode menu select **Auto-Run** then **Continue**.
Write the script then click on **Loop** if you want the script to continually run.



NOTE

Changing Run Mode will erase all Manual Run events.

Downloading the Program

When a program has been written it can then be downloaded to the ControlPad:

1. Select **Program > Download** from the menu bar.
2. The application will prompt you to connect the USB Programming Cable to a USB port on your PC and the ControlPad's Program port (FIG. 89):

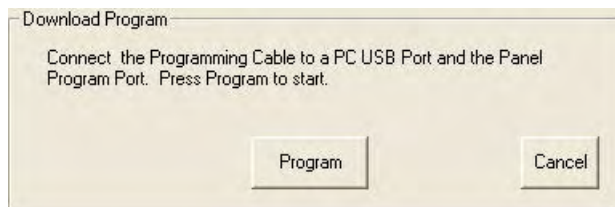

FIG. 89 Download Program window

3. Click **Program**. The programming window will appear.
 - All the buttons on the Panel will illuminate and the program will download.
 - When the download has completed the buttons will dim and a message will appear 'Download Complete'.

If an error occurs check the following:

- Cable is correctly connected
- Shut down any other programs running on the PC.
- If problem persists power down the Panel, hold in buttons 2 and 6 and re-power. Buttons 1 to 8 will illuminate. Release buttons 2 and 6 and download program.

Downloading To an Auto-running panel

To configure a panel that is currently Auto-running, the panel must be powered down and the program Downloaded within the first five seconds of power up before the panel starts auto-running again.

Adding a Relay Unit

1. Connect the relay unit to the Relay port on the ControlPad (see the *Relay 1 / Relay 2 Connectors* section on page 10).
2. Click the **Add Relay** button in the Command Bar to invoke the *Select Relay* window (FIG. 90).

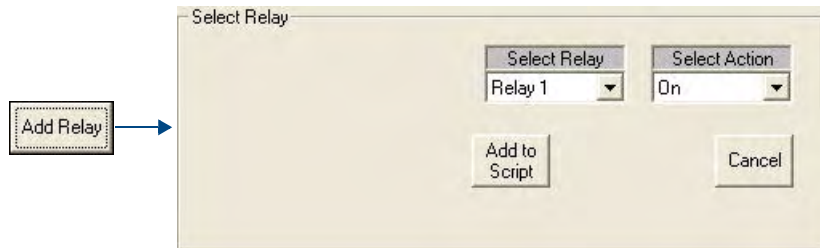

FIG. 90 Select Relay window

3. Select the relay to control from the *Select Relay* drop-down menu (*Relay 1* or *Relay 2*).
4. Select the relay action type from the *Select Action* drop-down menu.
 - **On** will latch the relay on,
 - **Off** will latch the relay off.
5. When the parameters have been set click on **Add to Script**.

NOVARA RS232 Codes

RS232 Protocol

- 9600
- n
- 8
- 1

RS232 Press/Release Codes

NOVARA RS232 Press/Release Codes		
Button Number	Press Code	Release Code
1	F2 09 81 10 01	F2 09 81 01
2	F2 09 81 10 02	F2 09 81 02
3	F2 09 81 10 03	F2 09 81 03
4	F2 09 81 10 04	F2 09 81 04
5	F2 09 81 10 05	F2 09 81 05
6	F2 09 81 10 06	F2 09 81 06
7	F2 09 81 10 07	F2 09 81 07
8	F2 09 81 10 08	F2 09 81 08
9	F2 09 81 20 09	F2 09 81 09
10	F2 09 81 20 0A	F2 09 81 0A
11	F2 09 81 20 0B	F2 09 81 0B
12	F2 09 81 20 0C	F2 09 81 0C
13	F2 09 81 20 0D	F2 09 81 0D
14	F2 09 81 20 0E	F2 09 81 0E
15	F2 09 81 20 0F	F2 09 81 0F
16	F2 09 81 20 10	F2 09 81 10
17	F2 09 81 40 11	F2 09 81 11
18	F2 09 81 40 12	F2 09 81 12
19	F2 09 81 40 13	F2 09 81 13
20	F2 09 81 40 14	F2 09 81 14
21	F2 09 81 40 15	F2 09 81 15
22	F2 09 81 40 16	F2 09 81 16
23	F2 09 81 40 17	F2 09 81 17
24	F2 09 81 40 18	F2 09 81 18
25	F2 09 81 80 19	F2 09 81 19
26	F2 09 81 80 1A	F2 09 81 1A
27	F2 09 81 80 1B	F2 09 81 1B
28	F2 09 81 80 1C	F2 09 81 1C
29	F2 09 81 80 1D	F2 09 81 1D
30	F2 09 81 80 1E	F2 09 81 1E
31	F2 09 81 80 1F	F2 09 81 1F
32	F2 09 81 80 20	F2 09 81 20

RS232 Function Codes

NOVARA RS232 Function Codes	
Command	Function
BL=xx	Set Backlight level • xx = 00-99
MB=xx	Set Max Brightness • xx = 00-99
FR=xx	Set Flash Rate • xx = 00-99
PR=xx	Set Pulse Rate • xx = 00-99 • Note: Adjusting the pulse rate sets the rise and fall time within the flash rate, to be effective, both may need to be adjusted. AMX recommends leaving as default values.
SLnn=a	Set LED State • nn = Button number (01-32), 00 = All • a = LED state (1 – Low, 2 – High, 3 – Flash, 4 – Off, 5 – Pulse)
SLGbbbb=a	Set LED Group • bbbb = 32 bits, 1 bit per LED (1 change, 0 leave) • a = LED state (1 – Low, 2 – High, 3 – Flash, 4 – Off, 5 – Pulse)
	Update firmware
SRQ	Request Status • Returns 32 bytes of LED button status (byte 1 = LED 1 etc)
IRQ	Request Setup Info • Returns 7 bytes (Byte 1 = Backlight level, 2 = Max brightness level, 3 = Flash rate, 4 = Pulse rate, 5 = orientation, 0=Vertical, 1=Horizontal) • Bytes 6&7 are the firmware version installed where values of 1 and 0 mean firmware version 1.0
SETHZ	Set Horizontal Layout
SETVT	Set Vertical Layout



It's Your World - Take Control™

3000 RESEARCH DRIVE, RICHARDSON, TX 75082 USA • 800.222.0193 • 469.624.8000 • 469-624-7153 fax • 800.932.6993 technical support • www.amx.com

10/08 ©2008 AMX. All rights reserved. AMX and the AMX logo are registered trademarks of AMX. AMX reserves the right to alter specifications without notice at any time.