



# **Agilent 82350B PCI GPIB Interface**

## **Installation and Configuration Guide**



Agilent Technologies

# Notices

© Agilent Technologies, Inc. 2002 - 2009

No part of this manual may be reproduced in any form or by any means (including electronic storage and retrieval or translation into a foreign language) without prior agreement and written consent from Agilent Technologies, Inc. as governed by United States and international copyright laws.

## Manual Part Number

82350-90004

## Edition

Eighth Edition, July 20, 2009

Printed in Malaysia

Agilent Technologies, Inc.  
3501 Stevens Creek Blvd.  
Santa Clara, CA 95052 USA

Microsoft is a U.S. registered trademark of Microsoft Corporation.

“PCI-SIG” and the PCI SIG design marks are registered trademarks and/or service marks of PCI-SIG.

FireWire is a registered trademark of Apple Computer, Inc.

## Warranty

**The material contained in this document is provided “as is,” and is subject to being changed, without notice, in future editions. Further, to the maximum extent permitted by applicable law, Agilent disclaims all warranties, either express or implied, with regard to this manual and any information contained herein, including but not limited to the implied warranties of merchantability and fitness for a particular purpose. Agilent shall not be liable for errors or for incidental or consequential damages in connection with the furnishing, use, or performance of this document or of any information contained herein. Should Agilent and the user have a separate written agreement with warranty terms covering the material in this document that conflict with these terms, the warranty terms in the separate agreement shall control.**

## Technology Licenses

The hardware and/or software described in this document are furnished under a license and may be used or copied only in accordance with the terms of such license.

## Restricted Rights Legend

U.S. Government Restricted Rights. Software and technical data rights granted to the federal government include only those rights customarily provided to end user customers. Agilent provides this customary commercial license in Software and technical data pursuant to FAR 12.211 (Technical Data) and 12.212 (Computer Software) and, for the Department of Defense, DFARS 252.227-7015 (Technical Data - Commercial Items) and DFARS 227.7202-3 (Rights in Commercial Computer Software or Computer Software Documentation).

## Safety Notices

**CAUTION**

A **CAUTION** notice denotes a hazard. It calls attention to an operating procedure, practice, or the like that, if not correctly performed or adhered to, could result in damage to the product or loss of important data. Do not proceed beyond a **CAUTION** notice until the indicated conditions are fully understood and met.

---

**WARNING**











A **WARNING** notice denotes a hazard. It calls attention to an operating procedure, practice, or the like that, if not correctly performed or adhered to, could result in personal injury or death. Do not proceed beyond a **WARNING** notice until the indicated conditions are fully understood and met.

---

## Safety Symbols

The following symbol on the instrument and in the documentation indicates precautions that must be taken to maintain safe operation of the instrument.

---

	Direct current
	Alternating current
	Both direct and alternating current
	Three-phase alternating current
	Earth (ground) terminal
	Protective conductor terminal
	Frame or chassis terminal
	Equipotentiality
	Equipment protected throughout by double insulation or reinforced insulation
	Caution, risk of electric shock

---



Caution, risk of danger (refer to this manual for specific Warning or Caution information).



Caution, hot surface

---

## General Safety Information

### CAUTION

- Use the device with the cables provided.
  - Repair or service that is not covered in this manual should only be performed by qualified personnels.
- 

### WARNING

- **Do not use the device if it appears damaged or defective.**
  - **Observe all markings on the device before connecting any wiring to the device.**
  - **Do no operate the device in the presence of flammable gases or fumes.**
  - **Do no install substitute parts or perform any unauthorized modification to the device.**
-

## Environment Conditions

This instrument is designed for indoor use in areas with low condensation. Table 1 shows the general environment requirements.

**Table 1 Environment requirements**

Environment Conditions	Requirements
Operating environment	0 °C to +55 °C
Operating humidity	Up to 90% at 40 °C non-condensing
Storage environment	- 40 °C to +70 °C
Storage humidity	Up to 90% at 65 °C non-condensing

**CAUTION**

The Agilent 82350B PCI GPIB Interface complies with the following safety and EMC requirements:

IEC 61326-1 Group 1, Class A

IEC 61010-1

## Regulatory Markings

---



The CE mark is a registered trademark of the European Community. The CE mark shows that the product complies with all the relevant European Legal Directives.

---

**ICES/NMB-001**

ICES/NMB-001 indicates that this ISM device complies with Canadian ICES-001.

---



The CSA mark is a registered trademark of the Canadian Standards Association. A CSA mark with the indicators "C" and "US" means that the product is certified for both the U.S. and Canadian markets, to the applicable American and Canadian standards.

---



The C-tick mark is a registered trademark of the Spectrum Management Agency of Australia. This signifies compliance with the Australia EMC Framework regulations under the terms of the Radio Communication Act of 1992.

---



This product complies with the WEEE Directive (2002/96/EC) marking requirement. The affixed product label indicates that you must not discard this electrical/electronic product in domestic household waste.

---



## Waste Electrical and Electronic Equipment (WEEE) Directive 2002/96/EC

This instrument complies with the WEEE Directive (2002/96/EC) marking requirement. This affixed product label indicates that you must not discard this electrical/electronic product in domestic household waste.

Product Category:

With reference to the equipment types in the WEEE directive Annex 1, this instrument is classified as a "Monitoring and Control Instrument" product.

The affixed product label is shown as below:



Do not dispose in domestic household waste

To return this unwanted instrument, contact your nearest Agilent office, or visit:

[www.agilent.com/environment/product](http://www.agilent.com/environment/product)

for more information.



**Agilent Technologies**

**DECLARATION OF CONFORMITY**  
According to ISO/IEC Guide 22 and CEN/CENELEC EN 45014



**Manufacturer's Name:** Agilent Technologies, Incorporated  
**Manufacturer's Address:** 815 - 14<sup>th</sup> St. SW  
Loveland, CO 80537  
USA

**Declares under sole responsibility that the product as originally delivered**

**Product Name:** PCI GPIB Interface  
**Model Number:** 82350B  
**Product Options:** This declaration covers all options of the above product(s)

**complies with the essential requirements of the following applicable European Directives, and carries the CE marking accordingly:**

EMC Directive (89/336/EEC, amended by 93/68/EEC)  
Low Voltage Directive (73/23/EEC, amended by 93/68/EEC)

**and conforms with the following product standards:**

EMC	Standard	Limit
	IEC 61326-1:1997+A1:1998 / EN 61326-1:1997+A1:1998	
	CISPR 11:1990 / EN 55011:1991	Group 1 Class A
	IEC 61000-4-2:1995+A1:1998 / EN 61000-4-2:1995	4 kV CD, 8 kV AD
	IEC 61000-4-3:1995 / EN 61000-4-3:1995	3 V/m, 80-1000 MHz
	IEC 61000-4-4:1995 / EN 61000-4-4:1995	0.5 kV signal lines, 1 kV power lines
	IEC 61000-4-6:1996 / EN 61000-4-6:1996	3 V, 0.15-80 MHz 1 cycle, 100%
	Canada: ICES-001:1998	
	Australia/New Zealand: AS/NZS 2064.1	

The product was tested in a typical configuration with Agilent Technologies test systems.

**Safety**  
IEC 61010-1:2001 / EN 61010-1:2001  
Canada: CSA C22.2 No. 1010.1:1992  
UL 61010B-1: 2003

**Supplementary Information:**

**This DoC applies to above-listed products placed on the EU market after:**

20 April 2004

Date

Ray Corson

Product Regulations Program Manager

For further information, please contact your local Agilent Technologies sales office, agent or distributor, or Agilent Technologies Deutschland GmbH, Herrenberger Straße 130, D 71034 Böblingen, Germany.

# Contents

## 1 Installing and Configuring the 82350

Getting Started 2

Step 1 - Before you install the 82350 3

Check your shipment 3

System requirements 4

Create an emergency repair disk 6

Step 2: Installing the Agilent IO Libraries Suite 7

Checking for installed Agilent IO Libraries 7

Installing Agilent IO Libraries Suite 9

Step 3: Connecting your instruments 17

Installing the 82350 in your PC 17

Connecting instruments to the 82350 19

Step 4: Configuring the 82350 23

Installing configuration files 23

Configuring the 82350 interface 24

Step 5: Communicating with your instruments 28

Verifying instrument communication 28

Programming your instruments 29

## 2 Troubleshooting Guidelines

Troubleshooting Overview 34

82350 Hardware Checks 35

Check cables/connections/power 35

82350 Software Checks 40

Agilent IO Libraries Suite Checks 45

Check IO Libraries Suite installation 45

Check IO Control operation 46

Install IO Libraries Suite (if 82350 was installed first) 47

### **3 82350 Specifications and Information**

General Requirements 50

General Characteristics 51

Accessing an Electronic Copy of this Guide 52

Contacting Agilent 53



# 1 Installing and Configuring the 82350

This *Agilent 82350B PCI GPIB Interface Installation and Configuration Guide* shows you how to install and configure the Agilent 82350B PCI GPIB Interface (called the 82350 in this guide) and shows how to use the Agilent IO Libraries Suite to configure the card in PCs with Windows XP or Windows Vista or Windows 7 operating systems.

**NOTE**

The 82350 interface is supported on PCs with Windows NT® 4.0, but the latest version of Agilent IO Libraries Suite is not supported on NT. To use Windows NT, go to <http://www.agilent.com/find/iolib> and download Agilent IO Libraries M.01.01. Refer to the IO Libraries M.01.01 documentation for installation and configuration instructions. In case of difficulty in installing the 82350, see Chapter 2 - Troubleshooting Information.

---



### Getting Started

In this guide, an **82350 GPIB Interface System** is defined as a system in which GPIB instruments are connected via GPIB cables to an 82350 PCI GPIB Interface Card (called the 82350 in this guide) that is installed in a Windows PC. [Figure 1-1](#) shows a typical system.

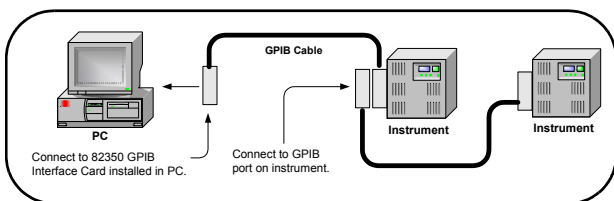

**Figure 1-1** 82350B system overview

Use the following sequence of steps as a guide as you set up your GPIB system. See the associated steps if you need more details. See *Chapter 2 - Troubleshooting Guidelines* if you need additional information on setting up the 82350 or GPIB instruments.

## Step 1 - Before you install the 82350

Before you install the 82350, you should:

- Check Your Shipment
- Check System Requirements
- Create an Emergency Repair Disk

### Check your shipment

Your 82350 Interface shipment should include the items in [Figure 1-2](#). If any items are missing or damaged, keep the shipping materials and contact Agilent Technologies. See *Chapter 3 - 82350 Guide Information* for addresses/telephone numbers.

#### CAUTION

To reduce the risk of damaging the 82350B card, protect the card from static electricity. Leave the card in its anti-static bag until you are ready to install the card. Handle the card only by the sheet metal frame or by the card edges. Never touch any other part of the card.

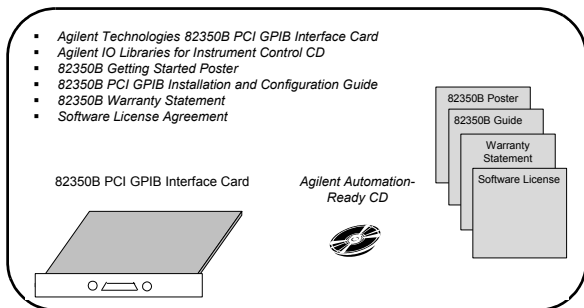

**Figure 1-2** 82350B shipment contents

### System requirements

The following is a list of the system configurations that we tested IO Libraries 15.5 on and are therefore guaranteed to work. In general, any x86 or x64 (except Itanium) should work but there may be a decrease in performance.

#### **Windows XP Service Pack 3 (or later)**

##### **Processor Speed:**

600 MHz or higher required, 800 MHz recommended

##### **Available memory:**

256 MB minimum (1 GB or greater recommended)

##### **Available hard disk space<sup>1</sup>:**

1.5 GB available hard disk space, includes:

- 1GB available for Microsoft .NET Framework 2.0
- 65MB for Agilent IO Libraries Suite

##### **Video:**

Super VGA (800x600) 256 colors or more

##### **Browser:**

Microsoft Internet Explorer 5.01 or greater

<sup>1</sup> Because of the installation procedure, less memory may be required for operation than is required for installation.



**Windows VISTA SP1 and SP2 (32-bit and 64-bit), Business, Ultimate, Enterprise, Home Basic, and Home Premium****Processor Speed:**

1Ghz 32-bit (x86), 1GHz 64-bit (x64), no support for Itanium64

**Available memory:**

1 GB minimum

**Available hard disk space<sup>1</sup>:**

1.5 GB available hard disk space, includes:

- 1GB available for Microsoft .NET Framework 2.0
- 65MB for Agilent IO Libraries Suite

**Video:**

Support for DirectX 9 graphics with 128MB graphics memory recommended (Super VGA graphics is supported)

**Browser:**

Microsoft Internet Explorer 7 or greater

**Windows 7 (32- and 64-bit), Home Basic, Home Premium, Professional, Ultimate, Enterprise****Processor Speed:**

1Ghz 32-bit (x86), 1GHz 64-bit (x64), no support for Itanium64

**Available memory:**

1 GB minimum

**Available hard disk space<sup>1</sup>:**

1.5 GB available hard disk space, includes:

- 1GB available for Microsoft .NET Framework 2.0
- 65MB for Agilent IO Libraries Suite

**Video:**

Support for DirectX 9 graphics with 128MB graphics memory recommended (Super VGA graphics is supported)

**Browser:**

Microsoft Internet Explorer 7 or greater

### **Create an emergency repair disk**

The Agilent IO Libraries Suite includes I/O drivers for various PCI plug-in cards. Extensive testing of these drivers and cards has revealed that early revisions of the BIOS code in several PCs are not completely PCI-compliant. This has caused problems when running the Agilent IO Libraries, whether or not the PCI card is installed. Problems can include system errors, operating system crashes, or card initialization failures.

For Windows NT operating systems, most PC manufacturers recommend that before installing any PCI card, you first create an EMERGENCY REPAIR DISK. If your PC exhibits any abnormal behavior following installation of the Agilent IO Libraries, we recommend a BIOS upgrade to the PC. BIOS upgrades are available from most PC manufacturers' websites.

## Step 2: Installing the Agilent IO Libraries Suite

Below are the steps on how to install the Agilent IO Libraries Suite, using default settings, including:

- Checking for Installed Agilent IO Libraries or Agilent IO Libraries Suite
- Installing Agilent IO Libraries Suite

### NOTE

See the *Agilent IO Libraries Getting Started Guide* on your Automation-Ready CD for a full description of installation options and installation troubleshooting information.

You must have Administrator privileges to install the IO Libraries Suite and to run the *Connection Expert* utility.

## Checking for installed Agilent IO Libraries

Before you begin installation, check for previously installed Agilent IO Libraries software. If a version of the Agilent IO Libraries Suite is installed on your PC, a blue IO icon may be displayed on the Windows Notification Area (on the lower right-hand side of the screen).

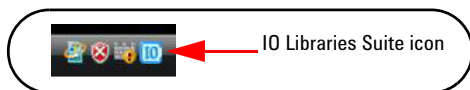

**Figure 1-3** IO Libraries Suite icon

- If the IO icon is displayed, click the icon and click **About Agilent IO Control** to display the version. The version must be 15.0 and above. If the IO icon is not displayed, a version may still be installed. To check this, click **Start | Programs** and look for the **Agilent IO Libraries** or **Agilent IO Libraries Suite** program group.

## 1 Installing and Configuring the 82350

- If this group is displayed, click **Agilent IO Libraries > Utilities > IO Control** to display the IO icon. Then, click the icon and click **About Agilent IO Libraries Control** to display the installed version (must be 15.0 or greater).
- If neither the IO icon nor the Agilent IO Libraries program group is displayed, no Agilent IO Libraries are installed and you can use the steps in this chapter and in the *Agilent IO Libraries Suite Connectivity Guide* to install the libraries.
- If the version of the Agilent IO Libraries Suite is less than 15.0, you must install the latest version included on your *Automation-Ready CD* to support the 82350B.
- If possible, you should always use the current version of the Agilent IO Libraries Suite. This version supports the latest interfaces and operating systems and has the most advanced features.

## Installing Agilent IO Libraries Suite

**NOTE**

You must have Administrator privileges to install Agilent IO Libraries Suite Connection Expert.

---

**NOTE****Every IO Libraries Suite installation is a “Full installation”**

In past versions of IO Libraries, there was an option to install IO Libraries as either a Full version or a Runtime version. Beginning with IO Libraries Suite 14.0, the installation process provides a **Full installation** for all users (i.e. there is no longer a Runtime installation option). This means that every installation now includes the development components of the Agilent IO Libraries Suite software, which allow you to develop your own I/O programs. If you wish to minimize the size of the installed software, select a Custom installation; when you get to the **Select Features** dialog, do not select the manuals and the sample programs.

---

This section describes how to install Agilent IO Libraries Suite on your PC. The process is as follows:

- 1 Verify that your PC meets the minimum system requirements. (See “System Requirements for Agilent IO Libraries Suite 15.5” in the *IO Libraries Suite 15.5 Connectivity Guide*)
- 2 If you are upgrading to IO Libraries Suite from a previous version of IO Libraries, you must remove the instruments and interfaces listed below before you upgrade your software. This step is necessary in order for these devices to obtain the correct drivers to work with Agilent IO Libraries Suite.
  - a Disconnect any USB instruments from your PC.
  - b Disconnect any Agilent 82357 USB/GPIB interface converters from your PC.
  - c Disconnect any Agilent E8491 IEEE 1394 PC Link to VXI interfaces from your PC.

## 1 Installing and Configuring the 82350

- 3 Close all other applications on your PC.

### NOTE

If you install a PCI card in your computer at the same time you install Agilent IO Libraries Suite 15, a possible conflict can occur. The “New Hardware Found” dialog for the PCI card must be closed before installing IO Libraries. Otherwise the IO Libraries installation will stop until PCI card installation is complete.

---

### NOTE

If you have NI software installed (such as NI MAX, etc.), then all NI services must be stopped prior to installing IO Libraries.

---

- 4 Insert the *Automation-Ready CD with Agilent IO Libraries Suite* into the CD-ROM drive of your PC.
  - Wait a few seconds for the auto-run window to appear.
  - If the auto-run window does not appear automatically,
    - Click **Start > Run...**
    - Type `<drive>:autorun\auto.exe`, where `<drive>` is your CD drive letter.
- 5 When the installation start-up window appears, click the “**Click here to install now**” button once, and wait for the InstallShield Wizard to appear.

Note: you also have the opportunity to watch a two-minute video how easy it is to install, set-up and configure your interfaces and instruments using Agilent IO Libraries Suite 15.
- 6 If the **IVI Shared Components** and **IVI VISA COM Standard Components** are not already installed on your PC, Agilent IO Libraries Suite installs them in the standard, default locations.

## NOTE

The IVI Shared Components and IVI VISA COM Standard Components are installed in default folders. However, if you need to install the IVI Components in a unique location refer to “Custom Installation of IVI Shared Components” in the *IO Libraries Suite 15.5 Connectivity Guide*.

---

- 7 When the InstallShield Wizard appears, click **Next >** to begin the IO Libraries Suite software installation.
- 8 Read the License Agreement(s). If you accept the terms, click the radio button labeled **I accept the terms of the license agreement** and then click **Next >** to continue.
- 9 When the InstallShield Wizard **Setup Type** dialog box appears, as shown, select **Typical** or **Custom**, then click **OK**. The **Typical** setup installs the recommended features for your configuration in standard locations on your PC. In a **Typical** setup, if another vendor’s VISA software is already installed on this PC, Agilent VISA is installed as secondary. If no other vendor’s VISA software is found on this PC, Agilent VISA is installed as primary. (See “Using Agilent VISA in Side-by-Side Mode” in the *IO Libraries Suite 15.5 Connectivity Guide*.)

## 1 Installing and Configuring the 82350

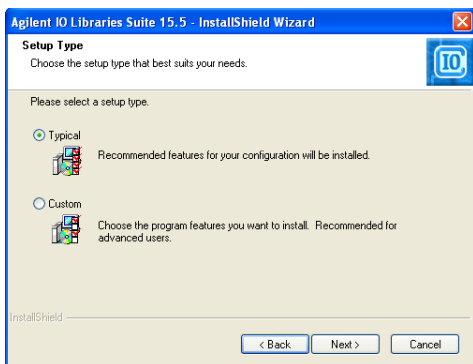

### NOTE

- If you accept the Typical Installation, click **“Next”** and proceed to [Step 13, Start Copying Files, on page 14](#).
- If you chose the Custom Installation radio button, click **“Next”** and proceed with [Step 10](#) below.

**10** If you chose the Custom setup and you do not have another vendor’s VISA implementation installed on your PC, then you will see the dialog box below, which asks whether you want to install Agilent VISA as the primary VISA.



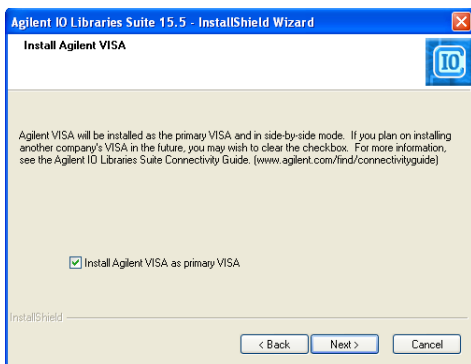

If you do have another vendor's VISA installed, you will see a similar dialog box, but the check box will not be selected, indicating that the default is to install Agilent VISA as secondary.

For details on this topic, see "Using Agilent VISA in Side-by-Side Mode" in the *IO Libraries Suite 15.5 Connectivity Guide*.

**11** If you chose a Custom setup, the next dialog shows the location of:

- The IO Libraries Suite Destination Folder
- Agilent VISA Destination Folder
- IVI Components Destination Folder

The VISA and IVI destinations are greyed out. They are for information only. In order to change them you must follow the instructions in "Custom Install the IVI Shared Components" in the *IO Libraries Suite 15.5 Connectivity Guide*.

**12** If you chose a **Custom** setup, you will now see the Select Features dialog box.

## 1 Installing and Configuring the 82350

- Click on any feature in the list to see the feature description and the space requirements for the selected set of features. It is recommended that you install the manuals and sample programs if you plan to program with the Agilent IO Libraries; however, you may omit them to save space.
- Select the check box for each feature to be installed. Clear the check box for each feature to omit.
- When you are done selecting features, click **Next >**.

**13**The Start Copying Files dialog appears; click **Install** to begin copying files.

- If the Microsoft .NET Framework version 2.0 has not previously been installed on your PC, IO Libraries will install them; this may take up to ten minutes. The Microsoft .NET Framework provides necessary infrastructure for Agilent IO Libraries Suite utilities, as well as for .NET programming tools and many other applications. You will only need to install the .NET Framework once, even if you remove and reinstall or upgrade your IO Libraries Suite.

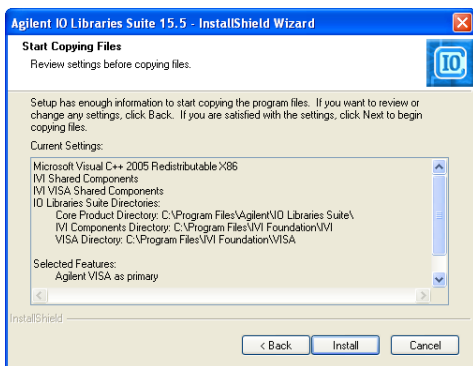

- 14 After the files have been copied, you may see a dialog asking you to restart your PC. This occurs only if you have certain I/O hardware configurations. If you choose not to reboot at this time, you should reboot before running Connection Expert.
- 15 When the **InstallShield Wizard Complete** dialog appears indicating that Agilent IO Libraries was successfully installed:
  - a Click **Finish** to close the window
  - b Or click on one of the product/solution links for information on other Agilent solutions.
- 16 Click the IO control icon () in lower right Windows Notification area to run Agilent IO Libraries.
- 17 If you are installing Agilent IO Libraries Suite along with another instrument, interface, or software package such as Agilent VEE, there may be another CD with additional software (drivers, sample programs, etc.). If you want to install this additional software,
  - Insert the CD into the CD drive on your PC.
  - Follow the instructions that came with the CD or the hardware or software product.
- 18 Re-connect any USB instruments or E8491 IEEE-1394 FireWire™ to VXI interfaces that you may have disconnected in [Step 2](#). Install any new hardware.
- 19 If Connection Expert is already running, click the **Refresh All** button to identify any hardware you have just installed or re-connected.

## 1 Installing and Configuring the 82350

If Connection Expert is not already running, run it now to verify your I/O configuration: In the Windows Notification area, click the IO icon () , then click Agilent Connection Expert.

- a Locate your interfaces and instruments in the Explorer Pane. Click on them to see their properties (displayed in the right-hand pane). Observe their state, also displayed in the right-hand pane: if communication to the interface or instrument has been successfully established, it will be in the Verified state, denoted by a green check mark.
- b Change the default I/O configuration (if necessary) by clicking **Change Properties...** in the property pane of the interface or instrument you wish to configure.

### NOTE

If you plan to program your GPIB instruments using the Agilent 488 API, or to run NI-488.2-compatible programs with Agilent interface hardware (such as GPIB cards), you may need to enable the Agilent 488 library. To do this, click **Tools > Agilent 488...**, then select the check box labeled **Enable Agilent GPIB cards for 488 programs**.

---

- c If you would like to test your connections manually, select your instrument, right-click and choose **Send Commands To This Instrument**.

## Step 3: Connecting your instruments

This step shows how to install an 82350 in a PCI slot in your PC and how to connect GPIB instruments to the 82350, including:

- Installing the 82350 in your PC
- Connecting instruments to the 82350

**NOTE**

If you have not yet installed the Agilent IO Libraries Suite, go to [“Step 2 - Installing the Agilent IO Libraries Suite”](#) and install the software BEFORE you install the 82350 in your PC.

To reduce the risk of damaging the 82350, only handle the card by the sheet metal frame or by its edges. Never touch any other part of the card, including the PCI connector.

The 82350B is a 5V PCI card and will not fit in a 3.3V PCI slot. Also, the 82350 will not fit in an EISA or ISA slot.

---

## Installing the 82350 in your PC

- 1 Record the Card Serial Number.** Remove the card from its anti-static bag and record the Serial Number for future reference. Save the anti-static bag so you can protect the card if you need to remove the card from the PC.

The 82350 Serial Number is located on the white serial number label on the card. The label contains 24 characters, with the last 8 characters (plus US) being the 82350 Serial Number. Thus, if the numbers on the serial number label are 82350-66511-4224-01-42300113, since the last 8 characters are 42300113, the 82350 Serial Number is US42300113.

- 2 Remove PC Cover.** Remove power from the PC and from all of its peripherals. Then, remove the power cord from the PC. Unlock and remove the

## 1 Installing and Configuring the 82350

cover from the PC to allow access to the I/O slots. See your PC documentation for instructions.

### NOTE

Take precautions against static discharge when handling and installing cards.

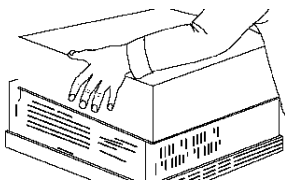

**Figure 1-4** Remove the PC cover

- 3 Remove a Cover Plate.** Remove one of the PC back panel cover plates. The 82350B is a 5V PCI card and will not fit in a 3.3V PCIe slot or in an EISA or ISA slot. Choose a 5V PCI slot that will give adequate clearance for the GPIB connector.

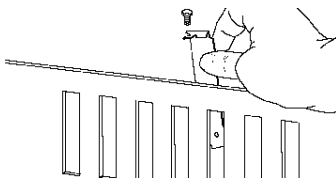

**Figure 1-5** Remove the card slot

- 4 Install the 82350.** Insert the 82350 Interface Card edge connector into the PCI expansion slot connector of the PC. Make sure the interface is fully seated by pushing firmly on the top edge of the card with the palm of your hand. The GPIB

connector should extend through the back panel opening to allow GPIB cable connection. If you install more than one 82350, you may want to install the cards so there is at least one empty slot between 82350s. When inserting the 82350, be sure to hold the card by its edges. Also, be careful with the metal faceplate around the GPIB connector as the faceplate can be bent.

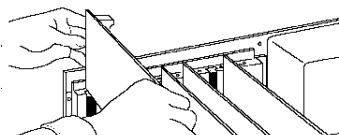

**Figure 1-6** Install the 82350B

- 5 Replace the Cover Plate Screw.** This will hold the 82350 in place. Save the blank cover plate for use if the 82350 is later removed. Replace the PC cover(s) as described in your PC documentation.

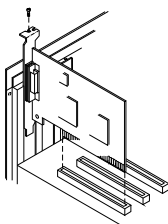

**Figure 1-7** Replace the cover plate screw

## Connecting instruments to the 82350

## 1 Installing and Configuring the 82350

After the 82350 is installed in your PC, the next step is to connect your GPIB instruments to the installed 82350. Suggested steps follow. When you have made the connections, go to “Step 4 - Configuring the 82350”.

**1 Review Connection Guidelines.** The recommended method for connecting a GPIB system is a linear arrangement with the system controller (PC) at one end of the system. However, a GPIB system can also be connected together in a star, linear, or a combination configuration as long as the total number of devices on the system is  $\leq 14$  and these guidelines are followed:

- To minimize stress on connector mountings, no more than three cable connectors blocks should be stacked on top of one another. The GPIB connector screws should be finger-tightened only.
- Minimize cable length as much as possible. All system devices must have tri-state drivers and must be powered on. Systems with devices not using tri-state drivers are limited to transfer rates  $< 250$  Kbytes/sec.
- For operation with data transfer rates  $< 500$  Kbytes/sec, the total length of all GPIB cables is  $\leq 2$  meters times the number of devices connected together, up to a maximum of 20 meters.
- For operation with data transfer rates  $> 500$  Kbytes/sec, the total length of all GPIB cables is  $> 1$  meter times the number of devices connected together, up to a maximum of 15 meters.
- The length between adjacent devices is not critical as long as the overall restriction is met. GPIB bus extenders are available that allow operation over much greater distances.



- 2 Connect GPIB Cables to the 82350.** Connect a separate GPIB cable to each installed 82350. Tighten the GPIB connector screws finger-tight only. (The screwdriver slots are for removal purposes only.) Two examples follow showing how to connect a single GPIB instrument or how to connect multiple GPIB instruments.

For information or to purchase Agilent GPIB cables, see [www.agilent.com/find/io](http://www.agilent.com/find/io)

**Example: Connecting a single GPIB instrument**

Figure 1-8 shows connections from a single GPIB instrument to the GPIB connector of an 82350 installed in your PC. You may want to record the primary GPIB address of the attached instrument for future programming use. After making the connections, reconnect the PC power cord and apply power to the PC and to attached peripherals/instruments.

**CAUTION**

To avoid damage to the connectors, only finger-tighten the connectors.

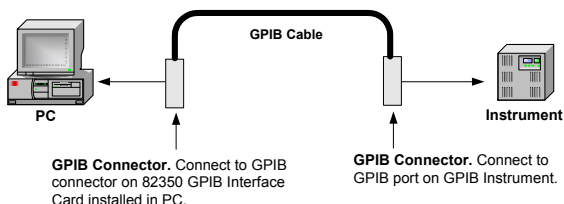

**Figure 1-8** Connecting a single GPIB instrument

## 1 Installing and Configuring the 82350

### Example: Connecting Multiple GPIB Instruments

Figure 1-9 shows one way to connect three GPIB instruments to an Agilent 82350 GPIB Interface Card. You may want to record the primary GPIB address of each attached instrument for future programming use. After making the connections, reconnect the PC power cord and apply power to the PC and attached peripherals/instruments.

#### CAUTION

To avoid damage to the connectors, only finger-tighten the connectors.

#### NOTE

Although the figure shows cable connections to GPIB Instrument 1, the connection can be to any GPIB instrument in the system.

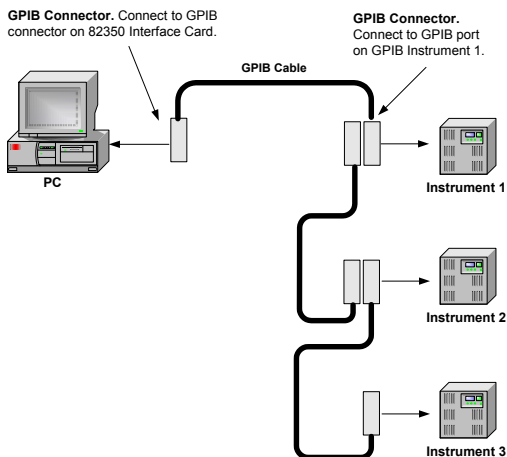

Figure 1-9 Connecting multiple GPIB instruments

## Step 4: Configuring the 82350

This step shows how to configure a Windows XP/Vista/7 operating system for a PC that has an 82350 installed.

### Installing configuration files

- 1 Apply Power.** Apply power to the PC and to the installed GPIB instruments. As Windows starts again, a **Found New Hardware Wizard** may start.
- 2 Install Configuration Files.** Click Next> to accept the defaults. (Make sure that you have installed Agilent IO Libraries Suite first. You will not need a CD.) Click **Finish** to complete the installation.
- 3 Open Connection Expert.** Click the **Agilent IO Control** icon in the Windows Notification area, and then click Agilent Connection Expert. When the main screen appears, you will see a map of the system connections in the **Instrument I/O on this PC** pane (also called “Explorer Pane”). *If you see your interface and instruments in the Explorer Pane, you are ready to go!*

**NOTE**

For help with Connection Expert, refer to the Agilent IO Libraries Suite help file. This help file is available from the **IO Control > Documentation** menu.

---

### Configuring the 82350 interface

- Open Connection Expert.** Click the **Agilent IO Control** icon (IO icon on the Windows Notification Area) and then click **Agilent Connection Expert**. When the Connection Expert window appears, highlight the GPIB interface in the explorer view (tree view at the center of the window) and then click **Change Properties...** to display the **Agilent 82350 PCI GPIB Interface** dialog box.

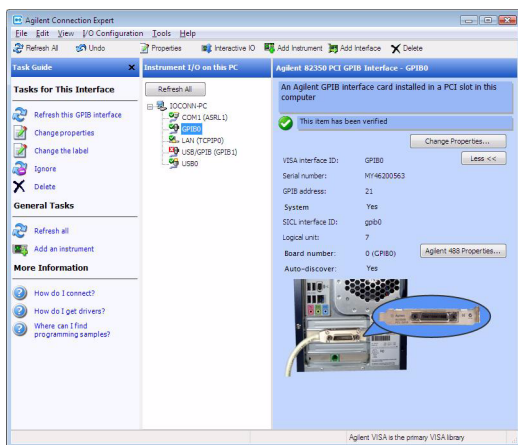

**Figure 1-10** Agilent Connection Experts

**NOTE**

For a description of Connection Expert and the Agilent IO Libraries Suite, see the Agilent IO Libraries Suite Online Help. To access this Help file, click the IO Control and select **Documentation > IO Libraries Suite Help**.

- 2 Configure GPIB Card Parameters.** When the **Agilent 82350 PCI GPIB Interface** dialog box appears, set the **VISA interface ID**, **SICL interface ID**, **Logical unit** and **GPIB address** values as required.

Also, verify that this is the **System controller** for the GPIB to which it is attached (this is the typical operating mode). (See the System Controller discussion below.) Then, click the **OK** button. Some guidelines to set these values follow.

**NOTE**

Changes to certain properties of the 82350, including:

- GPIB address
- System controller flag
- SICL interface ID
- Logical unit

will not take effect until you reboot your PC. If you choose not to reboot immediately, Connection Expert will display a warning icon  until you reboot.

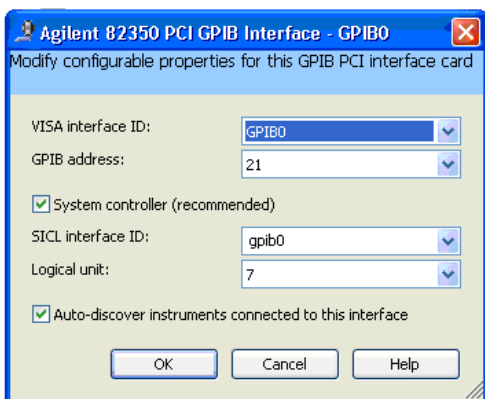

**Figure 1-11** Configure GPIB card parameters

## 1 Installing and Configuring the 82350

**Table 1-1** 82350 GPIB interface card configuration parameters

<b>VISA Interface ID</b>	Symbolic name that VISA uses to uniquely identify this GPIB interface. The default VISA interface ID is GPIB0. The 82350 interface ID for VISA must begin with the string GPIB and have an integer appended to it, such as GPIB0, GPIB1, GPIB2, etc. Remember this value to properly address GPIB devices in your VISA applications.
<b>GPIB Address</b>	Address of this GPIB interface controller on the GPIB bus. It is usually 21 if the GPIB interface is a System Controller or 20 if the GPIB interface is a non-System Controller (see System Controller, following). These addresses are chosen by convention but any address in the range 0 - 30, inclusive, may be used.
<b>System Controller</b>	Determines if this interface controls which bus devices talk and which bus devices listen. If several devices exist on a bus, be sure each has a unique GPIB bus address and only one device is the System Controller. Each GPIB interface has its own independent bus. Thus, each interface may be a System Controller as long as it is not chained together with other GPIB interfaces. However, two or more System Controllers on the same bus will cause the bus to be inoperative.
<b>SICL Interface ID</b>	Symbolic name that SICL uses to uniquely identify this GPIB interface. The default Interface ID is gpib0. The SICL interface ID must be a unique string of alphanumeric characters, starting with a letter. Remember this value and the logical unit number to properly address GPIB devices in your SICL applications.
<b>Logical Unit</b>	Number that SICL uses to uniquely identify this 82350 interface. The logical unit number is an integer in the range of 0 - 10000. Remember this value and the SICL interface ID to properly address the GPIB interface in your SICL applications.

- 3 Repeat Steps for Other Cards.** If you have installed more than one 82350 in your PC, repeat these steps for the remaining cards. Then, go to “Step 5 - Communicating with Instruments”.

### Step 5: Communicating with your instruments

After the 82350 has been configured and you have connected your GPIB instruments to the 82350, the next step is to verify communication between your PC and the instruments using the Interactive IO utility. After communication has been established, you can begin programming the instruments using VISA, VISA COM, SICL, or SCPI commands. This section includes:

- Verifying Instruments
- Programming Your Instruments (Optional)

#### Verifying instrument communication

When the Agilent IO Libraries Suite was installed on your PC, an I/O utility called **Interactive IO** was also installed. You can use Interactive IO to verify communication between your PC and connected GPIB instruments. This section shows one way to use Interactive IO to verify instrument communication.

##### NOTE

Once your GPIB interface has been configured in Connection Expert, if you can see the attached GPIB instrument(s) in the Connection Expert explorer and see their IDN string information in the detail pane then communication has been verified. Interactive IO allows you to manually verify communication and send specific commands to your instruments.

---

To use Interactive IO to send a **\*IDN?** (identification) query to an instrument:

- 1 Select the instrument by clicking its icon in the Connection Expert explorer view.
- 2 Right-click the instrument and click **Send Commands To This Instrument** to display the Interactive IO window. For information on



Interactive IO, including a list of common commands and their meanings, click **Help | Help Topics**.

- 3 **\*IDN?** is the default command. Click **Send & Read** to send the identification query to the instrument and display its reply in the Interactive IO window.
- 4 To send other commands, click **Commands>** to select from a list of common commands, or type a command into the **Command:** field. If you experience timeout errors for some commands, click **Options** to change the timeout value.

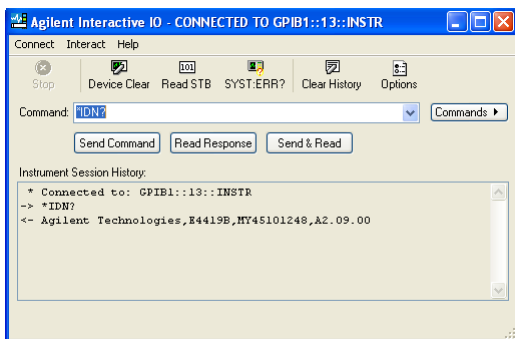

**Figure 1-12** Agilent Interactive IO

## Programming your instruments

This section provides an introduction to programming GPIB instruments via the 82350 PCI GPIB interface using the Agilent VISA and SIDL IO Libraries. You can program in various languages/applications, including Visual Basic, Visual C++, and Agilent VEE.

## 1 Installing and Configuring the 82350

See the applicable User's Guide, such as the *Visual Basic User's Guide*, for programming guidelines. You can also find additional programming examples using various IO Libraries and instrument drivers in the instrument *User's Guide*. After the 82350 is successfully installed and configured, it should act as a transparent interface for programming GPIB instruments.

For information on programming using Agilent VISA, see the *Agilent VISA User's Guide*. For information on VISA COM and for function references for VISA, VISA COM, and SICL, see the *IO Libraries Suite Online Help*.

### Accessing Programming Manuals and Help

You can access .pdf copies of the *Agilent VISA User's Guide* and the *Agilent SICL User's Guide for Windows* from the blue circled **IO** icon on the Windows Notification Area. Adobe Acrobat Reader is required to view these manuals.

To access the *Agilent VISA User's Guide*, click the IO icon and then click **Documentation | VISA Users Guide**. To access the *Agilent SICL User's Guide for Windows*, click the IO icon and then click **Documentation | SICL Users Guide**. To access VISA COM information, and function references for VISA, VISA COM, and SICL, click the IO icon and then click **Documentation | Help Topics > VISA COM Help**.

### Example: GPIB Interface Configuration

An **I/O interface** consists of a hardware interface and a software interface. One purpose of the Connection Expert utility is to associate a unique software interface ID with a hardware interface. The Agilent IO Libraries Suite uses an **Interface ID** or **Logical Unit Number** to identify an interface. This information is passed in the parameter string of the **viOpen** function call in a VISA program or in the **iopen** function call in a SIDL program.

For example, the GPIB interface system in [Figure 1-13](#) consists of a Windows PC with two 82350 GPIB cards connected to three GPIB instruments via GPIB cables. For this system, the Connection Expert utility has been used to assign GPIB card #1 a VISA interface ID of “GPIB0” and a SIDL interface ID of “gpib0”.

Connection Expert has also been used to assign GPIB card #2 a VISA interface ID of “GPIB1” and a SIDL interface ID of “gpib1”. With these names assigned to the interfaces, the VISA/SIDL addressing is as shown in the figure. Since unique names have been assigned by Connection Expert, you can use the VISA **viOpen** command to open the I/O paths to the GPIB instruments. Or, you can use the SIDL **iopen** command to open the I/O paths shown.

## 1 Installing and Configuring the 82350

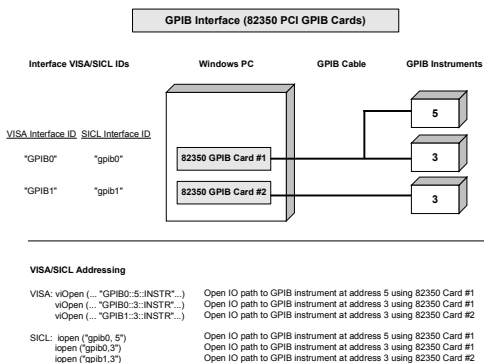

**Figure 1-13** Interface configuration for multiple instruments



## 2 Troubleshooting Guidelines

This chapter shows suggested troubleshooting steps for an Agilent 82350 GPIB interface, including:

**NOTE**

Additional troubleshooting information appears in the Agilent IO Libraries Suite Online Help and on the Web at <http://www.agilent.com/find/iolib>

---



## 2 Troubleshooting Guidelines

# Troubleshooting Overview

A suggested troubleshooting flowchart for the 82350, installed instruments, and the Agilent IO Libraries Suite follows. We suggest that you start at Step 1 and then go to Step 2 and then to Step 3, as required.

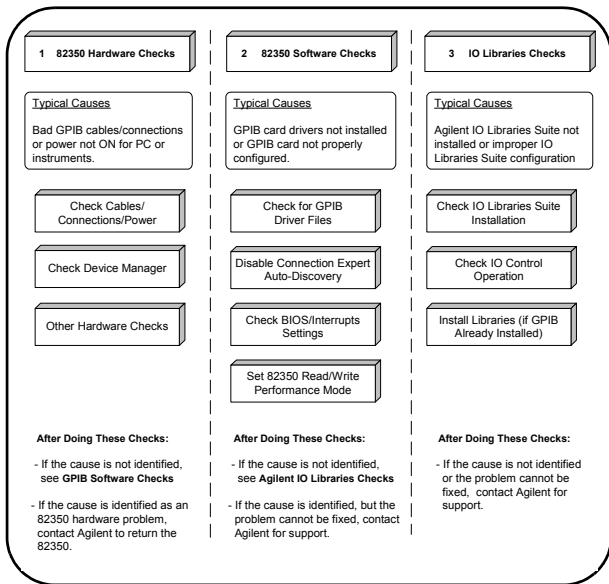

Figure 2-1 Troubleshooting overview

## 82350 Hardware Checks

This section gives guidelines to make hardware troubleshooting checks for the 82350, including:

- Check Cables/Connections/Power
- Check Device Manager
- Sound Card Does Not Work
- Data Transfers to Devices Fail
- Connection Expert Finds 82350 Card with Serial Number

### Check cables/connections/power

We suggest you start your troubleshooting sequence by performing the following hardware checks. If the hardware checks do not solve the problem, see 82350 Software Checks.

**NOTE**

There are no user-serviceable parts for the 82350. If you suspect a hardware failure for the 82350, contact Agilent for instructions to return the unit.

- 1 Check GPIB Cable Connections.** Check all GPIB cables for good connection to the GPIB connector on the 82350 installed in your PC and the GPIB cable connections between all connected GPIB instruments. An improperly attached GPIB connector can cause the bus to malfunction.
- 2 Check GPIB Cables for Damage.** Check all GPIB cables for cuts/damage and check for bent/misaligned/crushed connector pins. Replace cables as required.
- 3 Disconnect/Reconnect GPIB Cables.** If Steps 1 and 2 do not solve the problem, try disconnecting and reconnecting (or replacing) GPIB cables.

## 2 Troubleshooting Guidelines

- 4 **Check PC/Instrument Power-on.** Verify that the PC and all connected GPIB instruments are functional and are powered ON. Verify that host computer is not in a Suspended power management state.
- 5 **Reboot Your PC.** If doing Steps 1, 2, 3 or 4 does not solve the problem, reboot the PC. If this does not solve the problem, go to “Check Device Manager”.

### Check Device Manager

You can use the Windows Device Manager to reinstall the 82350 or equivalent, as required. From Device Manager, select **82350** and then **Properties**. Tab to **Driver** and click **Reinstall Driver**.

This will allow the Windows Plug and Play Manager to begin searching for a driver for the 82350. Since Device Manager may have disabled the 82350 device, click **Enable** to restart the 82350. If this does not resolve the problem, go to “82350 Software Checks”.

### If Sound Card Does Not Work

If sound card does not work after configuring interfaces, disable the auto-discovery process in Connection Expert. The auto-discovery process can cause sound and other cards to stop responding. To disable the auto-discovery process, run Connection Expert, select **Tools | Options**, and clear the check boxes labeled **Automatic discovery or refresh of I/O resources** and **Automatic configuration of unconfigured interfaces**. Close Connection Expert and restart your PC.



### If Data Transfers to Devices Fail

If devices attached to your ISA (82341) GPIB card are detected, but data transfers to those devices fail, this is usually caused either by an IRQ conflict with another card or by your system having no IRQs available for this card. If no IRQs are available, the IRQ value shown in Connection Expert will be -1.

**For Windows XP/Vista/7:** Try changing the IRQ setting to other values. You must reboot after changing the value to test it. If none work, you will have to free up other IRQs by disabling devices such as serial ports or sound cards.

### If Connection Expert Finds 82350 Card with Serial Number fffffff

If Connection Expert reports finding an 82350 card with serial number fffffff, it is typically caused by the PCIe card are not properly configured. Try the following:

- 1 Check BIOS Setting.** For Windows NT, make sure the BIOS **Operating System** setting is set to **Not PnP OS** or to **Running Windows NT** or to **Other**.
- 2 Upgrade your system BIOS to the latest version.** Note that even new computers often have newer BIOSs available.
- 3 If your computer locks up or freezes after installing.** Typically, this is caused by interrupt conflicts with other drivers in the system. PCI allows sharing of IRQs, but this also means that the drivers for cards with which the 82350 shares an IRQ must handle interrupt chaining properly. Both NT and Windows 98 allow multiple drivers to install interrupt service routines (ISRs) for a single IRQ. The operating system will keep a list of all the ISRs installed for each IRQ. When the IRQ is asserted, the operating system will call each ISR in turn until

## 2 Troubleshooting Guidelines

one of them returns TRUE (meaning that it handled the interrupt). The ISR's responsibility is to correctly return TRUE if its device was interrupting, or FALSE if not.

- 4 Perform Driver Workarounds.** Here are some ways to work around drivers that are not behaving properly:
  - a** Upgrade the drivers for devices sharing an IRQ with the 82350, including but not limited to, your video drivers, your LAN drivers, Agilent IDE and/or SCSI drivers, and your sound drivers.
  - b** Try to force the Agilent driver to be installed earlier in the ISR chain.
  - c** For Windows 98 SE, change your BIOS **Installed OS** setting. Try all the different values and use the one that works.
  - d** For Windows 98 SE, make sure all devices sharing an IRQ with our card have drivers installed. Right-click **My Computer** and select **Properties**, then **Device Manager**. Highlight **Computer** and click **Properties**. Find the 82350 card and check that all other cards on the same IRQ have a valid driver, not the big yellow question-mark.
- 5 Reconfigure Your PC.** Configure your PC so as to not share IRQ lines. Many PCI cards have bugs when sharing IRQ lines. You may or may not be able to do this on your PC; many PCs can be configured using the setup option when the PC is first booting.

- 6 Upgrade your system BIOS.** Note that even new computers may have a newer BIOS available.
- a** Make sure the BIOS **Installed O/S** setting is set correctly. This determines what software will configure all the Plug and Play cards in your system. Either the BIOS or the operating system can perform the task of querying all the cards to determine their resource needs, picking a valid configuration for all these cards, and telling the cards what their actual resource settings are.
  - b** If the **Installed O/S** is set to **Windows NT**, **NOT PnP O/S**, or **Other**, the BIOS will perform this task.
  - c** For NT version 4.0 or earlier, the BIOS must perform this task as the operating system does not know how to do this. For Windows 98, either the BIOS or the operating system can do this task, so try both. If you are running Windows NT, set to **Running Windows NT**, **Not VXiplug&play OS** or **Other**.

### 82350 Software Checks

This section provides guidelines for 82350 software checks, including:

- Disable Connection Expert Auto-Discovery
- Check BIOS/Interrupts Settings
- Set 82350 Read/Write Performance Mode

#### Disable Connection Expert Auto-Discovery

If your PC sound card stops working after configuring interfaces, disable the auto-discovery process in Connection Expert, as the auto-discovery process can cause sound and other cards to stop responding. To disable the auto-discovery process, run Connection Expert, select **Tools | Options**, and clear the check boxes labeled **Automatic discovery or refresh of I/O resources** and **Automatic configuration of unconfigured interfaces**. Close Connection Expert and restart your PC.

#### Check BIOS/Interrupts Settings

If Connection Expert reports finding an 82350 card with Serial Number ffffffff, this is typically caused by PCI cards not properly configuring. Try the following steps. If these steps do not work, remove and re-install the 82350 and then reconfigure the card.

- 1 Check BIOS Setting.** For Windows NT, make sure the BIOS **Operating System** setting is set to **Not PnP OS** or to **Running Windows NT** or to **Other**.
- 2 Upgrade your system BIOS to the latest version.** New computers oftentimes have newer BIOSs available.
- 3 If your computer locks up or freezes after installing.** This is typically caused by interrupt

conflicts with other drivers in the system. PCI allows sharing of IRQs, but this also means the drivers for cards which share an IRQ must handle interrupt chaining properly. Both Windows NT and Windows 98 allow multiple drivers to install interrupt service routines (ISRs) for a single IRQ. The operating system (OS) keeps a list of all the ISRs installed for each IRQ.

When the IRQ is asserted, the OS calls each ISR in turn until one of them returns TRUE (meaning that it handled the interrupt). The ISR's responsibility is to correctly return TRUE if its device was interrupting or FALSE if not. Drivers that return TRUE, even though they did not service the interrupt, will cause problems. Try the following steps to perform driver workarounds:

- Upgrade the drivers for devices sharing an IRQ with Agilent, including, but not limited to, your video drivers, your LAN drivers, Agilent IDE and/or SCSI drivers, and your sound drivers.
  
- For Windows 98SE, change your BIOS **Installed OS** setting. Try all the different values and use the one that works. Make sure all devices sharing an IRQ with your card have drivers installed.
  
- Right-click **My Computer** and select **Properties**, then **Device Manager**. Highlight **Computer** and click **Properties**. Find the 82350 card and check that all other cards on the same IRQ have a valid driver, not the big yellow question mark.

**4 Reconfigure Your PC.** Configure your PC so as to not share IRQ lines. Many PCI cards have bugs when sharing IRQ lines. You may or may not be able to do this on all PCs. Many PCs can

## 2 Troubleshooting Guidelines

be configured using the setup option when the PC is booting.

### 5 Upgrade your system BIOS. New computers may have a newer BIOS available. When installing a new system BIOS:

- Make sure the BIOS **Installed O/S** setting is set correctly. This determines what software will configure all the Plug and Play cards in your system. Either the BIOS or the operating system (OS) can perform the task of querying all the cards to determine their resource needs, picking a valid configuration for all these cards, and telling the cards what their actual resource settings are.
- If the **Installed O/S** is set to **Windows NT**, **NOT PnP O/S**, or **Other**, the BIOS will perform this task and the system may not work properly
- For NT 4.0, the BIOS must perform this task as the OS does not know how to do this. For Windows 98, either the BIOS or the O/S can do this task, so try both. If you are running Windows NT, set to **Running Windows NT**, **Not Plug and Play OS** or **Other**.

### Set 82350 Read/Write Performance Mode

The 82350 card read and write calls use one of two modes:

- **Polling.** Bytes are transferred to/from the card, one at a time. Polling mode is advantageous for transferring a small number of bytes because the setup overhead is very low, but it does require CPU involvement for each byte transferred.
- **Interrupt.** An entire buffer is transferred to/from the card without CPU involvement. Interrupt mode is advantageous for transferring large buffers because the higher per byte transfer rate more than compensates for the relatively long interrupt setup overhead.

The default behavior of the 82350 driver is to use **Polling** mode for transfers of 256 bytes or less and to use **Interrupt** mode for larger transfers. You can modify this default behavior by doing the following:

**SICL:** The SICL `ihint(id, hint)` function can be called to modify the read/write behavior for on a SICL session. The hint values allowed are:

- 1 **I\_HINT\_DONTCARE** (default value) Use Interrupt mode for transfer requests larger than 256 bytes, otherwise, use Polling mode.
- 2 **I\_HINT\_USEPOLL** Use the Polling mode.
- 3 **I\_HINT\_IO** Use the Interrupt mode.

**VISA:** The VISA `viSetAttribute(vi, VI_ATTR_DMA_ALLOW_EN, attrValue)` function can be called to modify the read/write behavior for a VISA session. The **VI\_ATTR\_DMA\_ALLOW\_EN** values allowed are:

- **VI\_TRUE** (default value) Use Interrupt mode for transfer requests larger than 256 bytes, otherwise, use Polling mode.
- **VI\_FALSE** Use the Polling mode.

Some additional factors to consider are:

- The settings discussed above are per session. This means you can open multiple sessions to a device and set different transfer modes for different sessions. The actual mode used will then depend on which session you are using for the read/write calls.
- In both SICL (with **hint = I\_HINT\_DONTCARE**) and VISA (with **VI\_ATTR\_DMA\_ALLOW\_EN = VI\_TRUE**), the size of the read request (as specified by **bufsize** in a SICL `iread()` or **count** in a VISA `viRead()` function call) will determine the mode used even if the number of bytes actually read is less.

## 2 Troubleshooting Guidelines

- The default formatted IO read buffer size is 4096 so when using this default size, formatted reads in SICL (with **hint = I\_HINT\_DONTCARE**) and VISA (with **VI\_ATTR\_DMA\_ALLOW\_EN = VI\_TRUE**) will use Interrupt mode even when a small number of bytes are expected.
- The default formatted IO write buffer size is 128 so when using this default size, formatted writes in SICL (with **hint = I\_HINT\_DONTCARE**) and VISA (with **VI\_ATTR\_DMA\_ALLOW\_EN = VI\_TRUE**) will use Polling mode even sending a large number of bytes.
- In SICL, Polling mode will always be used for the **iread()**, **ifread()** and **iscanf()** regardless of the above settings, when a **termchr** is set (**itermchr()** is not set to **-1**).
- In VISA, Polling mode will always be used for **viRead()**, **viBufRead()** and **viScanf()** regardless of the above settings, when **VI\_ATTR\_TERM\_CHAR\_EN = VI\_TRUE**.

The **crossover point** at which the Interrupt mode becomes faster than the Polling mode depends on the CPU speed, with a faster CPU having a higher crossover point.



## Agilent IO Libraries Suite Checks

This section gives guidelines to troubleshoot problems involving the Agilent IO Libraries Suite, including:

- Check IO Libraries Suite Installation
- Check IO Control Operation
- Install IO Libraries Suite (if 82350 was Installed First)

### Check IO Libraries Suite installation

Start your Agilent IO Libraries Suite troubleshooting sequence by verifying IO Libraries Suite installation. If the IO Libraries Suite is installed, go to Check IO Control Operation.

- 1 Check Agilent IO Libraries Version.** If a version of the Agilent IO Libraries has been installed, a blue **IO** icon is normally displayed on the Windows Notification Area (on the lower right-hand side of the screen).

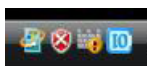

← IO Libraries Suite Icon

**Figure 2-210** Libraries Suite icon

- If the **IO** icon is displayed, click the icon and click **About Agilent IO Control** to display the version. The version must be version 15 or greater.
- If the **IO** icon is not displayed, a version might also be installed. To check this, click **Start | Programs** and look for the *Agilent IO Libraries* or *Agilent IO Libraries Suite* program group.

## 2 Troubleshooting Guidelines

- If this group is displayed, click **Agilent IO Libraries Suite | Utilities | IO Control** to display the **IO** icon. Then, click the icon and click **About Agilent IO Control** to display the installed version (must be version 15 or greater).
- If neither the **IO** icon nor the Agilent IO Libraries program group is displayed, no Agilent IO Libraries are installed. In this case, or if the installed version is not 15.0 or greater, you must install the latest version (see Step 2, following).

**2 Install Agilent IO Libraries Suite (as Required).** If Version 15.0 or greater of the Agilent IO Libraries is not installed on your PC, install the IO Libraries Suite. Otherwise, go to “Check IO Control Operation”.

### Check IO Control operation

When the Agilent IO Libraries Suite was installed, an IO Control was created. When the IO Control is active, it is displayed as a blue circled **IO** icon on the Windows Notification Area. If the IO Control is deactivated, SICL/VISA applications that are running with the 82350 will be unable to open sessions.

By default, the IO Control is always active after the Agilent IO Libraries Suite is installed and the blue **IO** icon is displayed. However, the IO Control may be active even though the blue **IO** icon is not displayed. There are two ways that the blue **IO** icon can be hidden:

- **Hiding Agilent IO Control.** Clicking the blue **IO** icon and then clicking **Hide Agilent IO Control**, or unchecking **View | Agilent IO Control** in Connection Expert, hides the **IO** icon, but does **not** deactivate the IO Control.

- **Clicking Exit.** Clicking the blue **IO** icon and then clicking **Exit** causes a dialog box to appear that asks you if you want to terminate the Agilent IO Control. Clicking **Yes** hides the blue **IO** icon **and** deactivates the IO Control.

If the blue **IO** icon is not displayed, either the blue **IO** icon display has been turned off and/or the IO Control (and associated **iprocsvr.exe**) is not active. In this case, click **Start | Programs | Agilent IO Libraries Suite | Utilities | IO Control** to re-start the IO Control and to display the blue circled **IO** icon.

## **Install IO Libraries Suite (if 82350 was installed first)**

If you installed the 82350 before installing the Agilent IO Libraries Suite software, follow these steps to install and configure the IO Libraries Suite and the necessary drivers for your card.

- 1** Install the Agilent IO Libraries Suite as described in "[Step 2: Installing the Agilent IO Libraries Suite](#)" on page 7 of this manual.
- 2** If the Connection Expert utility does not recognize your 82350 and display it as a PCI GPIB Interface, you may need to use Windows Device Manager to associate the correct drivers with your card. Follow the steps for your operating system:

## 2 Troubleshooting Guidelines

- **Windows XP/Vista/7:**  
Start the Windows Device Manager as follows: Right-click on **My Computer**, select **Properties**, then the **Hardware** tab, then **Device Manager**.

Find the **PCI Simple Communications Controller** in the Device Manager, and select **Update Driver...**

Allow Windows to find and install the driver automatically. You should not need to insert a CD.

### NOTE

On older operating systems, you may be asked to insert the 'HP I/O Libraries' CD. Depending on the file you are prompted for and on the operating system, you should be able to find the needed file in one of the following directories:

- C:\windows\inf
- C:\windows\system
- C:\windows\system32
- C:\windows\system32\drivers

The card may be identified as a Hewlett-Packard card. This is necessary for backward compatibility.

---



Agilent 82350B PCI GPIB Interface 82350B PCI  
GPIB Interface  
Installation and Configuration Guide

## **3** **82350 Specifications and Information**

This chapter provides general information for the *82350B PCI GPIB Interface*.



## General Requirements

Before installing your Agilent 82350, make certain your PC meets or exceeds the following criteria. [Table 3-1](#) lists the general requirements for installing the 82350.

**Table 3-1** 82350 General requirements

Minimum system requirements	Windows XP/Vista/7 (IO Libraries Suite v15)
Software required	Agilent IO Libraries Suite (IO Libraries Suite v15 included)
PCI bus slot	5-V PCI slot, 32 bits
Supported standards	PCI rev 2.2 IEEE 488.1 and IEEE 488.2 compatible

## General Characteristics

All characteristics are typical performance values and are not warranted. [Table 3-2](#) lists the general characteristics of the Agilent 82350.

**Table 3-2** 82350 General characteristics

Power	Backplane +5 V PCI
Connectors	Standard 24-pin GPIB (IEEE-488) +5V PCI
Maximum data rate	More than 900 KB/s
Maximum instrument connection	14 instruments—daisy chain via GPIB
Buffering	Built-in
Configuration	Plug-and-Play
EMC and safety *	IEC 61326-1 Group 1, Class A IEC 61010-1
Warranty	1 year
Length, width, and height	122 mm (L) x 122 mm (W) x 22 mm (H) (a full-height PCI card)
Weight	0.091 kg

## Accessing an Electronic Copy of this Guide

There are two ways you can access an electronic (.pdf) version of this guide, as follows. You will need Adobe Acrobat Reader Version 3.0 or later to view the electronic version.

- 1 Access from the IO Control.** After the Agilent IO Libraries Suite is installed, a blue circled IO icon appears on the right hand side of the Windows toolbar. To access an electronic version of this guide, click the IO icon, click **Documentation**, then **Interface Manuals**, and then click **82350 PCI GPIB Users Guide**.
- 2 Access from the Web.** On your Web browser address line, type **www.agilent.com/find/82350B** and navigate to the 82350 manual. The Web version of the manual will always be the latest revision.



## Contacting Agilent

You can reach Agilent Technologies at this telephone number in the United States:

United States Call Center: 1-800-829-4444

For other locations, contact your country's Agilent support organization.

A list of contact information for other countries is available on the Agilent Web site at:

**[www.agilent.com/find/assist](http://www.agilent.com/find/assist)**

A list of other Agilent Web sites follows.

URL	Description
<b><a href="http://www.agilent.com/find/assist">www.agilent.com/find/assist</a></b>	Agilent Technologies "Contact Us" page
<b><a href="http://www.agilent.com/find/iolib">www.agilent.com/find/iolib</a></b>	Update the Agilent IO Libraries Suite software
<b><a href="http://www.agilent.com/find/ADN">www.agilent.com/find/ADN</a></b>	Connectivity resources all in one place
<b><a href="http://www.agilent.com/find/techsupport">www.agilent.com/find/techsupport</a></b>	Technical support information, including manuals, application notes, FAQs, and software and firmware downloads
<b><a href="http://www.agilent.com/find/connectivity">www.agilent.com/find/connectivity</a></b>	For connection, communication and control of test instruments from your computer, you can find out the latest in connectivity.

### **3 82350 Specifications and Information**

# Index

## A

- Administrator privileges required, 8
- Agilent IO Control icon, 19
- Agilent VEE, 24
- Agilent Web sites, 51
- Agilent, contacting, 51

## C

- Changing Configuration Parameters, 34
- Changing Modes of Operation, 35
- configuration parameters, changing, 34
- configuration parameters, setting, 34
- Configuring 82350B, 17
- connecting 82350A to PC, 11
- connecting 82350A to USB hub, 16
- Connecting GPIB Instruments, 23
- Connection Expert, 8, 36
- contacting Agilent, 51
- crossover point, 39

## E

- examples
  - Connecting Multiple GPIB Instruments, 16
  - GPIB Interface Configuration, 26

## G

- General Characteristics, 49
- GPIB
  - check for driver files, 34
  - crossover point, 39
  - interrupt mode, 38
  - Logical Unit, 21
  - polling mode, 38
  - SIICL interface ID, 21
  - System Controller, 21
  - VISA Interface ID, 21

## H

- Hard Drive, 6

## I

- I/O interface, 26
- ihint, 38
- Initial Operating States, 29

- initial operating states, [29](#)
- Installing Agilent IO Libraries Suite, [8](#)
- installing the 82350A
  - configuring the 82350A, [17](#)
- Interactive IO, [23](#)
- interface ID, [26](#)
- IO Libraries Suite, checking for installation, [8](#)
- iopen, [26](#)

## L

- LED states, [29](#)
- logical unit number, [26](#)

## M

- Modes of Operation, changing, [35](#)

## P

- PCI Bus Slot, [7](#)

## S

- setting configuration parameters, [34](#)
- setting default configuration, [17](#)
- setting timeout floor values, [37](#)
- system requirements, checking, [6](#)

## T

- troubleshooting
  - check GPIB driver files, [34](#)
  - GPIB crossover point, [39](#)
  - GPIB interrupt mode, [38](#)
  - GPIB polling mode, [38](#)

## V

- viOpen, [26](#)
- viSetAttribute, [38](#)

## W

- Web sites, Agilent, [51](#)

**www.agilent.com**

## **Contact us**

To obtain service, warranty or technical assistance, contact us at the following phone or fax numbers:

United States:

(tel) 800 829 4444 (fax) 800 829 4433

Canada:

(tel) 877 894 4414 (fax) 800 746 4866

China:

(tel) 800 810 0189 (fax) 800 820 2816

Europe:

(tel) 31 20 547 2111

Japan:

(tel) (81) 426 56 7832 (fax) (81) 426 56 7840

Korea:

(tel) (080) 769 0800 (fax) (080) 769 0900

Latin America:

(tel) (305) 269 7500

Taiwan:

(tel) 0800 047 866 (fax) 0800 286 331

Other Asia Pacific Countries:

(tel) (65) 6375 8100 (fax) (65) 6755 0042

Or visit Agilent World Wide Web at:

[www.agilent.com/find/assist](http://www.agilent.com/find/assist)

Product specifications and descriptions in this document are subject to change without notice. Always refer to Agilent web site for the latest revision.

© Agilent Technologies, Inc. 2002 - 2009

Printed in Malaysia

Eighth Edition, July 20, 2009



82350-90004



**Agilent Technologies**