

User's Guide

AHA-1510A/1520A Series ISA-to-SCSI Host Adapter

AHA-1510A/20A Series User's Guide
Stock Number: 510400-00, Rev. C Page: Front Cover
Print Spec Number: 491842-00
Current Date: 12/7/94 ECN Date: 11/29/94

Adaptec, Inc.
691 South Milpitas Boulevard
Milpitas, CA 95035

Copyright © 1994, Adaptec, Inc.
All rights reserved. Adaptec and the
Adaptec logo are trademarks of Adaptec,
Inc. which may be registered in some
jurisdictions.

Printed in Singapore
STOCK NO.: 510400-00, Rev. C MA 12/94

AHA-1510A/20A Series User's Guide
Stock Number: 510400-00, Rev. C Page: -2
Print Spec Number: 491842-00
Current Date: 12/7/94 ECN Date: 11/29/94

▼▼▼▼ **AHA-1510A/1520A Series**
ISA-to-SCSI Host Adapter

User's Guide



Copyright

Copyright © 1994 Adaptec, Inc. All rights reserved. No part of this publication may be reproduced, stored in a retrieval system, or transmitted in any form or by any means, electronic, mechanical, photocopying, recording or otherwise, without the prior written consent of Adaptec, Inc., 691 South Milpitas Blvd., Milpitas, CA 95035.

Trademarks

Adaptec, the Adaptec logo, AHA, and EZ-SCSI are trademarks of Adaptec, Inc. which may be registered in some jurisdictions.

Floptical is a trademark of Insite Peripherals which may be registered in some jurisdictions.

All other trademarks are owned by their respective owners.

Changes

The material in this document is for information only and is subject to change without notice. While reasonable efforts have been made in the preparation of this document to assure its accuracy, Adaptec, Inc. assumes no liability resulting from errors or omissions in this document, or from the use of the information contained herein.

Adaptec reserves the right to make changes in the product design without reservation and without notification to its users.

Adaptec Technical Support and Services

If you have questions about installing or using the host adapter, check this user's guide first—you will find answers to most of your questions here. If you need further assistance, please contact us. We offer the following support and information services:

- For technical support (answers to technical questions, information about the Adaptec BBS, and access to the Interactive Fax system), call 800-959-SCSI (7274) or 408-945-2550, 24 hours a day, 7 days a week. To speak with a product support representative, call 408-934-SCSI (7274), M-F: 6:00 a.m. to 5:00 p.m., Pacific Time.
- For sales information, call 800-959-SCSI (7274) or 408-945-2550, M-F: 6:00 a.m. to 5:00 p.m., Pacific Time.
- The Adaptec Electronic Bulletin Board Service (BBS) provides information on software upgrades, new releases, answers to common questions, and other topics. The BBS is available 24 hours a day, 7 days a week, at 408-945-7727; 1200/2400/9600/14,400/28,800 baud, 8 data bits, 1 stop bit, no parity.
- The Adaptec Interactive Fax system provides answers to common questions and current information about Adaptec products and services. The Adaptec Interactive Fax system is available 23 hours a day, 7 days a week. The Fax system is out of service 1 hour each day. You can call this service directly at 408-957-7150.
- To order Adaptec software and SCSI cables, call 800-442-SCSI (7274) or 408-957-SCSI (7274), M-F: 6:00 a.m. to 5:00 p.m., Pacific Time.
- To request additional documentation for Adaptec products, call 800-934-2766 or 510-732-3829, M-F: 6:00 a.m. to 5:00 p.m., Pacific Time.

FCC Compliance Statement

This equipment has been tested and found to comply with the limits for a Class B digital device, pursuant to Part 15 of the FCC rules. These limits are designed to provide reasonable protection against harmful interference in residential installations. This equipment generates, uses, and can radiate radio frequency energy, and if not installed and used in accordance with the instructions, may cause harmful interference to radio communications. However, there is no guarantee that interference will not occur in a particular installation.

If this equipment does cause interference to radio or television equipment reception, which can be determined by turning the equipment off and on, the user is encouraged to try to correct the interference by one or more of the following measures:

- Reorient or relocate the receiving antenna
- Move the equipment away from the receiver
- Plug the equipment into an outlet on a circuit different from that to which the receiver is powered
- If necessary, the user should consult the dealer or an experienced radio/television technician for additional suggestions

CAUTION: Only equipment certified to comply with Class B (computer input/output devices, terminals, printers, etc.) should be attached to this equipment, and must have shielded interface cables.

Finally, any changes or modifications to the equipment by the user not expressly approved by the grantee or manufacturer could void the user's authority to operate such equipment.

Each host adapter is equipped with an FCC compliance label which shows only the FCC identification number. The full text of the associated label follows:

This device complies with part 15 of the FCC rules. Operation is subject to the following two conditions: (1) this device may not cause harmful interference and (2) this device must accept any interference received, including interference that may cause undesired operation.

▼▼▼▼ Table of Contents

Preface

Inside This Manual xi

Conventions xii

Advisories xiii

1 Introduction

General Product Information 1-1

Features 1-2

Fast Data Transfer 1-2

Superior Price/Performance Value 1-2

Multitasking 1-2

Connectivity 1-2

Compatibility 1-2

Software Support 1-3

Product Specifications 1-4

Physical Dimensions 1-4

Power Requirements 1-4

Environmental Requirements 1-4

2 Host Adapter Configuration

Jumper Block Locations 2-2

Default Settings 2-3

Jumper Block J5 2-4

Jumper Block J6 2-5

Jumper Block J7 2-6

Jumper Block J8 2-6

Jumper Block J9 (AHA-1520A/1522A) 2-7

Jumper Block J9 (AHA-1510A) 2-8

Host Adapter Settings 2-9

SCSI Disconnection 2-9

SCSI ID 2-9

SCSI Parity Checking 2-9

- SCSI Termination 2-10
- Synchronous Negotiation 2-10
- Interrupt Channel 2-10
- ISA Port Address 2-11
- SCSI BIOS 2-11
- SCSI Boot 2-11
- ISA BIOS Address 2-11
- Floppy Disk Controller 2-12
- Optional Host Adapter Settings 2-12
 - Data Transfer Mode 2-12
 - SCSI Floptical Support 2-13
 - Fast SCSI 2-13
 - Extended BIOS Translation for DOS Drives
> 1 GByte 2-13

3 Hardware Installation

- Host Adapter Layout 3-1
- Terminating the SCSI Bus 3-2
 - Terminating SCSI Devices 3-2
 - Terminating the Host Adapter 3-2
 - Termination for Internal Devices Only 3-3
 - Termination for External Devices Only 3-4
 - Termination for Internal and External
Devices 3-4
- Setting SCSI IDs 3-5
- Inserting the Host Adapter in a Slot 3-5
- Connecting SCSI Devices 3-7
 - Choosing SCSI Cables 3-7
 - Maximum Cable Lengths 3-7
 - Connecting Internal SCSI Devices 3-8
 - Connecting External SCSI Devices 3-9
- Connecting Floppy Drives (AHA-1522A only) 3-11
- Completing Installation 3-13

4 Software Support

- DOS/Windows 4-1
- Adaptec EZ-SCSI 4-1
- Other Operating Systems 4-2

5 Troubleshooting

- Operating Problems 5-1
- Other Error Messages 5-5

A Support for Large Disk Drives

- Extended Translation (Using MS-DOS 5.0) A-1
- When to Enable Extended Translation A-1
- Using Fdisk A-2
- Extended Translation Questions and Answers A-2

B Floptical Drive Support

- Floptical Installation B-1
- Floptical Diskettes and The Host Adapter B-1
- Floppy Device Drive Assignment B-2
- VHD Format B-3

AHA-1510A/20A Series User's Guide

Stock Number: 510400-00, Rev. C

Page: viii

Print Spec Number: 491842-00

Current Date: 11/18/94

ECN Date: 11/29/94

▼▼▼▼ List of Figures

- 2-1 AHA-1520A/1522A Jumper Blocks 2-2
- 2-2 AHA-1510A Jumper Block 2-2

- 3-1 Host Adapter Terminators 3-2
- 3-2 Connecting Internal Devices Only 3-3
- 3-3 Connecting External Devices Only 3-4
- 3-4 Connecting Internal and External Devices 3-4
- 3-5 Inserting the Host Adapter in a Slot 3-6
- 3-6 Internal SCSI Ribbon Cable to Host Adapter 3-8
- 3-7 Internal SCSI Ribbon Cable to Internal SCSI Device 3-9
- 3-8 Daisy Chaining External SCSI Devices 3-9
- 3-9 External Cable to Host Adapter 3-10
- 3-10 External Cable to External SCSI Device 3-10
- 3-11 Connecting Floppy Cable to Host Adapter 3-11
- 3-12 Connecting Floppy Cable to Floppy Drive 3-12
- 3-13 Connecting a Second Floppy Drive 3-12

▼▼▼▼ Preface

Inside This Manual

This manual explains how to install and use Adaptec AHA-1510A/1520A/1522A host adapters. For convenience, we will refer to these three host adapter models collectively as the AHA-1510A/20A Series.

- Chapter 1 Introduction**
has general information about product features, benefits and specifications.
- Chapter 2 Host Adapter Configuration**
describes the host adapter factory defaults, optional features, and how to change host adapter settings.
- Chapter 3 Hardware Installation**
describes how to install the host adapter in your computer.
- Chapter 4 Software Support**
describes Adaptec's EZ-SCSI software for DOS and Windows.
- Chapter 5 Troubleshooting**
has information to assist you in troubleshooting problems that may occur during installation and configuration.
- Appendix A Support for Large Disk Drives**
describes Adaptec's support for disk drives > 1GByte under DOS.
- Appendix B Floptical Drive Support**
describes support for SCSI Floptical drives and how to use this optional feature.

Conventions

The following typographic conventions are used in this manual.

bold

Used for keystrokes (... press the **Enter** key ...).

Helvetica

Used for operator entry that must be typed exactly as shown (... device=c:aspi2dos.sys ...) and for messages on the screen (... Enter Password ...).

Helvetica Italics

Used as a place holder for text you must determine and type in (... enter *nn* for number ...). Also used for program and file names that appear in body text (... the *autoexec.bat* file ...).

Italics

Used for emphasis (... is *only* supported ...) and for document reference (... refer to Chapter 3, *Hardware Installation...*).

Hexadecimal Numbers

Are followed by an 'h', e.g., 330h.

End Mark

The □ symbol marks the end of the text for each chapter.

Advisories

Advisories are quick notes that stress an important point or warn of a potential hazard to your system, your data and/or your personal safety. This manual uses three kinds of advisories:

Note: Text set off in this way presents reminders, tips or suggestions that may make it easier for you to install, configure and use your host adapter.

Caution: Failure to observe this kind of advisory could result in loss of data or damage to your system and installed devices

WARNING: Failure to observe this kind of advisory could result in personal injury.

Use caution when handling any electrical equipment.

Advisories in this manual can only cover the procedures contained here, and not all situations may have been addressed. Adaptec does not claim to have included every condition or situation that might require a Caution or Warning. You must refer to the documentation for your computer and peripheral devices when you are installing equipment or changing its configuration.



AHA-1510A/20A Series User's Guide

Stock Number: 510400-00, Rev. C

Page: xiv

Print Spec Number: 491842-00

Current Date: 11/18/94

ECN Date: 11/29/94

▼▼▼▼ 1 Introduction

General Product Information

The AHA-1510A/20A Series consists of three host adapter models:

- **AHA-1510A:** ISA-to-SCSI host adapter
- **AHA-1520A:** ISA-to-SCSI host adapter with onboard BIOS
- **AHA-1522A:** ISA-to-SCSI host adapter with onboard BIOS and floppy drive controller

Adaptec's AHA-1510A/20A Series host adapters break the price/performance barrier with multitasking ISA-to-SCSI I/O performance. These host adapters greatly enhance the I/O performance of ISA-bus and EISA-bus microcomputers with the much faster SCSI data transfer rates. AHA-1510A/20A Series host adapters provide superior data I/O performance at an affordable price.

AHA-1510A/20A Series host adapters excel in single user environments (i.e., stand-alone computers or network nodes) by utilizing the CPU's untapped power to improve system I/O performance. AHA-1510A/20A Series host adapters support up to eight simultaneous I/O tasks and can connect up to 56 devices (7 SCSI targets with 8 logical units per target).

AHA-1510A/20A Series host adapters are fully compatible with most SCSI devices and ISA-bus/EISA-bus computers. They fully support SCSI-1 and SCSI-2.

AHA-1510A/20A Series host adapters give you access to Adaptec's ASPI (Advanced SCSI Programming Interface) family of software. This family includes device drivers that work with tape, disk, CD-ROM, WORM, and DAT devices and also with operating systems such as DOS, OS/2, UNIX, and NetWare. The ASPI software communicates with the operating system managers through the common ASPI platform.

Features

Fast Data Transfer

- 10 MBytes/second synchronous Fast SCSI data rate
- 5 MBytes/second synchronous SCSI data rate
- 3 MBytes/second data rate on the ISA bus, the highest speed allowed in the Programmed I/O (PIO) environment
- 2 MBytes/second asynchronous SCSI data rate

Superior Price/Performance Value

- High speed PIO data transfer
- Optional high speed DMA data transfer (supported under OS/2 on EISA-bus computers)
- Minimal SCSI overhead in single-tasking environments when utilizing disconnect/reconnect capabilities
- 16-bit host bus data transfer widths

Multitasking

- Each host adapter supports up to eight simultaneous I/O tasks when utilizing SCSI-2 Disconnect/Reconnect feature.

Connectivity

- Each host adapter supports up to seven SCSI devices and up to eight logical units (LUNs) per SCSI device.
- Full SCSI Floppy/Floptical[®] (21 MByte) diskette supports configurations of up to four floppy-type diskettes (up to two standard floppy diskettes).
- Supports both synchronous and asynchronous devices: disk drives, tape, CD-ROM, WORM, DAT, etc.

Compatibility

- SCSI BIOS with boot capability and support for up to two hard disk drives under DOS (AHA-1520A/1522A only)
- Supports SCSI hard disks with capacities above 1 GByte

- ASPI and software driver support for all major operating systems, including DOS, OS/2, UNIX, and Netware
- Compatible with a wide variety of computer systems and SCSI devices
- Full support of SCSI-1 and SCSI-2
- Floppy controller option support for all standard floppy disk drives (AHA-1522A only)
- Optional built-in SCSI Floppy/Floptical diskette drive support
- Compact design; half-card size fits easily into desktop PCs, as well as many slots in laptop computers

Software Support

- Adaptec EZ-SCSI software automatically configures your system and peripherals
- Advanced SCSI features support through Adaptec's ASPI Manager software
- *aspi2dos* ASPI manager (included in Adaptec EZ-SCSI) enables optimal performance in DOS/Windows environment
- Modular software driver structure allows for an expanding library of off-the-shelf device modules
- Pass-through interface available to third-party software developers

Product Specifications

Physical Dimensions

- Length: 6.875"
- Width: 4.18"
- Thickness: 0.5"

Power Requirements

- 5.25 V to 4.75 V tolerance on the ISA power supply

Environmental Requirements

- Temperature (operating or storage) 0-55 °C (32-131 °F)



▼▼▼▼ 2 Host Adapter Configuration

AHA-1510A/20A Series host adapters are designed to operate as shipped in most ISA-bus and EISA-bus computer systems.

This chapter explains the default and optional settings for the AHA-1510A/20A Series host adapter. You will learn when to change the default settings and how to do so.

Some AHA-1510A/20A Series configuration parameters, such as SCSI ID and termination, are pre-set at the factory. These default settings are listed on page 2-3. Most of the configuration parameters are set with onboard jumpers. Some AHA-1510A parameters are set with jumpers, and some are set with command line switches in the *config.sys* file.

Caution: You should not change the default jumper settings unless you thoroughly understand the consequences of the change.

Jumper Block Locations

AHA-1520A host adapters have four jumper blocks, labeled J5, J6, J8 and J9. (These labels are printed on the board next to the jumper blocks.) AHA-1522A host adapters have an additional jumper block, J7, to enable or disable the floppy controller. Figure 2-1 shows the location of these jumper blocks.

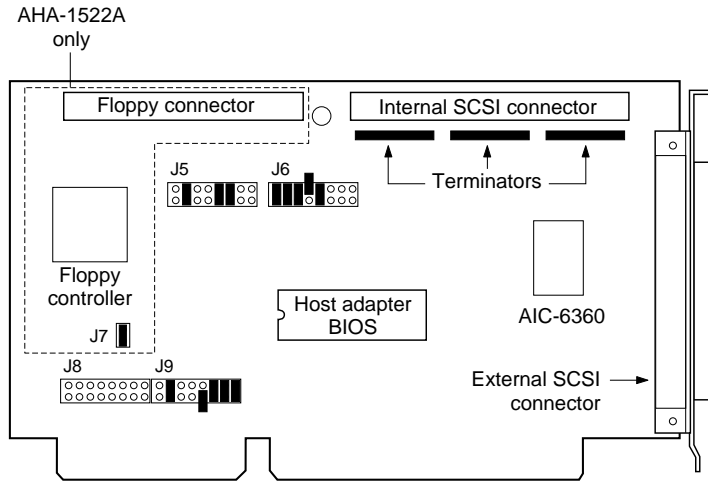

Figure 2-1. AHA-1520A/1522A Jumper Blocks

The AHA-1510A host adapter has only one jumper block, J9, which is described on page 2-8. Figure 2-2 shows its location.

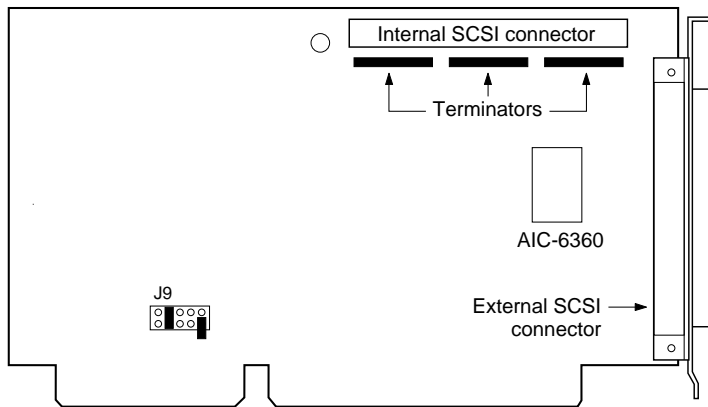

Figure 2-2. AHA-1510A Jumper Block

Default Settings

AHA-1510A/20A Series host adapters have the default setting shown in the following table. These settings are appropriate for most computer systems. If you want to change any of these settings, see the descriptions of each setting in the following sections.

Host Adapter Settings	Default Value
SCSI Disconnection	Enabled
SCSI ID	7
SCSI Parity	Enabled
Terminators	Installed
Synchronous Negotiation	Enabled
Interrupt host adapter	11
ISA Port Address	340h
ISA BIOS Address	DC000h,Enabled
Floppy Disk Controller	Enabled (AHA-1522A)
Data Transfer Mode	Programmed I/O
SCSI Floppy/Optical	Disabled
Fast SCSI	Disabled
> 1 GByte Translation	Disabled

Jumper Block J5











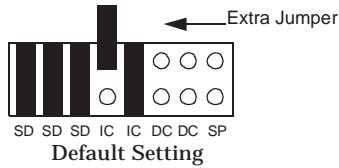







































Default Setting

Pin Pair	Description
DT	Set data transfer mode DMA enabled = jumper PIO (programmed I/O)* = no jumper DMA transfer mode is not supported under DOS or Windows. It is supported under OS/2 on EISA-bus computers.
BT	Enable/disable boot from host adapter BIOS Boot from host adapter BIOS* = jumper Do not boot from host adapter = no jumper
M0	No jumper
M1	Enable/disable Fast SCSI Fast SCSI on = jumper Fast SCSI off* = no jumper
SN	Enable/disable synchronous negotiation Synchronous negotiation on* = jumper Synchronous negotiation off = no jumper
DN	Enable/disable SCSI target disconnect Permit Disconnects* = jumper Do not permit Disconnect = no jumper
R-	Enable/disable SCSI Floppy/Floptical support SCSI Floppy/Floptical on = jumper Floppy/Floptical off* = no jumper
R-	Enable/disable greater than 1 GB translation > 1 GByte Translation on = jumper > 1 GByte Translation off* = no jumper

* Default setting

Jumper Block J6



Pin Pair	Description								
SD	<p>Set host adapter SCSI ID</p> <table style="width: 100%; border: none;"> <tr> <td style="text-align: center;"> = ID 7*</td> <td style="text-align: center;"> = ID 6</td> </tr> <tr> <td style="text-align: center;"> = ID 5</td> <td style="text-align: center;"> = ID 4</td> </tr> <tr> <td style="text-align: center;"> = ID 3</td> <td style="text-align: center;"> = ID 2</td> </tr> <tr> <td style="text-align: center;"> = ID 1</td> <td style="text-align: center;"> = ID 0</td> </tr> </table>	 = ID 7*	 = ID 6	 = ID 5	 = ID 4	 = ID 3	 = ID 2	 = ID 1	 = ID 0
 = ID 7*	 = ID 6								
 = ID 5	 = ID 4								
 = ID 3	 = ID 2								
 = ID 1	 = ID 0								
IC	<p>Set host adapter IRQ host adapter</p> <table style="width: 100%; border: none;"> <tr> <td style="text-align: center;"> = IRQ 9</td> <td style="text-align: center;"> = IRQ 10</td> </tr> <tr> <td style="text-align: center;"> = IRQ 11*</td> <td style="text-align: center;"> = IRQ 12</td> </tr> </table> <p>You must also set pin pairs on jumper block J9</p>	 = IRQ 9	 = IRQ 10	 = IRQ 11*	 = IRQ 12				
 = IRQ 9	 = IRQ 10								
 = IRQ 11*	 = IRQ 12								
DC	<p>Set host adapter DMA (only if DMA enabled on J5)</p> <table style="width: 100%; border: none;"> <tr> <td style="text-align: center;"> = Channel 0*</td> <td style="text-align: center;"> = Channel 6</td> </tr> <tr> <td style="text-align: center;"> = Channel 5</td> <td style="text-align: center;"> = Channel 7</td> </tr> </table> <p>You must also set pin pairs on jumper block J8</p>	 = Channel 0*	 = Channel 6	 = Channel 5	 = Channel 7				
 = Channel 0*	 = Channel 6								
 = Channel 5	 = Channel 7								
SP	<p>Enable/disable parity checking Parity enabled* = no jumper Parity disabled = jumper</p>								

* Default setting

Jumper Block J7

The host adapter floppy controller is enabled when the jumper is installed on jumper block J7.



★ Default setting

Caution: If the host adapter floppy controller is enabled, you must disconnect all other floppy controllers to avoid system hang.

Jumper Block J8

This jumper block is used *only* when DMA is enabled on jumper block J5 pin pair DT.

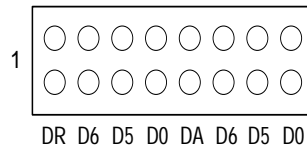

Default Setting





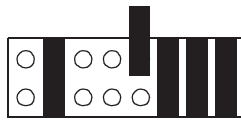







DMA Channel	Set J8 Pin Pairs
Set DMA channel	
Channel 0	D0, D0
Channel 5	D5, D5
Channel 6	D6, D6
Channel 7	DR, DA
You must also select the <i>same</i> interrupt channel with the DC pin pairs on jumper block J6.	

Jumper Block J9 (AHA-1520A/1522A)



I2 I1 I0 I9 AL J6 J4 BE

Default Setting

Pin Pair	Description				
I2, I1, I0, I9	<p>Set host adapter IRQ channel</p> <p>IRQ 12 = jumper I2 IRQ 11* = jumper I1 IRQ 10 = jumper I0 IRQ 9 = jumper I9 (not recommended with Windows 3.x)</p> <p>You <i>must</i> also set the corresponding IC pin pairs on jumper block J6.</p>				
AL	<p>Set port address</p> <p>340h * = no jumper 140h = jumper (extra jumper provided)</p> <p>The host adapter BIOS supports booting only for the default port address of 340h.</p>				
J6, J4	<p>Set BIOS address location</p> <table style="width: 100%; border: none;"> <tr> <td style="text-align: center;">  = C8000h- CBFFFh </td> <td style="text-align: center;">  = CC000h- CFFFFh </td> </tr> <tr> <td style="text-align: center;">  = D8000h- DBFFFh </td> <td style="text-align: center;">  = DC000h- DFFFFh* </td> </tr> </table>	 = C8000h- CBFFFh	 = CC000h- CFFFFh	 = D8000h- DBFFFh	 = DC000h- DFFFFh*
 = C8000h- CBFFFh	 = CC000h- CFFFFh				
 = D8000h- DBFFFh	 = DC000h- DFFFFh*				
BE	<p>Enable/disable host adapter BIOS</p> <p>Host adapter BIOS disabled = no jumper Host adapter BIOS enabled* = jumper</p>				

* Default setting

Jumper Block J9 (AHA-1510A)

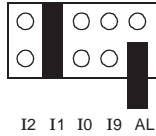

Default Setting

Pin Pair	Description
I2, I1, I0, I9	<p>Set host adapter IRQ channel</p> <p>IRQ 12 = jumper I2</p> <p>IRQ 11★ = jumper I1</p> <p>IRQ 10 = jumper I0</p> <p>IRQ 9 = jumper I9 (not recommended with Windows 3.x)</p> <p>One and only one of these pairs must be selected for proper operation of the software.</p>
AL	<p>Set port address</p> <p>340h ★ = no jumper</p> <p>140h = jumper</p> <p>An extra jumper is provided in case you want to install it on the pin pair to change the port address.</p>

★ Default setting

Host Adapter Settings

SCSI Disconnection

This setting determines whether the host adapter allows a SCSI device to disconnect from the SCSI bus (sometimes called Disconnect/Reconnect). Enabling disconnection allows the host adapter to perform other operations on the SCSI bus while the SCSI device is temporarily disconnected.

When disconnection is allowed, which is the default setting, the SCSI device may disconnect from the SCSI bus. The SCSI device may choose not to disconnect, however, even if permitted by the host adapter (this can usually be configured on the SCSI device). Leave Enable Disconnection at its default value if the host adapter connects to two or more SCSI devices. This optimizes SCSI bus performance. If the host adapter connects to only one SCSI device, set Enable Disconnection to *no* to achieve slightly better performance.

SCSI ID

Each host adapter on the host adapter has the default SCSI ID of 7, which gives the host adapter the highest priority on the SCSI bus. We recommend that you leave each host adapter ID at 7. For more information on SCSI IDs, see *Setting SCSI IDs* on page 3-5.

SCSI Parity Checking

SCSI parity checking is a procedure used by the host adapter to verify the accuracy of data transfer on the SCSI bus. By default, parity checking is enabled on all host adapter host adapters. Disable parity checking for a host adapter if any SCSI device on the host adapter does not support SCSI parity. Most currently available SCSI devices support SCSI parity. If you are not sure whether a device supports SCSI parity, consult the documentation for the device.

SCSI Termination

The default termination setting AHA-1510A/20A Series host adapters is *enabled*. Disable termination for the host adapter if you attach SCSI devices to *both* the internal and external connectors. For more information on host adapter termination, see *Terminating the SCSI Bus* on page 3-2.

Synchronous Negotiation

Synchronous negotiation is a SCSI feature that allows the SCSI host adapter and its attached SCSI devices to transfer data in synchronous mode. Synchronous data transfer is faster than asynchronous data transfer.

The Initiate Synchronous Negotiation setting determines whether the host adapter initiates synchronous negotiation with the SCSI device. At the default setting, *yes*, the host adapter initiates synchronous negotiation with the SCSI device. If you change the setting to *no*, the host adapter does not initiate synchronous negotiation; however, the host adapter always responds to synchronous negotiation if the SCSI device initiates it. If neither the host adapter nor the SCSI device negotiates for synchronous data transfers, data is transferred in asynchronous mode. You should normally leave the default setting because most SCSI devices support synchronous negotiation and because it allows for faster data transfer.

Some older SCSI-1 devices do not support synchronous negotiation. This may cause your computer to operate erratically or hang if Initiate Synchronous Negotiation is enabled. Set Initiate Synchronous Negotiation to *no* for these devices.

Interrupt Channel

Host adapters and other option cards in your computer may not share IRQ settings. If you are installing two SCSI host adapters, make sure they each have unique IRQ settings.

- The same IRQ channel must be selected on both jumper blocks J6 and J9.
- Note that some operating systems may not run properly if you assign IRQ 9 to the host adapter.

ISA Port Address

You probably will not need to change the port address, unless you are installing more than one SCSI host adapter, or you know that the current host adapter port address is in conflict with other devices. Your host adapter must not share its ISA port address with any other device on the computer. The default host adapter ISA port address is 340h. The alternate address is 140h. If you change the ISA port address, refer to Chapter 4, *Software Support*, for information on modifying your ASPI Manager device driver.

SCSI BIOS

SCSI BIOS is *enabled* by default on the AHA-1520A/1522A host adapters. This means the SCSI host adapter intercepts all hardware interrupt 13 calls. If the SCSI BIOS is successfully installed, it can support up to two SCSI hard disks. Non-SCSI interrupt 13 calls are passed to the motherboard BIOS.

SCSI Boot

SCSI boot capability is enabled by default (J5 pin pair BT jumper on). This means the host adapter intercepts hardware interrupt 19 during the boot process. If the SCSI boot process is successful, your system boots from your SCSI hard disk set at SCSI ID 0. If not, hardware interrupt 19 is passed either to another SCSI host adapter or to the motherboard BIOS.

Caution: If you are using two AHA-1520A/1522A host adapters, only one can have its SCSI boot enabled. If both host adapters have SCSI boot enabled, your system will hang.

ISA BIOS Address

You probably will not need to change the port address, unless you are installing more than one SCSI host adapter, or you know that the current host adapter BIOS address is causing a conflict in the system. The default host adapter BIOS address is DC000. Three alternate addresses are shown in *Jumper Block J9 (AHA-1520A/1522A)* on page 2-7. Each host adapter must have a unique ISA BIOS address. In addition, SCSI BIOS must be enabled as described in *Jumper Block J5* on page 2-4.

Floppy Disk Controller

The floppy controller is enabled by default on the AHA-1522A. Standard floppy drives connected to the AHA-1522A onboard floppy connector are not part of the SCSI bus. These drives are controlled by the non-SCSI floppy controller on the host adapter.

WARNING: Be sure to *disable* any other floppy controllers in your system, such as the controller on the motherboard or non-SCSI controllers. Enabling more than one floppy controllers can cause your system to hang.

Optional Host Adapter Settings

AHA-1520A/1522A host adapters also have the following optional configuration settings, which you should not change unless you thoroughly understand the consequences of doing so:

- Data transfer mode
- SCSI Floppy/Floptical
- Fast SCSI
- Extended BIOS Translation for DOS Drives > 1 GByte

Data Transfer Mode

AHA-1510A/20A Series host adapters use Programmed I/O (PIO) by default. If you must use the DMA data transfer mode, note the following:

- DMA must be enabled by setting pin pair DT on jumper block J5
- The DMA channel must be selected on both jumper blocks J6 and J8.
- The DMA channel selected for J6 and J8 must be *identical*.

SCSI Floptical Support

This setting enables support for SCSI floppy/floptical drives. This option is available on the AHA-1520A and the AHA-1522A, since SCSI floptical support is provided by the host adapter BIOS. See Appendix B, *Floptical Drive Support*, for more detailed information.

Fast SCSI

This setting determines the maximum synchronous data transfer rate for the host adapter. The Fast SCSI maximum is 10.0 MBytes/sec. Some older SCSI-1 devices, however, do not support Fast SCSI data transfer rate. This may cause your computer to operate erratically or hang. Do not enable Fast SCSI for these devices.

If the host adapter is set *not* to negotiate for synchronous data transfer (i.e., Initiate Synchronous Negotiation is disabled), then the value selected here is the maximum rate at which the host adapter accepts data from the device during negotiation. (This is standard SCSI protocol.)

Extended BIOS Translation for DOS Drives > 1 GByte

This setting enables or disables extended translation for SCSI hard disks with a capacity greater than 1 GByte (up to 8 GBytes). When enabled, which is the default setting, the following translation schemes are used:

- SCSI hard disks \leq 1 GByte use a translation scheme of 64 heads, 32 sectors per track.
- SCSI hard disks $>$ 1 GByte use a translation scheme of 255 heads, 63 sectors per track.

See Appendix A, *Support for Large Disk Drives*, for more information on extended translation.

Note: The setting for Extended BIOS Translation for DOS Drives > 1 GByte is valid only if the host adapter BIOS is enabled.



▼▼▼▼ 3 Hardware Installation

This chapter explains how to physically install the AHA-1510A/20A Series host adapter in your computer and connect SCSI devices to it. The chapter takes you through each of the following steps:

- Terminating the SCSI bus
- Changing the SCSI IDs of devices that have duplicate IDs
- Installing the host adapter in your computer
- Connecting the SCSI devices to the host adapter

See your computer hardware documentation for more information. AHA-1510A/20A host adapters are configured to provide optimum performance for most systems. Read Chapter 2, *Host Adapter Configuration*, to learn about changing host adapter configuration.

Note: You cannot change the configuration of the host adapter after it is installed unless you physically remove it from your computer.

Host Adapter Layout

The major AHA-1520A/1522A components, including the internal and external SCSI connectors, are shown in Figure 2-1 on page 2-2. The major AHA-1510A components are shown in Figure 2-2 on page 2-2. You may find it helpful to refer to these diagrams while installing the host adapter and attaching the cables.

Terminating the SCSI Bus

A set of resistors called *terminators* must be either installed in or enabled on the first and last physical devices on each host adapter channel; otherwise, the devices will not operate properly. You may need to change the termination setting on some SCSI devices when you install them. In general, the procedure for terminating the SCSI bus is as follows:

- 1 Determine which two SCSI devices (including the host adapter) are at the two ends of the SCSI bus. Terminate these devices, if they are not already terminated.
- 2 Disable termination on all other devices on the SCSI bus, if it is not already disabled.

Terminating SCSI Devices

Most SCSI disk drives, CD-ROM drives, and other SCSI devices have a jumper or a switch close to the SCSI connector that controls SCSI termination. Other devices have resistor modules that you can physically remove or insert. Read the device documentation if you are not sure how to determine the termination setting or how to enable or disable termination.

Terminating the Host Adapter

The three host adapter terminators are just below the internal SCSI connector, as shown in Figure 3-1

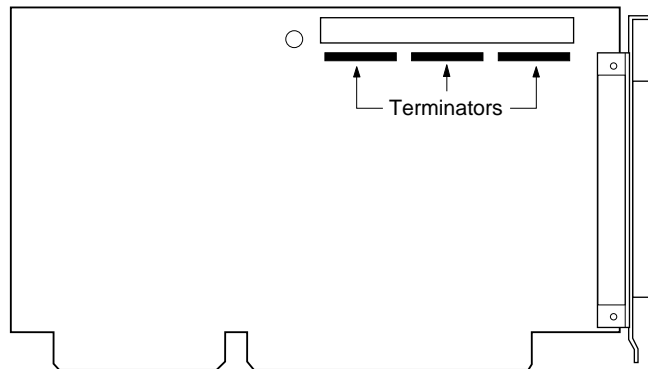

Figure 3-1. Host Adapter Terminators

The table below shows how termination must be set on the host adapter for the three possible configurations of devices on the SCSI bus. If you need to change the termination setting, follow the instructions in *Terminating the SCSI Bus* on page 3-2.

Devices Connected to Host Adapter	Host Adapter Terminators
Internal devices only (host adapter at end of cable)	All three installed
External devices only (host adapter at end of cable)	All three installed
Internal and external devices (host adapter in the middle)	All three removed

The following sections explain each of the three configurations.

Termination for Internal Devices Only

When only internal devices are connected to the host adapter, the last device connected to the ribbon cable should be terminated and the host adapter should be terminated, as shown in Figure 3-2.

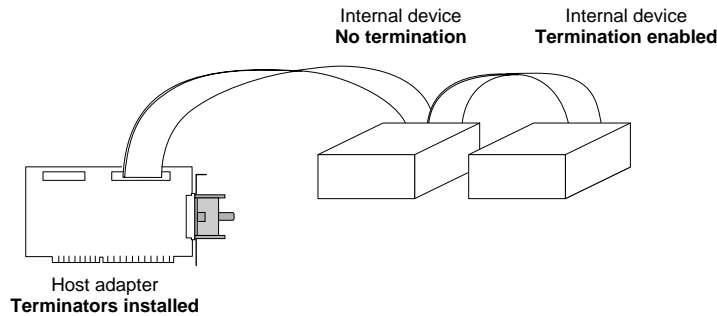

Figure 3-2. Connecting Internal Devices Only

Termination for External Devices Only

When only external devices are connected to the host adapter, the last device on the external chain of devices should be terminated and the host adapter should be terminated, as shown in Figure 3-3.

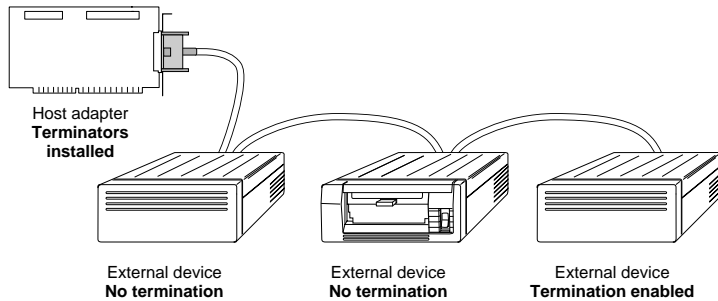

Figure 3-3. Connecting External Devices Only

Termination for Internal and External Devices

When both internal and external devices are connected to the host adapter, the last external device and the last internal device should be terminated, and you should *remove* the three terminators (i.e., disable termination) on the host adapter, as shown in Figure 3-4.

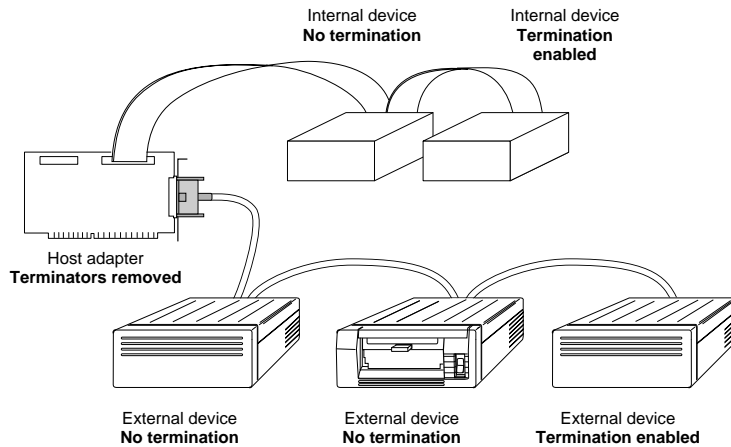

Figure 3-4. Connecting Internal and External Devices

Caution: If you replace the host adapter terminators, make sure you maintain correct orientation. The dot on the upper left corner of the resistor must align with pin 1 of the socket.

Setting SCSI IDs

Each device on the SCSI bus, including the host adapter, must have a unique SCSI ID. The ID uniquely define each device on the SCSI bus and determine which device controls the bus when two or more devices try to use it at the same time. ID 7 has the highest priority, and ID 0 has the lowest.

Setting SCSI IDs is a two-step process:

- 1 Determine the ID of each device on the SCSI bus.

The default ID for the AHA-1510A/20A is ID 7. To determine the IDs of disk drives, CD-ROM drives, and other devices, read their documentation and examine their switch settings or jumper settings.
- 2 Change the IDs (if needed) so that no IDs are duplicated on the same host adapter. We recommend the following IDs:
 - Leave the AHA-1510A/20A at the default, SCSI ID 7.
 - If you are installing Floptical drives, set them to SCSI IDs 2 through 6.
 - If you want to boot your computer from a SCSI hard disk drive, set the drive ID to 0.

See the SCSI device documentation for instructions on changing the SCSI ID.

Inserting the Host Adapter in a Slot

WARNING: Be sure the power is turned OFF before you continue. Also, ground yourself by touching an unpainted surface on the computer chassis before you open the computer case.

- 1 Remove the cover from the computer case.
- 2 Locate an unused, unobstructed expansion slot.
- 3 Remove the corresponding expansion slot cover from the back of the computer chassis. (The slot cover is the metal strip that covers the opening through which the host adapter's external connector extends.) Keep the screw that held the metal strip in place; you will need it later.

- 4 Ground yourself by touching an unpainted surface on the computer chassis, then carefully remove the host adapter from its package.
- 5 Position the host adapter directly over the slot. If your computer has a card guide to align the host adapter, be sure to insert the end of the board in the card guide.
- 6 Carefully press the bus connector on the bottom of the host adapter down into the slot, as shown in Figure 3-5, until the metal contacts on the bottom of the host adapter are securely seated in the slot.

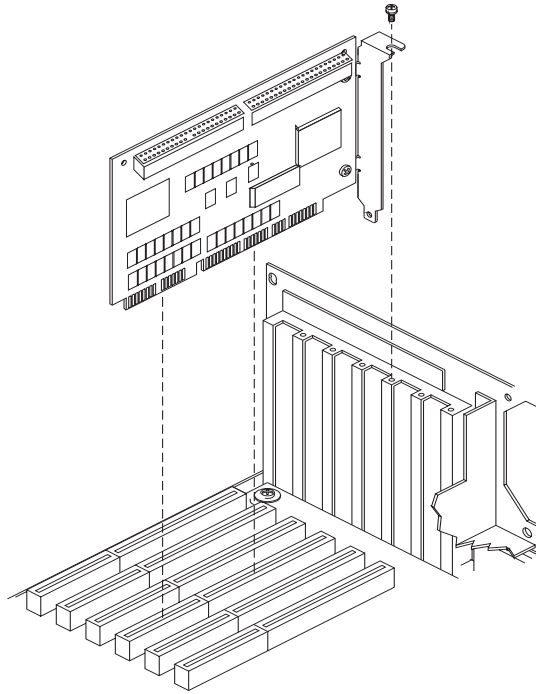

Figure 3-5. Inserting the Host Adapter in a Slot

- 7 Attach the host adapter bracket to the computer chassis with the screw from the expansion slot cover that you removed.

Note: *Do not* put the computer cover back on or reconnect the power yet!

Connecting SCSI Devices

SCSI devices are connected by cables in one continuous line called the *SCSI bus*. Each host adapter on the AHA-1510A/20A implements a separate SCSI bus, supporting up to seven 8-bit devices. AHA-1510A/20A Series host adapters have an internal and external SCSI connector to which you can attach up to seven SCSI devices.

This section explains how to connect both internal and external SCSI devices to the host adapter connectors.

Caution: AHA-1510A/20A host adapters support only *single-ended* SCSI devices. *Differential* SCSI devices may be damaged if you connect them to the host adapter bus. Most SCSI devices are single-ended. Read your SCSI device documentation if you are not sure whether a device is single-ended or differential.

Choosing SCSI Cables

Always use high-quality SCSI cables to connect the host adapter to devices on the SCSI bus. Poor-quality cables can cause data corruption, parity errors, and other problems. High-quality cabling is especially critical if you use Fast SCSI data transfer rates.

The round cables used for external SCSI devices vary widely in quality and electrical characteristics. Be sure that external SCSI cables meet SCSI-2 standards (your cable vendor can tell you this). Here are some guidelines for external SCSI cables:

- Use cables with a single-ended impedance range of 80-110 ohms.
- Do not use cables shorter than 30 cm (11.8 inches) between any two SCSI devices.

Adaptec sells high-quality internal and external SCSI-2 cables, which you can purchase by calling Adaptec at the number listed on page ii.

Maximum Cable Lengths

To assure reliable operation, the total length of the SCSI bus, including both internal and external cabling, should not exceed

- 6 meters (19.7 feet) if you are using asynchronous or synchronous data transfer rates
- 3 meters (9.8 feet) if you are using Fast SCSI data transfer rates

Connecting Internal SCSI Devices

To connect an internal SCSI device to the host adapter, you need a 50-conductor SCSI ribbon cable with a 50-pin internal connector. If you are attaching more than one internal device, the ribbon cable must have additional connectors.

Follow these steps to connect internal SCSI devices to the internal connector on the host adapter:

- 1 Obtain a SCSI ribbon cable that has enough connectors to accommodate all of the internal SCSI devices. If you need to physically install the SCSI device inside your computer before attaching the cables, follow the installation instructions in the device documentation.
- 2 Plug the SCSI connector at one end of the ribbon cable into the host adapter's internal SCSI connector, as shown in Figure 3-6.

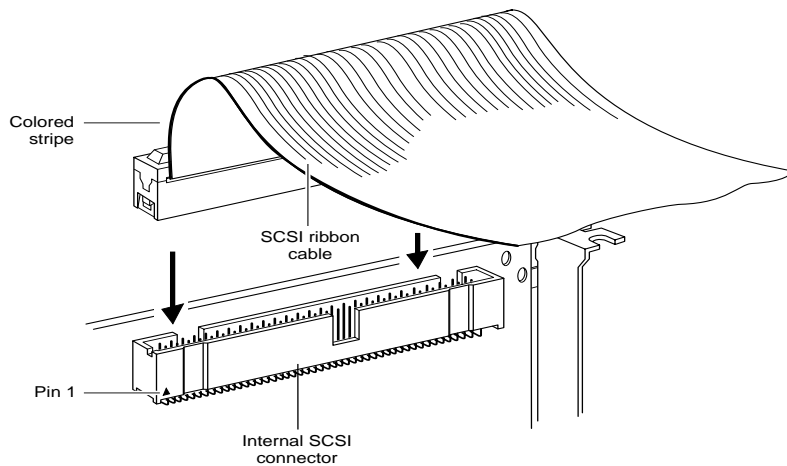

Figure 3-6. Internal SCSI Ribbon Cable to Host Adapter

- 3 The colored stripe on one side of the ribbon cable must match up with the number 1 printed on the host adapter board beneath the connector. This is called maintaining proper *pin-1 orientation*. Maintain pin-1 orientation throughout the SCSI bus, or your SCSI devices will not work properly.
- 4 Plug the last connector on the ribbon cable into the SCSI connector on the internal SCSI device.

- 5 To connect other internal SCSI devices, plug the devices into the other connectors on the ribbon cable, as shown in Figure 3-7.

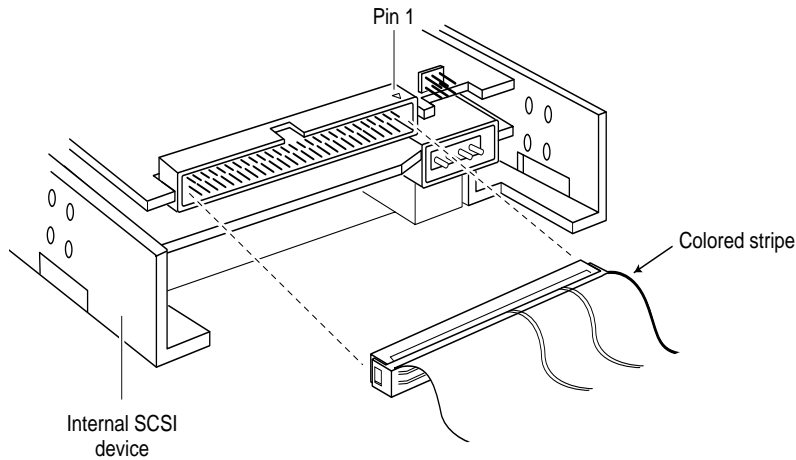

Figure 3-7. Internal SCSI Ribbon Cable to Internal SCSI Device

Connecting External SCSI Devices

You can daisy chain up to seven external SCSI devices to the external connector on the host adapter. *Daisy chaining* means connecting multiple devices in a series, as shown in Figure 3-8. A cable runs from the external host adapter connector to the first external device; a second cable connects the first external device with the second external device; and so on.

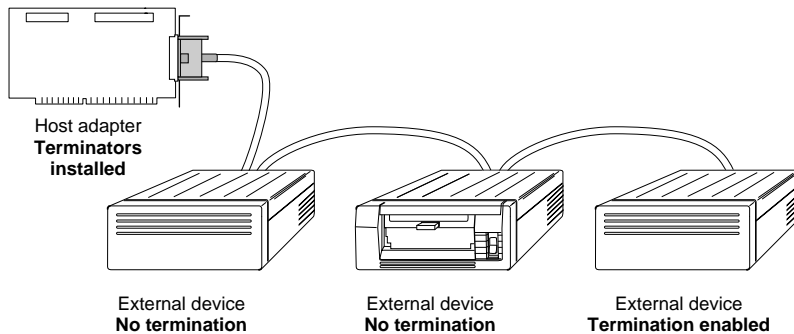

Figure 3-8. Daisy Chaining External SCSI Devices

Follow these steps to connect external SCSI devices:

- 1 Attach the external SCSI cable to the external SCSI connector, as shown in Figure 3-9. External cable orientation is automatic since connectors can be plugged in only one way.

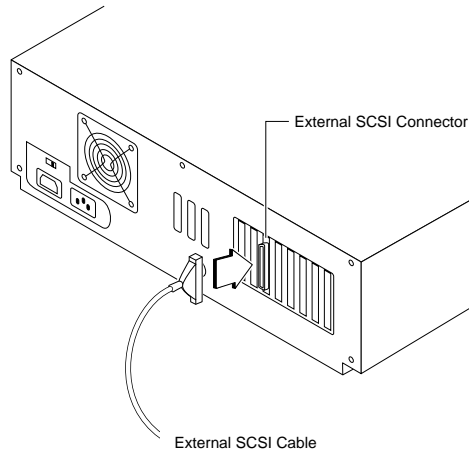

Figure 3-9. External Cable to Host Adapter

- 2 Attach the connector at the other end of the external cable to either one of the SCSI connectors on the external SCSI device, as shown in Figure 3-10.

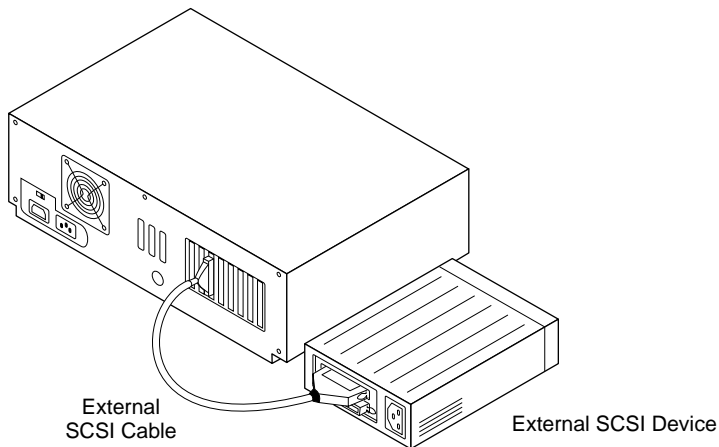

Figure 3-10. External Cable to External SCSI Device

- 3 Daisy chain other external SCSI devices, if any, to the previous device until all devices are connected, as shown in Figure 3-8.

Connecting Floppy Drives (AHA-1522A only)

The AHA-1522A floppy connector uses a 34-pin floppy ribbon cable with a 34-pin header connector. Be sure to maintain pin-1 orientation, as described in *Connecting Internal SCSI Devices* on page 3-8.

- 1 Connect the non-split end of the 34-pin floppy ribbon cable to the floppy connector, as shown in Figure 3-11.

- 2 Connect the split end of the 34-pin floppy ribbon cable to the connector on the first floppy drive (A), as shown in Figure 3-12.

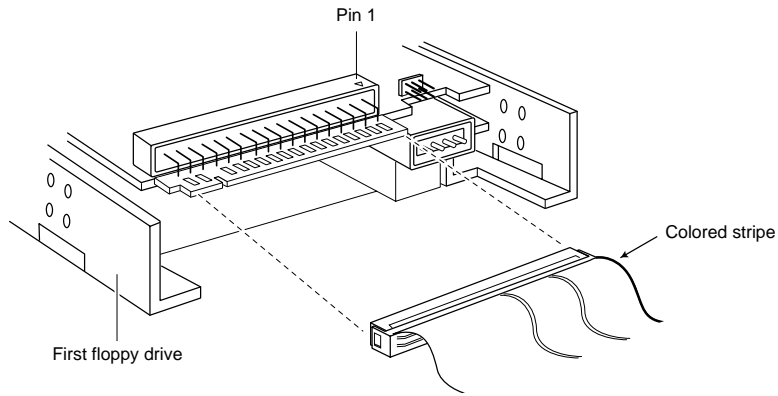

Figure 3-12. Connecting Floppy Cable to Floppy Drive

- 3 To connect a second floppy drive, plug the middle connector of the floppy ribbon cable to the connector on the second floppy drive (B), as shown in Figure 3-13.

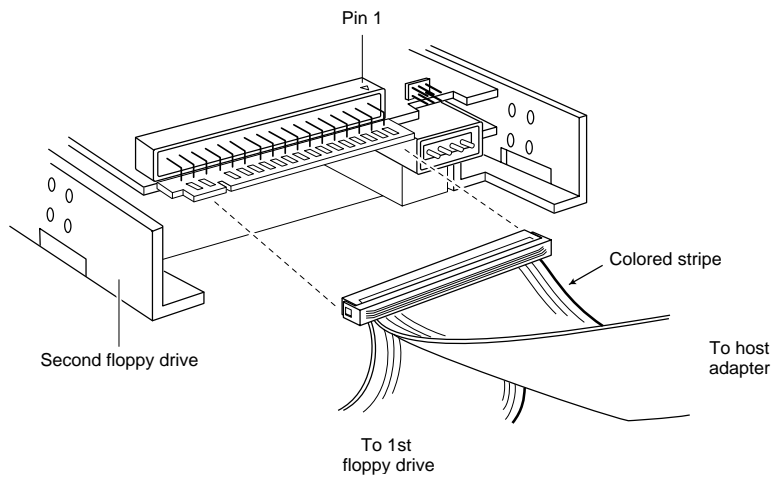

Figure 3-13. Connecting a Second Floppy Drive

Completing Installation

Before you reassemble your computer, be sure that

- The host adapter is firmly seated and secured in the slot
- The devices on each SCSI bus are properly terminated
- Each SCSI device on the SCSI bus has a unique SCSI ID
- Internal and external SCSI devices are firmly connected to the host adapter, and pin-1 orientation is correct
- Only one floppy controller is enabled (AHA-1522A only)
Many computers have floppy controllers on the motherboard or on a non-SCSI controller.

Follow these steps to complete installation:

- 1 Replace and secure the cover of the computer case.
- 2 Reconnect the power cords to all external SCSI devices and the computer.
- 3 Turn ON the power to all devices.
- 4 Boot the computer.

See Chapter 5, *Troubleshooting*, if you encounter any problems during installation.



▼▼▼▼ 4 Software Support

DOS/Windows

When you are using AHA-1520A/1522A host adapters under DOS, you can connect up to two SCSI hard disk drives per host adapter without additional software. AHA-1510A host adapters always need additional device drivers because they have no onboard BIOS.

You need additional software if you want to do any of the following with your AHA-1520A/1522A host adapter:

- Support more than two SCSI hard disk drives
- Remove or switch removable media (for example, Bernoulli cartridges) while your computer is running
- Support CD-ROM drives
- Support devices other than CD-ROM drives and disk drives—for example, SCSI tape drives, scanners, plotters, or WORM drives
- Disable the BIOS on the AHA-1520A/1522A host adapter

Adaptec EZ-SCSI

If you are running under DOS or Windows, Adaptec EZ-SCSI software makes driver installation easier than ever before. Adaptec EZ-SCSI is a menu-driven software package that configures your operating environment automatically.

Adaptec EZ-SCSI includes a number of software applications, such as an audio CD player for DOS and Windows, a tape backup program, and a data transfer benchmarking utility. It includes DOS and Windows formatting utilities for SCSI disk devices. Adaptec EZ-SCSI also includes ASPI device drivers that support most models of CD-ROM drives and SCSI disk devices.

To provide support for SCSI devices other than fixed disk devices and CD-ROM drives, check the hardware documentation for those devices. If the device requires ASPI support, you first need to run Adaptec EZ-SCSI to install an ASPI manager, and then install any other software provided with the device. If the device is designed to interface directly with the host adapter, then no ASPI manager is required.

See the *Adaptec EZ-SCSI User's Manual* for instructions on installing and running Adaptec EZ-SCSI software.

Other Operating Systems

Adaptec also provides embedded or floppy-based software support for NetWare, OS/2, and UNIX. For installation instructions, refer to the documentation provided with the specific software.



▼▼▼▼ 5 Troubleshooting

This chapter explains what to do if you have problems with your system after installing an AHA-1510A/20A Series host adapter.

If the information in this chapter does not solve your problems, contact your reseller for support. You can also leave questions on the Adaptec Bulletin Board Service (BBS) at the phone number listed in the front of this manual.

Operating Problems

Problem

The system will not boot from the standard floppy drive or hard drive after initial hardware installation. (1520A/1522A only)

Action

- 1 The LED on the host adapter should light up briefly when you power up the system. If the host adapter detects an internal failure, a message is displayed on the screen. Return the board to the place where you bought it for repair or replacement.
- 2 If the host adapter and SCSI drive LEDs always remain on, the pin-1 orientation of the SCSI cable is probably reversed between the host adapter and the drive. Fix the cable orientation. (See *Connecting Internal SCSI Devices* on page 3-8.)
- 3 If the host adapter BIOS message is not displayed on the screen, the system does not recognize the BIOS.
 - a Check for BIOS address conflicts between the host adapter and other option boards.
 - b Try a different BIOS address. Refer to jumper block J9 in Chapter 2, *Host Adapter Configuration*.
 - c Make sure the host adapter BIOS is enabled. The jumper on pin pair BE of jumper block J9 must be installed (factory default).

- d If two AHA-1520A/1522A host adapters are installed, make sure only *one* has its BIOS enabled.
- 4 If you see the message Host Adapter Not Found At Port 340h, check the ISA port address jumper setting. Refer to jumper block J9 in Chapter 2, *Host Adapter Configuration*.
- 5 Make sure that the floppy disk drive is cabled correctly.
- 6 Make sure only one floppy controller is enabled in the system.

Problem

No software driver is installed for the host adapter. The system will not boot from the SCSI hard disk drive, and the Adaptec logo does not appear on the screen during booting (AHA-1520A/1522A only).

This problem indicates that the host adapter BIOS is not running.

Action

- 1 Make sure the jumper is installed on pin pair BE of jumper block J9. (This factory default setting enables the BIOS.)
- 2 Make sure that the host adapter is firmly seated in the slot.
- 3 Make sure that there is no SCSI ID addressing conflict. Check the jumpers for proper installation.
- 4 Make sure that the SCSI hard drives set up as the first two hard drives in the system are set to Not Installed or No Drives Installed in your CMOS Setup program.
- 5 If necessary, back up all data on the desired boot hard disk and perform a high-level or low-level format on it.
- 6 If your system is running under DOS, be sure that the intended boot disk has an active DOS partition and a DOS format.
- 7 If your system is attempting to boot from the SCSI hard drive, make sure that the address of the hard drive you want to boot from is set to SCSI ID 0:0.
- 8 Make sure that SCSI parity is consistently enabled or disabled on all devices on the SCSI bus.
- 9 Make sure that SCSI termination is set correctly on the host adapter and the peripherals. (See *Terminating the SCSI Bus* on page 3-2.)

Problem

The *aspi2dos* ASPI manager is installed. The system will not boot from the SCSI hard disk drive, and the *aspi2dos* logo does not appear on the screen.

Action

- 1 Make sure that *aspi2dos.sys* is in the root directory of the boot drive.
- 2 Make sure that your *config.sys* file contains this line:

```
device=aspi2dos.sys /d
```

Additional command line options are required for AHA-1510A host adapter boards. See the *EZ-SCSI User's Manual* for details.

Problem

General difficulties using a SCSI drive as drive *D* with a standard hard disk as drive *C*.

Action

- 1 Make sure that hard disk 1 (*D*) is set to Not Installed or No Drive Installed with your CMOS Setup program.
- 2 Make sure that the SCSI drive you want to use as drive *D* is set to SCSI ID 0:0. Check your drive manual for information on setting the SCSI ID for that device.
- 3 Make sure that SCSI parity is consistently enabled or disabled on all devices on the SCSI bus.
- 4 Make sure that SCSI termination is set correctly on the host adapter and the peripherals.
- 5 If your system is running under DOS, make sure that the disk has a DOS partition and a DOS format.

Problem

General problems using a SCSI drive as drive *D* with another SCSI drive as drive *C*.

Action

- 1 Make sure that both standard hard disks are set to Not Installed or No Drive Installed with your CMOS Setup program.
- 2 Make sure that the SCSI drive that you want to use as drive *D* is set to SCSI ID 1:0. Check your drive manual for information on setting the SCSI ID for that device.
- 3 Make sure that SCSI parity is consistently enabled or disabled on all devices on the SCSI bus.
- 4 Make sure that SCSI termination is set correctly on the host adapter and the peripherals.
- 5 If your system is running under DOS, make sure that the disk has a DOS partition and a DOS format.

Problem

The system works erratically. It hangs, or the host adapter sometimes cannot find the drives.

Action

- 1 Make sure that SCSI parity is consistently enabled or disabled on all devices on the SCSI bus.
- 2 Make sure that SCSI termination is set correctly on the host adapter and the peripherals.
- 3 Check cable length and integrity. The cable should be no longer than six meters total for the entire SCSI bus.
- 4 If the host adapter and drive LEDs remain on during a hang condition, make sure that the SCSI drive conforms to SCSI-1, the SCSI CCS (Common Command Set) revision or SCSI-2 specifications.

Other Error Messages

Host adapter at port address xxx failed diagnostics.

xxx = the port address. This message indicates that there is no host adapter at that port address, that there is an address conflict, or that the host adapter is defective. Reinstall the host adapter. Check cables and jumpers. Check for I/O address conflicts. Confirm that the contents of the motherboard CMOS are set correctly with the Setup program.

Failed scanning for SCSI devices.

The driver failed when scanning the SCSI bus for SCSI devices. Be sure that the SCSI drive's jumpers for SCSI ID and LUN are set correctly. Be sure that all SCSI devices are powered up. Check SCSI bus termination, SCSI parity and cabling.

Get Device Type failed

Check with your drive manufacturer to ensure that you have the latest firmware for your SCSI drive.

Get number of heads failed

Read SCSI drive capacity failed

If the driver is unable to determine capacity for drives 0 through 7, contact the drive manufacturer. Low-level formatting may be needed.

Failed to read master boot record

Failed to read boot record

This indicates problems reading records off the disk. Check SCSI cabling.



AHA-1510A/20A Series User's Guide

Stock Number: 510400-00, Rev. C

Page: 5-6

Print Spec Number: 491842-00

Current Date: 11/18/94

ECN Date: 11/29/94

▼▼▼▼ **A** Support for Large Disk Drives

Extended Translation (Using MS-DOS 5.0)

All current versions of DOS are limited to 1024 cylinders per drive. The standard translation scheme for SCSI host adapters, using 64 heads and 32 sectors, provides a maximum accessible capacity of 1 GByte. As disk drives have recently grown beyond 1 GByte in formatted capacity, they have run up against the DOS 1024-cylinder limit. To continue its support for all SCSI disk drive capacities under DOS, Adaptec has included an extended translation scheme for AHA-1520A/1522A host adapters. This feature supports disk drives as large as 8 GBytes under DOS.

When to Enable Extended Translation

Extended translation is disabled by default. Use extended translation for > 1 GByte hard disks under DOS. Use standard translation, not extended translation, on drives formatted with two or more partitions for different operating systems. Partitions for NetWare can be larger than 1 GByte when using standard translation. For instructions on enabling extended translation, see Chapter 2, *Host Adapter Configuration*.

Caution: Be sure to *back up* your disk drive before you change the translation method on a disk drive. All data is erased when you change from one translation scheme to another.

Using Fdisk

To install a new disk, or to repartition an existing disk, use the *fdisk* DOS utility as you normally would. The cylinder size increases to 8 MBytes when you enable extended translation. The size of the partition you request must therefore be a multiple of 8 MBytes. If you request a partition size that is not a multiple of 8 MBytes, *fdisk* rounds up to the nearest whole multiple of 8 MBytes.

Extended Translation Questions and Answers

What happens if I enable extended translation with SCSI drives smaller than 1 GByte?
Drives handled by the AHA-1520A/1522A BIOS use extended translation if their formatted capacity is greater than 1 GByte. Drives smaller than 1 GByte of formatted capacity use standard translation regardless of whether extended translation is enabled.

What if I have more than two hard disk drives connected to the host adapter?
AHA-1520A/1522A BIOS supports up to two hard drives. With additional software, the AHA-1520A/1522A can support up to 24 hard disks. See *Adaptec EZ-SCSI* on page 4-1.





Floppy Device Drive Assignment

Drives *A* and *B* are reserved for floppy drives in the DOS environment and may be assigned to either standard diskette drives or Floptical drives.

When one Floptical drive is installed, it is recognized as the first, second, or third floppy, depending on the number of standard floppy drives installed in the system.

A Floptical drive may be configured as the bootable *A* drive, with a standard (non-SCSI) floppy drive installed as floppy *B*. This is possible only if your system CMOS Setup utility allows you to configure a standard floppy as *B* without setting a standard *A*.

When two Floptical drives are installed, they are recognized by the operating system as the first and second, second and third, or third and fourth floppy drives, depending on the number of standard floppy drives installed.

Note that when a Floptical drive is added to the system as the third or fourth floppy device, the DOS logical drive designator (*A*, *B*, *C*, etc.) assigned to the Floptical is dependent on the DOS version. In general, versions of DOS prior to 5.0 map third and fourth floppy drives *before* hard disk drives. DOS versions 5.0 and later map third and fourth floppy drives after the hard disk drives.

For example, in a system with two standard floppies, one hard disk, and one Floptical drive, drive letters are assigned as follows:

Drive	DOS 3.x and 4.x	Drive	DOS 5.0, 5.1, and above
A	First Floppy	A	First Floppy
B	Second Floppy	B	Second Floppy
C	Floptical	C	Hard Disk
D	Hard Disk	D	Floptical

Giving drive-letter assignment some thought before installation can make computer operation easier. Some application programs as well as statements in your *config.sys* and *autoexec.bat* files designate source file locations with drive-letter and directory pathnames.

VHD Format

Adaptec EZ-SCSI includes the DOS *vhdfmt* utility for formatting Floptical VHD diskettes. The *vhdfmt* program is provided because DOS 5.0 and earlier versions of DOS do not recognize VHD disk media.

Use your standard DOS Format utility to format 720 KByte and 1.44 MByte diskettes. *Vhdfmt* is *not* intended to be used with standard non-VHD diskettes.

See the *EZ-SCSI User's Guide* for more information about *vhdfmt*.



AHA-1510A/20A Series User's Guide

Stock Number: 510400-00, Rev. C

Page: B-4

Print Spec Number: 491842-00

Current Date: 11/18/94

ECN Date: 11/29/94