



This manual covers installation and operating instructions for the following 3Com[®] U.S. Robotics[®] modems:

Sportster[®] Voice 33.6 kbps internal modems

3Com, the 3Com logo, U.S. Robotics, the USRobotics logo, and Sportster are registered trademarks; Connections, Total Control, Courier, RapidComm, x2, and the x2 logo are trademarks and Towne Square 2000 is a service mark of 3Com Corporation or its subsidiaries. Windows and Internet Explorer are registered trademarks of Microsoft Corp. CompuServe is a registered trademark of CompuServe Inc. America Online is a registered trademark of America Online Inc. Netscape Navigator is a trademark of Netscape Communications Corp. Any other trademarks, trade names, or service marks used in this manual are the property of their respective owners.

Copyright © 1997 3Com Corporation or its subsidiaries
7770 North Frontage Road
Skokie, IL 60077-2690
All Rights Reserved

TABLE OF CONTENTS

Before You Begin (Windows 95 Users)	1
Determining Available Resources	1
Determining Your Version of Windows 95	2
Upgrading to x2 Technology	2
Modem Installation with Windows 3.x	3
A Word About COM Ports and IRQs	3
How to Use ComTest to Determine Your Modem's Settings	5
Testing an Installed Modem	7
What to Do with ComTest's Recommendation	8
How to Change the Modem's Settings	10
How to Insert the Modem into the Computer	12
Modem Installation with Windows 95	19
How to Prepare for Plug and Play Installation	19
How to Insert the Modem into the Computer	21
Installing the Modem Drivers	25
Software Installation and Testing	33
Software Installation and Registration Using the Setup Wizard	33
Sending Your First Fax	48

TABLE OF CONTENTS

Installing Other Fax/Data Software	52
Type of Modem	52
Initialization String	52
Flow Control	52
U.S. Robotics Modem Update Wizard	53
Installation	53
Operation	58
Using Modem Station	65
Troubleshooting and Online Help Resources	89
When Plug and Play Fails	95
Online Help Resources	96
Are You Still Having Problems?	100
If You Need to Return the Modem to Us	101
RapidComm Voice Troubleshooting Tips	102
A Note to Users with Older Versions of RapidComm Voice on Their Systems	102
Glossary	103
Technical Quick Reference	113
AT Command Summary	114
S Registers	128
Regulatory Information	138
Manufacturer's Declaration of Conformity	138

TABLE OF CONTENTS

Caution to the User	139
IC (Canada)	139
UL Listing/CUL Listing	139
Connecting to the Telephone Company	140
Fax Branding	140
Radio and Television Interference	141
For Canadian Modem Users	142
Limited Warranty	145
Index	148

BEFORE YOU BEGIN (WINDOWS[®] 95 USERS)

Determining Available Resources

Your Sportster[®] Voice modem is a Plug and Play device. Windows[™] 95 can automatically identify a Plug and Play device and determine if your system has the resources necessary to support the device. However, Plug and Play will not work if you do not have resources available or if devices on your system are not reporting resource usage correctly. Here's how you can verify that your system has the necessary resources before installing the modem:

1. Click the Windows 95 **Start** button, point to **Settings**, and then click **Control Panel**.
2. Double-click the **System** icon.

3. When the "System Properties" screen appears, click the **Device Manager** tab.
4. Double-click **Computer** and the "Computer Properties" screen appears.
5. Select the option at the top of the screen to show Interrupt Requests (IRQs).

You will see the IRQs your system is currently using. If IRQs 3, 4, 5, and 7 are being used, you need to free an IRQ before you begin installation. This process involves moving a device from the IRQ you want to use to a different (and usually higher) IRQ setting. Please read the documentation for (or contact the manufacturer of) the device that is currently using the IRQ you want to use for your modem to learn more about how to free the IRQ for your modem.

BEFORE YOU BEGIN (WINDOWS 95 USERS)

Determining Your Version of Windows 95

Follow these steps to determine your version of Windows 95. This information will be important during installation.

1. Click the **My Computer** icon on your desktop with the right mouse button.
2. Click **Properties**.
3. In the “System Properties” screen, look at the system information under the **General** tab (circled in the following screen image). The number following the text “Microsoft Windows 95” will end with “950”, “950a”, or “950b”. This indicates your version of Windows 95. Write this number on the blank below for later reference. Then click **OK**.

Windows 95 version

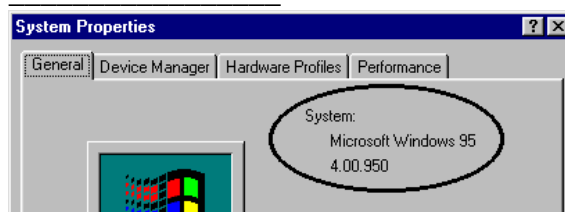

Upgrading to x2™ Technology

Be sure to read the section titled “U.S. Robotics Modem Update Wizard” on page 53 for information on upgrading your 33.6 faxmodem to x2™ technology, allowing downloads of up to 56 kbps*.

- **IMPORTANT!** All x2 products are capable of 56 kbps downloads; however, due to FCC rules which restrict power output of the service providers' modems, current download speeds are limited to 53 kbps. Actual speeds may vary depending on line conditions. Uploads from end users to service providers travel at speeds up to 28.8 kbps. An x2 modem, an analog phone line compatible with x2 technology, and an Internet Service Provider with x2 service are necessary for these high-speed downloads. See <http://www.3com.com/x2> for details.

MODEM INSTALLATION WITH WINDOWS[®] 3.X

You'll need these items from your Sportster[®] modem box:

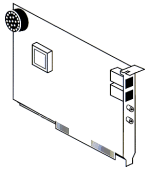

modem



phone cord



Connections[™] CD



microphone

Plus:



a screwdriver (not included)

A Word about COM Ports and IRQs

Most computer accessories — a mouse, sound card, enhanced graphics card, scanner, etc. — require a special connection through which they can communicate with the computer. For some devices, this connection is called a communications (or COM) port. Most computers have 1 or 2 COM ports, but they can have up to 4. Although internal modems do not connect to COM ports directly, they do require a COM port setting, which is determined by the setting on the modem's COM jumper pins.

Each COM port uses an interrupt request (IRQ). An accessory uses an IRQ to get the attention of your computer's central

MODEM INSTALLATION WITH WINDOWS 3.X

processing unit (CPU) so that the accessory can perform a task. The computer stops what it's doing, depending on the priority of the request, to help the accessory perform its task. When two accessories share an IRQ, it's like two people asking different questions in unison to a third person. Just as the person being asked the two questions cannot understand either request, a computer can lock up or otherwise fail to communicate properly with your modem when there is an IRQ conflict.

D KEY POINT: Accessories cannot share COM ports and should not share IRQs. When accessories try to share settings, they will either not work properly or not work at all. This section of the manual will help you understand the COM/IRQ settings on your new Sportster modem.

3Com has set your modem to a default Plug and Play setting geared towards Windows 95 users. In this configuration, the shunts used to set your modem's COM port and IRQ settings are hanging from single jumper pins and will not affect your modem's settings. As a Windows 3.x user, you need to run the ComTest program (on the Connections CD) to determine what settings your modem should use.



NOTE: Some communications software programs require a particular setting for your modem (RapidComm, which shipped with your modem, does not). If you wish to use a program other than RapidComm, now is a good time to read that software's manual to determine what setting is required.

How to Use ComTest to Determine Your Modem's Settings

1. Insert the Connections CD into your CD-ROM drive.
2. In Windows' Program Manager, click **Run** on the **File** menu. Type **d:\comtest.exe** and press **ENTER**. This starts ComTest, the program that determines which COM ports and IRQs are available for use by your modem.
3. The screen in the next column appears when ComTest starts.
 - If there is a modem in your computer which you are replacing with your new Sportster modem, go to "Testing an Installed Modem" on page 7 to

determine which COM and IRQ settings the older modem is using.

- If a modem is not currently installed in your computer, click **Recommend settings for a new modem**.

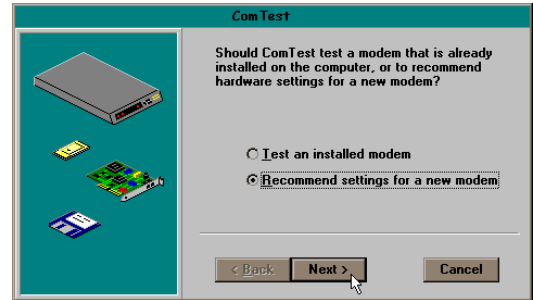

Then click **Next**.

MODEM INSTALLATION WITH WINDOWS 3.X

4. Click **Internal Modem**. Then click **Next**.

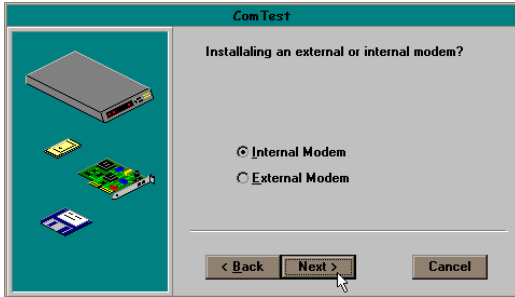

5. If you have a free setting, you will see a screen like this.

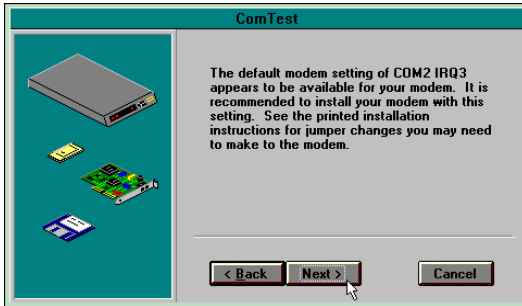

COM2/IRQ3 is free in this example. ComTest might instead recommend COM1/IRQ4, COM3/IRQ4, or COM4/IRQ3 for your modem.

Write down the displayed settings. You'll need to know these settings later. Click **Next**.

If you do not have a free setting, you will see a screen like this.

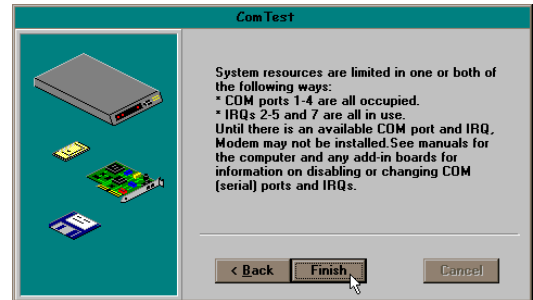

MODEM INSTALLATION WITH WINDOWS 3.X

Click **Finish** to exit ComTest. Go to “What to Do with ComTest’s Recommendation” on page 8.

6. When you see this screen, click **Finish** to exit ComTest.



Go to “What to Do with ComTest’s Recommendation” on page 8.

Testing an Installed Modem

If there is a modem already installed in your computer, you can determine its COM and IRQ settings by selecting the **Test an installed modem** option. Follow the instructions on screen until you see the screen that tells you “Testing is complete.” This screen will also tell you which COM and IRQ settings your present modem is using. These are the settings you want to use for your new Sportster modem. Write the settings down.

Turn off and unplug your computer and remove your present modem. Go to “How to Change the Modem’s Settings” on page 10.

What to Do with ComTest's Recommendation



NOTE: If your communications software requires a modem that ComTest does not recommend, there is a good chance that the setting is being used by another device in your system. To free that setting in your system, consult your computer's manual. Go to "How to Change the Modem's Settings" on page 10.

If ComTest recommended COM1/IRQ4

Write down "COM1" and "IRQ4" somewhere where it will be handy during software installation. Go to "How to Change the Modem's Settings" on page 10.

If ComTest recommended COM2/IRQ3

Write "COM2" and "IRQ3" somewhere where it will be handy during software installation. Go to "How to Change the Modem's Settings" on page 10.

If ComTest recommended COM3/IRQ4 or COM4/IRQ3

Do not use either of these settings. While the COM port part of the setting is acceptable (ComTest only recommends COM ports that are not being used), the IRQ part of the setting is not acceptable. When ComTest recommends either COM3/IRQ4 or COM4/IRQ3, the IRQ in the setting is being used by another accessory. You could use the suggested IRQ for the modem, but you run the risk that the modem and/or the other accessory sharing the IRQ might not work properly.

MODEM INSTALLATION WITH WINDOWS 3.X

If you do not have a sound card, use COM3/IRQ5. Write “COM3” and “IRQ5” somewhere where it will be handy during software installation. You will have to change the settings on your modem. Go to “How to Change the Modem’s Settings” on page 10.

If you do have a sound card, use COM2/IRQ3. To use this setting, you have to first disable your computer’s second serial port (COM2). This is a pronged socket on the back of your computer.

- Go to your computer manufacturer’s manual.
- Find out how to disable the COM port.
- Find out which of the sockets on the back of your computer is the second serial port.
- If you have something plugged into that port, find out if you can plug it in somewhere else. Any accessory plugged

into that port will not work after the port has been disabled.

- Then return to this point in this manual to continue.

After disabling COM2, you can use the COM2/IRQ3 setting.

Write “COM2” and “IRQ3” somewhere where it will be handy during software installation and go to “How to Change the Modem’s Settings” on page 10.

If ComTest reports that “You do not have any available COM ports and/or IRQs”

We recommend you disable COM1 or COM2. When you disable one of these COM ports, you can use it and its default IRQ for your modem. Go to your computer manufacturer’s manual.

MODEM INSTALLATION WITH WINDOWS 3.X

- Find out which socket is COM1 and which is COM2.
- If nothing is plugged into either port, you may choose either of the ports to disable. Your computer manufacturer's manual will tell you how to disable the COM port.
- If one port does not have anything plugged into it, note if the port is COM1 or COM2. This is the port you'll want to disable for your modem.
- If both ports are being used, you may be able to attach one of the plugged-in accessories elsewhere so that you can disable its COM port. The accessory will not work once its port is disabled.

If you've disabled COM1, you can now use the COM1/IRQ4 setting. Write it down somewhere where it will be handy during

software installation. Go to "How to Change the Modem's Settings" (on this page).

If you've disabled COM2, you can now use the COM2/IRQ3 setting. Write the setting down somewhere where it will be handy during software installation.

How to Change the Modem's Settings

1. Always touch an unpainted metal part of your computer (the back is usually unpainted) to discharge static electricity before handling the modem. Static can damage your modem. Then take the modem out of its plastic bag.
2. Find the COM and IRQ jumper shunts (small black plastic pieces) on your

MODEM INSTALLATION WITH WINDOWS 3.X

modem's jumper pins (see the following diagram).

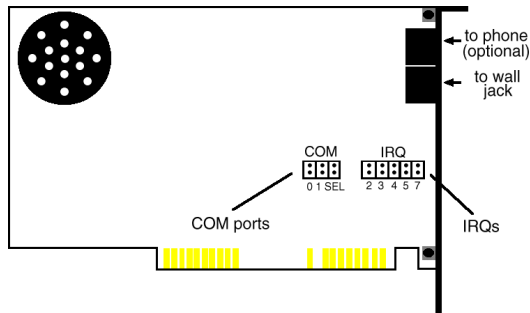

3. To change the COM port and IRQ settings, you need to reposition the jumper shunts on the COM port and IRQ pins. To do this, lift the jumper shunts off the pins.



TIP: Grasp the jumper shunts with a tweezers or needle-nosed pliers. **DO NOT** grasp too firmly, as you may crush the jumper shunts. If a jumper shunt seems stuck, gently rock it back and forth as you lift. Do not touch any other part of the modem or your computer with the tweezers/pliers. A jumper shunt needs to be sitting on both jumper pins in order to effectively set the modem to the desired setting.

MODEM INSTALLATION WITH WINDOWS 3.X

4. Move the jumper shunt to the new setting.
- The COM port setting can involve one to three shunts. The four possible COM port settings are as follows:

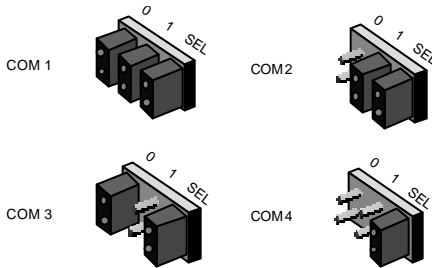

- Unlike most COM port settings, the IRQ setting involves only one jumper shunt. Simply move the jumper shunt to the pins labeled with the IRQ you need.

How to Insert the Modem into the Computer



NOTE: Before installing your modem, write its serial number somewhere where it will be handy during software installation. (You'll find the serial number underneath the bar code on the white sticker on the modem and on the outside of the box the modem came in.) If you ever need to call our customer support department, a customer support representative will ask you for the serial number. This will help him or her identify your modem.

MODEM INSTALLATION WITH WINDOWS 3.X

1. Turn off your computer and unplug it from the electrical outlet.
2. Unplug any peripheral devices (printer, monitor, keyboard, mouse, etc.) from the computer.
3. Remove the screws from your computer's cover and then remove the cover, as shown in the following diagrams. Your computer may differ in appearance from these diagrams, but the basic principle for removing the cover should be the same. Contact your computer manufacturer or review their manual if you need further instructions.



TIP: Before you unplug anything, label the cords or make a sketch of how things are connected. This can be helpful when you plug things back in later.



CAUTION: To avoid the risk of electric shock, make sure your computer and all peripheral devices are turned off and unplugged.

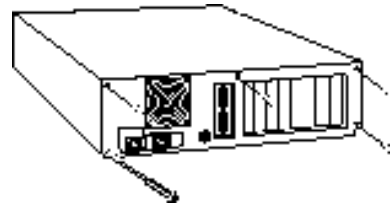

MODEM INSTALLATION WITH WINDOWS 3.X



4. Find an empty ISA expansion slot at least as long as the gold edge of your modem. (ISA slots have black plastic grooves lined with silver.) Unscrew and remove the expansion slot cover (the long narrow piece of metal that keeps dust from entering through the opening perpendicular to the slot). Be careful not to drop the screw into the computer. You will need it later to screw the modem into place.

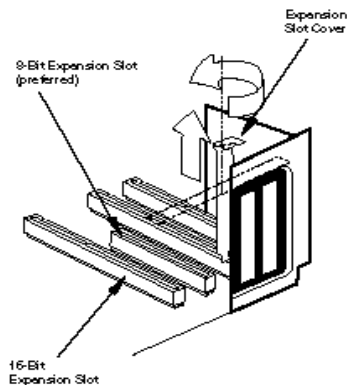

5. Holding the modem at each corner, with the gold edge facing the slot, push the modem down as gently as possible until it snaps into the expansion slot. (NOTE: The drawings show horizontally aligned expansion slots. Some computers have vertically aligned slots. The instructions apply to both styles.) You need to apply a little pressure to seat the modem properly. Sometimes a gentle back-and-forth motion helps to fit the

MODEM INSTALLATION WITH WINDOWS 3.X

modem all the way into the slot. If you feel resistance, the modem may not be properly lined up with the slot. Do not force it into the slot. Remove the modem and try again.

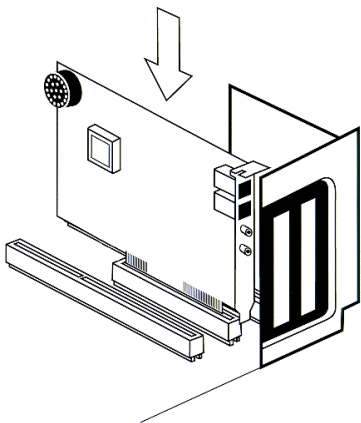

6. Once the modem is in place, fasten it firmly using the screw that you removed in step 4.
7. Replace the computer's cover and fasten it with the screws you removed in step 3.

8. If you currently have a phone plugged into the wall jack you plan to use for the modem, disconnect the phone's cord from the jack.



WARNING : The phone jack you use must be for an **ANALOG** phone line (the type found in most homes). Many office buildings have digital phone lines. Be sure you know which type of line you have. The modem will be damaged if you use a digital phone line.

9. Plug one end of the phone cord that came with the modem into the TELCO jack at the rear of the modem. Plug the other end of the cord into the wall jack.
10. If you wish to use a phone through the line the modem uses (when the modem is not in use), plug your phone's cord into the modem's PHONE jack.

MODEM INSTALLATION WITH WINDOWS 3.X

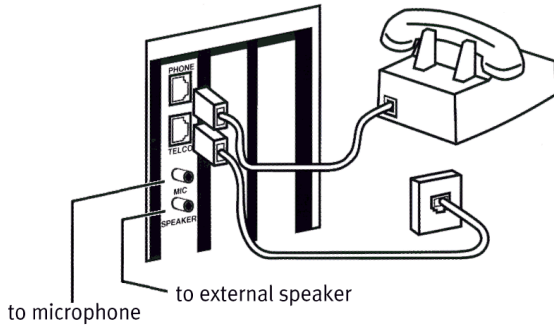

13. If you have your modem set to COM1/IRQ4 or COM2/IRQ3, go to “Software Installation and Testing” on page 33. If you have your modem configured to any other setting, open Program Manager and double-click the **Main** icon.



 **NOTE: You cannot use the modem and a phone at the same time if they share the same telephone line.**

11. Plug the microphone included with your modem into the MIC jack on the modem.
12. To enhance the modem’s full-duplex speakerphone capabilities, plug a set of powered external speakers (not included) into the SPEAKER jack on the modem.

MODEM INSTALLATION WITH WINDOWS 3.X

14. Double-click the **Control Panel** icon.

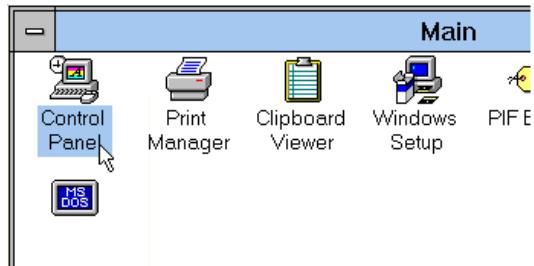

15. Double-click the **Ports** icon.

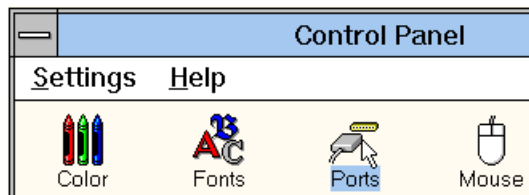

16. If it's not already selected, click the COM port for your modem. Then click **Settings**.

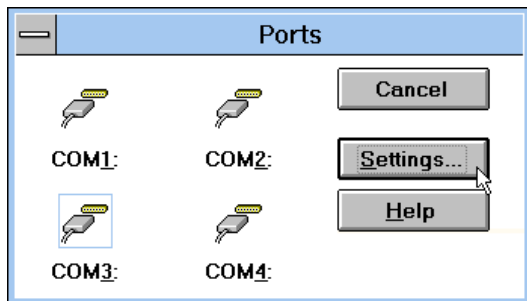

17. Click **Advanced**.

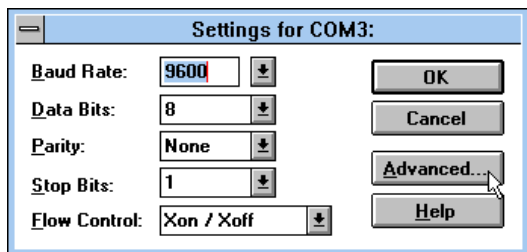

MODEM INSTALLATION WITH WINDOWS 3.X

18. In the **Interrupt Request Line (IRQ)** box, select the IRQ that ComTest recommended.

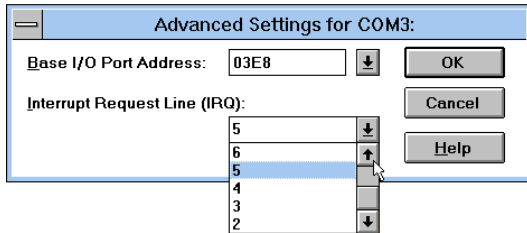

19. Click **OK**.

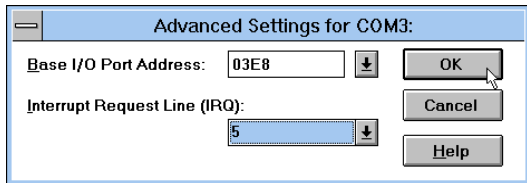

You will see a brief series of screens after the preceding screen. Click **OK** on each screen until you see a screen with a **Close** button. Click **Close** to exit Program Manager.

You are now ready to install the software on the Connections CD-ROM (included with your Sportster modem). Turn to “Software Installation and Testing” (page 33) for detailed information about installing the software, registering the modem, and trying out your modem by faxing U.S. Robotics.

MODEM INSTALLATION WITH WINDOWS[®] 95

You will need these items from your Sportster™ modem box:

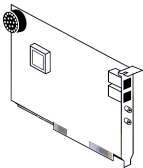

modem

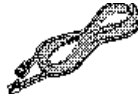

phone cord



Connections™ CD



microphone

Plus:



a screwdriver (not included)

Since your new Sportster is a “Plug and Play” device, Windows 95 may be able to detect your modem automatically after you plug it into your computer. The operating system should do all the work of recognizing the modem for you.

How to Prepare for Plug and Play Installation

1. Touch an unpainted metal part of your computer (the back is usually unpainted) to discharge static electricity. Static can damage your modem.
2. Take the modem out of its plastic bag.

MODEM INSTALLATION WITH WINDOWS 95

- Find the jumper shunts (small black plastic pieces) on the COM port and IRQ jumper pins on your modem. They should be in roughly the area indicated in the following illustration.

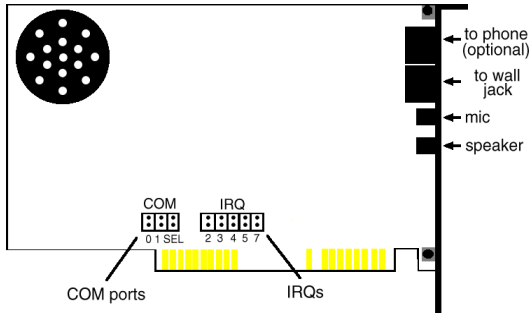

When doing a "Plug and Play" installation, the jumper shunts should be placed so that they are hanging from single jumper pins rather than on pairs of pins. Move your

jumper shunts so they are hanging as in the following diagram.

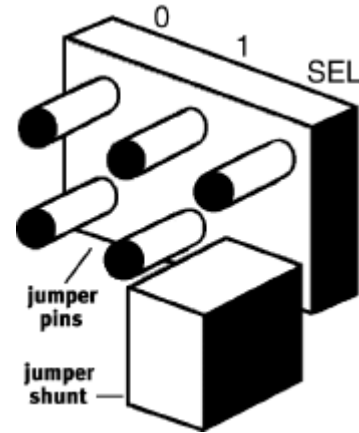

NOTE: If you need to move the jumper shunts, grasp them with a tweezers or a needle-nosed pliers. DO NOT grasp too firmly, however, or you may crush the jumper shunts. If a jumper shunt seems stuck, try gently rocking it back and forth as you lift.

How to Insert the Modem into the Computer



NOTE: Before installing your modem, write down its serial number. (You'll find the serial number underneath the bar code on the white sticker on the modem and on the outside of the box the modem came in.) If you ever need to call our customer support department, a customer support representative will ask you for the serial number. This will help him or her identify your Sportster modem.

1. Turn off your computer and unplug it from the electrical outlet.
2. Unplug any peripheral devices (printer, monitor, keyboard, mouse, etc.) from the computer.



TIP: Before you unplug any cords, label them or make a sketch of how they are connected. This can be helpful when you plug them back in later.



CAUTION : To avoid risk of electric shock, make sure your computer and all peripheral devices are turned off and unplugged from electrical outlets.

3. Remove the screws from your computer's cover and then remove the cover, as shown

MODEM INSTALLATION WITH WINDOWS 95

in the following diagrams. Your computer may differ in appearance from these diagrams, but the basic principle for removing the cover should be the same. Refer to your computer manufacturer's manual if you need further instructions.

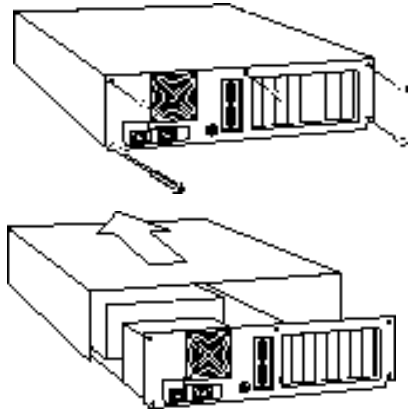

4. Find an empty ISA expansion slot that's at least as long as the gold edge of your modem. (ISA slots are black plastic grooves lined with metal.) Unscrew and remove the expansion slot cover (the long narrow piece of metal that keeps dust from entering through the opening perpendicular to the slot).

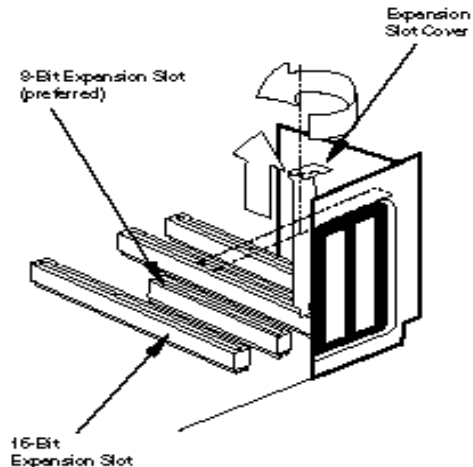

MODEM INSTALLATION WITH WINDOWS 95

5. Holding the modem at each corner, with the gold edge facing the slot, push the modem down as gently as possible until it snaps into the expansion slot. (NOTE: The following diagram shows horizontally aligned expansion slots. Some computers have vertically aligned slots. The instructions apply to both styles.)

You need to apply a little pressure to seat the modem properly. Sometimes a gentle back-and-forth motion helps fit the modem all the way into the slot. If you feel resistance, the modem may not be properly lined up with the slot. Do not force it into the slot. Remove the modem and try again.

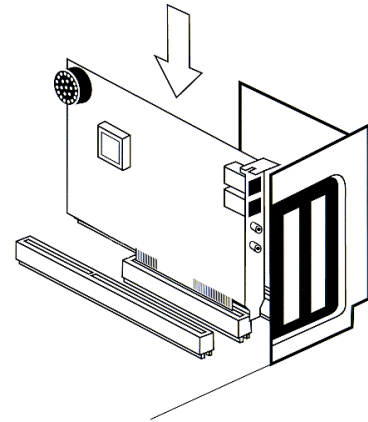

6. Once the modem is in the slot, fasten the modem firmly into place using the screw that you removed in step 4.
7. Replace the computer's cover and fasten it with the screws you removed in step 3.
8. Locate the wall jack you plan to use for the modem. If you have a phone plugged into

MODEM INSTALLATION WITH WINDOWS 95

this jack, disconnect the telephone cord from the jack.



WARNING : The phone jack you use must be for an **ANALOG** phone line (the type found in most homes). Many office buildings have digital phone lines. Be sure you know which type of line you have. The modem will be damaged if you use a digital phone line.

9. Plug one end of the phone cord included with the modem into the TELCO jack at the rear of the modem. Plug the other end of the cable into the wall jack.
10. If you wish to use a phone through the line the modem uses (when the modem is not in use), plug your phone's cord into the modem's PHONE jack.



NOTE: You cannot use the modem and a phone at the same time if they share the same telephone line.

11. Plug the microphone included with your modem into the MIC jack on the modem.
12. To enhance the modem's full-duplex speakerphone capabilities, plug a set of powered external speakers (not included) into the SPEAKER jack on the modem.

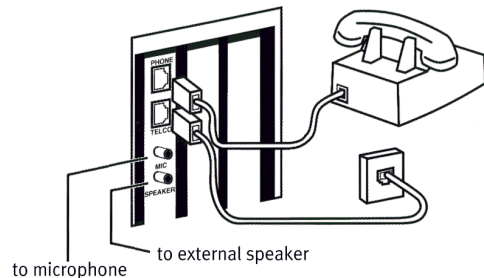

MODEM INSTALLATION WITH WINDOWS 95

13. Plug the power cords, cables, and peripherals back into the computer and turn on the computer.

Installing the Modem Drivers



NOTE: If you wrote “950b” on page 2 of this User’s Guide, go to “Installing Modem Drivers with Windows 95 Version 950b” on page 29. Otherwise, follow these instructions.

Installing Modem Drivers with Windows 95 Versions 950 and 950a

1. When Windows 95 restarts, it should detect the modem. If it does, you will see the following screen.

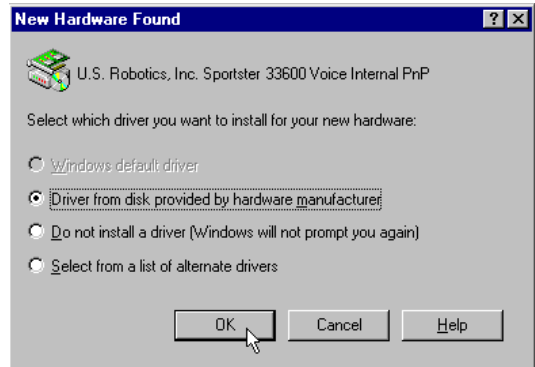

Click **Driver from disk provided by hardware manufacturer**. Then click **OK**.



NOTE: If this screen does not appear, go to the section titled “When Plug and Play Fails” on page 95.

MODEM INSTALLATION WITH WINDOWS 95

- When you see this screen, insert the Connections CD into your CD-ROM drive and type **D:** to replace the **A:**. (NOTE: If your CD-ROM drive has a different letter name, type that letter instead of **D**.)

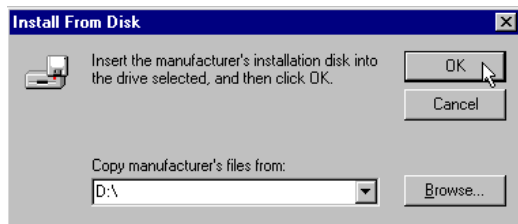

Click **OK**. Windows will load the modem's drivers.

- Once Windows finishes loading the information from the CD-ROM, you should verify that the modem installation was a success. When your desktop returns, click the Windows **Start** button and point to **Settings**. Then click **Control Panel**.

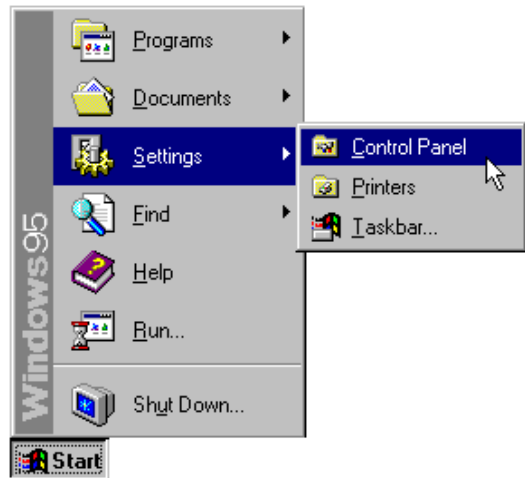

MODEM INSTALLATION WITH WINDOWS 95

4. Double-click the **Modems** icon (circled in the screen image below).

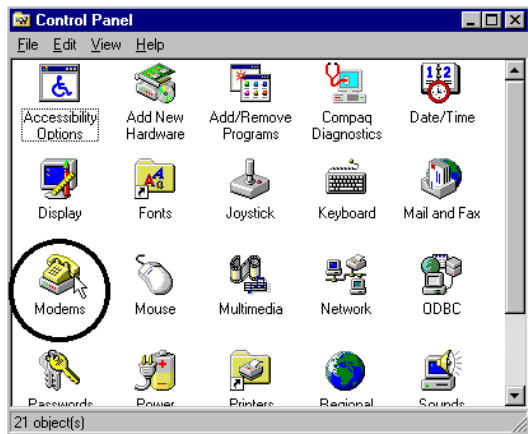

5. In the “Modems Properties” screen, you should see “Sportster 33600 Voice Internal PnP” listed.



MODEM INSTALLATION WITH WINDOWS 95

This means the installation was a success.
Click **OK**.

 **NOTE:** If you do not see your modem listed in the preceding screen, the Plug and Play installation was unsuccessful. Please refer to “When Plug and Play Fails” on page 95.

- Next, click the **Diagnostics** tab at the top of the “Modems Properties” screen. Write down the COM setting for your modem. (NOTE: Your screen may show a different setting than that shown in the following screen.) You will need to know this setting when you install RapidComm Voice.

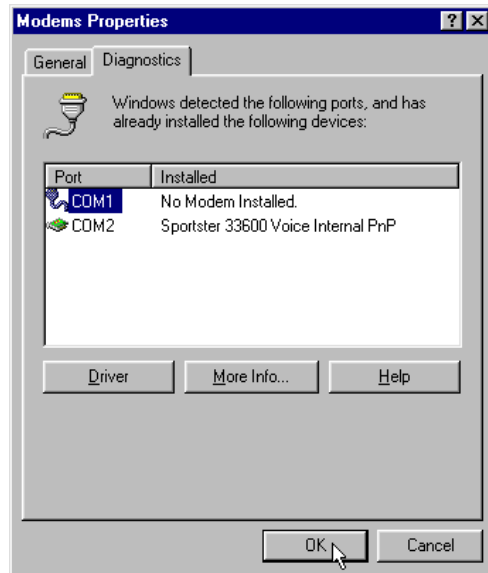

Turn to “Software Installation and Testing” (page 33) for detailed information about installing RapidComm Voice, registering the modem, and trying out your modem by faxing U.S. Robotics.

MODEM INSTALLATION WITH WINDOWS 95

Installing Modem Drivers with Windows 95 Version 950b

1. When Windows restarts, it should detect the modem (see following screen image). Insert the Connections CD and click **Next**.

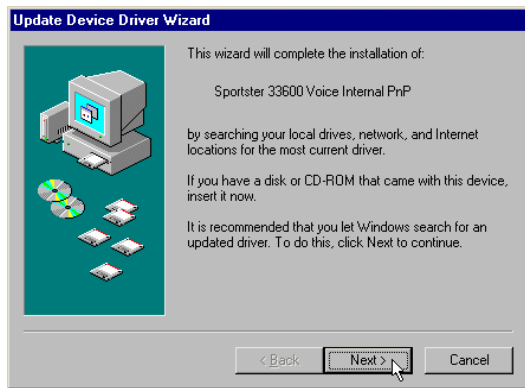

2. When you see the following screen, click **Finish**.



NOTE: If this screen does not appear, go to the section titled "When Plug and Play Fails" on page 95.

MODEM INSTALLATION WITH WINDOWS 95

- Once Windows 95 has installed the modem's drivers, you will see the following screen. This screen tells you which communications port your modem is installed to. (NOTE: Your screen may show a different COM port.) Make a note of the COM port setting. You will need this information later when you installing the software on the CD-ROM. Remove the CD from your CD-ROM drive and click **OK**. Windows will restart.



- Once Windows restarts, you should verify that the modem installation was a success. When your desktop returns, click the Windows **Start** button and point to **Settings**. Then click **Control Panel**.

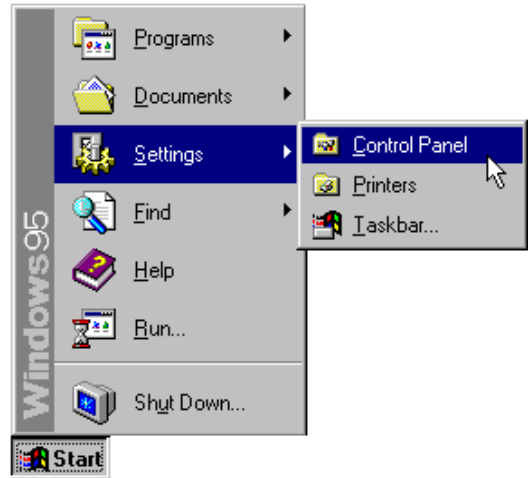

MODEM INSTALLATION WITH WINDOWS 95

5. Double-click the **Modems** icon (circled in the screen image below).

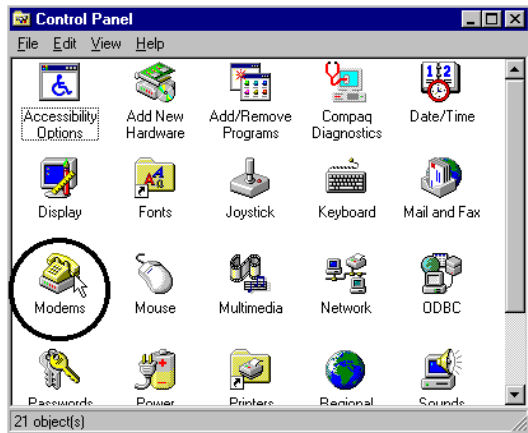

6. In the “Modems Properties” screen, you should see “Sportster 33600 Voice Internal PnP” listed.



MODEM INSTALLATION WITH WINDOWS 95

This means the installation was a success.
Click **OK**.

 **NOTE:** If you do not see your modem listed in the preceding screen, the Plug and Play installation was unsuccessful. Please refer to “When Plug and Play Fails” on page 95.

7. Next, click the **Diagnostics** tab at the top of the “Modems Properties” screen. Write down the COM setting for your modem. (NOTE: Your screen may show a different setting than that shown in the following screen.) You will need to know this setting when you install RapidComm Voice.

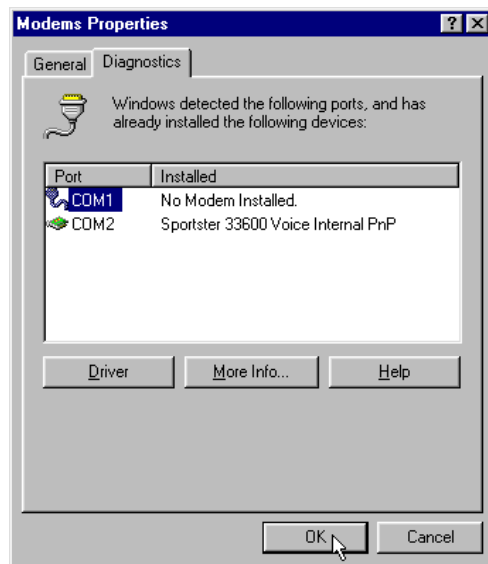

Turn to “Software Installation and Testing” (page 33) for detailed information about installing RapidComm Voice, registering the modem, and trying out your modem by faxing U.S. Robotics.

SOFTWARE INSTALLATION AND TESTING

Software Installation and Registration Using the Setup Wizard

This section guides you through the U.S. Robotics Setup Wizard, the Connections™ CD-ROM interface, and the installation of RapidComm™ Voice fax/data/voice software. It also shows you how to register and test your new Sportster modem.

RapidComm Voice fax/data/voice software simplifies sending and receiving faxes directly from your computer desktop. You can build your own fax directory, send faxes to specified groups of phone numbers, request individual cover pages when necessary, and send individual faxes without exiting your word processing program.

Additionally, RapidComm Voice software lets you connect to BBSs and other online data providers. Take advantage of this access to enter a new world of information and entertainment.



NOTE: The following instructions apply to Windows 3.x and Windows 95 users. However, only Windows 95 screens are shown.



NOTE: If you have an older version of RapidComm Voice software installed on your system, uninstall it before continuing.

SOFTWARE INSTALLATION AND TESTING

1. From the Windows 95 desktop, click the **Start** button and then click **Run**.



2. In the text box, type **D:\setup.exe**. (If your CD-ROM drive has a letter name other than **D**, type that letter in place of **D**.)

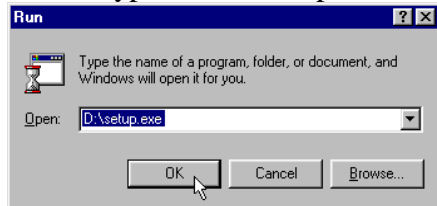

3. You will briefly see a screen that looks like this.

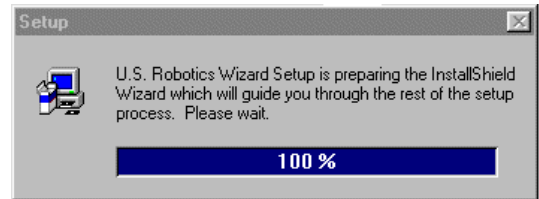

4. When you are asked if you wish to run the Setup Wizard, click **Yes**.

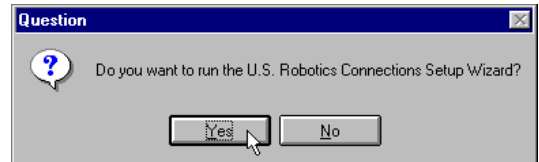

SOFTWARE INSTALLATION AND TESTING

5. This is the Setup Wizard's "Welcome" screen. After reading the screen, click **Next**.



6. When you see the following screen, select your modem from the list and select the correct COM port setting in the **Port** box. Then click **Next**.

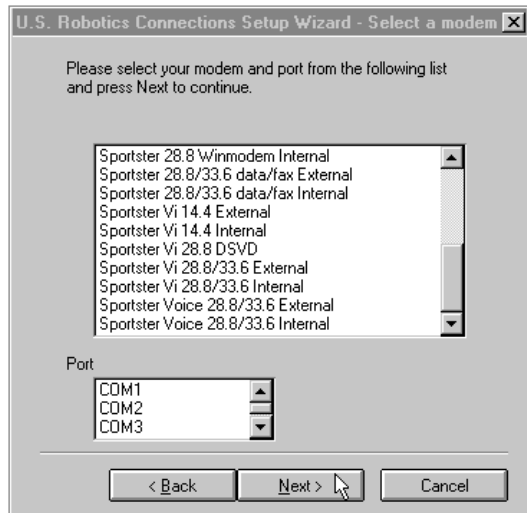
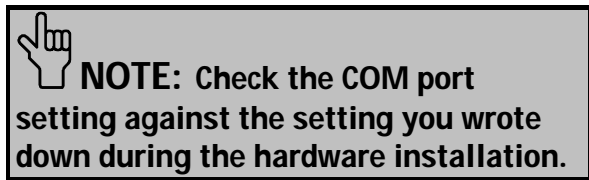

SOFTWARE INSTALLATION AND TESTING

7. When you see the next two screens, fill in the blank boxes with the appropriate information, using the **TAB** key to move between fields. Click **Next** on each screen when you have filled in all of the necessary information.

U.S. Robotics Connections Setup Wizard - Local Demographics

Please enter the following information:

First Name: John Middle Initial: J

Last Name: Public

Organization: ACME Products

Department: Advertising or marketing

Street Address: 1234 Pleasant Drive

City: Springfield State: IL

Zip: 60123 Country: United States

Phone Number: 123-456-7890 Extension: 123

Fax Number: 123-987-6543

Email address: public@acme.com

< Back Next > Cancel

U.S. Robotics Connections Setup Wizard

Please enter your address and phone number.

What kind of modem did you buy?

Date of purchase (MM/DD/YY): 01/01/96

Where did you buy your modem? Bob's CompuMart

Product Serial Number: 1234567890123456

You can find your serial number on the white sticker on the modem and on the outside of the box.

< Back Next > Cancel

8. You will see the following screen as the Setup Wizard creates a U.S. Robotics Connections program group.

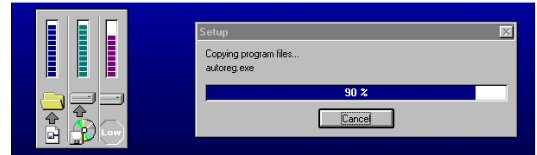

9. Next, the Setup Wizard looks for Netscape Navigator on your system.

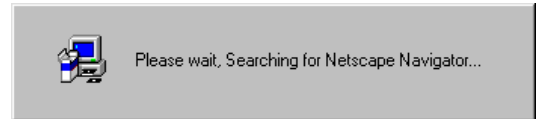

If the Setup Wizard does not find Netscape Navigator, it searches for Microsoft's Internet Explorer. If the Setup Wizard does not find Internet Explorer, it will automatically install the application later in the Setup Wizard process.

SOFTWARE INSTALLATION AND TESTING

10. The next screen introduces the U.S. Robotics Registration Wizard. After you read the screen, click **Next**. Read through each of the next two screens and verify or correct the information you typed earlier. Click **Next** on each screen to move on.

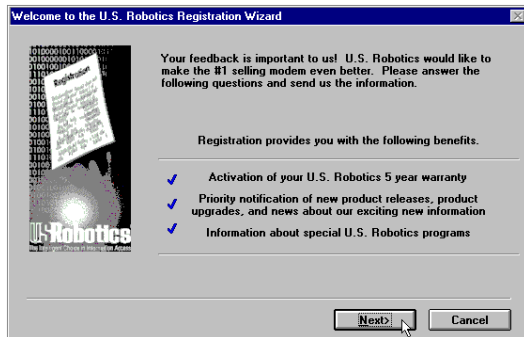

User Information

Please verify the following information.

First Name Middle Initial

Last Name

Organization

Department

Street Address

City State

Zip Country

Phone Number Extension

Fax Number

Email address

Product Information

Please fill out the following information about your product.

What kind of modem did you buy?

Date of Purchase

Where did you buy your modem?

Product Serial Number

You can find the serial number on the white sticker on the modem and on the outside of the box.

Check here if you would like information on product upgrades from time to time to be sent to you.

SOFTWARE INSTALLATION AND TESTING

11. When you see this screen, you are ready to register your new modem. Click **By Modem**. We recommend you choose the **By Modem** option because it's a great way to verify that your Sportster modem is correctly installed.

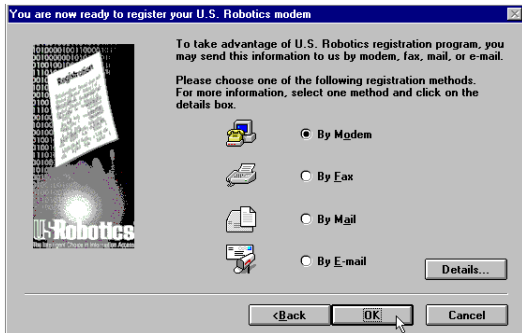

12. When you see this screen...



- If you need to dial a prefix (such as 9) to make a call outside your building, type the prefix before the 1 in the **Prefix** box and then click **Dial**. If the modem still does not dial the number properly, you may need to insert a comma between the prefix and the 1 to force the modem to pause.

SOFTWARE INSTALLATION AND TESTING

- If you do not need to dial a prefix, simply click **Dial**.

13. You will see a screen indicating that the registration information has been sent (see circled text in the screen below).

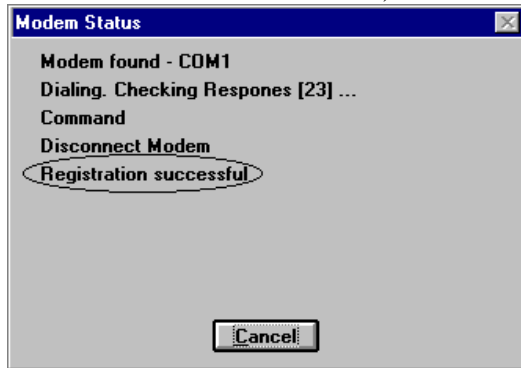

14. The next screen indicates that the Setup Wizard is finished. Click **OK** to launch the Connections CD-ROM.



NOTE: If the Setup Wizard detected Internet Explorer on your system during the setup process, your computer will launch the Connections CD-ROM when you click **OK**. Continue at step 15.

If the Setup Wizard DID NOT detect Internet Explorer on your system earlier in the setup process, it will launch the Internet Explorer installation utility after you click **OK**. When you see the following screen, click **Install Internet Explorer** and follow the on-screen instructions to complete the installation of the software.

SOFTWARE INSTALLATION AND TESTING



At the end of the installation process, you will see the following screen. Click **Yes**.

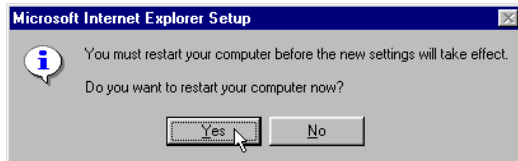

Windows 95 users: Windows will restart and the Connections CD will launch automatically upon restart.

Windows 3.x users: Windows will restart. When your desktop reappears, you will see a **Connections** icon (shown below) in the **Connections** program group. Double-click the icon to launch the CD.

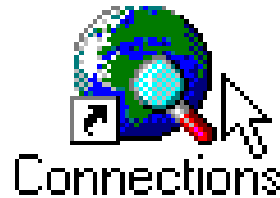

SOFTWARE INSTALLATION AND TESTING

15. When the main Connections menu appears, click **Business & Productivity** on the menu on the left hand side of the screen (circled below).

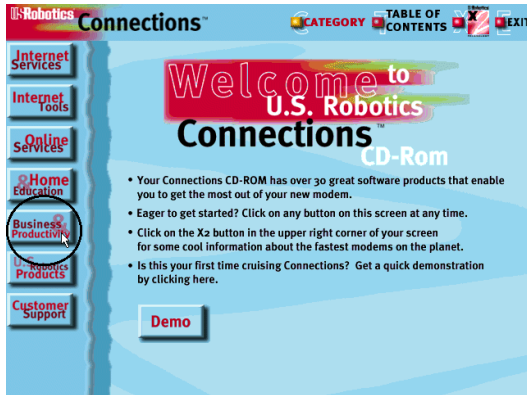

16. On the **Business & Productivity** menu is a **RapidComm Voice** button (circled in the following screen shot). RapidComm Voice is the fax/data/voice software you can use to send faxes directly from your desktop, transfer files electronically, set up multiple voice mail boxes, or dial into a BBS. Click **RapidComm Voice**.



SOFTWARE INSTALLATION AND TESTING

17. The next screen contains another menu on the right hand side of the screen. Included on the menu is a **Learn More & Get Software** button (circled in the screen image below). Click this button.



18. The next screen displays information about the RapidComm Voice software. When you are ready to install the RapidComm Voice software, click **Install** (circled in the lower left hand corner of the following screen image).

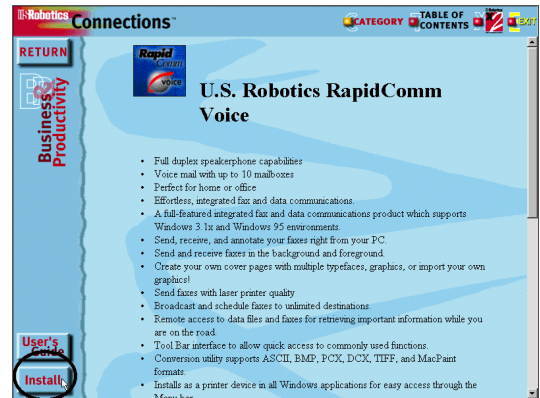

SOFTWARE INSTALLATION AND TESTING



NOTE: If you are using Netscape Navigator to view your Connections CD-ROM, you may be asked to save the application's installer to your computer when you click the **Install** button. Note the installer's file name and its location on your computer. To run the installer or demo, find the file on your computer and double-click it. The installer will start.

19. The next screen is the first of the "RapidComm Voice Setup" screens. When this screen appears, make sure the location shown in the text box is where you would like the files copied to and then click **Install**. If you wish to copy the RapidComm Voice files to a different

directory, type that location in the text box before clicking **Install**.



20. You will see this screen as files are copied.

SOFTWARE INSTALLATION AND TESTING

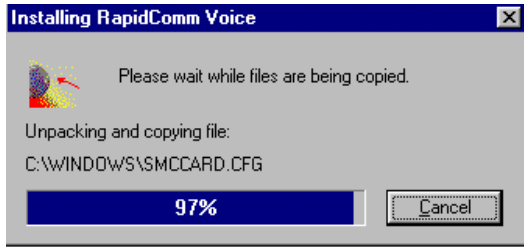

21. When you see this screen, click either **Yes** or **No**.

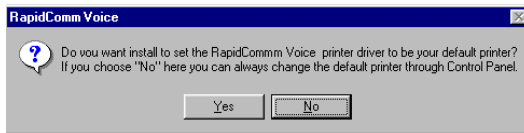

- If you click **Yes**, every document you print will be treated as a fax unless you change the printer selection in the program from which you are printing.
- If you click **No**, RapidComm Voice will not be selected as the default printer. When you want to send a fax, you must select RapidComm Voice as the printer in the program from which you are printing.

This screen marks the end of the RapidComm Voice installation. Click **OK** to return to the Connections.

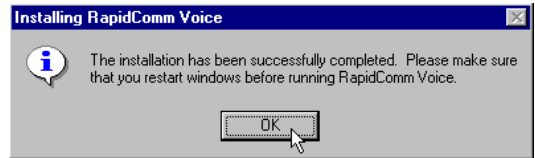

23. Click **Exit** (circled in the following screen image).

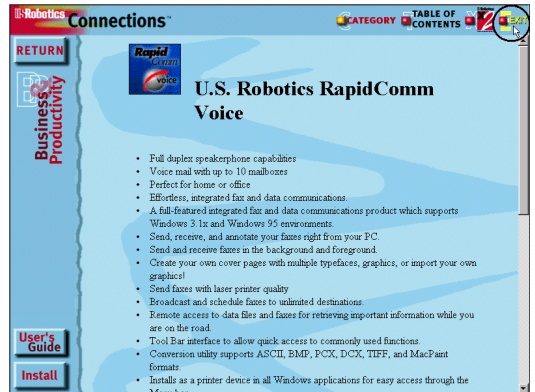

SOFTWARE INSTALLATION AND TESTING

24. Restart Windows by clicking the Windows **Start** button and pointing to **Shut Down**. Click **Restart the Computer?** on the “Shut Down Windows” screen. Then click **Yes**.

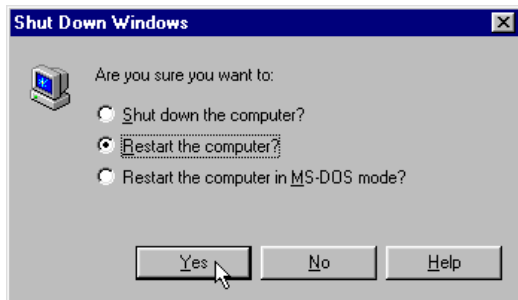

25. When your desktop appears, click Windows **Start**. Point to **Programs**. Then point to **RapidComm Voice**.

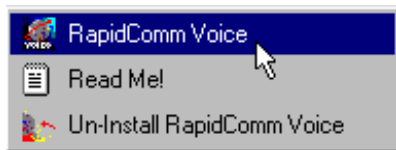

26. The following is the first “RapidComm Voice Setup Wizard” screen. After you read the screen, click **Next**.



SOFTWARE INSTALLATION AND TESTING

27. When you see this screen, verify the information shown and then fill in the **Data** box (if you have a third phone number just for your modem) and the **Local Area Code** box. Then click **Next**.

RapidComm Voice Setup Wizard

Who are you?

Name:

Company:

What is your phone number?

Voice:

Fax:

Data:

Local Area Code:

< Back Next > Cancel Help

28. After you verify the information on this screen, click **Next**.

RapidComm Voice Setup Wizard

The following information is needed for sending faxes, creating cover pages, and placing calls...

Address 1:

Address 2:

City:

State:

Country:

Zip/Post Code:

E-Mail Address:

< Back Next > Cancel Help

SOFTWARE INSTALLATION AND TESTING

29. Select the correct modem in the text box on the following screen. Then click **Next**.



30. The next screen allows you to select single or multiple mailboxes for your personal voice mail system. Click **Single** or **Multiple** and then click **Next**.

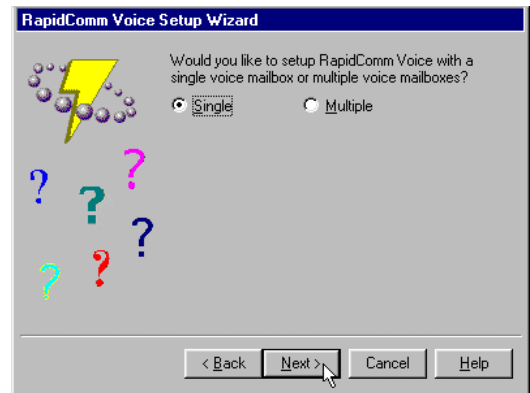

SOFTWARE INSTALLATION AND TESTING

31. When you see this screen...

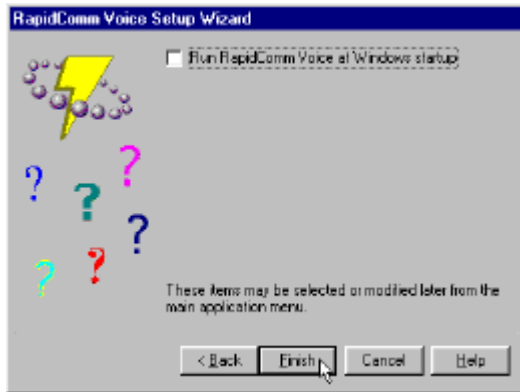

- If you want the RapidComm Voice program to launch at Windows startup, select the box to the left of **Run RapidComm Voice at Windows startup**. A check will appear in the box. Then click **Finish**.

- If you do not want RapidComm Voice to start every time you start Windows, simply click **Finish**.

32. You will see this screen.

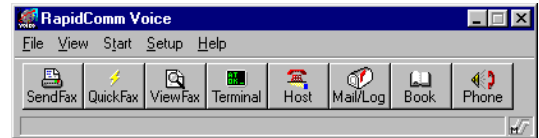

This is the main RapidComm Voice screen. To send your first fax, keep this screen open. (After this initial run, RapidComm Voice will not need to be running in order to send a fax.)

Sending Your First Fax

Using RapidComm Voice software, you can send and receive faxes directly from your computer and eliminate the need for a fax machine. Once you learn the basics of sending faxes, you can learn more involved fax

SOFTWARE INSTALLATION AND TESTING

functions, such as sending documents to groups of numbers at assigned times and how to transfer data files. These more advanced functions are explained in the electronic RapidComm Voice manual on your Connections CD. This chapter will walk you through sending your first fax.

1. Open an application in which you can create documents that you might want to fax (e.g., a word processing application). Create a document containing only a sentence or two. Name the document **tester**. Keep the document open.

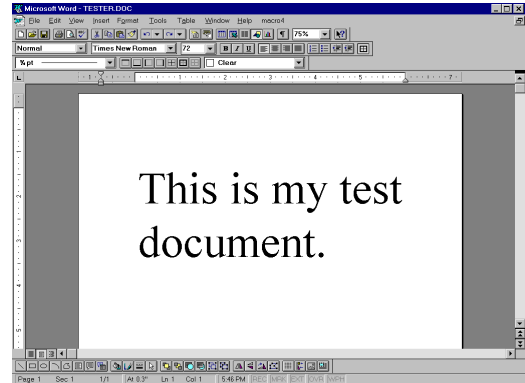

2. From the **File** menu, click **Print**.
3. Select **RapidComm Voice** as the printer. This can be changed in most Windows applications in the **Print** or **Printer Setup** dialog box.
4. Click **OK** or **Print** (whichever button you click in your application to indicate that you are ready to print) in the **Print** dialog box.

SOFTWARE INSTALLATION AND TESTING

5. When you see the following screen, fill in the necessary information in the text boxes. For testing purposes, send your “tester” document to the 3Com fax number, 847-676-3559.



NOTE: If you need to enter a prefix (such as 9) to dial a number outside your building, type the prefix before the fax number in the Fax number field.

Send Fax

Send fax to:

Fax number: 18476763559

Name: tester

Company: U.S. Robotics

Add to Phone Book... Open Phone Book...

Send Fax

Preview...

Cancel

Help

Subject:

Cover page note: Send cover page

Attachments...

Options...

Cover page template: Generic Fax

When you finish, click **Send Fax**.

6. You will see a series of screens as the fax is being transmitted. When the fax has been successfully transmitted, you will see a screen that looks like this.

SOFTWARE INSTALLATION AND TESTING

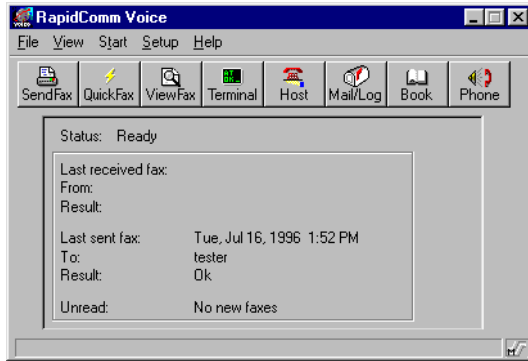

Congratulations —you are now ready to start using your Sportster modem!

Go to the electronic RapidComm Voice manual on your Connections CD for more detailed instructions on sending faxes and other things you can do using your Sportster modem and RapidComm Voice software.

INSTALLING OTHER FAX/DATA SOFTWARE

Your modem was designed for and tested using a wide range of communications software packages. This section will guide you through some of the details you may need to know when installing communications software packages other than RapidComm Voice (included on the Connections CD-ROM).

Type of Modem

Most communications software programs will ask you to select the type of modem you are using. Select a U.S. Robotics Sportster high speed modem. If that selection is not listed, pick Courier Dual Standard, V.32bis, or V.34.

Initialization String

For hardware flow control, a fixed serial port rate, and full result codes, type **AT&F1** and then press **ENTER**. If you must use software flow control, type **AT&F2** and then press **ENTER**.

Flow Control

For hardware flow control (highly recommended), select **RTS/CTS**. For software flow control, select **XON/XOFF**. You may need to disable the flow control (hardware or software) that you are not using.

U.S. ROBOTICS MODEM UPDATE WIZARD

Your Connections™ CD-ROM includes the U.S. Robotics Modem Update Wizard. This software is designed to quickly update your modem, whether to a newer version of its current code or to 3Com's revolutionary new x2™ technology. You can update your modem in any of the following 3 ways:

33.6 K	to	33.6 K (update)	=	FREE
33.6 K	to	56 K (upgrade)	=	\$FEE*
56 K	to	56 K (update)	=	FREE

* Fee for upgrades is subject to change.



NOTE: You can obtain this software from our BBS (847-982-5092) or from our World Wide Web page (www.3com.com) if you do not have a Connections CD-ROM.



NOTE: Complete the instructions in the Software Installation and Testing section of this manual before installing the Modem Update Wizard.



NOTE: These instructions pertain to Windows 3.x and Windows 95. However, only Windows 95 screen shots are shown unless the process for Windows 3.x users differ significantly.

Installation

1. Insert the Connections CD-ROM into your CD-ROM drive.

U.S. ROBOTICS MODEM UPDATE WIZARD

- Click the Windows **Start** menu and point to **Programs**. Point to **U.S. Robotics Connections**. Then click **Connections**.

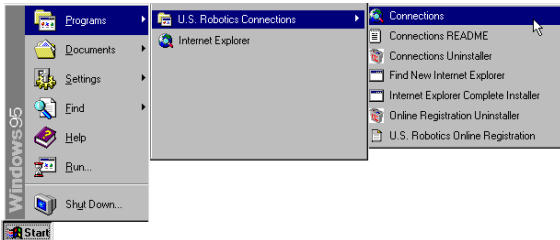

 **NOTE:** Windows 3.x users launch the CD-ROM by clicking the Connections icon in the Connections program group.

- From the main **Connections** menu, click **Customer Support** (circled in the following screen shot).

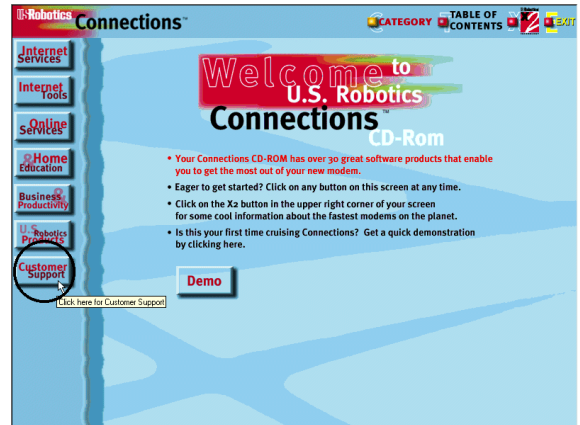

U.S. ROBOTICS MODEM UPDATE WIZARD

4. When the **Customer Support** menu appears, click **Modem Update Wizard** (circled in the following screen shot).



5. Next, click **Learn More & Get Software** (circled in the following screen shot).



U.S. ROBOTICS MODEM UPDATE WIZARD

6. In the following screen, click **Install** (circled below).



7. This launches the U.S. Robotics Modem Update Wizard Installer. The screen that follows is the welcome screen for the installer. After you read this screen, click **Next**.

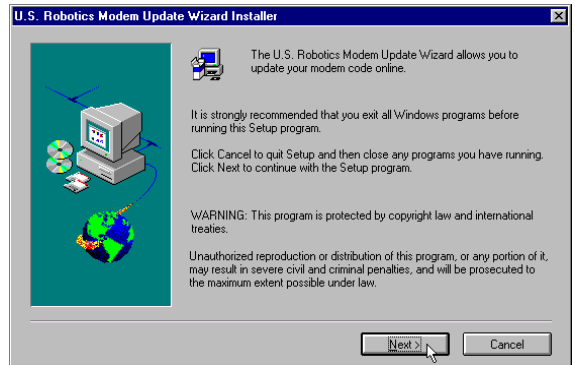

U.S. ROBOTICS MODEM UPDATE WIZARD

8. The next screen indicates where the installer will store the files for the Update Wizard. If the indicated location is acceptable, click **Next**. Otherwise, click **Browse** to find an acceptable directory.

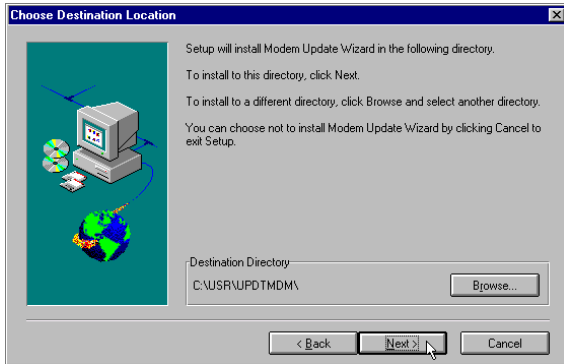

9. You will see the following screen for a moment as the installer creates the Modem Update Wizard program group.

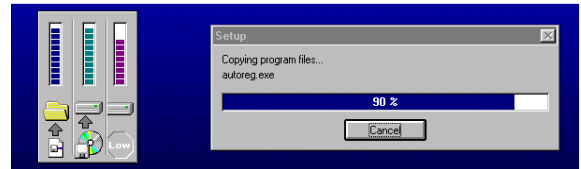

10. This screen indicates that the setup is complete. Click **OK**.

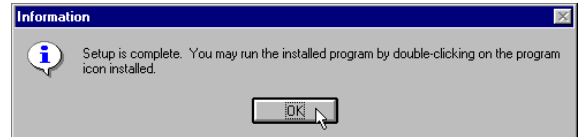

U.S. ROBOTICS MODEM UPDATE WIZARD

Operation

1. Click the Windows **Start** button. Point to **Programs**. Then point to **U.S. Robotics Modem Update Wizard**. Finally, click **Modem Update Wizard**.
2. After you read the “Welcome” screen, click **Next**.



3. This brings up the license agreement. After reading the license agreement, click **Accept** to continue.



U.S. ROBOTICS MODEM UPDATE WIZARD

- The software will now detect any modems installed on your system. When the detection phase finishes, you will see the following screen (the modems shown on your screen may differ). Click the modem you wish to upgrade and then click **Next** to continue.

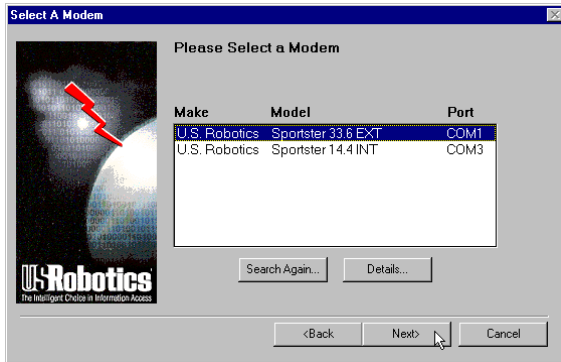

- The program will now determine if the selected modem is software upgradable.

Non-Upgradable Modems

If your modem **IS NOT** software upgradable, the program will display the following screen.

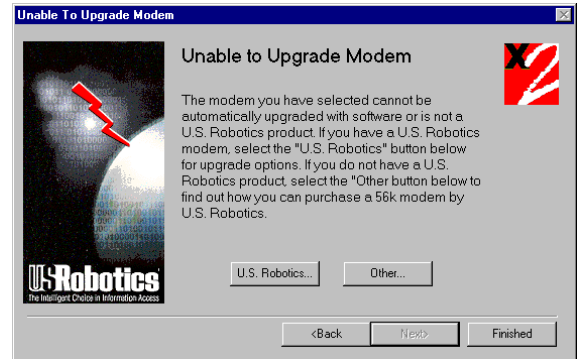

- Click **U.S. Robotics** if your modem is a U.S. Robotics modem to learn more about your upgrade options.

U.S. ROBOTICS MODEM UPDATE WIZARD

- **Click Other** to learn more about how to purchase a U.S. Robotics x2 modem.

Upgradable Modems

If the modem **IS** software upgradable, you will see the following screen.

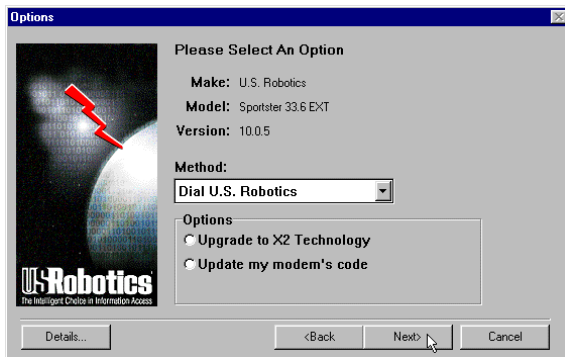

Click **Dial U.S. Robotics** (which should be the default selection) in the pull-down menu. Click **Upgrade to x2 Technology** if you wish

to upgrade a 33.6 kbps modem to 56 kbps code or click **Update my modem's code** to update your modem with the most recent version of its original code. Then click **Next**.

6. The next screen you will see is the order information screen. Users who are purchasing a 56K upgrade will see a screen that includes a credit card information query. Users who are updating their modem's code will see a personal information query screen. Fill in the screen with the appropriate information and then click **Next**.

U.S. ROBOTICS MODEM UPDATE WIZARD

- The following screen dials the U.S. Robotics Update Server. Click **Tone** or **Pulse** dialing as necessary. If you normally dial a prefix (such as 9) to dial out on your phone line, type that prefix before the 1 in the **Prefix** box. Then click **Dial**.



NOTE: Your screen may show a different number in the **Number** field.

The screenshot shows a window titled "US Robotics' Server" with a close button in the top right corner. The window contains the following elements:

- A "Select a Port" dropdown menu with "COM1" selected.
- A "Dialing Options" section containing two radio buttons: "Tone" (which is selected) and "Pulse".
- A "Calling From" dropdown menu with "United States" selected.
- Two input fields: "Prefix" containing the number "1" and "Number" containing "(847)982-5092".
- Two buttons at the bottom: "Dial" and "Cancel". A mouse cursor is pointing at the "Dial" button.

U.S. ROBOTICS MODEM UPDATE WIZARD

- Once connected, the server will compare available upgrades with the current code in your modem. If they differ, the server will automatically initiate the download procedure.



NOTE: Users purchasing a 56K upgrade are asked if the charge is acceptable (see the following screen image). Unless you have already been charged for an upgrade, click Yes to continue. If you have already been through this process once before, DO NOT click Yes. Click No and call Customer Support at 847-982-5151. (The price of the upgrade is subject to change and includes applicable taxes.)

Information



Do you agree to a final charge of 60.00?

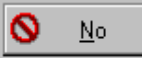

NOTE: If you do not have the most up to date .inf file for your modem (the file that helps Windows correctly identify your modem), you will see the following screen as the Modem Update Wizard automatically downloads the file.

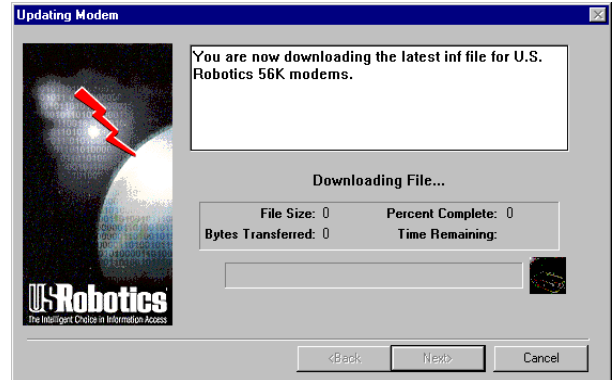

U.S. ROBOTICS MODEM UPDATE WIZARD

9. You will see this screen as the Wizard downloads the file for your modem.

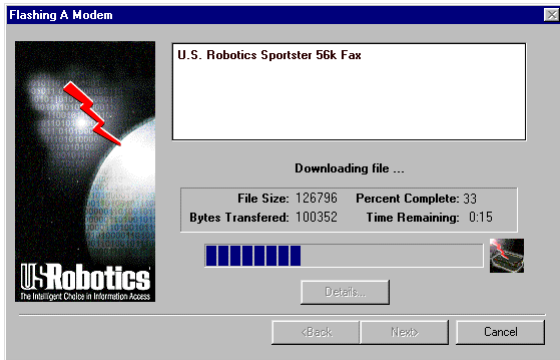

10. When the download is complete, the modem disconnects from the server. The words “Downloading file...” change to “Upgrading ...” or “Updating ...”, depending on whether you are upgrading or updating your modem. A new progress bar appears. This indicates that your modem’s code is being updated.

 **WARNING!** To avoid the risk of damaging your modem, **DO NOT** turn off the modem while it is being updated.

11. When updating is complete, the progress bar will be full and an “Update/Upgrade Complete” message appears. Click **Next**.

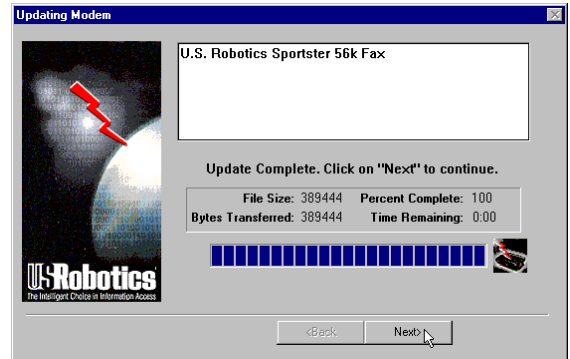

U.S. ROBOTICS MODEM UPDATE WIZARD

12. You will see a “Congratulations!” screen.
Click **Details**.

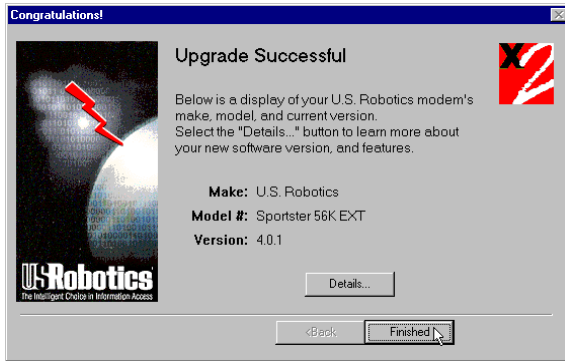

13. Click **OK** once you verify that the process was a success. When you return to the “Congratulations!” screen, click **Finished**.



Congratulations!

Enjoy the benefits of your updated Sportster modem!

USING MODEM STATION

What Does Modem Station Do?

- ◆ Modem Station provides a simple to use interface that makes communicating with your modem even easier.
- ◆ Modem Station allows you to point and click your way through configuration.
- ◆ Modem Station can automatically detect your modem and provide you with all the technical information you need, whenever you need it!

Why Modem Station?

- ◆ Modem commands can be confusing and difficult to memorize.
- ◆ Communications software often needs technical information about your modem.

- ◆ You may want to “tweak” your modem for optimum performance.
- ◆ You’d rather be surfing the Internet.

Installing Modem Station

If you did not install Modem Station when you first installed the Connections CD, please follow these instructions.

1. Insert the Connections CD into your CD-ROM drive.
2. Double-click the **My Computer** icon on your desktop.
3. Double-click the **CD-ROM** icon.
4. Double-click the **USR Tools** folder.
5. Double-click the **umssetup** icon.

USING MODEM STATION

6. You will be asked whether you wish to install Modem Station. Click **Yes**.
7. Wait a few moments for the Installation Wizard to load.
8. After reading the information on the “Welcome” screen, click **Next**.



9. When you see this screen, click **Next** to accept the default directory or click **Browse** to change directories.

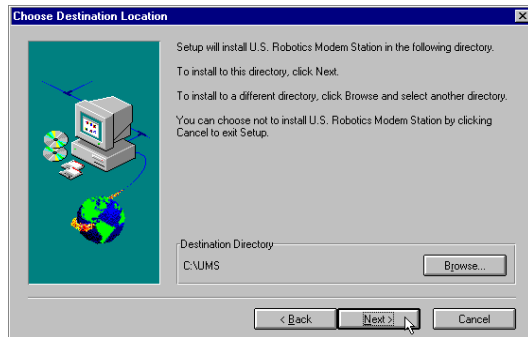

USING MODEM STATION

10. Click **Next** on the following screen to accept the default program folder. You can place Modem Station in an existing folder by selecting one from the list.

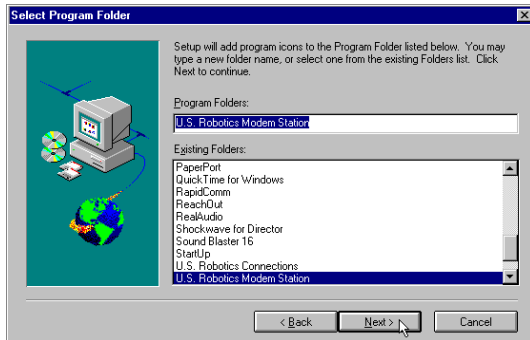

11. When you see the following screen, click **Finish** to complete the installation.

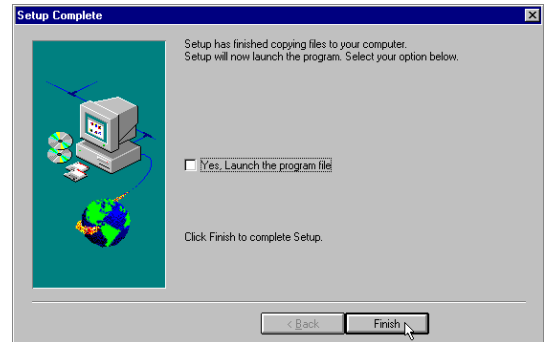

If this is the first time you've installed Modem Station, you may be asked to restart your computer.

USING MODEM STATION

Starting Modem Station

1. If you didn't start Modem Station from the Setup program, please start it now.
2. Click Windows **Start** button and then point to **Programs**. Click **U.S. Robotics Modem Station** (or the folder you selected during installation).
3. Click the **Modem Station** icon. This brings up the main menu.

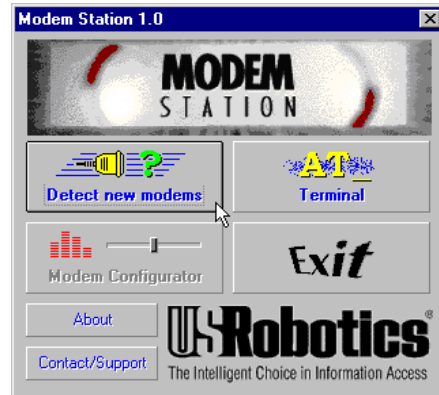

USING MODEM STATION

The main menu gives you direct access to the following options:

- ◆ DETECT NEW MODEMS
- ◆ TERMINAL
- ◆ MODEM CONFIGURATOR
- ◆ ABOUT
- ◆ CONTACT/SUPPORT

DETECT NEW MODEMS

This option detects US Robotics modems installed on your system and shows what COM port they are using. Click this option if you are running Modem Station for the first time, if you are changing modems, or if you simply need to know what port your modem is using.

TERMINAL

Terminal allows you to send commands directly to your modem and displays the

responses. You can use Terminal to dial up BBSs. In addition, you can configure your modem using Terminal. However, it is much easier to use the Modem Configurator.

MODEM CONFIGURATOR

Modem Configurator provides an easy-to-use interface for entering hard to remember commands. Use Modem Configurator for troubleshooting, initial configuration, and tuning your modem for optimum performance. Using the options available in Modem Configurator, you can control nearly every aspect of your modem's performance. We will discuss Modem Configurator's options in more detail in later sections.

ABOUT

The About option provides copyright and version information.

USING MODEM STATION

CONTACT/SUPPORT

This option details how to get in touch with U.S. Robotics.



TIP: For your convenience, we provide many on-line support avenues. For specific questions, our fax-on-demand service is a good place to start. You can download FAQs, software, and help files from our Web sites and BBS, or receive individualized support via support@usr.com. Type 0000 (4 zeroes) in the subject line of your e-mail.

Using Detect New Modems

1. Click **Detect New Modems** to bring up the following screen.

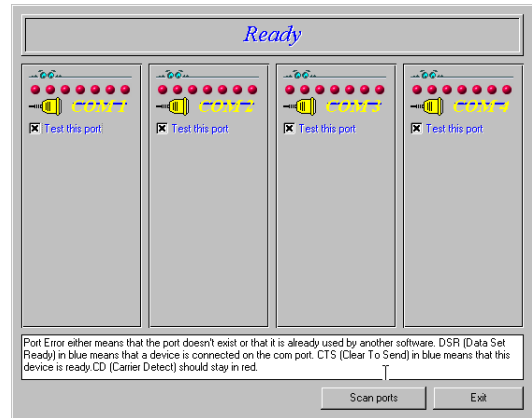

The screen consists of four columns, one for each possible COM port on a PC. You can scan a specific port(s) by selecting the checkbox for that port.

USING MODEM STATION

2. Click **Scan** to have Modem Station check for installed modems. This may take a few moments.
3. When the scan finishes, you will see the following display. Your display may differ depending on the type and number of modems installed.

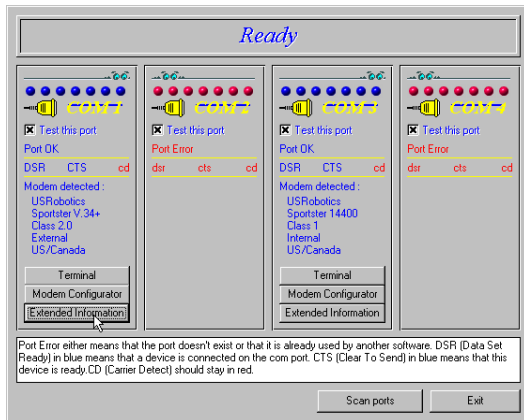

If your modem is installed and configured correctly, Modem Station will find the modem and display make and model information under the assigned port. All currently active ports should display “Port OK” under the heading. If a port displays a “Port Error”, it usually means that the port is disabled in system setup.



NOTE: Different systems and BIOSes use different methods of disabling COM ports. As a result, we cannot provide support for enabling COM ports. Please refer to your system's documentation or contact the manufacturer of your system for further information.

USING MODEM STATION

If you look at the information for the port your modem is using, you will see three buttons. These allow you to access Terminal and Modem Configurator without going back to the main menu. Extended Information provides detailed information about your modem, previous connections, firmware dates, etc. This next section details using the Terminal option.

Using Terminal

You can access Terminal from either the **Main** menu or the Detect New Modems screen. Clicking **Terminal** brings up the Terminal window.



In addition to allowing direct entry of modem commands, the Terminal window also allows you to dial into Bulletin Boards, listing services, and other online services.

USING MODEM STATION

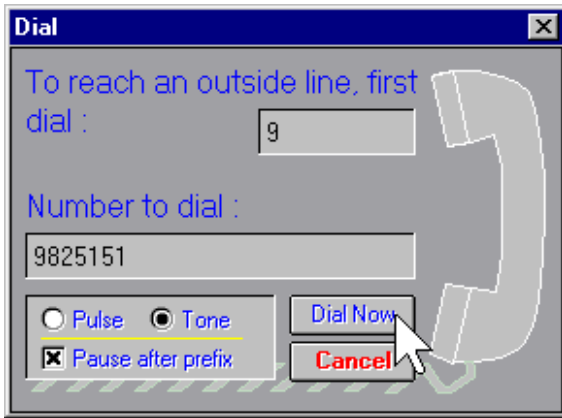

NOTE: Modem Station's Terminal window is provided primarily for troubleshooting convenience. If you frequently use BBSs, you will probably want to use a separate, full-featured Terminal program like the one provided in our RapidComm software.

On the lower part of the Terminal screen, you will see the COM port your modem is currently using. To select another modem, simply click on the arrow and select that modem's assigned port.

To the right of the port settings are the port speed settings. Port speed is the speed at which your computer sends data to the

USING MODEM STATION

modem. We will discuss port speed settings in detail later in this section.

Terminal includes a basic auto dialer.

To have Terminal dial a number for you, click **Dial** to bring up the “Dial” screen.

You need to tell the Dialer a few things about your phone system, such as whether it uses tone or pulse dialing, what digit, if any, you need to dial to get an outside line, and whether the dialer should wait between dialing that digit and the rest of the number. Once you provide this information, simply enter the phone number as if you were dialing a telephone. Click **Dial Now** to dial the number.

You can end a call by clicking **Hang Up** at the bottom of the screen.

When you are finished using Terminal, click **Exit** to return to the screen you accessed it from.

Using Modem Configurator

You can access Modem Configurator from either the **Main** menu or the Detect New Modems screen.

Click **Modem Configurator** to bring up this menu.

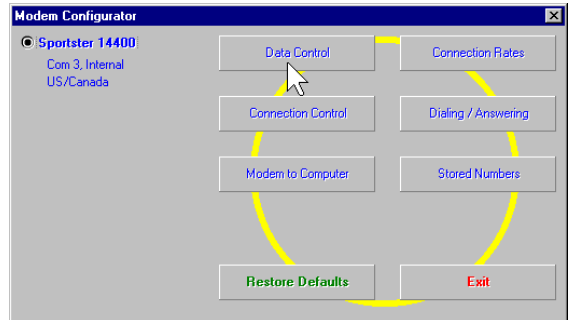

USING MODEM STATION

The **Modem Configurator** menu gives you access to the following options:

- ◆ DATA CONTROL
- ◆ CONNECTION CONTROL
- ◆ MODEM TO COMPUTER
- ◆ CONNECTION RATES
- ◆ DIALING/ANSWERING
- ◆ STORED NUMBERS
- ◆ RESTORE DEFAULTS
- ◆ EXIT

Data Control

This is the “Data Control” screen.

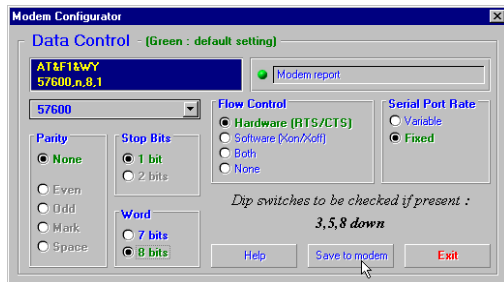

The “Data Control” screen allows you to assign the following basic communications settings:

- ◆ PORT SPEED
- ◆ PARITY
- ◆ STOP BITS
- ◆ WORD
- ◆ FLOW CONTROL
- ◆ SERIAL PORT RATE

For information on using these settings, please refer to the “Glossary” at the back of this manual.

Click **Help** for quick definitions of the terminology used in this screen.

In the upper left-hand corner of the screen, you will see the data control commands currently in use.

USING MODEM STATION

Once you have entered the Data Control settings, click **Save to Modem**. This stores the settings so that you do not have to re-enter them.

This screen also displays the default DIP switch settings.



TECHNICAL STUFF: DIP switches are tiny switches that control a few basic functions on some external modems. On modems without DIP switches, these functions are handled by modem commands.

Click **Exit** to return to the **Modem Configurator** menu.

CONNECTION CONTROL

This is where you adjust your modem's connection and transmission settings.

Click **Connection Control** to bring up this screen.

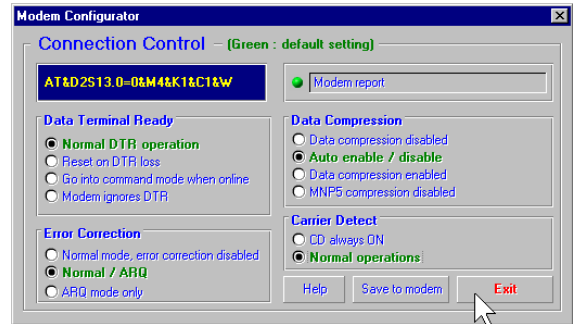

In the upper left hand corner of this screen, you will find the current Connection Control settings.

USING MODEM STATION

Use the “Connections Control” screen to configure the following settings:

- ◆ DATA TERMINAL READY (DTR)
- ◆ ERROR CORRECTION
- ◆ DATA COMPRESSION
- ◆ CARRIER DETECT

For detailed information about these settings, refer to the “Glossary” or the “Technical Quick Reference” sections of this manual.

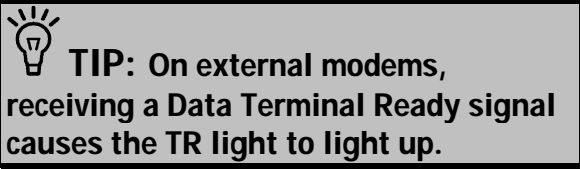

Click **Help** for quick definitions of terminology used in this screen.

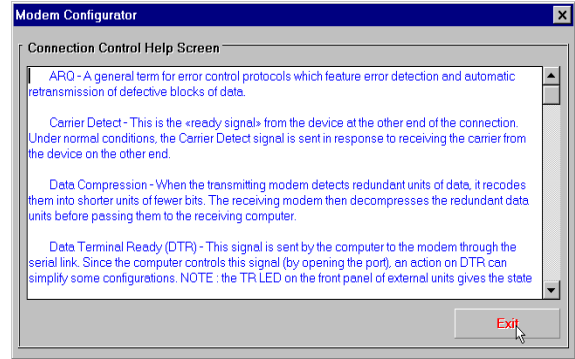

Once you have configured your Connection Control settings, click **Save to Modem** to save your settings

Using Modem to Computer

These settings control how your modem and computer communicate with each other. They control what you see on your terminal screen and how results are displayed.

USING MODEM STATION

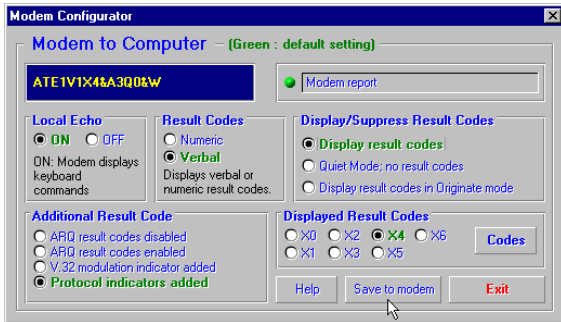

If you look in the upper left hand corner of the display, you will see the commands currently in use.

The “Modem to Computer” screen allows you to configure the following settings:

- ◆ LOCAL ECHO
- ◆ RESULT CODES
- ◆ RESULT CODE PREFERENCES



TIP: If you type ATDT and see ‘AATDDTT’ on your screen, it is possible that both your software and modem have Local Echo set to ‘ON’. Turn Local Echo ‘OFF’ on EITHER the modem or the software to solve this problem.

For details on using the commands in this screen, refer to the “Glossary” or “Technical Quick Reference” sections of this manual.

Click **Help** to see quick definitions of terminology used in this screen.

This screen also includes a chart of the ways result codes can be displayed. Click **Codes** to view a chart of the display options.

Once you configure your settings, click **Save to Modem** to save your choices.

USING MODEM STATION

CONNECTION RATES

The “Connection Rates” screen allows you to configure modem speeds and protocols.



WARNING! Use caution when changing connection settings. Improper settings may cause your modem to function incorrectly, disconnect, or fail to connect at all.

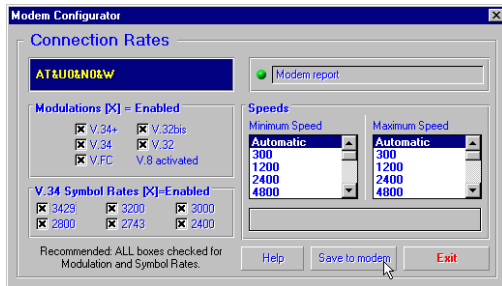

In the upper left hand corner of the screen you will see the current connection commands.

This screen allows you to configure the following settings:

- ◆ MODULATIONS
- ◆ V.34 SYMBOL RATES
- ◆ SPEEDS

Again, once you have selected your settings, click **Save to Modem** to save them.

When you are finished, click **Exit** to return to the **Modem Configurator** menu.

Please refer to the main body of the manual and the “Glossary” for detailed information about the terminology and settings used in this screen.

Click **Help** for quick definitions of terminology used in this screen.

USING MODEM STATION

DIALING/ANSWERING

The next screen allows you to adjust how your modem initiates and receives calls.

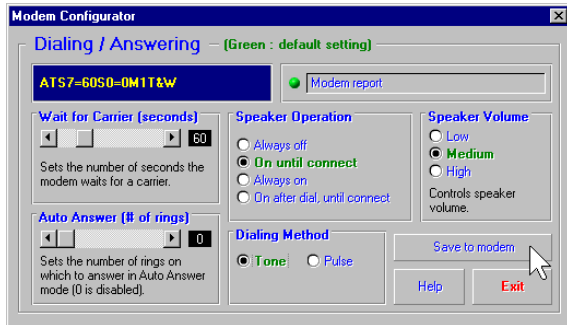

Using this screen, you can configure the following dial settings:

- ◆ WAIT FOR CARRIER
- ◆ AUTO-ANSWER # OF RINGS
- ◆ SPEAKER OPERATION
- ◆ DIALING METHOD
- ◆ SPEAKER VOLUME



TECHNICAL STUFF:
“Negotiation” is the noise we hear when two modems connect. The modems exchange information about their respective protocols and configurations. Once they agree on the fastest protocol they can both handle, transmission begins.

STORED NUMBERS

The “Stored Numbers” screen displays the phone numbers currently stored in your modem’s memory.

Use this screen to edit or add numbers stored in the modem’s memory.

USING MODEM STATION

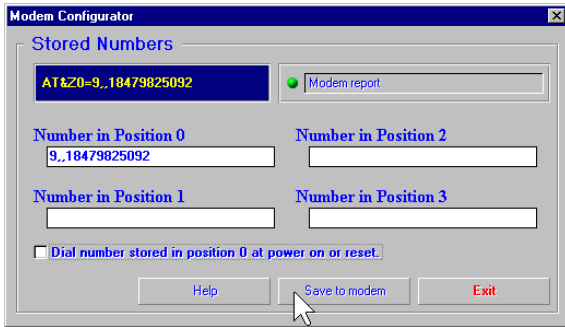

To store a number in your modem's memory, simply click in one of the entry boxes. Type in the phone number exactly as you would dial it. NOTE: Position Zero has a special feature. You can set your modem to automatically dial this number when your computer is turned on or when it is reset.

This is very useful if you are using your modem with a "dumb terminal" or know that you need to connect to a specific bulletin board or listing service.

You can change stored numbers by highlighting them and then typing the new numbers in their place. Once you store your numbers, you can dial them by entering this command from Terminal Mode:

ATDS0, ATDS1, ATDS2, etc.

Your U.S. Robotics modem comes with one phone number already stored in Position 0. If you haven't changed the default, typing **ATDS0** will automatically dial the U.S. Robotics BBS. You will want to change this if you are using a dumb terminal or online listing service, of course.

Once you enter the numbers you wish to store, click **Save to Modem** to store them. Click **Exit** to return to the **Main** menu.

The last option, Restore Defaults, resets your modem to factory specifications. This option is

USING MODEM STATION

available from many of the screens within Modem Station. When you click **Restore Defaults**, you will see a confirmation screen asking if you are sure you want to restore defaults. Click **OK** to proceed.



TIP: Restore Defaults will set your modem back to factory specifications. It is a good place to start when troubleshooting.

Using the Extended Information Screens

The “Extended Information” screens provide important and useful information about your modem. Unfortunately, some of this information is very complex.

We devote a separate section to the Extended Information screens so that we can explain what you’ll see (and why it is important to you) as fully as possible.

There are a series of commands used to obtain detailed information from U.S. Robotics modems. Extended Information provides a convenient way to get that important information without memorizing the commands.

From the “Detect New Modems” screen, click **Extended Information**.

The “Extended Information” screen provides access to the following information about your modem:

- ◆ ROM CHECKSUM
- ◆ PRODUCT
- ◆ ACTIVE PROFILE
- ◆ STORED PROFILE

USING MODEM STATION

- ◆ CONFIGURATION PROFILE
- ◆ LINK DIAGNOSTICS
- ◆ VxD CONFIGURATION
- ◆ DIAL/SECURITY

Winmodem users will have access to VxD information via these screens.

Courier users will have access to Dial/Security information.

Click **ROM Checksum** to bring up the following screen.

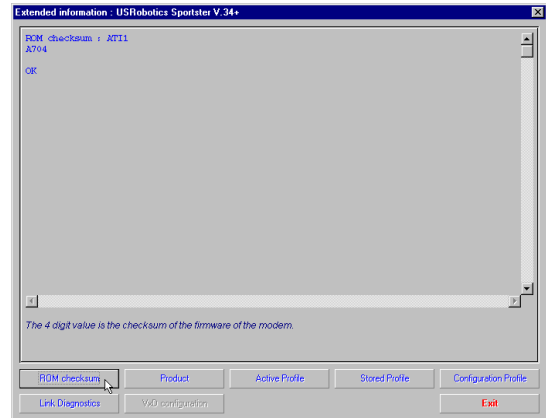

Technicians use the ROM Checksum to verify information stored in the modem's Read Only Memory. You can check the ROM Checksum from any Terminal program by typing **AT11** and pressing **ENTER**. For information about the specific modem you are using, click **Product** to bring up the next screen.

USING MODEM STATION

To see information about the profile in use, click **Active Profile** to bring up the next screen.

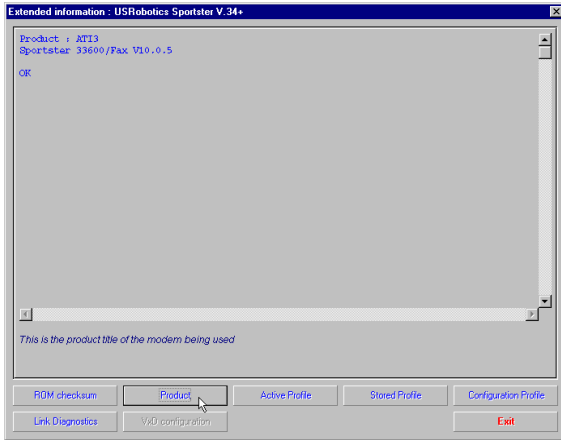

The “Product” screen displays the make and model of your modem. It is the equivalent of the AT13 command.

Your modem is able to store two configurations or “profiles.” Only one can be active at any time.

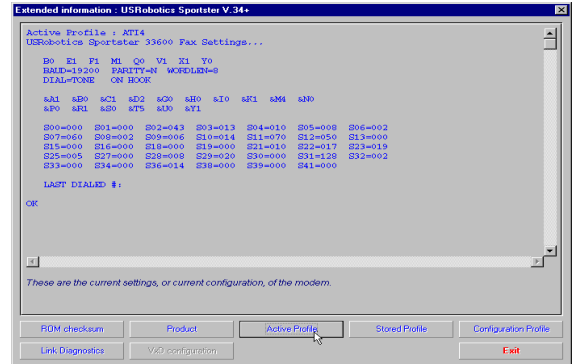

This screen contains information about your modem’s current configuration. Starting from the top, you will see the make and model of your modem. Directly below that you will see basic commands currently in use. Below that are the current connection settings.

USING MODEM STATION

The two lines below the connection settings are the advanced commands currently in use. Below them is a display of the contents of the ‘S-Registers’ for your modem. These registers are special programmable areas of your modem’s memory. They are used to store commands that are too complex to be handled by the standard (or ‘AT’) commands.

Just below that you will see the last number dialed. You can also see this information by typing **ATI4** in a Terminal program and pressing **ENTER**.

The next option displays the “Stored Profile” screen. This screen shows the configuration stored in your modem’s NVRAM (special programmable memory). Note that any stored phone numbers are displayed on this screen as well. This is the equivalent of the **ATI5** command. The information displayed is in the

same format as the “Active Profile” screen with the addition of stored phone numbers.

The next two screens contain information that our technical support representatives may need if you request support.

Click **Configuration** to bring up the first of these screens.

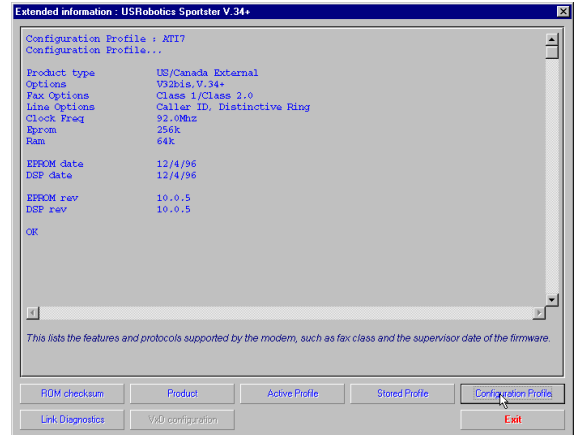

USING MODEM STATION

The “Configuration” screen displays the following information about your modem.

- Product Type displays the information relating to the make and model of your modem.
- Options displays the protocols available to your modem.
- Fax Options displays your fax compatibility.
- Clock Frequency displays the speed of the tiny “clock” that controls the timing of operations within the modem.
- EPROM displays how much information can be stored in the EPROM (or Supervisor) chip.
- RAM displays how much memory your modem has for processing commands and internal functions.
- Supervisor Date (or EPROM Date) displays the version date of the ‘firmware’ stored in the Supervisor chip. (The

Supervisor chip contains the special software used to control your modem’s functions.) If a support representative asks you for your Supervisor or EPROM date, look here.

- DSP Date is the date of the ‘firmware’ that controls the DSP in your modem.
- Supervisor and DSP rev (or revisions) are the equivalent of software version numbers.



TECHNICAL STUFF: The Supervisor chip contains the commands that control your modem. The DSP controls execution of those commands. The Supervisor chip needs orders from the DSP before it can carry out a command.

USING MODEM STATION

- DAA Country displays the countries your modem is designed for. This is important because phone systems and telecommunications laws vary from country to country.

Click **Link Diagnostics** to bring up the “Link Diagnostics” screen.

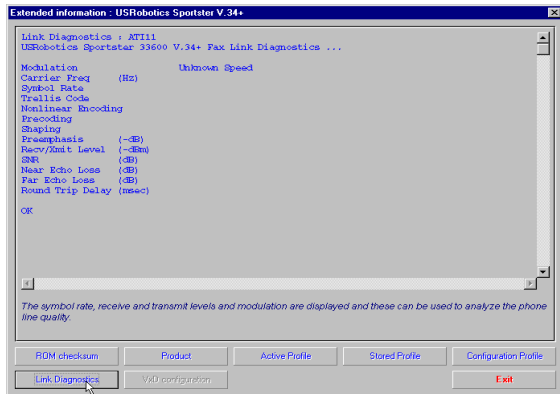

The “Link Diagnostics” screen displays statistics about your last connection. This screen is most often used as an aid in diagnosing connection failures, but it also can provide information about connection speeds and phone line conditions.

- Modulation displays the speed and type of connection.
- Carrier Frequency displays the electrical frequency of the carrier signal.
- Symbol Rate displays the speed of the transmission.
- Trellis Code, Nonlinear Encoding, Shaping, and Precoding all refer to methods of handling high speed data transmission.
- The items followed by (dB), (-dB), (-dBm), and (msec) refer to variations in the modulation tones that actually carry the information.

USING MODEM STATION

The rest of the screen contains information about CRC errors, Block Errors (Blers), resent data, and other data. This information is very important if you experience problems transmitting or receiving data or if you suspect problems with your phone service.

Only our U.S. Robotics Winmodem™ faxmodems use VxDs, or Virtual Device Drivers. The Winmodem product uses special software (called a ‘driver’) to manage many of the functions handled by hardware in our other modems. If you are using a Winmodem, the Extended Information menu will offer you the option of clicking on VxD to view information on the Winmodem driver. Please refer to your Winmodem manual for detailed information on the Winmodem drivers.

Courier modem users will see a display of current Dialback/Security settings. Refer to

your Courier documentation for instructions on configuring these special features.

We hope that you enjoy exploring the world of information and entertainment your new Sportster modem will open up for you and that Modem Station will make using and configuring your new modem as simple as possible.

Remember: If you have any questions or problems, feel free to visit one of our many online forums.

For answers to specific questions, be sure to visit our World Wide Web support site at **www.usr.com/home/online/main.htm**, or try our BBS (847-982-5092).

TROUBLESHOOTING AND ONLINE HELP RESOURCES

PROBLEM

DIAGNOSIS

POSSIBLE SOLUTION

The computer or software will not recognize the modem.

Your modem might not be turned on.

You may not be entering modem commands in the proper manner while in terminal mode.

You may have a COM port/IRQ conflict.

Make sure the modem is turned on. The power switch is on top of external modems. The CS light on the front panel should be lit. If you installed an internal modem, it should power up when the computer is turned on.

When entering commands in a terminal program, type in all upper case (AT) or all lower case (at).

WINDOWS 95 USERS: Uninstall the modem from your computer. In Device Manager, determine what COM port and IRQ settings are free on your system. Set the jumper shunts on your modem's jumper pins to these free settings, using the diagrams below as a guide. If no IRQ setting is available, you may need to move a device off of an IRQ in order to free it for use by your modem.

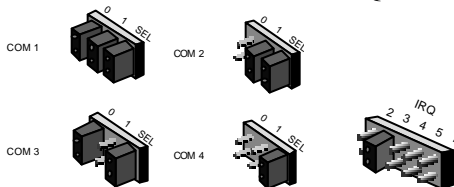

TROUBLESHOOTING AND ONLINE HELP RESOURCES

PROBLEM	DIAGNOSIS	POSSIBLE SOLUTION
The computer or software will not recognize the modem (cont.).	You may have a COM port/IRQ conflict (cont.).	Make sure you have the correct COM port and IRQ settings in your software and/or in the Windows Device Manager.
The modem displays double characters on your monitor.	Both the modem's and software's local character echoes are turned on.	Disable Local Echo in your software OR on your modem (not both). Turn local echo off on the modem by typing ATE0 and pressing ENTER in your software's terminal mode. To turn the local echo off in the software, refer to its documentation.
The modem won't go off hook to dial or doesn't answer the phone.	You may have plugged your modem's phone cord into a digital line.	Plugging your modem's phone cord into a digital phone line can damage the modem. Call your phone company if you are unsure whether or not your phone line is digital.
	You might have a bad phone cord connection to your modem.	The phone cord should be plugged into the TELCO jack on the modem and an analog wall phone jack. The phone cord should not exceed 12 feet in length. Use the phone cord included with your modem if possible.
	You may have devices between the modem and the phone jack.	There should be no line splitters, fax machines, or other devices between the modem and the wall jack.
	You may have a poor line connection.	Place the call again. Calls are routed differently each time. To verify a valid phone connection, enter RapidComm's Terminal mode, type ATX3DT18479825092 (the 3Com BBS), and press ENTER . This string bypasses the dial tone, allowing a connection if the modem is functioning properly.

TROUBLESHOOTING AND ONLINE HELP RESOURCES

PROBLEM	DIAGNOSIS	POSSIBLE SOLUTION
The modem won't go off hook to dial or doesn't answer the phone (cont.)	If you have voice mail, your dial tone may be altered when messages are waiting.	Answer your voice mail to restore your normal dial tone.
	Your software may not have auto answer enabled.	Enable the auto answer feature. In RapidComm's Terminal mode, type ATS0=1 and press ENTER . NOTE: You need to enable auto answer before every session unless you alter your software's initialization string to permanently enable auto answer.
Both modems exchange carrier signals but fail to establish a link.	You may have a poor line connection.	Try placing the call again. The phone company routes calls differently each time. To verify a valid phone connection, enter RapidComm's Terminal mode and type ATX3DT18479825092 and press ENTER (the phone number is the 3Com BBS). This string bypasses the dial tone, allowing a connection if the modem is functioning properly.
	There may be line splitters or other devices between your modem and the phone jack.	Remove all devices between the modem and the phone jack it is using. Make sure the phone cord you are using is no longer than 12 feet in length. Use the phone cord included with your Sportster if possible.
Your 33.6 kbps modem cannot achieve a 33.6 kbps Internet connection.	The phone line you are currently using may not be clean enough to achieve a 33.6 kbps connection.	Try using a different phone line. Make sure the phone line you are using is an analog phone line. Using a digital phone line will damage your modem.

TROUBLESHOOTING AND ONLINE HELP RESOURCES

PROBLEM	DIAGNOSIS	POSSIBLE SOLUTION
Your modem won't connect at 2400 bps with a 2400 bps modem.	The modem you're trying to connect with could be an older model that doesn't support error control.	You can disable error control on your modem by typing AT&M0 in terminal mode and pressing ENTER . Now try placing the call to the remote modem again. When finished, reset your modem to enable the error control features. In terminal mode, type ATZ and press ENTER . Note: ATZ4 or AT&F1 are often the best reset strings, as they restore hardware flow control defaults.
Your screen keeps displaying random garbage characters.	<p>You could have a conflict with the remote modem's settings for word length, parity, and stop bits.</p> <p>Your software and modem might not be set to the same flow control settings.</p> <p>The best flow control settings might not be enabled on your modem.</p>	<p>Set your modem's word length, parity, and stop bits the same as the remote modem or BBS you are calling. The most common settings are: data bits=8. Stop bits=1, parity=none, flow control=hardware (RTS/CTS)</p> <p>Make sure the software and modem have the same flow control settings (hardware [RTS/CTS] and software [xon/xoff]).</p> <p>In terminal mode, type AT&F1 and press ENTER to load the optimal settings.</p>

TROUBLESHOOTING AND ONLINE HELP RESOURCES

PROBLEM	DIAGNOSIS	POSSIBLE SOLUTION
Your communications software is reporting many cyclic redundancy check (CRC) errors and low characters per second (CPS).	You may have a bad phone line.	Try placing the call again. The phone company routes calls differently each time.
	Optimum flow control settings may not be enabled on your modem.	In terminal mode, type AT&F1 and press ENTER to load the optimum hardware flow control settings.
	The serial port rate in your communications software may be set too high for your modem's UART or your area's phone lines.	Lower the serial port rate in your communications software to 57,600 bps, 38,400 bps, or 19,200 bps. Some software programs, including AOL, allow port rates of 14,400, 28,800, 33,600. These values are invalid and should not be used. NOTE: The port rate for an x2 modem cannot be set lower than 57,600 if you want to achieve an x2 connection.
	The remote site you are dialing into may have trouble with the file transfer protocol.	Try using a different file transfer protocol. Zmodem is the preferred protocol.
	There may be a Terminate and Stay Resident (TSR) program (such as a screen saver or virus scanner) running in the background, disrupting data communications.	Disable any Terminate and Stay Resident (TSR) programs running in the background. If you have software running as a TSR, check the software's manual for information about disabling its ability to operate as a TSR.

TROUBLESHOOTING AND ONLINE HELP RESOURCES

PROBLEM	DIAGNOSIS	POSSIBLE SOLUTION
<p>Your communications software is reporting many cyclic redundancy check (CRC) errors and low characters per second (CPS) (cont.).</p> <p>Errors are constantly occurring in your V.17 fax transmissions.</p>	<p>You may be trying to download a file to a compressed area of your hard disk.</p> <p>Your modem initialization string could be insufficient for fax transmissions.</p> <p>There may be a Terminate and Stay Resident (TSR) program (such as a screen saver or virus scanner) running in the background, disrupting data communications.</p> <p>Your baud rate may be set too high.</p>	<p>Download to an uncompressed area on your hard drive.</p> <p>In your communications software, change the modem initialization string to AT&H3&I2&R2S7=90.</p> <p>Disable any Terminate and Stay Resident (TSR) programs running in the background. If you have software running as a TSR, check the software's manual for information about disabling its ability to operate as a TSR.</p> <p>Lower baud rate to 9600, 7200, or 4800.</p>
<p>RapidComm fails to initialize the modem.</p>	<p>You may be trying to fax a compressed file</p> <p>RapidComm's port settings may be incorrect.</p>	<p>Open the file in the application in which it was created. Select RapidComm as the printer and then print the file.</p> <p>Make sure RapidComm's port settings are correctly set for your modem.</p>

When Plug and Play Fails

If you have been directed to this section, your Plug and Play installation was not successful. Try the following possible solutions:

1. Click Windows 95 **Start** and click **Shut Down**. When asked if you wish to shut down your computer, click **Yes**. When Windows 95 indicates that it is safe to turn off your computer, turn it off and wait 15 seconds. Then turn the computer back on. Windows 95 may detect your modem upon this restart even if it did not detect the modem during the initial installation. If you see screens indicating that new hardware has been detected by Windows 95, turn to “Installing the Modem Drivers” on page xx. If not, continue with the next step.

2. Click Windows 95 **Start**, point to **Settings**, and click **Control Panel**. Double-click the **System** icon and then click the **Device Manager** tab on the “System Properties” screen. Look for “Other Devices” or “Unknown Devices” in the list that appears. If you do not see either of these options in the list, continue with the next section to learn about our support options. If you do see one of these options, double-click the option. If the description that appears matches the modem you are trying to install, click the **Remove** button. Click **OK** when Windows asks if you wish to remove the device. Next, restart the computer as described in step 1 on this page. If the computer does not detect the modem after this second restart, please continue

TROUBLESHOOTING AND ONLINE HELP RESOURCES

reading to learn about our support options.

Online Help Resources

Connecting to the 3Com BBS

To connect to the 3Com Bulletin Board System, follow these steps:

1. Start the RapidComm Voice program.
The software settings for the BBS are:

ANSI terminal emulation
Data Bits: 8
Parity: None
Stop Bits: 1

2. Put RapidComm Voice in Terminal mode
by clicking on the Terminal button.



3. Type **ATDS0** and press **ENTER**.

 **NOTE: ATDS0 automatically dials 1-847-982-5092, the 3Com BBS.**

If this is your first time connecting to our BBS, you will be asked to enter your name, create a password of your choice, and to fill out a questionnaire.

TROUBLESHOOTING AND ONLINE HELP RESOURCES

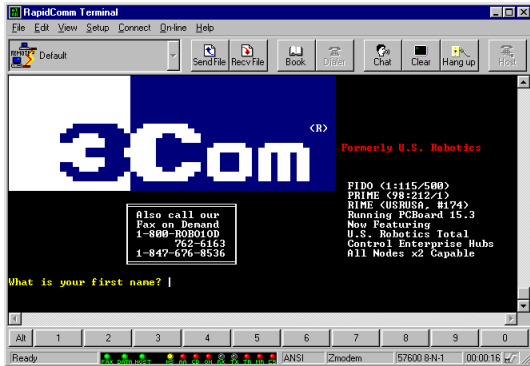

Downloading the User's Guide

To download the User's Guide, follow these steps:

1. In the main menu, type D.

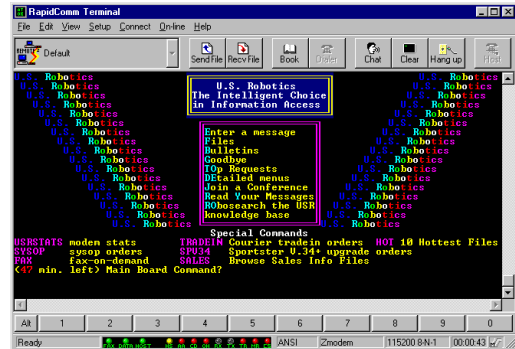

2. A **Filename to Download:** text box appears on the screen.

The preceding screen shot is what the introduction screen of the 3Com BBS will look like. The BBS gives you access to customer and technical support documents and the BBS library which contains hundreds of helpful files and tips to help simplify using your modem.

TROUBLESHOOTING AND ONLINE HELP RESOURCES

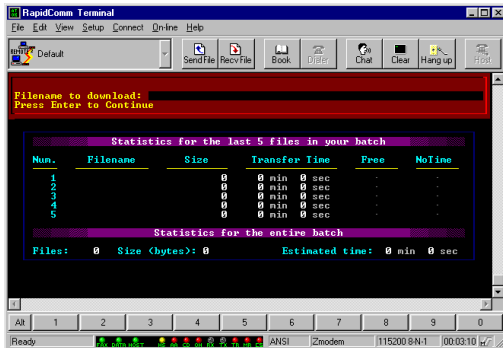

3. Type the name of the file you wish to receive. You have three manual formats from which to choose:
 - VOICE336.EXE—The guide in a self-extracting Word for Windows v6.0 format.
 - VOICE336.PDF—The guide in .pdf format (readable using Adobe Acrobat, which is available on the Connections CD-ROM).

4. Protocol Type for Transfer. Your selection depends on what your software supports. If possible, make Zmodem your first choice.
5. Depending on the software you are using, you will either be prompted where you want the file placed, or the file will be placed in the directory where your communications software is loaded.
6. When the file transfer is complete, and you are ready to leave the BBS, type **G** (for Good-bye) from the main menu.

3Com offers a number of other online technical support options for our U.S. Robotics Sportster modems. Choose any one of the following options if you need help with or want to learn more about your new modem.

TROUBLESHOOTING AND ONLINE HELP RESOURCES

Internet FTP

Provides free library containing the same files as the BBS site. FTP to **ftp.usr.com**.

Internet on Demand

Provides automatic technical support through a library containing product information, quick reference cards, and installation help. To obtain an index of available documents, send a blank e-mail to **support@usr.com**. To have a document e-mailed to you, send the document's number as the subject.

World Wide Web

A U.S. Robotics Home Page containing the same information as the Internet on Demand listing. Log on to:

www.usr.com/home/online/main.htm

CompuServe

Access the same information as the Internet FTP site. Connect through the **US Robotics Forum** or e-mail us through CompuServe Mail for a response within 24 hours. The U.S. Robotics forum address is **GO USROBOTICS**. Address private messages to **76711,707**.

America Online

Go to the **Keyword** field and type **USROBOTICS** to connect to various U.S. Robotics resources, such as file libraries, message boards, online customer support, and product announcements.

Technical Support Hotline

Technical questions about U.S. Robotics modems can also be answered by technical support representatives. The hotline is a toll

TROUBLESHOOTING AND ONLINE HELP RESOURCES

call. In order to save both time and expense, you should do the following before calling:

1. Click the Windows 95 **Start** button.
2. Point to **Programs** and then click **RapidComm Voice**. (If you have not installed RapidComm Voice, see the section title “Software Installation and Testing” on page 33.)
3. Enter RapidComm Voice’s terminal mode by clicking the **Terminal** button.
4. Type **ATI7** and press **ENTER**.
5. The information that appears will be useful to the technical support representative who attempts to troubleshoot your problem when you call. Select **Print** from the **File** menu or leave the information on screen.

Hotline (847) 982-5151

(Hours: 8:00 am - 6:00 pm CST)

Priority No-Hold Service

3Com also staffs its own 900 fee-based number for immediate assistance. These lines are staffed from 8 a.m. - 6 p.m. CST Monday through Friday.

No-Hold line 900-555-USR1

There is a \$1.50 per minute charge which will appear on your local phone bill. You must be 18 or older or have parental permission. (Service not available in Canada.)

Are You Still Having Problems?

- Review this manual.
- Call or visit your modem dealer. They may be able to assist you. This is much

TROUBLESHOOTING AND ONLINE HELP RESOURCES

more efficient and time-saving than returning the modem to U.S. Robotics.

- If your dealer can't help you, contact 3Com Customer Support. When you call, specify your modem serial number (found on the modem and on the outside of the box), the software being used, and, if possible, have the contents of your ATI7 screen available.

If You Need to Return the Modem to Us

Contact 3Com Customer Support. If the support representative determines that you need to return the modem, you will receive an SRO (Service Repair Order) number. You must have an SRO number before returning the modem to us. Ship the unit, postage paid, in a strong box made of corrugated

cardboard with plenty of packing material.

DO NOT send the modem back in the original box. Send ONLY the modem (NOT the power supply, manuals, CD-ROM, etc.). Include your SRO number, name, and address on the shipping label as well as inside the package. If possible, send the package via a courier capable of tracking the progress of the shipment. Ship to the following address:

**3Com
Attn: RMA
SRO#
6201 W. Oakton, East Dock
Morton Grove, IL 60053**

RapidComm Troubleshooting Tips

PROBLEM: The lights in the RapidComm Voice software's modem light monitor do not correspond to the actual lights on an external modem.

DIAGNOSIS: Under certain circumstances, the modem light monitor does not correctly report the activity of the modem. We are aware of this problem and are working to rectify the situation in upcoming versions of the software.

PROBLEM: The station ID works intermittently.

DIAGNOSIS: Under certain circumstances (including receiving a fax), the station ID may not work properly.

PROBLEM: RapidComm Voice does not work properly at 115.2 kbps.

DIAGNOSIS: The presence of disk compression software on your system hampers the RapidComm Voice software's ability to work properly at 115.2 kbps. Removal of the disk compression software from your system will allow RapidComm Voice to operate properly at 115.2 kbps.

A Note to User's with Older Versions of RapidComm Voice on Their Systems

You must uninstall older versions of RapidComm Voice from your system before installing the most recent version (contained on the CD-ROM that came with your new modem). Otherwise you may introduce conflicts in your system that will hamper the RapidComm Voice software's ability to work properly.

GLOSSARY

Cross references are printed **boldface**. Cross references with items in the Command Summary, found in the Technical Quick Reference (Section D), are printed in italics.

analog loopback

A modem self-test in which data from the keyboard or an internal test pattern is sent to the modem's transmitter, turned into analog form, looped back to the receiver, and converted back into digital form.

analog signals

A variety of signals and wavelengths that can be transmitted over communications lines such as the sound of a voice over the phone line.

answer mode

The mode used by your modem when answering an incoming call from an originating modem. The transmit/receive frequencies are the reverse of the originating modem, which is **originate mode**

application

A computer program designed to perform a specific task or set of tasks. Examples include word processing and spreadsheet applications.

ARQ

Automatic Repeat ~~Request~~. A function that allows your modem to detect flawed data and request that it be retransmitted. See **MNP** and **V.42**

ASCII

American Standard Code for Information Interchange. A code used to represent letters, numbers, and special **characters** such as \$, !, and /.

asynchronous transmission

Data transmission in which the length of time between transmitted **characters** may vary. Because characters may not be transmitted at set intervals, **start/stop** bits are used to mark the beginning and end of each character.

GLOSSARY

auto answer

Sets the modem to pick up the phone line when it detects a certain number of rings. See S-register S0 in the “Technical Quick Reference.”

auto dial

A process where your modem dials a call for you. The dialing process is initiated by sending an ATDT (dial tone) or ATDP (dial pulse) command followed by the telephone number. Auto dial is used to dial voice numbers. See command Dn.

baud rate

A term used to measure the speed of an analog transmission from one point to another. Although not technically accurate, baud rate is commonly used to mean **bit rate**.

binary digit

A 0 or 1, reflecting the use of the binary numbering system. Used because the computer recognizes either of two states, OFF or ON. Shortened form of binary digit is bit.

bit rate

Also referred to as transmission rate. The number of **binary digits** or bits, transmitted per second (**bps**). Communications channels using analog modems are established at set bit rates, commonly 2400, 4800, 9600, 14,400, 28,800 and higher.

bits per second (bps)

The bits **binary digits** per second rate. Thousands of bits per second are expressed as kilobits per second (kbps).

buffer

A temporary memory area used as storage during input and output operations. An example is the modem's command buffer.

byte

A group of **binary digits** stored and operated upon as a unit. Most often the term refers to 8-bit units or **characters** One kilobyte (KB) is equal to 1,024 bytes or characters; 640 KB is equal to 655,360 bytes or characters.

GLOSSARY

carrier

The basic signal altered or modulated by the modem in order to carry information.

character

A representation, coded **binary digits** of a letter, number, or other symbol.

characters per second (CPS)

A data transfer rate generally estimated from **bit rate** and the **character length**. For example, at 2400 bps, 8-bit characters with **start/stop bits** (for a total of ten bits per character) will be transmitted at a rate of approximately 240 characters per second (s). Some **protocols** such as error-control protocols, employ advanced techniques such as longer transmission **frames** and **data compression** to increase cps.

class 1 and 2.0

International standards used by **application** programs and fax modems for sending and receiving faxes.

cyclic redundancy checking (CRC)

An error-detection technique consisting of a test performed on each block **frame** of data by both sending and receiving modems. The sending modem inserts the results of its tests in each data block in the form of a CRC code. The receiving modem compares its results with the received CRC code and responds with either a positive or negative acknowledgment.

data communications

The transmission or sharing of data between computers via an electronic medium.

data compression table

A table containing values assigned for **character** during a call under **MINP5** data compression. **Default** values in the table are continually altered and built during each call: The longer the table, the more efficient **throughput** gained.

GLOSSARY

data mode

Mode used by a modem when sending and receiving data files.

DCE

Data Communications(or Circuit-Terminating)

Equipment, such as dial-up modems that establish and control the data link via the telephone network.

default

Any setting assumed, at startup or reset, by the computer's software and attached devices. The computer or software will use these settings until changed by the user or other software.

detect phase

In the **ITU-T V.42 error-control protocol**, the first stage in establishing if both modems attempting to connect have **V.42** capability.

dictionary

The term used for compression codes built by the **V.42bis** data compression algorithm.

digital loopback

A test that checks the modem's RS-232 interface and the cable that connects the terminal or computer and the modem. The modem receives data (in the form of **digital signals**) from the computer or terminal, and immediately returns the data to the screen for verification.

digital signals

Discrete, uniform signals. In this manual, the term refers to the **binary digits** 0 and 1.

DTE

Data Terminal (or Terminating) Equipment. A computer that generates or is the final destination of data.

duplex

Indicates a communications channel capable of carrying signals in both directions. **Half duplex, full duplex.**

GLOSSARY

Electronic Industries Association (EIA)

Group which defines electronic standards in the U.S.

error control

Various techniques that check the reliability of **characters** (**parity**) or blocks of data **V.42** and **MNP** error-control **protocols** use error detection (**CRC**) and retransmission of flawed **frames** (**ARQ**).

facsimile

A method for transmitting the image on a page from one point to another. Commonly referred to as fax.

fax mode

The mode used by a modem to send and receive data in **facsimile** format. See definitions for **V.17**, **V.27ter**, **V.29**

flow control

A mechanism that compensates for differences in the flow of data into and out of a modem or other device. See commands **&In**, **&In**, **&Rn**.

frame

A **data communication** term for a block of data with header and trailer information attached. The added information usually includes a frame number, block size data, error-check codes, and Start/End indicators.

full duplex

Signals can flow in both directions at the same time over one line. In microcomputer communications, may refer to the suppression of the on-line **local echo**.

half duplex

Signals can flow in both directions, but only one way at a time. In microcomputer communications, may refer to activation of the on-line **local echo**, which causes the modem to send a copy of the transmitted data to the screen of the sending computer.

GLOSSARY

Hz

Hertz, a frequency measurement unit used internationally to indicate cycles per second.

ITU-T

An international organization that defines standards for telegraphic and telephone equipment. For example, the Bell 212A standard for 1200-bps communication in North America is observed internationally. **ITU-T V.22** For 2400-bps communication, most U.S. manufacturers observe V.22bis.

LAPM

Link Access Procedure for Modems. An error-control **protocol** defined in **ITU-T Recommendation V.42**. Like the **MNP** protocols, LAPM uses **cyclic redundancy checking (CRC)** and retransmission of corrupted data (**ARQ**) to ensure data reliability.

local echo

A modem feature that enables the modem to display keyboard commands and transmitted data on the screen. See command En.

MNP

Microcom Networking Protocol, an error-control **protocol** developed by Microcom, Inc., and now in the public domain. There are several different MNP protocols, but the most commonly used one ensures error-free transmission through error detection (**CRC**) and retransmission of flawed **frames**.

modem

A device that transmits/receives computer data through a communications channel such as radio or telephone lines. It also changes signals received from the phone line back to **digital signals** before passing them to the receiving computer.

nonvolatile memory (NVRAM)

User-programmable random access memory whose data is retained when power is turned off. On **Smartster** modem, it includes four stored phone numbers and the modem settings.

off/on hook

Modem operations that are the equivalent of manually lifting a phone receiver (taking it off-hook) and replacing it (going on-hook).

GLOSSARY

online fall back/fall forward

A feature that allows high-speed, error-control modems to monitor line quality and fall back to the next lower speed in a defined range if line quality diminishes. As line conditions improve, the modems switch up to the next higher speed.

originate mode

The mode used by your modem when initiating an outgoing call to a destination modem. The transmit/receive frequencies are the reverse of the called modem, which is in **answer mode**.

parity

A simple error-detection method that checks the validity of a transmitted **character**. Character checking has been surpassed by more reliable and efficient forms of error checking, including **V.42** and **MNP 2-4 protocols**. Either the same type of **parity** must be used by two communicating computers, or both may omit parity.

protocol

A system of rules and procedures governing communications between two or more devices. Protocols vary, but communicating devices must follow the same protocol in order to exchange data. The format of the data, readiness to receive or send, error detection and error correction are some of the operations that may be defined in protocols.

RAM

Random Access Memory. Memory that is available for use when the modem is turned on, but that clears of all information when the power is turned off. The modem's RAM holds the current operational settings, **flow control buffer**, and a **command buffer**.

remote digital loopback

A test that checks the phone link and a remote modem's transmitter and receiver.

remote echo

A copy of the data received by the remote system, returned to the sending system, and displayed on the screen. Remote echoing is a function of the remote system.

GLOSSARY

ROM

Read Only Memory. Permanent memory, not user-programmable.

serial transmission

The consecutive flow of data in a single channel. Compare to parallel transmissions where data flows simultaneously in multiple channels.

start/stop bits

The signaling bits attached to a character before and after the character is transmitted during asynchronous transmission.

terminal

A device whose keyboard and display are used for sending and receiving data over a communications link. Differs from a microcomputer or a mainframe in that it has little or no internal processing capabilities.

terminal mode

Software mode that allows direct communication with the modem. Also known as command mode.

throughput

The amount of actual user data transmitted per second without the overhead of protocol information such as start/stop bits or frame headers and trailers. Compare with characters per second.

V.8

The ITU-T standard specification that covers the initial handshaking process.

V.17 fax

An ITU-T standard for making facsimile connections at 14,400 bps, 12,000 bps, 9,600 bps, and 7,200 bps.

V.21

An ITU-T standard for modems operating in asynchronous mode at speeds up to 300 bps, full-duplex, on public switched telephone networks.

V.22

An ITU-T standard for modem communications at 1200 bps, compatible with the Bell 212A standard observed in the U.S. and Canada.

GLOSSARY

V.22 bis

An **ITU-T** standard for modem communications at 2400 bps. The standard includes an automatic link negotiation fallback to 1200bps and compatibility with Bell 212A/V.22 modems.

V.27 ter

An **ITU-T** standard for **facsimile** operations that specifies modulation at 4800bps, with fallback to 2400bps.

V.29

An **ITU-T** standard for **facsimile** operations that specifies modulation at 9600bps, with fallback to 7200bps.

V.32

An **ITU-T** standard for modem communications at 9600 bps and 4800bps. V.32 modems fall back to 4800bps when line quality is impaired.

V.32 bis

An **ITU-T** standard that extends the V.32 connection range: 4800, 7200, 9600, 12,000, and 14,400bps. V.32bis modems fall back to the next lower speed when line quality is impaired, fall back further as necessary, and also

fall forward (switch back up) when line conditions improve (see **online fall back/fall forward**).

V.34

An **ITU-T** standard that currently allows data rates as high as 28,800bps.

V.34+

An enhancement to **V.34** that enables data transfer rates as high as 33,600bps.

V.42

An **ITU-T** standard for modem communications that defines a two-stage process of detection and negotiation for **LAPM error control**

V.42 bis

An extension of **ITU-T V.42** that defines a specific data compression scheme for use during V.42 connections.

GLOSSARY

Xmodem

The first of a family of **error control software protocols** used to transfer files between modems. These protocols are in the public domain and are available from many bulletin board services.

XON/XOFF

Standard **ASCII control characters** used to tell an intelligent device to stop/resume transmitting data.

Ymodem

An error-checking **protocol** that can send several files of data at a time in **1024-byte (1K) blocks**. This protocol can use either checksums or CRC for error checking.

Ymodem G

Similar to **Ymodem**, except it includes no error checking, which makes it faster.

Zmodem

Similar to **Xmodem** and **Ymodem**, except it includes batch transfer, the ability to recover from a partially complete transfer, a **mutostart** feature, and improved efficiency.

TECHNICAL QUICK REFERENCE

This section includes information about:

- AT Command Summary
- S-Registers

AT Command Summary

- Type commands in either upper or lower case, not a combination. Use the Backspace key to delete errors. (You cannot delete the original AT command since it is stored in the modem buffer.)
- If a command has numeric options and you don't include a number, zero is assumed. For example, if you type **ATB**, the command **ATB0** is assumed.
- Every command except A/, A>, and +++ must begin with the AT prefix and be entered by pressing **ENTER**.
- The maximum command length is 58 characters. The modem doesn't count the AT prefix, carriage returns, or spaces.



NOTE: All defaults are based on the &F1—Hardware Flow Control template loaded in NVRAM when the modem is shipped. Defaults are listed in italics.

TECHNICAL QUICK REFERENCE

Command Set

\$ Use in conjunction with D, S, or & commands (or just AT) to display a basic command list; online help.

A Manual Answer: goes off hook in answer mode. Pressing any key aborts the operations.

A/ Re-executes the last issued command. Used mainly to redial. This does not require the AT prefix or a Carriage Return.

A> Re-executes the last-issued command continually.

Any key Aborts off-hook dial/answer operation and hangs up.

AT Required command prefix, except with A/ and +++. Use alone to test for OK result code.

Bn **U.S./ITU-T answer sequence.**

B0 ITU-T answer sequence

B1 U.S. answer tone

Dn **Dials the specified phone number. Includes the following:**

L Dials the last dialed number.

P Pulse (rotary) dial

R Originates call using answer (reverse) frequencies.

TECHNICAL QUICK REFERENCE

Sn	Dials the phone number string stored in NVRAM at position n (n = 0–3). Phone numbers are stored with the &Zn=s command.	!	(Exclamation point) Flashes the switch hook.
T	Tone dial	/	Delays for 125 ms. before proceeding with dial string.
,	(Comma) Pause, See S8 definition; which it's linked to.	W	Wait for second dial tone (X2 or X4); linked to S6 register.
;	(Semicolon) Return to Command mode after dialing.	@	Dials, waits for quiet answer, and continues (X3 or higher).
“	Dials the letters that follow (in an alphabetical phone number).	\$	Displays a list of Dial commands.
	En		Sets local echo.
		E0	Echo OFF
		E1	Modem displays keyboard commands

TECHNICAL QUICK REFERENCE

Fn Sets online local echo of transmitted data ON/OFF.

- F0 Local echo ON.
Modem sends a copy of data it sends to the remote system to your screen.
- F1 Local echo OFF.
Receiving system may send a remote echo of data it receives.

Hn Controls ON/OFF hook.

- H0 Hangs up (goes on hook).
- H1 Goes off hook.

In Displays the following information.

- I0 Four-digit product code
- I1 Results of ROM checksum
- I2 Results of RAM checksum
- I3 Product type
- I4 Current modem settings
- I5 Nonvolatile memory (NVRAM) settings
- I6 Link diagnostics
- I7 Product configuration

Ln Controls speaker volume (internals only).

- L0 Low volume
- L1 Low volume
- L2 Medium volume
- L3 High volume

TECHNICAL QUICK REFERENCE

Mn	Operates speaker.	Q1	Quiet mode; no result codes.
	M0 Speaker always OFF.	Q2	Displays result codes only in Originate mode.
	M1 Speaker ON until CONNECT.		
	M2 Speaker always ON.	Sr.b=n	Sets bit .b of register r to n (0/OFF or 1/ON).
	M3 Speaker ON after dial, until CONNECT.	Sr=n	Sets register r to n.
On	Returns online.	Sr?	Displays contents of S-Register r.
	O0 Returns online.	S\$	Displays a list of the S-Registers.
	O1 Returns online and retrains.	T	Sets tone dial.
P	Sets pulse dial (for phone lines that don't support touch-tone dialing).	Vn	Displays verbal/numeric result codes.
Qn	Displays/suppresses result codes.	V0	Numeric codes
	Q0 Displays result codes.	V1	Verbal codes

TECHNICAL QUICK REFERENCE

Xn Sets result code displayed. Default is X4.

Result Codes	Xn Setting				
	X0	X1	X2	X3	X4
0/OK	•	•	•	•	•
1/CONNECT	•	•	•	•	•
2/RING	•	•	•	•	•
3/NO CARRIER	•	•	•	•	•
4/ERROR	•	•	•	•	•
5/CONNECT 1200		•	•	•	•
6/NO DIAL TONE			•		•
7/BUSY				•	•
8/NO ANSWER*				•	•
9/RESERVED					
10/CONNECT 2400		•	•	•	•
11/RINGING					•
13/CONNECT 9600		•	•	•	•
18/CONNECT 4800		•	•	•	•
20/CONNECT 7200		•	•	•	•
21/CONNECT 12000		•	•	•	•
25/CONNECT 14400		•	•	•	•
43/CONNECT 16800		•	•	•	•
85/CONNECT 19200		•	•	•	•
91/CONNECT 21600		•	•	•	•
99/CONNECT 24000		•	•	•	•
103/CONNECT 26400		•	•	•	•
107/CONNECT 28800		•	•	•	•
151/CONNECT 31200		•	•	•	•
155/CONNECT 33600	•	•	•	•	•

TECHNICAL QUICK REFERENCE

Xn (continued)

<u>Xn</u>	<u>Result Codes (cont.)</u>	<u>X0</u>	<u>X1</u>	<u>X2</u>	<u>X3</u>	<u>X4</u>
	Adaptive Dialing			•	•	•
	Wait for 2nd Dial Tone (W)			•		•
	Wait for Answer (@)				•	•
	Fast Dial			•		•
	*Requires @ in dial string; replaces NO CARRIER					

TECHNICAL QUICK REFERENCE

Y_n	Selects power-on/reset default configuration.		
Y0	Default is profile 0 setting in NVRAM	Z4	Resets modem to factory default profile 1 (&F1)
Y1	Default is profile 1 setting in NVRAM	Z5	Resets modem to factory default profile 2 (&F2)
Z	Resets modem.	&\$	Displays a list of ampersand (&) commands.
Z0	Resets modem to NVRAM profile selected by Y command or dip 7.	&A	Enables/disables additional result code subsets (see X_n).
Z1	Resets modem to NVRAM profile 0	&A0	ARQ result codes disabled
Z2	Resets modem to NVRAM profile 1	&A1	ARQ result codes enabled
Z3	Resets modem to factory default profile 0 (&F0)	&A2	V.32 modulation indicator added

TECHNICAL QUICK REFERENCE

&A3 Protocol indicators added—
LAPM/MNP/NONE (error control) and V42bis/MNP5 (data compression)

&Bn **Manages modem's serial port rate.**

&B0 Variable, follows connection rate
&B1 Fixed serial port rate
&B2 Fixed in ARQ mode, variable in non-ARQ mode

&Cn **Controls Carrier Detect (CD) signal.**

&C0 CD override
&C1 Normal CD operations

&Dn **Controls Data Terminal Ready (DTR) operations.**

&D0 DTR override
&D1 DTR toggle causes online Command mode
&D2 Normal DTR operations
&D3 Resets on receipt of DTR

&Fn **Loads a read-only (non-programmable) factory configuration.**

&F0 Generic template
&F1 Hardware flow control template
&F2 Software flow control template

TECHNICAL QUICK REFERENCE

&Gn Sets Guard Tone.

&G0 No guard tone, U.S. and Canada

&G1 550 Hz guard tone, some European countries, requires B0 setting.

&G2 1800 Hz guard tone, U.K., requires B0 setting.

&Hn Sets Transmit Data (TD) flow control (see also &Rn).

&H0 Flow control disabled

&H1 Hardware flow control, Clear to Send (CTS)

&H2 Software flow control, XON/XOFF

&H3 Hardware and software flow control

&In Sets Receive Data (RD) software flow control (see also &Rn).

&I0 Software flow control disabled

&I1 XON/XOFF signals to your modem and remote system

&I2 XON/XOFF signals to your modem only

&Kn Enables/disables data compression.

&K0 Data compression disabled

&K1 Auto enable/disable

&K2 Data compression enabled

TECHNICAL QUICK REFERENCE

&K3	MNP5 compression disabled	&N0	Variable rate
&Mn	Sets Error Control (ARQ) for connections at 1200 bps and higher.	&N1	300 bps
&M0	Normal mode, error control disabled	&N2	1200 bps
&M1	Reserved	&N3	2400 bps
&M2	Reserved	&N4	4800 bps
&M3	Reserved	&N5	7200 bps
&M4	Normal/ARQ	&N6	9600 bps
&M5	ARQ mode	&N7	12,000 bps
&Nn	Sets connect speed. If connection cannot be established at this speed, the modem will hang up. Sets ceiling connect speed if &Un is greater than 0. See &Un.	&N8	14,400 bps
		&N9	16,800 bps
		&N10	19,200 bps
		&N11	21,600 bps
		&N12	24,000 bps
		&N13	26,400 bps
		&N14	28,800 bps
		&N15	31,200 bps
		&N16	33,600 bps

TECHNICAL QUICK REFERENCE

&Pn Sets pulse (rotary) dial make/break ratio.

&P0 U.S./Canada ratio,
39%/61%

&P1 U.K. ratio, 33%/67%

&Rn Sets Receive Data (RD) hardware flow control, Request to Send (RTS) (see also &Hn).

&R0 Reserved

&R1 Modem ignores RTS

&R2 Received Data to
computer only on RTS

&Sn Controls Data Set Ready (DSR) operations.

&S0 DSR override; always
ON

&S1 Modem controls DSR

&Tn Begins test modes (used in conjunction with s register 18).

&T0 Ends testing

&T1 Analog Loopback

&T2 Reserved

&T3 Local Digital
Loopback

&T4 Enables Remote
Digital Loopback

&T5 Prohibits Remote
Digital Loopback

&T6 Initiates Remote Digital
Loopback

&T7 Remote Digital with
self-test and error
detector

TECHNICAL QUICK REFERENCE

&T8 Analog Loopback with self-test and error detector

&Un Sets floor connect speed when &Un is set greater than 0. &Nn is the ceiling connect speed. See &Nn.

&U0 Disabled

&U1 300 bps

&U2 1200 bps

&U3 2400 bps

&U4 4800 bps

&U5 7200 bps

&U6 9600 bps

&U7 12,000 bps

&U8 14,400 bps

&U9 16,800 bps

&U10 19,200 bps

&U11 21,600 bps

&U12 24,000 bps

&U13 26,400 bps

&U14 28,800 bps

&U15 31,200 bps

&U16 33,600 bps

&Wn Writes current configuration to NVRAM templates.

&W0 Modifies the NVRAM 0 template (Y0)

&W1 Modifies the NVRAM 1 template (Y1)

&Yn Sets break handling.

&Y0 Destructive, but doesn't send break

&Y1 Destructive, expedited

&Y2 Nondestructive, expedited

TECHNICAL QUICK REFERENCE

&Y3 Nondestructive,
unexpedited

&Zn=s Writes phone number string
s to NVRAM at position n
(n = 0–3).

&Zn=L Writes last executed dial
string to NVRAM at
position n (n = 0–3).

&Zn? Displays the phone number
stored at position n (n = 0–
3).

&ZL? Displays the last executed
dial string.

**#CID=n Controls Caller ID
feature.**

#CID=0 Caller ID disabled.

#CID=1 Caller ID enabled.

#CID=2 Caller ID enabled with
extended information,
including caller's name.

+++ Escapes to online-command
mode.

S Registers

To change a setting, use the `ATSr=n` command, where `r` is the register and `n` is a decimal value from 0 – 255 (unless otherwise indicated).

Register	Default	Function
S0	0	Sets the number of rings on which to answer in Auto Answer Mode. When set to 0, Auto Answer is disabled.
S1	0	Counts and stores the number of rings from an incoming call. (S0 must be greater than 0.)
S2	43	Stores the ASCII decimal code for the escape code character. Default character is +. A value of 128 – 255 disables the escape code.
S3	13	Stores the ASCII code for the Carriage Return character. Valid range is 0 – 127.
S4	10	Stores the ASCII decimal code for the Line Feed character. Valid range is 0 – 127.
S5	8	Stores the ASCII decimal code for the Backspace character. A value of 128 – 255 disables the Backspace key's delete function.

TECHNICAL QUICK REFERENCE

Register	Default	Function
S6	2	Sets the number of seconds the modem waits before dialing. If Xn is set to X2 or X4, this is the time-out length if there isn't a dial tone.
S7	60	Sets the number of seconds the modem waits for a carrier. May be set for much longer duration if, for example, the modem is originating an international connection.
S8	2	Sets the duration, in seconds, for the pause (,) option in the Dial command.
S9	6	Sets the required duration, in tenths of a second, of the remote modem's carrier signal before recognition by the Sportster modem.
S10	7	Sets the duration, in tenths of a second, that the modem waits to hang up after loss of carrier. This guard time allows the modem to distinguish between a line disturbance from a true disconnect (hang up) by the remote modem.

While we don't recommend connecting the modem to a line with call waiting, if you have it, you may wish to adjust this setting upward to prevent the modem from misinterpreting the second call signal as a disconnect by the remote modem.

TECHNICAL QUICK REFERENCE

Register	Default	Function															
S10 (cont.)		<p>A better alternative is to ask your phone company how to temporarily disable call waiting (usually *70W). For example: ATDT *70W phone number.</p> <p>Note: If you set S10 = 255, the modem will not hang up when carrier is lost. Dropping DTR hangs up the modem.</p>															
S11	70	Sets the duration and spacing, in milliseconds, for tone dialing.															
S12	50	Sets the duration, in fiftieths of a second, of the guard time for the escape code sequence (+++).															
S13	0	<p>Bit-mapped register. Select the bit(s) you want on and set S13 to the total of the values in the Value column. For example, ATS13 = 17 enables bit 0 (value is 1) and bit 4 (value is 16).</p> <table border="1" style="margin-left: 20px;"> <thead> <tr> <th>Bit</th> <th>Value</th> <th>Result</th> </tr> </thead> <tbody> <tr> <td>0</td> <td>1</td> <td>Reset when DTR drops.</td> </tr> <tr> <td>1</td> <td>2</td> <td>Reset non-MNP transmit buffer from 1.5K to 128 bytes.*</td> </tr> <tr> <td>2</td> <td>4</td> <td>Set backspace key to delete.</td> </tr> <tr> <td>3</td> <td>8</td> <td>On DTR signal, auto dial the number stored in NVRAM at position 0.</td> </tr> </tbody> </table>	Bit	Value	Result	0	1	Reset when DTR drops.	1	2	Reset non-MNP transmit buffer from 1.5K to 128 bytes.*	2	4	Set backspace key to delete.	3	8	On DTR signal, auto dial the number stored in NVRAM at position 0.
Bit	Value	Result															
0	1	Reset when DTR drops.															
1	2	Reset non-MNP transmit buffer from 1.5K to 128 bytes.*															
2	4	Set backspace key to delete.															
3	8	On DTR signal, auto dial the number stored in NVRAM at position 0.															

TECHNICAL QUICK REFERENCE

Register	Default	Function	
S13 (cont.)		Bit	Value Result
		4	16 At power on/reset, Auto Dial the number stored in NVRAM at position 0.
		5	32 Reserved
		6	64 Disable quick retrains.
		7	128 Disconnect on escape code.

* The 1.5K-byte non-ARQ buffer allows data transfer with modem- and modem-type file transfer protocols without using flow control.

The 128-byte option lets remote users with slower modems keep data you're sending from scrolling off their screens. When remote users send your computer an XOFF (Ctrl-S) and you stop transmitting, the data in transit from your modem's buffer doesn't exceed the size of their screen.

This is also very helpful in situations when a remote modem/printer application is losing characters.

S15 0 Bit-mapped register setup. To set the register, see instructions for S13.

Bit	Value	Result
0	1	Disable ARQ/MNP for V.22.
1	2	Disable ARQ/MNP for V.22bis.
2	4	Disable ARQ/MNP V.32/V.32bis/V.32terbo.
3	8	Disable MNP handshake.
4	16	Disable MNP level 4.
5	32	Disable MNP level 3.

TECHNICAL QUICK REFERENCE

Register	Default	Function															
S15 (cont.)		<table border="1" style="width: 100%; border-collapse: collapse;"> <thead> <tr> <th style="text-align: left;">Bit</th> <th style="text-align: left;">Value</th> <th style="text-align: left;">Result</th> </tr> </thead> <tbody> <tr> <td>6</td> <td>64</td> <td>MNP incompatibility.</td> </tr> <tr> <td>7</td> <td>128</td> <td>Disable V.42 operation.</td> </tr> </tbody> </table> <p>To disable V.42 detect phase, select the total of the values for bits 3 and 7.</p>	Bit	Value	Result	6	64	MNP incompatibility.	7	128	Disable V.42 operation.						
Bit	Value	Result															
6	64	MNP incompatibility.															
7	128	Disable V.42 operation.															
S16	0	<p>Bit-mapped register setup. To set the register, see instructions for S13.</p> <table border="1" style="width: 100%; border-collapse: collapse;"> <thead> <tr> <th style="text-align: left;">Bit</th> <th style="text-align: left;">Value</th> <th style="text-align: left;">Result</th> </tr> </thead> <tbody> <tr> <td>0</td> <td>1</td> <td>Reserved</td> </tr> <tr> <td>1</td> <td>2</td> <td>Reserved</td> </tr> <tr> <td>2</td> <td>4</td> <td>Touch tone test.</td> </tr> <tr> <td>4</td> <td>8</td> <td>Use internal test pattern.</td> </tr> </tbody> </table>	Bit	Value	Result	0	1	Reserved	1	2	Reserved	2	4	Touch tone test.	4	8	Use internal test pattern.
Bit	Value	Result															
0	1	Reserved															
1	2	Reserved															
2	4	Touch tone test.															
4	8	Use internal test pattern.															
S18	0	Test timer for &T loopback testing. Sets the time in seconds of testing before the modem automatically times out and terminates the test. When set to 0, the timer is disabled. Valid range is 1-255.															
S19	0	Sets the duration, in minutes, for the inactivity timer. The timer activates when there is no data activity on the phone line; at time-out the modem hangs up. S19=0 disables the timer.															
S21	10	Sets the length, in 10-millisecond units, of breaks sent from the modem to the computer; applies to MNP or V.42 mode only.															

TECHNICAL QUICK REFERENCE

Register	Default	Function																								
S22	17	Stores the ASCII decimal code for the XON character.																								
S23	19	Stores the ASCII decimal code for the XOFF character.																								
S25	20	Sets the duration, in hundredths of a second, that DTR must be dropped so that the modem doesn't interpret a random glitch as a DTR loss. (Most users will want to use the default; this register is useful for setting compatibility with older systems running under older operating software.)																								
S27	0	Bit-mapped register setup. To set the register, see instructions for S13.																								
		<table border="1" style="width: 100%; border-collapse: collapse;"> <thead> <tr> <th style="text-align: left;">Bit</th> <th style="text-align: left;">Value</th> <th style="text-align: left;">Result</th> </tr> </thead> <tbody> <tr> <td>0</td> <td>1</td> <td>Enables ITU-T V.21 modulation at 300bps for overseas calls; in V.21 mode, the modem answers both overseas and domestic (U.S. and Canada) calls, but only originates V.21 calls. (Default Bell 103)</td> </tr> <tr> <td>1</td> <td>2</td> <td>Enables unencoded (non-trellis coded) modulation in V.32 mode.</td> </tr> <tr> <td>2</td> <td>4</td> <td>Disables V.32 modulation.</td> </tr> <tr> <td>3</td> <td>8</td> <td>Disables 2100 Hz answer tone to allow two V.42 modems to connect faster.</td> </tr> <tr> <td>4</td> <td>16</td> <td>Enables V.23 fallback mode.</td> </tr> <tr> <td>5</td> <td>32</td> <td>Disables V.32bis mode.</td> </tr> <tr> <td>6</td> <td>64</td> <td>Disables V.42 selective reject.</td> </tr> </tbody> </table>	Bit	Value	Result	0	1	Enables ITU-T V.21 modulation at 300bps for overseas calls; in V.21 mode, the modem answers both overseas and domestic (U.S. and Canada) calls, but only originates V.21 calls. (Default Bell 103)	1	2	Enables unencoded (non-trellis coded) modulation in V.32 mode.	2	4	Disables V.32 modulation.	3	8	Disables 2100 Hz answer tone to allow two V.42 modems to connect faster.	4	16	Enables V.23 fallback mode.	5	32	Disables V.32bis mode.	6	64	Disables V.42 selective reject.
Bit	Value	Result																								
0	1	Enables ITU-T V.21 modulation at 300bps for overseas calls; in V.21 mode, the modem answers both overseas and domestic (U.S. and Canada) calls, but only originates V.21 calls. (Default Bell 103)																								
1	2	Enables unencoded (non-trellis coded) modulation in V.32 mode.																								
2	4	Disables V.32 modulation.																								
3	8	Disables 2100 Hz answer tone to allow two V.42 modems to connect faster.																								
4	16	Enables V.23 fallback mode.																								
5	32	Disables V.32bis mode.																								
6	64	Disables V.42 selective reject.																								

TECHNICAL QUICK REFERENCE

Register	Default	Function									
S27 (cont.)		<table border="1" style="width: 100%; border-collapse: collapse;"> <thead> <tr> <th style="text-align: left;">Bit</th> <th style="text-align: left;">Value</th> <th style="text-align: left;">Result</th> </tr> </thead> <tbody> <tr> <td>7</td> <td>128</td> <td>Software compatibility mode. This setting disables the codes and displays the 9600 code instead. The actual rate of the call can be viewed on the ATI6 screen. Used for unusual software incompatibilities. Some software may not accept 7200, 12,000, and 14,400 bps or greater result codes.</td> </tr> </tbody> </table>	Bit	Value	Result	7	128	Software compatibility mode. This setting disables the codes and displays the 9600 code instead. The actual rate of the call can be viewed on the ATI6 screen. Used for unusual software incompatibilities. Some software may not accept 7200, 12,000, and 14,400 bps or greater result codes.			
Bit	Value	Result									
7	128	Software compatibility mode. This setting disables the codes and displays the 9600 code instead. The actual rate of the call can be viewed on the ATI6 screen. Used for unusual software incompatibilities. Some software may not accept 7200, 12,000, and 14,400 bps or greater result codes.									
S28	0	Eliminates the V.32 answer tones for a faster connection.									
	8	Default item, all times are in tenths of seconds.									
	255	Disables all connections except V.32 at 9600 bps.									
S29	20	Sets the duration, in tenths of a second, of the V.21 answer mode fallback timer.									
S30	-	Reserved									
S31	-	Reserved									
S32	2	Bit-mapped register setup. To set the register, see the instructions for S13.									
		<table border="1" style="width: 100%; border-collapse: collapse;"> <thead> <tr> <th style="text-align: left;">Bit</th> <th style="text-align: left;">Value</th> <th style="text-align: left;">Result</th> </tr> </thead> <tbody> <tr> <td>0</td> <td>1</td> <td>V.8 Call Indicate enabled.</td> </tr> <tr> <td>1</td> <td>2</td> <td>Enables V.8 mode.</td> </tr> </tbody> </table>	Bit	Value	Result	0	1	V.8 Call Indicate enabled.	1	2	Enables V.8 mode.
Bit	Value	Result									
0	1	V.8 Call Indicate enabled.									
1	2	Enables V.8 mode.									

TECHNICAL QUICK REFERENCE

Register	Default	Function		
<hr/>				
S32 (cont.)		Bit	Value	Result
		2	4	Reserved.
		3	8	Disable V.34 modulation.
		4	16	Disable V.34+ modulation.
		5-7	32-128	Reserved.
S33	0	Bit-mapped register setup. To set the register, see the instructions for S13.		
		Bit	Value	Result
		0	1	Disable 2400 symbol rate.
		1	2	Disable 2743 symbol rate.
		2	4	Disable 2800 symbol rate.
		3	8	Disable 3000 symbol rate.
		4	16	Disable 3200 symbol rate.
		5	32	Disable 3429 symbol rate.
		6	64	Reserved
		7	128	Disable shaping.
S34	0	Bit-mapped register setup. To set registers, see instructions for S13.		
		Bit	Value	Result
		0	1	Disable 8S-2D trellis encoding.
		1	2	Disable 16S-4D trellis encoding.

TECHNICAL QUICK REFERENCE

Register	Default	Function		
S34 (cont.)		Bit	Value	Result
		2	4	Disable 32S-2D trellis encoding.
		3	8	Disable 64S-4D trellis encoding.
		4	16	Disable non-linear coding.
		5	32	Disable TX level deviation.
		6	64	Disable Pre-emphasis.
		7	128	Disable Pre-coding.
S35	0	Bit-mapped register setup. To set registers, see instructions for S13.		
		Bit	Value	Result
		0-2	1-7	Limit back channel rate.
				1 = 28800 max.
				2 = 26400 max.
				3 = 24000 max.
				4 = 21600 max.
				5 = 19200 max.
				6 = 16800 max.
				7 = 14400 max.
		3	8	Force RBS operation
		4-7	12-128	Reserved.

TECHNICAL QUICK REFERENCE

Register	Default	Function									
S38	0	Sets an optional delay, in seconds, before a forced hang-up and clearing of the Transmit buffer when DTR drops during an ARQ call. This allows time for a remote modem to acknowledge receipt of all transmitted data before it is disconnected. The modem immediately hangs up when DTR drops. This option only applies to connections terminated by dropping DTR. If the modem receives the ATH command, it ignores S38 and immediately hangs up.									
S39-S40	Reserved										
S41	0	Bit-mapped register setup. To set registers, see instructions for S13.									
		<table><thead><tr><th>Bit</th><th>Value</th><th>Result</th></tr></thead><tbody><tr><td>0</td><td>1</td><td>Distinctive ring enabled.</td></tr><tr><td>1-7</td><td>2-128</td><td>Reserved</td></tr></tbody></table>	Bit	Value	Result	0	1	Distinctive ring enabled.	1-7	2-128	Reserved
Bit	Value	Result									
0	1	Distinctive ring enabled.									
1-7	2-128	Reserved									

REGULATORY INFORMATION

Manufacturer's Declaration of Conformity

3Com
7770 North Frontage Road
Skokie, Illinois 60077-2690
U.S.A.

declares that the product U.S. Robotics Sportster Voice 33600 Internal Faxmodem conforms to the FCC's specifications:

Part 15, Class B:

Operation is subject to the following two conditions:

- (1) this device may not cause harmful electromagnetic interference, and
- (2) this device must accept any interference

received including interference that may cause undesired operations.

Part 68:

This equipment complies with FCC Rules Part 68. Located on the bottom of the modem is the FCC Registration Number and Ringer Equivalence Number (REN). You must provide this information to the telephone company when requested.

The REN is used to determine the number of devices you may legally connect to your telephone line. In most areas, the sum of the REN of all devices connected to one line must not exceed five (5.0). You should contact your telephone company to determine the maximum REN for your calling area.

REGULATORY INFORMATION

This equipment uses the following USOC jacks: RJ-11C.

This equipment may not be used on coin service provided by the telephone company. Connection to party lines is subject to state tariffs.

An FCC compliant telephone cord and modular plug are provided with this equipment, which is designed to connect to the telephone network or premises wiring using a Part 68 compliant compatible jack. See installation instructions for details.

Caution to the User

The user is cautioned that any changes or modifications not expressly approved by the party responsible for compliance could void the user's authority to operate the equipment.

IC (Canada)

This digital apparatus does not exceed the Class B limits for radio noise emissions from digital apparatus set out in the interference-causing equipment standard entitled Digital Apparatus, ICES-003 of Industry Canada. Cet appareil numérique respecte les limites de bruits radioélectriques applicables aux appareils numériques de Classe B prescrites dans la norme sur le matériel brouilleur: Appareils Numériques, NMB-003 édictée par l'Industrie Canada.

UL Listing/CUL Listing

This information technology equipment is UL-Listed and CUL-Listed for use with UL-Listed personal computers that have installation instructions detailing user installation of card cage accessories.

REGULATORY INFORMATION

Connecting to the Telephone Company

It is not necessary to notify the telephone company before installing the modem. However, the telephone company may request the telephone number(s) to which the Sportster modem is connected and the declaration of conformity to FCC Parts 15 and Part 68 on the first page of this section.

Be sure that the telephone line you are connecting the modem to is a standard analog line and not a digital (PBX), party, or coin telephone line.

If the modem is malfunctioning, it may affect the telephone lines. In this case, disconnect the modem until the source of the difficulty is traced.

Fax Branding

The Telephone Consumer Protection Act of 1991 makes it unlawful for any person to use a computer or other electronic device, including fax machines, to send any message unless such message clearly contains in a margin at the top or bottom of each transmitted page or on the first page of the transmission, the date and time it is sent, an identification of the business or other entity, or other individual sending the message, and the telephone number of the sending machine or of such business, other entity, or individual. (The telephone number provided may not be a 900 number or any other number for which charges exceed local or long-distance transmission charges.)

In order to program this information into your Sportster modem, refer to the RapidComm manual on the CD-ROM that shipped with

REGULATORY INFORMATION

your modem. If you're using a different communications software program, refer to its manual.

Radio and Television Interference

This equipment generates and uses radio frequency energy and if not installed and used properly, in strict accordance with the manufacturer's instructions, may cause interference to radio and television reception. This modem complies with FCC Part 15, Class B of the FCC rules for digital devices. These rules are designed to provide reasonable protection against radio frequency interference from a digital device in a residential installation.

However, there is no guarantee that interference will not occur in a particular installation. If this device does cause interference to radio or television reception,

which you can determine by monitoring reception when the modem is installed and when it is removed from the computer, try to correct the problem with one or more of the following measures:

- Reorient the receiving antenna (for televisions with antenna reception only) or cable input device.
- Relocate the computer with respect to the receiver.
- Relocate the computer and/or the receiver so that they are on separate branch circuits.

If necessary, consult your dealer or an experienced radio/television technician for additional suggestions. You may find the following booklet, prepared by the Federal Communications Commission, helpful:

REGULATORY INFORMATION

How to Identify and Resolve Radio-TV Interference Problems
Stock No. 004-000-0345-4
U.S. Government Printing Office
Washington, DC 20402

In accordance with Part 15 of the FCC rules, the user is cautioned that any changes or modifications to the equipment described in this manual that are not expressly approved by 3Com could void the user's authority to operate the equipment.

For Canadian Modem Users

NOTICE: The Industry Canada (IC) label identifies certified equipment. This certification means the equipment meets certain telecommunications network protective, operational, and safety

requirements as prescribed in the appropriate Terminal Equipment Technical Requirements document(s). The Department does not guarantee the equipment will operate to the user's satisfaction.

Before installing this equipment, users should ensure that it is permissible to be connected to the facilities of the local telecommunications company. The equipment must also be installed using an acceptable method of connection. In some cases, the company's inside wiring associated with a single-line, individual service may be extended by means of a certified connector assembly (telephone extension cord.) The customer should be aware that compliance with the above conditions may not prevent degradation of service in some situations. Currently, telecommunication companies do not allow users to connect their

REGULATORY INFORMATION

equipment to jacks except in precise situations that are spelled out in tariffing arrangements with those companies.

Repairs to certified equipment should be coordinated by a representative designated by the supplier. Any repairs or alterations made by the user to this equipment, or equipment malfunctions, may give the telecommunications company cause to request the user to disconnect the equipment.

For your own protection, make sure that the electrical ground connections of the power utility, telephone lines, and internal metallic water pipe system, if present, are connected together. This precaution may be particularly important in rural areas.

CAUTION: Do NOT attempt to make such connections yourself. Instead contact an

electric inspection authority or electrician, as appropriate.

NOTICE: The Ringer Equivalence Number (REN) assigned to each terminal device provides an indication of the maximum number of terminals allowed to be connected to a telephone interface. The termination on an interface may consist of any combination of devices subject only to the requirement that the sum of the Ringer Equivalence Numbers of all the devices does not exceed 5.

The Ringer Equivalence Number is located on the bottom of the modem's case (external modems) or on the modem's circuit board (internal modems).

WARRANTY AND REPAIR SERVICE CENTER:

REGULATORY INFORMATION

Keating Technologies **25 Royal Crest Court, Suite 200** **Markham, ONT L3R 9X4**

«**AVIS** : L'étiquette d'Industrie Canada identifie le matériel homologué. Cette étiquette certifie que le matériel est conforme aux normes de protection, d'exploitation et de sécurité des réseaux de télécommunications, comme le prescrivent les documents concernant les exigences techniques relatives au matériel terminal. Le Ministère n'assure toutefois pas que le matériel fonctionnera à la satisfaction de l'utilisateur.

Avant d'installer ce matériel, l'utilisateur doit s'assurer qu'il est permis de le raccorder aux installations de l'entreprise locale de télécommunication. Le matériel doit également être installé en suivant une méthode acceptée

de raccordement. L'abonné ne doit pas oublier qu'il est possible que la conformité aux conditions énoncées cidessus n'empêche pas la dégradation du service dans certaines situations.

Les réparations de matériel homologué doivent être coordonnées par un représentant désigné par le fournisseur. L'entreprise de télécommunications peut demander à l'utilisateur de débrancher un appareil à la suite de réparations ou de modifications effectuées par l'utilisateur ou à cause de mauvais fonctionnement.

Pour sa propre protection, l'utilisateur doit s'assurer que tous les fils de mise à la terre de la source d'énergie électrique, des lignes téléphoniques et des canalisations d'eau métalliques, s'il y en a, sont raccordés

REGULATORY INFORMATION

ensemble. Cette précaution est particulièrement importante dans les régions rurales.

Avertissement: L'utilisateur ne doit pas tenter de faire ces raccordements lui-même; il doit avoir recours à un service d'inspection des installations électriques, ou à un électricien, selon le cas.

«**AVIS : L'indice d'équivalence de la sonnerie** (IES) assigné à chaque dispositif terminal indique le nombre maximal de terminaux qui peuvent être raccordés à une interface. La terminaison d'une interface téléphonique peut consister en une combinaison de quelques dispositifs, à la seule condition que la somme d'indices d'équivalence de la sonnerie de tous les dispositifs n'excède pas 5.»

Centre de garantie et de service après-vente:

Keating Technologies
25 Royal Crest Court, Suite 200
Markham, ONT L3R 9X4

Limited Warranty

U.S. Robotics Access Corp., a subsidiary of 3Com Corporation, warrants to the original end-user purchaser that this product will be free from defects in materials and workmanship for a period of five years from the date of purchase. During the limited warranty period, and upon proof of purchase, the product will be repaired or replaced (with the same or a similar model, which may be a refurbished model) at U.S. Robotics' option, without charge for either parts or labor. This limited warranty shall not apply if the product is modified,

REGULATORY INFORMATION

tampered with, misused, or subjected to abnormal working conditions (including, but not limited to, lightning and water damage).

THIS LIMITED WARRANTY DOES NOT GUARANTEE YOU UNINTERRUPTED SERVICE. REPAIR OR REPLACEMENT AS PROVIDED UNDER THIS LIMITED WARRANTY IS THE EXCLUSIVE REMEDY OF THE PURCHASER. THIS LIMITED WARRANTY IS IN LIEU OF ALL OTHER WARRANTIES, EXPRESS OR IMPLIED, INCLUDING, BUT NOT LIMITED TO, ANY IMPLIED WARRANTY OF MERCHANTABILITY OR FITNESS FOR A PARTICULAR USE OR PURPOSE. U.S. ROBOTICS SHALL IN NO EVENT BE LIABLE FOR ANY

SPECIAL, INDIRECT, INCIDENTAL, PUNITIVE, OR CONSEQUENTIAL DAMAGES OF ANY KIND OR CHARACTER, INCLUDING, WITHOUT LIMITATION, LOSS OF REVENUE OR PROFITS, FAILURE TO REALIZE SAVINGS OR OTHER BENEFITS, LOSS OF DATA OR USE, DAMAGE TO EQUIPMENT, AND CLAIMS AGAINST THE PURCHASER BY ANY THIRD PERSON, EVEN IF U.S. ROBOTICS HAS BEEN ADVISED OF THE POSSIBILITY OF SUCH DAMAGES.

This limited warranty gives you specific legal rights. You may have others, which vary from state to state.

Some states do not allow limitations on duration of an implied warranty, or the

REGULATORY INFORMATION

exclusion or limitation of incidental or consequential damages, so the above exclusion or limitation may not apply to you.

To obtain service under this limited warranty, contact the 3Com Technical Support Department at 847-982-5151 or by mail at 3Com, 7770 N. Frontage Road, Attn.: Technical Support Dept., Skokie, Illinois 60077-2690. You will be given a Service Repair Order (“SRO”) number to help 3Com keep track of your limited warranty request. Once you have received your SRO number, take or send the product, postage prepaid and insured, to 3Com, Attn: RMA, [your SRO#], 6201 W. Oakton, East Dock, Morton Grove, IL 60053. Pack the modem in a strong corrugated cardboard box with plenty of packing material. DO NOT send the modem

back in its original box. DO NOT send anything but the modem (do not send back the power supply, CD-ROM, documentation, etc.). If possible, send the modem via a courier capable of tracking the progress of the shipment. Include proof of the date of purchase. IMPORTANT: If you send your unit, pack it securely, and be sure that your SRO number is visible on the outside of the package.

INDEX

A

America Online, U.S. Robotics online support and, 99
analog phone lines, vs. digital, 15, 24
AOL. See America Online, U.S. Robotics
online support and

B

BBS, 3Com, 96-98

C

characters per second (cps)
low, errors and, 93-94
COM ports
conflicts, 89-90
and Plug and Play installations, 19-20
CompuServe, U.S. Robotics online support
and, 99

Connections CD-ROM

Modem Update Wizard, 53-64
software installation, 33-50

D

drivers, modem
installing, 25-32

E

error control
disabling, 92

F

faxing with RapidComm Voice software, 48-50
flow control, 51
FTP, U.S. Robotics online support and, 98

Index

I

IRQs, 1, 3-12, 20
 conflicts, 89-90
ISA expansion slots, 14, 22

J

jumper pins, 10-12, 20
jumper shunts, 10-12, 20

M

microphone installation, 16, 24
modem installation
 Plug and Play, 19-32
 With Windows 3.x, 3-18
Modem Update Wizard, 53-64
 installing, 53-57
 using, 58-64

O

online help resources, 96-100

P

parity, 92
Plug and Play installation, 19-32
 failures, 95

R

RapidComm Voice software
 faxing with, 48-50
 installing, 33-50
 troubleshooting, 101

S

serial number, modem, 12, 21
shunts, jumper, 10-12, 20
speakerphone feature, 16, 24

Index

T

Technical Support Hotline, 99
terminal mode, 96, 99
Terminate and Stay Resident programs, errors and, 93, 94
troubleshooting, 89-94
 RapidComm Voice software, 101-102
TSR. See Terminate and Stay Resident programs

U

upgrading/updating modems, 53-64

V

V.17 fax transmissions, errors and, 94

W

Windows 95

determining your version, 2

World Wide Web (WWW), 3Com online support and, 96-100

X

x2 technology, 2, 53-64