



Canon

SELPHY CP400

COMPACT PHOTO PRINTER
IMPRESORA FOTOGRÁFICA COMPACTA
IMPRIMANTE PHOTO COMPACTE

User Guide

ENGLISH

Guía del usuario

ESPAÑOL

Guide d'utilisation

FRANÇAIS

Canon SELPHY CP400

Canon

Connecting the Printer to a Camera and Printing
Conexión de la impresora a la cámara e impresión
Connexion de l'imprimante à l'appareil photo

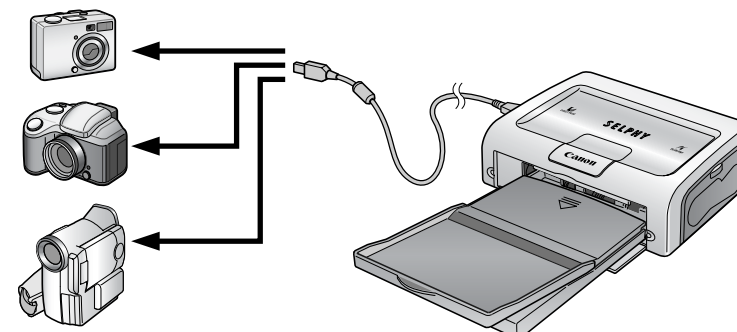

Connecting the Printer to a Computer and Printing
Conexión de la impresora a un ordenador e impresión
Connexion de l'imprimante à un ordinateur et impression

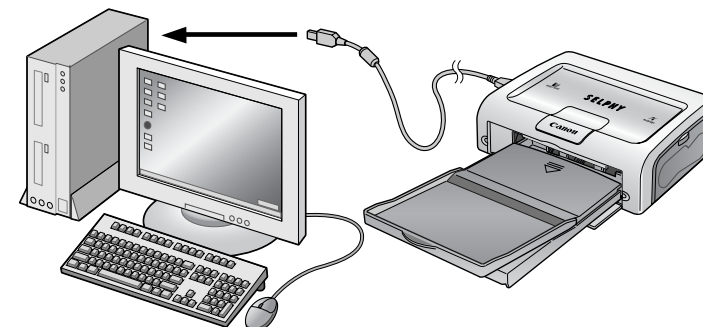

Contents

Enjoy Various Kinds of Printing	2
Printing Procedure and Reference Guides	4
Package Contents	6
Quick Start	7
Before You Begin	11
What Can Be Accomplished with this Printer	12
Symbols Used	12
Read This First	13
Safety Precautions	13
Proper Usage and Handling.....	17
Components Guide	21
Let's Print	23
Preparing Your Ink Cassette/Paper Sets and Paper Cassette	23
Loading the Ink Cassette	25
Placing the Paper into the Paper Cassette	26
Loading the Paper Cassette.....	28
Connecting a Power Source and the Camera to the Printer	29
Printing	31
Troubleshooting	33
Error Messages	35
Specifications	37
Connecting the Printer to a Computer and Printing	39
Read Carefully Before Using!.....	39
System Requirements.....	41
Printing Operations Overview	42
Installing the Software and the Printer Driver.....	43
Windows	43
Macintosh	46
Connecting the Printer to Your Computer	49
Viewing the PDF Manuals.....	51
Printer Software Guide	51
<i>ZoomBrowser EX Software User Guide / ImageBrowser Software User Guide</i>	51
Uninstalling the Software	52
Windows	52
Macintosh	53
Uninstalling the Printer Driver	54
Windows	54
Macintosh	55
Printing with Non-Canon Digital Cameras	57

Enjoy Various Kinds of Printing

Enjoy Printing Images from Your Digital Camera or Digital Camcorder

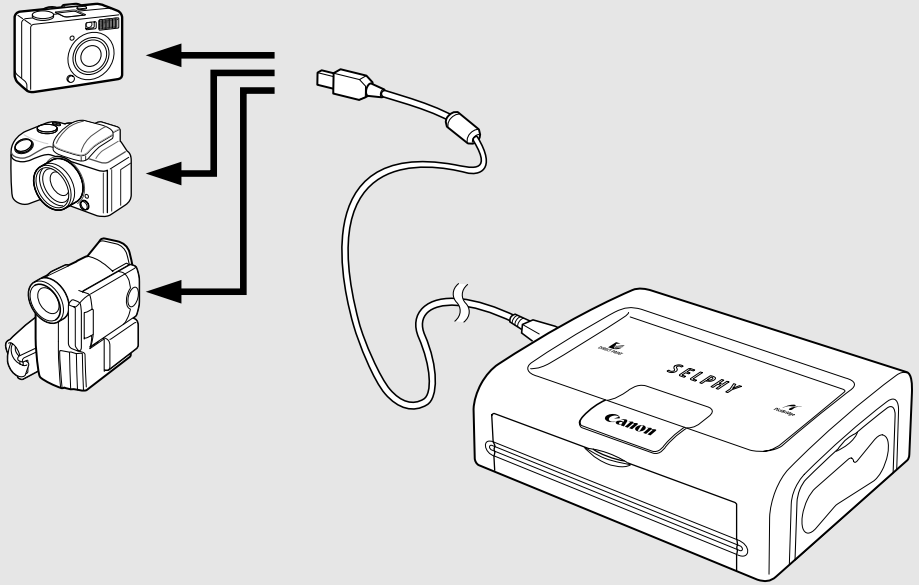

Enjoy Printing Images from Your Computer

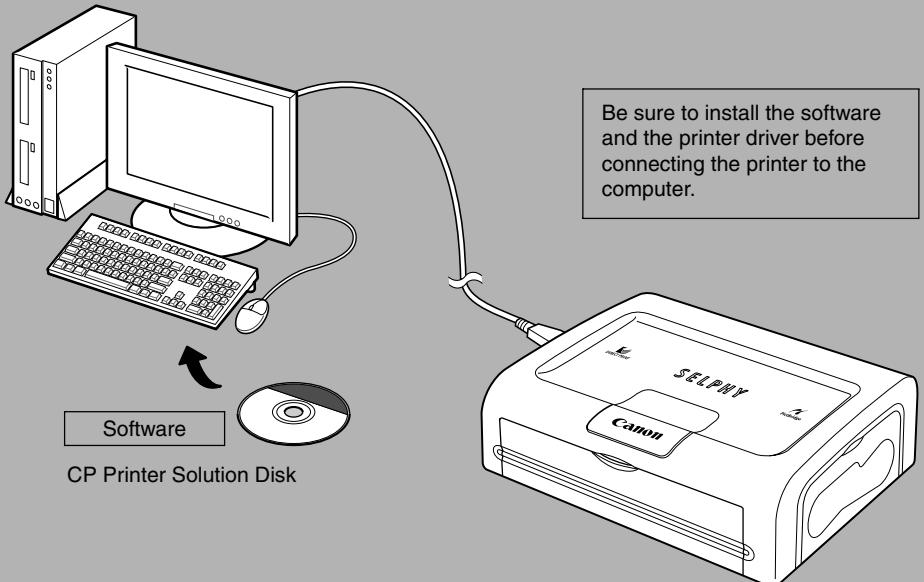

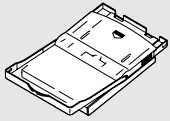

L size paper cassette
(sold separately)



Print easily at home.

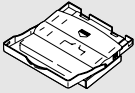

Credit card size paper cassette
(sold separately)



**Make label stickers.
(8 per sheet)**

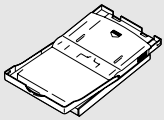

Postcard size paper cassette



Make original large size postcards.

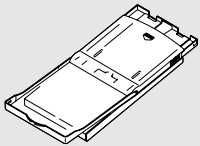

Wide size paper cassette
(sold separately)

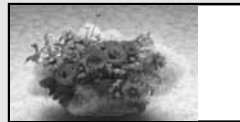

Make original greeting cards.

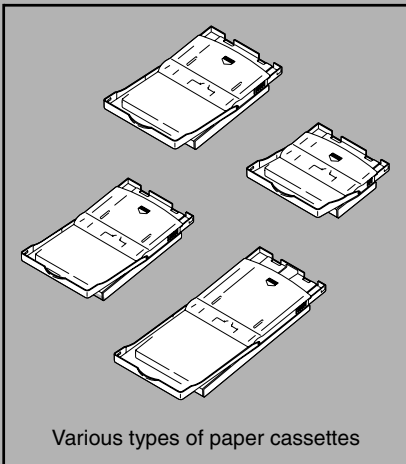

Various types of paper cassettes

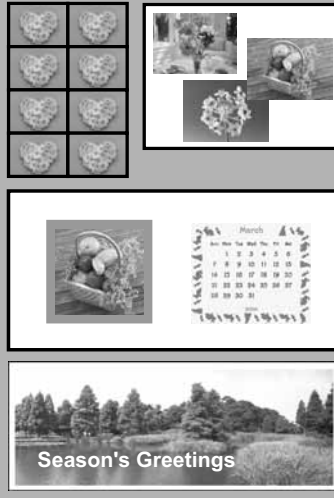

You can design layouts as you like.
Titles, captions, etc., can be added.

Printing Procedure and Reference Guides

Connecting a digital camera or digital video camera to the printer

Preparing

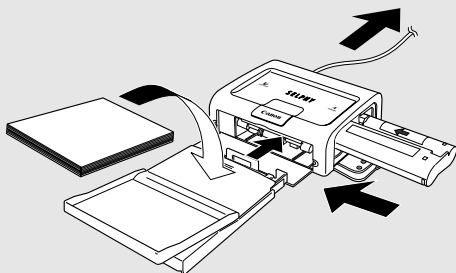

▶ Connecting

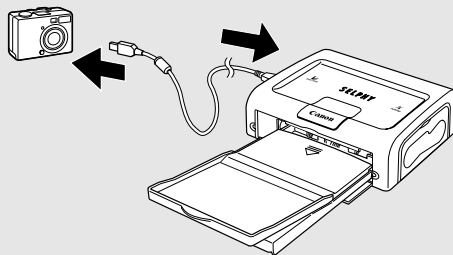

Reference Guides



User Guide
(This Guide) p. 25

Basic operations



User Guide
(This Guide) p. 29

Detailed instructions



Direct Print User Guide

Connecting the printer to a computer and printing

Preparing

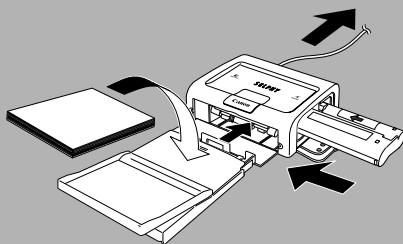

▶ Installing the Software

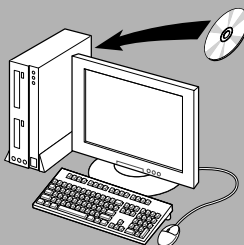

▶ Connecting

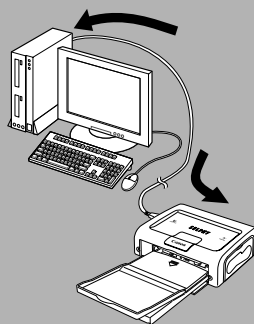

Reference Guides



User Guide
(This Guide) p. 39

and printing

▶ Printing

Print settings are made using the camera.

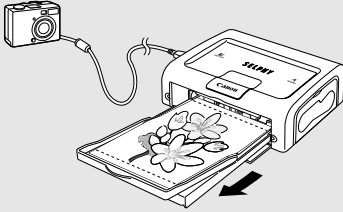

▶ Error Messages Troubleshooting

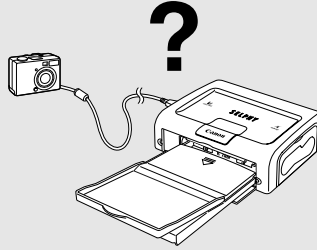

or



Camera User Guide

Using the Non-Canon Digital cameras, refer to the user guide that came with your camera.

▶ Printing

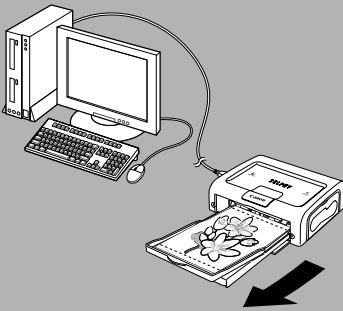

▶ Error Messages Troubleshooting

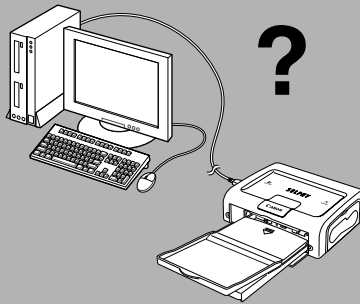

Printer Software Guide (PDF Format)

 : Included with the printer

Package Contents

**Compact Photo Printer
SELPHY**

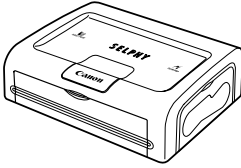

**Paper Cassette
(Postcard size)**

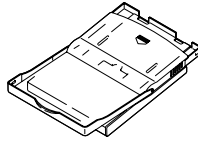

**CP Printer
Solution Disk**



**Standard Paper
(Postcard size,
5 sheets)**

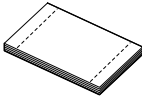

**Ink Cassette
(Postcard size,
for 5 sheets)**

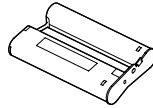

Cleaner Stick

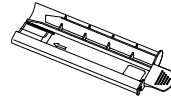

**Compact Power
Adapter CA-CP200**

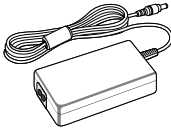

Power Cord

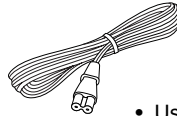

- User Guide (This Guide)
- Warranty Card*¹
- Canon Customer Support Leaflet*¹

*¹ Not included in some regions.

The following products are sold separately.

Paper Cassette PCL-CP100	L size
Paper Cassette PCC-CP100	Credit card size
Paper Cassette PCW-CP100	Wide size (100 × 200 mm (4 × 8 in.))
Color Ink/Paper Set KP-36IP	Postcard size, 36 standard sheets
Color Ink/Paper Set KP-108IP	Postcard size, 108 standard sheets
Color Ink/Paper Set KL-36IP	L size, 36 standard sheets
Color Ink/Paper Set KC-36IP	Credit card size, 36 standard sheets
Color Ink/Paper Set KW-24IP	Wide Size (100 × 200 mm), 24 standard sheets
Color Ink/Full-sized Label Set KC-18IF	Credit card size, full-size, 18 Label sheets
Color Ink/Label Set KC-18IL	Credit card size, Multiple (8-screen), 18 Label sheets

Some products are not sold in some regions.

Quick Start

Let's start by printing on postcard size paper.

This section explains the procedures required to print with the paper and the ink cassette (trial kit) included with your printer.

General camera descriptions in this guide refer to digital cameras or digital camcorders compatible with the compact photo printer (CP400). However, in detailed instructions, "camera" refers to "digital cameras", and "compact power adapter" refers to "power source" throughout this guide.

The name of the button which is used for printing differs depending on the model of your camera.

Things to Prepare

Printer (CP400)

Standard Paper (Postcard size, 5 sheets)

Ink Cassette (Postcard size, for 5 sheets)

Paper Cassette (Postcard size)

Compact Power Adapter CA-CP200

Power cord

Canon camera

Memory card containing the images you wish to print

Camera User Guide or Direct Print User Guide

Interface cable included with your camera kit

 : Included with the printer

1 Loading the Ink Cassette in the Printer (p. 25)

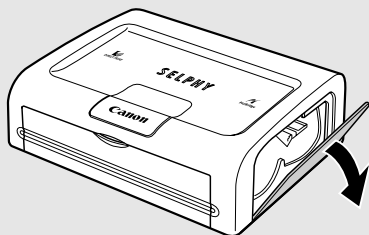

1 Open the ink cassette compartment cover.

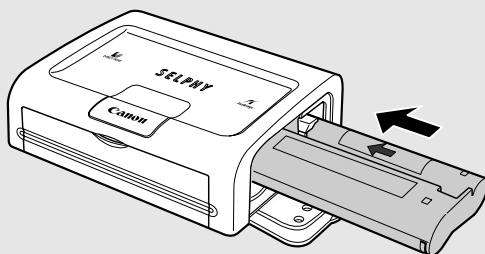

2 Load the ink cassette and close the ink cassette compartment cover.

Quick Start (Continued)

2 Placing the Paper into the Paper Cassette (p. 26)

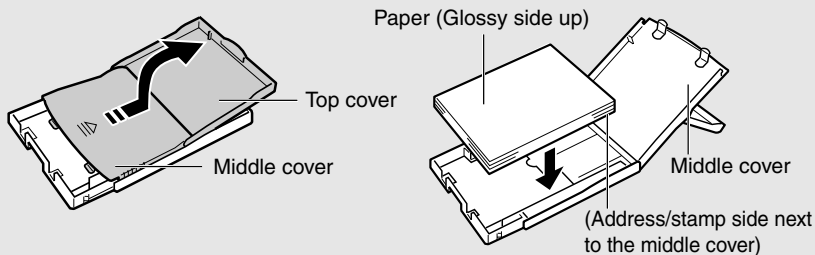

1 Open the paper cassette's top and middle covers.

2 Place the paper (postcard size, 5 sheets), glossy side up and the address/stamp side next to the middle cover, in the paper cassette.

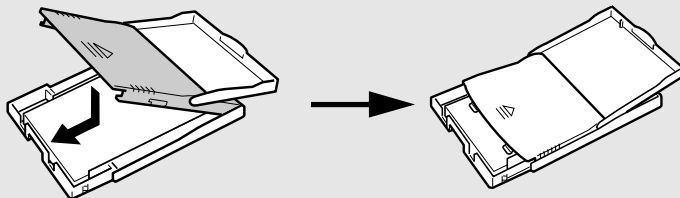

3 Place the middle cover back to its original position, and leave the top cover open.

3 Loading the Paper Cassette into the Printer (p. 28)

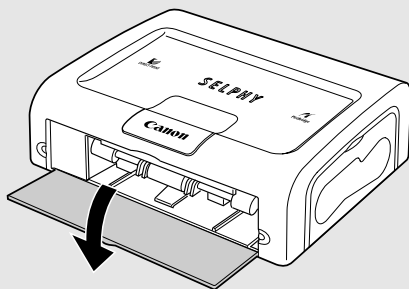

1 Open the paper cassette compartment cover.

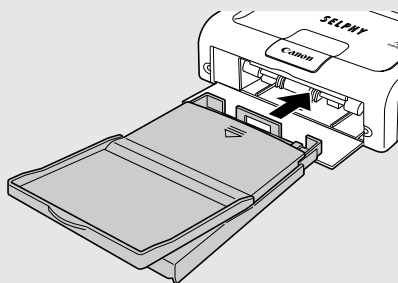

2 Push the paper cassette all the way into the paper cassette compartment, with its top cover open and its middle cover closed.

4 Connecting the Printer to a Power Source (p. 29)

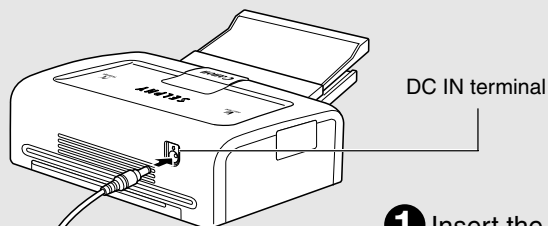

- 1 Insert the power cord into the compact power adapter and plug the other end into a power outlet.

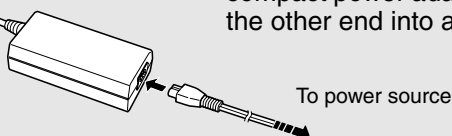

- 2 Connect the compact power adapter to the printer's DC IN terminal.

- At this point, the power will turn on and the printer's display window will light blue.

5 Connecting the Camera to the Printer (p. 29)



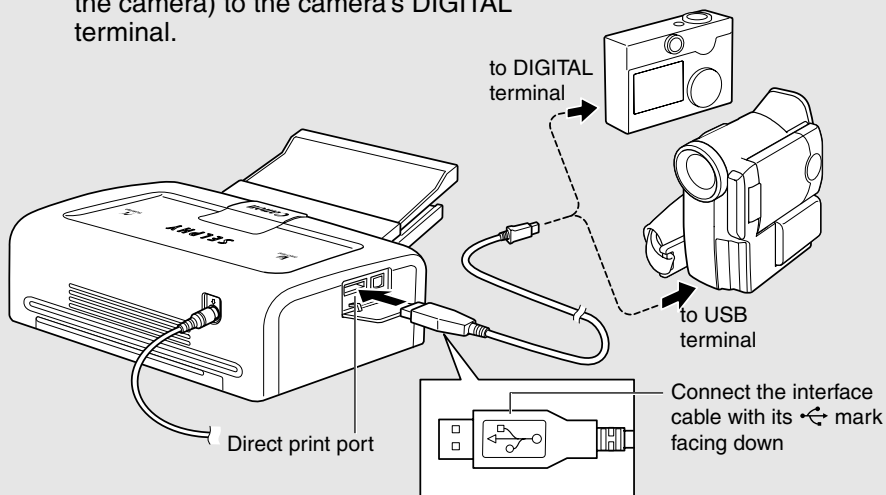

- 1 Connect the interface cable (included with the camera) to the camera's DIGITAL terminal.



- 2 Connect the other end of the interface cable to the printer's direct print port.

Quick Start (Continued)

6 Printing (p. 31)

- 1 Turn the camera's power on and display the images.
 - The  (*Canon Direct Print*) mark or the  (*PictBridge*) mark appears on the upper left corner of the LCD monitor.
- 2 Press the camera's , **SET** or **SELECT** button.
 - The button to be pressed differs depending on the camera.
 - If the  button is pressed, printing starts immediately.



Screen shot of the camera's LCD monitor

The screen shot differs depending on the model of your camera.

- 3 Select [Print] and press the **SET** or **SELECT** button.
 - Printing starts.
 - The printer's display window blinks blue.

With certain camera models, the camera will power up and display its images when it is connected to the printer with the interface cable. For detailed instructions, please refer to the *Camera User Guide* or *Direct Print User Guide* that came with your camera.

Before You Begin

Thank you for your purchase of the Canon Compact Photo Printer SELPHY CP400. This guide explains the printer's general flow of operations, from camera print settings to printing and computer connection operations to printing. For information about how to make prints, refer to the *Camera User Guide* or *Direct Print User Guide* that came with your camera and to the *Printer Software Guide* (bundled on the CP Printer Solution Disk).

Before using your printer for the first time, please read through the *Safety Precautions* (p. 13).

Warning Against Copyright Infringement

Please respect all copyrights. Use of images produced by this printer for purposes other than personal entertainment may be prohibited by law.

Warranty Limitations

This printer's warranty is only effective in the country of sale. If a problem arises while the printer is in use abroad, please convey it back to the country of sale before proceeding with a warranty claim to a Canon Customer Support center.

For Canon Customer Support contacts, please see the Canon Limited Warranty supplied with your printer.

Use of genuine Canon accessories is recommended.

This product is designed to achieve excellent performance when used with genuine Canon accessories. Canon shall not be liable for any damage to this product and/or accidents such as fire, etc., caused by the malfunction of non-genuine Canon accessories (e.g., a leakage and/or explosion of a battery pack). Please note that this warranty does not apply to repairs arising out of the malfunction of non-genuine Canon accessories, although you may request such repairs on a chargeable basis.

What Can Be Accomplished with this Printer

Connects directly to supporting Canon cameras

Allows easy printing from any Canon camera that supports direct printing with the compact photo printer (CP400). Just connect the interface cable and you're ready to go.

Connects directly to computers

Simply connect the printer to a computer with a commercially available USB cable to perform the following operations;

- Print the shots taken with your camera in a variety of layouts.
- Print part of an image (trimming)
- Print images with captions and artistic layout (Windows only)
- Make your own custom business cards

Four paper sizes and two types of labels

You can print on standard paper in postcard size, L size, credit card size or wide size (100 × 200 mm (4 × 8 in.)). In addition to the standard size paper, you can print full-sized labels or 8-label stickers with the credit card size paper.

High-quality prints, fast paper feeding

Offers photo-quality prints. Produces up to 18* prints without reloading.

* Up to 12 prints when using wide size paper (sold separately).

Fast printing

Postcard size images can be printed at the high speed of approximately 81 seconds per sheet.*

* The above printing speeds are applicable when Canon compact digital camera equipped with the DIGIC II is connected to the printer. Printing speeds may vary with other cameras.

Coated prints

Applies a protective coating to each print.



Borderless prints

Can produce borderless images that fill the paper completely.

Supports DPOF (Digital Print Order Format)

Supports DPOF settings for print selection, number of copies, and shooting date.



- If  or  mark does not display on the camera's LCD monitor when you connect your camera to this printer, your camera's firmware may be incompatible with this printer. Please check the Canon BeBit website (<http://web.canon.jp/Imaging/BeBit-e.html>) or your regional Canon website, for information or to download compatible firmware.

Since this printer complies with an industry standard for direct printing (*PictBridge*), you can print with non-Canon cameras that are also compatible with this standard. For details, refer to page 57.

Symbols Used



: This mark denotes issues that may affect the printer's operation.



: This mark denotes additional topics that complement the basic operating procedures.

Safety Precautions

- Before using the devices, please ensure that you have read and understood the safety precautions described below. Always ensure that the devices are operated correctly.
- The safety precautions noted on the following pages are intended to instruct you in the safe and correct operation of the devices to prevent injuries or damage to yourself and other persons.
- “Devices” refers to the “printer” or “compact power adapter” throughout this guide.



WARNINGS

Do not play the supplied CD-ROM(s) in any CD player that does not support data CD-ROMs. Playing the CD-ROM(s) in an audio CD player (music player) could damage the speakers. It is also possible to suffer from hearing loss from listening with headphones to the loud sounds of a CD-ROM played on a music CD player.

■ Devices

If the devices emit smoke or a burning odor, or show other signs of significant malfunction, immediately unplug the power cord from the power outlet. Continued operation under these conditions poses risk of fire or electric shock. Be sure that smoke or burning odor subsides, and then contact your dealer or the nearest Canon Customer Support help desk.

If the devices are dropped or the casing becomes damaged, unplug the power cord from the power outlet. Continued operation poses risk of fire or electric shock. Contact your dealer or the nearest canon Customer Support help desk.

Never rest small metallic objects or liquid containers on top of the devices. If liquid splashes onto the devices, wipe the devices dry using a soft absorbent cloth. If liquid spills into the devices or an object falls into the devices, immediately unplug the power cord from the power outlet. Continued operation poses risk of fire or electric shock. Contact your dealer or the nearest Canon Customer Support help desk.

Do not use flammable solvents such as alcohol, benzene, or paint thinner to clean the devices. Use of such solvents poses a fire risk.

Do not drop or insert metallic or combustible objects into the devices. Entry of foreign objects into the devices may result in fire, electric shock, or equipment failure. Store the devices out of the reach of children.

Do not disassemble or modify the devices. The devices contain high-voltage components, and there is risk of electric shock. If your devices need internal adjustments or repair, contact your dealer or a Canon Customer Support help desk.

Do not touch metal parts of the devices or the power plug during thunderstorms. Lightning strikes may produce lethal voltages within the devices. Keep clear of the devices while thunderstorms are in progress.

■ Power

Do not exceed the cable and power outlet ratings when operating this product. Do not operate this product outside of the specified voltage rating. Connecting too many devices to the same outlet may result in fire. Check that the voltage of the outlet is compatible with the devices before plugging them in.

If the power cord becomes damaged (if internal wiring is exposed, etc.), immediately unplug it from the power outlet. Continued use poses risk of fire or electric shock.

Do not plug in or unplug the power cord while your hands are wet, as this may result in electric shock. When unplugging the power cord, hold it firmly at the plug area. Do not pull directly on the cord, as this may damage or expose the cord's internal wiring, resulting in risk of fire or electric shock.

Be sure that the power cord is plugged all the way in. A loose connection may result in heat buildup, fire, or electric shock.

Do not damage, modify, or rest heavy objects on the power cord. Damage to the cord may result in the exposure of live wires, fire, or electric shock.

Keep the power cord free of dust. The presence of dust or metallic debris on the plug poses risk of fire or electric shock. If the plug area is not clean, unplug the power cord and then wipe the plug area clean using a dry cloth. Check the plug periodically to make sure it is clean.

■ Usage Location

Do not place the devices on an unstable or tilted table or desk, as there is risk that the devices may fall and cause injury.



CAUTIONS

■ Devices

Do not block the air vents on the printer. Blocking the vents may cause the inside of the printer to overheat, resulting in damage to internal components and risk of equipment failure or fire. Use the devices in a well-ventilated area.

Do not rest heavy objects on the devices. Objects may fall off the devices and cause injury. Weight placed on the devices may deform the casing, resulting in damage to internal parts and posing risk of fire.

Unplug the devices when you are not using them. If the devices remain plugged in, there is risk that accidental contact with the device's internal parts may cause electric shock. Leaving the devices plugged in during prolonged periods of non-use poses risk of fire.

Do not remove the paper cassette from the printer while printing is in progress. Paper moves back and forth in the cassette four times during printing. Placing your hand in the way of moving paper may result in injury. Wait for printing to finish completely before removing the cassette. Never place your hand into the paper cassette slot.

Do not reach into internal parts of the devices except as specified in the operating instructions. Reaching into inappropriate parts of the devices may cause your hand to become caught or injured.

■ Power

Do not move the devices while they are plugged in. Doing so may damage the power cord. Continued use of a damaged power cord poses risk of fire or electric shock.

Do not excessively bend or twist the power cord. Doing so may damage the cord. Continued use of a damaged cable poses risk of fire or equipment failure. Leave about 15 cm (6 in.) of clearance at the front and back of the devices and 10 cm (4 in.) of clearance on both sides to ensure adequate ventilation.

Do not pull on the power cord. Doing so may damage the power cord. Continued use of a damaged cord poses risk of fire or electric shock. Always hold the cord by the plug area when unplugging it.

■ Usage Location

Do not use the devices in locations that are smoky, humid, dusty, or subject to strong vibration. Entry of water or dust into the devices, or internal damage caused by strong vibration, may pose risk of fire or electric shock. Have the devices checked approximately once a year (contact your dealer), preferably before the onset of your area's humid season.

Do not leave the devices exposed to high temperatures. Do not leave in direct sunlight, or close to heating equipment, or in a car with windows closed on a hot day. High temperatures may cause deformation of the devices and pose risk of fire.

Do not use the devices near an open flame. Sheets ejected from the printer (onto the top of the paper cassette) may fall into the flame, resulting in fire.

Do not use the devices close to TV sets or AM radios. Devices' operation may adversely affect TV and radio reception.

Proper Usage and Handling

■ Usage Location

Do not use near strong magnets or near devices that produce strong electromagnetic fields. Electromagnetic radiation from devices such as TVs and game machines, and strong magnetic fields from devices such as speakers and large motors, may cause distortion in printed images.

Use in a well-ventilated, level area.

Leave about 15 cm (6 in.) of clearance at the front and back of the devices and 10 cm (4 in.) of clearance on both sides. Be sure to leave clearance around the paper-handling slot (at the rear) so that paper has sufficient room to jut out from the slot during printing.

Place the printer so that the air vents on the back will not be blocked.

If the air vents blocked, the printer interior could heat up, causing the printer to temporarily stop.

■ Handling Precautions

Please avoid turning the printer's power on and off needlessly as the printer initialization consumes ink: There may not be enough ink left for the allotted sheets in the set.

Unplug the printer when you are not using it. But please note that you should plug in and run the printer at least once every six months to ensure that it remains functional.

Before transporting the printer, remove the paper and ink cassettes and close the paper cassette cover and the ink cassette cover. If dirt or foreign objects enter the printer, print quality may deteriorate.

Pack the printer into an appropriate case for transport. If a case is not available, wrap it with cloth or other protective material to protect against scratches.

Never use volatile compounds or insecticides on the printer, and do not allow rubber or vinyl material to remain in prolonged contact with the printer. These materials may cause deformation of the printer's casing.

□ Overheating

If the printer overheats, it will temporarily stop operating. *This does not mean that the printer has malfunctioned.* The printer will resume normal printing as soon as it cools down.

Temporary stoppages are most likely to occur in the following cases:

- When printing continuously.
 - If the room is unusually warm.
 - If the air vents on the back of the printer are blocked or if ventilation is inadequate.
-

□ To Prevent Damage from Condensation

Condensation may form in the printer if you suddenly move it from a cold location to a warm location. To prevent damage that might be caused by condensation, place the printer in a sealed plastic bag prior to moving it, and allow it to reach room temperature before using it. Stop using the printer immediately if you detect condensation. Continued use may damage the equipment. Wait until the moisture evaporates completely before resuming use.

□ Cleaning the Printer

Never use benzene, paint thinner, or other volatile solvents to clean the printer. Volatile solvents may cause deformation or peeling of the printer's casing. To clean the printer, wipe it with a soft dry cloth. If stronger cleaning is required, wipe first with a cloth moistened with a dilute neutral solvent, then wipe again with a soft dry cloth. If you use a chemical cleaning cloth, read the instructions that come with it and observe all indicated precautions.

Keep the air vents clean and free of dust. Clean the vents as necessary. Dust that enters the printer through the vents may land on the ink sheet, resulting in poor print quality and possibly leading to printer breakdown. If the ink sheet becomes dusty, remove the ink cassette and replace it with a new one.

■ Proper Handling of Ink Cassettes

Please use only the ink cassettes specified for use by Canon.

Do not open the ink cassette cover while printing is in progress, and do not pull the ink cassette out. These actions may damage the printer.

Do not touch or pull on the ink sheet.

Do not handle the ink cassettes with wet or sweaty hands.

Allow ink cassettes to reach room temperature before installing and using them.

Condensation may form if you suddenly move ink cassettes from a cold location to a warm location. If there is risk of condensation, leave the cassette in its packaging until it reaches room temperature, and wipe away any moisture before loading it.

If you are not planning to use the printer for a while, remove and store the ink cassette.

■ Proper Handling of Paper Cassettes

Do not apply excessive force to the paper cassette. Force or impact on the cassette may result in paper jams or equipment damage.

Do not bend or deform the spring located at the rear of the middle cover of the paper cassette.

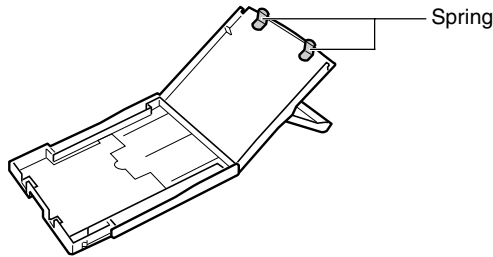

Do not place any foreign objects in the print output receptacle (on the top of the paper cassette). This area is for paper only.

If you are not planning to use the printer for a while, remove the paper cassette, close the paper cassette's top cover and store the paper cassette. Also remove the paper from the paper cassette and store it horizontally.

■ Proper Handling of Paper

Please use only the paper types specified for use by Canon.

Paper must be printed on the glossy side (the side without any printed markings).

Always load paper into the cassette with the glossy side up. Loading the paper the wrong way may result in poor print quality, and in some cases may cause damage to the printer.

Do not tear or bend the paper's perforated edges before printing. Tearing the paper's perforated edges will cause the ink sheet to wind up automatically and waste one print's worth of ink. If this happens, there will not be enough ink left to print all the paper sheets included in the kit.

Do not use label sheets on which labels are partially peeled off.

Do not touch the print side of the paper with your fingers. Always hold the paper along the edges (outside the perforated border).

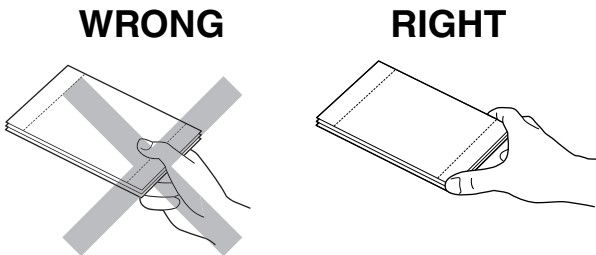

Be sure that hands are dry before touching the paper. Sharp objects will scratch the paper surface. Keep the paper surface free from fingerprints, dust, water droplets, etc.

Do not write on the paper before printing. Writing on paper before printing on it may result in malfunction.

Do not touch paper while it is being printed. During printing, the sheet repeatedly moves back and forth along the top of the paper cassette and in and out through the paper-handling slot. Please do not touch the sheet during this process.

Do not allow too many prints to accumulate in the print output receptacle. Do not allow more than 9 sheets to accumulate in the print output receptacle.

You may write on the paper with an oil-based pen, but to avoid smudging please allow ink time to dry before touching it.

Allow the paper to reach room temperature before installing and using it. Condensation may form if you suddenly move the paper from a cold location to a warm location. If there is risk of condensation, leave the paper in its packaging until it reaches room temperature, and wipe away any moisture before loading it.

Please avoid the following actions as they may result in color change, color fading or color bleeding.

- Sticking any type of adhesive tape onto the print surface.
 - Allowing print surfaces to come into contact with vinyl materials.
 - Applying alcohol or other volatile solvents to the print surface.
 - Leaving print surfaces tightly pressed against any other surfaces or objects for prolonged periods.
-

■ Paper Storage

If you wish to mount prints into an album, select an album with nylon-based sleeves, or with propylene or cellophane sleeves. Other types of sleeves may cause color loss or color bleeding.

Color change may occur over time in accordance with conditions of storage. Canon assumes no liability for color changes.

To avoid print quality deterioration, do not store your prints in the following types of locations.

- Locations that reach temperatures above 40 °C (104 °F)
 - Humid or dusty locations
 - Locations exposed to direct sunlight.
-

Remove unused paper from the paper cassette, return it to the bag and then into its original package. Store the package horizontally.

■ Others

When opening a color ink/paper set (full-sized label set, label set), check the contents. If something seems to be missing or appears to be damaged, contact the dealer for assistance.

Components Guide

■ Compact Photo Printer SELPHY CP400

Front View

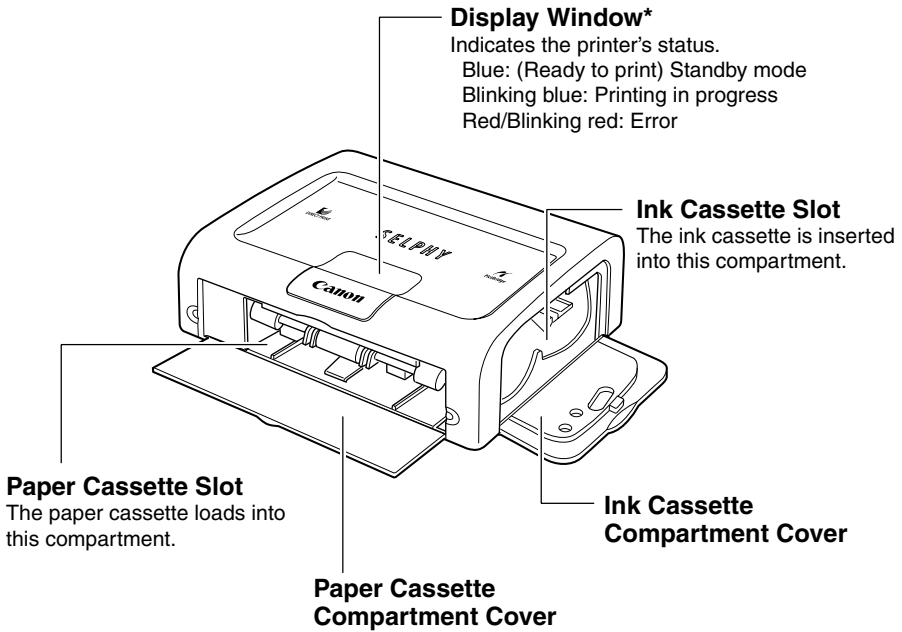

* The display window is covered with a thin plastic film for protection against scratches during shipment. Remove it before using the printer.

Back View

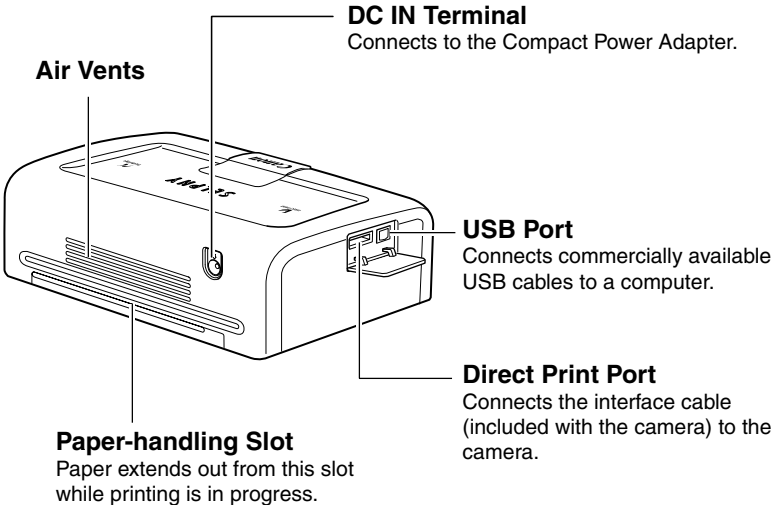

Preparing Your Ink Cassette/Paper Sets and Paper Cassette

Since there are several kinds of ink/paper set (including the separately sold sets), please make sure you are using the right ink cassette and paper cassette for the chosen paper. If the set is not correct, you will not be able to print. Please check the sets and the names of their components in the table below.

Look here for the paper cassette name

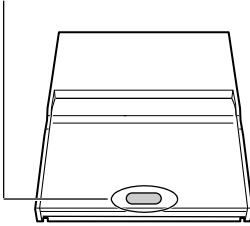

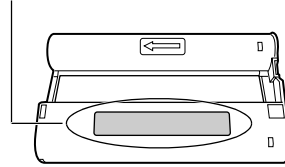

Look here for the ink cassette name



■ Checking Your Ink/Paper Sets

□ Printing on Postcard Size Paper (100 × 148 mm (4 × 6 in.))

Paper	Number of Sheets	Paper Cassette Name	Ink Cassette Name The design of the seal on your ink cassette may slightly differ from the examples below.
	5	POSTCARD SIZE	Postcard (4x6in) size Canon 5 Printouts Made in Japan/Japon
	36	POSTCARD SIZE	Postcard (4x6in) size Canon 36 Printouts Made in Japan/Japon

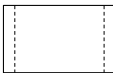

-  Included in package

□ Printing on L Size Paper (89 × 119 mm (3.5 × 4.7 in.))

Paper	Number of Sheets	Paper Cassette Name	Ink Cassette Name The design of the seal on your ink cassette may slightly differ from the examples below.
	36	L SIZE	L size Canon 36 Printouts Made in Japan/Japon

- The paper cassette PCL-CP100 (sold separately) is required when printing on L size paper.

□ Printing on Credit Card Size Paper (54 × 86 mm (2.1 × 3.4 in.))

Paper	Number of Sheets	Paper Cassette Name	Ink Cassette Name The design of the seal on your ink cassette may slightly differ from the examples below.
 Standard Paper	36	CARD SIZE	Card size Canon 36 Printouts Made in Japan/Japan
 Full-sized Label	18	CARD SIZE	Card size Canon 18 Printouts Made in Japan/Japan
 8-sticker Label	18	CARD SIZE	Card size Canon 18 Printouts Made in Japan/Japan

- The paper cassette PCC-CP100 (sold separately) is required when printing on credit card size paper.

□ Printing on Wide Size Paper (100 × 200 mm (4 × 8 in.))

Paper	Number of Sheets	Paper Cassette Name	Ink Cassette Name The design of the seal on your ink cassette may slightly differ from the examples below.
	24	WIDE	Wide(100x200mm/4x8in) Canon 24 Printouts Made in Japan/Japan

- The paper cassette PCW-CP100 (sold separately) is required when printing on Wide size paper (100 × 200 mm (4 × 8 in.)).

□ Separately Sold Ink and Paper Products

You can use the following color ink/paper sets (sold separately) with the Canon Compact Photo Printer SELPHY CP400.

Paper Size	Contents	Product Name
Postcard size	Standard paper (36 sheets) Dedicated ink cassette	Color Ink/Paper Set KP-36IP
L size	Standard paper (36 sheets) Dedicated ink cassette	Color Ink/Paper Set KL-36IP
Credit card size	Standard paper (36 sheets) Dedicated ink cassette	Color Ink/Paper Set KC-36IP
	Full-sized label (18 sheets) Dedicated ink cassette	Color Ink/Full-Sized Label Set KC-18IF
	8-sticker label (18 sheets) Dedicated ink cassette	Color Ink/Label Set KC-18IL
Wide size (100 × 200 mm (4 × 8 in.))	Standard paper (24 sheets) Dedicated ink cassette	Color Ink/Paper Set KW-24IP

- One ink cassette can print to all of the paper included in the ink/paper set.

Loading the Ink Cassette

1

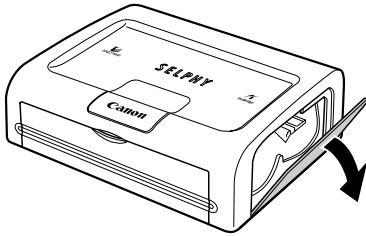

Open the ink cassette compartment cover.

2

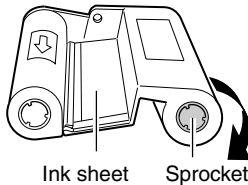

Remove any slack from the ink sheet.

- Push in on the sprocket, and turn it gently in the indicated direction to take up the slack until the ink sheet straightens out (It will not be possible to print to all of the paper if you overwind the ink sheet).

3

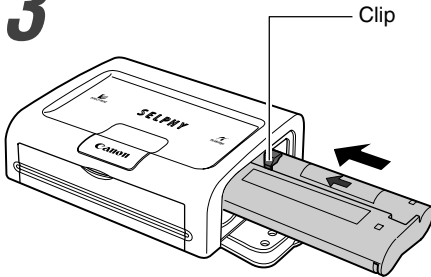

Hold the cassette so that the embossed arrow is at the top, and insert it all the way into the compartment (in the direction of the arrow).

- Be careful to avoid touching or pulling on the ink sheet when inserting the cassette.
- Push the cassette all the way in, so that it clicks into place.
- When you are ready to remove the ink cassette, lift the clip and pull the cassette out.

4

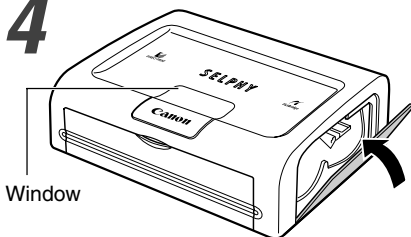

Close the ink cassette compartment cover.

- You can check the name of the ink cassette in the printer through the window on the top of the printer.



- Do not reuse empty ink cassettes. Attempting to reuse an empty ink cassette may result in malfunction or damage to the printer.
- Please also refer to the *Proper Handling of Ink Cassettes* section of *Proper Usage and Handling* (p. 18).

Placing the Paper into the Paper Cassette

1

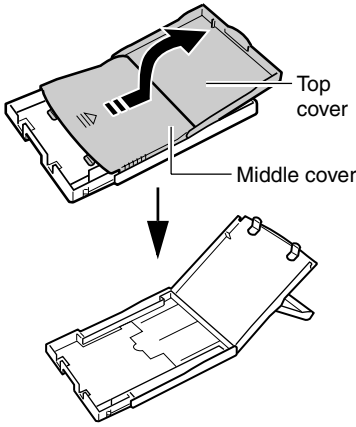

Open the paper cassette's top cover and middle cover.

- Open the top cover, then push the middle cover in the direction of the arrow and lift it up.

2

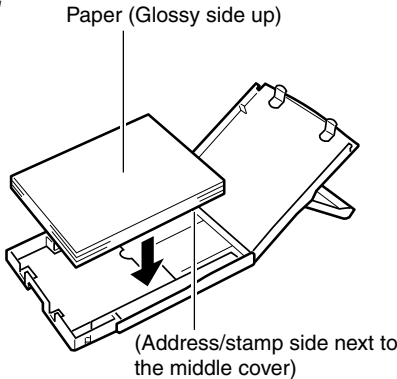

Fan the paper stack properly and place the paper into the paper cassette, with the printable side (glossy side) facing up.

- Insert the postcard size paper with the glossy side up and the address/stamp side next to the middle cover as shown in the figure.
- Do not touch the glossy side of the paper (to avoid fingerprints) when you fan the paper stack.
- Insert the wide size paper (100 × 200 mm (4 × 8 in.)) (sold separately) as shown in the figure below.
- Insert the credit card size paper as shown in the figure below.

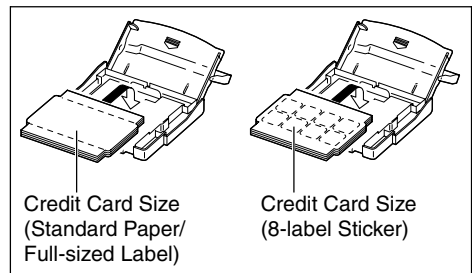
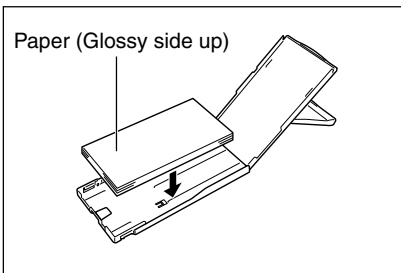

- Insert the L size paper (sold separately) as shown in the figure below

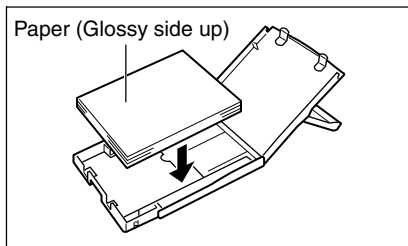

3

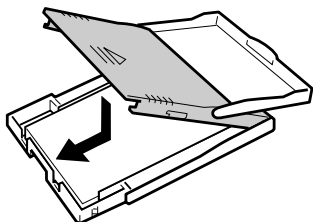

Place the middle cover back to its original position.

- After pulling the middle cover down, slide it in the direction of the arrows until it clicks back into place.
- Do not close the top cover.



- Please use specified paper types only.
- Do not insert more than 18 sheets in the paper cassette.
- Do not insert more than 12 sheets wide size paper (100 × 200 mm (4 × 8 in.); sold separately) in the paper cassette.
- **Printed or fed paper is coated even when nothing is printed on the paper. Therefore, never reuse the printed or fed paper for printing. Reused paper may stick to the ink sheet, resulting in damage to the printer.**
- Please also refer to the *Proper Handling of Paper Cassettes* and the *Proper Handling of Paper* sections of *Proper Usage and Handling* (p. 19).

Loading the Paper Cassette

1

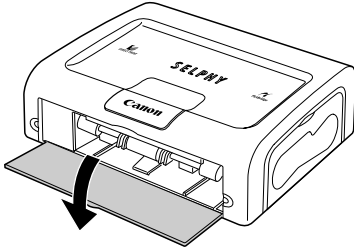

Open the paper cassette compartment cover.

2

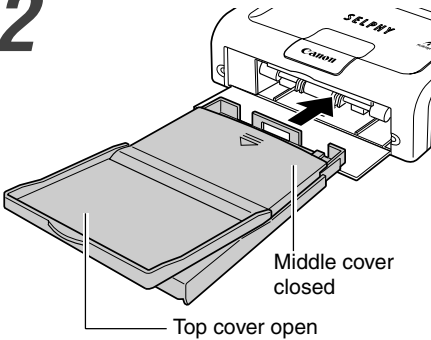

Push the paper cassette all the way into the paper cassette slot.

- Be sure the paper is set correctly before pushing the cassette in.
- Insert the paper cassette evenly so that it slides over the bottom of the slot entrance.



- Do not remove the paper cassette while feeding, printing, or ejection is in progress.



- The printer outputs the finished prints into the receptacle onto the top of the printer cassette (top of the middle cover or inside of the top cover). Be sure to close the middle cover and open the top cover so that output can proceed normally.

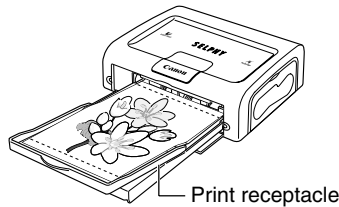

Connecting a Power Source and the Camera to the Printer

Connect the camera to the printer using the cable (included with the camera) and turn the printer's power on.

For more detailed camera connection instructions, refer to your *Camera User Guide* or *Direct Print User Guide*.

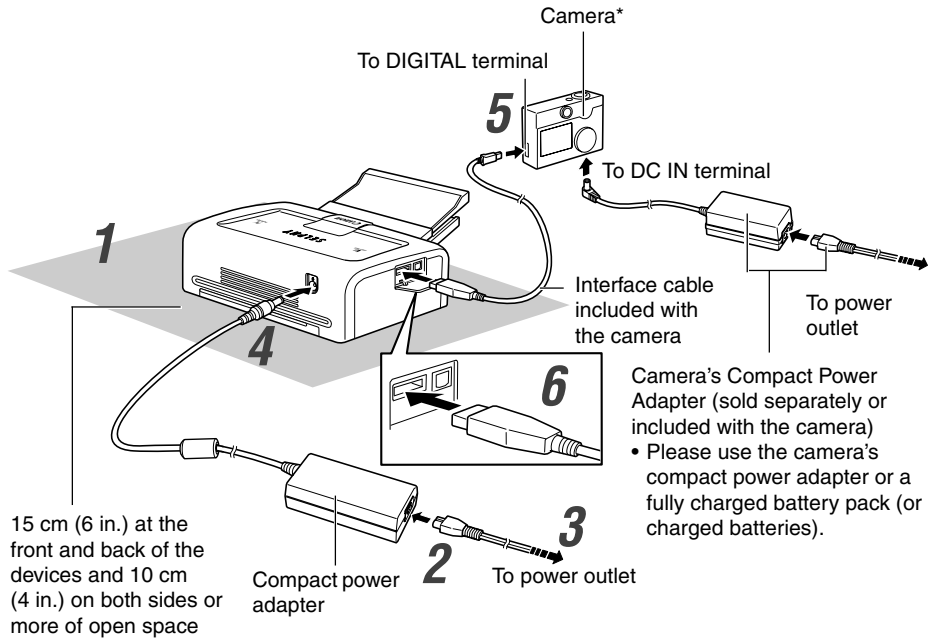

* Canon cameras compatible with CP400, and non-Canon cameras compatible with PictBridge can also be connected.

The numbered steps in the following instructions refer to the numbers in the above illustration.

1 Place the printer on a flat area.

- Be sure to leave about 15 cm (6 in.) of clearance around the paper-handling slot (at the rear) so that paper has sufficient room to jut out from the slot during printing.

2 Connect the supplied power cord to the supplied Compact Power Adapter CA-CP200.

3 Insert the plug in a power outlet.

4

Connect the Compact Power Adapter cable to the printer.

- The power turns on and the printer's display window lights blue.

5

Connect the interface cable to the camera.

- Use the interface cable that came with your camera.

6

Connect the interface cable to the printer.

- Insert the cable in the left port, **with the ↵ mark on the cable facing down.**

■ Turning the Printer's Power Off

Unplug the cable of the compact power adapter from the printer. (The display window will shut off)



- We recommend that you also connect the camera's compact power adapter (sold separately or included with the camera) when using the camera with your printer.
- When connecting the cable, be sure that the connectors on the cable match up correctly with the connectors on the camera and printer.
- Use an easily accessible power outlet for the printer's power cord, so that you can unplug the printer cable quickly in the event of a problem.
- Please also refer to the *Usage Location* section of *Proper Usage and Handling* for information about printer usage location (p. 17).



- Some camera models do not come with a compact power adapter. For details, please see the *System Map* that came with your camera.

Printing

This section explains the flow of printing operations with Canon cameras*. For more details, refer to your *Camera User Guide* or *Direct Print User Guide*.

* In other cases, please refer to the *Printing with Non-Canon Digital Cameras* (p. 57).

1



Turn the camera's power on and display the images.

- Check that the (Canon Direct Print) or (PictBridge) mark is displayed in the upper left corner of the LCD monitor.
- Some camera models automatically power up when the cable is connected to the printer. The mark then displays on the LCD monitor.

2

Display the images to be printed and press the SET or SELECT button.

- If your camera has the (Print/Share) button, printing starts immediately after you press the button (Step 3 is not necessary).

3



Select [Print] and press the SET or SELECT button.

- Printing starts. The camera returns to the playback screen once printing is successfully completed.
- The display window blinks blue during printing.

The screen shot differs depending on the model of your camera.



If or does not display in step 1, check the following:

- Is the cable correctly connected? (p. 29)
- Is the printer's power on? (p. 29)
- Is your camera's firmware compatible with this printer?
→ Check the Canon BeBit website or your regional Canon website.

If printing does not start, check the following:

- Does the camera's LCD monitor display a message? (p. 35)

■ Printing on the Separately Sold Wide Size (100 × 200 mm (4 × 8 in.)) Paper

You can make your own message cards and greeting cards.

The cards are printed as explained below.

When the Camera is Connected to the Printer

Printed on the 100 × 150 mm (4 × 6 in.) portion of the card.



Nothing is printed on this portion so you can write your message with an oil-based pen.

When a Computer is Connected to the Printer





Printed on the whole card.



- If  (*PictBridge*) mark appears on step 1 on page 31, select [Default] on the paper size setting screen.
- When a computer is connected to the printer, you can lay out pictures and text as you wish. For details, refer to the *Printer Software Guide*.

Troubleshooting

If the printer does not seem to be working properly, run through the checks below to see if you can identify and correct the problem. If you are not able to solve the problem, please call your dealer or contact a Canon Customer Support help desk for assistance.

Problem	Cause	Solution
The printer has no power.	The compact power adapter or power cord is not correctly connected.	Be sure that the compact power adapter and power cord are connected correctly. Be sure that the power cord is plugged into a standard power outlet.
The printer's display window is blinking red.	There is a malfunction in the printer.	Turn the printer's power off and turn it on again.
The  (Canon Direct Print) /  (PictBridge) mark does not display in the upper left corner of the LCD monitor.	The cable is not correctly connected.	Connect the cable correctly. (p. 29)
	The printer's power is off.	Turn the printer's power on. (p. 29)
	Your camera's firmware is incompatible with this printer.	Please check the Canon BeBit website or your regional Canon website.
The printer does not print.	The printer is connected to a computer and printing is in progress.	Wait until the print outputted by the computer is complete.
	The printer is not correctly connected to the camera.	Connect the cable correctly. (p. 29) If the connection is correct, the  or  mark will appear on the camera's LCD monitor.
	The camera's batteries are depleted.	Replace with fully charged (fresh) batteries, or plug the camera into a power outlet (using the camera's optional compact power adapter).
	The ink cassette is not loaded correctly.	Load the ink cassette correctly. (p. 25)
	Too much slack in the ink cassette's ink sheet.	Take up the slack. (p. 25)
	The paper cassette is not pushed all the way in.	Load the paper cassette correctly. (p. 28)
Printing stopped midway.	The printer has overheated.	Wait for the printer to cool down.
	The printer is not correctly connected to the camera.	Connect the cable correctly. (p. 29)

Problem	Cause	Solution
The printer's display window lights red without the camera's LCD monitor displaying any error message.	There is a malfunction in the printer.	Remove the paper from the paper-handling slot and take up any slack in the ink sheet. Turn the printer's power off and turn it on again.
Print quality is not good.	You are not using the correct paper type.	Use the designated paper type.
	Paper is loaded with the wrong side up.	Load the paper correctly. (p. 26)
	The ink sheet or paper is dirty.	Use a clean ink sheet and clean paper.
	Condensation has formed inside the printer.	Wait for condensation to evaporate.
Faint stripes appear in the print.	Dust has accumulated inside the printer.	Remove the ink cassette and insert the cleaner stick in the direction of the arrow and with the arrow on the cleaner stick facing up. Push it in completely as shown in figure A and slide it in and out of the printer 2 or 3 times.
Printed images are distorted.	The printer is too close to a TV, video game machine, or other electromagnetic source.	Move the printer so that it is at least one meter (3.3 ft.) away from the electromagnetic source.
	The printer is too close to a stereo speaker, large motor, or other strong magnetic source.	Move the printer away from the strong magnetic source.
Nothing happens when the camera's  or SET button is pressed.	The printer has overheated.	Wait for the printer to cool down.
	Printing is in progress.	Wait for the printer to finish printing.
Frequent paper jams.	The paper cassette is overloaded.	Do not load more than 18 sheets of paper into the cassette. Do not insert more than 12 sheets of wide size paper (100 × 200 mm (4 × 8 in.); sold separately) in the paper cassette.
	The print output receptacle is too full.	Do not allow more than 9 sheets to accumulate in the receptacle.
	Paper is creased or curled.	Do not use paper that is creased or curled.

Figure A



Error Messages

If a problem occurs while the printer is connected to the camera, the printer's display window will light or blink red and the camera's LCD monitor may display one of the messages indicated below. (If the camera is connected to a TV, the message will appear on the TV screen.)

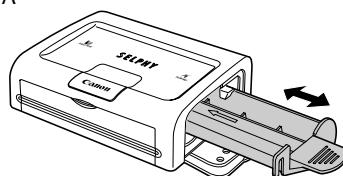
Error Message	Cause	Solution
No paper	Paper cassette is incorrectly installed.	Load the paper cassette correctly.
	Paper is not loaded correctly in the paper cassette.	Load paper into the cassette correctly.
	No paper in the paper cassette.	Load paper into the cassette.
	Paper is not feeding correctly.	Take out the paper cassette, and then manually remove any paper remaining in the printer.
No Ink	No ink cassette in the printer.	Load an ink cassette.
	The ink cassette is out of ink.	Load a new ink cassette.
Incompatible paper size	Wrong paper size is loaded in the printer.	Use the designated paper size.
Incompatible ink size	Wrong ink cassette size is loaded in the printer.	Use the designated ink cassette size.
Ink Cassette Error	The ink cassette is not working correctly.	Remove the ink cassette from the printer, take up the slack in the ink sheet, and then reload the cassette. If this does not solve the problem, replace with a new ink cassette. If the ink cassette is stuck in the printer, contact a Canon Customer Support help desk for assistance.
Paper and ink do not match	The paper and ink are from different sets.	Check the ink/paper sets.
Paper Jam	Paper jammed during printing.	Turn the power off and turn it on again. If the printer fails to eject the paper, contact a Canon Customer Support help desk for assistance.
Paper has been changed.	Paper was changed after the print menu was displayed.	Change back to the original paper size or change the print settings.
Communication Error	Error in communication between printer and camera.	Turn the printer and camera power off and turn it on again. If the error message does not clear, contact a Canon Customer Support help desk for assistance.

Error Message	Cause	Solution
Cannot Print!	The image was taken with a different camera, recorded in a different format, or has been altered by a computer.	Check whether the image's size matches the camera's pixel capacity. If the size is not appropriate, resize the image and convert as necessary so that the image is in a JPEG format that the camera can display.
Could not print xx images	You have selected a number of images for DPOF printing, but some of these images cannot be printed because they were taken with a different camera, recorded in a different format, or have been altered by a computer. (Where xx indicates the number of unprintable images from among those selected)	Check whether the image size matches the camera's pixel capacity. If sizes are not appropriate, resize the images and convert as necessary so that images are in a JPEG format that the camera can display.

Specifications

■ Compact Photo Printer SELPHY CP400

□ General Specifications

Printer Type	Full-color direct digital printer		
Print Method	Dye-sublimation thermal transfer (with overcoating)		
Resolution Reproduction	300 × 300 dpi		
Gradation	256 gradations/color		
Ink	Dedicated ink cassette for each paper size (Y/M/C/overcoating)		
Paper	Postcard size (standard sheets) L size (standard sheets) Credit card size (standard sheets, full-sized label and 8-label sticker) Wide size (100 × 200 mm (4 × 8 in.)) (standard sheets)		
Paper-Feed Method	Automatic feed from paper cassette		
Paper-Eject Method	Sheets eject onto top of paper cassette		
Print Modes	Standard (1-screen) print (bordered or borderless) Multiple (8-screen) print (for use with labels)		
Print Sizes	Postcard size print	(borderless)	: 100.0 × 148.0 mm (3.9 × 5.8 in.)
		(bordered)	: 91.4 × 121.9 mm (3.6 × 4.8 in.)
	L size print	(borderless)	: 89.0 × 119.0 mm (3.5 × 4.7 in.)
		(bordered)	: 79.2 × 105.3 mm (3.1 × 4.2 in.)
	Credit card size print	(full-sized, borderless)	: 54.0 × 86.0 mm (2.1 × 3.4 in.)
		(full-sized, bordered)	: 50.0 × 66.7 mm (2.0 × 2.6 in.)
		(8 stickers per label)	: 17.3 × 22.0 mm (0.7 × 0.9 in.) (per sticker)
	Wide size (100 × 200 mm (4 × 8 in.)) print	(computer connection)	: 100.0 × 200.0 mm (3.9 × 7.9 in.)
		(camera connection)	: 100.0 × 150.0 mm (3.9 × 5.9 in.)
	Print Speeds* (when a Canon camera is connected)	Postcard size print	(bordered/borderless)
L size print		(bordered/borderless)	Approx. 68 sec.
Credit card size print		(full-sized, bordered/ borderless)	Approx. 40 sec.
		(8 stickers)	Approx. 40 sec.
Wide size (100 × 200 mm (4 × 8 in.)) print			Approx. 102 sec.

* The above printing speeds are applicable when Canon compact digital camera equipped with the DIGIC II is connected to the printer. Printing speeds may vary with other cameras.
Based on Canon's standard testing conditions. Variations may occur depending on printing.

□ Interface

Signal Transfer	Proprietary protocol for Canon cameras, PictBridge	
Connection Method	Camera/Printer connection	Interface cable included with the camera
	Computer/Printer connection	Commercially available USB cable Recommended printer cable Material: AWG 28 or upper-grade Type: Twisted-pair, sealed cable (compatible with high-speed mode) Length: max. 5.0 m (16.4 ft.)

□ Device Specifications

Operating Temperatures	5 – 40 °C (41 – 104 °F)
Operating Humidity	20% to 80% (when running)
Power Source	AC 100 – 240 V (50/60 Hz)
Power consumption	AC 60 W or less (4 W or less when idle)
Dimensions	171.0 (W) × 56.0 (H) × 120.0 (D) mm (6.7 × 2.2 × 4.7 in.)
Weight	Approx. 820 g (28.9 oz.) (excluding ink and paper cassettes)

■ Compact Power Adapter CA-CP200

Input voltage	AC 100-240 V (50/60 Hz) 1.5 A (100 V) – 0.75 A (240 V)
Rated output	DC 24 V, 2.5 A
Operating temperatures	0 – 45 °C (32 – 113 °F)
Dimensions	122.0 × 60.0 × 30.5 mm (4.8 × 2.4 × 1.2 in.) (excluding cable)
Weight	Approx. 310 g (10.9 oz.)

The specifications and appearance are subject to change without notice.

Connecting the Printer to a Computer and Printing

Read Carefully Before Using!

CANON SOFTWARE LICENSE AGREEMENT

IMPORTANT – READ THIS AGREEMENT BEFORE USING THE SOFTWARE ON THE CD-ROM IN THIS BOX. BY USING THE SOFTWARE, YOU AGREE TO BE BOUND BY THE TERMS OF THIS AGREEMENT.

This is a license agreement (the “Agreement”) between you and Canon Inc. (“Canon”).

IF YOU DO NOT AGREE TO THE TERMS AND CONDITIONS OF THIS AGREEMENT, DO NOT USE THE SOFTWARE PROGRAM ON THE CD-ROM (INCLUDING ALL SOUND AND IMAGE DATA) AND THE USER MANUAL IN THIS BOX (COLLECTIVELY, THE “SOFTWARE”) AND PROMPTLY RETURN THE SOFTWARE TO YOUR POINT OF PURCHASE FOR A REFUND.

In consideration of the right to use the SOFTWARE, you agree to abide by the terms and conditions of this Agreement.

1. **LICENSE:** Canon grants you the personal, non-exclusive right to use the SOFTWARE only on a single computer. You may physically transfer the SOFTWARE from one computer to another provided that the SOFTWARE is used on only one computer at a time. You shall not install or use the SOFTWARE on a network, multiple CPU, multiple site arrangement, or any other hardware configuration where the SOFTWARE is accessible to more than one CPU or to more than one user.

With respect to the sound and image data (“Data”) contained in the Software, which are to be downloaded to the applicable Canon digital camera product, Canon grants you a personal, non-exclusive license to use the Data on a single Canon digital camera product only.

YOU SHALL NOT ASSIGN, SUBLICENSE, RENT, LEASE, LOAN, CONVEY OR OTHERWISE USE, TRANSFER, COPY, TRANSLATE, CONVERT TO ANOTHER PROGRAMMING LANGUAGE, ALTER, MODIFY, DECOMPILE OR DISASSEMBLE THE SOFTWARE, IN WHOLE OR IN PART, EXCEPT AS EXPRESSLY PROVIDED IN THIS AGREEMENT.

2. **BACK-UP COPY:** You may make one copy of the SOFTWARE solely for back-up purposes, or copy the SOFTWARE onto the permanent storage device (e.g. a hard disk) of your computer and retain the original for back-up purposes. Any other copying of the SOFTWARE is a violation of this Agreement. You must reproduce and include the copyright notice on the back-up copy.
3. **SUPPORT AND UPDATES:** Neither Canon, nor its subsidiaries, dealers or distributors will be responsible for providing maintenance or support for use of the SOFTWARE. No updates, fixes or support will be made available for the SOFTWARE.
4. **LIMITED WARRANTY AND LIMITATION OF LIABILITY:** It is your responsibility to choose, maintain and match the hardware and software components of your computer system. Thus Canon does not guarantee uninterrupted service or correction of errors or that the functions or performance of the SOFTWARE will meet your requirements. THE SOFTWARE IS LICENSED ON AN “AS IS” BASIS AND WITHOUT WARRANTY OR CONDITION OF ANY KIND. The CD-ROM storing the SOFTWARE is warranted only against defective material under normal use for a period of ninety (90) days after purchase from an authorized Canon dealer as evidenced by your sales receipt. Your sole remedy for a defective CD-ROM shall be replacement of the same without charge when returned by you at your expense to your point of purchase and proven to be defective upon inspection. The Replacement CD-ROM will be warranted for the remainder of the original ninety (90) day warranty period of the defective CD-ROM. The limited warranty does not apply if the failure of the CD-ROM resulted from accident, abuse or misapplication of the SOFTWARE and shall not extend to anyone other than the original user of the SOFTWARE.

EXCEPT AS SPECIFICALLY SET FORTH IN THIS PARAGRAPH 4, CANON, CANON’S SUBSIDIARIES, DISTRIBUTORS AND DEALERS DISCLAIM ALL WARRANTIES, OR CONDITIONS, EXPRESS OR IMPLIED, INCLUDING ANY WARRANTY OR CONDITION OF MERCHANTABILITY OR FITNESS FOR A PARTICULAR PURPOSE, WITH RESPECT TO THE SOFTWARE.

NEITHER CANON NOR ANY OF CANON’S SUBSIDIARIES, DISTRIBUTORS OR DEALERS IS LIABLE FOR ANY DAMAGES HOWSOEVER CAUSED, INCLUDING WITHOUT LIMITATION, DIRECT, CONSEQUENTIAL OR INCIDENTAL LOSS OR DAMAGE INCLUDING LOSS OF PROFITS, EXPENSE OR INCONVENIENCE HOWSOEVER CAUSED OR ARISING OUT OF THE SOFTWARE OR THE USE THEREOF.

NEITHER CANON, NOR ANY OF CANON’S SUBSIDIARIES, DISTRIBUTORS OR DEALERS SHALL HAVE ANY OBLIGATION TO INDEMNIFY YOU AGAINST ANY CLAIM OR SUIT BROUGHT BY A THIRD PARTY ALLEGING THAT THE SOFTWARE OR THE USE THEREOF INFRINGES ANY INTELLECTUAL PROPERTY OF SUCH THIRD PARTY.

SOME STATES, PROVINCES OR LEGAL JURISDICTIONS DO NOT ALLOW THE EXCLUSION OF IMPLIED WARRANTIES, OR THE LIMITATION OR EXCLUSION OF LIABILITY FOR INCIDENTAL OR CONSEQUENTIAL DAMAGES, OR PERSONAL INJURY OR DEATH RESULTING FROM NEGLIGENCE ON THE PART OF THE SELLER, SO THE ABOVE DISCLAIMERS AND EXCLUSIONS MAY NOT APPLY TO YOU.

5. **TERM:** This Agreement is effective upon your using the SOFTWARE and remains in effect until expiration of all copyright interests in the SOFTWARE unless earlier terminated. You may terminate this Agreement by destroying the SOFTWARE. This Agreement will also terminate without notice to you if you fail to comply with any of the terms of this Agreement and you must then promptly return the SOFTWARE. In addition, Canon may enforce its other legal rights.
6. **U.S. GOVERNMENT RESTRICTED RIGHTS NOTICE:**
The SOFTWARE is a "commercial item," as that term is defined at 48 C.F.R. 2.101 (Oct 1995), consisting of "commercial computer software" and "commercial computer software documentation," as such terms are used in 48 C.F.R. 12.212 (Sept 1995). Consistent with 48 C.F.R. 12.212 and 48 C.F.R. 227.7202-1 through 227.72024 (June 1995), all U.S. Government End Users shall acquire the SOFTWARE with only those rights set forth herein. Manufacturer is Canon Inc./30-2, Shimomaruko 3-chome, Ohta-ku, Tokyo 146-8501, Japan.
7. **EXPORT RESTRICTIONS:** You agree to comply with all export laws and restrictions and regulations of the country involved, and not to export or re-export, directly or indirectly, the SOFTWARE in violation of any such laws and restrictions and regulations, or without all necessary approvals.
8. **SEVERABILITY:**
In the event that any provision of this Agreement is declared or found to be illegal by any court or tribunal of competent jurisdiction, such provision shall be null and void with respect to the jurisdiction of that court or tribunal and all the remaining provisions of this Agreement shall remain in full force and effect.
9. **CONTROLLING LAW:** The terms of this Agreement as it relates to purchases of the Software in the United States of America shall be governed and construed in all respects in accordance with the laws and regulations of the State of New York, without reference to choice of law principles. The terms of this Agreement as it relates to purchases of the Software in Canada shall be governed by the laws of the province of Ontario.
10. **OWNERSHIP:** All rights, including but not limited to copyrights and trade secret rights, to the SOFTWARE belong to Canon, its affiliated corporations and third party licensors. Your use of the SOFTWARE is subject to the laws of the United States, and Canada, and other applicable copyright and trademark laws, and nothing in this Agreement constitutes a waiver of the rights of Canon, its affiliated corporations and third party licensors under such laws. You only own the CD-ROM media in which the Software is stored. Except as expressly provided herein, no license or right, express or implied, is hereby conveyed or granted by Canon to you for any intellectual property of Canon. Nothing contained in Paragraph 1 shall be construed to give Canon any ownership rights in any images, graphics or textual material that you save in connection with the Software.
You may not modify, remove or delete any or all copyright notices (i) which are contained in the Software, including any copy thereof, and (ii) which are on the original CD-ROM and on the medium of a back-up copy made pursuant to Section 2 above.
11. **ACKNOWLEDGEMENT: BY USING THE SOFTWARE, YOU ACKNOWLEDGE THAT YOU HAVE READ THIS AGREEMENT, UNDERSTOOD IT, AND AGREE TO BE BOUND BY ITS TERMS AND CONDITIONS. YOU ALSO AGREE THAT THIS AGREEMENT IS THE COMPLETE AND EXCLUSIVE STATEMENT OF AGREEMENT BETWEEN YOU AND CANON CONCERNING THE SUBJECT MATTER HEREOF AND SUPERSEDES ALL PROPOSALS OR PRIOR AGREEMENTS, VERBAL OR WRITTEN, AND ANY OTHER COMMUNICATIONS BETWEEN THE PARTIES RELATING TO THE SUBJECT MATTER HEREOF. NO AMENDMENT TO THIS AGREEMENT SHALL BE EFFECTIVE UNLESS SIGNED BY A DULY AUTHORIZED OFFICER OF CANON.**

System Requirements

Please install the software on a computer meeting the following minimum requirements.

■ Windows

OS	Windows 98 Second Edition (SE) Windows Me Windows 2000 Service Pack 4 Windows XP (including the Service Pack 1)
Computer Model	The above OS should be pre-installed on computers with built-in USB ports.
CPU	Pentium 500 MHz or higher processor
RAM	Windows 98 SE/Windows Me: 128 MB or more Windows 2000/Windows XP: 256 MB or more
Interface	USB
Free Hard Disk Space	<ul style="list-style-type: none">• Canon Utilities<ul style="list-style-type: none">- ZoomBrowser EX: 250 MB or more (including the PhotoRecord printing program)- PhotoStitch: 40 MB or more• Canon SELPHY CP400 Printer Driver: 3 MB or more (the amount of free space required for installation)
Display	1,024 × 768 pixels/High Color (16 bit) or better

■ Macintosh

OS	Mac OS X (v10.1.5 – v10.3)
Computer Model	The above OS should be pre-installed on computers with built-in USB ports.
CPU	PowerPC G3/G4/G5
RAM	256 MB or more
Interface	USB
Free Hard Disk Space	<ul style="list-style-type: none">• Canon Utilities<ul style="list-style-type: none">- ImageBrowser: 200 MB or more- PhotoStitch: 40 MB or more• Canon SELPHY CP400 Printer Driver: 3.8 MB or more (the amount of free space required for installation)
Display	1,024 × 768 pixels/32,000 colors or better



- A CD-ROM drive is required to install the software.
- All procedures performed with a connection to a USB 2.0 compliant board are not guaranteed.
- Macintosh software cannot be used on disks formatted in the UFS (Unix File System) format.

Printing Operations Overview

Follow the steps outlined below to prepare the printer and install the necessary software to enable printing.

Prepare the printer.

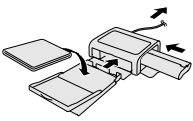

Load the paper and ink cassette into the printer and turn the printer power on.



See this guide. (p. 25 – p. 30)



Install the software and the printer driver onto the computer.

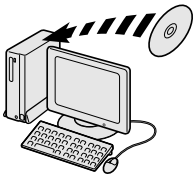

Place the supplied CP Printer Solution Disk in the computer's CD-ROM drive and install the necessary software and the printer driver.



See this guide.
Windows → p. 43
Macintosh → p. 46



Connect the printer to the computer.

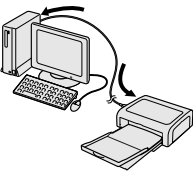

Connect the printer to the computer using a commercially available USB cable.



See this guide. (p. 49 – p. 50)



Print the image.

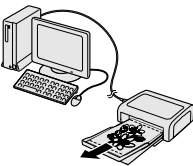

You can use the software you have installed to print images in a variety of layouts.



See the *Printer Software Guide** (PDF).

* The *Printer Software Guide* will automatically be installed to your computer together with the installation of the software. (p. 51)



- Please refer to the *Specifications* on page 37 for detailed information on USB cables.

Installing the Software and the Printer Driver

The CP Printer Solution Disk contains software that your computer will require for printing. Install the software and the printer driver according to the following steps.

■ Windows



- Be sure to install the software and the printer driver before connecting the printer to the computer.
- With Windows XP or Windows 2000, be sure to log on with Administrator privileges (computer system administrator) when installing the software.



- The instructions in this section are intended for Windows XP. If you are using another version of Windows, actual screen contents and procedures may differ slightly from those indicated here.

1

Close any programs that are running.

2

Place the CP Printer Solution Disk in the CD-ROM drive.

- The installer panel automatically appears.

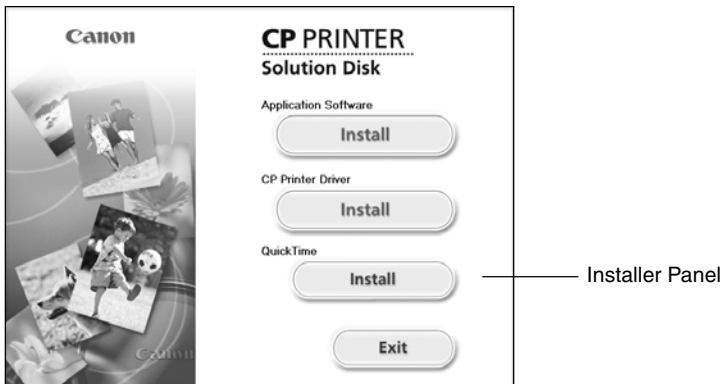

If the installer panel does not automatically appear, use the following procedure to start it.

- For Windows XP, click the [Start] button and select [My Computer], double-click the CD-ROM icon in the next window.
- For Windows 98/Me/2000, double-click the [My Computer] icon on the desktop, and double-click the CD-ROM icon in the next window.

3

Click the Application Software [Install] button and click [Next].

4 Select [Easy Installation] as the setup type and click [Next].

- Select [Custom Installation] to select programs for individual installation.

5 Click [Yes] if you consent to all the conditions of the software license agreement.

6 Review the installation settings and click [Next].

- Follow the screen messages to proceed.
- Restart your computer when a dialog box appears instructing you to do so.
- When the installation is complete, the installer panel will appear.

Next, install the printer driver to your computer.

7 Click the CP Printer Driver [Install] button.



If the installer panel does not automatically appear, use the following procedure to start it.

- For Windows XP, click the [Start] button and select [My Computer], double-click the CD-ROM icon in the next window.
- For Windows 98/Me/2000, double-click the [My Computer] icon on the desktop, and double-click the CD-ROM icon in the next window.

8 Click the printer you are using and click [Next].

9 Click [Yes] if you consent to all the conditions of the software license agreement.

- The installer starts.

10 When the screen below appears, connect the printer to the computer with a USB cable.

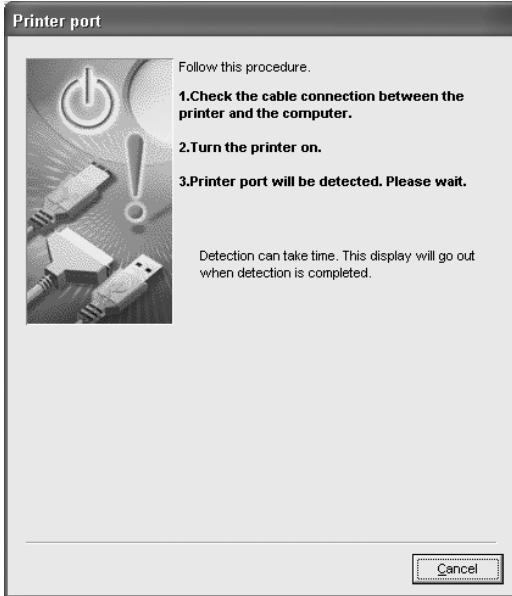

- Refer to *Connecting the Printer to Your Computer* (p. 49) on how to connect.
- Follow the screen messages to proceed.

11 When the installation is complete, click [Exit], and then remove the CP Printer Solution Disk from the CD-ROM drive.

- Restart your computer when a dialog box appears instructing you to do so.
-

■ Macintosh



- Be sure to install the software and the printer driver before connecting the printer to the computer.



- The instructions in this section are intended for Mac OS X (v10.1). If you are using another version of Mac OS, actual screen contents and procedures may differ slightly from those indicated here.

1 Quit any programs that are running.

2 Place the CP Printer Solution Disk in the CD-ROM drive, and double-click the [Canon CP Printer Installer] icon in the CD-ROM.

- The installer panel automatically appears.

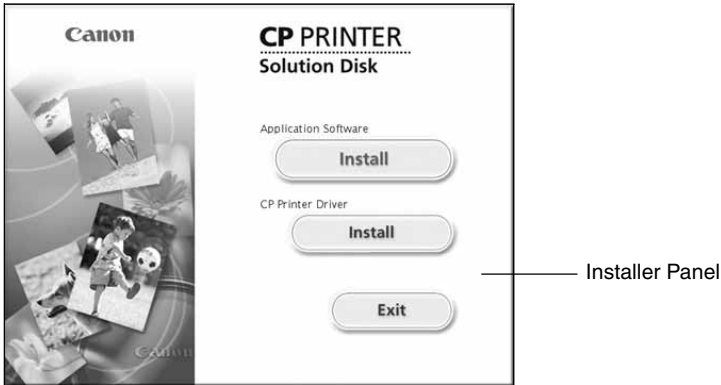

3 Click the Application Software [Install] button.

4 Select [Easy Installation] and then click [Next].

- Select [Custom Installation] to select programs for individual installation.

5 Click [Agree] if you consent to all the conditions of the software license agreement.

6 Review the installation settings and click [Next].

- Follow the screen messages to proceed.
 - When the installation is complete, the installer panel will appear.
-

Next, install the printer driver to your computer.

7 Click the CP Printer Driver [Install] button.



8 Click the printer you are using.

9 Click [Agree] if you consent to all the conditions of the software license agreement.

- The installer starts.

10 Select [Easy Install], and then click the [Install] button.

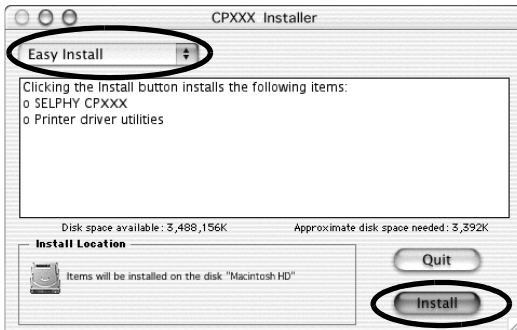

- Follow the screen messages to proceed.
- Restart your computer when a dialog box appears instructing you to do so.

11 Remove the CP Printer Solution Disk from the CD-ROM drive.

Next, register your printer on the Printer List

12 Turn the printer power on, then connect the printer to the computer with the USB cable.

- For directions on connecting the printer, see *Connecting the Printer to Your Computer* (p. 49).

13 Double-click the hard disk icon where Mac OS X is installed.

14 Double-click the [Print Center] or [Printer Setup Utility] icon in [Applications] ▶ [Utilities] folder.

- The [Printer List] window appears.

15 Click the [Add Printer] or [Add] button.

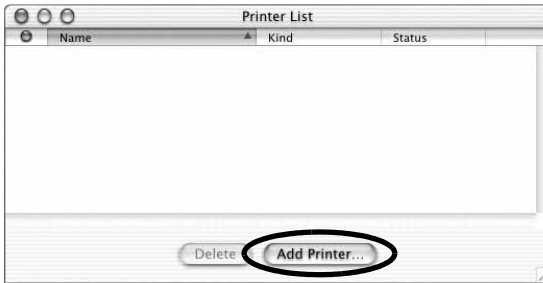

16 Select [USB], select the printer name, and then click the [Add] button.

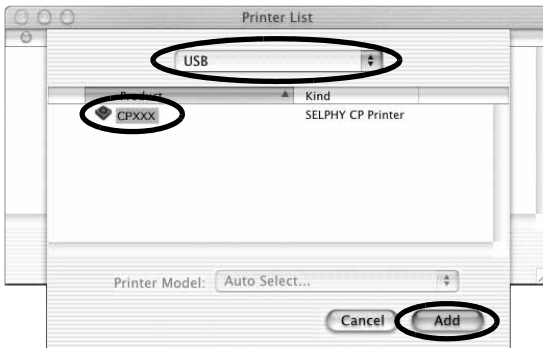

17 Close the window by clicking  in the upper left-hand corner.

Connecting the Printer to Your Computer

■ Notes about connection

In using the USB cable, be sure to connect the printer directly to your computer.

If you connect the USB cable via a USB hub, the printer may not function properly.

Do not use other USB devices (with the exception of a USB mouse or keyboard) with the printer. The printer may not function properly.

Disconnect the other USB devices from your computer and then reconnect the printer.

Do not connect two or more direct print compatible printers (all CP series printers) to the same computer.

The printers may not function properly.

When connecting the printer to your computer, we recommend that you connect it to the same USB port you used to install the printer driver.

If you connect the printer to a different USB port, Windows may create a copy of the printer driver. This depends on your Windows version and the printer driver, and does not affect the operation of the printer.

To delete a copy of the printer driver, proceed as follows:

1. Disconnect the USB cable from your computer.
 2. Delete the copy of the printer driver as follows (do not use the uninstaller.)
 - (1) For Windows 98/Me/2000, click the [Start] button and select [Settings], and [Printers].
For Windows XP, click the [Start] button and select [Control Panel], [Printers and Other Hardware], and [Printers and Faxes].
 - (2) Right-click the copy of the printer driver and then select [Delete] on the short-cut menu.
 3. Restart your computer. Connect the printer to the USB port you used to install the printer driver.
-



- Do not put your computer into the standby mode (or sleep mode) while the printer is connected to a USB port.
- If you accidentally do so, do not disconnect the USB cable from your computer while it is in the standby mode; instead, leaving the USB cable connected, first return your computer to its normal mode. If you remove the USB cable while your computer is in the standby mode, your computer may not be able to return to its normal mode. For details on your computer's standby mode, refer to the documentation provided with your computer.

1

Connect one end of a commercially available USB cable (sold separately) to the USB port on the printer, and the other end to a USB port on your computer.

- There is no need to turn off the printer or your computer.
- When connecting the printer to your computer, make sure the connectors on the ends of the USB cable match the ports on the printer and your computer.
- For the location and direction of your computer's USB port, refer to the documentation provided with your computer.

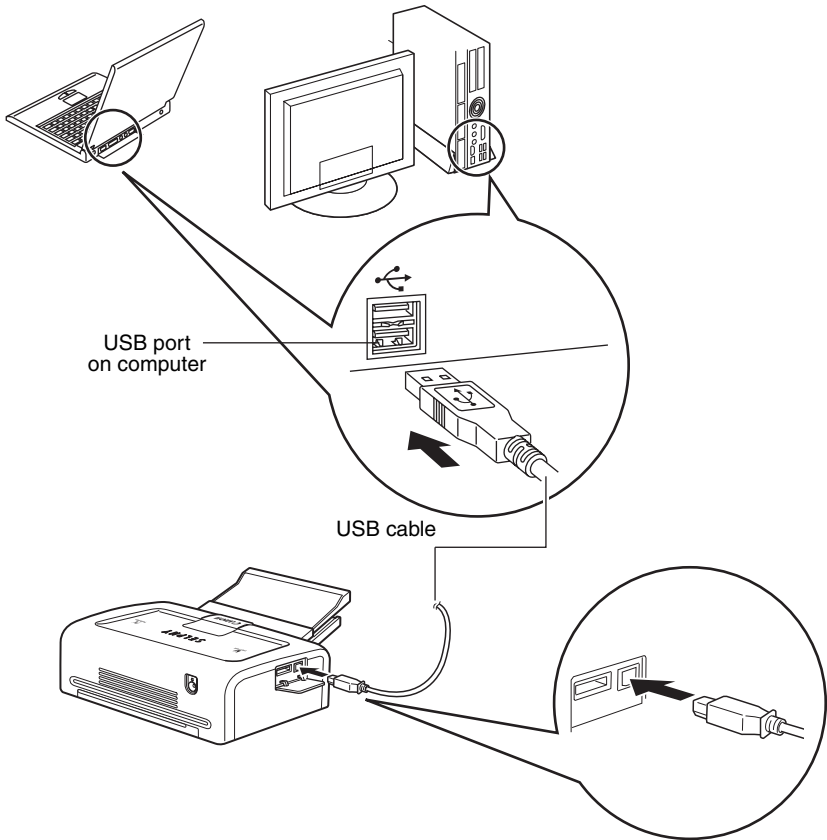

- When disconnecting the USB cable, you do not need to turn off the printer or your computer.

Viewing the PDF Manuals



- Adobe Reader or Adobe Acrobat Reader must be installed to view the PDF Manuals. If this software is not installed in your computer, access the following web site and download the software.

<http://www.adobe.com/products/acrobat/readstep2.html>

■ Printer Software Guide

1 Install the software from the CP Printer Solution Disk. (Windows → p. 43, Macintosh → p. 46)

- The *Printer Software Guide* will automatically be installed to your computer, and the  [CP Printer Guide] icon appears on the desktop.

2 Double-click [CP Printer Guide].

- *Printer Software Guide* will be displayed.



- If you need the *Printer Software Guide* in a different language:

Windows/Macintosh: Double-click the desired language folder in the [Readme] folder on the CD-ROM, then double-click [CP Printer User Guide.pdf].

■ ZoomBrowser EX Software User Guide / ImageBrowser Software User Guide

To view the *ZoomBrowser EX Software User Guide* (Windows) and the *ImageBrowser Software User Guide* (Macintosh), access the following site and download.

<http://web.canon.jp/Imaging/information-e.html>

Uninstalling the Software

This section describes how to uninstall the software.



- Uninstall the software when it is no longer needed, or if a problem occurs and uninstalling becomes necessary. Note that if you uninstall the software, you will not be able to use it anymore.

■ Windows

The instructions in this section are intended for uninstallation of ZoomBrowser EX.

1

Click the [Start] button and select [Programs] or [All Programs], [Canon Utilities], [ZoomBrowser EX], and [ZoomBrowser EX Uninstall].

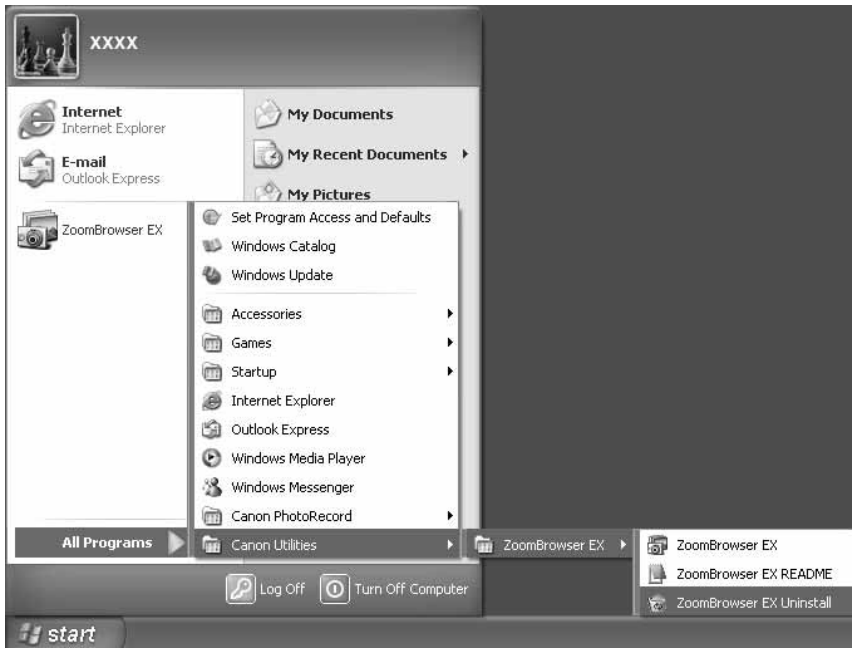

- Uninstallation begins and ZoomBrowser EX is removed.



- You can use the same procedure to uninstall PhotoStitch.
- To uninstall PhotoRecord, click the [Start] button and select [Programs] or [All Programs], [Canon PhotoRecord], and [PhotoRecord Uninstall].

■ Macintosh

Uninstall the programs by dragging the application's folder (the folder in which it was installed) into the Trash, and then empty the Trash.



- Please be careful not to accidentally delete any folders with downloaded images that may be contained within the application folder.

Uninstalling the Printer Driver

This section describes how to uninstall the printer driver.



- Uninstall the printer driver if it is no longer needed, or if a problem occurs and uninstalling becomes necessary. Note that if you uninstall the printer driver, you will no longer be able to use the printer to print.

Be sure to follow the procedures described in this section to uninstall the printer.

■ Windows

- 1** Click the [Start] and select [Programs] or [All Programs], [Canon SELPHY CPXXX], [Uninstall].

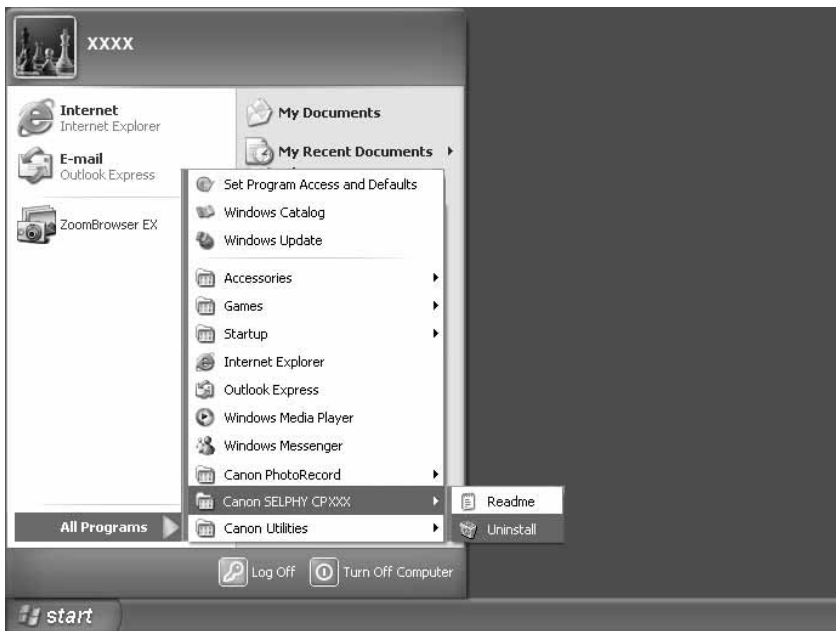

- 2** Select the printer you will uninstall and click [Next].
 - Follow the screen messages to proceed.

■ Macintosh

1 Place the CP Printer Solution Disk in the CD-ROM drive, and double-click the [Canon CP Printer Installer] icon.

- The installer panel appears.

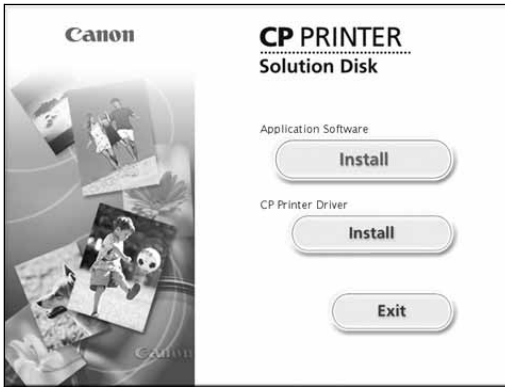

2 Click the CP Printer Driver [Install] button.

3 Click the printer you wish to uninstall.

4 Click [Agree] if you consent to all the conditions of the software license agreement.

5 Select [Uninstall], and then click the [Uninstall] button.

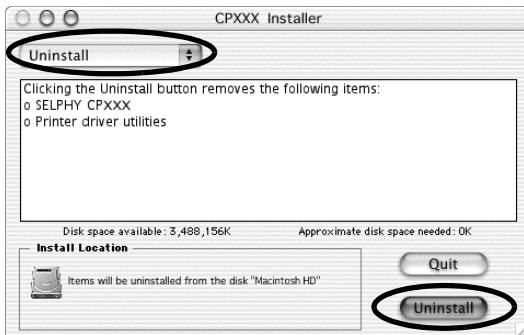

- Follow the screen messages to proceed.

6 Click the [Continue] button to automatically close any applications other than the uninstaller.

7 When the uninstallation is complete, click [Quit], and then remove the CP Printer Solution Disk from the CD-ROM drive.

Next, delete the printer from the Printer List.

8 Double-click the hard disk icon where Mac OS X is installed.

9 Double-click the [Print Center] or [Printer Setup Utility] icon in [Applications] ▶ [Utilities] folder.

- The [Printer List] window appears.
-

10 Select the printer you uninstalled, and then click the [Delete] button.

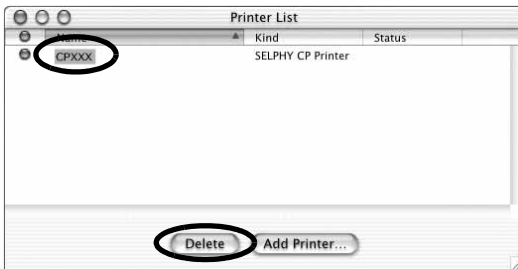

11 Close the window by clicking  in the upper left-hand corner.

Printing with Non-Canon Digital Cameras

Since the CP400 printers support the direct print *PictBridge** standard, you can connect *PictBridge* compliant non-Canon digital cameras to easily print high image quality photos.

* *PictBridge*: *PictBridge* is an industry standard for direct printing that allows you to print images without using a computer by directly connecting a digital camera or digital camcorder (hereafter “camera”) to a printer, regardless of their brands and models.

■ Before Using the Printer

Please read carefully the user guide that came with your camera and make sure that:

- **The camera is *PictBridge* compliant.**
- You are using the USB cable for the camera/computer connection to connect the printer to the camera. (This cable may be included with the camera)
- You set the print settings with the camera. For details, refer to the camera’s user guide.

■ Connecting the Camera

Insert one end of the USB cable used for the camera/computer connection in the printer’s direct print port (see p. 29) and insert the other end in the camera’s terminal. (For details, refer to the camera’s user guide)

- The printer’s display window blinks blue several times once the printer and camera are correctly connected. The display window lights steadily blue once it is ready to print.
- If a problem occurs during a connection or during printing, the printer’s display window lights or blinks red. If this happens, the error message that appears on the camera’s LCD monitor may differ according to your camera model.

■ Printing Functions

When printing with non-Canon cameras, the following items differ from Canon-camera printing operations.

Functions Available with Non-Canon Cameras

- This option allows you to print the specified number of multiple images on a single sheet of paper.
- This option allows you to fix images at a size smaller than the paper they will be printed on, allowing you to write in the resulting blank area.
- Printing different selected images on an 8-label sheet.
- If you connect a camera which has an automatic image enhancement function to the printer, the image is automatically adjusted for even more beautiful prints. (With Canon Cameras, the image is adjusted without using this function.)

You can use these options if they are supported by your camera.

❑ Functions Not Available with Non-Canon Cameras

- Printing indexes with the file name.



- Printing speed may differ according to your camera model and the image's number of recorded pixels. (The value written on page 37 is a printing speed obtained when printing with a Canon camera.)

Disclaimer

- While every effort has been made to ensure that the information contained in this guide is accurate and complete, no liability can be accepted for any errors or omissions. Canon reserves the right to change the specifications of the hardware and software described herein at any time without prior notice.
- No part of this guide may be reproduced, transmitted, transcribed, stored in a retrieval system, or translated into any language in any form, by any means, without the prior written permission of Canon.
- Canon makes no warranties for damages resulting from corrupted or lost data due to a mistaken operation or malfunction of the camera, the printer, the software, the CompactFlash™ cards (CF cards), personal computers, peripheral devices, or use of non-Canon CF cards.

Trademark Acknowledgments

- Canon and SELPHY are trademarks of Canon Inc.
- Adobe is a trademark of Adobe Systems Incorporated.
- CompactFlash is a trademark of SanDisk Corporation.
- Macintosh, Mac OS and QuickTime are trademarks of Apple Computer Inc., registered in the United States and other countries.
- Microsoft® and Windows® are either registered trademarks or trademarks of Microsoft Corporation in the United States and/or other countries.
- Other names and products not mentioned above may be registered trademarks or trademarks of their respective companies.

FCC Notice

(Printer, Model CD1012/CD1013)

This device complies with Part 15 of the FCC Rules. Operation is subject to the following two conditions;

- (1) this device may not cause harmful interference, and
- (2) this device must accept any interference received, including interference that may cause undesired operation.

Note: This equipment has been tested and found to comply with the limits for Class B digital devices, pursuant to Part 15 of the FCC rules. These limits are designed to provide reasonable protection against harmful interference in a residential installation. This equipment generates, uses and can radiate radio frequency energy and, if not installed and used in accordance with the instructions, may cause harmful interference to radio communications. However, there is no guarantee that interference will not occur in a particular installation. If this equipment does cause harmful interference to radio or television reception, which can be determined by turning the equipment off and on, the user is encouraged to try to correct the interference by one or more of the following measures:

- Reorient or relocate the receiving antenna.
- Increase the separation between the equipment and receiver.
- Connect the equipment into an outlet on a circuit different from that to which the receiver is connected.
- Consult the dealer or an experienced radio/TV technician for help.

Use of shielded cable with the ferrite core provided with the Printer is required to comply with Class B limits in Subpart B of Part 15 of the FCC rules.

Do not make any changes or modifications to the equipment unless otherwise specified in the manual. If such changes or modifications should be made, you could be required to stop operation of the equipment.

Canon U.S.A. Inc.

One Canon Plaza, Lake Success, NY 11042, U.S.A.

Tel No. (516) 328-5600

Canadian Radio Interference Regulations

This Class B digital apparatus complies with Canadian ICES-003.

Réglementation canadienne sur les interférences radio

Cet appareil numérique de la classe B est conforme à la norme NMB-003 du Canada.