



Light Piano

YPP-100

Owner's Manual

SPECIAL MESSAGE SECTION

This product utilizes batteries or an external power supply (adapter). DO NOT connect this product to any power supply or adapter other than one described in the manual, on the name plate, or specifically recommended by Yamaha.

WARNING: Do not place this product in a position where anyone could walk on, trip over, or roll anything over power or connecting cords of any kind. The use of an extension cord is not recommended! If you must use an extension cord, the minimum wire size for a 25' cord (or less) is 18 AWG. NOTE: The smaller the AWG number, the larger the current handling capacity. For longer extension cords, consult a local electrician.

This product should be used only with the components supplied or; a cart, rack, or stand that is recommended by Yamaha. If a cart, etc., is used, please observe all safety markings and instructions that accompany the accessory product.

SPECIFICATIONS SUBJECT TO CHANGE:

The information contained in this manual is believed to be correct at the time of printing. However, Yamaha reserves the right to change or modify any of the specifications without notice or obligation to update existing units.

This product, either alone or in combination with an amplifier and headphones or speaker/s, may be capable of producing sound levels that could cause permanent hearing loss. DO NOT operate for long periods of time at a high volume level or at a level that is uncomfortable. If you experience any hearing loss or ringing in the ears, you should consult an audiologist.

IMPORTANT: The louder the sound, the shorter the time period before damage occurs.

Some Yamaha products may have benches and / or accessory mounting fixtures that are either supplied with the product or as optional accessories. Some of these items are designed to be dealer assembled or installed. Please make sure that benches are stable and any optional fixtures (where applicable) are well secured BEFORE using. Benches supplied by Yamaha are designed for seating only. No other uses are recommended.

NOTICE:

Service charges incurred due to a lack of knowledge relating to how a function or effect works (when the unit is operating as designed) are not covered by the manufacturer's warranty, and are therefore the owners responsibility. Please study this manual carefully and consult your dealer before requesting service.

ENVIRONMENTAL ISSUES:

Yamaha strives to produce products that are both user safe and environmentally friendly. We sincerely believe that our products and the production methods used to produce them, meet these goals. In keeping with both the letter and the spirit of the law, we want you to be aware of the following:

Battery Notice:

This product MAY contain a small non-rechargeable battery which (if applicable) is soldered in place. The average life span of this type of battery is approximately five years. When replacement becomes necessary, contact a qualified service representative to perform the replacement.

This product may also use "household" type batteries. Some of these may be rechargeable. Make sure that the battery being charged is a rechargeable type and that the charger is intended for the battery being charged.

When installing batteries, do not mix batteries with new, or with batteries of a different type. Batteries MUST be installed correctly. Mismatches or incorrect installation may result in overheating and battery case rupture.

Warning:

Do not attempt to disassemble, or incinerate any battery. Keep all batteries away from children. Dispose of used batteries promptly and as regulated by the laws in your area. Note: Check with any retailer of household type batteries in your area for battery disposal information.

Disposal Notice:

Should this product become damaged beyond repair, or for some reason its useful life is considered to be at an end, please observe all local, state, and federal regulations that relate to the disposal of products that contain lead, batteries, plastics, etc. If your dealer is unable to assist you, please contact Yamaha directly.

NAME PLATE LOCATION:

The name plate is located on the bottom of the product. The model number, serial number, power requirements, etc., are located on this plate. You should record the model number, serial number, and the date of purchase in the spaces provided below and retain this manual as a permanent record of your purchase.

Model

Serial No.

Purchase Date

PLEASE KEEP THIS MANUAL

92-BP (bottom)

FCC INFORMATION (U.S.A.)

1. IMPORTANT NOTICE: DO NOT MODIFY THIS UNIT!

This product, when installed as indicated in the instructions contained in this manual, meets FCC requirements. Modifications not expressly approved by Yamaha may void your authority, granted by the FCC, to use the product.

2. IMPORTANT:

When connecting this product to accessories and/or another product use only high quality shielded cables. Cable/s supplied with this product MUST be used. Follow all installation instructions. Failure to follow instructions could void your FCC authorization to use this product in the USA.

3. NOTE:

This product has been tested and found to comply with the requirements listed in FCC Regulations, Part 15 for Class "B" digital devices. Compliance with these requirements provides a reasonable level of assurance that your use of this product in a residential environment will not result in harmful interference with other electronic devices. This equipment generates/uses radio frequencies and, if not installed and used according to the instructions found in the users manual, may cause interference harmful to the operation of other electronic devices. Compliance with FCC

regulations does not guarantee that interference will not occur in all installations. If this product is found to be the source of interference, which can be determined by turning the unit "OFF" and "ON", please try to eliminate the problem by using one of the following measures:

Relocate either this product or the device that is being affected by the interference.

Utilize power outlets that are on different branch (circuit breaker or fuse) circuits or install AC line filter/s.

In the case of radio or TV interference, relocate/reorient the antenna. If the antenna lead-in is 300 ohm ribbon lead, change the lead-in to co-axial type cable.

If these corrective measures do not produce satisfactory results, please contact the local retailer authorized to distribute this type of product. If you can not locate the appropriate retailer, please contact Yamaha Corporation of America, Electronic Service Division, 6600 Orangethorpe Ave, Buena Park, CA90620

The above statements apply ONLY to those products distributed by Yamaha Corporation of America or its subsidiaries.

* This applies only to products distributed by YAMAHA CORPORATION OF AMERICA.

(class B)

OBSERVERA!

Apparaten kopplas inte ur växelströmskällan (nätet) så länge som den är ansluten till vägguttaget, även om själva apparaten har stängts av.

ADVARSEL: Netspændingen til dette apparat er IKKE afbrudt, så længe netledningen sidder i en stikkontakt, som er tændt — også selvom der er slukket på apparatets afbryder.

VAROITUS: Laitteen toisiopiiriin kytketty käyttökytkin ei irroita koko laitetta verkosta.

(standby)

PRECAUTIONS

PLEASE READ CAREFULLY BEFORE PROCEEDING

* Please keep this manual in a safe place for future reference.



WARNING

Always follow the basic precautions listed below to avoid the possibility of serious injury or even death from electrical shock, short-circuiting, damages, fire or other hazards. These precautions include, but are not limited to, the following:

Power supply/AC power adaptor

- Only use the voltage specified as correct for the instrument. The required voltage is printed on the name plate of the instrument.
- Use the specified adaptor (PA-5D, PA-5C or an equivalent recommended by Yamaha) only. Using the wrong adaptor can result in damage to the instrument or overheating.
- Check the electric plug periodically and remove any dirt or dust which may have accumulated on it.
- Do not place the AC adaptor cord near heat sources such as heaters or radiators, and do not excessively bend or otherwise damage the cord, place heavy objects on it, or place it in a position where anyone could walk on, trip over, or roll anything over it.

Do not open

- Do not open the instrument or attempt to disassemble the internal parts or modify them in any way. The instrument contains no user-serviceable parts. If it should appear to be malfunctioning, discontinue use immediately and have it inspected by qualified Yamaha service personnel.

Water warning

- Do not expose the instrument to rain, use it near water or in damp or wet conditions, or place containers on it containing liquids which might spill into any openings.
- Never insert or remove an electric plug with wet hands.

Fire warning

- Do not put burning items, such as candles, on the unit. A burning item may fall over and cause a fire.

If you notice any abnormality

- If the AC adaptor cord or plug becomes frayed or damaged, or if there is a sudden loss of sound during use of the instrument, or if any unusual smells or smoke should appear to be caused by it, immediately turn off the power switch, disconnect the adaptor plug from the outlet, and have the instrument inspected by qualified Yamaha service personnel.



CAUTION

Always follow the basic precautions listed below to avoid the possibility of physical injury to you or others, or damage to the instrument or other property. These precautions include, but are not limited to, the following:

Power supply/AC power adaptor

- When removing the electric plug from the instrument or an outlet, always hold the plug itself and not the cord.
- Unplug the AC power adaptor when not using the instrument, or during electrical storms.
- Do not connect the instrument to an electrical outlet using a multiple-connector. Doing so can result in lower sound quality, or possibly cause overheating in the outlet.

Location

- Do not expose the instrument to excessive dust or vibrations, or extreme cold or heat (such as in direct sunlight, near a heater, or in a car during the day) to prevent the possibility of panel disfiguration or damage to the internal components.
- Do not use the instrument in the vicinity of a TV, radio, stereo equipment, mobile phone, or other electric devices. Otherwise, the instrument, TV, or radio may generate noise.
- Do not place the instrument in an unstable position where it might accidentally fall over.
- Before moving the instrument, remove all connected adaptor and other cables.
- Use only the stand specified for the instrument. When attaching the stand, use the provided screws only. Failure to do so could cause damage to the internal components or result in the instrument falling over.

Connections

- Before connecting the instrument to other electronic components, turn off the power for all components. Before turning the power on or off for all components, set all volume levels to minimum. Also, be sure to set the volumes of all components at their minimum levels and gradually raise the volume controls while playing the instrument to set the desired listening level.

Maintenance

- When cleaning the instrument, use a soft, dry cloth. Do not use paint thinners, solvents, cleaning fluids, or chemical-impregnated wiping cloths.

Handling caution

- Never insert or drop paper, metallic, or other objects into the gaps on the panel or keyboard. If this happens, turn off the power immediately and unplug the power cord from the AC outlet. Then have the instrument inspected by qualified Yamaha service personnel.
- Do not place vinyl, plastic or rubber objects on the instrument, since this might discolor the panel or keyboard.
- Do not rest your weight on, or place heavy objects on the instrument, and do not use excessive force on the buttons, switches or connectors.
- Do not operate the instrument for a long period of time at a high or uncomfortable volume level, since this can cause permanent hearing loss. If you experience any hearing loss or ringing in the ears, consult a physician.

Saving data

Saving and backing up your data

- Internal data is retained for about 1 week after the power is turned off. If the period is exceeded, the data will be lost. Be sure to turn the power switch on for a few minutes at least once a week. The data could be lost due to malfunction or incorrect operation. Save important data to external media such as the Yamaha MDF3 MIDI data filer.

Backing up the floppy disk

- To protect against data loss through media damage, we recommend that you save your important data onto two floppy disks.

Yamaha cannot be held responsible for damage caused by improper use or modifications to the instrument, or data that is lost or destroyed.

Always turn the power off when the instrument is not in use.

Even when the power switch is in the "STANDBY" position, electricity is still flowing to the instrument at the minimum level. When you are not using the instrument for a long time, make sure you unplug the AC power adaptor from the wall AC outlet.

* The illustrations and LED displays as shown in this owner's manual are for instructional purposes only, and may be different from the ones on your instrument.

● COPYRIGHT NOTICE

This product incorporates and bundles computer programs and contents in which Yamaha owns copyrights or with respect to which it has license to use others' copyrights. Such copyrighted materials include, without limitation, all computer software, styles files, MIDI files, WAVE data and sound recordings. Any unauthorized use of such programs and contents outside of personal use is not permitted under relevant laws. Any violation of copyright has legal consequences. **DON'T MAKE, DISTRIBUTE OR USE ILLEGAL COPIES.**

Introduction

Thank you for choosing a Yamaha Light Piano YPP-100. Your YPP-100 is a fine musical instrument that employs advanced Yamaha music technology. With the proper care, your YPP-100 will give you many years of musical pleasure.

- The YPP-100 utilizes Yamaha's "AWM Stereo Sampling" tone generating Light Piano technology to produce musically rich voices of unmatched sonic realism. The piano voices are created with newly recorded samples taken from a full concert grand piano.
- Dual mode allows 2 voices to be played simultaneously.
- Metronome feature with variable tempo facilitates practice.
- 2-track digital recorder lets you record and play back anything you play on the keyboard.
- MIDI compatibility and a range of MIDI functions make the YPP-100 useful in a range of advanced MIDI music systems.

In order to make the most of your YPP-100's performance potential and features, we urge you to read this Owner's Manual thoroughly, and keep it in a safe place for later reference.

■ Trademarks

- Apple and Macintosh are trademarks of Apple Computer, Inc., registered in the U.S. and other countries. All other trademarks are the property of their respective holders.

Included Accessories

- Owner's Manual
- Music Rest
- FC5 Footswitch (x1)
- Keyboard Stand

Contents

The Control Panel	8	F3 Dual Mode Functions	28
Setting Up	10	F3.1: Dual Balance	28
■ Power supply connections	10	F3.2: Dual Detune	28
■ Accessory Jacks	10	F3.3: 1st Voice Octave Shift	28
■ Music Rest	11	F3.4: 2nd Voice Octave Shift	28
Selecting & Playing Voices	12	F3.5: 1st Voice Effect Depth	29
Playing the Demonstration Tunes	13	F3.6: 2nd Voice Effect Depth	29
■ Voice Demo	13	F3.7: Reset	29
■ Preset Song	14	■ F4 Soft Pedal Mode	29
■ Preset Song A-B Repeat	15	■ F5 Metronome Volume	29
■ Preset Song Part Cancel	16	■ F6 Preset Song Part Cancel Volume	29
• Synchro Start	16	■ F7 MIDI Functions	30
• Soft Pedal Start/Stop	16	F7.1: MIDI Transmit Channel Selection	30
The Dual Mode	17	F7.2: MIDI Receive Channel Selection	30
• Other Dual Mode Functions	17	F7.3: Local Control ON/OFF	31
Reverb	18	F7.4: Program Change ON/OFF	31
• Adjusting Reverb Depth	18	F7.5: Control Change ON/OFF	32
The Effect	19	F7.6: MIDI Transmit Transpose	32
• Adjusting Effect Depth	19	F7.7: Panel/Status Transmit	32
Touch Sensitivity	20	F7.8: Bulk Data Dump	32
Transposition	21	■ F8 Backup Functions	33
The Metronome & Tempo Control	22	F8.1: Voice	33
■ The Metronome	22	F8.2: MIDI	33
• Metronome Time Signature	22	F8.3: Tuning	33
• Metronome Volume Function	22	F8.4: Pedal	33
■ Tempo Control	22	Using the MIDI Functions	34
Using the User Song Recorder	23	■ What Is MIDI?	34
■ Recording	23	■ Connecting to a Personal Computer	36
• Changing the Initial Settings	24	Factory Preset Recall	37
• Erasing a Single Track	24	Troubleshooting	37
■ Playback	25	Options	37
• Synchro Start	25	Voice Descriptions	38
• Soft Pedal Start/Stop	25	Demo and Preset Song List	39
The Function Mode	26	Factory Setting List	40
• To Select a Function	26	MIDI Data Format	41
■ F1 Tuning	27	MIDI Implementation Chart	45
■ F2 Scale	27	Keyboard Stand Assembly	46
F2.1: Scale	27	Specifications	49
F2.2: Base Note	27		

The Control Panel

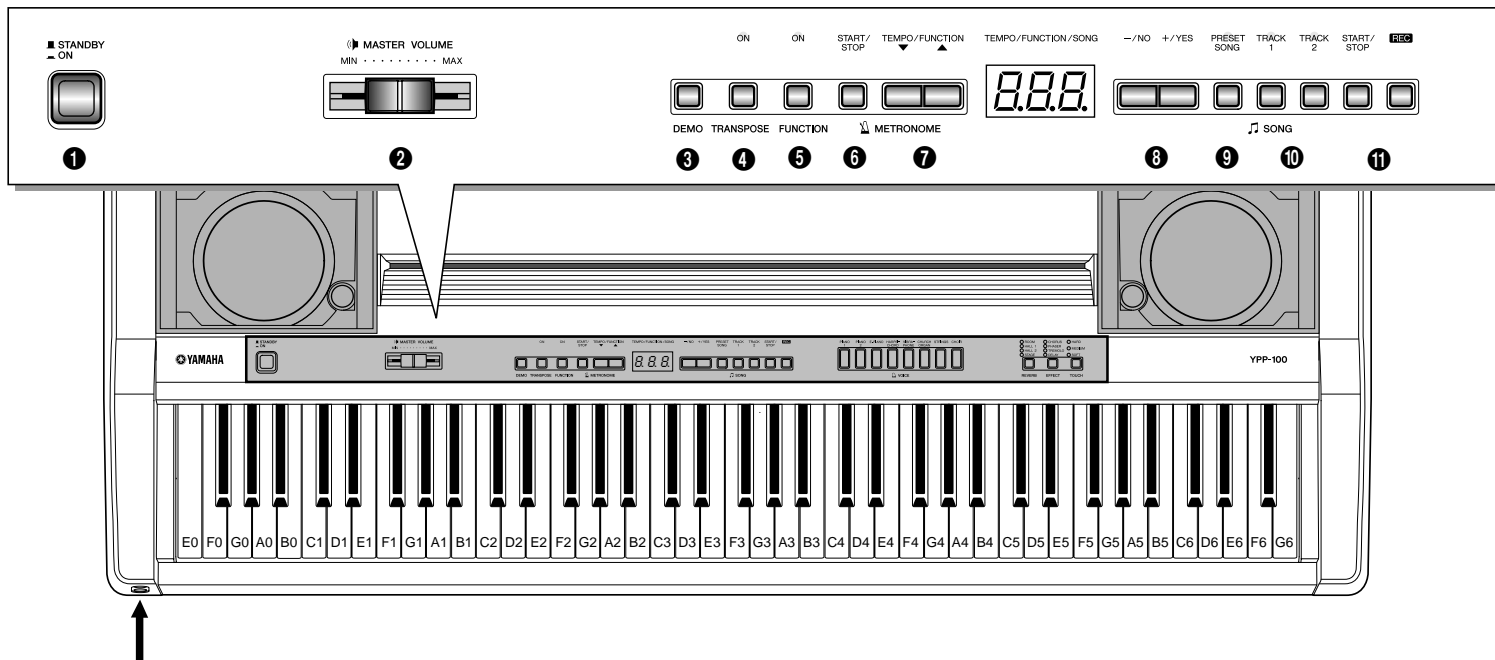

The PHONES jacks are located on the front panel, below the left end of the keyboard. (see page 11)

1 [STANDBY/ON] Switch

Press the [STANDBY/ON] switch once to turn the power ON, a second time to turn the power OFF. When the power is initially turned ON, a voice selector LED will light.

2 [MASTER VOLUME] Control

The [MASTER VOLUME] control adjusts the volume (level) of sound produced by the YPP-100's internal stereo sound system. The [MASTER VOLUME] control also adjusts headphone volume when a pair of headphones is plugged into the PHONES jack (page 11).

3 [DEMO] Button

Activates the demo playback mode in which you can select playback of different demonstration sequences for each of the YPP-100's voices. See page 13 for details.

4 [TRANPOSE] Button

The [TRANPOSE] button allows access to the YPP-100's TRANPOSE function (to shift the pitch of the entire keyboard up or down in semitone intervals).

5 [FUNCTION] Button

This button accesses a range of utility functions — including the MIDI functions — that significantly enhance versatility and playability. See page 26 for details.

6 METRONOME [START/STOP] Button

Turns the metronome sound on and off. The [TEMPO/FUNCTION ▼, ▲] buttons are used to set the tempo of the metronome sound. The [-/NO] and [+ /YES] buttons are used to change the time signature (beat) of the metronome if used while the METRONOME [START/STOP] button is held — page 22.

7 [TEMPO/FUNCTION ▼, ▲] Buttons

These buttons adjust the tempo of the metronome function as well as the playback tempo of the recorder function. The tempo range is from 32 to 280 beats per minute — page 22. These same buttons are also used to select functions — page 26.

8 [-/NO], [+ /YES] Buttons

These buttons select a preset song number for playback, and are also used to adjust a range of other parameters.

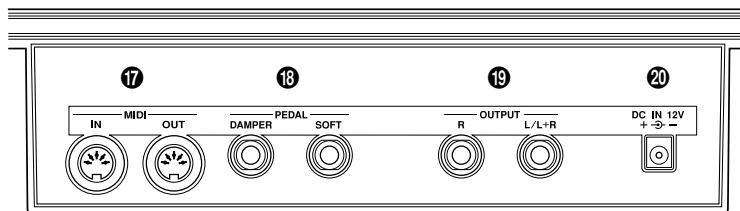
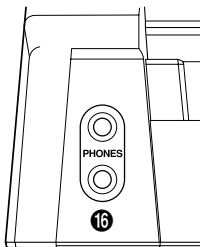
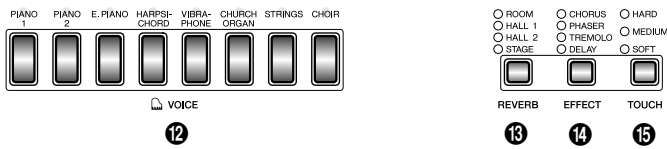

9 [PRESET SONG] Button

This button enters the preset song mode. While in this mode you can use the [-/NO] and [+YES] buttons to select from 20 songs.

10 TRACK [1] and [2] Buttons

The YPP-100 has a 2-track recorder, and these buttons are used to select the track(s) to be recorded or played back. See page 23 for details.

11 SONG [START/STOP] and [REC] Buttons

These buttons control the YPP-100's user song recorder, letting you record and play back just about anything you play on the keyboard.

12 Voice Selectors

Simply press any of the voice selectors to select the corresponding voice. The voice selector LED will light to indicate which voice is currently selected.

There is also a dual mode in which two voices can be played simultaneously across the full range of the keyboard (see page 17 for details).

13 [REVERB] Button

The [REVERB] button selects a number of digital reverb effects that you can use for extra depth and expressive power. See page 18 for details.

14 [EFFECT] Button

This button selects a number of effects which can give your sound greater depth and animation.

15 [TOUCH] Button

The [TOUCH] button makes it easy to adjust the touch response of the YPP-100 to match your playing style. See page 20 for details.

16 PHONES Jacks

... See page 11 for details.

17 MIDI IN/OUT Connectors

... See page 11 for details.

18 PEDAL DAMPER/SOFT Jacks

... See page 11 for details.

19 OUTPUT R and L/L+R Jacks

... See page 10 for details.

20 DC IN 12V Jack

... See page 10 for details.

Power supply connections

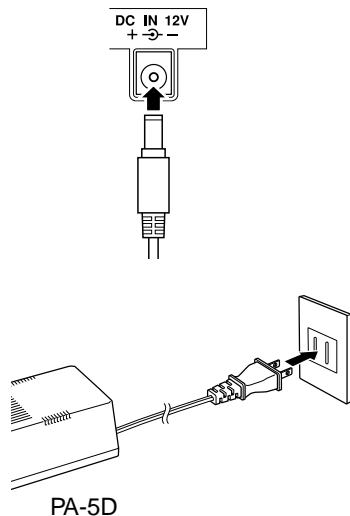

Using An AC Power Adaptor

- 1** Make sure that the STANDBY/ON switch of the YPP-100 is set to STANDBY.
- 2** Connect the AC adaptor (PA-5D, PA-5C or other adaptor specifically recommended by Yamaha) to the power supply jack.
- 3** Plug the AC adaptor into an AC outlet.

CAUTION

- Never interrupt the power supply (e.g. unplug the AC adaptor) during any YPP-100 record operation! Doing so can result in a loss of data.

WARNING

- Use **ONLY** a Yamaha PA-5D or PA-5C AC Power Adaptor (or other adaptor specifically recommended by Yamaha) to power your instrument from the AC mains. The use of other adaptors may result in irreparable damage to both the adaptor and the YPP-100.
- Unplug the AC Power Adaptor when not using the YPP-100, or during electrical storms.
- Plugging or unplugging the AC power adaptor will reset the YPP-100 to the defaults.

Accessory Jacks

- CAUTION** • Before connecting the YPP-100 to other electronic components, turn off the power for all components. Before turning the power on or off for all components, set all-volume levels to minimum.

Using the OUTPUT R and L/L+R Jacks

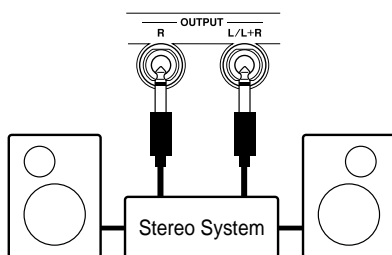

The OUTPUT R and L/L+R jacks deliver the output of the YPP-100 for connection to an instrument amplifier, mixing console, PA system, or recording equipment. If you will be connecting the YPP-100 to a monaural sound system, use only the L/L+R jack. When a plug is inserted into the L/L+R jack only, the left- and right-channel signals are combined and delivered via the L/L+R jack so you don't lose any of the YPP-100's sound.

CAUTION

- When the YPP-100's OUTPUT jacks are connected to an external sound system, first turn the YPP-100 power on, and then the power to the external amplifier/speaker system. Reverse this order when turning the power off.

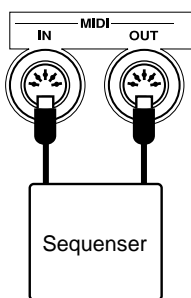

Using the MIDI IN and OUT Connectors

The MIDI IN connector receives MIDI data from an external MIDI device which can be used to control the YPP-100. The MIDI OUT connector transmits MIDI data generated by the YPP-100 (e.g. note and velocity data produced by playing the YPP-100 keyboard).

More details on MIDI are given in “MIDI Functions” on page 30.

Using the Damper Pedal (connect a footswitch to the DAMPER Jack)

A footswitch connected to the DAMPER jack will basically function in the same way as a damper pedal on an acoustic piano. When the footswitch is pressed, notes played will have a long sustain. Releasing the footswitch immediately stops (dampens) any sustained notes.



- Be sure that you do not press the footswitch while turning the power on. If you do, the ON/OFF status of the footswitch will be reversed.
- If the Damper function doesn't work, or notes are sustained even when the footswitch is not pressed, make sure that the pedal is properly plugged into the DAMPER Jack.

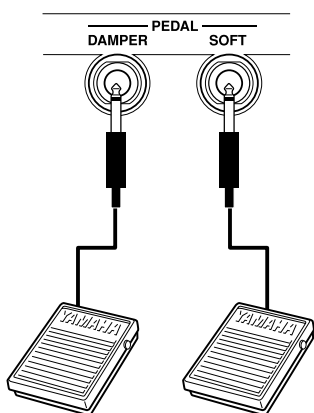

Using the Soft Pedal (connect a footswitch to the SOFT Jack)

A footswitch connected to the SOFT jack reduces the volume and slightly changes the timbre of notes played while the footswitch is pressed. The soft pedal function will not affect notes that are already sustaining when the footswitch is pressed.

This footswitch can also be assigned to function as a start/stop switch with the “Soft Pedal Mode” described on page 29.

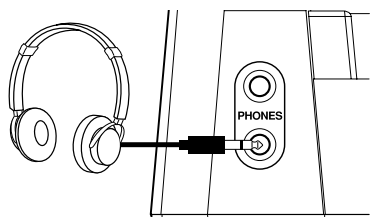

Using the PHONES Jacks

Two sets of standard stereo headphones can be plugged in here for private practice or late-night playing. The internal speaker system is automatically shut off when a pair of headphones is plugged into either of the PHONES jacks.

Music Rest

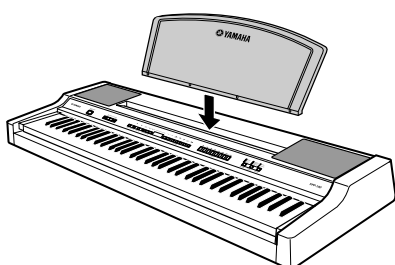

The YPP-100 is supplied with a music rest that can be attached to the instrument by inserting it into the slot at the rear of the control panel.

Selecting & Playing Voices

1 Turn Power On



With the AC power adaptor connected, simply press the [STANDBY/ON] switch until it locks in the ON position. When the instrument is not in use, be sure to turn the power off. (Press the switch again so that it pops up.)

CAUTION

- Even when the switch is in the "STANDBY" position, electricity is still flowing to the instrument at the minimum level. When you are not using the YPP-100 for a long time, make sure you unplug the AC power adaptor from the wall AC outlet.

2 Set the Volume

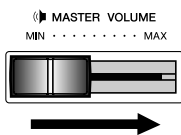

Initially set the [MASTER VOLUME] control about half way between the "MIN" and "MAX" settings. Then, when you start playing, re-adjust the [MASTER VOLUME] control for the most comfortable listening level.

3 Select a Voice

Select the desired voice by pressing one of the voice selectors.



- See "Voice Descriptions" on page 38.

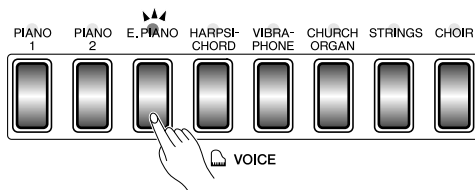

4 Play

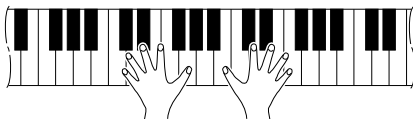

The YPP-100 also offers keyboard touch response, so the volume and timbre of notes played can be controlled according to how "hard" you play the keys. The amount of variation available depends on the selected voice.



- Some voices do not have keyboard touch response. See "Voice Descriptions" on page 38 for details.

5 Add Effects As Required

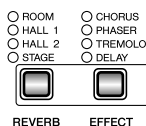

You can add or change reverb and effects as desired by using the [REVERB] button (page 18) and [EFFECT] button (page 19).

Playing the Demonstration Tunes

Demonstration tunes are provided that effectively demonstrate each of the YPP-100's voices. There are also 20 preset songs that you can play individually, all in sequence, or in random order. Here's how you can select and play the demo tunes.



- The demo or preset song mode cannot be engaged while a user song recorder (page 23) is in use.
- No MIDI reception occurs in the demo/preset song mode.
- The demo/preset song data is not transmitted via the MIDI connectors.

* See page 39 for a complete listing of the demo tunes and preset songs.

Voice Demo

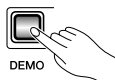

1 Engage the Demo Mode

Press the [DEMO] button to engage the demo mode — the voice selector indicators will flash in sequence.

2 Play a Voice Demo

Press one of the voice selectors to start playback of all songs starting from the corresponding voice demo tune — featuring the voice normally selected by that voice selector button. (If you press the **SONG [START/STOP]** button instead of a voice selector button, the PIANO 1 demo tune will begin playback.) The indicator of the selected voice selector button will flash during playback, and “- - -” will appear on the LED display. You can start playback of any other voice demo tune during playback by simply pressing the corresponding voice selector. You can stop playback at any time by pressing the **SONG [START/STOP]** button or the voice selector of the currently playing demo.

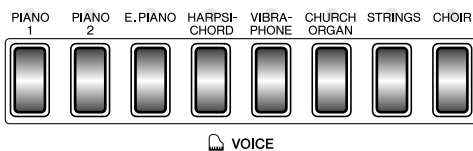

- Use the [MASTER VOLUME] control to adjust the volume.



3 Exit From the Demo Mode

Press the [DEMO] button to exit from the demo mode and return to the normal play mode.

Playing the Demonstration Tunes

Preset Song

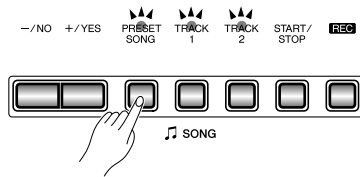

1 Engage the Preset Song Mode

Press the [PRESET SONG] button to engage the preset song mode — the [PRESET SONG], TRACK [1] and [2] indicators will light.

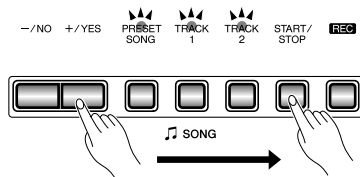

2 Play a Preset Song

To play any of the 20 preset songs provided, use the [-/NO], [+ /YES] buttons to select the number of the tune you want to play (the number will appear on the LED display), then press the SONG [START/STOP] button. Playback will stop automatically when playback of the selected preset song has finished.

Select “RL L” instead of a number to play all preset songs in sequence, or select “r n d” to continuously play all preset songs in random order. Press the SONG [START/STOP] button to stop playback.

TEMPO/FUNCTION/SONG

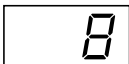

NOTE

- Use the [MASTER VOLUME] control to adjust the volume.
- You can use the [TEMPO/FUNCTION ▼,▲] buttons to adjust the playback tempo as required. This produces a relative tempo variation, with a range from “-50” through “- - -” to “50” at maximum; the range will differ depending on the selected song.
- The default tempo “- - -” is automatically selected whenever a new preset song is selected, or playback of a new preset song begins during “RL L” or “r n d” playback.
- You can play the keyboard along with the preset song playback. The voice playing on the keyboard can be changed.
- You can change the Reverb type that is applied to the voice you play on the keyboard and for the preset song playback. You can change the Effect type and Touch sensitivity that is applied to the voice you play on the keyboard. When a new preset song is selected or a new preset song is automatically started in continuous play, the HALL 1 reverb type will automatically be selected.

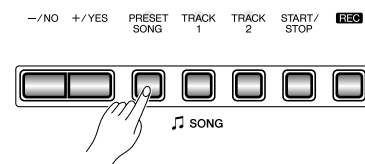

3 Exit From the Preset Song Mode

Press the [PRESET SONG] button to exit from the preset song mode, the indicator will go off, and return to the normal play mode.

Preset Song A-B Repeat

The A-B Repeat function can be used to continuously repeat a specified phrase within a preset song. Combined with the Part Cancel function described below, this provides an excellent way to practice difficult phrases.

1] Specify the Beginning (A) of the Phrase

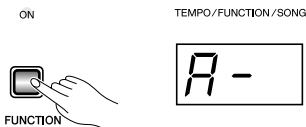

Select and play a preset song, then press the [FUNCTION] button at the beginning of the phrase you want to repeat. This sets the “A” point (“A-” will appear on the display).

To set the “A” point at the very beginning of the song, press the [FUNCTION] button before starting playback.

2] Specify the End (B) of the Phrase

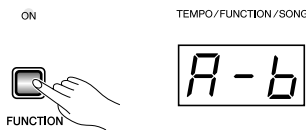

Press the [FUNCTION] button a second time at the end of the phrase. This sets the “B” point (“A-b” will appear on the display). At this point repeat playback will begin between the specified A and B points. The metronome will sound when playback begins to give you a tempo reference. However, if playback repeats from the beginning of the song, there will be no tempo reference from metronome.

To set the B point at the song’s end, press the [FUNCTION] button after song playback is complete and before “A-” disappears from the display.

3] Stop Playback.....

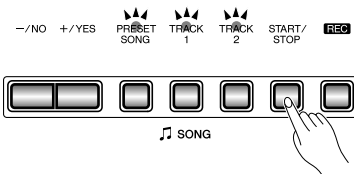

Press the **SONG** [START/STOP] button to stop playback while retaining the specified A and B points. A-B repeat playback will resume if the **SONG** [START/STOP] button is then pressed again.

To cancel the A and B points press the [FUNCTION] button once.



NOTE

- The A and B points are automatically canceled when a new song is selected.
- The A-B Repeat function cannot be used during “RL” or “rd” playback.

Preset Song Part Cancel

The 20 preset songs have separate left- and right-hand parts that can be turned on and off as required so you can practice the corresponding part on the keyboard. The right-hand part is played by **TRACK [1]** track, and the left-hand part is played by **TRACK [2]** track.

1 Turn the Desired Part Off

Press the **TRACK [1]** or **[2]** button to turn the corresponding part off — the corresponding indicator will go out (these buttons alternately toggle the corresponding part on and off).



- The parts can be turned on or off even during playback.
- The Preset Song Part Cancel function cannot be used during “RL L” or “r n d” playback.
- The “Preset Song Part Cancel Volume” function described on page 29 can be used to set the canceled part so that it plays at a volume from “0” (no sound) to “20”. The default setting is “5”.
- Both parts are automatically turned ON whenever a new song is selected.

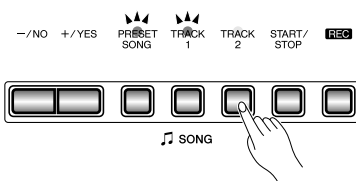

2 Start/Stop Playback

Press the **SONG [START/STOP]** button to start and stop playback as required.

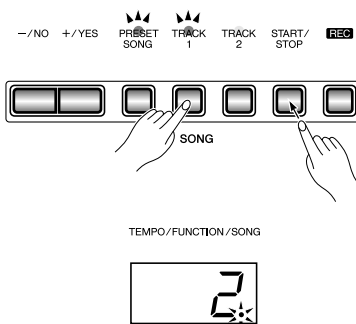
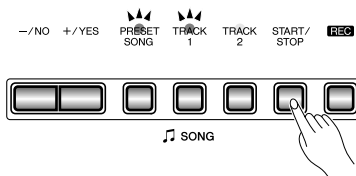

□ Synchro Start

When the Synchro Start function is engaged, playback of the selected preset song will begin automatically as soon as you start playing on the keyboard.

To engage the Synchro Start function press the **SONG [START/STOP]** button while holding the part button corresponding to the part which is ON. A dot will appear in the lower right corner of the display. (Repeat the previous operation to disengage the Synchro Start function.)

Playback will then start as soon as you begin playing on the keyboard.



- If you hold a track button which is OFF while pressing the **SONG [START/STOP]** button, that track will be turned ON and the Synchro Start mode will be engaged.

□ Soft Pedal Start/Stop

A footswitch connected to the **SOFT** jack can be used to start and stop playback of a preset song using the “Soft Pedal Mode” function described on page 29.

The Dual Mode

The dual mode makes it possible to play two voices simultaneously across the entire range of the keyboard.

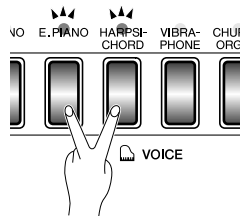

Voice numbering priority

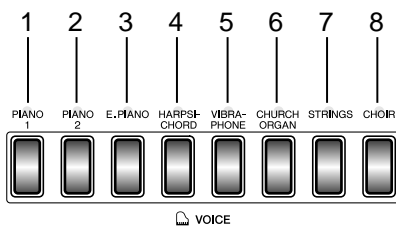

To activate the dual mode simply press two voice selectors at the same time (or press one voice selector while holding another). The voice indicators of both selected voices will light when the dual mode is active. To return to the normal single-voice play mode, press any single voice selector.

According to the voice numbering priority as shown in the diagram on the left, lower valued voice numbers will be designated as the 1st Voice (the other voice will be designated as the 2nd Voice).

NOTE

• [EFFECT] in the Dual Mode

Depending upon the conditions one effect type will take priority over the other. Depth will be decided according to the depth default value of the voice combination. However, using function F3 (see page 28) you can change the depth value for each voice as you like.

Effect depth setting via the panel controls (i.e. pressing the [–/NO] or [+ /YES] buttons while holding the [EFFECT] button — see page 19) will be applied to the 1st Voice only.

• [REVERB] in the Dual Mode

The reverb type assigned to the 1st Voice will take priority over the other. (If the reverb is set to OFF, the 2nd Voice's reverb type will be in affect.)

Reverb depth setting via the panel controls (i.e. pressing the [–/NO] or [+ /YES] buttons while holding the [REVERB] button — see page 18) will be applied to the 1st Voice only.

Other Dual Mode Functions

The YPP-100 Function mode provides access to a number of other dual-mode functions, listed below. See the corresponding pages for details.

- Dual Balance 28
- Dual Detune 28
- 1st Voice Octave Shift 28
- 2nd Voice Octave Shift 28
- 1st Voice Effect Depth 29
- 2nd Voice Effect Depth 29
- Reset 29

Reverb

The **[REVERB]** button selects a number of digital reverb effects that you can use for extra depth and expressive power.

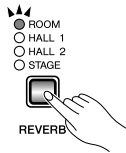

To select a reverb type press the **[REVERB]** button a few times until the indicator corresponding to the desired type lights (the indicators light in sequence each time the **[REVERB]** button is pressed). No reverb is produced when all indicators are off.

OFF

No reverb effect is selected when no REVERB indicator is lit.

ROOM

This setting add a continuous reverb effect to the sound that is similar to the type of acoustic reverberation you would hear in a room.

HALL 1

For a “bigger” reverb sound, use the HALL 1 setting. This effect simulates the natural reverberation of a small-size concert hall.

HALL 2

For a really spacious reverb sound, use the HALL 2 setting. This effect simulates the natural reverberation of a large concert hall.

STAGE

A simulation of the type of reverb produced in a stage environment.



• *The default reverb type (including OFF) and depth settings are different for each voice.*

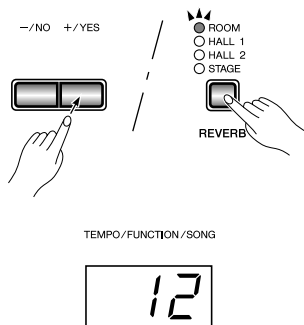

Adjusting Reverb Depth

Adjust the reverb depth for the selected voice by using the **[-/NO]** and **[+/YES]** buttons while holding the **[REVERB]** button. The depth range is from 0 through 20 (the current depth setting appears on the LED display while the **[REVERB]** button is held). A setting of “0” produces no effect, while a setting of “20” produces maximum reverb depth. Press the **[-/NO]** and **[+/YES]** buttons simultaneously while holding the **[REVERB]** button to recall the default setting for the current voice (default depth settings are different for each voice).

The Effect

The **[EFFECT]** button allows you to select one of the effects that can give your sound greater depth and animation.



To select an effect type press the **[EFFECT]** button a few times until the indicator corresponding to the desired type lights (the indicators light in sequence each time the **[EFFECT]** button is pressed). No effect is produced when all indicators are off.

OFF

No effect is selected when no EFFECT indicator is lit.

CHORUS

Shimmering, broadening effect

PHASER

Adds depth to the sound.

TREMLOLO

Tremolo effect

DELAY

Echo effect



• The default effect type (including OFF) and depth settings are different for each voice.

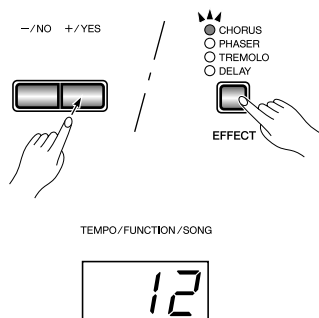

Adjusting Effect Depth.....

Effect depth can be individually adjusted for the selected voice by using the **[-/NO]** and **[+ /YES]** buttons while holding the **[EFFECT]** button. The depth range is from 0 through 20 (the current depth setting appears on the LED display while the **[EFFECT]** button is held). A setting of “0” produces no effect, while a setting of “20” produces maximum effect depth. Press the **[-/NO]** and **[+ /YES]** buttons simultaneously while holding the **[EFFECT]** button to recall the default setting for the current voice (the default depth settings are different for each voice).

Touch Sensitivity

Four different types of keyboard touch sensitivity — HARD, MEDIUM, SOFT or FIXED — can be selected to match different playing styles and preferences.

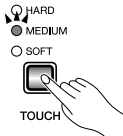

To select a touch sensitivity type press the [TOUCH] button a few times until the indicator corresponding to the desired type lights (the indicators light in sequence each time the [TOUCH] button is pressed).

HARD

The HARD setting requires the keys to be played quite hard to produce maximum loudness.

MEDIUM

The MEDIUM setting produces a fairly “standard” keyboard response. This is the initial factory default setting.

SOFT

The SOFT setting allows maximum loudness to be produced with relatively light key pressure.

FIXED (no indicator lit)

All notes are produced at the same volume no matter how hard the keyboard is played.

When the FIXED type is selected, the volume of notes played in the FIXED mode can be set by using the [–/NO] and [+ /YES] buttons while the [TOUCH] button is held (the current volume level appears on the display). The volume range is from 1 through 127. The default setting is 80.



- This setting does not change the weight of the keyboard.
- The touch sensitivity type and volume set in the FIXED mode will become the common setting for all voices. However, the touch sensitivity settings may have little or no effect with certain voices which are not normally responsive to keyboard dynamics (Refer to the “Voice Descriptions” on page 38).

Transposition

The YPP-100's TRANSPOSE function makes it possible to shift the pitch of the entire keyboard up or down in semitone intervals up to a maximum of 12 semitones (i.e. a maximum of one octave up or down). "Transposing" the pitch of the YPP-100 keyboard facilitates playing in difficult key signatures, and you can easily match the pitch of the keyboard to the range of a singer or other instrumentalist.

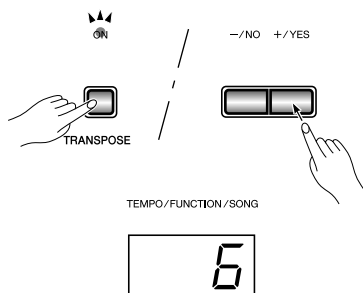

Use the [-/NO] or [+ /YES] button while holding the [TRANSPOSE] button to transpose down or up as required. The transposition range is from “-12” (down one octave) through “0” (normal pitch) to “12” (up one octave). The amount of transposition appears on the LED display while the [TRANSPOSE] button is held. The default transpose setting is “0”.

NOTE

- The [TRANSPOSE] button indicator remains lit when a transpose setting other than “0” is selected.
- If the transposed note exceeds the A-1 ... C7 range, the note will be sounded one octave higher or lower.

The Metronome & Tempo Control

The YPP-100 built-in metronome is a convenient feature for practice, and it can also provide a solid rhythmic guide when recording using the User Song Recorder feature, described in the next section.

The Metronome

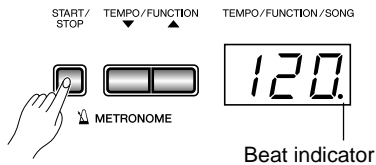

The metronome sound is alternately turned on and off by pressing the **METRONOME** [**START/STOP**] button. When on, the beat indicator flashes at the current tempo.

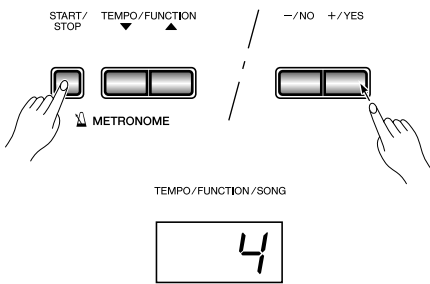

Metronome Time Signature

The time signature (beat) of the metronome can be set by using the **[-/NO]** and **[+/YES]** buttons while holding the **METRONOME** [**START/STOP**] button. You can set the beat to 0, 2, 3, 4, 5 or 6 (the current setting appears on the LED display while the **METRONOME** [**START/STOP**] button is held). Press the **[-/NO]** and **[+/YES]** buttons simultaneously while holding the **METRONOME** [**START/STOP**] button to recall the default setting “0” (no accent).

Metronome Volume Function

The volume of the metronome sound can be adjusted via the Metronome Volume function in the Function mode—page 29.

Tempo Control

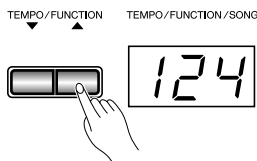

The tempo of the metronome and user song recorder playback (the recorder is described in the next section) can be set from 32 to 280 beats per minute by using the **[TEMPO/FUNCTION ▼, ▲]** buttons. The selected tempo will appear on the LED display while in the normal play mode and while the **[TEMPO/FUNCTION ▼, ▲]** buttons are being used to adjust the tempo in the recording/playback mode. The default tempo (120 or the recorded song tempo when the recorder contains data and the playback track indicator is lit) can be recalled by simultaneously pressing the **[▼]** and **[▲]** buttons.

Using the User Song Recorder

The ability to record and play back what you've played on the YPP-100 keyboard can be an effective practice aid. You can, for example, record just the left-hand part, and then practice the right-hand part while playing back the recorded left-hand part. Or, since you can record up to two tracks separately, you could record the left- and right-hand parts separately, or record both parts of a duet and hear how they sound when played back.

The user song recorder actually records the following data:

■ **Entire Song**

- Tempo
- Time signature (beat)
- Reverb type (including OFF)
- Effect type

■ **Individual Tracks**

- Notes played
- Dual mode voices
- Soft pedal
- Dual balance (F3)
- Voice selection
- Damper pedal
- Effect depth
- Dual detune (F3)
- Reverb depth
- Dual octave shift (F3)

Recording

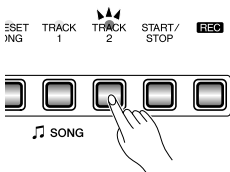
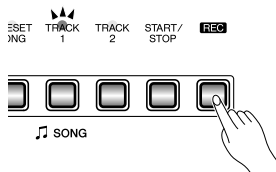
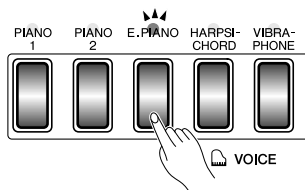

1) Make All Necessary Initial Settings

Before actually beginning to record, select the voice you want to record with (or voices if you will be using the dual or split mode). You might also want to set the volume and tempo controls.

2) Engage the Record Ready Mode

Press the [REC] button to engage the record ready mode (recording does not actually start yet). The record ready mode can be disengaged before recording by pressing the [REC] button a second time.



- The record ready mode cannot be engaged while the demo/preset song mode is engaged.

3) Select the Record Track

When the record mode is engaged in the previous step, the last-recorded track will automatically be selected for recording and its indicator — i.e. the **TRACK [1]** or **[2]** button indicator — will glow red. If you want to record on a different track, press the appropriate track button so that its indicator glows red.



- The track button indicators of tracks which contain previously recorded data will glow green (unless the track is turned off as described below). The previously-recorded data on the non-record track will normally be played back as you record, so you can play along with a previously-recorded track. If you don't want to hear the previously recorded track as you record (when you want to record a song different from what you recorded on the previous track etc.), press the playback track button before pressing the [REC] button (step 1, above) so that its indicator goes out.
- Recording on a track which already contains data will erase all previous data on that track.
- When the record mode is engaged the amount of memory available for recording will be shown on the LED display in approximate kilobytes (starting at "50"), and the rightmost dot on the LED display will flash at the current METRONOME tempo setting.

Using the User Song Recorder

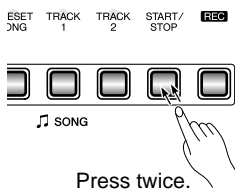
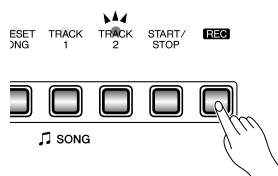
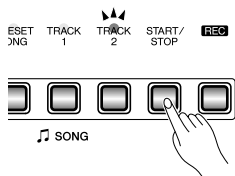
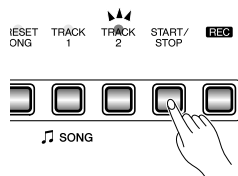
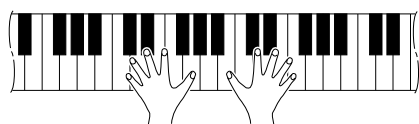

4 Start Recording

Recording will begin automatically as soon as you play a note on the keyboard or press the **SONG [START/STOP]** button. The current measure number will appear on the display while recording.



- A footswitch connected to the **SOFT** jack can be assigned to function as a start/stop switch for song recording with the "Soft Pedal Mode" described on page 29.
- If the metronome was on when you started recording, you'll be able to keep time with the metronome while recording, but the metronome sound will not be recorded.
- You can record up to a maximum of about 10,000 notes on the YPP-100, depending on pedal usage and other factors. The record track indicator will begin to flash when recorder memory is almost full. If the memory becomes full during recording, "FUL" will appear on the display and recording will stop automatically. (All recorded data up to that point will be retained.)

5 Stop Recording

Press either the **[REC]** or **SONG [START/STOP]** button to stop recording.

The indicator of the recorded track will glow green to indicate that it now contains data.

Changing the Initial Settings

The initial voice, tempo, reverb type, reverb depth, and effect settings made in step 1 of the recording procedure are actually recorded by the YPP-100.

These initial settings can be changed after the recording is finished by pressing the **[REC]** button to engage the record ready mode, pressing the appropriate track button, making the required changes, and then pressing the **[REC]** button again to exit from the record ready mode and register the changes.

If you do this, be careful not to press the **SONG [START/STOP]** button or a key on the keyboard, either of which will start recording and erase all previous recorded data on the selected track.

It is possible to cancel the operation even after changes have been made: change tracks and then press the **[REC]** button to exit from the record mode (this also cancels data for the entire song).



- The following data for initial settings cannot be changed: "Dual balance (F3)", "Dual detune (F3)" or "Dual octave shift (F3)".

Erasing a Single Track

All data can be erased from either of the recorder's tracks by engaging the record mode, selecting the track you want to erase, and then pressing the **SONG [START/STOP]** button twice without recording any data.

Playback

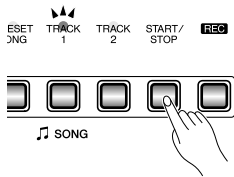

To play back what you've recorded, first make sure that the green track indicators of the tracks you want to play are lit. If not, press the corresponding track button(s) so that they are lit. Then press the **SONG [START/STOP]** button. Playback starts from the beginning of the recorded data, and will stop automatically at the end of the recorded data. You can also stop playback at any time by pressing the **SONG [START/STOP]** button.

To mute a track so that it doesn't play back, press the corresponding track button so that its indicator goes out (press again to turn the track back on).

The current measure number appears on the display during playback.

NOTE

- It is possible to play along on the keyboard during playback. In this case, the playback voice and the voice you play on the keyboard are not the same. The playback voice is the voice that was set when the data was recorded. The voice you play on the keyboard is the voice that is selected on the panel.
- The playback volume and tempo can be adjusted by using the [MASTER VOLUME] control and [TEMPO/FUNCTION ▼, ▲] buttons (press both [TEMPO/FUNCTION ▼, ▲] buttons simultaneously to recall the default tempo).
- All user song recorder data will be retained in memory for about one week after the power is turned off. If you want to keep your recorded data for longer periods, turn the power on for a few minutes at least once a week. It is also possible to store it to an external MIDI storage device such as the Yamaha MIDI Data Filer MDF3 by using the Bulk Data Dump function described on page 32.
- The track indicators will not light automatically when the power is turned on even if the user song recorder contains data. It is therefore necessary to press the track buttons so that the corresponding green indicators light before starting recorder playback. It is also a good idea to press the track buttons to check if the tracks contain data before recording. If the green indicator lights when the corresponding track button is pressed, that track contains data which will be erased and replaced by the newly-recorded data.
- If the metronome is being used during playback, the metronome will automatically stop when playback is stopped.
- During recorder playback, the volume of a track which is turned off will always be "0" (i.e. the "Preset Song Part Cancel Volume" function — page 29 — only affects preset song playback).
- The playback data is not transmitted via the MIDI OUT connector.
- Playback cannot be started when the demo/preset song mode is engaged.
- Playback cannot be started when the recorder contains no data, or when both track buttons are off.
- If the REVERB type is changed via the panel controls during playback, both the playback and keyboard reverb effects will be changed.
- If the EFFECT type is changed via the panel controls during playback, the playback effect may be switched off in some cases.

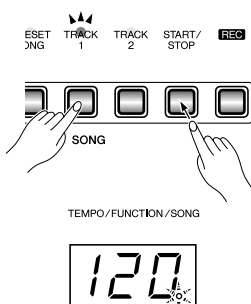

Synchro Start

When the Synchro Start function is engaged, recorder playback will begin automatically as soon as you start playing on the keyboard.

To engage the Synchro Start function press the **SONG [START/STOP]** button while holding a track button which is ON. The rightmost dot on the display will flash at the current tempo. (Repeat the previous operation to disengage the Synchro Start function.) Playback will then start as soon as you begin playing on the keyboard.

If you hold a track button which is OFF while pressing the **SONG [START/STOP]** button, that track will be turned ON and the Synchro Start mode will be engaged.

Soft Pedal Start/Stop

A footswitch connected to the SOFT jack can be assigned to start or stop recorder playback using the "Soft Pedal Mode" function described on page 29. This is convenient for starting playback of the recorded part anytime after you have started playing.

The Function Mode

The **[FUNCTION]** button provides access to a range of functions that give the YPP-100 extraordinary versatility. The functions are categorized in groups as follows:

F1	Tuning	27
F2	Scale	27
F3	Dual Mode Functions	28
F4	Soft Pedal Mode	29
F5	Metronome Volume	29
F6	Preset Song Part Cancel Volume	29
F7	MIDI Functions	30
F8	Backup Functions	33

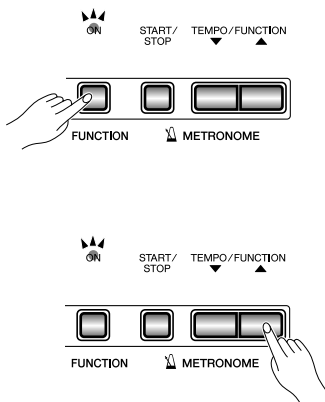

● Operation Example

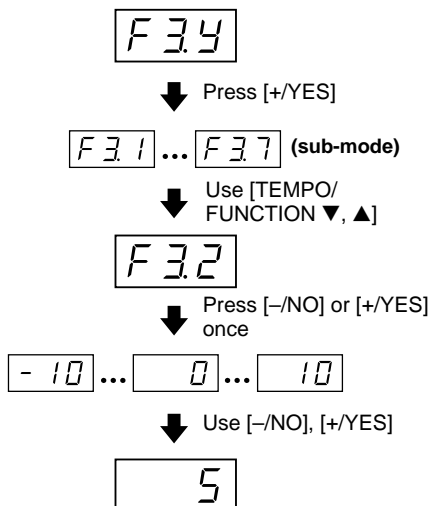

To Select a Function ...

- Press the **[FUNCTION]** button so that its indicator lights.
 - NOTE** • Functions cannot be selected during demo/preset song playback or when the user song recorder is in operation.
- Use the **[TEMPO/FUNCTION ▼, ▲]** buttons to select the desired function: F1 through F8.
- In the case of the Scale (F2), Dual Mode (F3), MIDI (F7), and Backup (F8) functions, you will have to press the **[+ / YES]** button once to enter the respective sub-mode after the function has been selected, and then use the **[TEMPO/FUNCTION ▼, ▲]** buttons again to select the desired sub-function.
 - NOTE** • The Dual mode must be engaged before the F3 function can be selected. If the Dual mode is not engaged, "F 3 -" will appear on the display and the sub-mode will not be available.
- Set the function as required by using the **[- / NO]** and **[+ / YES]** buttons (see the individual function descriptions, below).
 - NOTE** • After selecting the function, the current setting will be displayed when the **[- / NO]** or **[+ / YES]** button is pressed for the first time.
- Press the **[FUNCTION]** button so that its indicator goes out to exit from the function mode.

F1 Tuning

After selecting “*F 1*”, use the [–/NO] and [+ /YES] buttons to lower or raise the pitch in approximately 0.2 Hz increments (the first time the [–/NO] or [+ /YES] button is pressed simply switches to the tuning value display without actually changing the tuning). The overall tuning range is from 427.0 Hz to 453.0 Hz (corresponding to the A3 note’s Hz). Press the [–/NO] and [+ /YES] buttons simultaneously to recall the default value “440 Hz”.

Tenths of a Hertz are indicated on the LED display by the appearance and position of one or two dots, as in the following example:

Display	Value
440	440.0
440.	440.2
440.	440.4
440.	440.6
440.	440.8

F2 Scale

After selecting “*F 2.5*”, press the [+ /YES] button to engage the scale function sub-mode, then use the [TEMPO/FUNCTION ▼, ▲] buttons to select the desired scale function, as listed below.

F2.1: Scale

In addition to the standard Equal Temperament tuning, the YPP-100 includes 6 classic tunings that you can select and use to play music of the corresponding period, or experiment with in a more modern context. The tunings are:

- | | |
|----------------------|-----------------|
| 1: Equal Temperament | 5: Mean Tone |
| 2: Pure Major | 6: Werckmeister |
| 3: Pure Minor | 7: Kirnberger |
| 4: Pythagorean | |

Use the [–/NO] and [+ /YES] buttons to select the number of the desired tuning. Press the [–/NO] and [+ /YES] buttons simultaneously to recall the default settings (Equal Temperament tuning).

F2.2: Base Note

Unlike Equal Temperament tuning, these classic tunings must be tuned to a specific key. Use the [–/NO] and [+ /YES] buttons to select the key you want the previously selected tuning to be based. The selected key will appear on the display, followed by a low bar if flat (e.g. “*F _*”) or a high bar if sharp (e.g. “*F ^*”).

Press the [–/NO] and [+ /YES] buttons simultaneously to recall the default settings “C”.

 **NOTE** • The base note setting is effective for tunings other than the Equal Temperament tuning.

F3 Dual Mode Functions

After selecting “F 3.4”, press the [+/**YES**] button to engage the dual-mode function sub-mode, then use the [**TEMPO/FUNCTION** ▼, ▲] buttons to select the desired dual mode function, as listed below.

If the Dual mode is not engaged “F 3.-” will appear instead of “F 3.4” and the Dual mode functions cannot be selected. If this happens engage the Dual mode and proceed (See page 17 for more information on the Dual Mode.)

■ **SHORTCUT:** You can jump directly to the dual-mode functions (F3) by pressing the [**FUNCTION**] button while holding the two dual-mode voice selectors.



NOTE

• Dual mode function settings are set individually for each voice combination.

F3.1: Dual Balance

The volume levels of the two voices combined in the dual mode can be adjusted as required by using this function. Use the [-/**NO**] and [+/**YES**] buttons to adjust the balance as required. The balance range is from 0 through 20. A setting of “10” produces equal balance between the two dual-mode voices. Settings below “10” increase the volume of the 2nd Voice in relation to the 1st Voice, and settings above “10” increase the volume of the 1st Voice in relation to the 2nd Voice (“1st” and “2nd” is explained on page 17). Press the [-/**NO**] and [+/**YES**] buttons simultaneously to recall the default setting (different for each voice combination).

You can set one voice as the main voice, and another voice as a softer, mixed voice.

F3.2: Dual Detune

This function makes it possible to detune the 1st and 2nd dual-mode Voices to create a thicker sound. Use the [-/**NO**] and [+/**YES**] buttons to set the amount of detuning as required. The detune range is from -10 through 10. A setting of “0” sets both voices to the same pitch. “+” values raise the pitch of the 1st voice while lowering the pitch of the 2nd voice, and “-” values raise the pitch of the 2nd voice while lowering the pitch of the 1st voice. (“1st” and “2nd” is explained on page 17). Press the [-/**NO**] and [+/**YES**] buttons simultaneously to recall the default setting (different for each voice combination).



NOTE

• The maximum amount of pitch variation increases toward the lower key range (± 49 cents at the E0 key), and decreases toward the higher key range (± 5 cents at the G6 key). 100 cents = 1 semitone.

F3.3: 1st Voice Octave Shift

F3.4: 2nd Voice Octave Shift

Depending on which voices you combine using the dual mode, the combination may sound better if one of the voices is shifted up or down an octave. Use the [-/**NO**] and [+/**YES**] buttons to set the octave of the 1st or 2nd Voice as required (“1st” and “2nd” is explained on page 17). The available settings are “0” for normal pitch, “-1” to shift the pitch down one octave, and “1” to shift the pitch up one octave. Press the [-/**NO**] and [+/**YES**] buttons simultaneously to recall the default setting (different for each voice combination).

F3.5: 1st Voice Effect Depth

F3.6: 2nd Voice Effect Depth

These functions make it possible to individually set the depth of the effect for the 1st and 2nd dual-mode Voices (“1st” and “2nd” is explained on page 17). Use the [–/NO] and [+ /YES] buttons to set the effect depth for the corresponding voice as required. The depth range is from 0 through 20. A setting of “0” produces no effect, while a setting of “20” produces maximum effect depth. Press the [–/NO] and [+ /YES] buttons simultaneously to recall the default setting (different for each voice combination).



• *The effect depth settings cannot be changed unless the EFFECT is ON. The Function mode must be exited before EFFECT can be turned ON.*

F3.7: Reset

This function resets all dual-mode functions to their default values. Press the [+ /YES] button to reset the values. “E r d” will appear on the display when all functions have been reset.

F4 **Soft Pedal Mode**

This function sets the footswitch connected to the SOFT jack for normal soft pedal operation or for song start/stop operation. Use the [–/NO] or [+ /YES] buttons to select the desired soft pedal mode. “1” engages the normal soft pedal mode, and “2” engages the start/stop mode. When the start/stop mode is engaged, the footswitch connected to the SOFT jack functions in the same way as the SONG [START/STOP] button on the panel.

Press the [–/NO] and [+ /YES] buttons simultaneously to recall the default setting of “1”.

F5 **Metronome Volume**

■ **SHORTCUT:** You can jump directly to the metronome functions by pressing the [FUNCTION] button while holding the METRONOME [START/STOP] button.

The volume of the metronome sound can be changed. After selecting “F 5”, use the [–/NO] and [+ /YES] buttons to set the metronome volume as required. The volume range is from 1 through 20. A setting of “1” produces minimum sound, while a setting of “20” produces maximum metronome volume. Press the [–/NO] and [+ /YES] buttons simultaneously to recall the default setting “10”.

F6 **Preset Song Part Cancel Volume**

This function sets the volume at which a “canceled” part is played during preset song playback (see page 16 for information on the “part-cancel” function). Use the [–/NO] and [+ /YES] buttons to set the volume as required. The volume range is from 0 through 20. A setting of “0” produces no sound, while a setting of “20” produces maximum volume. Press the [–/NO] and [+ /YES] buttons simultaneously to recall the default setting “5”.

Adjust the part volume to a comfortable level to use the “canceled” part as a guide to play along with. Set to “0” if you don’t want to hear the part.

F7 MIDI Functions

After selecting “F 7.4”, press the [+/**YES**] button to engage the MIDI function sub-mode, then use the [TEMPO/**FUNCTION** ▼, ▲] buttons to select the desired MIDI function, as listed below.



- Always use a high-quality MIDI cable to connect MIDI OUT to MIDI IN terminals. Never use MIDI cables longer than about 15 meters, since cables longer than this can pick up noise which can cause data errors.

- ☐ F7.1: MIDI Transmit Channel Selection
- ☐ F7.2: MIDI Receive Channel Selection

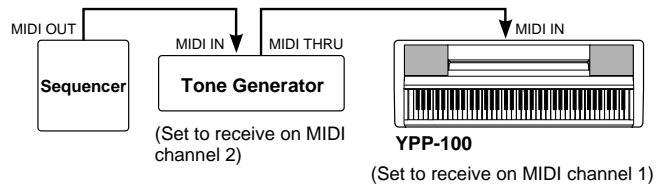

The MIDI system allows transmission and reception of MIDI data on 16 different channels. Multiple channels have been implemented to allow selective control of certain instruments or devices connected in series. For example, a single MIDI sequence recorder could be used to “play” two different instruments or tone generators. One of the instruments or tone generators could be set to receive only on channel 1, while the other is set to receive on channel 2. In this situation the first instrument or tone generator will respond only to channel-1 information transmitted by the sequence recorder, while the second instrument or tone generator will respond only to channel-2 information. This allows the sequence recorder to “play” two completely different parts on the receiving instruments or tone generators.

In any MIDI control setup, the MIDI channels of the transmitting and receiving equipment must be matched for proper data transfer. A “Multi-timbre” receive mode is also available, which allows simultaneous reception of different parts on all 16 MIDI channels, allowing the YPP-100 to play multi-channel song data received from a music computer or sequencer. There’s also a “1-2” mode which allows simultaneous reception on channels 1 and 2.

Use the [–/**NO**] and [+/**YES**] buttons to select the desired transmit or receive channel. The transmit channel parameter can also be turned “OFF” if you don’t want the YPP-100 to transmit any MIDI data. To select the multi-timbre receive mode, set the receive channel to “ALL”. Select “1-2” for multi-timbre reception on channels 1 and 2 only.

Press the [–/**NO**] and [+/**YES**] buttons simultaneously to recall the default setting: transmit = “1”; receive = “ALL”.



- In the dual mode, first voice data is transmitted on its set channel while second voice data is transmitted on the next greater channel. No data is transmitted if the transmit channel is set to “OFF”.
- Demo/preset song data and recorder playback data are not transmitted via MIDI.
- No MIDI reception occurs when the demo/preset song mode is engaged.
- Program change and other like channel messages received will not affect the YPP-100’s panel settings or what is being played on the keyboard.

F7.3: Local Control ON/OFF

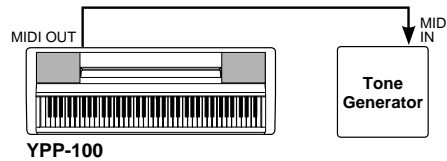

“Local Control” refers to the fact that, normally, the YPP-100 keyboard controls its internal tone generator, allowing the internal voices to be played directly from the keyboard. This situation is “Local Control On” since the internal tone generator is controlled locally by its own keyboard.

Local control can be turned OFF, however, so that the YPP-100 keyboard does not play the internal voices, but the appropriate MIDI information is still transmitted via the MIDI OUT connector when notes are played on the keyboard. At the same time, the internal tone generator responds to MIDI information received via the MIDI IN connector.

Use the [–/NO] and [+ /YES] buttons to turn local control “On” or “OFF”.

Press the [–/NO] and [+ /YES] buttons simultaneously to recall the default setting “On”.

F7.4: Program Change ON/OFF

Normally the YPP-100 will respond to MIDI program change numbers received from an external keyboard or other MIDI device, causing the correspondingly numbered voice to be selected on the corresponding channel (the keyboard voice does not change). The YPP-100 will normally also send a MIDI program change number whenever one of its voices is selected, causing the correspondingly numbered voice or program to be selected on the external MIDI device if the device is set up to receive and respond to MIDI program change numbers.

This function makes it possible to cancel program change number reception and transmission so that voices can be selected on the YPP-100 without affecting the external MIDI device.

Use the [–/NO] and [+ /YES] buttons to turn program change transmission and reception “On” or “OFF”.

Press the [–/NO] and [+ /YES] buttons simultaneously to recall the default setting “On”.



• For information on program change numbers for each of the YPP-100's voices, refer to page 42 in the MIDI Data Format section.

F7.5: Control Change ON/OFF

Normally the YPP-100 will respond to MIDI control change data received from an external MIDI device or keyboard, causing the voice on the corresponding channel to be affected by pedal and other “control” settings received from the controlling device (the keyboard voice is not affected). The YPP-100 also transmits MIDI control change information when one of its pedals or other appropriate controls are operated.

This function makes it possible to cancel control change data reception and transmission so that, for example, the YPP-100 pedals and other controls can be operated without affecting an external MIDI device.

Use the [–/NO] and [+ /YES] buttons to turn control change transmission and reception “On” or “OFF”.

Press the [–/NO] and [+ /YES] buttons simultaneously to recall the default setting “On”.



NOTE • For information on control changes that can be used with the YPP-100, refer to the MIDI Data Format on page 41.

F7.6: MIDI Transmit Transpose

This function allows the MIDI note data transmitted by the YPP-100 to be transposed up or down in semitone increments by up to plus or minus 12 semitones. The pitch of the YPP-100 itself is not affected.

Use the [–/NO] and [+ /YES] buttons to set the desired amount of MIDI transmit transposition. The range is from “–12” (down one octave) through “0” (no transposition) to “12” (up one octave).

Press the [–/NO] and [+ /YES] buttons simultaneously to recall the default setting “0”.

F7.7: Panel/Status Transmit

This function causes all the current YPP-100 panel settings (selected voice, etc.) to be transmitted via the MIDI OUT terminal. This is particularly useful if you will be recording performances to a MIDI sequence recorder such as the Yamaha MIDI Data Filer MDF3 which will be used to control the YPP-100 on playback. By transmitting the YPP-100 panel settings and recording them on the MIDI sequence recorder prior to the actual performance data, the YPP-100 will be automatically restored to the same settings when the performance is played back.

Press the [+ /YES] button to transmit the panel/status data. “*É r d*” will appear on the LED display when the data has been successfully transmitted.



NOTE • See page 42 for list of the “Panel Data Contents” transmitted by this function.
• Panel setting data that is transmitted to an external device can only be reloaded on a model of the same type. Panel setting data can also be directly transferred to or from instruments of the same model type.

F7.8: Bulk Data Dump

This function is used to transmit all data stored in the Recorder memory to a MIDI data storage device such as the Yamaha MIDI Data Filer MDF3, other sequence recorders, or MIDI compatible computers.

Press the [+ /YES] button to begin bulk transmission. “*É r d*” will appear on the LED display when the data has been successfully transmitted.



NOTE • User song recorder data that is transmitted to an external device can only be reloaded on a model of the same type. Recorder data can also be directly transferred to or from instruments of the same model type.
• The reload operation cannot be executed when the demo/preset song mode or user song recorder is in operation, or when the Function mode is engaged.
• No MIDI note/panel data transmission or data reception occurs during a bulk data dump transmit operation.

F8 Backup Functions

After selecting “*F.B.Y.*”, press the [+/**YES**] button to engage the backup function sub-mode, then use the [TEMPO/FUNCTION ▼, ▲] buttons to select the desired backup function, as listed below.



- The backup settings themselves, and the contents of the user song recorder memory, are always backed up.
- Even if the Backup is turned on, factory presets can be recalled at any time (see page 37). The factory setting list is found on page 40.

Even if backup is turned on via one of the functions described below, the data will only be retained in memory for about 1 week if the power is not turned on during this time. If the backup period is exceeded, all settings will be reset to their default values. If you want to retain the backup settings for longer periods, be sure to turn the power switch on for a few minutes at least once a week.

F8.1: Voice

Turns backup of the voice functions listed below on or off. Use the [–/**NO**] and [+/**YES**] buttons to turn backup “On” or “OFF”.

The default backup mode is “OFF”.

- Voice (Keyboard and Dual)
- Dual (ON/OFF, Voice, and Dual Functions for each voice combination)
- Reverb (ON/OFF, Type, and Depth for each voice)
- Effect (ON/OFF, Type, and Depth for each voice)
- Touch Sensitivity (including the FIXED volume)
- Metronome (Beat, Volume)
- Preset Song Part Cancel Volume

F8.2: MIDI

Turns backup of the MIDI functions listed below on or off. Use the [–/**NO**] and [+/**YES**] buttons to turn backup “On” or “OFF”.

The default backup mode is “OFF”.

- Channel (Transmit, Receive)
- Program Change ON/OFF
- MIDI Transmit Transpose
- Local ON/OFF
- Control Change ON/OFF

F8.3: Tuning

Turns backup of the tuning functions listed below on or off. Use the [–/**NO**] and [+/**YES**] buttons to turn backup “On” or “OFF”.

The default backup mode is “OFF”.

- Transpose
- Tuning
- Scale (including base note)

F8.4: Pedal

Turns backup of the Soft Pedal Mode on or off. Use the [–/**NO**] and [+/**YES**] buttons to turn backup “On” or “OFF”.

The default backup mode is “OFF”.

Using the MIDI Functions

The YPP-100 is MIDI-compatible, featuring MIDI IN and MIDI OUT terminals and providing a variety of MIDI-related controls. By using the MIDI functions you can expand your musical possibilities. This section explains what MIDI is, and what it can do, as well as how you can use MIDI on your YPP-100.

What Is MIDI?

No doubt you have heard the terms “acoustic instrument” and “digital instrument.” In the world today, these are the two main categories of instruments. Let’s consider an acoustic piano and a classical guitar as representative acoustic instruments. They are easy to understand. With the piano, you strike a key, and a hammer inside hits some strings and plays a note. With the guitar, you directly pluck a string and the note sounds. But how does a digital instrument go about playing a note?

Acoustic guitar note production

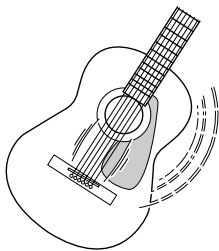

Pluck a string and the body resonates the sound.

Digital instrument note production

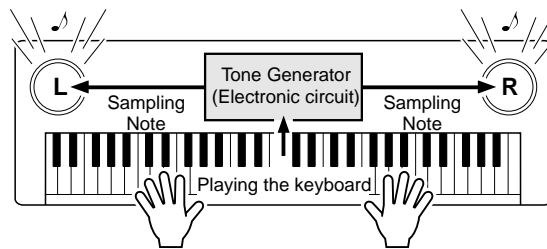

Based on playing information from the keyboard, a sampling note stored in the tone generator is played through the speakers.

As shown in the illustration above, in an electronic instrument the sampling note (previously recorded note) stored in the tone generator section (electronic circuit) is played based on information received from the keyboard. So then what is the information from the keyboard that becomes the basis for note production?

For example, let’s say you play a “C” quarter note using the PIANO 1 sound on the YPP-100 keyboard. Unlike an acoustic instrument that puts out a resonated note, the electronic instrument puts out information from the keyboard such as “with what voice,” “with which key,” “about how strong,” “when was it pressed,” and “when was it released.” Then each piece of information is changed into a number value and sent to the tone generator. Using these numbers as a basis, the tone generator plays the stored sampling note.

● Example of Keyboard Information

Voice (with what voice)	PIANO 1
Note number (with which key)	60 (C3)
Note on (when was it pressed) and note off (when was it released)	Timing expressed numerically (quarter note)
Velocity (about how strong)	100 (strong)

MIDI is an acronym that stands for Musical Instrument Digital Interface, which allows electronic musical instruments to communicate with each other, by sending and receiving compatible Note, Control Change, Program Change and various other types of MIDI data, or messages.

The YPP-100 can control a MIDI device by transmitting note related data and various types of controller data. The YPP-100 can be controlled by the incoming MIDI messages which automatically determine tone generator mode, select MIDI channels, voices and effects, change parameter values and of course play the voices specified for the various parts.

MIDI messages can be divided into two groups: Channel messages and System messages. Below is an explanation of the various types of MIDI messages which the YPP-100 can receive/transmit.

● Channel Messages

The YPP-100 is an electronic instrument that can handle 16 channels. This is usually expressed as "it can play 16 instruments at the same time." Channel messages transmit information such as Note ON/OFF, Program Change, for each of the 16 channels.

Message Name	YPP-100 Operation/Panel Setting
Note ON/OFF	Messages which are generated when the keyboard is played. Each message includes a specific note number which corresponds to the key which is pressed, plus a velocity value based on how hard the key is struck.
Program Change	Voice number (along with corresponding bank select MSB/LSB settings, if necessary).
Control Change	Messages that are used to change some aspect of the sound (Damper, Reverb Depth, etc.)

● System Messages

This is data that is used in common by the entire MIDI system. System messages include messages like Exclusive Messages that transmit data unique to each instrument manufacturer and Realtime Messages that control the MIDI device.

Message Name	YPP-100 Operation/Panel Setting
Exclusive Message	Reverb/Effect settings, etc.
Realtime Messages	Start/stop operation

The messages transmitted/received by the YPP-100 are shown in the MIDI Implementation Chart on page 45.

MIDI Terminals

In order to exchange MIDI data between multiple devices, each device must be connected by a cable. The MIDI terminals of the YPP-100 are located on the rear panel.

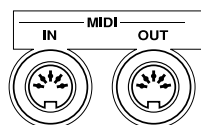

MIDI IN	Receives MIDI data from another MIDI device.
MIDI OUT	Transmits the YPP-100's keyboard information as MIDI data to another MIDI device.

NOTE

- Special MIDI cables (sold separately) must be used for connecting to MIDI devices. They can be bought at music stores, etc.
- Never use MIDI cables longer than about 15 meters. Cables longer than this can pick up noise which can cause data errors.

Connecting to a Personal Computer

By connecting your YPP-100's MIDI terminals to a personal computer, you can have access to a wide variety of music software.

When using a MIDI interface device installed in the personal computer, connect the MIDI terminals of the personal computer and the YPP-100.

Use only special MIDI cables when connecting MIDI devices.

- **Connect the MIDI terminals of the YPP-100 to the MIDI terminals of the personal computer.**

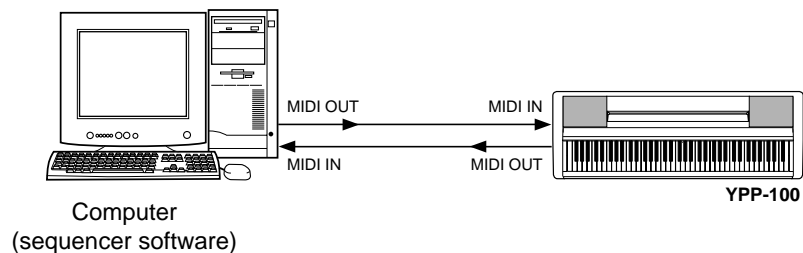

- When connecting the YPP-100 to a personal computer, first turn the power to both the YPP-100 and the computer OFF before connecting the cable. After connecting the cable, turn the power to the computer on first, then turn on the YPP-100.

- **When using a MIDI interface with a Macintosh series computer, connect the RS-422 terminal of the computer (modem or printer terminal) to the MIDI interface, as shown in the diagram below.**

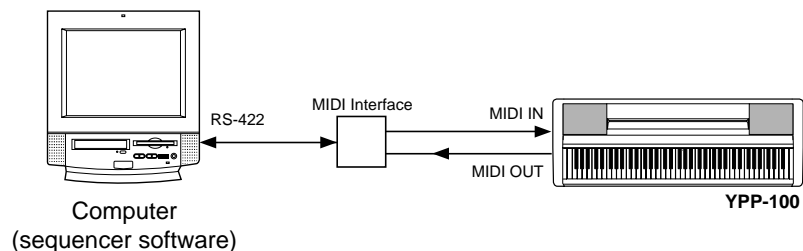

- When using a Macintosh series computer, set the MIDI interface clock setting in the application software to match the setting of the MIDI interface you are using. For details, refer to the owner's manual for the software you are using.

- **When connecting to a computer with a USB interface, use the Yamaha UX16 USB/MIDI Interface. Connect the UX16 and the computer with a standard USB cable, then make the proper MIDI connections between the YPP-100 and the UX16.**

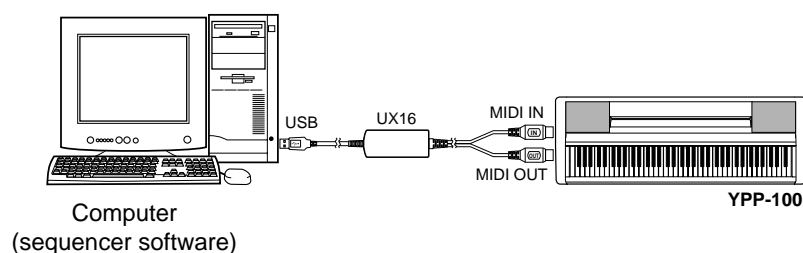

Factory Preset Recall

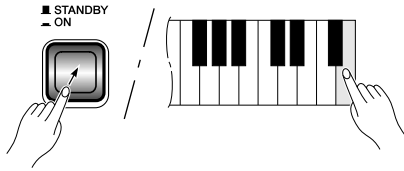

All dual mode, reverb, effect, touch sensitivity, tuning settings, and the settings affected by the Backup Functions can be restored to their original factory preset values by holding the G6 key (rightmost key on the keyboard) while turning the [STANDBY/ON] switch ON. This also erases all recorder data, and sets all Backup on/off settings (F8) to “OFF”.



• The factory setting list is found on page 40.

Troubleshooting

If you encounter what appears to be a malfunction, please check the following points before assuming that your YPP-100 is faulty.

1. No Sound When the Power is Turned ON

Is the AC power adaptor properly connected to the YPP-100 and an AC wall outlet? Check the AC connection carefully. Is the MASTER VOLUME control turned up to a reasonable listening level? Also make sure that a pair of headphones is not plugged into the PHONES jack, and that the Local Control (page 31) is ON.

2. The Footswitch Doesn't Work Correctly

If the footswitch connected to the DAMPER or SOFT jacks does not work, or notes are sustained even when the pedal is not pressed (its ON/OFF status is reversed), make sure that the footswitch is properly plugged into the corresponding jack or turn the power OFF then ON again without pressing the footswitch.

3. The YPP-100 Reproduces Radio or TV Sound

This can occur if there is a high-power transmitter in your vicinity. Contact your Yamaha dealer.

4. Intermittent Static Noise

This is usually due to turning ON or OFF a household appliance or other electronic equipment which is fed by the same AC mains line as your YPP-100.

5. Interference Appears On Radio or TV Sets Located Near the YPP-100

The YPP-100 contains digital circuitry which can generate radio-frequency noise. The solution is to move the YPP-100 further away from the affected equipment, or vice versa.

6. Noise is heard from the YPP-100's speakers.

The noise may be due to interference caused by the use of a mobile phone in close proximity to the YPP-100.

Turn off the mobile phone, or use it further away from the YPP-100.

7. Distorted Sound When the YPP-100 is Connected to An External Amplifier/Speaker System

If the YPP-100 is connected to a stereo system or instrument amplifier and the sound is distorted, try reducing the volume of the YPP-100 first, then reduce the volume of the external equipment to a level at which the distortion ceases.

- If “E C n” appears on the display an internal malfunction has occurred. In this case, contact your Yamaha dealer.

Options

FC5, FC4 Footswitch

Connects to the DAMPER or SOFT Jacks.

HPE-150 Stereo Headphones

High-performance lightweight dynamic headphones with extra-soft ear pads.

Voice Descriptions

Voice	Stereo/Mono	Touch Response	Voice Descriptions
PIANO 1	Stereo	○	Newly-recorded samples from a full concert grand piano. Perfect for classical compositions as well as any other style that requires acoustic piano.
PIANO 2	Stereo	○	A bright, expansive piano sound which is ideal for rock and popular genres.
E.PIANO	Mono	○	Soft tone when played lightly, and an aggressive tone when played hard.
HARPSICHORD	Stereo	×	The definitive instrument for baroque music. Since harpsichord uses plucked strings, there is no touch response. There is, however, a characteristic additional sound when the keys are released.
VIBRAPHONE	Stereo	○	Vibraphone played with relatively soft mallets. The tone becomes more metallic the harder you play.
CHURCH ORGAN	Stereo	×	A soft pipe-organ type voice that is ideal for hymn accompaniment and other styles.
STRINGS	Stereo	○	A large string ensemble. Try combining this voice with piano in the DUAL mode.
CHOIR	Stereo	○	A big, spacious choir voice. Perfect for creating rich harmonies in slow pieces.

Demo and Preset Song List

Voice Demo Tune Titles

Voice Name	Title	Composer
PIANO 1	Fantasia-Impromptu	F.F.Chopin
PIANO 2	Yamaha Original	H.Fujita
E.PIANO	Yamaha Original	Fukuda
HARPSICHORD	Le Coucou	L-C.Daquin
VIBRAPHONE	Yamaha Original	H.Fujita
CHURCH ORGAN	Organ Concerto Op.4 No.2	G.F.Händel
STRINGS	Brandenburgisches Konzert No.3	J.S.Bach
CHOIR	Kantate Nr.140	J.S.Bach

- Some of the demonstration pieces listed above are short rearranged excerpts from the original compositions. Original songs are all rights reserved (© 2002 YAMAHA CORPORATION).

Preset Song Titles

No.	Title	Composer
1	Arabesque 1	C.A.Debussy
2	Melody in F	A.Rubinstein
3	Prelude op.28-15 "Raindrop"	F.F.Chopin
4	Nocturne op.9-2	F.F.Chopin
5	Valse op.64-1 "Petit chien"	F.F.Chopin
6	Valse op.69-1 "L'adieu"	F.F.Chopin
7	Piano Sonate op.27-2 "Mondschein" 1st mov.	L.v.Beethoven
8	Etude op.10-12 "Revolutionary"	F.F.Chopin
9	Träumerei	R.Schumann
10	Menuett G dur	W.A.Mozart
11	Prelude (Wohltemperierte Klavier I No.1)	J.S.Bach
12	Turkish March (Piano Sonate No.11 K.331)	W.A.Mozart
13	Impromptu op.90-2	F.P.Schubert
14	Moments Musicaux op.94-3	F.P.Schubert
15	Frühlingslied op.62-2	J.L.F.Mendelssohn
16	Clair de lune	C.A.Debussy
17	Arabesque	J.F.F.Burgmuller
18	La chevaleresque	J.F.F.Burgmuller
19	Für Elise	L.v.Beethoven
20	Liebesträume Nr.3	F.Liszt

Factory Setting List

		Backup Group
Voice	PIANO 1	F8.1
Dual Mode	OFF	
Reverb Type	Preset for each voice	
Reverb Depth	Preset for each voice	
Effect Type	Preset for each voice	
Effect Depth	Preset for each voice	
Touch Sensitivity	MEDIUM	
Volume in the FIXED Mode	80	
Metronome	OFF	—
Metronome Time Signature	0 (no accent)	F8.1
Tempo	120	—
Transpose	0	F8.3

“—”: Not memorized

Function

	Function	Default	Backup Group
F1	Tuning	A3=440Hz	F8.3
F2.1	Scale	1 (Equal Temperament)	
F2.2	Base Note	C	
F3.1	Dual Balance	Preset for each voice combination	F8.1
F3.2	Dual Detune	Preset for each voice combination	
F3.3, F3.4	Dual Octave Shift	Preset for each voice combination	
F3.5, F3.6	Dual Effect Depth	Preset for each voice combination	
F4	Soft Pedal Mode	1 (soft pedal)	F8.4
F5	Metronome Volume	10	F8.1
F6	Preset Song Part Cancel Volume	5	
F7.1	MIDI Transmit Channel	1	F8.2
F7.2	MIDI Receive Channel	ALL	
F7.3	Local Control	ON	
F7.4	Program Change Send & Receive	ON	
F7.5	Control Change Send & Receive	ON	
F7.6	MIDI Transmit Transpose	0	
F8	Backup	All OFF	Always backed up

MIDI Data Format

If you're already very familiar with MIDI, or are using a computer to control your music hardware with computer-generated MIDI messages, the data provided in this section can help you to control the YPP-100.

1. NOTE ON/OFF

Data format: [9nH] -> [kk] -> [vv]

9nH = Note ON/OFF event (n = channel number)
kk = Note number (Transmit: 10H ~ 73H = E-1 ~ G7 /
Receive: 00H ~ 7FH = C-2 ~ G8)*
vv = Velocity (Key ON = 01H ~ 7FH, Key OFF = 00H)

Data format: [8nH] -> [kk] -> [vv] (reception only)

8nH = Note OFF event (n = channel number)
kk = Note number: 00H ~ 7FH = C-2 ~ G8
vv = Velocity

* If received value exceeds the supported range for the selected voice, the note is adjusted by the necessary number of octaves.

2. CONTROL CHANGE

Data format: [BnH] -> [cc] -> [vv]

BnH = Control change (n = channel number)
cc = Control number
vv = Data Range

(1) Bank Select

ccH	Parameter	Data Range (vvH)
00H	Bank Select MSB	00H:Normal
20H	Bank Select LSB	00H...7FH

Bank selection processing does not occur until receipt of next Program Change message.

(2) Main Volume (reception only)

ccH	Parameter	Data Range (vvH)
07H	Volume	00H...7FH

(3) Expression

ccH	Parameter	Data Range (vvH)
0BH	Expression	00H...7FH

(4) Damper

ccH	Parameter	Data Range (vvH)
40H	Damper	00H...7FH

(5) Sostenuto (reception only)

ccH	Parameter	Data Range (vvH)
42H	Sostenuto	00H-3FH:off, 40H-7FH:on

(6) Soft Pedal

ccH	Parameter	Data Range (vvH)
43H	Soft Pedal	00H-3FH:off, 40H-7FH:on

(7) Effect1 Depth (Reverb Send Level)

ccH	Parameter	Data Range (vvH)
5BH	Effect1 Depth	00H...7FH

Adjusts the reverb send level.

(8) Effect4 Depth (Variation Effect Send Level)

ccH	Parameter	Data Range (vvH)
5EH	Effect4 Depth	00H...7FH

3 MODE MESSAGES

Data format: [BnH] -> [cc] -> [vv]

BnH = Control event (n = channel number)
cc = Control number
vv = Data Range

(1) All Sound Off

ccH	Parameter	Data Range (vvH)
78H	All Sound Off	00H

Switches off all sound from the channel. Does not reset Note On and Hold On conditions established by Channel Messages.

(2) Reset All Controllers

ccH	Parameter	Data Range (vvH)
79H	Reset All Controllers	00H

Resets controllers as follows.

Controller	Value
Expression	127 (max)
Damper Pedal	0 (off)
Sostenuto	0 (off)
Soft Pedal	0 (off)

(3) Local Control (reception only)

ccH	Parameter	Data Range (vvH)
7AH	Local Control	00H (off), 7FH (on)

(4) All Notes Off

ccH	Parameter	Data Range (vvH)
7BH	All Notes Off	00H

Switches OFF all the notes that are currently ON on the specified channel. Any notes being held by the damper or sostenuto pedal will continue to sound until the pedal is released.

(5) Omni Off (reception only)

ccH	Parameter	Data Range (vvH)
7CH	Omni Off	00H

Same processing as for All Notes Off.

(6) Omni On (reception only)

ccH	Parameter	Data Range (vvH)
7DH	Omni On	00H

Same processing as for All Notes Off.

(7) Mono (reception only)

ccH	Parameter	Data Range (vvH)
7EH	Mono	00H

Same processing as for All Sound Off.

(8) Poly (reception only)

ccH	Parameter	Data Range (vvH)
7FH	Poly	00H

Same processing as for All Sound Off.

- When control change reception is turned OFF in the Function mode, control change data will not be transmitted or received except for Bank Select and Mode messages.
- Local on/off, OMNI on/off are not transmitted. (The appropriate note off number is supplied with "All Note Off" transmission).
- When a voice bank MSB/LSB is received, the number is stored in the internal buffer regardless of the received order, then the stored value is used to select the appropriate voice when a program change message is received.
- The Multi-timbre and Poly modes are always active. No change occurs when OMNI ON, OMNI OFF, MONO, or POLY mode messages are received.

4. PROGRAM CHANGE

Data format: [CnH] -> [ppH]

CnH = Program event (n = channel number)
ppH = Program change number

P.C.#=Program Change number			
	MSB	LSB	P.C.#
PIANO 1	0	112	0
PIANO 2	0	112	1
E.PIANO	0	112	4
HARPSICHORD	0	112	6
VIBRAPHONE	0	112	11
CHURCH ORGAN	0	112	19
STRINGS	0	112	48
CHOIR	0	112	52

- When program change reception is turned OFF in the Function mode, no program change data is transmitted or received. Also, Bank MSB/LSB is not transmitted or received.

5. SYSTEM REALTIME MESSAGES

[rrH]
F8H: Timing clock
FAH: Start
FCH: Stop
FEH: Active sensing

Data	Transmission	Reception
F8H	Transmitted every 96 clocks	Received as 96-clock tempo timing when MIDI clock is set to External
FAH	Recorder start	Recorder start Not received when the MIDI clock is set to Internal.
FCH	Recorder stop	Recorder stop Not received when the MIDI clock is set to Internal.
FEH	Transmitted every 200 milliseconds	If a signal is not received via MIDI for more than 400 milliseconds, the same processing will take place for All Sound Off, All Notes Off and Reset All Controllers as when those signals are received.

- Caution: If an error occurs during MIDI reception, the Damper, Sostenuto, and Soft effects for all channels are turned off and an All Note Off occurs.

6. SYSTEM EXCLUSIVE MESSAGES (Yamaha MIDI Format)

Panel Data Transmit

Data format: [F0H] -> [43H] -> [0nH] -> [7CH] -> ... -> [F7H]

F0H, 43H, 0nH, 7CH (n: channel number)
00H, 2AH (data length)
43H, 4CH, 20H, 20H (CL)
59H, 50H, 50H, 27H, 30H, 31H (YPP '01)
30H, 30H (version x, y)
[PANEL DATA]
[CHECK SUM (1byte)] = 0-(43H+4CH+20H+.....+Data end)
F7H

• Panel Data Contents

- (1) 1'st Voice
- (2) Dual On/Off
- (3) Dual Voice
- (4) Dual Balance
- (5) Dual Detune
- (6) Dual Voice1 Octave
- (7) Dual Voice2 Octave
- (8) Dual Voice1 Effect Depth
- (9) Dual Voice2 Effect Depth
- (10) -
- (11) -
- (12) -
- (13) -
- (14) -
- (15) -
- (16) -
- (17) -
- (18) -
- (19) Reverb Type 1
- (20) Reverb Type 2
- (21) Reverb Depth1
- (22) Reverb Depth2
- (23) Effect Type 1
- (24) Effect Type 2
- (25) Effect Depth
- (26) Touch Sensitivity
- (27) Fixed Data
- (28) Soft Pedal Function
- (29) Absolute tempo low byte
- (30) Absolute tempo high byte

- "-" indicates no affect.
- Panel data send requests cannot be received.

7. SYSTEM EXCLUSIVE MESSAGES (Universal System Exclusive)

(1) Universal Realtime Message

Data format: [F0H] -> [7FH] -> [XnH] -> [04H] -> [01H] -> [//H] -> [mmH] -> [F7H]

MIDI Master Volume

- Simultaneously changes the volume of all channels.
- When a MIDI master volume message is received, the volume only has affect on the MIDI receive channel, not the panel master volume.

F0H = Exclusive status
7FH = Universal Realtime
7FH = ID of target device
04H = Sub-ID #1=Device Control Message
01H = Sub-ID #2=Master Volume
//H = Volume LSB
mmH = Volume MSB
F7H = End of Exclusive

or
F0H = Exclusive status
7FH = Universal Realtime
XnH = When n is received n=0-F, whichever is received.
X = don't care
04H = Sub-ID #1=Device Control Message
01H = Sub-ID #2=Master Volume
//H = Volume LSB
mmH = Volume MSB
F7H = End of Exclusive

(2) Universal Non-Realtime Message (GM On)

General MIDI Mode On

Data format: [F0H] -> [7EH] -> [XnH] -> [09H] -> [01H] -> [F7H]

- F0H = Exclusive status
- 7EH = Universal Non-Realtime
- 7FH = ID of target device
- 09H = Sub-ID #1=General MIDI Message
- 01H = Sub-ID #2=General MIDI On
- F7H = End of Exclusive

- or**
- F0H = Exclusive status
 - 7EH = Universal Non-Realtime
 - XnH = When received, n=0~F.
X = don't care
 - 09H = Sub-ID #1=General MIDI Message
 - 01H = Sub-ID #2=General MIDI On
 - F7H = End of Exclusive

When the General MIDI mode ON message is received, the MIDI system will be reset to its default settings. This message requires approximately 50ms to execute, so sufficient time should be allowed before the next message is sent.

8. SYSTEM EXCLUSIVE MESSAGES (XG Standard)

(1) XG Native Parameter Change

Data format: [F0H] -> [43H] -> [1nH] -> [4CH] -> [hhH] -> [mmH] -> [//H] -> [ddH] -> [F7H]

- F0H = Exclusive status
- 43H = YAMAHA ID
- 1nH = When received, n=0~F.
When transmitted, n=0.
- 4CH = Model ID of XG
- hhH = Address High
- mmH = Address Mid
- //H = Address Low
- ddH = Data
- F7H = End of Exclusive

Data size must match parameter size. When the XG System On message is received, the MIDI system will be reset to its default settings. The message requires approximately 50ms to execute, so sufficient time should be allowed before the next message is sent.

(2) XG Native Bulk Data (reception only)

Data format: [F0H] -> [43H] -> [0nH] -> [4CH] -> [aaH] -> [bbH] -> [hhH] -> [mmH] -> [//H] -> [ddH] -> ...-> [cCH] -> [F7H]

- F0H Exclusive status
- 43H YAMAHA ID
- 0nH When received, n=0~F.
When transmitted, n=0.
- 4CH Model ID of XG
- aaH ByteCount
- bbH ByteCount
- hhH Address High
- mmH Address Mid
- //H Address Low
- ddH Data
- | |
- cCH Check sum
- F7H End of Exclusive

- Receipt of the XG SYSTEM ON message causes reinitialization of relevant parameters and Control Change values. Allow sufficient time for processing to execute (about 50 msec) before sending the YPP-100 another message.
- XG Native Parameter Change message may contain two or four bytes of parameter data (depending on the parameter size).
- For information about the Address and Byte Count values, refer to Table 1 below. Note that the table's Total Size value gives the size of a bulk block. Only the top address of the block (00H, 00H, 00H) is valid as a bulk data address.

9. SYSTEM EXCLUSIVE MESSAGES (YPP-100 MIDI Format)

Data format: [F0H] -> [43H] -> [73H] -> [xxH] -> [nnH] -> [F7H]

- F0H = Exclusive status
 - 43H = Yamaha ID
 - 73H = YPP ID
 - xxH = Product ID (YPP-100 common ID: 67H or YPP common ID: 01H)
 - nnH = Substatus
 - nn Control
 - 02H Internal MIDI clock
 - 03H External MIDI clock
 - 06H Bulk Data (the bulk data follows 06H)
 - F7H = End of Exclusive
- * When nn=02H or 03H, YPP common ID (01H) is recognized as well as 50H.

BULK DUMP FORMAT

- F0H, 43H, 73H
- 6AH =Product ID
- 06H =Bulk ID
- 05H =Sequence data
- 0nH, 0nH, 0nH, 0nH, 0nH, 0nH, 0nH, 0nH =Data length
- [BULK DATA]
- [CHECK SUM (1byte)] = 0-sum (BULK DATA)
- F7H = End of Exclusive

10. SYSTEM EXCLUSIVE MESSAGES (Special Control)

Data format: [F0H] -> [43H] -> [73H] -> [xxH] -> [11H] -> [0nH] -> [cCH] -> [vvH] -> [F7H]

- F0H = Exclusive status
- 43H = Yamaha ID
- 73H = YPP ID
- 67H = YPP-100 common ID
- 11H = Special control
- 0nH = Control MIDI change (n=channel number)
- cc = Control number
- vv = Value
- F7H = End of Exclusive

Control	On	ccH	vvH
Metronome	Always 00H	1BH	00H : off 01H : - 02H : 2/4 03H : 3/4 04H : 4/4 05H : 5/4 06H : 6/4 07H : No accent
Channel Detune	ch: 00H-0FH	43H	(Sets the Detune value for each channel) 00H-7FH
Voice Reserve	ch: 00H-0FH	45H	00H : Reserve off 7FH : on*

* When Volume, Expression is received for Reserve On, they will be effective from the next Key On. Reserve Off is normal.

11. SYSTEM EXCLUSIVE MESSAGES (Others)

Data format: [F0H] -> [43H] -> [1nH] -> [27H] -> [30H] -> [00H] -> [00H] -> [mmH] -> [//H] -> [cCH] -> [F7H]

Master Tuning (XG and last message priority) simultaneously changes the pitch of all channels.

- F0H = Exclusive Status
- 43H = Yamaha ID
- 1nH = Transmission from n=YPP-100 is always 0. 0-F is received.
- 27H = Model ID of TG100
- 30H = Sub ID
- 00H =
- 00H =
- mmH = Master Tune MSB
- //H = Master Tune LSB
- cCH = don't care (under 7FH)
- F7H = End of Exclusive

<Table 1>

MIDI Parameter Change table (SYSTEM)

Address (H)	Size (H)	Data (H)	Parameter	Description	Default value (H)
00 00 00	4	020C - 05F4(*1)	MASTER TUNE	-50 - +50[cent]	00 04 00 00
01				1st bit 3 - 0 → bit 15 - 12	400
02				2nd bit 3 - 0 → bit 11 - 8	
03				3rd bit 3 - 0 → bit 7 - 4	
04	1	00 - 7F	MASTER VOLUME	0 - 127	7F
05				4th bit 3 - 0 → bit 3 - 0	
06	1	34 - 4C(*2)	TRANSPOSE	-12 - +12[semitones]	40
7E				XG SYSTEM ON	00=XG sytem ON
7F				RESET ALL PARAMETERS	00=ON (receive only)
TOTAL SIZE	07				

*1: Values lower than 020CH select -50 cents. Values higher than 05F4H select +50 cents.

*2: Values from 28H through 33H are interpreted as -12 through -1. Values from 4DH through 58H are interpreted as +1 through +12.

<Table 2>

MIDI Parameter Change table (EFFECT 1)

Refer to the "Effect MIDI Map" for a complete list of Reverb, Chorus and Variation type numbers.

Address (H)	Size (H)	Data (H)	Parameter	Description	Default value (H)
02 01 00	2	00-7F	REVERB TYPE MSB	Refer to Effect MIDI Map 00 : basic type	01(=HALL1) 00
		00-7F	REVERB TYPE LSB		
02 01 40	2	00-7F	VARIATION TYPE MSB	Refer to Effect MIDI Map 00 : basic type	00(=Effect off) 00
		00-7F	VARIATION TYPE LSB		

• "VARIATION" refers to the EFFECT on the panel.

<Table 3>

MIDI Parameter Change table (MULTI PART)

Address (H)	Size (H)	Data (H)	Parameter	Description	Default value (H)
08 nn 11	1	00 - 7F	DRY LEVEL	0 - 127	7F

nn = Part Number

● Effect MIDI Map

REVERB

	MSB	LSB
ROOM	02H	10H
HALL 1	01H	10H
HALL 2	01H	11H
STAGE	03H	10H

EFFECT

	MSB	LSB
CHORUS	42H	10H
PHASER	48H	10H
TREMOLO	42H	12H
DELAY	05H	10H

Function...	Transmitted	Recognized	Remarks
Basic Channel Default Changed	1 1 – 16	1 1 – 16	
Mode Default Messages Altered	3 × *****	1 × ×	*1 Poly Mode only
Note Number : True voice	16 – 115 *****	0 – 127 0 – 127	
Velocity Note ON Note OFF	○ 9nH, v=1 – 127 ○ 9nH, v=0	○ 9nH, v=1 – 127 ○ 9nH, v=0 or 8nH	
After Touch Key's Ch's	× ×	× ×	
Pitch Bender	×	×	
Control Change 0, 32 7 11 64 66 67 91 94	○ ○ ○ ○ × ○ ○ ○	○ ○ ○ ○ ○ ○ ○ ○	Bank Select Volume Expression Damper Sostenuto Soft pedal Reverb Depth Effect Depth
Program Change : True #	○ *****	○	
System Exclusive	○	○	
: Song Position Common : Song Select : Tune	× × ×	× × ×	
System : Clock Real Time : Commands	○ ○	○ ○	
: All sounds off : Reset All Controllers Aux : Local ON/OFF Messages : All Notes Off : Active Sense : Reset	× × × × ○ ×	○ (120, 126, 127) ○ (121) ○ (122) ○ (123 – 125) ○ ×	
Notes : *1 = Recieve Mode is always multi timbre and Poly mode.			

Mode 1: OMNI ON, POLY
Mode 3: OMNI OFF, POLY

Mode 2: OMNI ON, MONO
Mode 4: OMNI OFF, MONO

○: Yes
×: No

Keyboard Stand Assembly

CAUTION

- Be careful not to mismatch parts, and be sure to install all parts in the correct direction. Please assemble in accordance with the sequence given below.
- Assembly should be carried out by at least two persons.
- Be sure to use the correct screw size, as indicated above. Use of incorrect screws can cause damage.
- Be sure to tighten all screws upon completing assembly of each unit.
- To disassemble, reverse the assembly sequence given below.

Have a phillips-head (+) screwdriver ready.

The parts shown in the "Assembly Parts" illustration will be used. Follow the assembly instructions and select the parts as needed.

Assembly Parts

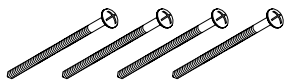
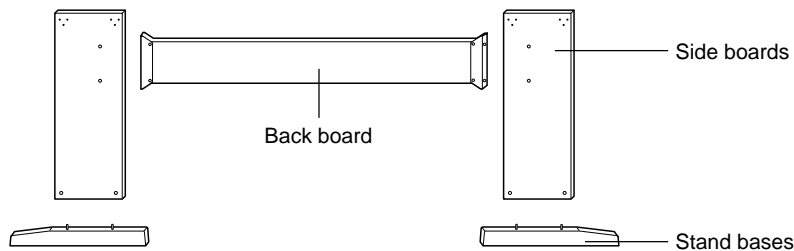

❶ 6 x 70 mm round head screws (4 pcs.)



❷ Joint connectors (4 pcs.)



❸ 3.5 x 16 mm tapping screws (12 pcs.)



❹ 6 x 30 mm round head screws (4 pcs.)



❺ 5 x 16 mm round head screws (4 pcs.)

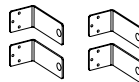

❻ Angle brackets (4 pcs.)

1

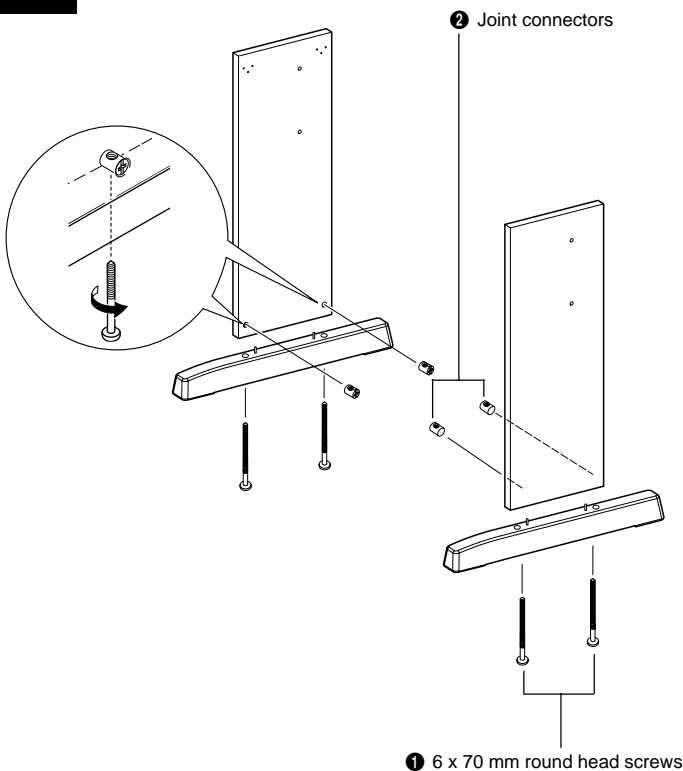

1 Attach the stand bases.

Making sure that the boards are facing the proper direction (the holes should face inside), insert the joint connectors ❷ into the holes as shown. The joint connectors have been installed properly if you can see a plus mark on the connector.

Attach the stand bases to the rear of the side boards, using the 6 x 70 mm round head screws ❶.

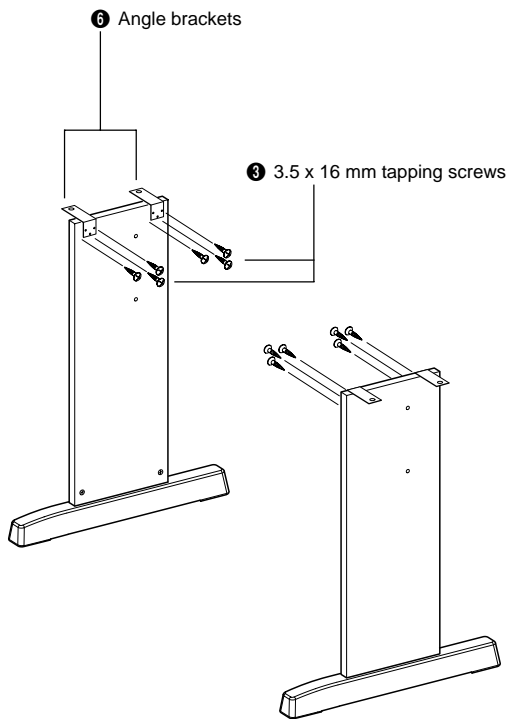
2**2 Attach the angle brackets.**

Attach the angle brackets **6** to the side boards using the 3.5 x 16 mm tapping screws **3**.

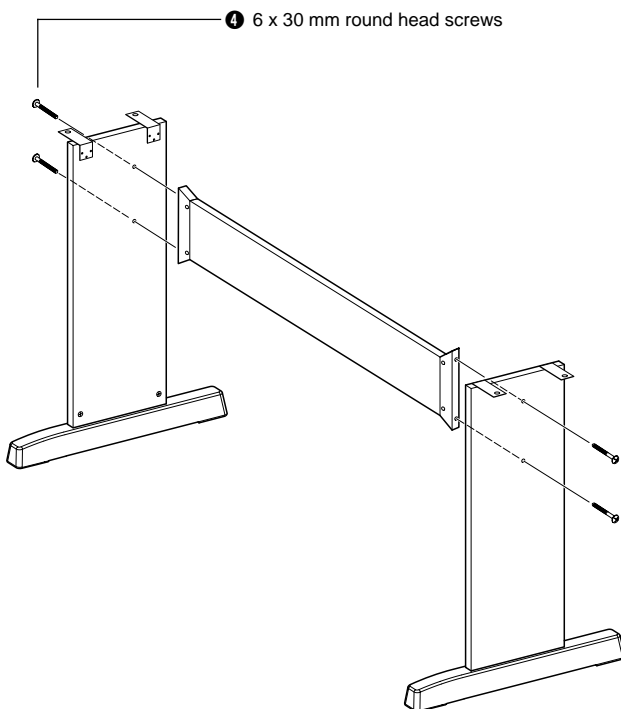
3**3 Attach the back board.**

Attach the back board, using the 6 x 30 mm round head screws **4**.

CAUTION

- Be careful not to drop the back board or touch the sharp metal fittings.

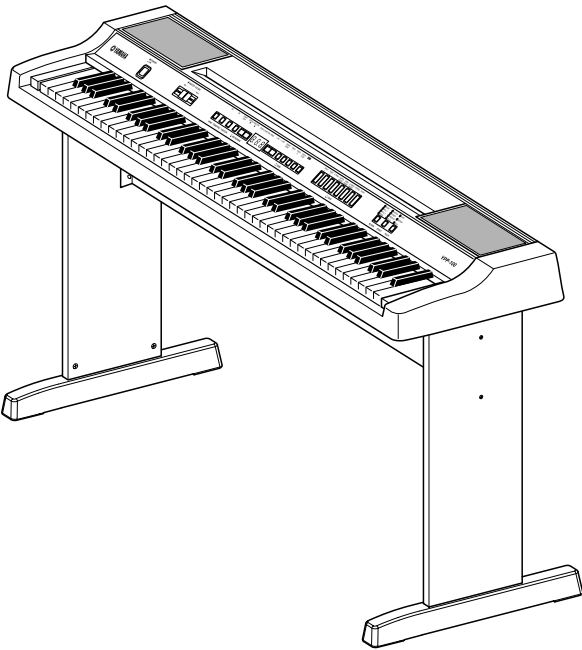
4**4 Put the keyboard on the stand.**

Carefully place the keyboard on the side boards.
Slowly move the keyboard so that the holes on the bottom of the keyboard are properly aligned with the holes on the angle brackets.

⚠ CAUTION

- Be careful not to drop the keyboard or to get your fingers caught between the keyboard and the stand parts.

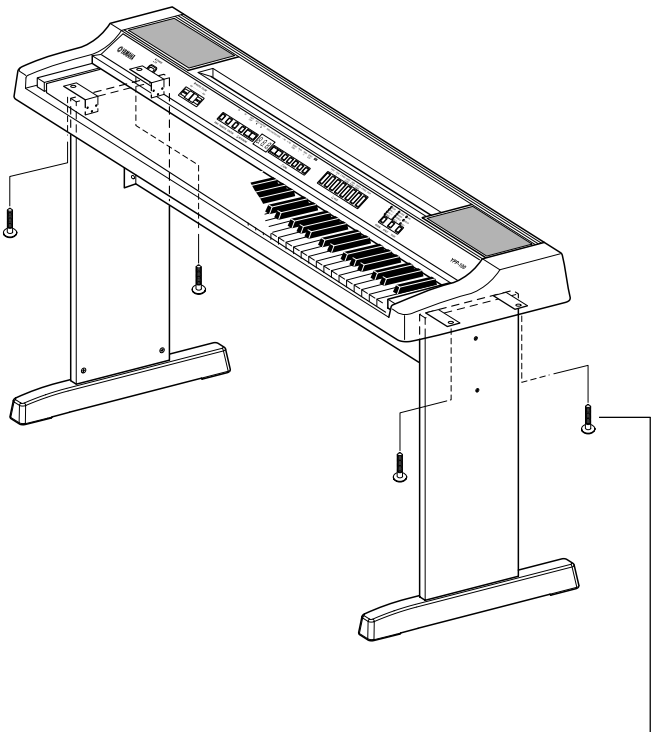
5

5 5 x 16 mm round head screws

5 Install the keyboard to the stand.

Fix the keyboard to the angle brackets, using the 5 x 16 mm round head screws **5**.

■ Post-assembly checklist

Once you've assembled the stand, check the following points:

- Are there any parts left over?
 - ➔ If so, read the assembly instructions again and correct any errors you might have made.
- Is the instrument clear of doors and other movable fixtures?
 - ➔ If not, move the instrument to an appropriate location.
- Does the instrument make a rattling noise when you play it or move it?
 - ➔ If so, properly tighten all screws.
- Also, if the keyboard makes a creaking noise or seems unsteady when you play it, refer carefully to the assembly instructions and diagrams and retighten all screws.

Specifications

	YPP-100
KEYBOARD	76 KEYS (E0 ~ G6)
POLYPHONY	64 NOTES MAX.
VOICE SELECTORS	8 voices
REVERB	ROOM, HALL 1, HALL 2, STAGE
EFFECT	CHORUS, PHASER, TREMOLO, DELAY
TOUCH SENSITIVITY	HARD, MEDIUM, SOFT, FIXED
SONG CONTROLS	TRACK 1, TRACK 2, SONG [START/STOP], REC
PEDAL CONTROLS	SOFT, DAMPER
OTHER CONTROLS	MASTER VOLUME, DEMO, TRANPOSE, FUNCTION, METRONOME [START/STOP], TEMPO/FUNCTION [▼]/[▲], [-/NO]/[+/YES], PRESET SONG, LED Display
JACKS/CONNECTORS	PHONES x 2, OUTPUT R & L/L+R, MIDI IN/OUT, PEDAL DAMPER/SOFT, DC IN 12V
MAIN AMPLIFIERS	6 W x 2
SPEAKERS	12 cm x 2
POWER CONSUMPTION	18 W (when using the power adaptor)
POWER SUPPLY	Adaptor : Yamaha PA-5D or PA-5C AC power adaptor
DIMENSIONS (W x D x H)	1,178 x 410 x 785 mm (46-3/8" x 16-1/8" x 30-7/8") (not including the Music rest)
	1,178 x 410 x 968 mm (46-3/8" x 16-1/8" x 38-1/8") (including the Music rest)
WEIGHT	16.8 kg (37 lbs. 1 oz.) (including the Keyboard stand)
SUPPLIED ACCESSORIES	Owner's Manual, Music Rest, FC5 Footswitch, Keyboard Stand
OPTIONAL ACCESSORIES	Headphones : HPE-150 Footswitch : FC4, FC5 USB/MIDI Interface : UX16

- Specifications and descriptions in this owner's manual are for information purposes only. Yamaha Corp. reserves the right to change or modify products or specifications at any time without prior notice. Since specifications, equipment or options may not be the same in every locale, please check with your Yamaha dealer.

Limited Warranty

90 DAYS LABOR

1 YEAR PARTS

Yamaha Corporation of America, hereafter referred to as Yamaha, warrants to the original consumer of a product included in the categories listed below, that the product will be free of defects in materials and/or workmanship for the periods indicated. This warranty is applicable to all models included in the following series of products:

YPP SERIES OF LIGHT PIANO

If during the first 90 days that immediately follows the purchase date, your new Yamaha product covered by this warranty is found to have a defect in material and/or workmanship, Yamaha and/or its authorized representative will repair such defect without charge for parts or labor.

If parts should be required after this 90 day period but within the one year period that immediately follows the purchase date, Yamaha will, subject to the terms of this warranty, supply these parts without charge. However, charges for labor, and/or any miscellaneous expenses incurred are the consumers responsibility. Yamaha reserves the right to utilize reconditioned parts in repairing these products and/or to use reconditioned units as warranty replacements.

THIS WARRANTY IS THE ONLY EXPRESS WARRANTY WHICH YAMAHA MAKES IN CONNECTION WITH THESE PRODUCTS. ANY IMPLIED WARRANTY APPLICABLE TO THE PRODUCT, INCLUDING THE WARRANTY OF MERCHANT ABILITY IS LIMITED TO THE DURATION OF THE EXPRESS WARRANTY. YAMAHA EXCLUDES AND SHALL NOT BE LIABLE IN ANY EVENT FOR INCIDENTAL OR CONSEQUENTIAL DAMAGES.

Some states do not allow limitations that relate to implied warranties and/or the exclusion of incidental or consequential damages. Therefore, these limitations and exclusions may not apply to you.

This warranty gives you specific legal rights. You may also have other rights which vary from state to state.

CONSUMERS RESPONSIBILITIES

If warranty service should be required, it is necessary that the consumer assume certain responsibilities:

1. Contact the Customer Service Department of the retailer selling the product, or any retail outlet authorized by Yamaha to sell the product for assistance. You may also contact Yamaha directly at the address provided below.
2. Deliver the unit to be serviced under warranty to: the retailer selling the product, an authorized service center, or to Yamaha with an explanation of the problem. Please be prepared to provide proof purchase date (sales receipt, credit card copy, etc.) when requesting service and/or parts under warranty.
3. Shipping and/or insurance costs are the consumers responsibility.* Units shipped for service should be packed securely.

*Repaired units will be returned PREPAID if warranty service is required within the first 90 days.

IMPORTANT: Do NOT ship anything to ANY location without prior authorization. A Return Authorization (RA) will be issued that has a tracking number assigned that will expedite the servicing of your unit and provide a tracking system if needed.

4. Your owners manual contains important safety and operating instructions. It is your responsibility to be aware of the contents of this manual and to follow all safety precautions.

EXCLUSIONS

This warranty does not apply to units whose trade name, trademark, and/or ID numbers have been altered, defaced, exchanged removed, or to failures and/or damages that may occur as a result of:

1. Neglect, abuse, abnormal strain, modification or exposure to extremes in temperature or humidity.
2. Improper repair or maintenance by any person who is not a service representative of a retail outlet authorized by Yamaha to sell the product, an authorized service center, or an authorized service representative of Yamaha.
3. This warranty is applicable only to units sold by retailers authorized by Yamaha to sell these products in the U.S.A., the District of Columbia, and Puerto Rico. This warranty is not applicable in other possessions or territories of the U.S.A. or in any other country.

Please record the model and serial number of the product you have purchased in the spaces provided below.

Model _____ Serial # _____ Sales Slip # _____

Purchased from _____ Date _____
(Retailer)

YAMAHA CORPORATION OF AMERICA
Electronic Service Division
6600 Orangethorpe Avenue
Buena Park, CA 90620

KEEP THIS DOCUMENT FOR YOUR RECORDS. DO NOT MAIL!

For details of products, please contact your nearest Yamaha or the authorized distributor listed below.

Pour plus de détails sur les produits, veuillez-vous adresser à Yamaha ou au distributeur le plus proche de vous figurant dans la liste suivante.

Die Einzelheiten zu Produkten sind bei Ihrer unten aufgeführten Niederlassung und bei Yamaha Vertragshändlern in den jeweiligen Bestimmungsländern erhältlich.

Para detalles sobre productos, contacte su tienda Yamaha más cercana o el distribuidor autorizado que se lista debajo.

NORTH AMERICA

CANADA

Yamaha Canada Music Ltd.
135 Milner Avenue, Scarborough, Ontario,
M1S 3R1, Canada
Tel: 416-298-1311

U.S.A.

Yamaha Corporation of America
6600 Orangethorpe Ave., Buena Park, Calif. 90620,
U.S.A.
Tel: 714-522-9011

CENTRAL & SOUTH AMERICA

MEXICO

**Yamaha de Mexico S.A. De C.V.,
Departamento de ventas**
Javier Rojo Gomez No.1149, Col. Gpe Del
Moral, Deleg. Iztapalapa, 09300 Mexico, D.F.
Tel: 686-00-33

BRAZIL

Yamaha Musical do Brasil LTDA.
Av. Rebouças 2636, São Paulo, Brasil
Tel: 011-853-1377

ARGENTINA

Yamaha de Panamá S.A. Sucursal de Argentina
Viamonte 1145 Piso2-B 1053,
Buenos Aires, Argentina
Tel: 1-4371-7021

PANAMA AND OTHER LATIN AMERICAN COUNTRIES/ CARIBBEAN COUNTRIES

Yamaha de Panamá S.A.
Torre Banco General, Piso 7, Urbanización Marbella,
Calle 47 y Aquilino de la Guardia,
Ciudad de Panamá, Panamá
Tel: 507-269-5311

EUROPE

THE UNITED KINGDOM

Yamaha-Kemble Music (U.K.) Ltd.
Sherbourne Drive, Tilbrook, Milton Keynes,
MK7 8BL, England
Tel: 01908-366700

IRELAND

Danfay Ltd.
61D, Sallynoggin Road, Dun Laoghaire, Co. Dublin
Tel: 01-2859177

GERMANY/SWITZERLAND

Yamaha Europa GmbH.
Siemensstraße 22-34, 25462 Rellingen,
F.R. of Germany
Tel: 04101-3030

AUSTRIA

Yamaha Music Austria
Schleiergasse 20, A-1100 Wien Austria
Tel: 01-60203900

THE NETHERLANDS

Yamaha Music Nederland
Kanaalweg 18G, 3526KL, Utrecht, The Netherlands
Tel: 030-2828411

BELGIUM

Yamaha Music Belgium
Keiberg Imperiastraat 8, 1930 Zaventem, Belgium
Tel: 02-7258220

FRANCE

**Yamaha Musique France,
Division Claviers**
BP 70-77312 Marne-la-Vallée Cedex 2, France
Tel: 01-64-61-4000

ITALY

Yamaha Musica Italia S.P.A.
Viale Italia 88, 20020 Lainate (Milano), Italy
Tel: 02-935-771

SPAIN/PORTUGAL

Yamaha-Hazen Electronica Musical, S.A.
Ctra. de la Coruna km. 17, 200, 28230
Las Rozas (Madrid) Spain
Tel: 91-201-0700

GREECE

Philippe Nakas S.A.
Navarinou Street 13, P.Code 10680, Athens, Greece
Tel: 01-364-7111

SWEDEN

Yamaha Scandinavia AB
J. A. Wettergrens Gata 1
Box 30053
S-400 43 Göteborg, Sweden
Tel: 031 89 34 00

DENMARK

YS Copenhagen Liaison Office
Generatorvej 8B
DK-2730 Herlev, Denmark
Tel: 44 92 49 00

FINLAND

F-Musiikki Oy
Kluuvikatu 6, P.O. Box 260,
SF-00101 Helsinki, Finland
Tel: 09 618511

NORWAY

Norsk filial av Yamaha Scandinavia AB
Grini Næringspark 1
N-1345 Østerås, Norway
Tel: 67 16 77 70

ICELAND

Skifan HF
Skeifan 17 P.O. Box 8120
IS-128 Reykjavik, Iceland
Tel: 525 5000

OTHER EUROPEAN COUNTRIES

Yamaha Europa GmbH.
Siemensstraße 22-34, 25462 Rellingen,
F.R. of Germany
Tel: 04101-3030

AFRICA

**Yamaha Corporation,
Asia-Pacific Music Marketing Group**
Nakazawa-cho 10-1, Hamamatsu, Japan 430-8650
Tel: 053-460-2312

MIDDLE EAST

TURKEY/CYPRUS

Yamaha Europa GmbH.
Siemensstraße 22-34, 25462 Rellingen,
F.R. of Germany
Tel: 04101-3030

OTHER COUNTRIES

Yamaha Music Gulf FZE
LB21-128 Jebel Ali Freezone
P.O.Box 17328, Dubai, U.A.E.
Tel: 971-4-881-5868

ASIA

HONG KONG

Tom Lee Music Co., Ltd.
11/F., Silvercord Tower 1, 30 Canton Road,
Tsimshatsui, Kowloon, Hong Kong
Tel: 2737-7688

INDONESIA

**PT. Yamaha Music Indonesia (Distributor)
PT. Nusantik**
Gedung Yamaha Music Center, Jalan Jend. Gatot
Subroto Kav. 4, Jakarta 12930, Indonesia
Tel: 21-520-2577

KOREA

Yamaha Music Korea Ltd.
Tong-Yang Securities Bldg. 16F 23-8 Yoido-dong,
Yongdungpo-ku, Seoul, Korea
Tel: 02-3770-0661

MALAYSIA

Yamaha Music Malaysia, Sdn., Bhd.
Lot 8, Jalan Perbandaran, 47301 Kelana Jaya,
Petaling Jaya, Selangor, Malaysia
Tel: 3-703-0900

PHILIPPINES

Yupangco Music Corporation
339 Gil J. Puyat Avenue, P.O. Box 885 MCPO,
Makati, Metro Manila, Philippines
Tel: 819-7551

SINGAPORE

Yamaha Music Asia Pte., Ltd.
11 Ubi Road #06-00, Meiban Industrial Building,
Singapore
Tel: 65-747-4374

TAIWAN

Yamaha KHS Music Co., Ltd.
10F, 150, Tun-Hwa Northroad,
Taipei, Taiwan, R.O.C.
Tel: 02-2713-8999

THAILAND

Siam Music Yamaha Co., Ltd.
121/60-61 RS Tower 17th Floor,
Ratchadaphisek RD., Dindaeng,
Bangkok 10320, Thailand
Tel: 02-641-2951

THE PEOPLE'S REPUBLIC OF CHINA AND OTHER ASIAN COUNTRIES

**Yamaha Corporation,
Asia-Pacific Music Marketing Group**
Nakazawa-cho 10-1, Hamamatsu, Japan 430-8650
Tel: 053-460-2317

OCEANIA

AUSTRALIA

Yamaha Music Australia Pty. Ltd.
Level 1, 99 Queensbridge Street, Southbank, Victoria
3006, Australia
Tel: 3-9693-5111

NEW ZEALAND

Music Houses of N.Z. Ltd.
146/148 Captain Springs Road, Te Papapa,
Auckland, New Zealand
Tel: 9-634-0099

COUNTRIES AND TRUST TERRITORIES IN PACIFIC OCEAN

**Yamaha Corporation,
Asia-Pacific Music Marketing Group**
Nakazawa-cho 10-1, Hamamatsu, Japan 430-8650
Tel: 053-460-2312

HEAD OFFICE Yamaha Corporation, Pro Audio & Digital Musical Instrument Division
Nakazawa-cho 10-1, Hamamatsu, Japan 430-8650
Tel: 053-460-3273



Yamaha PK CLUB (Portable Keyboard Home Page, English only)

<http://www.yamahaPKclub.com/>

Yamaha Manual Library

<http://www2.yamaha.co.jp/manual/english/>

M.D.G., Pro Audio & Digital Musical Instrument Division, Yamaha Corporation
© 2002 Yamaha Corporation

V880950 PO???.?-???? Printed in China