

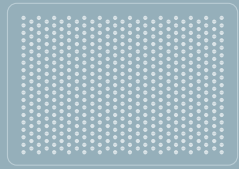

L1
L2
L3
L4



CLEAR



TENORI-ON

M A N U A L

TNR-W

designed by Toshio Iwai & Yamaha

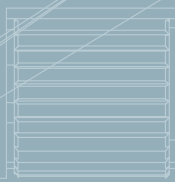

TENORI-ON
LAYER 01 - Score 01000-01
INST 01 / 01 : Photon
TIME 00 : 00 : 00 ■ STOP

About the Manuals

The TENORI-ON is provided with the four manuals listed below.

Quick Guide

The Quick Guide provides instructions on setup and basic operation that will get you started as quickly as possible.



TENORI-ON Manual (This manual; PDF)

The manual is provided as an electronic document on the supplied CD-ROM, and it provides detailed descriptions and procedures that will help you take full advantage of the TENORI-ON's many advanced features. Refer to the Quick Guide for basic information such as turning on the power, the functions of the panel controls, and more.



Precautions

This document lists a number of points you need to be aware of in order to use the TENORI-ON properly and safely. Please read it carefully. Guarantee information and after-service contact details are also included.



Installation Guide

Explains the procedure for installing the "TENORI-ON User Voice Manager" software that is included on the supplied CD-ROM on your computer.

Using the PDF Manual

- Click the item you want to refer to in the "Bookmarks" index to the left of the main display window to go to the corresponding page. Click the "Bookmarks" tab to open the index if it is not showing.
- Click the page numbers that appear in the table of contents to go directly to the corresponding page.
- Select "Find" or "Search" from the Adobe Reader "Edit" menu and enter a key word to locate related information anywhere in the document. Click an item in the list that appears after searching to go directly to the corresponding page.

NOTE The names and positions of menu items may vary according to the version of Adobe Reader being used.

The illustrations and LCD screens as shown in this owner's manual are for instructional purposes only, and may appear somewhat different from those on your instrument.

Copying of the commercially available musical data including but not limited to MIDI data and/or audio data is strictly prohibited except for your personal use.

When using a power adaptor, even when the STANDBY/ON switch is in the "STANDBY" position, electricity is still flowing to the instrument at the minimum level. When you are not using the instrument for a long time, make sure you unplug the AC power adaptor from the wall AC outlet.

Please note that there may be slight variations in the color of the LED buttons.

Contents

The TENORI-ON Is	4	Edit Menu	54
Layers and Performance Modes	4	1. Copy this Block	55
Layers and Blocks	5	2. Clear this Block	55
Voices	6	3. Copy this Layer	56
Connecting to Second TENORI-ON or Computer	7	4. Clear this Layer	57
Song Recording and Playback	9	5. Clear All Blocks	57
SD Memory Card File Types and Operations	9	6. Reset All Blocks	58
Non-performance Functions (Interior and Power Save Modes)	10	Preference Menu	59
Performance Modes	12	1. Quantize	60
Basic Operation	12	2. Push Sensitivity	60
Score Mode	15	3. Master Tuning	60
Random Mode	17	4. Local Control	61
Draw Mode	18	5. Synchronize	61
Bounce Mode	19	6. Loop Indicator	61
Push Mode	20	File Menu	62
Solo Mode	21	1. Song	64
Parameter Settings	22	2. All Blocks	68
Setting Parameters with the Function Buttons	23	3. Current Block	73
[L1] Instrument	24	4. Current Layer	78
[L2] Sound Length	25	5. All Settings	83
[L3] Octave	26	6. Samplings	88
[L4] Score Mode Loop Point	27	Effect Menu	99
[L4] Random Mode Rotation	28	1. Reverb Type	99
[L5] Loop Speed	29	2. Reverb Param	100
[R1] Layer No.	30	3. Chorus Type	100
[R2] Master Tempo	31	4. Chorus Param	100
[R3] Master Transpose	32	Interior Menu	101
[R4] Volume	33	1. Interior Start	101
[R5] Block Number	34	2. Interior Type	102
Setting Parameters with the Jog Dial	36	3. Saver Type	102
Data Storage and Initialization	39	4. Saver Time	103
Play Menu	42	5. Time Signal ON/OFF	103
1. Hardware Volume	43	6. Alarm ON/OFF	103
2. Master Tempo	43	7. Set Alarm	104
3. Master Scale	44	8. Save As Time Signal	104
4. Master Transpose	45	9. Save As Alarm	105
5. Master Loop Speed	45	10. Clock Adjust	105
6. Master Loop Point	46	System Menu	106
7. Reset Loop Timing	46	1. Save As Default	106
8. Mute	47	2. SD Format	107
Layer Menu	48	3. Owner Name	107
1. Instrument	49	4. Version Check	108
2. Volume	50	5. Factory Reset	108
3. Loop Speed	51	Recording Menu	109
4. Sound Length	52	Appendix	111
5. Panpot	53	Display Message List	111
6. Animation	53	Troubleshooting	113
		MIDI Data Format	115
		TENORI-ON MIDI Transmit/Receive Event Specifications ..	115
		MIDI Implementation Chart	118
		Voice List	119
		Index	122



4

Layers and Blocks

The TENORI-ON handles a complete set of 16 layers as a "block." You can have up to 16 blocks, each with up to 16 layers. You can switch between blocks instantaneously to create varied performances with plenty of musical interest.

Parameters that apply to individual layers (voice, pitch, note entry position, etc.) are internally managed separately from parameters that apply to individual blocks (master tempo, master transpose, master scale, etc.). This makes it possible, for example, to create variations within the same song in which only the note timing is altered, and instantly switch between variations. The only exception is that layers have the same voices throughout all blocks (e.g. layer 3 in block 1 will use the same voice as layer 3 in block 10), so changing blocks won't change the voice for a given layer.

The Layer/Block Relationship

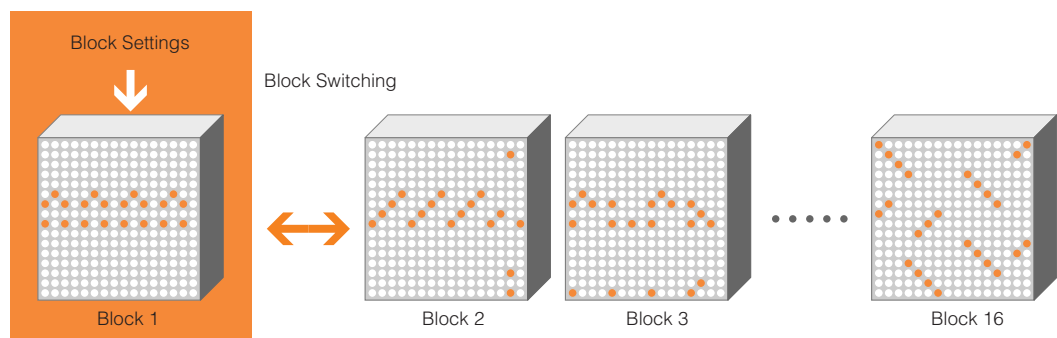

Since the blocks will usually hold similar performance data, convenient block copy functions are provided.

[Reference]

- * Block → Block Copy Block Number → [Page 34](#)
Copy this Block → [Page 55](#)
- * Layer → Layer Copy Block Number → [Page 34](#)
Copy this Layer → [Page 56](#)
- * Block Switching Block Number → [Page 34](#)

Voices

The various sounds that can be played by the TENORI-ON are called "voices." The TENORI-ON can use up to 256 voices, 253 of which are built in and play via the internal MIDI tone generator. A wide range of voices including piano, strings, drums, percussion, sound effects, and voices developed specifically for use with the TENORI-ON are provided. The remaining three voice numbers are reserved for voice samples provided by the user. Samples you have created using your computer or downloaded can be converted and assigned for use with the TENORI-ON by using the supplied TENORI-ON User Voice Manager software, saved to an SD Memory Card, and then loaded into the TENORI-ON. User voice can be played in the same way as the internal MIDI tone generator voices.

A different voice can be assigned to each layer, and all notes played on a given layer will be played using the same voice. Multiple layers with different voices assigned to each can be played simultaneously. But of course you could also assign the same voice to multiple layers. Maximum polyphony (the maximum number of notes that can be played simultaneously) is 32. If more than 32 notes are played at the same time, only the last (newest) 32 notes will be played.

The voices can be varied by adjusting gate time (the length of the notes), transposition, octave shift, and other parameters. There's also a Master Tuning parameter that can be used to tune the MIDI tone generator voices.

The ionian C scale is assigned to layer pitches by default (i.e. the LED buttons produces pitches corresponding to the white keys on a piano). The default scale can be changed via the menu.

MIDI drum voices have no pitch variation. Each LED button produces the sound of a different drum or percussion instrument. For this reason scale, octave shift, and transpose settings have no effect on drum voices.

Reverb and chorus effects can be applied to the voices. The effect type and depth can be set as required.

A number of other variations can be applied to voices. Refer to the items listed below for more information.

[Reference]

- * Changing Voices Instrument → [Page 24, 49](#)
- * Adjusting Volume Hardware Volume → [Page 43](#)
Volume → [Page 33, 50](#)
- * Changing Note Length (Gate Time) Sound Length → [Page 25, 52](#)
- * Octave Shift Octave → [Page 26](#)
- * Transposition Master Transpose → [Page 32, 45](#)
- * Tuning Master Tuning → [Page 60](#)
- * Changing Scales Master Scale → [Page 44](#)

- * Panning (Stereo Positioning) Panpot → [Page 53](#)
- * Effects (Reverb and Chorus) Effect Menu → [Page 99](#)
- * Loading Samples. Samplings → [Page 88](#)
The supplied "TENORI-ON User Voice manager" software
installation guide.

Connecting to Second TENORI-ON or Computer

The TENORI-ON has a mini-DIN type MIDI connector that, via the supplied MIDI cable adaptor, can be connected to a second TENORI-ON to allow synchronized performance, or to a computer to allow recording of the instrument's MIDI output.

[Reference]

- * MIDI Specifications MIDI Data Format → [Page 115](#)
MIDI Implementation Chart → [Page 118](#)

Transmitting the TENORI-ON MIDI Output to a Computer

TENORI-ON performance data (MIDI data) can be transmitted to a computer where it can be recorded and processed.

● Connecting to a Computer

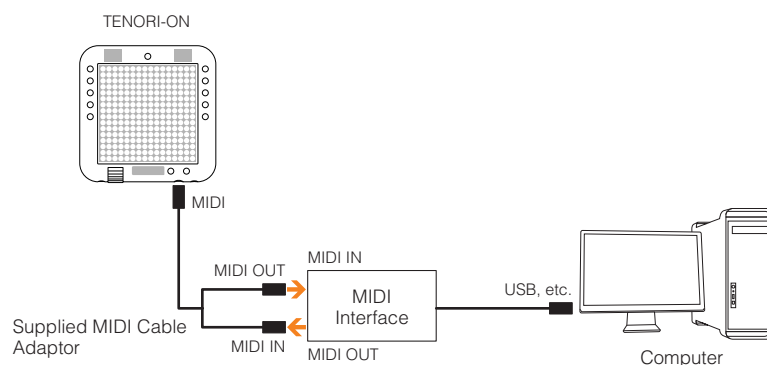

● Synchronized Performance with Other TENORI-ON Instruments

Two TENORI-ON instruments can be connected via MIDI so that when playback is started or paused on the "Master" TENORI-ON, the "Slave" TENORI-ON follows. To use this capability one of the connected TENORI-ON instruments must be set to Master status and the other must be set to Slave. It is also possible to synchronize more than two TENORI-ON instruments in this way. In such cases only one TENORI-ON can function as the Master while all others are Slaves.

[Reference]

- * Master/Slave Settings for Synchronized Performance Synchronize → [Page 61](#)

Connecting Two TENORI-ON Instruments

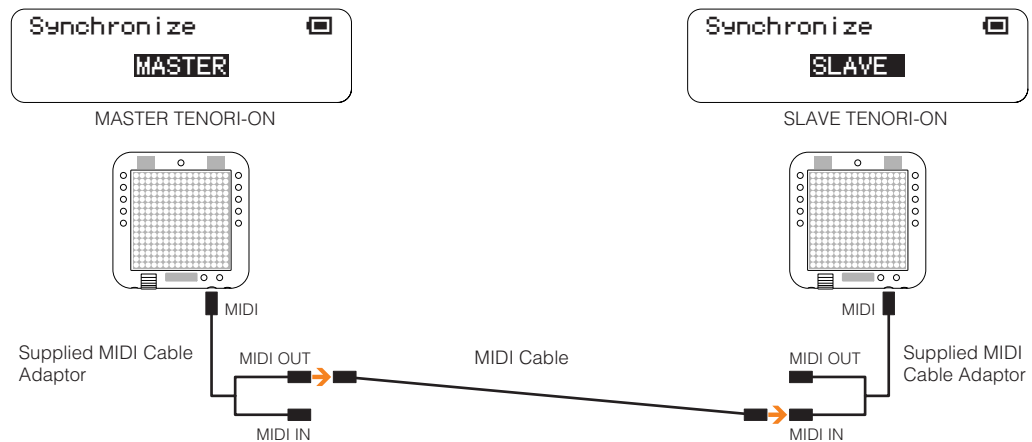

Connecting More than Two TENORI-ON Instruments

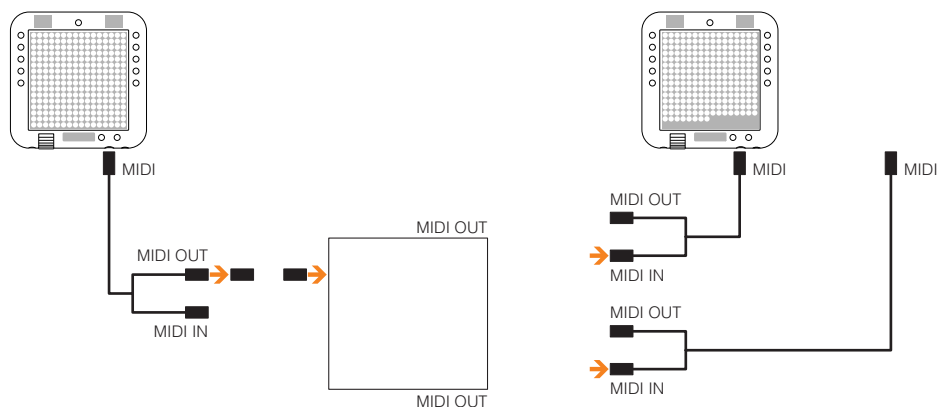

Power-on Procedure

If you have the TENORI-ON connected to an external sound system, it is important to turn the devices in your audio chain on in the correct order to prevent unwanted noise as well as possible damage to your equipment.

Before turning the power on, make sure that any volume controls on all devices are turned all the way down.

When turning power on, you should normally begin with the source and end with power amplifiers or powered speakers. Here's an example:

1. TENORI-ON
2. Mixer
3. Powered Speakers

The opposite applies when turning power off:

1. Powered Speakers
2. Mixer
3. TENORI-ON

Song Recording and Playback

Performance operations carried out on the TENORI-ON can be recorded in real time and saved to an SD Memory Card as a Song File.

Song Files contain all performance operations (note entry, etc.), settings (voice selection, tempo, etc.) and other user operations carried out in all layers and blocks in real time. A recorded Song File can then be loaded in into the TENORI-ON and played back, precisely reproducing LED button and function button operations precisely as they were recorded. Song files can be transferred to a computer and made available on the Internet or attached to email messages to other TENORI-ON users.

[Reference]

- * Recording TENORI-ON Performances Recording Menu → [Page 109](#)
- * Song File Operations File Menu/Song → [Page 64](#)
- * Using the Supplied Software The supplied "TENORI-ON User Voice manager" software installation guide.

SD Memory Card File Types and Operations

In addition to Song Files, the following file types can be saved to and loaded from SD memory cards, as well as renamed or deleted as required.

File Type	Content
All Blocks	Performance data and settings for all layers and blocks.
Current Block	Performance data and settings for all layers in the current block.
Current Layer	Performance data and settings for the current layer in the current block.
All Settings	All data other than the note entry points for all layers and blocks.
Samplings	Samples you have created on a computer or downloaded from the Internet can be converted to TENORI-ON file format using the supplied TENORI-ON User Voice Manager and loaded into the instrument's user voice memories (voice numbers <01/16,> <02/16,> and <03/16>) for playback. User voices can be saved to and loaded from SD Memory Cards.

[Reference]

- * File Operations File Menu → [Page 62](#)
- * Sample Save/Load Samplings → [Page 88](#)
The supplied "TENORI-ON User Voice manager" software installation guide.

Non-performance Functions (Interior and Power Save Modes)

When set to the Interior Mode the TENORI-ON will function as a clock and/or play back songs automatically. There's also a Power Save Mode that automatically puts the TENORI-ON to "sleep" if it isn't operated for a specified period of time.

Interior Mode

You can set up the TENORI-ON to function as a clock and play back songs automatically. It can play a composition you have created as an alarm or time hourly reminder. Alternatively, it can be set to play a song you have created or the demo song while the time is being displayed.

Power Save Mode

This energy-saving feature stops the sequencer and turns all LED buttons off.

● Interior Mode Operation (Interior Types)

Song (DEMO)	Plays the pre-programmed TENORI-ON demo song.
SONG (SD)	Randomly plays Song Files from an SD Memory Card.
Clock	Displays the time on the TENORI-ON matrix.
Clock + Song (DEMO)	Displays the time on the TENORI-ON matrix while playing the pre-programmed TENORI-ON demo song. The demo song light animation appears on the matrix in addition to the time.
Clock + Song (SD)	Displays the time on the TENORI-ON matrix while randomly playing Song Files from an SD Memory Card. The song light animation appears on the matrix in addition to the time.

● Clock Functions

- The hour and minute are displayed numerically on the LED button matrix in 24-hour format. Seconds are indicated by a dot that moves around the outermost 60 LED buttons, and an "expanding-square" light animation that occurs once per second.
- The hour reminder sound can be turned ON or OFF.
- The alarm can be turned ON or OFF.
- The alarm time can be set as required.
- Original hourly reminder and alarm sounds can be created.

[Reference]

* Interior Mode Settings Interior Menu → [Page 101](#)

Example: 15:39:18 (three thirty-nine PM and eighteen seconds)

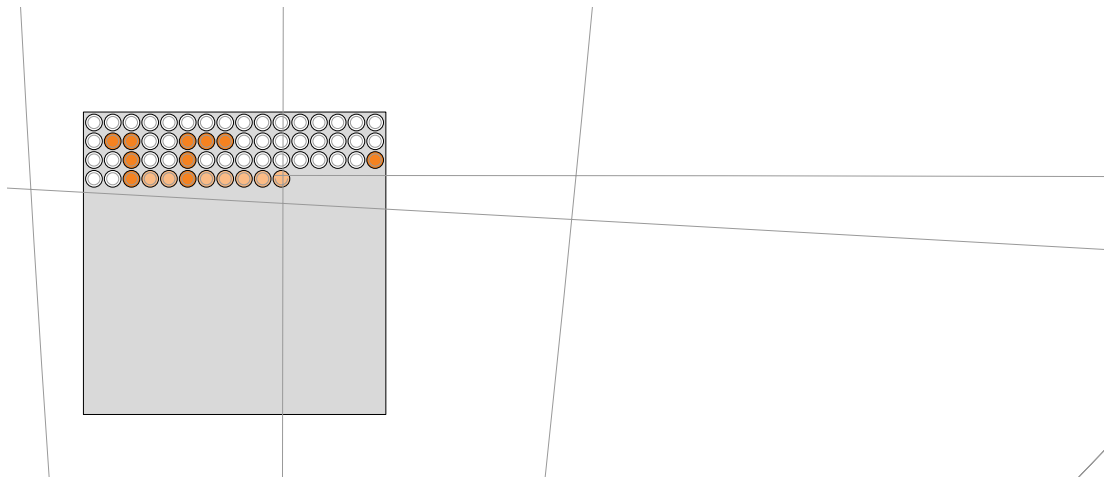

Performance Modes

This section describes the 6 TENORI-ON performance modes that are assigned to the 16 layers. A thorough understanding of the modes will help you to create more interesting, unique performances.

Basic Operation

The basic settings and operations used for TENORI-ON performance are described below.

● The Display

When the TENORI-ON is turned on layer 1 and the Score mode will be selected. You can begin creating compositions right away by simply entering notes via the LED buttons. When the power is initially turned on the start-up screen will appear for a few seconds, and then the status display will appear. The status display will be shown during TENORI-ON performance. To return to the Status display, press the [CANCEL] button as many times as necessary.

Status Display

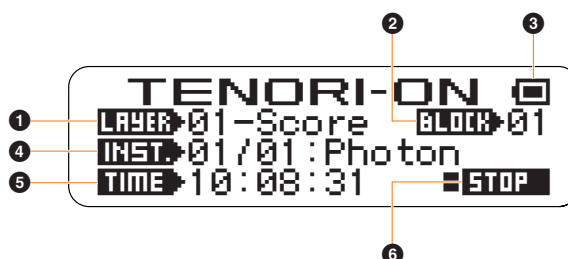

- 1 LAYER [LAYER] The current layer number and mode.
- 2 BLOCK [BLOCK] The current block number.
- 3 POWER [POWER] Current power status.
 [AC] AC adaptor in use.
 [FULL] Battery full (battery power).
 [HALF] Battery half full (battery power).
 [ALMOST] Battery almost depleted (battery power).
 [DEPLETED] Battery depleted (battery power).
- 4 INST [INST] Current voice number and name.
- 5 TIME [TIME] / REC [REC] / PLAY [PLAY] Displays the time during normal performance: [TIME] h:m:s].
 Displays elapsed time during recording: [REC] h:m:s].
 Displays elapsed time during playing: [PLAY] h:m:s]
- 6 STOP [STOP] / START [START] [STOP] during normal performance and recording.
 [START] when playback is stopped.



When the power status indicator shows that the batteries are almost depleted ([ALMOST]), replace all six batteries with new ones as soon as possible.

If the remaining battery power drops even lower [DEPLETED] will be displayed and SD Memory Card access will not be possible. Change the batteries immediately.

Basic Settings and Editing During Performance

● [CLEAR] button

Press the [CLEAR] button to clear all active notes from the layer.

Clear All Active Notes from the Layer	Press the [CLEAR] button briefly.
Clear All Active Notes from All Layers and Blocks	Press and hold the [CLEAR] button.

● Function Button Settings/Edits

Basic settings and edits are made during performance using the [L1] — [L5] functions buttons, [R1] — [R5] functions buttons, and LED buttons.

[Reference]

- * Using the Function Buttons TENORI-ON Quick Guide, Setting Parameters with the Function Buttons → [Page 23](#)

Changing Voices	Use the LED buttons while holding the [L1] button (→ Page 24).
Change Note Length	Use the LED buttons while holding the [L2] button (→ Page 25).
Change the Octave	Use the LED buttons while holding the [L3] button (→ Page 26).
Change the Score Mode Loop Range	Use the LED buttons while holding the [L4] button (→ Page 27).
Rotate Shape in the Random Mode	Use the LED buttons while holding the [L4] button (→ Page 28).
Adjust Loop Speed	Use the LED buttons while holding the [L5] button (→ Page 29).
Change Layers	Use the LED buttons while holding the [R1] button (→ Page 30).
Change the Tempo	Use the LED buttons while holding the [R2] button (→ Page 31).
Transposition	Use the LED buttons while holding the [R3] button (→ Page 32).
Adjust the Layer Volume	Use the LED buttons while holding the [R4] button (→ Page 33).
Change Blocks, Copy Layer, Copy Block	Use the LED buttons while holding the [R5] button (→ Page 34).

• Menu Settings/Edits

Detailed TENORI-ON settings can be accessed and edited by using the jog dial to select menu items on the LCD display. File save and load operations can also be accessed this way.

[Reference]

* Using the Menus Setting Parameters with the Jog Dial → [Page 36](#)

Stop Playback	Press the [OK] button at the point you want to stop playback while the Status Display is shown. Press the [OK] button a second time and playback will resume from that point.
Adjust Overall Volume	Use the jog dial and [OK] button to go to the "Hardware Volume" display (→ Page 43).
Mute Output	Use the jog dial and [OK] button to go to the "Mute" display (→ Page 47).
Adjust Layer Panning	Use the jog dial and [OK] button to go to the "Panpot" display (→ Page 53).
Apply a Reverb or Chorus Effect	Use the jog dial and [OK] button to go to the "Effect menu" display (→ Page 99).
Change the Light Animation	Use the jog dial and [OK] button to go to the "Animation" display (→ Page 53).
Clear All Active Notes from the Layer	Press the [CLEAR] button briefly. Alternatively, use the jog dial and [OK] button to go to the "Clear this layer" display (→ Page 57).
Clear All Active Notes from All Layers and Blocks	Press and hold the [CLEAR] button. Alternatively, use the jog dial and [OK] button to go to the "Clear All Blocks" display (→ Page 57).
Reset All Layers and Blocks	Use the jog dial and [OK] button to go to the "Reset All Blocks" display (→ Page 58).
Copy Active Notes	Use the jog dial and [OK] button to go to the "Copy this block" display (→ Page 55) or "Copy this layer" display (→ Page 56).
Change Scales	Use the jog dial and [OK] button to go to the "Master Scale" display (→ Page 44).
Adjust MIDI Tone Generator Tuning	Use the jog dial and [OK] button to go to the "Master Tuning" display (→ Page 60).
Reset the Playback Loop	Use the jog dial and [OK] button to go to the "Reset Loop Timing" display (→ Page 46).
Determines whether notes played on the TENORI-ON will sound via the internal tone generator or not	Use the jog dial and [OK] button to go to the "Local Control" display (→ Page 61).
Adjust the LED Button Long-press Time	Use the jog dial and [OK] button to go to the "Push Sensitivity" display (→ Page 60).
File Operations	Use the jog dial and [OK] button to go to the "File menu" display (→ Page 62).
Format an SD Memory Card	Use the jog dial and [OK] button to go to the "SD Format" display (→ Page 107).
Factory Reset	Use the jog dial and [OK] button to go to the "Factory Reset" display (→ Page 108).
Record a performance	Use the jog dial and [OK] button to go to the "Recording Menu" display (→ Page 109).

More detailed menu settings than listed in the above chart are described in the following pages. Understand all the possibilities offered by the TENORI-ON can help you gain maximum enjoyment from the instrument.

Score Mode

The Score Mode is assigned to TENORI-ON layers 1 — 7.

The Score Mode is selected by default when the power is turned on.

Score Mode Operation

In this mode the TENORI-ON interface functions like a musical "score" on which you can write the notes to be played in one musical measure via the 16 x 16 LED button matrix. The "loop indicator" (four lit LED buttons in a vertical column) proceeds from left to right, and active notes will play when the loop indicator passes over them. Light animation will also occur for each note played. The loop indicator will loop back to the beginning once the right edge of the matrix is reached.

Press the [OK] button while the highlighted "STOP" indicator in the lower right corner of the LCD display is shown to temporarily pause loop playback. The loop indicator will stop at the position at which the [OK] button is pressed. Press the [OK] button a second time and loop playback will resume from the point at which it was paused. You can change the point from which playback will resume by moving the paused loop indicator to the desired position (press an LED button at the desired start position).

[Reference]

- * Setting the loop beginning and end points. (Master Loop Point → [Page 46](#), Loop Point → [Page 27](#))
- * Changing the loop indicator speed (beat speed). (Loop Speed → [Page 29, 51](#))
- * Turning the loop indicator off. (Loop Indicator → [Page 61](#))
- * Changing the light animation. (Animation → [Page 53](#))

The horizontal axis corresponds to time and the vertical axis corresponds to the pitch of the notes played. The factory default scale for the vertical axis is an ionian scale, corresponding to the white keys on a piano.

[Reference]

- * Selecting a scale other than the ionian scale. (Master Scale → [Page 44](#))
- * Changing octaves. (Octave → [Page 26](#))

If a drum voice is selected each note on the vertical axis does not correspond to a different pitch in the scale, but rather to a different instrument in the drum "kit." See "Voices" on [Page 6](#).

Press an LED button briefly to play the sound assigned to it. If you hold the LED button a bit longer it will remain lit and will become an active note. Press and hold an active note to deactivate it (the LED button will go out).

[Reference]

- * The press-and-hold time for note entry can be changed as required. (Push Sensitivity → [Page 60](#))
- * The note length (gate time) can be changed as required. (Sound Length → [Page 25, 52](#))

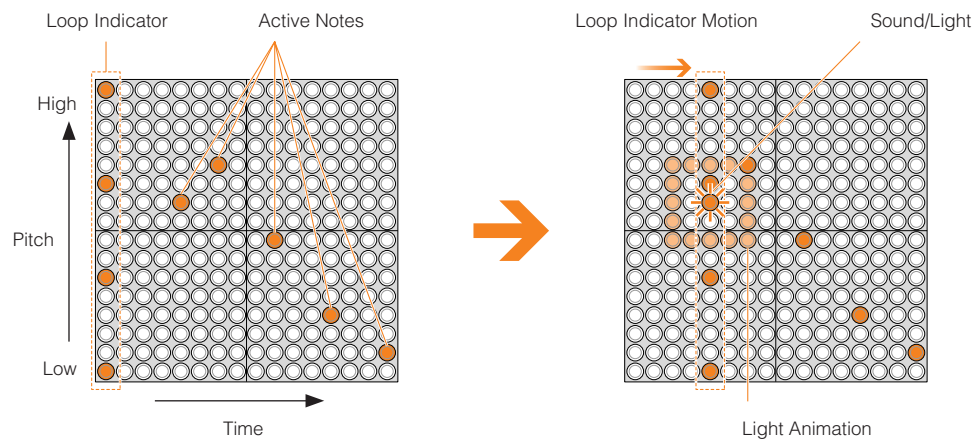

Random Mode

The Random Mode is assigned to layers 8 — 11.

Random Mode Operation

If you press an LED button long enough to enter an active note in the Random Mode, the active note will play back repeatedly. If you then enter a few more active notes, the lights will "travel" from note to note, in the order entered, and the active notes will sound when the traveling light passes over them. The Random Mode thus produces a totally different type of loop from the Score Mode.

[Reference]

- * The next active note will play at the specified 1-beat timing. The length of each beat can be adjusted via the Loop Speed parameter (Loop Speed → [Page 29, 51](#). Master Loop Speed → [Page 45](#)).

You can even spin loop-shapes you create in the Random Mode by holding the [L4] button and running a finger around the matrix in the direction and at the speed of the desired spin. The pitches of the notes will change accordingly as the shape spins, producing loop sound effects.

[Reference]

- * Rotation → [Page 28](#)

Press an LED button briefly to play the sound assigned to it. If you hold the LED button a bit longer it will remain lit and will become an active note. Press and hold an active note to deactivate it (the LED button will go out).

[Reference]

- * The press-and-hold time for note entry can be changes as required. (Push Sensitivity → [Page 60](#))
- * The note length (gate time) can be changed as required. (Sound Length → [Page 25, 52](#))

As in the Score Mode the factory default scale for the vertical axis is an ionian scale, corresponding to the white keys on a piano. Nothing is assigned to the horizontal axis, but the timing between notes will depend on the distance between the notes on the matrix.

[Reference]

- * Selecting a scale other than the ionian scale. (Master Scale → [Page 44](#))
- * Changing octaves. Octave → [Page 26](#))
- * Changing the light animation. (Animation → [Page 53](#))

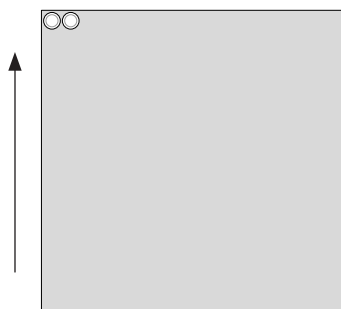

Draw Mode

The Draw Mode is assigned to layers 12 and 13.

Draw Mode Operation

In this mode you can press individual LED buttons or draw lines or curves on the matrix, and those actions will be played back and repeated. You can keep adding to your "composition" during playback to build up thick sonic textures.

[Reference]

- * Recording and playback of LED button operations loops in 16th-beat increments in the Score mode. LED button operations are played back in the next loop. The loop length (cycle) can be adjusted via the Loop Speed parameter (Loop Speed → [Page 29, 51](#). Master Loop Speed → [Page 45](#)).
- * In the Draw Mode you cannot clear only a part of the performance. The entire layer can be cleared by pressing the [CLEAR] button.

When a button is pressed it will sound and be activated immediately. In the Draw Mode there is no need to press and hold a button to enter a note. Because this, in the Draw mode is possible to "draw sounds" by running your finger(s) over the LED button matrix in various ways.

[Reference]

- * The note length (gate time) can be changed as required. (Sound Length → [Page 25, 52](#))

As in the Score Mode the factory default scale for the vertical axis is an ionian scale, corresponding to the white keys on a piano. Nothing is assigned to the horizontal axis, but you can run your finger over the matrix horizontally to produce notes in quick succession.

[Reference]

- * Selecting a scale other than the ionian scale. (Master Scale → [Page 44](#))
- * Changing octaves. (Octave → [Page 26](#))
- * Changing the light animation. (Animation → [Page 53](#))

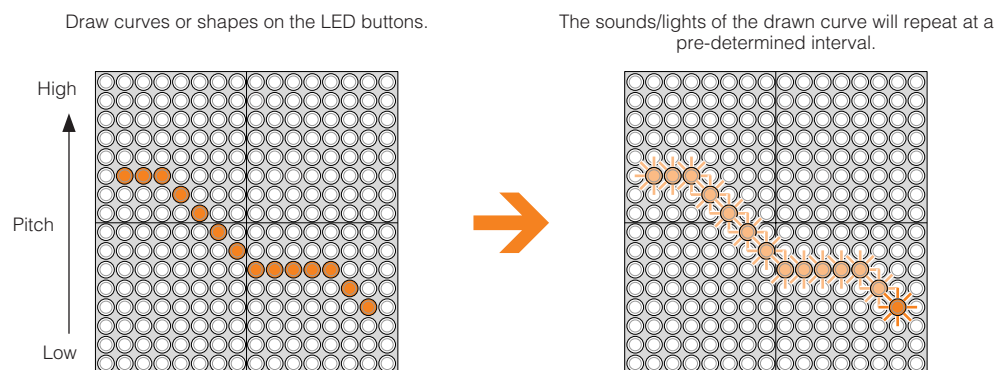

Bounce Mode

The Bounce Mode is assigned to layer 14.

Bounce Mode Operation

Press an LED button and the light will "drop" from that button, bounce back from the bottom of the matrix, and repeat. The corresponding note will sound when the light bounces at the bottom row.

The higher the entry point, the longer the interval between the sound. By choosing appropriate entry points you can set the repeat interval as required.

[Reference]

- * The illuminated dots move at a speed corresponding to the timing of the LED buttons: i.e. 1 beat per dot. (Loop Speed → [Page 29, 51](#). Master Loop Speed → [Page 45](#)).

In the Bounce Mode the pitches are arranged horizontally. As in the Score Mode the factory default scale is an ionian scale, corresponding to the white keys on a piano, with the lowest pitch on the left and the highest on the right.

Press the lowest LED button to stop activity in that column.

[Reference]

- * Selecting a scale other than the ionian scale. (Master Scale → [Page 44](#))
- * Changing octaves. (Octave → [Page 26](#))
- * The note length (gate time) can be changed as required. (Sound Length → [Page 25, 52](#))

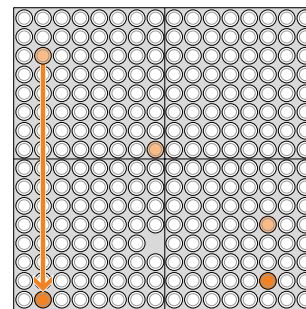
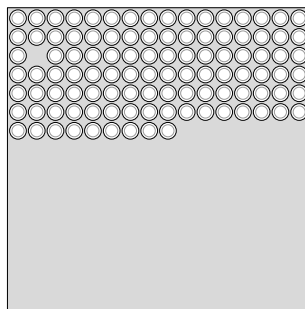

Push Mode

The Push Mode is assigned to layer 15.

Push Mode Operation

In this mode if you press and hold an LED button the sound of the corresponding note will begin to change gradually. The way the note changes will depend on the voice used (this feature will only work with sustained voices that have a time-based tonal change in the sustained portion of the voice's envelope). Voices 15/01 through 15/16 have been specifically created for use in the Push mode, and are recommended.

The flashing surrounding the pressed button will gradually get brighter and wider.

If the button is held briefly the note and flashing will stop when you release it, but if you hold the button for longer the note and flashing will continue even after the button is released.

To stop a note that is sounding, press the corresponding LED button (at the center of the flashing LED buttons).

The factory default scale for the horizontal axis is an ionian scale, corresponding to the white keys on a piano. Nothing is assigned to the vertical axis.

[Reference]

- * Selecting a scale other than the ionian scale. (Master Scale → [Page 44](#))
- * Changing octaves. (Octave → [Page 26](#))

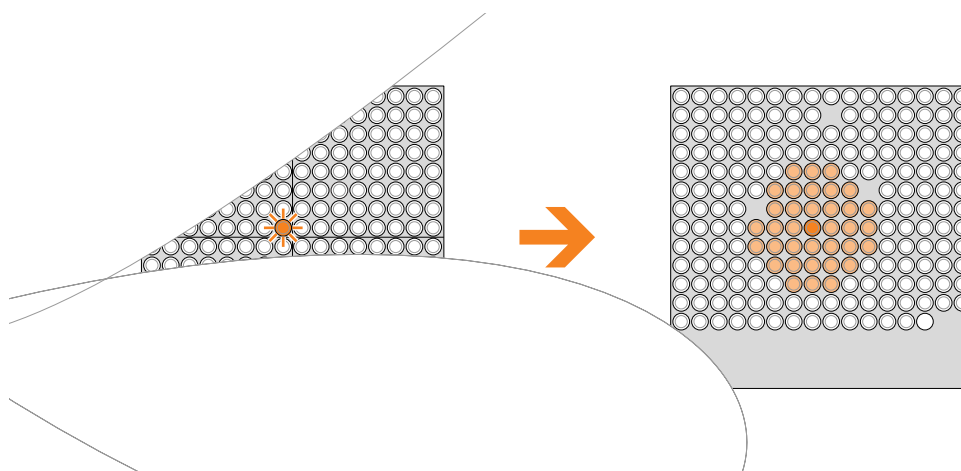

Solo Mode

The Solo Mode is assigned to layer 16.

Solo Mode Operation

Press an LED button and the corresponding note will repeat until the button is released. The LEDs in a column in which an LED button is pressed will flash upwards.

In the solo mode the pitches are arranged horizontally, like a piano. The vertical axis sets the interval between repeats: you can change the interval between repeats easily by pressing or sliding your finger to a lower (longer) or higher (shorter) LED button in the column.

If a sustained voice is used the note will sound for as long as the button is held.

[Reference]

- * The note length (gate time) can be changed as required. (Sound Length → [Page 25, 52](#))
- * The interval between repeats can be adjusted by changing the loop speed. The repeat interval of the top row of LED buttons is 1/2 the loop speed, and the interval doubles for each row down the matrix. (Loop Speed → [Page 29, 51](#). Master Loop Speed → [Page 45](#)).

The factory default scale for the horizontal axis is an ionian scale, corresponding to the white keys on a piano, with the lowest pitch on the left and the highest on the right.

[Reference]

- * Selecting a scale other than the ionian scale. (Master Scale → [Page 44](#))
- * Changing octaves. (Octave → [Page 26](#))
- * Note timing in the Solo Mode will be synchronized to the Score Mode. (Quantize → [Page 60](#))

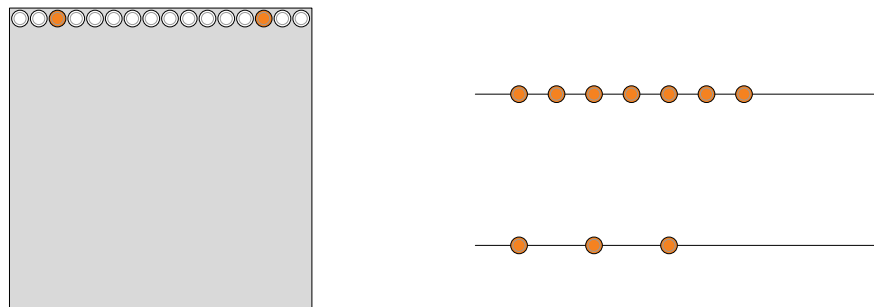

Parameter Settings

The TENORI-ON provides the following two methods for setting parameters such as voice and tempo.

■ The Function Buttons (→ [Page 23](#))

The function buttons are used in conjunction with the LED buttons to provide fast, easy access to functions such as voice switching, layer switching, block switching, and more. Visual feedback from the LED button matrix makes settings intuitive and easy.

■ The Jog Dial and Menu (→ [Page 36](#))

Detailed parameters, file save and load functions, song recording and other "deep" functions can be accessed via the jog dial and menu. "Customization" functions such as long-press time for the LED buttons can also be accessed and adjusted in this way.

- Settings available via the function buttons ([L1] — [L5], [R1] — [R5]) also appear on the LCD display during adjustment. At this time you can also use the jog dial for finer adjustment.

Setting Parameters with the Function Buttons

Settings can be made by holding one of the ten function buttons located on either side of the TENORI-ON ([L1] — [L5], [R1] — [R5]) and operating the LED buttons.

When a function button is pressed the current setting for that button will appear on the LED button matrix, and the setting can be changed by pressing the appropriate LED button(s).

Settings available via the function buttons also appear on the LCD display during adjustment. At this time you can also use the jog dial for finer adjustment.

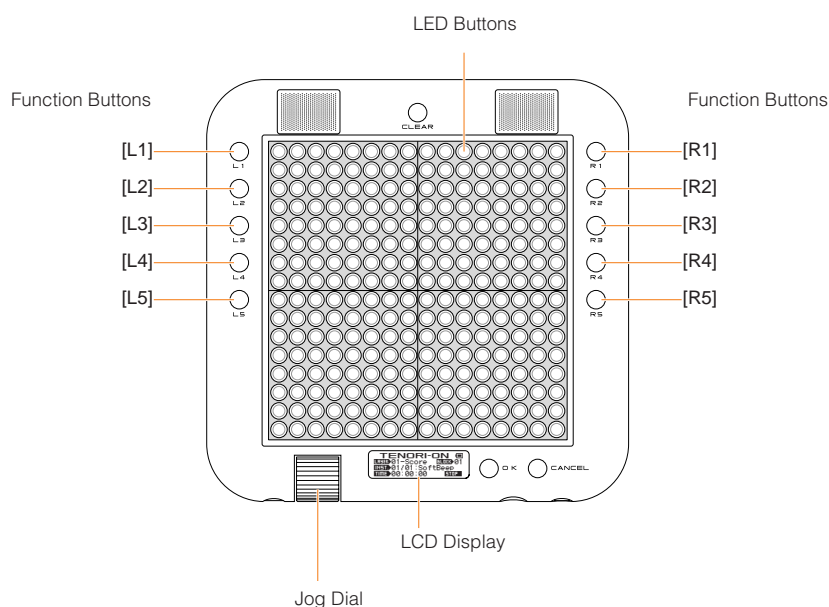

The settings available via the function buttons are as follows:

Button	Function	Description	Page
[L1]	Instrument	Selects the voice for the current layer.	24
[L2]	Sound Length	Sets the gate time (note length) for all active notes in the current layer.	25
[L3]	Octave	Sets the octave for all active notes in the current layer.	26
[L4]	Loop Point (Score Mode)	Sets the loop range when a Score Mode layer is selected.	27
	Rotation (Random Mode)	Sets the direction and speed of rotation for active note shapes in the Random Mode.	28
[L5]	Loop Speed	Sets the beat length (the speed of the loop indicator) for Score Mode layers only.	29
[R1]	Layer No.	Switches layers.	30
[R2]	Master Tempo	Sets the tempo for all layers and blocks.	31
[R3]	Master Transpose	Sets transposition for all layers and blocks.	32
[R4]	Volume	Sets the volume for each layer (common to all blocks).	33
[R5]	Block No.	Switches blocks. Also used for layer and block copy.	34

[L2] Sound Length

Sets the note length (gate time) for all active notes in the current layer.

While holding the [L2] button slide your finger horizontally over the matrix to move the lit vertical line to the desired setting, or simply press an LED button at the appropriate column. Moving the line to the right increases the note length.

The LED buttons adjust the Sound Length in the increments listed below. You can also use the jog dial for finer adjustment in +/-10 millisecond increments.

- Depending on the voice used, setting a shorter Sound Length may have no effect, or changing the Sound Length may result in inconsistent sound. Also, the maximum length of user voices is 0.97 seconds, and setting a longer Sound length will have no effect.

- Range 10 msec — 9990 msec
- Default 100 msec (all layers)

Values selected via the LED buttons.

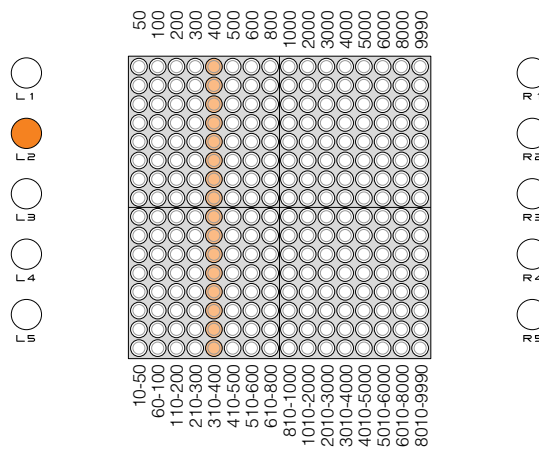

Matrix display related to settings made via the jog dial.

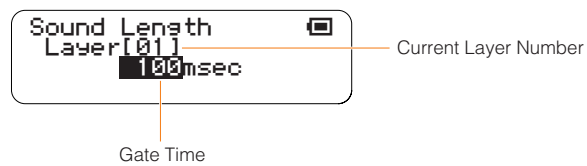

[Reference]

* Layer menu/Sound Length (→ [Page 52](#))

[L3] Octave

Sets the octave for all active notes in the current layer.

While holding the [L3] button slide your finger vertically over the matrix to move the lit horizontal line to the desired octave, or simply press an LED button in the appropriate row.

The eighth row from the bottom produces no octave shift (a "0" setting). Each row above that shifts the pitch up by the corresponding number of octaves up to "+5", while each row below that lowers the pitch by the corresponding number of octaves down to "-5". Pressing an LED button outside the maximum octave shift range of -5 — +5 has no effect.

The eighth row from the bottom produces no octave shift (a "0" setting). Each row above that shifts the pitch up by the corresponding number of octaves up to "+5", while each row below that lowers the pitch by the corresponding number of octaves down to "-5". Pressing an LED button outside the maximum octave shift range of -5 — +5 has no effect.

- Changes will not be applied to notes that are already playing in the Push or Solo modes, or currently playing notes if a long Sound length has been specified.

■ Range -5 — +5 octaves

■ Default 0 (all layers)

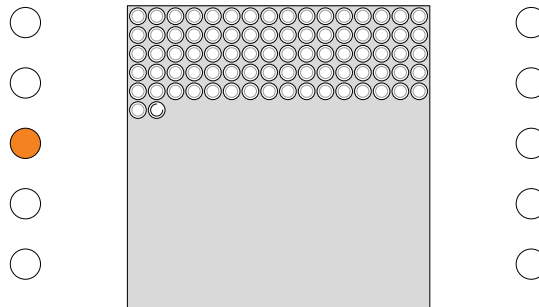

[L4] Score Mode Loop Point

Sets the loop playback range for the current Score Mode layer.

While holding the [L4] button slide your finger horizontally over upper half of the matrix to move the loop TOP point indicator to the desired point, and slide your finger horizontally over lower half of the matrix to move the loop END point indicator to the desired point, as required. Once the start and end points are set you can use the jog dial to move the entire range to the left or right while maintaining the set distance between the start and end points.

- The END point cannot be moved to a position before (to the left of) the TOP point. The END point can be moved to the same location as the TOP point, which will produce a 1-beat loop.
- The loop points for all Score Mode layers can be set to the same points simultaneously via the Master Loop Point (all layers) setting in the Play menu.

- Range TOP = 1 — 16, END = 1 — 16
- Default TOP = 1, END = 16

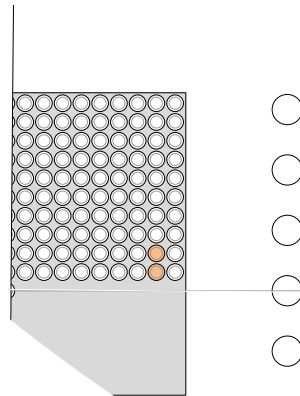

[Reference]

- * Play menu/Master Loop Point (→ [Page 46](#))

[L4] Random Mode Rotation

When a Random Mode layer is selected you can spin loop-shapes by holding the [L4] button and running a finger around the matrix in the direction and at the speed of the desired spin.

- Rotation direction and speed settings apply to the same layer in all blocks.
- To stop rotation, press and hold the LED button, or press the same LED button twice while holding the [L4] button. Pressing the [CLEAR] button clears only the active notes, leaving the rotation data active unless rotation has been stopped.
- Individual notes cannot be entered or cleared by pressing their LED buttons during rotation.

■ Range The speed at which the LED buttons are stroked is detected, and the nearest rotation speed* is automatically selected from the eight listed below.

- 4 beats (384 clocks),
- 3 beats (288 clocks),
- 2 beats (182 clocks),
- 1 beat (96 clocks),
- 3/4 beat (72 clocks),
- 1/2 beat (48 clocks),
- 1/4 beat (24 clocks),
- 1/8 beat (12 clocks)

* Rotation speed: Each complete rotation consists of 32 steps, and thus each step covers an angle of 11.25°. Rotation speed is specified as the number of beats between steps.

[Reference]

* The length of each beat can be adjusted via the Loop Speed parameter (Loop Speed → Page 29, 51. Master Loop Speed → Page 45).

■ Default none

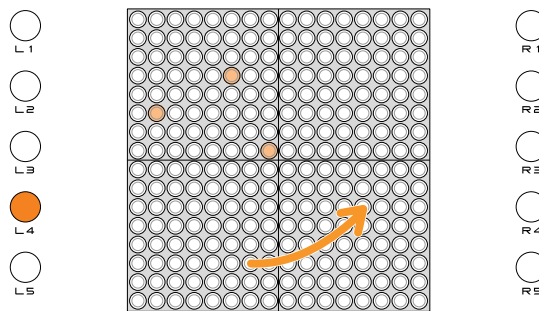

Rotation
Layer[08] [Random]

Current Layer Number

[Reference]

* Random Mode (→ Page 17)

[L5] Loop Speed

Sets the loop playback speed (the duration of the beats).

When the [L5] buttons is pressed the LED button column corresponding to the current setting will light. Four settings are available, set via the leftmost four columns on the matrix: quarter notes, eighth notes, sixteenth notes, and thirty-second notes.

While holding the [L5] button press a button in the corresponding column. LED buttons in other columns have no effect.

- Not available in the Push Mode.
- This setting will be changed if the Master Loop Speed (all layers) parameter in the Play menu is changed.

■ Range 1 (quarter note), 2 (eighth note), 4 (sixteenth note), 8 (thirty-second note)

■ Default 4 (The layer 14 default is 8)

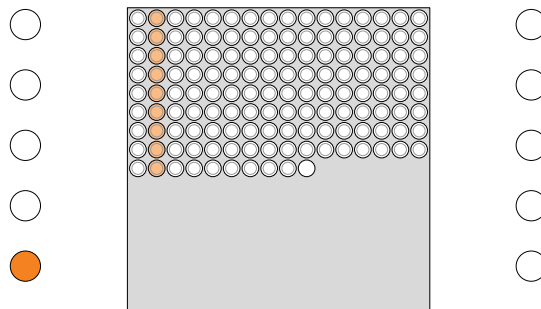

[Reference]

- * Play menu/Master Loop Speed (→ [Page 45](#)), Layer menu/Loop Speed (→ [Page 51](#))

[R1] Layer No.

Switches to a different layer.

When the [R1] button is pressed the LED button row corresponding to the currently selected layer will light. The lowest row corresponds to layer 1 and the highest row corresponds to layer 16.

While holding the [R1] button slide your finger vertically over the matrix or simply press an LED button in the appropriate row to select the desired layer.

The selected layer number will also appear in the LCD display, along with the layer mode.

■ Range 1 — 16

■ Default 1

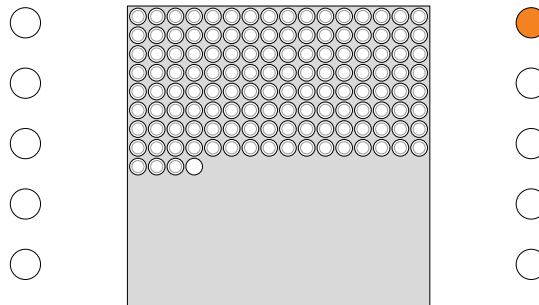

[R2] Master Tempo

Sets the playback tempo for all layers and all blocks.

When the [R2] button is pressed the LED button column corresponding to the current tempo setting will light. While holding the [R2] button slide your finger horizontally over the matrix or simply press an LED button in the appropriate column to select the desired tempo setting.

Moving the line to the right produces faster tempos.

The LED buttons adjust the tempo in the increments listed below. You can also use the jog dial for finer adjustment.

- Range 40 — 240 (50 — 200 via the LED buttons)
- Default 75

Values selected via the LED buttons.

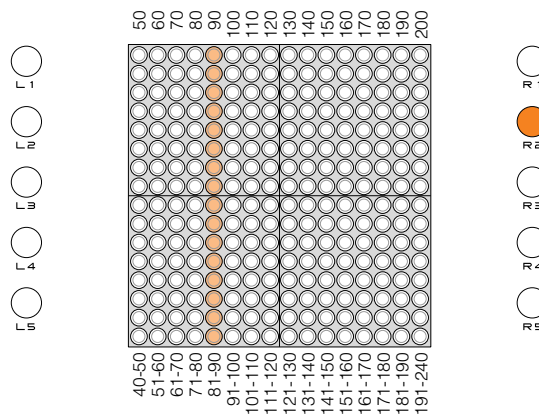

Matrix display related to settings made via the jog dial.

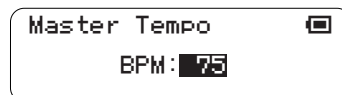

[Reference]

* Play menu/Master Tempo (→ Page 43)

[R3] Master Transpose

Adjusts the playback pitch in semitone increments for all layers and all blocks.

When the [R3] button is pressed the LED button row corresponding to the currently selected transpose value will light. While holding the [R3] button slide your finger vertically over the matrix or simply press an LED button in the appropriate row to select the desired degree of transposition.

The eighth row from the bottom produces no transposition (a "0" setting). Each row above that shifts the pitch up by the corresponding number of semitones up to "+8", while each row below that lowers the pitch by the corresponding number of semitones down to "-7".

- Changes will not be applied to notes that are already playing in the Push or Solo modes, or currently playing notes if a long Sound length has been specified.

- Range -7 — +8 (semitone increments)
- Default 0

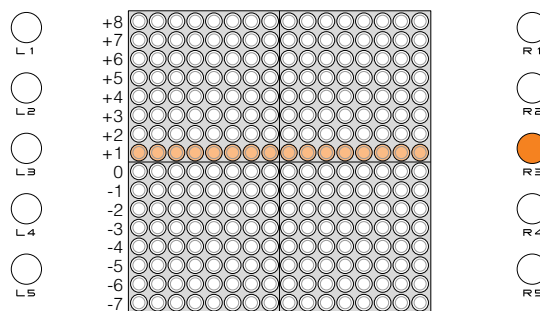

[Reference]

* Play menu/Master Transpose (→ [Page 45](#))

[R4] Volume

Layer Volume

Allows the volume of each layer to be adjusted as required (layer volume common to all blocks).

When the [R4] button is pressed the current volume settings for all 16 layers are displayed on the LED button matrix. Each row of LED buttons corresponds to layer, beginning with layer 01 at the bottom row.

While holding the [R4] button slide your finger horizontally over the row corresponding to the layer you want to adjust to set the volume as required. Moving a setting to the right increases the volume of the corresponding layer.

Master Volume

You can also use the jog dial while holding the [R4] button to set the master volume level (all layers). The master volume value appears on the LCD display only.

- Range Layer volume: 0 — 127
Master volume: 0 — 127
- Default Layer volume: 96 (all layers)
Master volume: 96

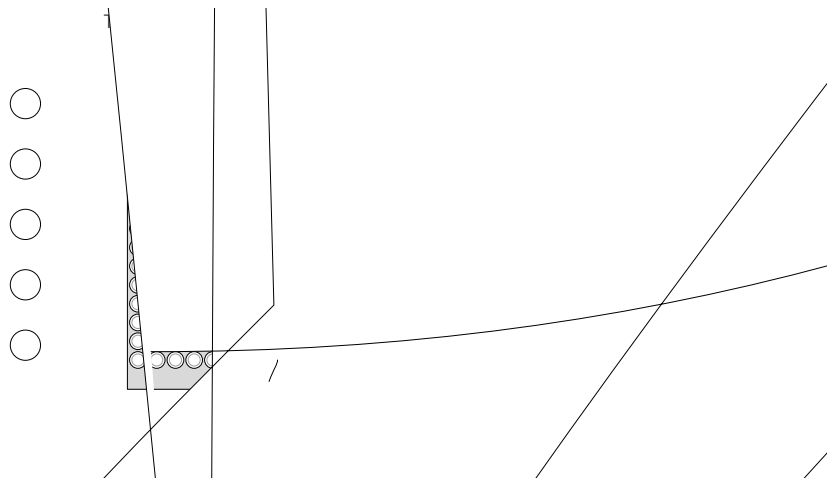

- To adjust the instrument's basic volume level, refer to Hardware Volume (→ [Page 43](#)).

[Reference]

- * Layer menu/Volume (→ [Page 50](#))

[R5] Block Number

Switches to a different block.

When the [R5] button is pressed the LED button column corresponding to the currently selected block will light. The leftmost column corresponds to block 1 and the rightmost column corresponds to block 16.

While holding the [R5] button slide your finger horizontally over the matrix or simply press an LED button in the appropriate column to select the desired block.

- When switching blocks while in the Push Mode the active notes will be retriggered (i.e. they will play from the beginning again).
- When switching blocks while in the Random Mode, Bounce Mode, the loop point will return to the beginning of the loop in either of the cases listed below:
 - The block that is switched to is not operating in one of the three modes listed above.
 - The block that is switched to includes one or more notes in different positions from the current block.

■ Range 1 — 16

■ Default 1

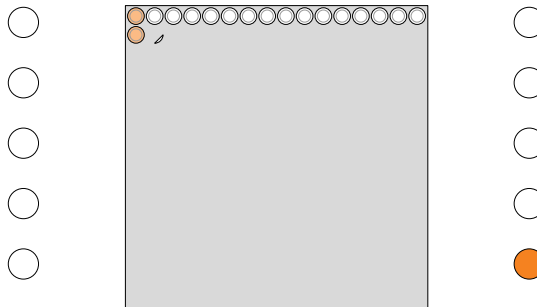

Using the [R5] Button to Copy Layers

By holding the [R5] button and performing the operations described below you can copy either a single layer or all layers from the current block to another block.

1. If the current block is not the block containing the layers you want to copy, hold the [R5] button and press the LED button corresponding to the desired "source" Block (the LEDs in that column will light dimly).
2. If you repeatedly press the lowest LED button in the lit column while holding the [R5] button, the LED buttons in the lit column will switch between three levels of brightness in the following sequence: dim → medium → bright → dim. The functions corresponding to each brightness level are: dim = block move, medium = copy 1 layer, bright = copy all layers. The procedures to copy 1 or all layers are described below.

To Copy a Single Layer

While holding the [R5] button while the LED buttons are lit dimly, press the lowest LED button in the lit column once so that the LED buttons shine at medium brightness, and then press an LED button in column corresponding to the block you want to copy to. The current layer from the source block will be copied to the same layer in the destination block. Release the [R5] button.

To Copy All Layers

While holding the [R5] button while the LED buttons are lit dimly, press the lowest LED button in the lit column twice so that the LED buttons shine at maximum brightness, and then press an LED button in column corresponding to the block you want to copy to. All layers from the source block will be copied to the destination block. Release the [R5] button.

When the copy operation is complete the destination block will be selected and the LED buttons will automatically return to their minimum brightness level.

Setting Parameters with the Jog Dial

In addition to using the function buttons described in the preceding section, parameters can be accessed by using the jog dial and menus shown on the LCD display, and edited by using the jog dial or LED buttons.

Basic Operation

- 1 When the power is turned on the status display will appear on the LCD following the initial startup display.

Startup Display

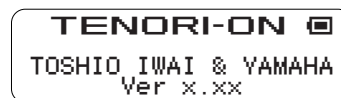

Status Display

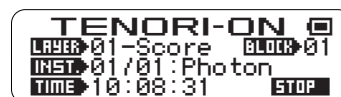

- 2 If you rotate the jog dial while the status information is showing the Main Menu will appear.

Main Menu

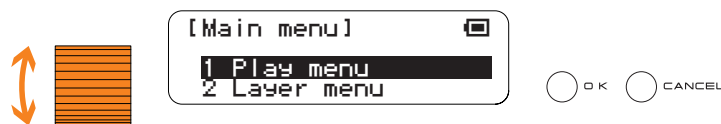

The currently selected item is highlighted on the display.

The Main Menu includes the following nine items:

No.	Menu	Description	Page
1	Play menu	Parameters common to all layers and blocks.	42
2	Layer menu	Parameters that can be set individually for each layer.	48
3	Edit menu	Copy, clear, reset, and other editing commands.	54
4	Preference menu	Initial settings for the entire instrument.	59
5	File menu	Data file save and load.	62
6	Effect menu	Reverb and chorus effect settings.	99
7	Interior menu	Non-performance operations (clock, song playback).	101
8	System menu	Factory reset, SD Memory Card format, and others.	106
9	Recording menu	Song record and save.	109

- 3 Rotate the jog dial to select the desired menu item, and then press the [OK] button to go to the related submenu.

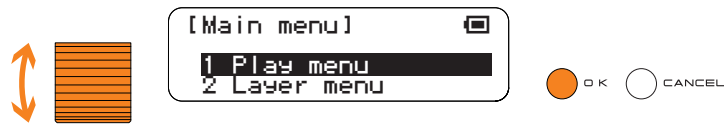

The Play Menu Submenu

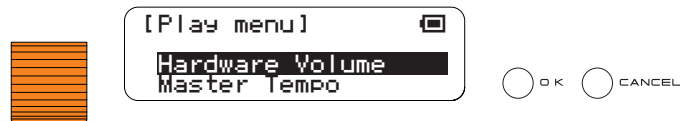

- 4 Select a parameter from the submenu and press the [OK] button to go to the related parameter edit display.

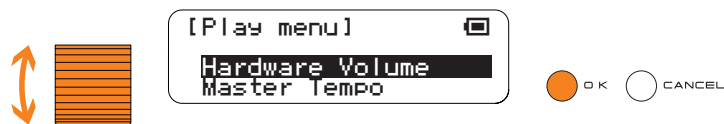

Hardware Volume Parameter Display

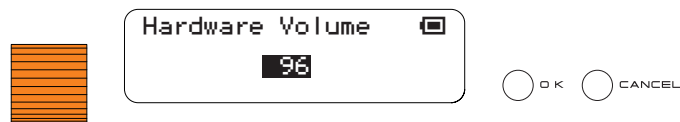

- The File menu submenu contains a further layer of operations from which the desired operation must be selected. See "File menu" on [Page 62](#) for details.

- 5 In the parameter edit display the current parameter value will be highlighted ready for editing. Use the jog dial to edit the parameter as required. Some parameters can be set via the LED buttons.

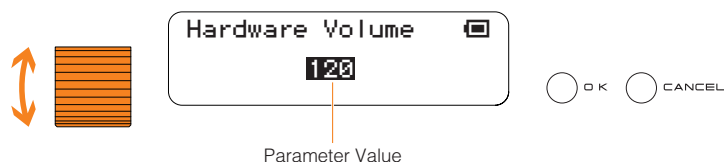

- 6 Press the [OK] button to apply the edit and return to the previous menu layer.
Press the [CANCEL] button to return to the previous menu layer without making any changes.
- If a parameter edit display includes multiple parameters, pressing the [OK] button after editing one parameter will apply that edit and highlight the next parameter in the display.

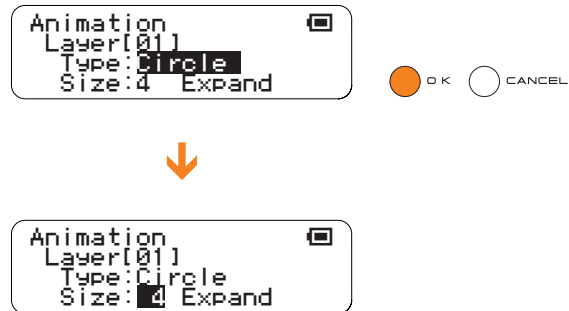

- 7 Use the [CANCEL] button to navigate upward through the menu layers.

Data Storage and Initialization

Data that is Erased When the Power is Turned Off

■ All block set

All active notes and settings for all layers and blocks are not retained in memory when the power is turned off, so if you want to keep any active notes data you have created you will need to use the Save All Blocks function described on [Page 69](#) to save it to an SD Memory Card.

■ Data Listed as "Save as Default" in the "Backup" Column of the Chart Below

These items are not retained in memory when the power is turned off, but can be saved to the internal flash ROM as the default settings by using the Save As Default function described on [Page 106](#). Settings saved in this way become the power-on default settings.

Items listed as "Automatic Backup" in the "Backup" column of the chart are automatically saved as the power-on default settings whenever a change is made.

Initialization

The entire system can be restored to the factory default settings by using the Factory Reset function described on [Page 108](#). To reset all active notes and settings for all layers and blocks, use the Reset All Blocks function described on [Page 58](#).

 **All data will be erased when the Factory Reset function is executed. Be sure to save any data you want to keep to an SD Memory Card beforehand.**

 **All layer and block data will be erased when the Reset All Blocks function is executed. Be sure to save any data you want to keep to an SD Memory Card beforehand.**

Menu Settings

Parameter		Backup	Factory Default	
Play Menu	Hardware Volume	Automatic Backup	96	
	Master Tempo	Save As Default	75	
	Master Scale		Ionian	
	Master Transpose		0	
	Master Loop Speed		Cannot be backed up. But since this setting is related to the Layer menu Loop Speed parameter, it can be saved as the default layer setting by using the Save As Default function.	4
	Master Loop Point	TOP	Cannot be backed up. But since this setting is related to the Loop Point settings accessed via the function buttons, it can be saved as the default layer setting by using the Save As Default function.	1
		END	Cannot be backed up. But since this setting is related to the Loop Point settings accessed via the function buttons, it can be saved as the default layer setting by using the Save As Default function.	16
	Reset Loop Timing	Cannot be backed up.	OK	
Mute	Save As Default	OFF		

Setting Parameters with the Jog Dial Data Storage and Initialization

Parameter	Backup	Factory Default	
Layer Menu	Layer 1	01/01	
	Layer 2	02/15	
	Layer 3	03/01	
	Layer 4	04/08	
	Layer 5	05/03	
	Layer 6	06/10	
	Layer 7	07/10	
	Instrument	Layer 8	08/05
		Layer 9	09/01
		Layer 10	10/13
		Layer 11	11/12
		Layer 120612	

Save As Default

Setting Parameters with the Jog Dial Function Button Settings

Parameter			Backup	Factory Default	
Layer Menu	Animation	Expand/Shrink Layer 14	Save As Default	None	
		Type Layer 15		Circle	
		Size Layer 15		3→4→5	
		Expand/Shrink Layer 15		Expand/Shrink	
		Type Layer 16		Vertical Line	
		Size Layer 16		1	
		Expand/Shrink Layer 16		None	
Edit Menu	-		-	-	
Preference Menu	Quantize		Automatic Backup	ON	
	Push Sensitivity			120	
	Master Tuning			0	
	Local Control			ON	
	Synchronize			MASTER	
	Loop Indicator			ON	
File Menu	-		-	-	
Effect Menu	Reverb Type		Automatic Backup	HALL 1	
	Reverb Param			40	
	Chorus Type			NO EFFECT	
	Chorus Param			0	
Interior Menu	Interior START		-	-	
	Interior Type		Automatic Backup	Song (DEMO)	
	Saver Type			Interior	
	Saver Time			10	
	Time Signal On/Off			OFF	
	Alarm On/Off				
	Set Alarm	Hour		0	
		Minute			
	Save As Time Signal			None	-
	Save As Alarm				-
	Clock Adjust	Year		Automatic Backup (When the clock battery is depleted the clock will be reset to "07/01/01 00:00:00")	07
		Month	01		
		Day	0		
Hour					
Minute					
Second					
System Menu	Save As Default		-	-	
	SD Format			-	
	Owner Name		Automatic Backup	"No Name"	
	Version Check		-	-	
	Factory Reset			-	
Recording Menu	-		-	-	

Function Button Settings

Parameter			Backup	Factory Default
Common	Layer No		Save As Default	1
	Block No			1
	Master Volume			96
Layer	Octave	Layer 1 — 16	Save As Default	0
	Loop Point	TOP Layer 1 — 16		1
		END Layer 1 — 16		16

■ Play Menu

The Play menu provides access to performance parameters that apply all layers and all blocks.

The Play menu submenu includes the following 8 items.

1. Hardware Volume	Page 43
2. Master Tempo	Page 43
3. Master Scale	Page 44
4. Master Transpose	Page 45
5. Master Loop Speed	Page 45
6. Master Loop Point	Page 46
7. Reset Loop Timing	Page 46
8. Mute	Page 47

Use the jog dial to highlight a submenu item, then press the [OK] button to go to the corresponding parameter edit display.



1. Hardware Volume

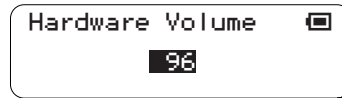

Sets the hardware volume.

- Range 0 — 127
- Default 96
- LED Buttons No display

[Reference]

* Layer menu/Volume (→ [Page 50](#))

2. Master Tempo

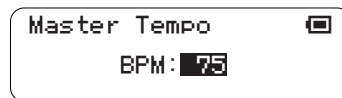

Sets the master tempo for all layers and blocks.

This display also appears when the [R2] button is pressed.

The LED buttons can be used to make adjustments in the increments shown below, while the jog dial can be used for fine adjustment.

- Range 40 — 240
- Default 75
- LED Buttons Values are displayed on the LED button matrix as illustrated below. Adjustments can be made via the LED buttons from 50 to 200 in 10-step increments.

Tempo settings available via the LED buttons.

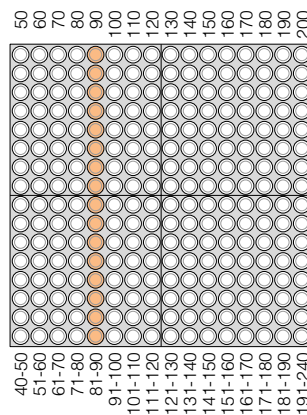

LED button matrix display in relation to tempo settings made via the jog dial.

[Reference]

* Function Button [R2] (→ [Page 31](#))

3. Master Scale

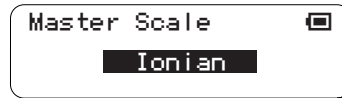

Sets the master scale for all layers and blocks.

- Changes will not be applied to notes that are already playing in the Push or Solo modes, or currently playing notes if a long Sound length has been specified.

- Range Ionian, Dorian, Phrygian, Lydian, Mixolydian, Aeolian, Locrian, Chromatic, OKINAWA
- Default Ionian
- LED Buttons No display

Note Assignments for Each Scale

Octave = 0, Transpose = 0, Center Note = C3

Ionian	Dorian	Phrygian	Lydian	Mixolydian	Aeolian	Locrian	Chromatic	OKINAWA
D5 (86)	D5 (86)	D \flat 5 (85)	D5 (86)	D5 (86)	D5 (86)	D \flat 5 (85)	D \sharp 4/E \flat 4 (75)	C6 (96)
C5 (84)	C5 (84)	C5 (84)	C5 (84)	C5 (84)	C5 (84)	C5 (84)	D4 (74)	B5 (95)
B4 (83)	B \flat 4 (82)	B \flat 4 (83)	B4 (83)	B \flat 4 (82)	B \flat 4 (82)	B \flat 4 (82)	C \sharp 4/D \flat 4 (73)	G5 (91)
A4 (81)	A4 (81)	A \flat 4 (80)	A4 (81)	A4 (81)	A \flat 4 (80)	A \flat 4 (80)	C4 (72)	F5 (89)
G4 (79)	G4 (79)	G4 (79)	G4 (79)	G4 (79)	G4 (79)	G \flat 4 (78)	B3 (71)	E5 (88)
F4 (77)	F4 (77)	F4 (77)	F \sharp 4 (78)	F4 (77)	F4 (77)	F4 (77)	A \sharp 3/B \flat 3 (70)	C5 (84)
E4 (76)	E \flat 4 (75)	E \flat 4 (75)	E4 (76)	E4 (76)	E \flat 4 (75)	E \flat 4 (75)	A3 (69)	B4 (83)
D4 (74)	D4 (74)	D \flat 4 (73)	D4 (74)	D4 (74)	D4 (74)	D \flat 4 (73)	G \sharp 3/A \flat 3 (68)	G4 (79)
C4 (72)	C4 (72)	C4 (72)	C4 (72)	C4 (72)	C4 (72)	C4 (72)	G3 (67)	F4 (77)
B3 (71)	B \flat 3 (70)	B \flat 3 (70)	B3 (71)	B \flat 3 (70)	B \flat 3 (70)	B \flat 3 (70)	F \sharp 3/G \flat 3 (66)	E4 (76)
A3 (69)	A3 (69)	A \flat 3 (68)	A3 (69)	A3 (69)	A \flat 3 (68)	A \flat 3 (68)	F3 (65)	C4 (72)
G3 (67)	G3 (67)	G3 (67)	G3 (67)	G3 (67)	G3 (67)	G \flat 3 (66)	E3 (64)	B3 (71)
F3 (65)	F3 (65)	F3 (65)	F \sharp 3 (66)	F3 (65)	F3 (65)	F3 (65)	D \sharp 3/E \flat 3	G3 (67)
E3 (64)	E \flat 3 (63)	E \flat 3 (63)	E3 (64)	E3 (64)	E \flat 3 (63)	E \flat 3 (63)	D3 (62)	F3 (65)
D3 (62)	D3 (62)	D \flat 3 (61)	D3 (62)	D3 (62)	D3 (62)	D \flat 3 (61)	C \sharp 3/D \flat 3 (61)	E3 (64)
C3 (60)	C3 (60)	C3 (60)	C3 (60)	C3 (60)	C3 (60)	C3 (60)	C3 (60)	C3 (60)

C \sharp D \sharp F \sharp G \sharp A \sharp
D \flat E \flat G \flat A \flat B \flat

C D E F G A B C

4. Master Transpose



Sets transposition for all layers and blocks.

This display also appears when the [R3] button is pressed.

- Changes will not be applied to notes that are already playing in the Push or Solo modes, or currently playing notes if a long Sound length has been specified.

- Range -7 — +8 (semitone increments)
- Default 0
- LED Buttons Values are displayed on the LED button matrix as illustrated below. Adjustments can be made via the LED buttons.

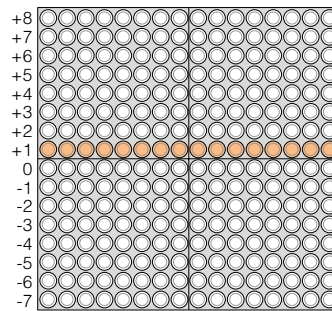

The eighth row from the bottom produces no transposition (a "0" setting). Each row above that shifts the pitch up by the corresponding number of semitones up to "+8", while each row below that lowers the pitch by the corresponding number of semitones down to "-7".

[Reference]

- * Function Button [R3] (→ [Page 32](#))

5. Master Loop Speed

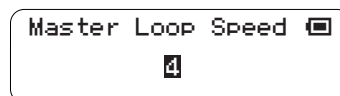

Sets the loop speed (the length of each beat) for all layers and blocks.

- Range 1 (quarter note), 2 (eighth note), 4 (sixteenth note), 8 (thirty-second note)
- Default 4
- LED Buttons No display

[Reference]

- * Layer menu/Loop Speed (→ [Page 51](#))

6. Master Loop Point

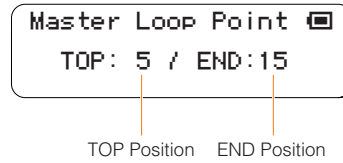

Sets the loop points (TOP and END) for all layers and blocks.

The loop includes the TOP and END points.

The TOP and END points are set via the LED buttons, and the jog dial moves the entire loop range backward or forward.

- The END point cannot be moved to a position before (to the left of) the TOP point. The END point can be moved to the same location as the TOP point, which will produce a 1-beat loop.

■ Range TOP = 1 — 16, END = 1 — 16

■ Default TOP = 1, END = 16

■ LED Buttons The TOP point is indicated by a lit half-column on the upper half of the matrix, and the END point is indicated by a lit half-column on the lower half of the matrix, as shown below. The TOP and END points are set via the LED buttons.

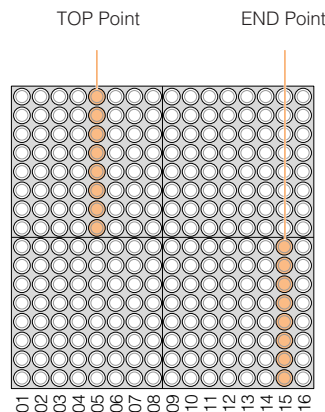

[Reference]

* Function Button [L4] (→ Page 27)

7. Reset Loop Timing

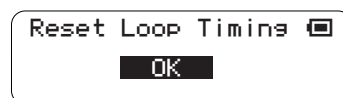

Resets the current playback position to the TOP of the loop for all layers and blocks.

■ Range OK, CANCEL

■ Default OK

■ LED Buttons No display

8. Mute



All sound output is muted when this function is turned ON.

- Range ON, OFF
- Default OFF
- LED Buttons No display

■ Layer Menu

The Layer menu provides access to parameters that apply to individual layers.

The currently selected layer will be affected by the Layer menu parameters.

The Layer menu submenu includes the following 6 items.

1. Instrument	Page 49
2. Volume	Page 50
3. Loop Speed	Page 51
4. Sound Length	Page 52
5. Panpot	Page 53
6. Animation	Page 53

Use the jog dial to highlight a submenu item, then press the [OK] button to go to the corresponding parameter edit display.



1. Instrument

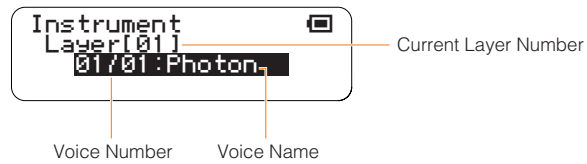

Selects the voice that will be played in the current layer.

This display also appears when the [R1] button is pressed.

Refer to the Voice List on [Page 119](#) for a complete list of voice numbers and names.

Voice numbers <01/16>, <02/16>, and <03/16> are user voices.

- When a user voice is selected from a preset voice, the Sound Length (→ [Page 52](#)) will be set to 1000 (msec). Conversely, when a preset voice is selected from a user voice the sound length for all other voices will be set to 100 (msec).
 - Changes will not be applied to notes that are already playing in the Push or Solo modes, or currently playing notes if a long Sound length has been specified.
- Range Vertical axis: 01 — 16
Horizontal axis: 01 — 16
 - Default Different for each layer
 - LED Buttons The current voice is indicated by the intersection of the lit row and column. The LED buttons can be used to select a different voice.

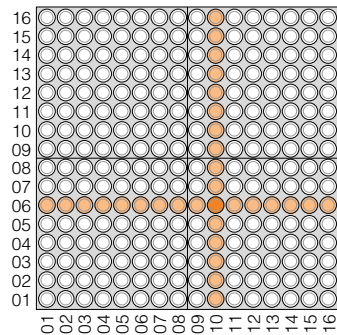

The intersection of the crossed lines is the current voice number (in this example: "06/10").

[Reference]

- * Function Button [L1] (→ [Page 24](#)), Voice List (→ [Page 119](#))

2. Volume

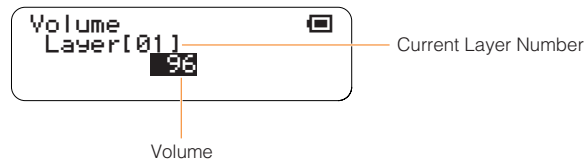

Sets the volume of individual layers (layer volume common to all blocks).

LED button matrix display and operation are the same as for the [R4] button.

The LED buttons can be used to set the volume of all 16 layers.

The LED buttons adjust the volume in the increments shown below, while the jog dial can be used for fine adjustment.

- Range 0 — 127
- Default 96 (all layers)
- LED Buttons Each row of LED buttons corresponds to a layer, while the horizontal axis corresponds to volume level (refer to the illustration below). The LED buttons can be used to adjust the volume of the corresponding layer.

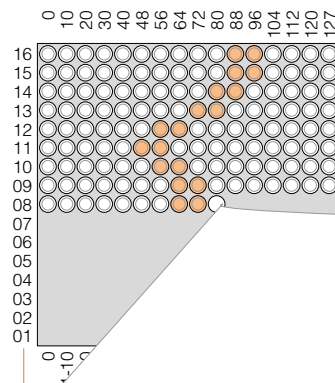

[Reference]
 * Function Button [R4] (→)

3. Loop Speed

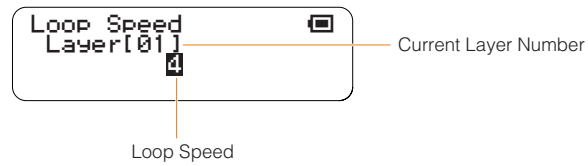

Sets the loop playback speed (the duration of the beats).
This display also appears when the [L5] button is pressed.

- This setting will be changed if the Master Loop Speed (all layers) parameter in the Play menu is changed.

- Range 1 (quarter note), 2 (eighth note), 4 (sixteenth note), 8 (thirty-second note)
- Default 4 (The layer 14 default is 8)
- LED Buttons The leftmost four columns on the matrix correspond to the available settings: quarter notes, eighth notes, sixteenth notes, and thirty-second notes. Press an LED button in one of these columns to make the corresponding setting. LED buttons in other columns have no effect.

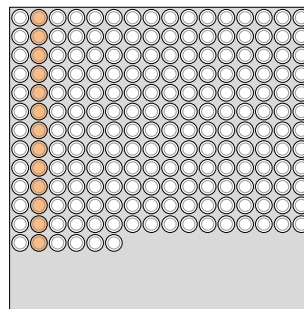

[Reference]

- * Play menu/Master Loop Speed (→ [Page 45](#)), Function Button [L5] (→ [Page 29](#))

4. Sound Length

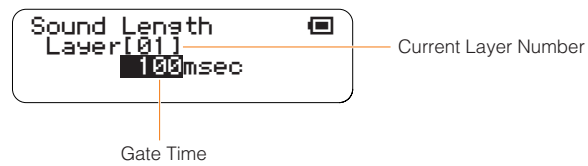

Sets the note length (gate time).

This setting applies to all active notes in the current layer.

The LED buttons adjust the Sound Length in the increments listed below. You can also use the jog dial for finer adjustment in +/-10 millisecond increments.

This display also appears when the [L2] button is pressed.

- Depending on the voice used, setting a shorter Sound Length may have no effect, or changing the Sound Length may result in inconsistent sound. Also, the maximum length of user voices is 0.97 seconds, and setting a longer Sound length will have no effect.
- Range 10 msec — 9990 msec
- Default 100 msec (all layers)
- LED Buttons The selected values are displayed as illustrated below. Settings can also be made via the LED buttons.

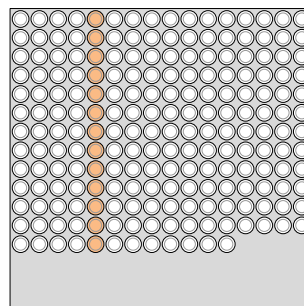

[Reference]

- * Function Button [L2] (→ [Page 25](#))

5. Panpot

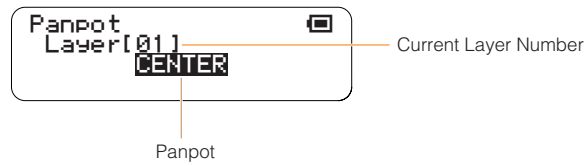

Sets the stereo pan position for the current layer.

- Range L64 — L01, CENTER, R01 — R63
- Default CENTER (all layers)
- LED Buttons No display

6. Animation

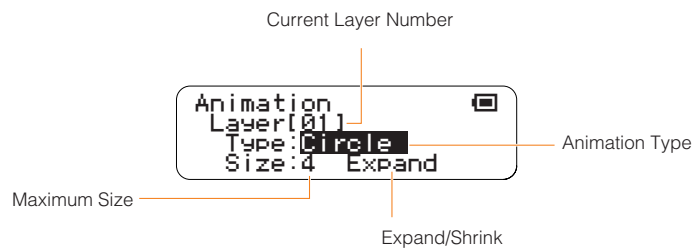

Sets the type of light animation that accompanies active notes, including whether the animation expands or shrinks, and the maximum animation size.

These settings apply to the current layer.

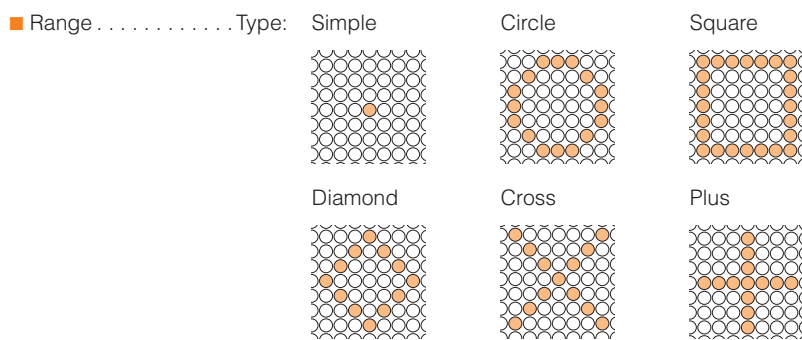

Size: 1 — 22 (maximum expand or shrink size), Expand, Shrink

- Default Different for each layer
- LED Buttons No display

■ Edit Menu

The Edit menu provides access to data editing functions such as copy, clear, and reset. The Edit menu submenu includes the following 6 items.

1. Copy this Block	Page 55
2. Clear this Block	Page 55
3. Copy this Layer	Page 56
4. Clear this Layer	Page 57
5. Clear All Blocks	Page 57
6. Reset All Blocks	Page 58

Use the jog dial to highlight a submenu item, then press the [OK] button to go to the corresponding parameter edit display.



The Undo Function

When you press the [OK] button to execute a copy, clear, or reset function from the Edit menu, the "UNDO" display shown below will appear after the copy, clear, or reset function has been completed. To undo the function just executed press the [OK] button, or to continue without undoing the function press an LED button or the [CANCEL] or [CLEAR] button.



- The UNDO display will time-out after 15 seconds if no operation is performed in that time.
- The Undo display will not appear when the [CLEAR] button is pressed (short or long press) to clear all active notes from the layer.

1. Copy this Block

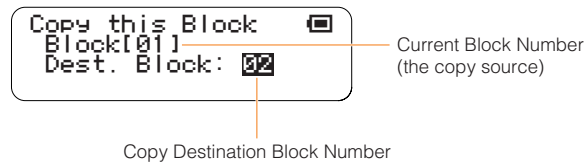

Copy all active notes from all layers in the current block to a different block. Specify the destination block number and then press the [OK] button. Press the [CANCEL] button to cancel the copy operation.

- Range 1 — 16
- LED Buttons The copy destination block number is displayed as illustrated below. The destination block number can also be set via the LED buttons.

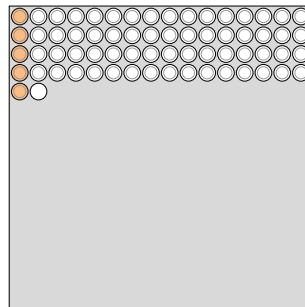

2. Clear this Block

Clears all active notes from all layers in the current block. Rotate the jog dial to display "OK" if it isn't already showing, then press the [OK] button. To cancel the clear operation either press the [CANCEL] button or rotate the jog dial to display "CANCEL" and press the [OK] button.

- This function clears the active notes, but leaves Random Mode rotation data unaffected and active. The LED buttons can not be used to enter notes while rotation is active. Refer to Rotation (→ [Page 28](#)) for information on stopping rotation.

- Range OK, CANCEL
- Default OK
- LED Buttons Animation displayed when clear executed

3. Copy this Layer

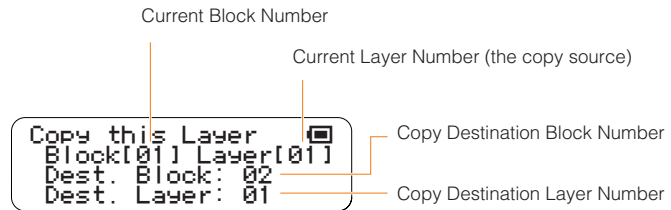

Copies all active notes from the current layer in the current block to a layer in a different block. This function will only work between layers that have the same performance mode.

Example: You can copy from layer 1 (Score Mode) to layer 7 (Score Mode), but from layer 1 (Score Mode) to layer 8 (Random Mode).

Use the LED buttons to select the copy destination block and layer numbers (you can also use the jog dial to select the copy destination block).

When the destination block and layer have been selected, press the [OK] button to execute the copy operation.

Press the [CANCEL] button to cancel the operation.

- If the copy source layer has a different performance mode from the destination layer, the "Mode different. Can't copy!" message will appear. Press either the [CANCEL] or [OK] button to return to the Edit menu.
- Range Destination Block: 1 — 16, Destination Layer: 1 — 16
- Default The currently selected block and layer
- LED Buttons The columns correspond to block numbers and the rows correspond to layer numbers as illustrated below. The intersection between the lit horizontal and vertical lines indicates the destination block and layer numbers.

In this example the selected copy destination block 2, layer 7.

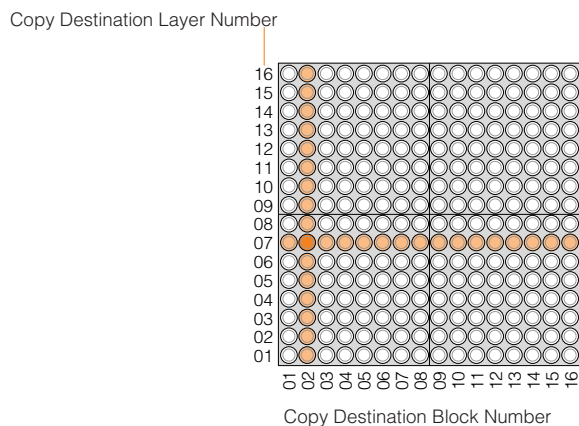

4. Clear this Layer

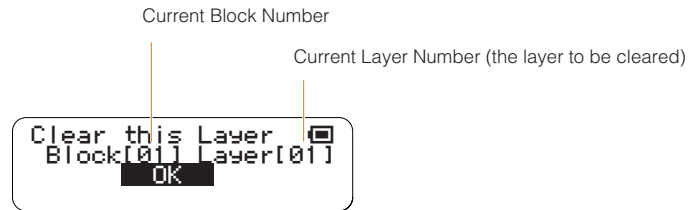

Clears all active notes from the current block and layer. This produces the same result as briefly pressing the [CLEAR] button.

Rotate the jog dial to display "OK" if it isn't already showing, then press the [OK] button.

To cancel the clear operation either press the [CANCEL] button or rotate the jog dial to display "CANCEL" and press the [OK] button.

- This function clears the active notes, but leaves Random Mode rotation data unaffected and active. The LED buttons can not be used to enter notes while rotation is active. Refer to Rotation (→ [Page 28](#)) for information on stopping rotation.

- Range OK, CANCEL
- Default OK
- LED Buttons Animation displayed when clear executed

5. Clear All Blocks

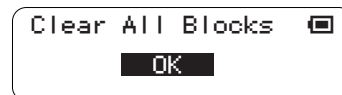

Clears all active notes from all blocks and layers. This produces the same result as pressing the [CLEAR] button (long press).

Rotate the jog dial to display "OK" if it isn't already showing, then press the [OK] button.

To cancel the clear operation either press the [CANCEL] button or rotate the jog dial to display "CANCEL" and press the [OK] button.

- Range OK, CANCEL
- Default OK
- LED Buttons Animation displayed when clear executed

6. Reset All Blocks



Clears all active notes and initializes all settings for all blocks and layers.

Rotate the jog dial to display "OK" if it isn't already showing, then press the [OK] button.

To cancel the clear operation either press the [CANCEL] button or rotate the jog dial to display "CANCEL" and press the [OK] button.

- Range OK, CANCEL
- Default OK
- LED Buttons Animation displayed when reset executed

■ Preference Menu

The Preference menu provides access to initial settings that apply to the entire instrument. The Preference menu submenu includes the following 6 items.

1. Quantize	Page 60
2. Push Sensitivity	Page 60
3. Master Tuning	Page 60
4. Local Control	Page 61
5. Synchronize	Page 61
6. Loop Indicator	Page 61

Use the jog dial to highlight a submenu item, then press the [OK] button to go to the corresponding parameter edit display.



1. Quantize

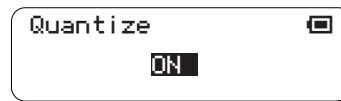

This setting applies to layer 16 (Solo Mode).

When ON the repeat timing of notes played in the Solo Mode is synchronized with playback timing in the Score Mode (layers 1 — 7).

- Range ON, OFF
- Default ON
- LED Buttons No display

2. Push Sensitivity



Sets the long-press time for the LED buttons.

The TENORI-ON recognizes a button press as a "long press" when the button is held for longer than the specified Push Sensitivity setting.

- Range 50 — 500 (milliseconds)
- Default 120 (milliseconds)
- LED Buttons No display

3. Master Tuning

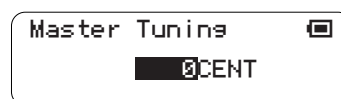

Master tuning for the internal MIDI tone generator and the user voices.

This parameter has no effect on the user voices (numbers <01/16,> <02/16,> and <03/16>).

- Range -100 — +100 (cents)
- Default 0 (cents)
- LED Buttons No display

4. Local Control

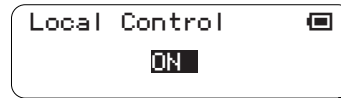

Determines whether TENORI-ON performance input (data) controls the internal MIDI tone generator (ON) or not (OFF).

When set to "OFF" no sound will be output from the TENORI-ON speakers or headphone jack, but performance data will still be transmitted via the MIDI connector. Also, the LED buttons will produce no sound when operated if this parameter is set to "OFF."

- Range ON, OFF
- Default ON
- LED Buttons No display

5. Synchronize

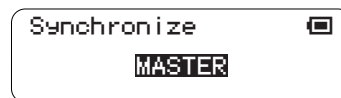

Sets the master or slave status for multiple TENORI-ON units to be synchronized via a MIDI connection. The "Master" TENORI-ON provides the clock for all "Slave" TENORI-ON units.

- A TENORI-ON set to the Slave mode will only function properly if correctly connected to the Master TENORI-ON.
- For synchronized operation, make sure that the Master TENORI-ON is playing back at a tempo that is close to the tempo at which the performance data for the Slave TENORI-ON was created. The Slave performance may not be reproduced properly if there is too great a difference between the tempos.

- Range MASTER, SLAVE
- Default MASTER
- LED Buttons No display

6. Loop Indicator

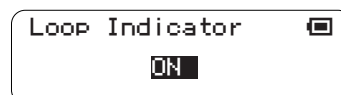

Determines whether the loop indicator is visible (ON) or not (OFF) in the Score Mode. This setting applies to all Score Mode layers (layers 1 — 7).

- Range ON, OFF
- Default ON
- LED Buttons Loop indicator

■ File Menu

The File menu provides access to functions that allow you to save data to an SD Memory Card, load sample files, and more.

The File menu submenu includes the following 6 items.

1.	Song	Page 64
2.	All Blocks	Page 68
3.	Current Block	Page 73
4.	Current Layer	Page 78
5.	All Settings	Page 83
6.	Samplings	Page 88

Use the jog dial to highlight a submenu item, then press the [OK] button to go to the corresponding parameter edit display.



Each item in the File menu submenu has a further 3 — 5 functions that you will need to select from.

After accessing a submenu, use the jog dial to highlight the desired function and then press the [OK] button.

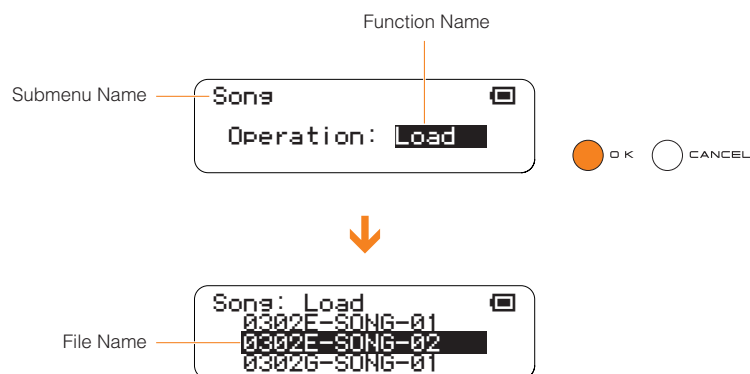

Refer to the Display Message List on [Page 111](#) for information about error messages that may be displayed during SD Memory Card access operations.

- The TENORI-ON can only display file names consisting of up to 16 ASCII characters, not including the file extension. 2-byte characters cannot be displayed.

Files saved to an SD Memory Card are saved in a "TENORI-ON" folder that is automatically created on the card. Up to 1,000 files can be stored in the TENORI-ON folder, or up to 256 files of each file-extension type.

⚠ Before using SD Memory Cards with the TENORI-ON, be sure to read "Handling SD™ Memory Cards" on [Page 63](#).

Using SD™ Memory Cards

SD is a registered trademark of the SD Card Association.

The instrument features a built-in SD Memory Card slot. It lets you save original data you've created on the SD Memory Card, and allows you to load data from a card to the instrument. Be sure to handle SD Memory Cards with care. Follow the important precautions below.

SD Memory Card types

Use SD Memory Cards with a capacity of two gigabytes or

SD Memory Cards formatted on this device may or may not be useable as is on other devices.

The instrument is not compatible with SDIO and SDHC.

Formatting SD Memory Cards

If you are unable to use new, blank SD Memory Cards or cards that have been used with other instruments, you may need to format them. For information on how to format a SD Memory Card, see the user manual. Keep in mind that all data on the card will be erased when formatting. Make sure to check the instrument to see whether or not the card contains any data before formatting.

SD Memory Cards formatted on this device may or may not be useable as is on other devices.

Inserting and Removing SD Memory Cards

Inserting SD Memory Cards

To insert a SD Memory Card with the terminal (gold-plated) side down into the card slot, until it clicks.



- Do not insert the SD Memory Cards in the wrong direction.
- Do not insert anything other than a SD Memory Card in the slot.

Removing SD Memory Cards

- After making sure that the instrument is not accessing* the SD Memory Card, insert the card until it clicks into place and release it. When the SD Memory Card is ejected, pull it out of the drive. If the card cannot be removed because it is stuck, do not try to force it, but instead try re-inserting the card completely into the slot and attempt to eject it again.

* Accessing includes saving, loading, formatting and deleting. Also, be aware that the instrument will automatically access the SD Memory Card to check the media type when it is inserted while the instrument is turned on.

Never attempt to remove the SD Memory Card or turn the power off during accessing. Doing so can damage the data on the instrument or card and possibly damage the SD Memory Card itself.

About SD Memory Cards

Handle SD Memory Cards with care, and follow these precautions:

- There are times when static electricity affects SD Memory Card. Before you touch a SD Memory Card, touch something metallic such as a door knob and aluminum sash, to reduce the possibility of static electricity.
- Be sure to remove the SD Memory Card from the SD Card slot when it is not in use for a long time.
- Do not expose the SD Memory Card to direct sunlight, extremely high or low temperatures, or excessive humidity, dust or liquids.
- Do not place heavy objects on a SD Memory Card or bend or apply pressure to the card in any way.
- Do not touch the gold-plated terminals of the SD Memory Card or put any metallic plate onto the terminals.
- Do not expose the SD Memory Card to magnetic fields, such as those produced by televisions, speakers, motors, etc., since magnetic fields can partially or completely erase data on the SD Memory Card, rendering it unreadable.

To protect your data (write-protect switch):

- SD Memory Cards are equipped with a write-protect switch. To prevent accidental erasure of important data saved in SD Memory Card, slide the write-protect switch on the device to the "protect" position. When saving data, make sure that the write-protect switch is set to the "overwrite" position.

Data Backup

- For maximum data security, Yamaha recommends that you keep two copies of important data on separate SD Memory Cards. This gives you a backup if one card is lost or damaged.

1. Song

Provides access to song file operations.

"Song" files are files created by the TENORI-ON song recording function (→ [Page 109](#)).

In addition to performance data (active notes and settings such as voice, tempo, etc.) for all layers and blocks, all button and jog dial operations are recorded in real time. A recorded Song file can then be loaded in into the TENORI-ON and played back, precisely reproducing the entire performance as it occurred.

The following 3 Song file functions are provided:

Load Song	Page 64
Rename Song	Page 65
Delete Song	Page 67

● Load Song

Loads a Song file that has been saved to an SD Memory Card into the TENORI-ON.

- 1 Insert the SD Memory Card containing the file you want to load into the TENORI-ON card slot.
- 2 Use the jog dial and [OK] button to navigate to the Song function menu as follows:
"Main menu" → "File menu" → "Song"

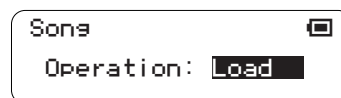

- 3 Use the jog dial to highlight the "Load" function, then press the [OK] button.
- 4 Song files on the card will appear as a list on the LCD display (with no file extension). Use the jog dial to select the file you want to load.

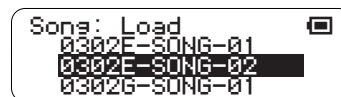

- Only files that are in song-file format will be displayed.

- 5 Press the [OK] button to load the selected file.
The display shown below will appear while the file is being loaded.
Press the [OK] or [CANCEL] button to cancel the load operation.

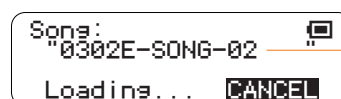

The name of the Song file being loaded.

- 6** When the Song file has been loaded the display shown below will appear, and playback will begin.
Press the [OK] button when you want to stop playback.



- The composer name that appears on the third line of the display is the registered "Owner Name" for the TENORI-ON on which the Song file was recorded (→ [Page 107](#)).

● Rename Song

Allows a new name to be entered for a Song file on an SD Memory Card.

- 1 Insert the SD Memory Card containing the file you want to rename into the TENORI-ON card slot.
- 2 Use the jog dial and [OK] button to navigate to the Song function menu as follows:
"Main menu" → "File menu" → "Song"

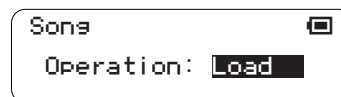

- 3 Use the jog dial to highlight the "Rename" function, then press the [OK] button.



- 4 Song files on the card will appear as a list on the LCD display (with no file extension).
Use the jog dial to select the file you want to rename.

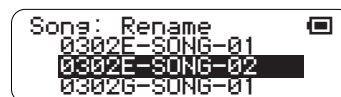

- Only files that are in song-file format will be displayed.

- 5 Press the [OK] button to go to the file name entry display. The name of the currently selected file will be displayed, and you can enter a new file name as required.



The Input cursor "█" indicates the current entry point in the file name displayed on the second line of the LCD. Use the jog dial to highlight the character you want to enter in the list on the third and fourth lines of the LCD, then press the [OK] button to enter that character at the current entry point. When a character is entered the cursor moves one character to the right, ready for the next character. If you want to enter a new character in the middle of the file name, you will need to delete and re-enter all characters up to that point.

To delete characters, use the jog dial to highlight the "+" symbol in the lower right corner of the display and press the [OK] button as many times as necessary.

File names can be up to 16 alphanumeric and hyphen (-) characters in length, not including the file extension. The file extension will be added automatically.

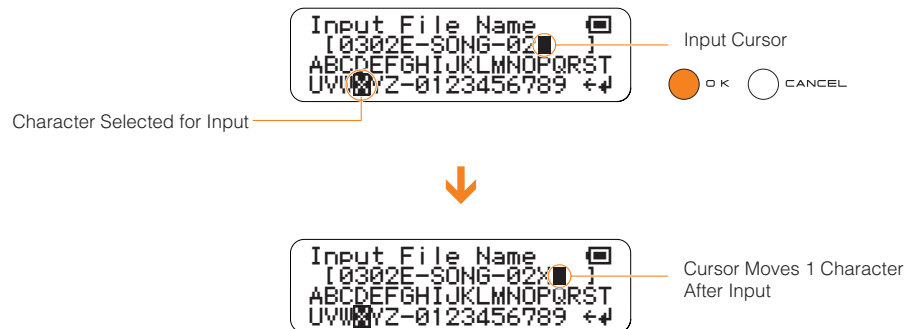

- 6 When the file name has been entered as required use the jog dial to highlight the "+" symbol in the lower right corner of the display and press the [OK] button. "Executing ..." will appear on the display while the file is being renamed.

⚠ File data may be irreparably corrupted if you turn off the power or remove the SD Memory Card while the "Executing..." display is showing.

- If a file with the same name exists on the SD Memory Card an overwrite confirmation display like the one shown below will appear.

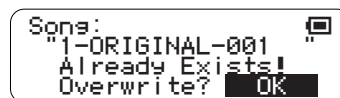

- Press the [OK] button if it's OK to overwrite the file. Press the [CANCEL] button (or use the jog dial to select "CANCEL" on the LCD and then press the [OK] button) to cancel the operation and leave the original file unaltered.

- 7 The display shown in step 3, above, will reappear when the operation has finished.

● Delete Song

Deletes a specified Song from an SD Memory Card.

- 1 Insert the SD Memory Card containing the file you want to delete into the TENORI-ON card slot.
- 2 Use the jog dial and [OK] button to navigate to the Song function menu as follows:
"Main menu" → "File menu" → "Song"

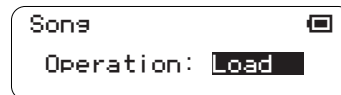

- 3 Use the jog dial to highlight the "Delete" function, then press the [OK] button.



- 4 Song files on the card will appear as a list on the LCD display (with no file extension). Use the jog dial to select the file you want to delete.



- Only files that are in song-file format will be displayed.

- 5 Press the [OK] button to delete the selected file.
A confirmation display like the one shown below will appear.
Press the [OK] button if it's OK to delete the file. Press the [CANCEL] button (or use the jog dial to select "CANCEL" on the LCD and then press the [OK] button) to cancel the operation and leave the file unaltered.

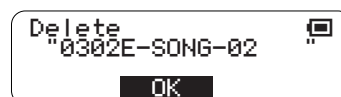

If you press the [OK] button to execute the delete operation, "Executing ..." will appear on the display while the file is being deleted.

 **File data may be irreparably corrupted if you turn off the power or remove the SD Memory Card while the "Executing..." display is showing.**

- 6 The display shown in step 3, above, will reappear when the operation has finished.

2. All Blocks

Provides access to All Blocks file operations.

"All Blocks" files include active notes and settings such as voice, tempo, etc., for all layers and blocks.

The following 4 All Blocks file functions are provided:

Load All Blocks	Page 68
Save All Blocks	Page 69
Rename All Blocks	Page 70
Delete All Blocks	Page 71

● Load All Blocks

Loads an All Blocks file that has been saved to an SD Memory Card into the TENORI-ON.

- 1 Insert the SD Memory Card containing the file you want to load into the TENORI-ON card slot.
- 2 Use the jog dial and [OK] button to navigate to the All Blocks function menu as follows:
"Main menu" → "File menu" → "All Blocks"

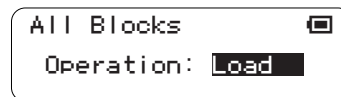

- 3 Use the jog dial to highlight the "Load" function, then press the [OK] button.
- 4 All Blocks files on the card will appear as a list on the LCD display (with no file extension). Use the jog dial to select the file you want to load.



- Only files that are in All Blocks format will be displayed.

- 5 Press the [OK] button to load the selected file.
The display shown below will appear while the file is being loaded.
Press the [OK] or [CANCEL] button to cancel the load operation.

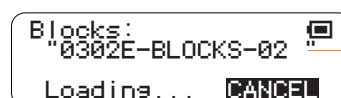

The name of the All Blocks file being loaded.

- 6 When the All Blocks file has been loaded the display shown in step 2, above, will appear, and playback of the All Blocks file will begin.
Press the [OK] button in the status display when you want to stop playback.

● Save All Blocks

Saves an All Blocks file containing all active notes and settings such as voice, tempo, etc., for all layers and blocks to an SD Memory Card.

- 1 Insert an SD Memory Card that has sufficient free space for the file to be saved into the TENORI-ON card slot.
- 2 Use the jog dial and [OK] button to navigate to the All Blocks function menu as follows:
"Main menu" → "File menu" → "All Blocks"

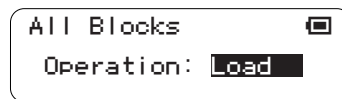

- 3 Use the jog dial to highlight the "Save" function, then press the [OK] button.



The file name entry display will appear. A default file name will be provided, which you can either use as-is or replace with a name of your own.

File name entry procedure is described in the Rename Song section on [Page 65](#).



- 4 When the file name has been entered as required use the jog dial to highlight the "⏏" symbol in the lower right corner of the display and press the [OK] button.
The file name will be entered and the save function will be executed.
A display like the one shown below will appear while the All Blocks file is being saved.
You can cancel the operation by pressing the [OK] or [CANCEL] button.



File data may be irreparably corrupted if you turn off the power or remove the SD Memory Card while the "Saving..." display is showing.

- If a file with the same name exists on the SD Memory Card an overwrite confirmation display like the one shown below will appear.

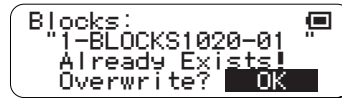

- Press the [OK] button if it's OK to overwrite the file. Press the [CANCEL] button (or use the jog dial to select "CANCEL" on the LCD and then press the [OK] button) to cancel the operation and leave the original file unaltered.

5 The display shown in step 3, above, will reappear when the operation has finished.

● Rename All Blocks

Allows a new name to be entered for an All Blocks file on an SD Memory Card.

- 1** Insert the SD Memory Card containing the file you want to rename into the TENORI-ON card slot.
- 2** Use the jog dial and [OK] button to navigate to the All Blocks function menu as follows: "Main menu" → "File menu" → "All Blocks"

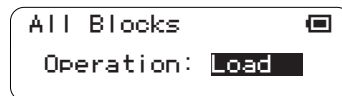

- 3** Use the jog dial to highlight the "Rename" function, then press the [OK] button.



- 4** All Blocks files on the card will appear as a list on the LCD display (with no file extension). Use the jog dial to select the file you want to rename.

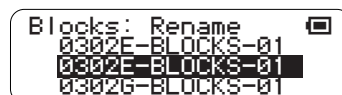

- Only files that are in All Blocks format will be displayed.

- 5 Press the [OK] button to go to the file name entry display. The name of the currently selected All Blocks file will be displayed, and you can enter a new file name as required. File name entry procedure is described in the Rename Song section on Page 65.

- File names can be up to 16 characters in length. The file extension will be added automatically.



- 6 When the file name has been entered as required use the jog dial to highlight the "↵" symbol in the lower right corner of the display and press the [OK] button. "Executing ..." will appear on the display while the file is being renamed.

⚠ File data may be irreparably corrupted if you turn off the power or remove the SD Memory Card while the "Executing..." display is showing.

- If a file with the same name exists on the SD Memory Card an overwrite confirmation display like the one shown below will appear.

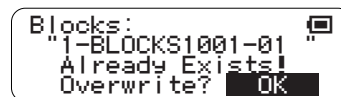

- Press the [OK] button if it's OK to overwrite the file. Press the [CANCEL] button (or use the jog dial to select "CANCEL" on the LCD and then press the [OK] button) to cancel the operation and leave the original file unaltered.

- 7 The display shown in step 3, above, will reappear when the operation has finished.

● Delete All Blocks

Deletes a specified All Blocks file from an SD Memory Card.

- 1 Insert the SD Memory Card containing the file you want to delete into the TENORI-ON card slot.
- 2 Use the jog dial and [OK] button to navigate to the All Blocks function menu as follows: "Main menu" → "File menu" → "All Blocks"

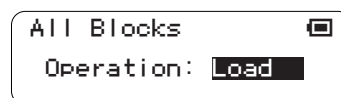

- 3 Use the jog dial to highlight the "Delete" function, then press the [OK] button.



- 4 All Blocks files on the card will appear as a list on the LCD display (with no file extension). Use the jog dial to select the file you want to delete.



- Only files that are in All Blocks format will be displayed.

- 5 Press the [OK] button to delete the selected file.

A confirmation display like the one shown below will appear.

Press the [OK] button if it's OK to delete the file. Press the [CANCEL] button (or use the jog dial to select "CANCEL" on the LCD and then press the [OK] button) to cancel the operation and leave the file unaltered.



If you press the [OK] button to execute the delete operation, "Executing ..." will appear on the display while the file is being deleted.



File data may be irreparably corrupted if you turn off the power or remove the SD Memory Card while the "Executing..." display is showing.

- 6 The display shown in step 3, above, will reappear when the operation has finished.

3. Current Block

Provides access to Current Block file operations.

"Current Block" files include active notes and settings such as voice, tempo, etc., for all layers in the current block.

The following 4 Current Block file functions are provided:

Load Current Block	Page 73
Save Current Block	Page 74
Rename Current Block	Page 75
Delete Current Block	Page 77

● Load Current Block

Loads a Current Block file that has been saved to an SD Memory Card into the TENORI-ON.

 **When a block is loaded the layer settings for all other blocks will also be overwritten by the loaded data.**

- 1 Make sure the block that you want to load the data into is selected on the TENORI-ON (Function Button [R5]: [Page 34](#)).
- 2 Insert the SD Memory Card containing the file you want to load into the TENORI-ON card slot.
- 3 Use the jog dial and [OK] button to navigate to the Current Block function menu as follows:
"Main menu" → "File menu" → "Current Block"

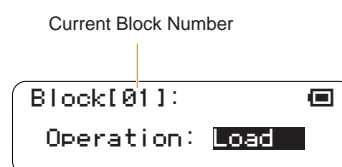

- 4 Use the jog dial to highlight the "Load" function, then press the [OK] button.
- 5 Current Block files on the card will appear as a list on the LCD display (with no file extension). Use the jog dial to select the file you want to load.



- Only files that are in Current Block format will be displayed.

- 6 Press the [OK] button to load the selected file.
The display shown below will appear while the file is being loaded.
Press the [OK] or [CANCEL] button to cancel the load operation.

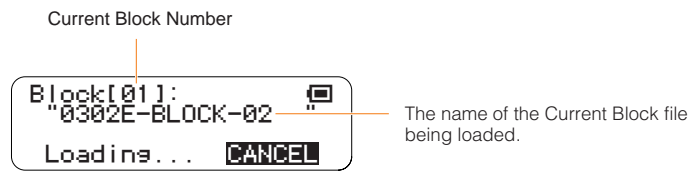

- When the Current Block file has been loaded the display shown in step 3, above, will appear, and playback of the Current Block file will begin.
Press the [OK] button in the status display when you want to stop playback.

● Save Current Block

Saves a Current Block file containing all active notes and settings such as voice, tempo, etc., for all layers in the current block to an SD Memory Card.

- Insert an SD Memory Card that has sufficient free space for the file to be saved into the TENORI-ON card slot.
- Use the jog dial and [OK] button to navigate to the Current Block function menu as follows:
"Main menu" → "File menu" → "Current Block"

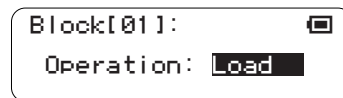

- Use the jog dial to highlight the "Save" function, then press the [OK] button.



- The file name entry display will appear. A default file name will be provided, which you can either use as-is or replace with a name of your own.
File name entry procedure is described in the Rename Song section on [Page 65](#).

- File names can be up to 16 characters in length. The file extension will be added automatically.



- 5** When the file name has been entered as required use the jog dial to highlight the "⏏" symbol in the lower right corner of the display and press the [OK] button.

The file name will be entered and the save function will be executed.

A display like the one shown below will appear while the Current Block file is being saved.

You can cancel the operation by pressing the [OK] or [CANCEL] button.



File data may be irreparably corrupted if you turn off the power or remove the SD Memory Card while the "Saving..." display is showing.

- If a file with the same name exists on the SD Memory Card an overwrite confirmation display like the one shown below will appear.

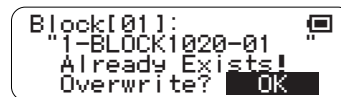

- Press the [OK] button if it's OK to overwrite the file. Press the [CANCEL] button (or use the jog dial to select "CANCEL" on the LCD and then press the [OK] button) to cancel the operation and leave the original file unaltered.

- 6** The display shown in step 3, above, will reappear when the operation has finished.

● Rename Current Block

Allows a new name to be entered for a Current Block file on an SD Memory Card.

- 1** Insert the SD Memory Card containing the file you want to rename into the TENORI-ON card slot.
- 2** Use the jog dial and [OK] button to navigate to the Current Block function menu as follows:
"Main menu" → "File menu" → "Current Block"

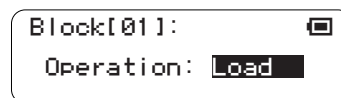

- 3** Use the jog dial to highlight the "Rename" function, then press the [OK] button.

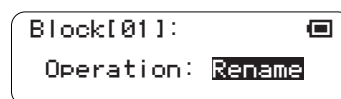

- 4 Current Block files on the card will appear as a list on the LCD display (with no file extension). Use the jog dial to select the file you want to rename.



- Only files that are in Current Block format will be displayed.

Press the [OK] button to go to the file name entry display. The name of the currently selected Current Block file will be displayed, and you can enter a new file name as required. File name entry procedure is described in the Rename Song section on Page 65.

- File names can be up to 16 characters in length. The file extension will be added automatically.



- 5 When the file name has been entered as required use the jog dial to highlight the "+" symbol in the lower right corner of the display and press the [OK] button. "Executing ..." will appear on the display while the file is being renamed.



File data may be irreparably corrupted if you turn off the power or remove the SD Memory Card while the "Executing..." display is showing.

- If a file with the same name exists on the SD Memory Card an overwrite confirmation display like the one shown below will appear.

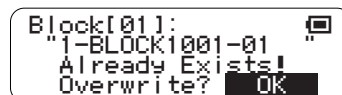

- Press the [OK] button if it's OK to overwrite the file. Press the [CANCEL] button (or use the jog dial to select "CANCEL" on the LCD and then press the [OK] button) to cancel the operation and leave the original file unaltered.

- 6 The display shown in step 3, above, will reappear when the operation has finished.

● Delete Current Block

Deletes a specified Current Block file from an SD Memory Card.

- 1 Insert the SD Memory Card containing the file you want to delete into the TENORI-ON card slot.
- 2 Use the jog dial and [OK] button to navigate to the Current Block function menu as follows:
"Main menu" → "File menu" → "Current Block"

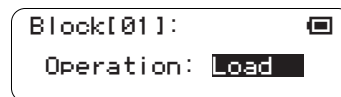

- 3 Use the jog dial to highlight the "Delete" function, then press the [OK] button.



- 4 Current Block files on the card will appear as a list on the LCD display (with no file extension). Use the jog dial to select the file you want to delete.



- Only files that are in Current Block format will be displayed.

- 5 Press the [OK] button to delete the selected file.
A confirmation display like the one shown below will appear.
Press the [OK] button if it's OK to delete the file. Press the [CANCEL] button (or use the jog dial to select "CANCEL" on the LCD and then press the [OK] button) to cancel the operation and leave the file unaltered.



If you press the [OK] button to execute the delete operation, "Executing ..." will appear on the display while the file is being deleted.

 File data may be irreparably corrupted if you turn off the power or remove the SD Memory Card while the "Executing..." display is showing.

- 6 The display shown in step 3, above, will reappear when the operation has finished.

4. Current Layer

Provides access to Current Layer file operations.

"Current Layer" files include active notes and settings such as voice, tempo, etc., for the current layer in the current block.

The following 4 Current Layer file functions are provided:

Load Current Layer	Page 78
Save Current Layer	Page 79
Rename Current Layer	Page 80
Delete Current Layer	Page 82

● Load Current Layer

Loads a Current Layer file that has been saved to an SD Memory Card into the TENORI-ON.

 **When a layer is loaded the layer settings for all other blocks will also be overwritten by the loaded data.**

- 1 Make sure the layer that you want to load the data into is selected on the TENORI-ON (Function Button [R1] Layer Number: [Page 30](#)).
- 2 Insert the SD Memory Card containing the file you want to load into the TENORI-ON card slot.
- 3 Use the jog dial and [OK] button to navigate to the Current Layer function menu as follows:
"Main menu" → "File menu" → "Current Layer"



- 4 Use the jog dial to highlight the "Load" function, then press the [OK] button.
- 5 Current Layer files on the card will appear as a list on the LCD display (with no file extension). Use the jog dial to select the file you want to load.

- Only files that are in Current Layer format will be displayed.

- Press the [OK] button to load the selected file.
The display shown below will appear while the file is being loaded.
Press the [OK] or [CANCEL] button to cancel the load operation.

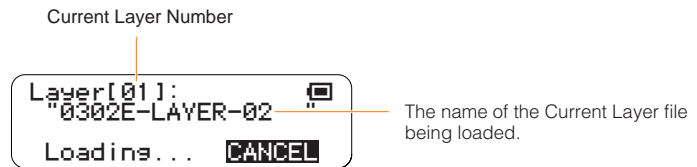

- When the Current Layer file has been loaded the display shown in step 3, above, will appear, and playback of the Current Layer file will begin.
Press the [OK] button in the status display when you want to stop playback.

● Save Current Layer

Saves a Current Layer file containing all active notes and settings such as voice, tempo, etc., for the current layer in the current block to an SD Memory Card.

- Insert an SD Memory Card that has sufficient free space for the file to be saved into the TENORI-ON card slot.
- Use the jog dial and [OK] button to navigate to the Current Layer function menu as follows:
"Main menu" → "File menu" → "Current Layer"

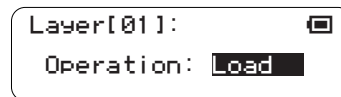

- Use the jog dial to highlight the "Save" function, then press the [OK] button.



- The file name entry display will appear. A default file name will be provided, which you can either use as-is or replace with a name of your own.
File name entry procedure is described in the Rename Song section on [Page 65](#).

- File names can be up to 16 characters in length. The file extension will be added automatically.



- 5** When the file name has been entered as required use the jog dial to highlight the "⏏" symbol in the lower right corner of the display and press the [OK] button.

The file name will be entered and the save function will be executed.

A display like the one shown below will appear while the Current Layer file is being saved.

You can cancel the operation by pressing the [OK] or [CANCEL] button.



File data may be irreparably corrupted if you turn off the power or remove the SD Memory Card while the "Saving..." display is showing.

- If a file with the same name exists on the SD Memory Card an overwrite confirmation display like the one shown below will appear.

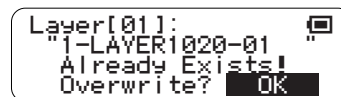

- Press the [OK] button if it's OK to overwrite the file. Press the [CANCEL] button (or use the jog dial to select "CANCEL" on the LCD and then press the [OK] button) to cancel the operation and leave the original file unaltered.

- 6** The display shown in step 3, above, will reappear when the operation has finished.

● Rename Current Layer

Allows a new name to be entered for a Current Layer file on an SD Memory Card.

- 1** Insert the SD Memory Card containing the file you want to rename into the TENORI-ON card slot.

- 2** Use the jog dial and [OK] button to navigate to the Current Layer function menu as follows:

"Main menu" → "File menu" → "Current Layer"

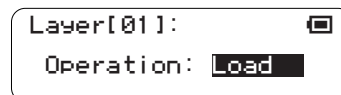

- 3** Use the jog dial to highlight the "Rename" function, then press the [OK] button.

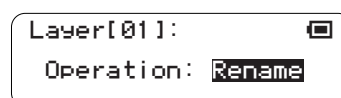

- 4 Current Layer files on the card will appear as a list on the LCD display (with no file extension). Use the jog dial to select the file you want to rename.



- Only files that are in Current Layer format will be displayed.

Press the [OK] button to go to the file name entry display. The name of the currently selected Current Layer file will be displayed, and you can enter a new file name as required. File name entry procedure is described in the Rename Song section on Page 65.

- File names can be up to 16 characters in length. The file extension will be added automatically.

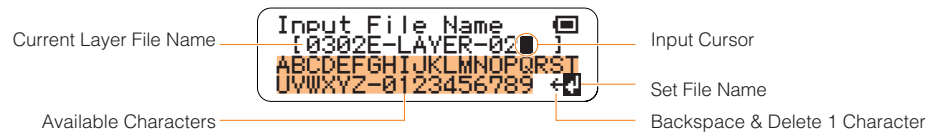

- 5 When the file name has been entered as required use the jog dial to highlight the "↵" symbol in the lower right corner of the display and press the [OK] button. "Executing ..." will appear on the display while the file is being renamed.



File data may be irreparably corrupted if you turn off the power or remove the SD Memory Card while the "Executing..." display is showing.

- If a file with the same name exists on the SD Memory Card an overwrite confirmation display like the one shown below will appear.

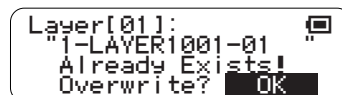

- Press the [OK] button if it's OK to overwrite the file. Press the [CANCEL] button (or use the jog dial to select "CANCEL" on the LCD and then press the [OK] button) to cancel the operation and leave the original file unaltered.

- 6 The display shown in step 3, above, will reappear when the operation has finished.

● Delete Current Layer

Deletes a specified Current Layer file from an SD Memory Card.

- 1 Insert the SD Memory Card containing the file you want to delete into the TENORI-ON card slot.
- 2 Use the jog dial and [OK] button to navigate to the Current Layer function menu as follows:
"Main menu" → "File menu" → "Current Layer"

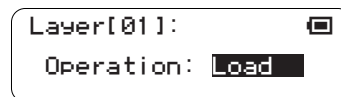

- 3 Use the jog dial to highlight the "Delete" function, then press the [OK] button.



- 4 Current Layer files on the card will appear as a list on the LCD display (with no file extension). Use the jog dial to select the file you want to delete.



- Only files that are in Current Layer format will be displayed.

- 5 Press the [OK] button to delete the selected file.
A confirmation display like the one shown below will appear.
Press the [OK] button if it's OK to delete the file. Press the [CANCEL] button (or use the jog dial to select "CANCEL" on the LCD and then press the [OK] button) to cancel the operation and leave the file unaltered.



If you press the [OK] button to execute the delete operation, "Executing ..." will appear on the display while the file is being deleted.



File data may be irreparably corrupted if you turn off the power or remove the SD Memory Card while the "Executing..." display is showing.

- 6 The display shown in step 3, above, will reappear when the operation has finished.

5. All Settings

Provides access to All Settings file operations.

"All Settings" files include all settings such as voice, tempo, etc., for all layers and blocks. Active notes are not included.

The following 4 All Settings file functions are provided:

Load All Settings	Page 83
Save All Settings	Page 84
Rename All Settings	Page 85
Delete All Settings	Page 86

● Load All Settings

Loads an All Settings file that has been saved to an SD Memory Card into the TENORI-ON.

- 1 Insert the SD Memory Card containing the file you want to load into the TENORI-ON card slot.
- 2 Use the jog dial and [OK] button to navigate to the All Settings function menu as follows: "Main menu" → "File menu" → "All Settings"

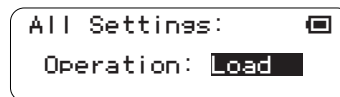

- 3 Use the jog dial to highlight the "Load" function, then press the [OK] button.
- 4 All Settings files on the card will appear as a list on the LCD display (with no file extension). Use the jog dial to select the file you want to load.

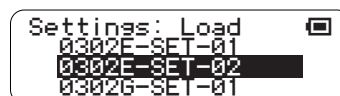

- Only files that are in All Settings format will be displayed.

- 5 Press the [OK] button to load the selected file. The display shown below will appear while the file is being loaded. Press the [OK] or [CANCEL] button to cancel the load operation.

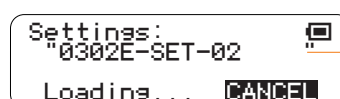

The name of the All Settings file being loaded.

- 6 When the All Settings file has been loaded the display shown in step 2, above, will appear, and playback of the existing active notes will begin using the All Settings data just loaded.

Press the [OK] button in the status display when you want to stop playback.

● Save All Settings

Saves an All Settings file containing all settings such as voice, tempo, etc., for all layers and blocks to an SD Memory Card. Active notes are not included.

- 1 Insert an SD Memory Card that has sufficient free space for the file to be saved into the TENORI-ON card slot.
- 2 Use the jog dial and [OK] button to navigate to the All Settings function menu as follows: "Main menu" → "File menu" → "All Settings"

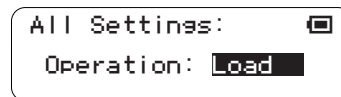

- 3 Use the jog dial to highlight the "Save" function, then press the [OK] button.



- 4 The file name entry display will appear. A default file name will be provided, which you can either use as-is or replace with a name of your own.

File name entry procedure is described in the Rename Song section on [Page 65](#).

- File names can be up to 16 characters in length. The file extension will be added automatically.



- 5 When the file name has been entered as required use the jog dial to highlight the "+" symbol in the lower right corner of the display and press the [OK] button.

The file name will be entered and the save function will be executed.

A display like the one shown below will appear while the All Settings file is being saved. You can cancel the operation by pressing the [OK] or [CANCEL] button.



⚠ File data may be irreparably corrupted if you turn off the power or remove the SD Memory Card while the "Saving..." display is showing.

- If a file with the same name exists on the SD Memory Card an overwrite confirmation display like the one shown below will appear.

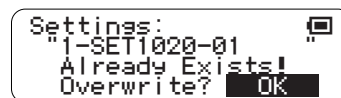

- Press the [OK] button if it's OK to overwrite the file. Press the [CANCEL] button (or use the jog dial to select "CANCEL" on the LCD and then press the [OK] button) to cancel the operation and leave the original file unaltered.

6 The display shown in step 3, above, will reappear when the operation has finished.

● Rename All Settings

Allows a new name to be entered for an All Settings file on an SD Memory Card.

- 1** Insert the SD Memory Card containing the file you want to rename into the TENORI-ON card slot.
- 2** Use the jog dial and [OK] button to navigate to the All Settings function menu as follows: "Main menu" → "File menu" → "All Settings"

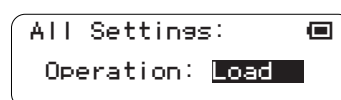

- 3** Use the jog dial to highlight the "Rename" function, then press the [OK] button.



- 4** All Settings files on the card will appear as a list on the LCD display (with no file extension). Use the jog dial to select the file you want to rename.

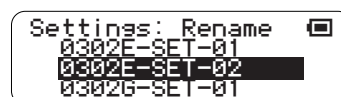

- Only files that are in All Settings format will be displayed.

- 5 Press the [OK] button to go to the file name entry display. The name of the currently selected All Settings file will be displayed, and you can enter a new file name as required. File name entry procedure is described in the Rename Song section on Page 65.

- File names can be up to 16 characters in length. The file extension will be added automatically.

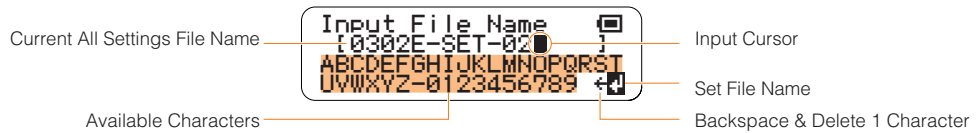

- 6 When the file name has been entered as required use the jog dial to highlight the "↵" symbol in the lower right corner of the display and press the [OK] button. "Executing ..." will appear on the display while the file is being renamed.

⚠ File data may be irreparably corrupted if you turn off the power or remove the SD Memory Card while the "Executing..." display is showing.

- If a file with the same name exists on the SD Memory Card an overwrite confirmation display like the one shown below will appear.

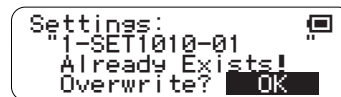

- Press the [OK] button if it's OK to overwrite the file. Press the [CANCEL] button (or use the jog dial to select "CANCEL" on the LCD and then press the [OK] button) to cancel the operation and leave the original file unaltered.

- 7 The display shown in step 3, above, will reappear when the operation has finished.

● Delete All Settings

Deletes a specified All Settings file from an SD Memory Card.

- 1 Insert the SD Memory Card containing the file you want to delete into the TENORI-ON card slot.
- 2 Use the jog dial and [OK] button to navigate to the All Settings function menu as follows: "Main menu" → "File menu" → "All Settings"

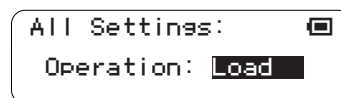

- 3 Use the jog dial to highlight the "Delete" function, then press the [OK] button.



- 4 All Settings files on the card will appear as a list on the LCD display (with no file extension). Use the jog dial to select the file you want to delete.



- Only files that are in All Settings format will be displayed.

- 5 Press the [OK] button to delete the selected file.

A confirmation display like the one shown below will appear.

Press the [OK] button if it's OK to delete the file. Press the [CANCEL] button (or use the jog dial to select "CANCEL" on the LCD and then press the [OK] button) to cancel the operation and leave the file unaltered.



If you press the [OK] button to execute the delete operation, "Executing ..." will appear on the display while the file is being deleted.



File data may be irreparably corrupted if you turn off the power or remove the SD Memory Card while the "Executing..." display is showing.

- 6 The display shown in step 3, above, will reappear when the operation has finished.

6. Samplings

Provides access to Samplings file operations.

The TENORI-ON provides three user voices: <01/16,> <02/16,> and <03/16.> Audio samples can be loaded into the TENORI-ON and played via these voices.

Audio samples can be converted to the sample format used by the TENORI-ON (.tnw file extension) using the TENORI-ON User Voice Manager software provided on the supplied CD-ROM. This menu provides access to a number of functions that can be used to manage ".tnw" files.

The following 5 Samplings file functions are provided:

Load Samplings	Page 93
Save Samplings	Page 94
Rename Samplings	Page 95
Delete Samplings	Page 97
Samplings Info	Page 98

■ Creating User Voices (Sampling Files)

Audio files that have been recorded using a computer or downloaded from the Internet must be converted to the TENORI-ON user voice file format ("sampling" file format with ".tnw" file name extension) before they can be loaded into the TENORI-ON user voice numbers and played.

The TENORI-ON User Voice Manager software provided on the supplied CD-ROM can be used to convert audio files to the appropriate format and assign them to the TENORI-ON LED buttons. Sampling files thus created can then be transferred to the TENORI-ON using an SD Memory Card.

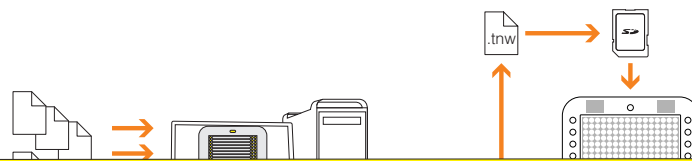

seq
It is necessary to prepare the files
are to be used.

2 Launch the TENORI-ON User Voice Manager software.

Use the TENORI-ON User Voice Manager software included on the supplied CD-ROM to convert your files to the TENORI-ON format and assign them to the appropriate LED buttons.

2-1 Install the TENORI-ON User Voice Manager on your computer following the procedure outlined in the separate "TENORI-ON User Voice Manager Installation Guide" document.

2-2 Double click the "TNR_UserVoiceMgr.exe" or "TNR_UserVoiceMgr.app" file on your computer to launch the software.

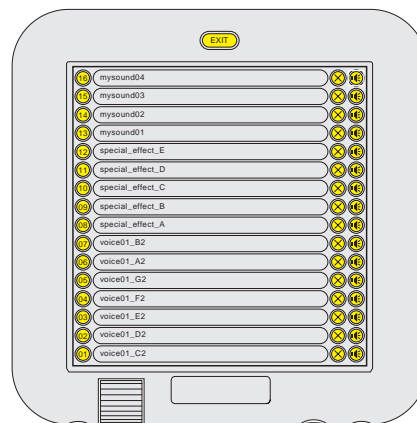

A graphic representation of the TENORI-ON and LED button arrangement in the Score Mode will appear on the display. [LOAD] buttons 1 through 16 on the display correspond to the equivalent TENORI-ON LED button positions.

- When shipped from the factory the vertical-axis of the LED button matrix is assigned to a scale corresponding to the white keys on a piano, as show in the illustration below. If you assign audio files with pitches corresponding to the default pitches of the buttons, your user voice can be played in the same way as the internal voices.

3 Load the audio files.

A dialog window that allows you to select and load an audio file into the TENORI-ON User Voice Manager will appear when you click one of the [LOAD] buttons.

Select the audio file you want to load and assign to the corresponding button. The first 0.97 seconds of the selected WAVE or AIFF file will be used. The names of the assigned audio files will appear to the right of the corresponding [LOAD] buttons (without the file extension).

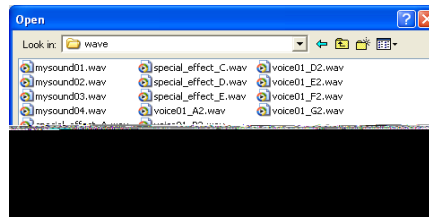

Click a [PLAY] button to play the corresponding audio file.

Click a [DELETE] button to delete (cancel assignment of) the corresponding audio file.

- Audio file icons can also be dragged and dropped on the target [LOAD] button to assign them.
- [LOAD] buttons 01 — 16 correspond to MIDI note numbers 60 — 75. For note numbers outside this range the assignments are repeated in 16-note groups.
- LED buttons to which no audio file is assigned will produce no sound when pressed.

4 Save in TENORI-ON "Sampling" format.

When the audio files have been assigned as required, convert the entire set (all 16 files) to a single TENORI-ON format user voice file, and save the user voice file to an SD Memory Card.

- Use an SD Memory Card with a capacity of 2 gigabytes or less that has been properly formatted using the TENORI-ON formatting function (→ [Page 106](#): [System menu] → [SD Format]).

Click the [MAKE USER VOICE] button.

The file save dialog window will appear. Specify the location you want to save the file to (the SD Memory Card) and the file name if necessary. A default file name consisting of the month and day (e.g. "0901") plus a single character indicating the hour (0...9, A...N), plus four digits indicating the minute and second (e.g. "3620"), plus "-VOICE", plus the file extension (.tnw) will be automatically generated. You can edit the default file name as required, using a maximum of 16 characters. Only capital alphabetic characters and the hyphen ("-") can be used in file names.

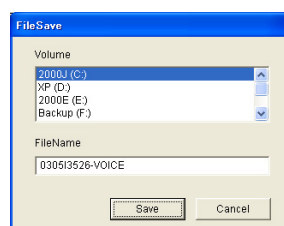

- 5 Click the [EXIT] button to quit the software.
- 6 Insert the SD Memory Card to which the file was saved in step 4, above, into the TENORI-ON card slot.
- 7 Load the file from the SD Memory Card into a user memory. Refer to "Load Samplings" on [Page 93](#) for details.
User voice setup is now complete.
- 8 Play the user voice.
You can now select the user voice by pressing the corresponding LED button while holding the [L1] button, in the same way as you select the internal voices.

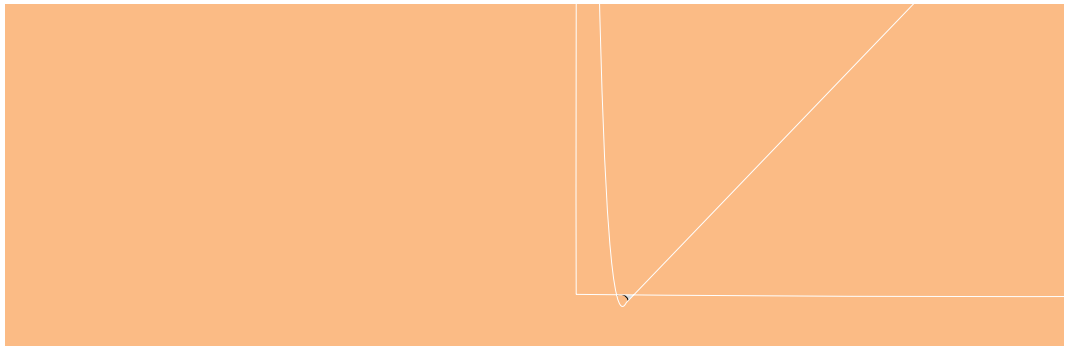

- Octave, transpose, and scale settings do not affect the user voices.
- User voices are retained in memory even when the TENORI-ON is turned off.
- In order to play a song that uses a user voice on a different TENORI-ON, the user voice file must first be loaded into the TENORI-ON on which the song is to be played (→ "Save Samplings" on [Page 94](#), and "Load Samplings" on [Page 93](#)).

● Load Samplings

Loads a Samplings file that has been saved to an SD Memory Card into the TENORI-ON.

- 1 Insert the SD Memory Card containing the file you want to load into the TENORI-ON card slot.
- 2 Use the jog dial and [OK] button to navigate to the Samplings function menu as follows: "Main menu" → "File menu" → "Samplings"

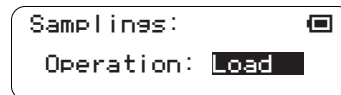

- 3 Use the jog dial to highlight the "Load" function, then press the [OK] button. A display that allows you to specify the user memory to which the loaded sample file will be saved will appear. Use the jog dial to select the desired user memory, then press the [OK] button.
 - In this display "User1," "User2," and "User3" correspond to user memory numbers <01/16,> <02/16,> and <03/16.> The bottom line on the LCD displays the name of the sample file currently loaded in that user memory. If the user memory is empty, "-----" will be displayed.

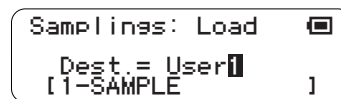

- 4 Samplings files on the card will appear as a list on the LCD display (with no file extension). Use the jog dial to select the file you want to load.



- Only files that are in "tnw" format will be displayed.

- 5 Press the [OK] button to load the selected file. The display shown below will appear while the file is being loaded. Press the [OK] or [CANCEL] button to cancel the load operation.

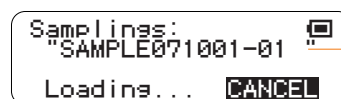

The name of the Samplings file being loaded.

- Sampling file load operations may take a few minutes to complete.

- 6 When the Samplings file has been loaded the display shown in step 2, above, will appear.

● Save Samplings

Saves a Samplings file currently loaded in a user memory to an SD Memory Card in ".tnw" format.

- 1 Insert an SD Memory Card that has sufficient free space for the file to be saved into the TENORI-ON card slot.
- 2 Use the jog dial and [OK] button to navigate to the Samplings function menu as follows: "Main menu" → "File menu" → "Samplings"

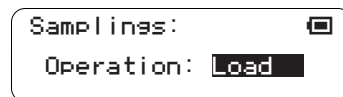

- 3 Use the jog dial to highlight the "Save" function, then press the [OK] button.



- 4 A display that allows you to specify the user memory containing the sample to be saved will appear. Use the jog dial to select the desired user memory (1 — 3), then press the [OK] button.

- In this display "User1," "User2," and "User3" correspond to user memory numbers <01/16,> <02/16,> and <03/16.> The bottom line on the LCD displays the name of the sample file currently loaded in that user memory. If the user memory is empty, "-----" will be displayed.

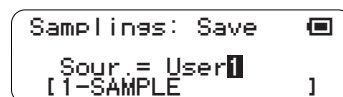

- 5 The file name entry display will appear. A current file name will be displayed, which you can either use as-is or replace with a different name.

File name entry procedure is described in the Rename Song section on [Page 65](#).

- File names can be up to 16 characters in length. The file extension will be added automatically.



- 6** When the file name has been entered as required use the jog dial to highlight the "⏏" symbol in the lower right corner of the display and press the [OK] button. The file name will be entered and the save function will be executed. A display like the one shown below will appear while the All Settings file is being saved. You can cancel the operation by pressing the [OK] or [CANCEL] button.



File data may be irreparably corrupted if you turn off the power or remove the SD Memory Card while the "Saving..." display is showing.

- Sampling file save operations may take a few minutes to complete.
- If a file with the same name exists on the SD Memory Card an overwrite confirmation display like the one shown below will appear.

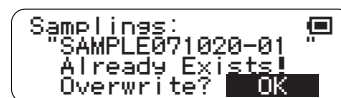

- Press the [OK] button if it's OK to overwrite the file. Press the [CANCEL] button (or use the jog dial to select "CANCEL" on the LCD and then press the [OK] button) to cancel the operation and leave the original file unaltered.

- 7** The display shown in step 3, above, will reappear when the operation has finished.

● Rename Samplings

Allows a new name to be entered for a Samplings file on an SD Memory Card.

- 1** Insert the SD Memory Card containing the file you want to rename into the TENORI-ON card slot.
- 2** Use the jog dial and [OK] button to navigate to the Samplings function menu as follows: "Main menu" → "File menu" → "Samplings"

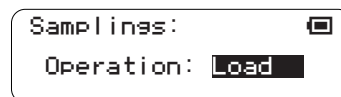

- 3** Use the jog dial to highlight the "Rename" function, then press the [OK] button.



- 4 Samplings files on the card will appear as a list on the LCD display (with no file extension). Use the jog dial to select the file you want to rename.



- Only files that are in ".tnw" format will be displayed.

Press the [OK] button to go to the file name entry display. The name of the currently selected Samplings file will be displayed, and you can enter a new file name as required. File name entry procedure is described in the Rename Song section on Page 65.

- File names can be up to 16 characters in length. The file extension will be added automatically.

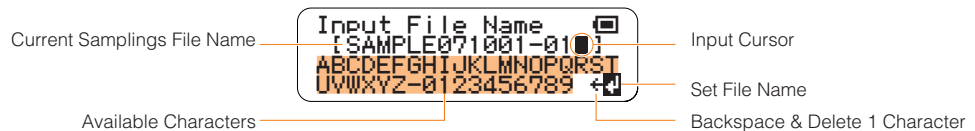

- 5 When the file name has been entered as required use the jog dial to highlight the "↵" symbol in the lower right corner of the display and press the [OK] button. "Executing ..." will appear on the display while the file is being renamed.



File data may be irreparably corrupted if you turn off the power or remove the SD Memory Card while the "Executing..." display is showing.

- If a file with the same name exists on the SD Memory Card an overwrite confirmation display like the one shown below will appear.

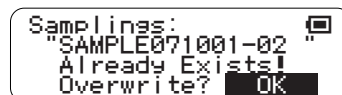

- Press the [OK] button if it's OK to overwrite the file. Press the [CANCEL] button (or use the jog dial to select "CANCEL" on the LCD and then press the [OK] button) to cancel the operation and leave the original file unaltered.

- 6 The display shown in step 3, above, will reappear when the operation has finished.

● Delete Samplings

Deletes a specified Samplings file from an SD Memory Card.

- 1 Insert the SD Memory Card containing the file you want to delete into the TENORI-ON card slot.
- 2 Use the jog dial and [OK] button to navigate to the Samplings function menu as follows: "Main menu" → "File menu" → "Samplings"

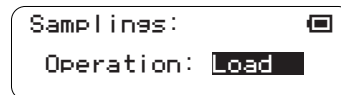

- 3 Use the jog dial to highlight the "Delete" function, then press the [OK] button.



- 4 Samplings files on the card will appear as a list on the LCD display (with no file extension). Use the jog dial to select the file you want to delete.

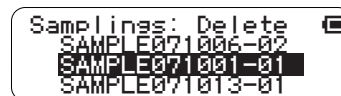

- Only files that are in ".tnw" format will be displayed.

- 5 Press the [OK] button to delete the selected file. A confirmation display like the one shown below will appear. Press the [OK] button if it's OK to delete the file. Press the [CANCEL] button (or use the jog dial to select "CANCEL" on the LCD and then press the [OK] button) to cancel the operation and leave the file unaltered.

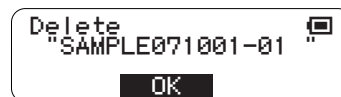

If you press the [OK] button to execute the delete operation, "Executing ..." will appear on the display while the file is being deleted.

 File data may be irreparably corrupted if you turn off the power or remove the SD Memory Card while the "Executing..." display is showing.

- 6 The display shown in step 3, above, will reappear when the operation has finished.

● Samplings Info

Displays the name of the sample files currently loaded in the TENORI-ON user memories.

- 1 Use the jog dial and [OK] button to navigate to the Samplings function menu as follows:
"Main menu" → "File menu" → "Samplings"

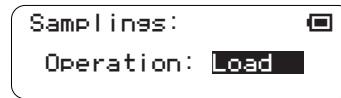

- 2 Use the jog dial to highlight the "Info" function, then press the [OK] button.



- 3 A list of the sample files currently loaded in the TENORI-ON user memories 1 — 3 will be displayed.

- In this display "1," "2," and "3" correspond to user memory numbers <1/16,> <02/16,> and <03/16.> If a user memory is empty, "-----" will be displayed.

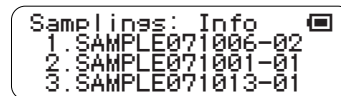

- 4 Press the [OK] or [CANCEL] button to return to the display shown in step 2, above.

■ Effect Menu

The Effect menu provides access to functions that allow you to apply reverb and chorus effects to the TENORI-ON voices.

The Effect menu submenu includes the following 4 items.

1. Reverb Type	Page 99
2. Reverb Param	Page 100
3. Chorus Type	Page 100
4. Chorus Param	Page 100

Use the jog dial to highlight a submenu item, then press the [OK] button to go to the corresponding parameter edit display.



1. Reverb Type



Selects the reverb type.

- NO EFFECT No reverb effect.
- HALL1, HALL2 Concert hall reverb simulations.
- ROOM1, ROOM2, ROOM3The type of reverb you'd hear in a room.
- STAGE1, STAGE 2 Simulations of stage reverb.
- PLATE1, PLATE2 Simulations of studio plate reverb units.

- Range NO EFFECT, HALL1, HALL2, ROOM1, ROOM2, ROOM3, STAGE1, STAGE2, PLATE1, PLATE2
- Default HALL1
- LED Buttons No display

2. Reverb Param



Adjusts the depth of the reverb effect. Higher values produce greater reverb depth.

- Range 0 — 127
- Default 40
- LED Buttons No display

3. Chorus Type

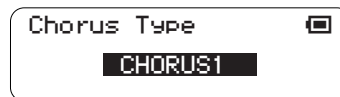

Selects the chorus effect type.

- NO EFFECT No chorus effect.
 - CHORUS1, CHORUS2 Chorus effects.
 - FLANGR1, FLANGR2 Flanger effects.
- Range NO EFFECT, CHORUS1, CHORUS2, FLANGR1, FLANGR2
 - Default NO EFFECT
 - LED Buttons No display

4. Chorus Param

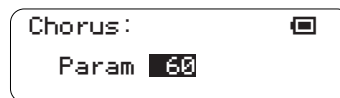

Adjusts the depth of the chorus effect. Higher values produce greater chorus depth.

- Range 0 — 127
- Default 0
- LED Buttons No display

■ Interior Menu

The Interior menu provides access to functions that allow you to set up the TENORI-ON to function as a clock or automatically play back songs (Interior Mode) or to "sleep" if not activated for a specified period of time (Power Save Mode).

The Interior menu submenu includes the following 10 items.

1. Interior START	Page 101
2. Interior Type	Page 102
3. Saver Type	Page 102
4. Saver Time	Page 103
5. Time Signal ON/OFF	Page 103
6. Alarm ON/OFF	Page 103
7. Set Alarm	Page 104
8. Save As Time Signal	Page 104
9. Save As Alarm	Page 105
10. Clock Adjust	Page 105

Use the jog dial to highlight a submenu item, then press the [OK] button to go to the corresponding parameter edit display.



1. Interior Start



Press the [OK] button while this display is showing to immediately begin operation of the Interior Type specified in the next item.

- If you press the [OK] button to start the Interior Mode, The Saver Type is automatically set to "Interior."

- Range None
- LED Buttons No display

2. Interior Type

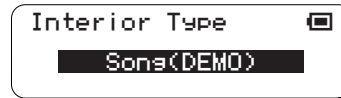

Specifies the type of function that will begin operation when the Interior Mode is started.

- Song (DEMO)Plays the pre-programmed TENORI-ON demo song.
- SONG (SD)Randomly plays Song Files from an SD Memory Card.
- ClockDisplays the time on the TENORI-ON matrix.
- Clock + Song (DEMO)Displays the time on the TENORI-ON matrix while playing the pre-programmed TENORI-ON demo song.
- Clock + Song (SD)Displays the time on the TENORI-ON matrix while randomly playing Song Files from an SD Memory Card.

- Range Song (DEMO), Song (SD), Clock, Clock+Song (DEMO), Clock+Song (SD)
- Default Song (DEMO)
- LED Buttons No display

3. Saver Type

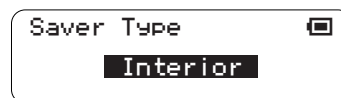

Selects the type of operation that will begin if the TENORI-ON is not operated for a specified period of time.

- Interior ModeClock or song playback as specified by the Interior Type item, above.
- Power Save ModePower Save Mode operation (sequence stop and LED buttons out).

- Range Interior, Power Save
- Default Interior
- LED Buttons No display

4. Saver Time

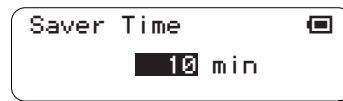

Sets the amount of time that must elapse before saver operation begins.

If the TENORI-ON is not operated for the time specified here, the type of operation specified by the Saver Type item will begin.

- Range OFF, 1 — 1440 (minutes)
- Default 10 (minutes)
- LED Buttons No display

5. Time Signal ON/OFF

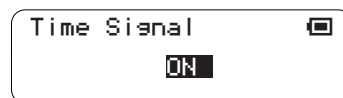

Determines whether an hourly chime will be played during Interior Mode operation. When ON, the chime will sound on the hour at 00 minutes and 00 seconds. The total chime playback time is 8 seconds. Performance data created on the TENORI-ON can be used in place of the standard hourly chime (→ [Page 104](#): Save As Time Signal).

- Range ON, OFF
- Default OFF
- LED Buttons No display

6. Alarm ON/OFF

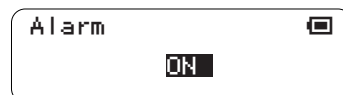

Determines whether the alarm will sound during Interior Mode operation. The total alarm playback time is 48 seconds. Performance data created on the TENORI-ON can be used in place of the standard alarm (→ [Page 105](#): Save As Alarm).

- Range ON, OFF
- Default OFF
- LED Buttons No display

7. Set Alarm

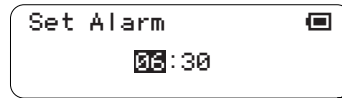

Sets the time at which the alarm will sound during Interior Mode operation.

- If the hourly chime and alarm are set to the same time (the alarm minutes are set to "00"), only the alarm will sound.

- Range 00:00 — 23:59
- Default 00:00
- LED Buttons No display

8. Save As Time Signal

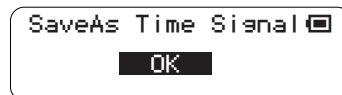

Saves the performance data (active notes and settings) in the current block for use as the time signal that will play as the hourly chime during Interior Mode operation.

- If you use this function to change the time signal (hourly chime), the original default time signal will be erased. To restore the original time signal use the Factory Reset function.

After selecting the block containing the data you want to save as the time signal, press the [OK] button while this display is showing to save the data as the time signal.

- Press the [CANCEL] button (or use the jog dial to select "CANCEL" on the LCD and then press the [OK] button) if you want to cancel the operation.

If you press the [OK] button to execute the operation, "Saving ..." will appear on the display while the data is being saved.



File data may be irreparably corrupted if you turn off the power or remove the SD Memory Card while the "Saving..." display is showing.

- Range OK, CANCEL
- Default OK
- LED Buttons No display

9. Save As Alarm

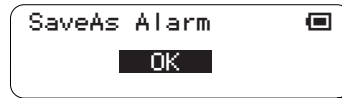

Saves the performance data (active notes and settings) in the current block for use as the alarm that will play during Interior Mode operation.

- If you use this function to change the alarm, the original default alarm will be erased. To restore the original alarm use the Factory Reset function.

After selecting the block containing the data you want to save as the alarm, press the [OK] button while this display is showing to save the data as the alarm.

- Press the [CANCEL] button (or use the jog dial to select "CANCEL" on the LCD and then press the [OK] button) if you want to cancel the operation.

If you press the [OK] button to execute the operation, "Saving ..." will appear on the display while the data is being saved.



File data may be irreparably corrupted if you turn off the power or remove the SD Memory Card while the "Saving..." display is showing.

- Range OK, CANCEL
- Default OK
- LED Buttons No display

10. Clock Adjust

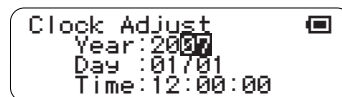

Sets the clock year, month, day, and time.

Press the [OK] button after setting each parameter to highlight the next parameter.

Pressing the [OK] button after the last parameter has been set applies the new clock settings.

- Range Year: 2000 — 2099
Month & Day: 01 — 12/01 — 31
Time: 00 — 23/00 — 59
*Seconds cannot be adjusted.
- Default OK
- LED Buttons No display

■ System Menu

The System menu provides access to functions related to basic system operation, such as factory reset, SD Memory Card formatting, and others.

The System menu submenu includes the following 5 items.

1. Save As Default	Page 106
2. SD Format	Page 107
3. Owner Name	Page 107
4. Version Check	Page 108
5. Factory Reset	Page 108

Use the jog dial to highlight a submenu item, then press the [OK] button to go to the corresponding parameter edit display.



1. Save As Default

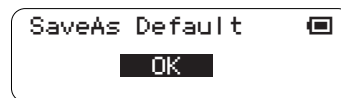

Saves the current settings for all blocks and layers as the power-on defaults that will be automatically recalled when the TENORI-ON is turned on. If this function is not used to save any user settings as defaults, the initial factory settings are used.

Press the [OK] button while this display is showing to save the current settings as the power-on defaults.

When you press the [OK] button "Saving ..." will appear on the display while the data is being saved.

⚠ File data may be irreparably corrupted if you turn off the power or remove the SD Memory Card while the "Saving..." display is showing.

- Press the [CANCEL] button (or use the jog dial to select "CANCEL" on the LCD and then press the [OK] button) if you want to cancel the operation.

- Range OK, CANCEL
- Default OK
- LED Buttons No display

2. SD Format

 Before using SD Memory Cards with the TENORI-ON, be sure to read "Handling SD™ Memory Cards" on Page 63.

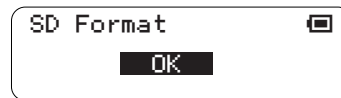

Formats an SD Memory Card for use with the TENORI-ON.

- SD cards with a capacity greater than 32 MB will be formatted using FAT32 format, while SD cards with a capacity of 32 MB or less will be formatted using FAT16 format.

After inserting an SD Memory Card into the card slot, press the [OK] button while this display is showing to begin formatting.

When you press the [OK] button "Formatting ..." will appear on the display while the card is being formatted.

 The format operation will erase all data from the SD Memory Card. Make sure there is not important data you want to keep on a card before formatting it.

 Do not turn off the power or remove the SD Memory Card while the "Formatting..." display is showing.

- Press the [CANCEL] button (or use the jog dial to select "CANCEL" on the LCD and then press the [OK] button) if you want to cancel the operation.

- Range OK, CANCEL
- Default OK
- LED Buttons No display

3. Owner Name



This function lets you register an "Owner Name" in the TENORI-ON memory.

The Owner Name you register will be stored with song files as the "Composer Name", and will be shown on the LCD along with the Song name when the file is played back.

- 1 The factory default owner name – "NO NAME" – will appear on the display. You can enter a new owner name as required.

The name entry procedure is described in the Rename Song section on [Page 65](#).

- Owner names can be up to 16 characters in length.

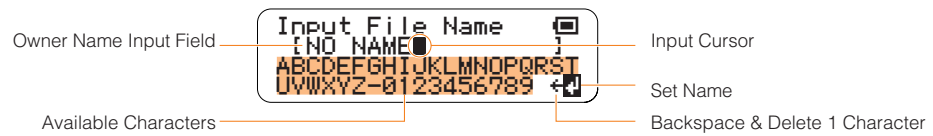

- 2 When the owner name has been entered as required use the jog dial to highlight the "+" symbol in the lower right corner of the display and press the [OK] button.
- 3 The submenu display will reappear when the name has been entered.

4. Version Check



Displays the version number of the TENORI-ON system ROM.

5. Factory Reset

Resets all TENORI-ON parameters to the original factory settings. All blocks and all layers are restored to the factory default settings, and all active notes are cleared. All registered data – alarm, time signal, owner name, etc. – will also be cleared, as will the Save As Default (→ [Page 106](#)) settings. Loaded sampling files will not be initialized.

Press the [OK] button while this display is showing to restore the factory defaults.

- Press the [CANCEL] button (or use the jog dial to select "CANCEL" on the LCD and then press the [OK] button) if you want to cancel the operation.

- Range OK, CANCEL
- Default OK
- LED Buttons No display

■ Recording Menu

This menu provides access to the TENORI-ON real-time recording function.

 **Before using SD Memory Cards with the TENORI-ON, be sure to read "Handling SD™ Memory Cards" on Page 63.**

- 1 Insert an SD Memory Card that has been properly formatted by the TENORI-ON into the card slot.
- 2 Use the jog dial select "Main Menu" → "Recording menu," then press the [OK] button to the Recording menu START display.



- 3 Press the [OK] button while the above display is showing to begin recording.

- Master volume (→ Page 33) changes will be recorded during song recording, whereas hardware volume (→ Page 43) will not.
- Press the [CANCEL] button if you want to cancel recording.

Recording will begin from the instant you press the [OK] button, and all performance data for all layers and blocks (note position data), LED button operations, function button operations (voice, tempo settings, etc.), and [CLEAR] button operations will be recorded in real time. The maximum amount of data that can be recorded is 39 kilobytes. This corresponds to approximately 1,000 button or dial operations. The following display will appear during recording, showing the current layer status and elapsed recording time.



- 4 Press the [OK] button to stop recording.

A display that will allow the recorded performance to be saved as a Song File to the SD Memory Card will appear. Press the [OK] button to begin the Song file save procedure.

- Press the [CANCEL] button (or use the jog dial to select "CANCEL" on the LCD and then press the [OK] button) if you want to cancel the recording.

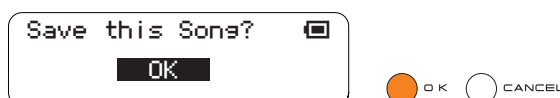

- 5** The Song File name entry display will appear. A default file name will be displayed, which you can either use as-is or replace with a different name.

File name entry procedure is described in the Rename Song section on [Page 65](#).

- File names can be up to 16 characters in length. The file extension will be added automatically.

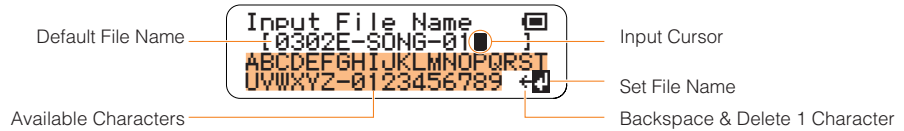

- 6** When the file name has been entered as required use the jog dial to highlight the "⏏" symbol in the lower right corner of the display and press the [OK] button.

The file name will be entered and the save function will be executed.

A display like the one shown below will appear while the Song file is being saved.

You can cancel the operation by pressing the [OK] or [CANCEL] button.



File data may be irreparably corrupted if you turn off the power or remove the SD Memory Card while the "Saving..." display is showing.

- If a file with the same name exists on the SD Memory Card an overwrite confirmation display like the one shown below will appear.

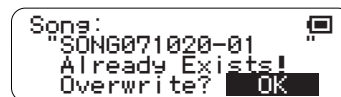

- Press the [OK] button if it's OK to overwrite the file. Press the [CANCEL] button (or use the jog dial to select "CANCEL" on the LCD and then press the [OK] button) to cancel the operation and leave the original file unaltered.

- 7** The display shown in step 2, above, will reappear when the operation has finished.

- Songs cannot be edited after they have been recorded. However, you can save the current layer or block(s) by selecting and saving All Blocks, Current Block, or Current Layer from the File menu, and then reload the data and edit it as required.

Appendix

Display Message List

Power Save...	Power Save mode in operation.
Mode different. Can't Copy!	This message will appear if you attempt to use the CopythisLayer function (→ page 56) to copy between layers that have different performance modes. Data cannot be copied between layers that have different mode.
UNDO?	This message will appear after you execute a copy, clear, or reset function from the Edit menu. Press the [OK] button to undo the copy, clear, or reset function just executed. Press the [CANCEL] button, or any button other than the [OK] button, or wait for the 15-second timeout to return to the menu.
Loading...	Currently loading a file. Don't turn off the power or remove the SD Memory Card while this display is showing.
Saving...	Currently saving a file to an SD Memory Card or the internal flash memory. Don't turn off the power or remove the SD Memory Card while this display is showing.
Executing...	Currently executing a file rename or delete operation. Don't turn off the power or remove the SD Memory Card while this display is showing.
Formatting...	Currently formatting an SD Memory Card.
SD Card Error! No SD Card.	No SD Memory Card is in the card slot.
Unformatted!	The SD Memory Card in the card slot has not been formatted.
SD Card Error! Card is Locked.	The SD Memory Card write-protect switch is "ON" (write protected).
SD Card Error! Access Timeout.	A timeout error has occurred during a SD Memory Card save or load operation.
SD Card Error! Illegal Media.	The media in the card slot is unsupported.
SD Card Error! Card is Full.	The SD Memory Card is full and no more data can be written to it.
SD Card Error! Card is Not Ready.	The SD Memory Card is not ready for a read or write operation.
SD Card Error! Illegal File Name.	The name specified for ma file load operation is not allowed.
SD Card Error! Illegal Format.	The format of the card in the card slot is not supported.
SD Card Error! Not Supported File.	The file format is not supported.
SD Card Error! The File is Broken.	The file is corrupted.
SD Card Error! Can not Open File.	The file cannot be opened.
SD Card Error! Can not Write File.	The file cannot be written.
SD Card Error! Can not Read File.	The file cannot be read.
SD Card Error! Unexpected Error.	An unexpected error has occurred.
SD Card Error! Mode is Different.	The performance mode and TENORI-ON mode are different.
Alarm Playins...	The alarm is currently playing in the Interior Mode.
Time Signal...	The time signal is currently playing in the Interior Mode.

Display Message List

Clear Layer Block[**] Layer[**]	All active notes have been cleared from the current layer/block.
Clear All	All active notes have been cleared from all layers and blocks.
Songs Already Exists! Overwrite?	This display will appear when a song file with the same name already exists. Press the [OK] button if it's OK to overwrite the file. Press the [CANCEL] button to cancel the overwrite operation.
Blocks Already Exists! Overwrite?	This display will appear when an all block file with the same name already exists. Press the [OK] button if it's OK to overwrite the file. Press the [CANCEL] button to cancel the overwrite operation.
Block[**] Already Exists! Overwrite?	This display will appear when a block file with the same name already exists. Press the [OK] button if it's OK to overwrite the file. Press the [CANCEL] button to cancel the overwrite operation.
Layer[**] Already Exists! Overwrite?	This display will appear when a layer file with the same name already exists. Press the [OK] button if it's OK to overwrite the file. Press the [CANCEL] button to cancel the overwrite operation.
Settings Already Exists! Overwrite?	This display will appear when a setting file with the same name already exists. Press the [OK] button if it's OK to overwrite the file. Press the [CANCEL] button to cancel the overwrite operation.
Samplings Already Exists! Overwrite?	This display will appear when a sampling file with the same name already exists. Press the [OK] button if it's OK to overwrite the file. Press the [CANCEL] button to cancel the overwrite operation.

Troubleshooting

Symptom	Possible Cause & Solution	Page
Overall		
Clicks and pops occur occasionally.	Noise can be produced by nearby electronic devices being turned on or off, electrical motors, or similar sources. Try to use an electrical output as far away from the suspected noise source as possible. If no cause can be found, contact your Yamaha service center.	–
Interference from mobile phones, radios, television sets, and similar devices.	Interference can be caused by mobile phones, radio transmitters, or similar devices operating in the vicinity of the instrument. If the noise seems to be excessive contact your Yamaha service center.	–
The instrument causes interference with radios or television sets.	This instrument can cause interference if operated too close to radio or television receivers. Move the instrument further away from the receiving devices if interference occurs.	–
No response to long button presses.	The long-press (sensitivity) parameter may be set to too long a time. Reduce the time setting.	page 60
No Sound		
No Sound	Local Control may be off. If off it should be turned on.	page 61
	The volume may be turned all the way down. Turn it up to an appropriate level.	page 33, 43
	A pair of headphones or external speakers may be connected.	–
	The mute function may be engaged. Turn it off.	page 47
	MIDI connection is not established with the Master TENORI-ON, or does not operate properly, even though "Slave Mode" is selected in the "Preference menu".	–
Some notes cut off.	The instrument's 32-note maximum polyphony has been exceeded (i.e. more than 32 notes are being played at once).	–
	In all modes other than the Push Mode, only one note of a given pitch can play at the same time in a single layer. When a second note of the same pitch is played in the same layer, any previous note of the same pitch is turned off before the new note is played.	–
	The Sound Length setting is too long. The TENORI-ON uses a stereo tone generator (each note uses two notes of the instrument's polyphony), so when a long Sound Length is specified the maximum polyphony (number of simultaneous notes) can be easily exceeded, with the result that the notes may not play as expected.	–
Pitch and Voices		
The scale assigned to the vertical/horizontal axis does not sound right.	A scale other than the default Ionian scale has been selected. Select the Ionian scale.	page 44
When a new block is selected and the voice is changed, the voice used in the first layer changes as well.	The same voice applies to the same-numbered layers in all blocks.	page 6
Data Storage and Initialization		
Settings are not retained at the next power-on.	Save settings you want retained using the Save As Default function.	page 106
Some parameters are not initialized when the Reset All Blocks function is executed.	Some parameters saved using the Save As Default function are not initialized.	page 39

Symptom	Possible Cause & Solution	Page
SD Memory Card		
Can't record or play.	The SD Memory Card is write-protected. Set the card's write-protect switch to the OFF position.	page 63
	Too much performance data. Performances that exceed 39KB (About 1000 operations) cannot be recorded.	-
	Not enough remaining SD Memory Card capacity. Use a different SD Memory Card.	-
Cannot perform file operations.	Save and rename operations can only be performed on up to 100 files that have file names in which the first five characters are the same.	-
	The SD Memory Card is write-protected. Set the card's write-protect switch to the OFF position.	page 63
	Not enough remaining SD Memory Card capacity. Use a different SD Memory Card.	-
	The maximum number of files has been exceeded. Up to 1,000 files can be stored in the TENORI-ON folder, or up to 256 files of each file-extension type.	page 62
A loaded All Blocks, Current Block, or Current Layer file does not play automatically.	If playback is paused when a file is loaded, the loaded file will not be played automatically. Return to the status display and press the [OK] button to begin playback.	-
Others		
The loop indicator doesn't move.	The pause mode may have been engaged by pressing the [OK] button. Press the [OK] button a second time.	-
The loop point and/or loop speed settings have changed.	These settings change when the Play menu Master Loop Point and Master Loop Speed settings are changed.	-

MIDI Data Format

TENORI-ON MIDI Transmit/Receive Event Specifications

1. Transmittable/Receivable System Messages

The TENORI-ON transmits MIDI messages corresponding to operations performed on it, and received MIDI messages can be used to control the TENORI-ON tone generator. System messages that can be transmitted and received by the TENORI-ON are listed below. Refer to the MIDI Implementation Chart for other message types.

System Messages that Can Be Transmitted and Received By the TENORI-ON

Type	Details	Transmit	Receive
System Realtime	Timing Clock (F8)	○*1	○*2
	Start (FA)	○*1	○*2
	Continue (FB)	×	○*2
	Stop (FC)	○*1	○*2
	Active Sensing (FE)	○*1	○*3
System Exclusive	Master Volume (F0 7F 7F 04 01 00 dd F7)	○	○*3
	Master Volume (F0 43 10 4C 00 00 04 dd F7)	×	○*3
	Master Tune (F0 43 10 27 30 00 00 dd dd 00 F7)	○	○*3
	Master Tune (F0 43 10 4C 00 00 00 dd dd dd dd F7)	×	○*3
	Reverb Type (F0 43 10 4C 02 01 00 dd dd F7)	○	○*3
	Chorus TType (F0 43 10 4C 02 01 20 dd dd F7)	○	○*3
	TENORI-ON Exclusive (F0 43 73 01 33 00 dd dd dd F7)	○	×

*1 Transmitted only in Master Mode. *2 Received only in Slave Mode. *3 Received only in Master Mode.

System Realtime Messages FE and F8 are continuously transmitted (in the Master Mode) after startup regardless of sequencer start/stop operations.

2. TENORI-ON Specific System Exclusive Messages

MIDI messages corresponding to button or dial operations performed on the TENORI-ON are output as System Exclusive Messages. The format used for these messages is listed below.

11110000	F0	Exclusive Status
01000011	43	YAMAHA ID
01110011	73	Device ID
00000001	01	Model ID
00110011	33	Sub ID 1
00000000	00	Sub ID 2
0ddddd	dd	Data1
0ddddd	dd	Data2
0ddddd	dd	Data3
11110111	F7	End of Exclusive

Data1

B7	B6	B5	B4	B3	B2	B1	B0
0	0	0	TYPE1	TYPE0	0	STAT1	STAT0

TYPE [1:0]

Controller Types

TYPE1	TYPE0	Controller
0	0	Frame Button
0	1	Panel Button
1	0	Dial

STAT [1:0]

Controller Status

STAT1	STAT0	Status
0	0	Button OFF or Dial Down
0	1	Button ON or Dial Up
1	1	Dial Stop

Data2

B7	B6	B5	B4	B3	B2	B1	B0
0	0	0	X4	X3	X2	X1	X0

X [4:0]

When TYPE [1:0] is 00 (Frame Button):**Frame Button Types**

X4	X3	X2	X1	X0	Button
0	0	0	0	0	Cancel
0	0	0	0	1	OK
0	0	0	1	0	Clear
0	1	0	0	0	R1
0	1	0	0	1	R2
0	1	0	1	0	R3
0	1	0	1	1	R4
0	1	1	0	0	R5
1	0	0	0	0	L1
1	0	0	0	1	L2
1	0	0	1	0	L3
1	0	0	1	1	L4
1	0	1	0	0	L5

When TYPE [1:0] is 01 (Panel Button):**Panel Button Horizontal Axis (0, 1, 2, ... 15, from left to right).**

X4	X3	X2	X1	X0
0	Panel Button Horizontal Axis (0-15)			

When TYPE [1:0] is 10 (Dial):**Dial Control Range (0-15).**

X4	X3	X2	X1	X0
0	Dial Control Range (0-15)			

Data3

B7	B6	B5	B4	B3	B2	B1	B0
0	0	0	0	Y3	Y2	Y1	Y0

Y [3:0]

When TYPE [1:0] is 01 (Panel Button):**Panel Button Vertical Axis (0, 1, 2, ... 15, from top to bottom).**

Y3	Y2	Y1	Y0
Panel Button Vertical Axis (0-15)			

When TYPE [1:0] is 00 (Frame Button) or 10 (Dial):**All 0.**

Y3	Y2	Y1	Y0
0	0	0	0

Model TNR-W MIDI Implementation Chart

Function...	Transmitted	Recognized	Remarks
Basic Channel Default Changed	1 - 16 X	1 - 16 X	
Mode Default Messages Altered	3 X *****	3 X X	
Note Number : True voice	0 - 127 *****	0 - 127 0 - 127	
Velocity Note ON Note OFF	O 9nH, v=100 X	O 9nH, v=1-127 X	
After Touch Key's Ch's	X X	X X	
Pitch Bend	X	X	
Control Change 0,32 7 10 11 91,93	O O O O O	O O O O O	Bank Select Main Volume Panpot Expression Effect Depth
Prog Change : True #	O 0 - 127 *****	O 0 - 127	
System Exclusive	O	O	
Common : Song Pos. : Song Sel. : Tune	X X X	X X X	
System : Clock Real Time : Commands	O O	O*1 O*1	
Aux : All Sound Off : Reset All Cntrls : Local ON/OFF : Mes- : All Notes OFF : sages: Active Sense : Reset	X X X X O X	X (120,126,127) X (121) X X (123-125) O X	
Note : *1 Only effective in Slave Mode.			

Voice List

When you specify a program change as a number in the range of 0 — 127, specify a number that is one less than the program number listed below.

Category	Voice #			Displayed Voice Number (Vertical/ Horizontal)	Voice Name
	MSB #	LSB #	Prog #		
Layer 1	63	1	1	01/01	Photon
	63	1	2	01/02	Photopia
	63	1	3	01/03	Pearl
	63	1	4	01/04	Pulse
	63	1	5	01/05	Cell
	63	1	6	01/06	Pixel
	63	1	7	01/07	Serene
	63	1	8	01/08	Electron
	63	1	9	01/09	Winter
	63	1	10	01/10	SoftMmb
	63	1	11	01/11	SoftAcco
	63	1	12	01/12	SoftHarm
	63	1	13	01/13	GrandPno
	63	1	14	01/14	QuietPno
	63	1	15	01/15	OldPiano
	63	0	1	01/16	User1
Layer 2	63	1	16	02/01	eKalimba
	63	1	17	02/02	LiteOrg
	63	1	18	02/03	GlassTap
	63	1	19	02/04	Drop
	63	1	20	02/05	Shimmery
	63	1	21	02/06	Mist
	63	1	22	02/07	Acorn
	63	1	23	02/08	Chime
	63	1	24	02/09	ThumbPno
	63	1	25	02/10	ToyTrain
	63	1	26	02/11	ToyBanjo
	63	1	27	02/12	LazyBass
	63	1	28	02/13	Crocus
	63	1	29	02/14	CandyCan
	63	1	30	02/15	Peaceful
63	0	2	02/16	User2	
Layer 3	63	1	31	03/01	OrgFlute
	63	1	32	03/02	GtrHarmo
	63	1	33	03/03	GreenFlt
	63	1	34	03/04	Lonely
	63	1	35	03/05	Murmur
	63	1	36	03/06	OrganLT
	63	1	37	03/07	TinyWind
	63	1	38	03/08	Bassoon
	63	1	39	03/09	Hopper
	63	1	40	03/10	PopEcho
	63	1	41	03/11	PopStr
	63	1	42	03/12	Maple
	63	1	43	03/13	ToyRobot
	63	1	44	03/14	Tropical
	63	1	45	03/15	Floating
	63	0	3	03/16	User3

Category	Voice #			Displayed Voice Number (Vertical/ Horizontal)	Voice Name
	MSB #	LSB #	Prog #		
Layer 4	63	1	46	04/01	NMCanon
	63	1	47	04/02	LeedPlus
	63	1	48	04/03	DotGame
	63	1	49	04/04	HardBeep
	63	1	50	04/05	PopFlang
	63	1	51	04/06	PeekTone
	63	1	52	04/07	RetroPop
	63	1	53	04/08	SonarPad
	63	1	54	04/09	CaveDrop
	63	1	55	04/10	DullBeep
	63	1	56	04/11	SnapStr
	63	1	57	04/12	MellowB
	63	1	58	04/13	BasicB
	63	1	59	04/14	PowerB
	63	1	60	04/15	MetalB
	63	1	61	04/16	SlowB
Layer 5	63	1	62	05/01	EchoBass
	63	1	63	05/02	PizzStr
	63	1	64	05/03	SinePop
	63	1	65	05/04	PowerPop
	63	1	66	05/05	Blip
	63	1	67	05/06	WindPass
	63	1	68	05/07	DonPiyo
	63	1	69	05/08	MetalHit
	63	1	70	05/09	BuzzPop
	63	1	71	05/10	FlowOut
	63	1	72	05/11	Spring
	63	1	73	05/12	BublEcho
	63	1	74	05/13	Pico
	63	1	75	05/14	LightPop
	63	1	76	05/15	RainDrop
	63	1	77	05/16	Creak
Layer 6	63	1	78	06/01	TreeFrog
	63	1	79	06/02	Squeeze
	63	1	80	06/03	FootStep
	63	1	81	06/04	Carib
	63	1	82	06/05	Point
	63	1	83	06/06	EchoTom
	63	1	84	06/07	PureTom
	63	1	85	06/08	TinBox
	63	1	86	06/09	Boom
	63	1	87	06/10	LowBoom
	63	1	88	06/11	EchoBoom
	63	1	89	06/12	SoftBoom
	63	1	90	06/13	LargeBox
	63	1	91	06/14	Barrel
	63	1	92	06/15	AirSynth
	63	1	93	06/16	SteelDrm

Voice List

Category	Voice #			Displayed Voice Number (Vertical/ Horizontal)	Voice Name
	MSB #	LSB #	Prog #		
Layer 7	63	1	94	07/01	HighKit
	63	1	95	07/02	BumpKit
	63	1	96	07/03	StompKit
	63	1	97	07/04	BangKit
	63	1	98	07/05	ScrubKit
	63	1	99	07/06	HandKit
	63	1	100	07/07	MouthKit
	63	1	101	07/08	EastKit
	63	1	102	07/09	EastKit2
	63	1	103	07/10	EchoKit
	63	1	104	07/11	PowerKit
	63	1	105	07/12	SnapKit
	63	1	106	07/13	LowKit
	63	1	107	07/14	MidKit
	63	1	108	07/15	Knocks
	63	1	109	07/16	Stomp
Layer 8	63	1	110	08/01	Square
	63	1	111	08/02	Aroma
	63	1	112	08/03	Sprout
	63	1	113	08/04	Spot
	63	1	114	08/05	Quasar
	63	1	115	08/06	BeanBag
	63	1	116	08/07	TipToe
	63	1	117	08/08	Gemini
	63	1	118	08/09	Apollo
	63	1	119	08/10	Hexagon
	63	1	120	08/11	Green
	63	1	121	08/12	DoLoop
	63	1	122	08/13	Milli
	63	1	123	08/14	Centi
	63	1	124	08/15	Deca
63	1	125	08/16	Hect	
Layer 9	63	2	1	09/01	Peanuts
	63	2	2	09/02	Walnut
	63	2	3	09/03	Ping
	63	2	4	09/04	Pong
	63	2	5	09/05	Mallet
	63	2	6	09/06	HumOrgan
	63	2	7	09/07	BuzOrgan
	63	2	8	09/08	PopOrgan
	63	2	9	09/09	JazOrgan
	63	2	10	09/10	ResOrgan
	63	2	11	09/11	FuzOrgan
	63	2	12	09/12	PufOrgan
	63	2	13	09/13	PicOrgan
	63	2	14	09/14	DropEcho
	63	2	15	09/15	Sesame
	63	2	16	09/16	Delta

Category	Voice #			Displayed Voice Number (Vertical/ Horizontal)	Voice Name
	MSB #	LSB #	Prog #		
Layer 10	63	2	17	10/01	Marble
	63	2	18	10/02	PinBall
	63	2	19	10/03	TinToy
	63	2	20	10/04	Chick
	63	2	21	10/05	Vibes
	63	2	22	10/06	SineMmb
	63	2	23	10/07	Harp
	63	2	24	10/08	Opinion
	63	2	25	10/09	Stuffy
	63	2	26	10/10	Sulky
	63	2	27	10/11	Log
	63	2	28	10/12	Oscillat
	63	2	29	10/13	Grief
	63	2	30	10/14	Bubble
	63	2	31	10/15	Plankton
	63	2	32	10/16	Popcorn
Layer 11	63	2	33	11/01	Acordion
	63	2	34	11/02	Viola
	63	2	35	11/03	Cello
	63	2	36	11/04	Violin
	63	2	37	11/05	Contrabs
	63	2	38	11/06	SfotStr
	63	2	39	11/07	Strings
	63	2	40	11/08	Piccolo
	63	2	41	11/09	Flute
	63	2	42	11/10	Recorder
	63	2	43	11/11	PanFlute
	63	2	44	11/12	Bagpipe
	63	2	45	11/13	Clarinet
	63	2	46	11/14	Oboe
	63	2	47	11/15	Harmnica
	63	2	48	11/16	El.Grand
Layer 12	63	2	49	12/01	LadyBird
	63	2	50	12/02	Tsugumi
	63	2	51	12/03	WhiteEye
	63	2	52	12/04	NewHope
	63	2	53	12/05	Trickle
	63	2	54	12/06	MayFly
	63	2	55	12/07	Moth
	63	2	56	12/08	GlasPerc
	63	2	57	12/09	SineLead
	63	2	58	12/10	Flick
	63	2	59	12/11	Doze
	63	2	60	12/12	Sleep
	63	2	61	12/13	ElecToy
	63	2	62	12/14	Frog
	63	2	63	12/15	RadioPno
	63	2	64	12/16	Droid

Voice List

Category	Voice #			Displayed Voice Number (Vertical/ Horizontal)	Voice Name
	MSB #	LSB #	Prog #		
Layer 13	63	2	65	13/01	Children
	63	2	66	13/02	Aqua
	63	2	67	13/03	Pierrot
	63	2	68	13/04	Musicbox
	63	2	69	13/05	Fairy
	63	2	70	13/06	Ukulet
	63	2	71	13/07	Molecule
	63	2	72	13/08	Sparkler
	63	2	73	13/09	AirTweet
	63	2	74	13/10	Neutrino
	63	2	75	13/11	CosmoRay
	63	2	76	13/12	Elf
	63	2	77	13/13	Elfin
	63	2	78	13/14	ChitChat
	63	2	79	13/15	RayDrop
	63	2	80	13/16	Ozone
Layer 14	63	2	81	14/01	Chrome
	63	2	82	14/02	Oak
	63	2	83	14/03	Awake
	63	2	84	14/04	Ebony
	63	2	85	14/05	Epoxy
	63	2	86	14/06	Pendulum
	63	2	87	14/07	Xylophon
	63	2	88	14/08	Marimba
	63	2	89	14/09	MetalXY
	63	2	90	14/10	SoftFoot
	63	2	91	14/11	PopUP
	63	2	92	14/12	Helium
	63	2	93	14/13	Locust
	63	2	94	14/14	TinyBell
63	2	95	14/15	PopVibes	
63	2	96	14/16	Balimba	
Layer 15	63	2	97	15/01	Candera
	63	2	98	15/02	Orbit
	63	2	99	15/03	Helix
	63	2	100	15/04	Fade
	63	2	101	15/05	Appear
	63	2	102	15/06	SlowRay
	63	2	103	15/07	PhaseOrg
	63	2	104	15/08	Sunspot
	63	2	105	15/09	Whistle
	63	2	106	15/10	Corona
	63	2	107	15/11	Diode
	63	2	108	15/12	Zone
63	2	109	15/13	Venus	
63	2	110	15/14	Mercury	
63	2	111	15/15	Polar	
63	2	112	15/16	Pai	

Category	Voice #			Displayed Voice Number (Vertical/ Horizontal)	Voice Name
	MSB #	LSB #	Prog #		
Layer 16	63	2	113	16/01	SlowFlux
	63	2	114	16/02	AirFlow
	63	2	115	16/03	Dynamo
	63	2	116	16/04	Field
	63	2	117	16/05	Closed
	63	2	118	16/06	Parallel
	63	2	119	16/07	Proton
	63	2	120	16/08	Radiator
	63	2	121	16/09	Neutron
	63	2	122	16/10	Particle
	63	2	123	16/11	Aerial
	63	2	124	16/12	Ion
	63	2	125	16/13	Glow
	63	2	126	16/14	Spiral
	63	2	127	16/15	Oxygen
	63	2	128	16/16	Velocity

- A**
- Active Notes 16
 - Alarm ON/OFF 103
 - All Block Set 39
 - All Blocks 68
 - All Settings 83
 - Animation 53
- B**
- Backup 39
 - Block 5, 34
 - Bounce Mode 19
- C**
- CANCEL 38, 54
 - Chorus Param 100
 - Chorus Type 100
 - CLEAR 13
 - Clear All Blocks 57
 - Clear this Block 55
 - Clear this Layer 57
 - Clock Adjust 105
 - Connecting 7
 - Copy this Block 55
 - Copy this Layer 56
 - Current Block 73
 - Current Layer 78
- D**
- Demo Song 102
 - Display 12
 - Draw Mode 18
- E**
- Edit Menu 54
 - Effect Menu 99
- F**
- Factory Reset 108
 - File Menu 62
 - Format (SD Memory Card) 107
 - Function Buttons 23
- H**
- Hardware Volume 43
- I**
- Initialization 39
 - Instrument 24, 49
 - Interior Menu 101
 - Interior Start 101
 - Interior Type 102
- J**
- Jog Dial 36
- L**
- [L1] 24
 - [L2] 25
 - [L3] 26
 - [L4] 27, 28
 - [L5] 29
 - Layer 4, 5, 30
 - Layer Menu 48
 - Layer Volume 33
 - Local Control 61
 - Loop Indicator 15, 61
 - Loop Point 27, 46
 - Loop Speed (Layer) 29, 51
 - Loop Speed (Master) 45
- M**
- Master Loop Point 46
 - Master Loop Speed 45
 - Master Scale 44
 - Master Tempo 31, 43
 - Master Transpose 32, 45
 - Master Tuning 60
 - Master Volume 33
 - MIDI 7, 115, 118
 - Mute 47
- O**
- Octave 26
 - OK 37
 - Owner Name 107
- P**
- Panpot 53
 - Parameter 22, 39, 40, 41
 - Performance Mode 4, 12
 - Play Menu 42
 - Power Save 10, 102
 - Preference Menu 59
 - Push Mode 20
 - Push Sensitivity 60
- Q**
- Quantize 60
- R**
- [R1] 30
 - [R2] 31
 - [R3] 32
 - [R4] 33
 - [R5] 34
- Random Mode 17, 28
 - Recording Menu 109
 - Reset All Blocks 58
 - Reset Loop Timing 46
 - Reverb Param 100
 - Reverb Type 99
 - Rotation 28
- S**
- Samplings 88
 - Save 39
 - Save All Blocks 69
 - Save As Alarm 105
 - Save As Default 106
 - Save As Time Signal 104
 - Saver Time 103
 - Saver Type 102
 - Score Mode 15, 27
 - SD Memory Card 9, 63
 - Set Alarm 104
 - Solo Mode 21
 - Song 64
 - Song (Playback) 65
 - Song (Recording) 109
 - Sound Length 25, 52
 - Status Display 12
 - Stop Playback 14
 - Storage 39
 - Synchronize 61
 - System Menu 106
- T**
- Time Signal ON/OFF 103
- U**
- Undo 54
 - User Voice 24, 89
- V**
- Version Check 108



<http://www.global.yamaha.com/tenori-on>

Yamaha Home Keyboards Home Page (English only)

<http://music.yamaha.com/homekeyboard>

Yamaha Manual Library

<http://www.yamaha.co.jp/manual/>