

# VocoPro

ULTIMATE CHOICE OF KARAOKE ENTERTAINMENT

## FEATURES:

- Fully BPM (Beats Per Minute) synchronizable multi-effect signal processor includes REVERB, ECHO, PAN, FLANGER, TRANSFORM, FILTER and PITCH BEND.
- Vocal Harmonizer with 2 stages of Higher octaves, 2 stages of Lower octaves and Double effect.
- Professional Digital Echo can be used simultaneously with Vocal Harmonizer, Reverb and all other effects.
- Range and Level parameters for each effect.
- 3 XLR or 1/4" mic inputs with individual volume controls.
- Balanced XLR outputs for optimal fidelity to your sound system and 2 pairs of RCA outputs.
- 3 pairs of RCA inputs for connection of external players or other components.
- Mic insert allows balanced PHONO connection of external processor for stereo loop.
- Digital Signal Processor effects are assignable from either music or mic input.

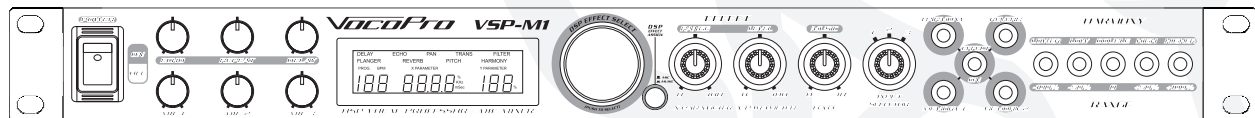

## VSP-M1

Multi-Effect Digital Signal Processor/Mixer

o w n e r ' s m a n u a l

## Table of Contents

Listening for a Lifetime .....	3
Safety Instructions .....	4
Welcome.....	5
Front Panel.....	6-8
Rear Panel .....	9
Getting Connected .....	10
Troubleshooting.....	11
Specifications.....	12



***VocoPro***

ULTIMATE CHOICE OF KARAOKE ENTERTAINMENT

# Listening For A Lifetime

---

Selecting fine audio equipment such as the unit you've just purchased is only the start of your musical enjoyment. Now it's time to consider how you can maximize the fun and excitement your equipment offers. VocoPro and the Electronic Industries Association's Consumer Electronics Group want you to get the most out of your equipment by playing it at a safe level. One that lets the sound come through loud and clear without annoying blaring or distortion and, most importantly, without affecting your sensitive hearing.

Sound can be deceiving. Over time your hearing "comfort level" adapts to a higher volume of sound. So what sounds "normal" can actually be loud and harmful to your hearing. Guard against this by setting your equipment at a safe level BEFORE your hearing adapts.

To establish a safe level:

- Start your volume control at a low setting.
- Slowly increase the sound until you can hear it comfortably and clearly, and without distortion.

Once you have established a comfortable sound level:

- Set the dial and leave it there.
- Pay attention to the different levels in various recordings.

Taking a minute to do this now will help to prevent hearing damage or loss in the future. After all, we want you listening for a lifetime.

Used wisely, your new sound equipment will provide a lifetime of fun and enjoyment. Since hearing damage from loud noise is often undetectable until it is too late, this manufacturer and the Electronic Industries Association's Consumer Electronics Group recommend you avoid prolonged exposure to excessive noise. This list of sound levels is included for your protection.

## **Some common decibel ranges:**

Level	Example
<b>30</b>	Quiet library, Soft whispers
<b>40</b>	Living room, Refrigerator, Bedroom away from traffic
<b>50</b>	Light traffic, Normal Conversation
<b>60</b>	Air Conditioner at 20 ft., Sewing machine
<b>70</b>	Vacuum cleaner, Hair dryer, Noisy Restaurant
<b>80</b>	Average city traffic, Garbage disposals, Alarm clock at 2 ft.

## **The following noises can be dangerous under constant exposure:**

Level	Example
<b>90</b>	Subway, Motorcycle, Truck traffic, Lawn Mower
<b>100</b>	Garbage truck, Chainsaw, Pneumatics drill
<b>120</b>	Rock band concert in front of speakers
<b>140</b>	Gunshot blast, Jet plane
<b>180</b>	Rocket launching pad

# Safety Instructions



**CAUTION**  
RISK OF SHOCK



CAUTION: To reduce the risk of electric shock, do not remove cover (or back). No user-serviceable parts inside. Only refer servicing to qualified service personnel.

## Explanation of Graphical Symbols



The lightning flash & arrowhead symbol, within an equilateral triangle, is intended to alert you to the presence of danger.



The exclamation point within an equilateral triangle is intended to alert you to the presence of important operating and servicing instructions.

**WARNING**

To reduce the risk of fire or electric shock, do not expose this unit to rain or moisture.

**1. Read Instructions** - All the safety and operating instructions should be read before the appliance is operated.

**2. Retain Instructions** - The safety and operating instructions should be retained for future reference.

**3. Heed Warnings** - All warnings on the appliance and in the operating instructions should be adhered to.

**4. Follow Instructions** - All operating and use instructions should be followed.

**5. Attachments** - Do not use attachments not recommended by the product manufacturer as they may cause hazards.

**6. Water and Moisture** - Do not use this unit near water. For example, near a bathtub or in a wet basement and the like.

**7. Carts and Stands** - The appliance should be used only with a cart or stand that is recommended by the manufacturer.

**7 A.** An appliance and cart combination should be moved with care. Quick stops, excessive force, and uneven surfaces may cause an overturn.



**8. Ventilation** - The appliance should be situated so its location does not interfere with its proper ventilation. For example, the appliance should not be situated on a bed, sofa, rug, or similar surface that may block the ventilation slots.

**9. Heat** - The appliance should be situated away from heat sources such as radiators, heat registers, stoves, or other appliances (including amplifiers) that produce heat.

**10. Power Sources** - The appliance should be connected to a power supply only of the type described in the operating instructions or as marked on the appliance.

**11. Grounding or Polarization** – Precautions should be taken so that the grounding or polarization means of an appliance is not defeated.

**12. Power-Cord Protection** – Power-supply cords should be routed so that they are not likely to be walked on or pinched by items placed upon or against them, paying particular attention to cords at plugs, convenience receptacles, and the point where they exit from the appliance.

**13. Cleaning** – Unplug this unit from the wall outlet before cleaning. Do not use liquid cleaners or aerosol cleaners. Use a damp cloth for cleaning.

**14. Power lines** – An outdoor antenna should be located away from power lines.

**15. Nonuse Periods** – The power cord of the appliance should be unplugged from the outlet when left unused for a long period of time.

**16. Object and Liquid Entry** – Care should be taken so that objects do not fall and liquids are not spilled into the enclosure through openings.

**17. Damage Requiring Service** – The appliance should be serviced by qualified service personnel when:

- A. The power supply cord or plug has been damaged; or
- B. Objects have fallen into the appliance; or
- C. The appliance has been exposed to rain; or
- D. The appliance does not appear to operate normally or exhibits a marked change in performance; or
- E. The appliance has been dropped, or the enclosure damaged.

**18. Servicing** – The user should not attempt to service the appliance beyond that described in the operating instructions. All other servicing should be referred to qualified service personnel.

### Note:

To CATV system installers (U.S.A.): This reminder is provided to call the CATV system installers attention to Article 820-40 of the NEC that provides guidelines for proper grounding and, in particular, specifies that the cable ground shall be connected as close to the point of cable entry as practical.



**Welcome....**



And Thank you for purchasing the PIANO-5 from VocoPro, your ultimate choice in Karaoke entertainment! With years of experience in the music entertainment business, VocoPro is a leading manufacturer of Karaoke equipment, and has been providing patrons of bars, churches, schools, clubs and individual consumers the opportunity to sound like a star with full-scale club models, in-home systems and mobile units. All our products offer solid performance and sound reliability, and to further strengthen our commitment to customer satisfaction, we have customer service and technical support professionals ready to assist you with your needs. We have provided some contact information for you below.

**VocoPro**  
1728 Curtiss Court  
La Verne, CA 91750  
**Toll Free: 800-678-5348**  
TEL: 909-593-8893  
FAX: 909-593-8890

**VocoPro Company Email Directory**

**Customer Service & General Information**  
info@vocopro.com

**Tech Support**  
techsupport@vocopro.com

**Remember Our Website**

Be sure to visit the VocoPro website [www.vocopro.com](http://www.vocopro.com) for the latest information on new products, packages and promo s. And while you re there don t forget to check out our Club VocoPro for Karaoke news and events, chat rooms, club directories and even a Service directory!

We look forward to hearing you sound like a PRO, with VocoPro, your ultimate choice in Karaoke entertainment.

**FOR YOUR RECORDS**

Please record the model number and serial number below, for easy reference, in case of loss or theft. These numbers are located on the rear panel of the unit. Space is also provided for other relevant information

**Model Number** \_\_\_\_\_

**Serial Number** \_\_\_\_\_

**Date of Purchase** \_\_\_\_\_

**Place of Purchase** \_\_\_\_\_

# Front Panel Descriptions

## Front Panel

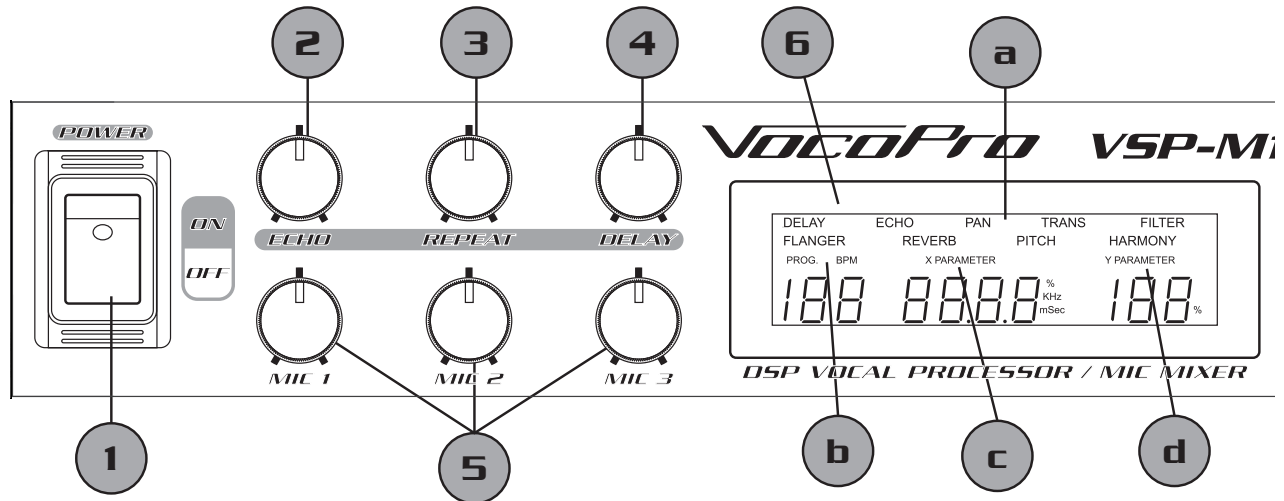

1. **POWER** - In the upper position, this switch turns the VSP-M1 ON, lower position OFF.
2. **ECHO** - This controls the level of the ECHO effect for only MIC 1, 2 and 3, and not other input sources. MIC 3 is the only input where the ECHO can be bypassed entirely, so if you don't want an equal amount of the effect applied to MIC 1 and 2 (also 3 while that input has its ECHO set ON), turn the ECHO control hard left. ECHO output is then at zero.
3. **REPEAT** - This sets the number of ECHO repeats before MIC ECHO decays for MIC 1, 2 and 3.
4. **DELAY** - This control sets the DELAY time in between ECHO repetitions.
5. **MIC 1, 2, and 3 LEVEL** - These knobs adjust the individual MIC levels.
6. **LCD DISPLAY** - This display window indicates:
  - a. Which effect is being applied to source; ECHO, PAN, TRANS, FILTER, FLANGER, REVERB, PITCH or HARMONY
  - b. BEATS PER MINUTE (BPM). When an external music source is input to the VSP-M1, the counter will automatically display the BPM for each track. Since the VSP-M1 has a BPM Auto Synchronization feature, it will automatically cue the effects to align with the rhythm of the music.
  - c. X PARAMETER. The RANGE of each effect is shown here in either a percentage or in milliseconds.
  - d. Y PARAMETER. The LEVEL of each effect is shown here in a percentage from 0 to 100%.

## Front Panel Descriptions (CONTINUED)

### Front Panel

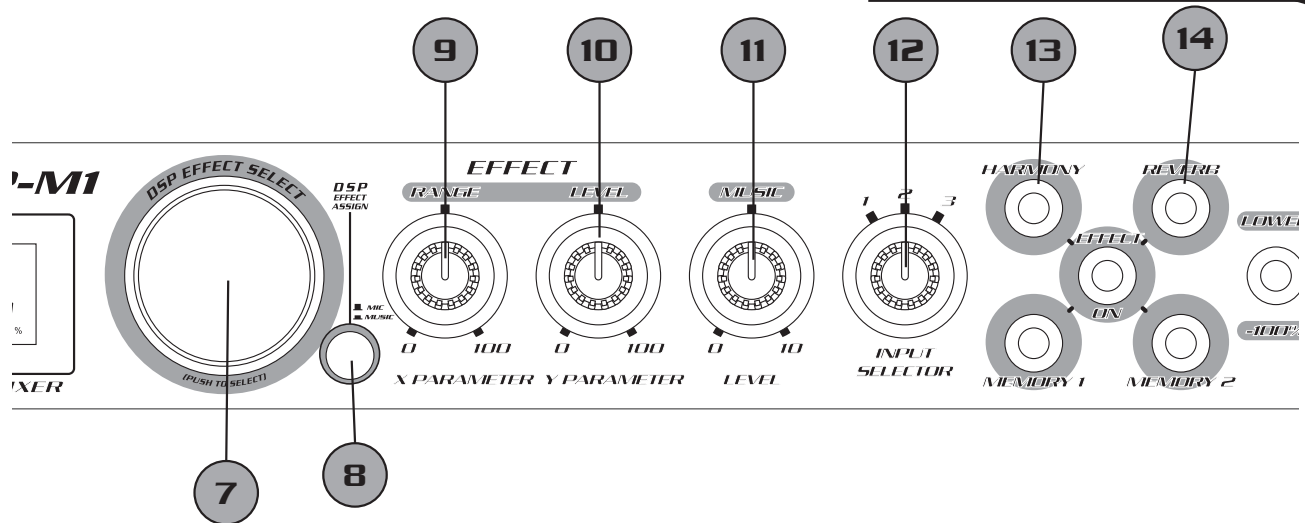

7. **DSP EFFECT SELECT** - Turn this dial to scroll through ECHO, PAN, TRANS, FILTER, FLANGER, REVERB, PITCH or HARMONY and push dial to select one of these effects to apply to an input
8. **DSP EFFECT ASSIGN** - Push in to apply EFFECT to source music input, and release the button to the extended position to apply EFFECT to a MIC input.
9. **X PARAMETER/ EFFECT RANGE** - Used to adjust the time parameter of digital effects in either a percentage or in milliseconds.
10. **Y PARAMETER/ EFFECT LEVEL** - Used to adjust the LEVEL parameter of digital effects in a percentage from 0 to 100%.
11. **MUSIC LEVEL** - Raises or lowers to overall output of source music from INPUT 1, 2 or 3.
12. **INPUT SELECTOR** - Correlates to AUDIO IN 1, 2 and 3. Switch this dial to whichever music source you want to apply effects to.
13. **HARMONY** - For instant access to the HARMONY effect, press this button and the LED will change from red to green to indicate that the effect has been switched ON. The default HARMONY setting is the HIGHER/+100% octave.
14. **REVERB** - For instant access to the REVERB effect, press this button and the LED will change from red to green to indicate that the effect has been switched ON. Default X PARAMETER is 50% and Y PARAMETER is 20%.

## Front Panel Descriptions (CONTINUED)

15. **MEMORY 1** - Use this button if you want to save your parameters preferences for one of the effects. With the effect desired selected, set your X and Y PARAMETER preferences and hold the MEMORY 1 button until the red LED flashes. The preferences have been saved. Now when you need to make a quick selection of this effect with these parameters, press MEMORY 1 for instant access rather than using the DSP EFFECT dial. When an effect has been stored, pressing this button will turn the LED from red to green, indicating your saved effect has been recalled.

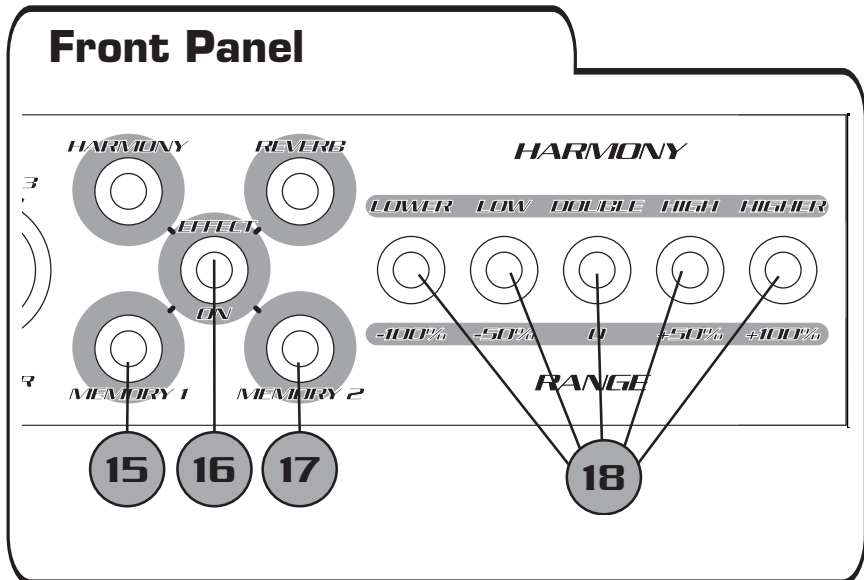

16. **EFFECT ON** - This button must be pushed, switching the red LED to green, to activate the effects.
17. **MEMORY 2** - Use this button if you want to save your parameters preferences for one of the effects. With the effect desired selected, set your X and Y PARAMETER preferences and hold the MEMORY 2 button until the red LED flashes. The preferences have been saved. Now when you need to make a quick selection of this effect with these parameters, press MEMORY 2 for instant access rather than using the DSP EFFECT dial. When an effect has been stored, pressing this button will turn the LED from red to green, indicating your saved effect has been recalled.
18. **HARMONY/RANGE** - When you press each of these buttons, the LED switches from red to green. These buttons serve a dual function:
- HARMONY** - The Vocal Harmonizer effect of the VSP-M1 allows you to add harmonizing, octaves or doubling notes to either a microphone or source music input.
    - DOUBLE/0** - As an example, if you sing a "C" note (or any other note) into the mic, and have selected the DOUBLE/0 button, a duplicate signal is produced which gives the impression there are two people singing that same note.
    - LOW/-50%** - There are two notes in a major scale that harmonize easily with the root note, the major third and major fifth. This button will take the C note from our example and match it to the 3rd of its lower octave, E in this case, to simulate backing bass vocal parts being sung.
    - LOWER/-100%** - Pressing this button adds the major fifth of the lower octave of your root note. In our example of singing a C note, this would add a G note for very "pop" sounding, or chiming, vibrant bass harmonies.
    - HIGH/+50%** - There are several different higher and lower pitch "octaves," of every musical note, and pressing this button will add the next higher octave accompanying the source.
    - HIGHER/+100%** - Press this button to get the next octave, 2 higher than the root note.
  - RANGE** - The second function of these buttons is presets or "hot keys" for REVERB and PITCH effects X PARAMETER.
    - DOUBLE/0** - With the REVERB effect, this button sets the RANGE (X PARAMETER) at 50. With PITCH, RANGE is set 0.
    - LOW/-50%** - With the REVERB effect, this button sets the RANGE (X PARAMETER) at 25. With PITCH, RANGE is set -50%.
    - LOWER/-100%** - With the REVERB effect, this button sets the RANGE (X PARAMETER) at 0. With PITCH, RANGE is -100%.
    - HIGH/+50%** - With the REVERB effect, this button sets the RANGE (X PARAMETER) at 75. With PITCH, RANGE is set at +50%.
    - HIGHER/+100%** - With the REVERB and PITCH effects, this button sets the RANGE (X PARAMETER) at 100.



# Rear Panel Descriptions

## Rear Panel

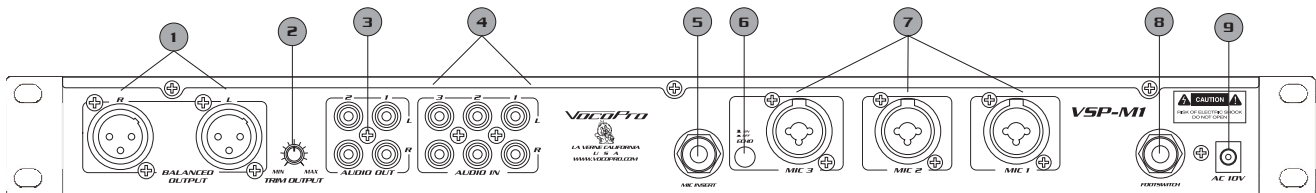

1. **BALANCED OUTPUT** - Connect your Left and Right XLR cables from the VSP-M1 to balanced inputs on your mixer, amplifier or powered mixer.
2. **TRIM OUTPUT** - The output level from the VSP-M1 can be adjusted using this control. For the best, clean sound quality, adjust TRIM until just before the signal begins to distort.
3. **AUDIO OUT** - Connect your Left and Right RCA cables from these VSP-M1 outputs to a stereo, Home entertainment system, amplifier, mixer or powered amplifier with RCA in jacks.
4. **AUDIO IN** - You can connect up to 3 music sources for input selection here, including stereos, disc players, mixers, etc.
5. **MIC INSERT** - This jack is used for connection of an outboard processor such as a compressor using only a single 1/4" TRS (Tip = send, ring = return, Sleeve = signal ground).
6. **ECHO ON/OFF** - MIC 3 is the only MIC input which allows you the ability to bypass the ECHO effect entirely rather than simply turning the ECHO level all the way to zero. Press this button in to turn the effect OFF. In the extended position, the effect is ON.
7. **MIC 1, 2 and 3 INPUTS** - These jacks accept either 1/4" microphone cables in the center of the input, or line up the 3 prongs of an XLR cable with the XLR connection around the center.
8. **FOOTSWITCH** - Connect any standard footswitch via 1/4" cable here for remote control of the VSP-M1.
9. **AC 10V ADAPTOR JACK** - Connect included power adaptor here.

# Getting Connected

## Rear Panel Suggested Connections

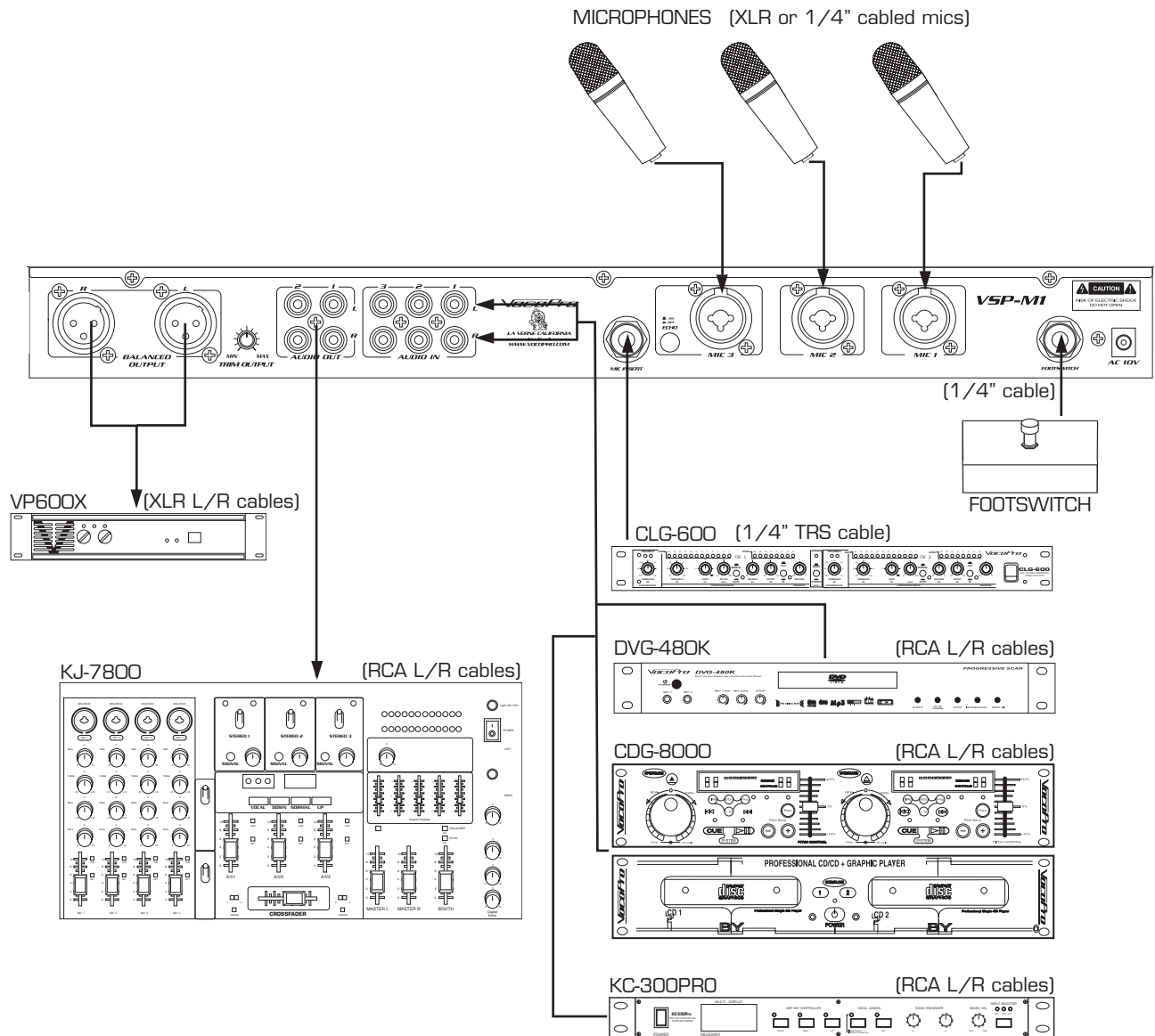

The VSP-M1 is versatile as an external component in your already existing system, with amps such as the VP600X pictured above. You can also connect directly to a power amp that takes RCA L/R inputs. Or, use it to process any signal from one of these suggested types of components and others with RCA connections. Options not shown include connecting the VSP-M1 to powered speakers such as PV420s, using the VSP-M1 as a basic mixer. If you need more Equalization control, or Key Control, try connecting to your VSP-M1 through a KJ-7800 Mixer, and out to your sound system. Another option for Key Control is to connect your player through our KC-300PROX and out from the Key Controller to the VSP-M1. See your VocoPro dealer for compatible components!

# Troubleshooting

Problems	Solutions
NO OUTPUT	Faulty cables from external components should always be checked first. Try 2 different sets of RCA cables to eliminate any possibility that cables are defective.
	Check other components for malfunction or poor connections.
	If other components are compatible, try a BALANCED OUTPUT (XLR) connection first for optimum sound quality.
	Be sure that XLR BALANCED OUTPUT cables are firmly seated in their connection jack. They should be immobile from being easily pulled out.
	Rotate all RCA cables slightly at their connection points.
	Check MUSIC Level.
	Check INPUT SELECTOR to make sure your INPUT source # matches.
	Check DSP EFFECT ASSIGN to see that it matches your MIC or MUSIC input type.
	If microphones are in use, check each microphone for malfunction and poor connection
	Check the proper MIC Level control which matches your MIC INPUT #.
EFFECT LEVEL and RANGE can also affect OUTPUT level. Adjust accordingly for best output.	
NO ECHO	Check ECHO Level on front panel.
	If your microphone is connected to MIC INPUT 3, this is the only MIC in which ECHO can be completely bypassed using the ECHO ON/OFF switch for that mic from the back panel.
	REPEAT and DELAY controls should also be adjusted to get full ECHO effect.
DISTORTION	When using BALANCED OUTPUT (XLR Left and Right), it is important to adjust the trim output to a point which delivers the cleanest Signal-to-Noise ratio. The output should have enough gain to be audible with a clear signal.
	Check microphone levels to moderate mic input to a more suitable level.
	External connections often offer Level, Volume, Gain, Equalization, Master and channel faders to set the overall output to your sound system. The key is finding a balance between all of these factors to produce the cleanest tone.
	Try different effects to reach desired tones.

# Specifications

Power Source: AC 10V, 1000mA +/-10%, 10 Watts  
Dimensions: 482 (W) x 43.7 (H) x 160 (D) mm  
Weight: 2.6 Kgs

Input/output impedance & sensitivity (FX OFF, Maximum Gain, 0dBV output, Load=100K OHM)  
Audio of AV: 20K OHM /-10dBV (316mV): +/-2dB  
Mic: 2K OHM /-50dBV (3.16mV): +/-2dB  
Unbalanced output: 1K OHM / 0dB  
Balanced output: 600 OHM / 4dBm (1.23V) +/-2dB

Frequency response (Maximum Gain, 0dBV output, Load=100K OHM)  
Audio of AV: 20 - 20K Hz +/-1dB (FX OFF)  
20 - 20K Hz +/-1.5dB (FX ON,DRY)  
Mic: 20 - 20K Hz +/-3dB (FX OFF)

THD + N (Maximum Gain, 0dB output, w/20KHz LPF, Load=100K OHM)  
Audio of AV: Less than 0.008% at 20-20KHz (FX OFF)  
Less than 0.03% at 1KHz (FX ON,DRY)  
Mic: Less than 0.04% at 20-20KHz (FX OFF)

Maximum input (Output THD=1%, Maximum Gain, Load=100K OHM)  
Audio of AV: More than +4dBV (FX OFF)  
More than +3dBV (FX ON,DRY)  
Mic: More than -39dBV (FX OFF)

Maximum output (EQ flat, maximum gain, Fx off, THD=1%, load=100K OHM)  
Unbalanced output: More than +12dBV (4.0V)  
Balanced output: More than +14dBm (4.0V)

Output noise (Maximum Gain, w/20KHz LPF, A-Weighted)  
Audio of AV: Less than -95dBV (FX OFF)  
Less than -82dBV (FX ON,DRY)

L/R Crosstalk (Maximum Gain, 1KHz, 0dBV output, w/20KHz LPF)  
Audio of AV: More than 75dB (FX OFF)  
More than 65dB (FX ON,DRY)

Channel Balance: Within 3dB

# **VocoPro**

ULTIMATE CHOICE OF KARAOKE ENTERTAINMENT



© Vocopro 2004  
V 1.0

[WWW.VOCOPRO.COM](http://WWW.VOCOPRO.COM)