

Soundcraft

SPIRIT

STUDIO

USERS GUIDE

SPIRIT STUDIO

SPIRIT

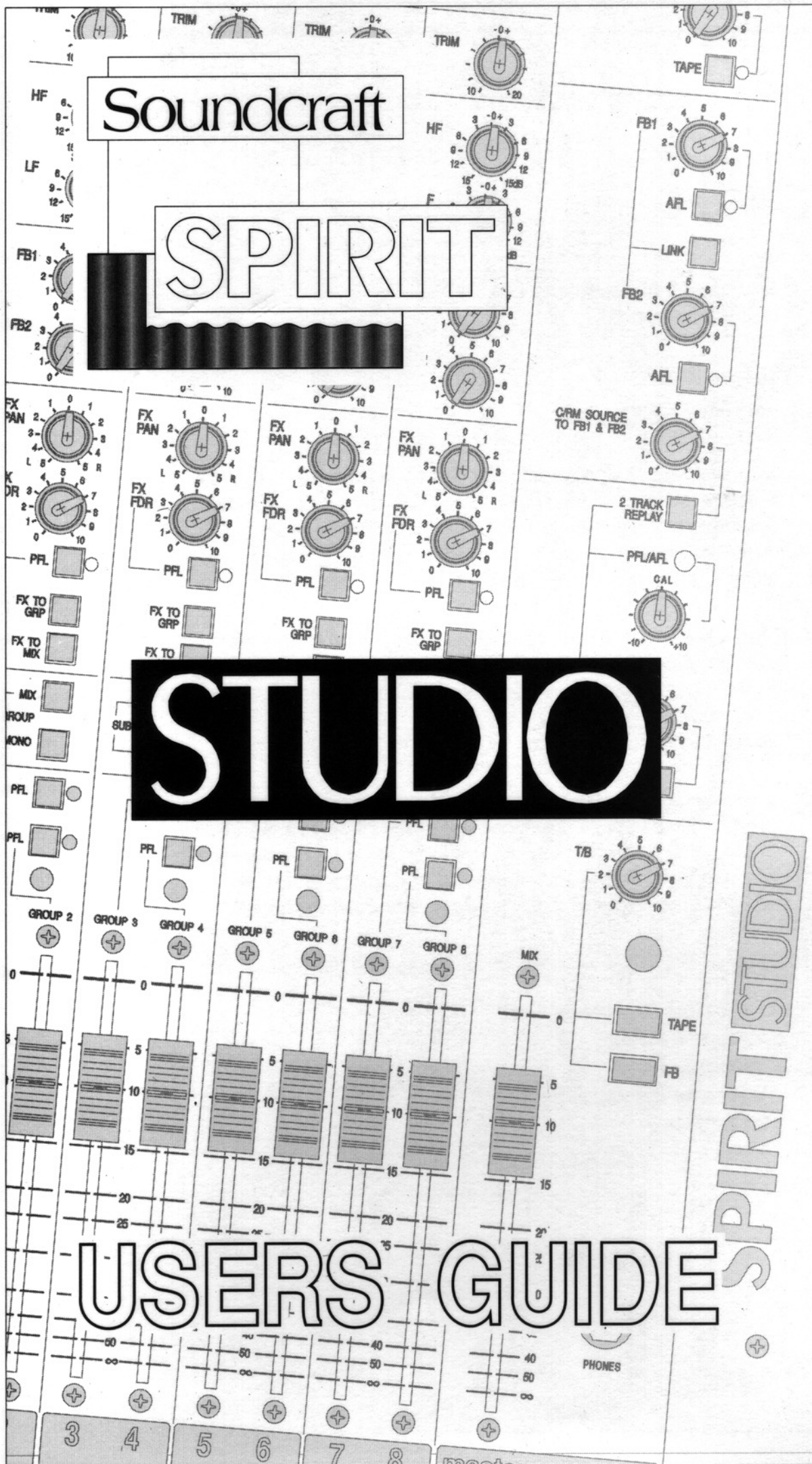

© Soundcraft Electronics Ltd. 1990  
All rights reserved

Issue 1 (first draft)  
Part No. ZZ2686

Information in this manual is subject to change without notice and does not represent a commitment on the part of the vendor. Soundcraft Electronics Ltd. shall not be liable for any loss or damage whatsoever arising from the use of information or any error contained in this manual.

No part of this manual may be reproduced, stored in a retrieval system, or transmitted, in any form or by any means, electronic, electrical, mechanical, optical, chemical, including photocopying and recording, for any purpose without the express written permission of Soundcraft Electronics Ltd.

It is recommended that all maintenance and service on the product should be carried out by Soundcraft Electronics Ltd. or its authorised agents. Soundcraft Electronics Ltd. cannot accept any liability whatsoever for any loss or damage caused by service, maintenance or repair by unauthorised personnel.

Soundcraft Electronics Ltd.  
Unit 2  
Borehamwood Ind Park  
Rowley Lane  
Borehamwood  
Herts.  
WD6 5PZ  
England

## User Guide

Contents
----------

Introduction . . . . .	2
Basic Principles of Multitrack Recording . . . . .	4
Getting Started . . . . .	6
Connections and Connectors . . . . .	6
Fault Finding Guide . . . . .	9
Getting to know your console . . . . .	10
Facilities . . . . .	10
Input - Channel Path . . . . .	10
Input - Monitor Path . . . . .	15
Group Section . . . . .	16
Master Section . . . . .	18
Using your SPIRIT STUDIO Console . . . . .	21
Initial Set Up . . . . .	21
Applications . . . . .	24
Recording . . . . .	24
Playback/Mix-Down . . . . .	25
Overdubbing . . . . .	26
Live P.A. . . . .	27
Care of your mixer . . . . .	28
Glossary . . . . .	28
Selectable Options . . . . .	30
Specifications . . . . .	31
Front Panel Layout . . . . .	fold out rear cover
Block Diagram . . . . .	inside rear cover

## INTRODUCTION

Congratulations on your purchase of a SPIRIT STUDIO mixer. Owning a Soundcraft console brings you the expertise and support of one of the industry's leading manufacturers and the results of over 17 years experience supporting some of the biggest names in the business. Packed full of features for track-laying, mixdown and overdubbing SPIRIT STUDIO provides you with access to the full range of professional multitrack techniques from an unusually compact mixer.

Designed by engineers who understand the individual needs of musicians, SPIRIT STUDIO has been built to the highest standards using quality Japanese components and employing automated assembly techniques beyond the reach of most manufacturers of compact mixers.

A rugged steel chassis is combined with moulded side trims to give protection and distinctive appearance. Custom-moulded controls, designed for the best 'feel' and visual clarity complement the styling, resulting in a truly professional product which is ideal for all types of multitrack recording from 8-track all the way up to 24-track.

An in-line console available in two frame sizes (16/8/2 and 24/8/2) there is no shortage of inputs on SPIRIT STUDIO, since in mixdown mode the multitrack monitor inputs double as extra line inputs.

The input channels are able to accept a wide range of Microphone and Line level signals from separate input sockets. Every channel features a separate Channel and Tape Monitor section, with unique flexibility to swap functions between the two paths. The 4-band EQ is in two sections - normally the HL/LF section is before the insert point and the LOW MID and HI MID after the insert point, thus allowing separate EQ of Send and Return. If EQ to Monitor switch is pressed the HF/LF EQ is switched into the Monitor path leaving the LOW MID and HI MID section after the Insert point in the

Channel path. The Auxiliary Sends are similarly split to give 1 Foldback and 2 Auxiliary sends in both the Channel and Monitor paths, or all four Auxiliary sends may be assigned to the Channel path.

The Monitor fader is normally a rotary control, but an INPUT REVERSE switch swaps Channel and Monitor inputs, allowing the tape return signal to be brought down the full facilities of the Channel path and mixed on the long throw channel fader. The Channel PAN control drives a matrix of routing switches to feed the signal to 8 Groups in stereo pairs, plus the Stereo mix.

The Group masters are arranged as pairs, and the outputs are normalised to the respective Tape Sends on the input channels in blocks of eight unless the Channel DIRECT switches are pressed. The Group output is also available on a separate jack socket for use as an extra send during mixdown. Groups may be routed as odd and even pairs to the Stereo mix, or as combined MONO feeds. Each group has a 16-segment LED bargraph meter.

Above the Group masters are 4 Stereo Effects Returns, with balanced inputs, 2-band shelving EQ and feeds to the two Foldback busses, the Stereo mix or summed to the local Groups in stereo.

The Master section comprises the control room monitoring facilities, Oscillator with two fixed frequencies, Talkback and Stereo mix and AFL/PFL metering.

A full description of all facilities in 'Getting to know your console' can be found on page 10.

SPIRIT STUDIO is designed to be as user-friendly as possible, but a few minutes spent reading through this manual will help you become familiar with the product away from the pressure of a recording session, and allow you to gain full benefit from the superb performance offered by your new mixer.

Above all, remember that your SPIRIT mixer is designed to extend your creativity. The more you explore the controls and the effect they have on the sound output, the more you will appreciate how you can influence and enhance the final sound, both by careful and creative balancing of channels and the use of

## BASIC PRINCIPLES OF RECORDING

---

### The Mixer

As one would expect, the main purpose of the mixer is to combine sounds, but under precise and smooth control. This is why long-throw faders are essential on any professional product. The faders provide you with total control of the final sound at your finger tips and like an artist playing an instrument you should listen to your fader movements, not look at your hands.

Your SPIRIT STUDIO mixer accepts a wide range of input signals via a microphone input, for very low level signals, or a line input, for higher level signals from, for instance, tape machines, effects processors, etc.

The mixer is split into two sections. The Inputs receive, match and process individual source signals, and distributes them at precise mix levels to a choice of outputs. The Master and Group sections allow overall level control of all outputs, and provides monitoring of the audio signal at many points in the mixer, either on headphones or meters.

The Equaliser controls are the most flexible and potentially destructive feature of the mixer. They have a similar effect on the frequency response of the input channel as the tone controls on a hi-fi system, but with much greater precision, and allow particular characteristics of the input signal to be emphasised or reduced. It is very important that you become familiar with the effect each control has on the sound and this is best achieved by spending time listening to the effect of each control on a well-known track played through the mixer.

The Auxiliary Sends provide a way of routing the input signals to a number of secondary outputs, for artists foldback, echo units or additional speaker outputs.

The Pan control adjusts the position of the input signal within the stereo mix, and can be swept from full left, through to full right. This allows particular artists to retain their correct spatial position within the mix, particularly important for stereo recording.

Pre-Fade-Listen(PFL) allows you to monitor the signal at many points in the mixer. Pressing any PFL switch places the signal at that particular point onto the control room outputs (or headphones if plugged in) and the

right meter. This allows the engineer to check the quality of the signal or to pin-point problems. Using PFL will not affect the signals on the Left and Right Mix outputs.

Each input channel and the Group and Mix outputs have an Insert 'A' gauge jack socket, which is a break point in the signal path. It allows the signal to be taken out of the mixer, through an external piece of equipment and then back into the mixer directly after its original exit point. The Insert point is normally bypassed by the 'A' gauge jack socket contacts, and is only brought into operation when a plug is inserted. Typical uses would include Effects Processors, Limiters or additional Equalisers.

The terms PRE and POST are often used in the context of Inserts, Equalisers and Auxiliary Sends, and describe whether that facility is placed before (Pre) or after (Post) another particular section. This is explained further in the detailed description of facilities.

A mixer is often judged, amongst other factors, by the amount of Headroom available. This is a measure of the reserve available to cope with sudden peaks in the input signal, without distortion caused by Clipping, when the signal becomes so high that it would exceed the power supply rail voltages and is as a result limited. This commonly occurs where gain settings are incor-

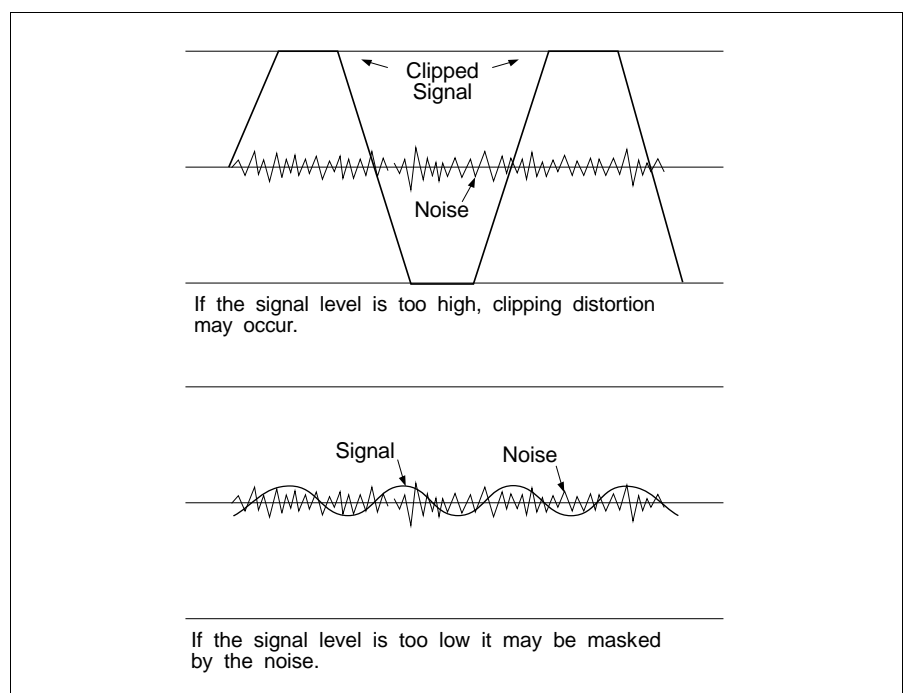

rectly set or where sources are improperly matched to the mixer input. If the source signal is too high, clipping and distortion results. If the signal is too low it becomes masked by the background noise which is present to some degree in all mixers. The diagram below illustrates this point.

It is during recording that the greatest demands are made on a mixer in terms of transparency and audio quality. While a stereo recording will often be made direct to the master tape machine, multitrack machines provide greater flexibility by allowing the recording to be done in three stages. The first stage is Tracking in which individual voices or instruments, or groups of instruments are recorded as cleanly as possible on selected tracks on the multitrack machine. The second

---

## GETTING STARTED

### CONNECTIONS AND CONNECTORS

Although this may seem a simple subject, faulty connectors and cabling are the source of most sound system problems. Correctly-made cables of the proper type, with the right connectors for the job will ensure peak performance from your system with minimum noise pick-up. The following section will help you to connect SPIRIT STUDIO mixer correctly.

Two different types of audio connectors are used, 3-pin XLR and 1/4" three pole ('A' gauge) jacks. These are

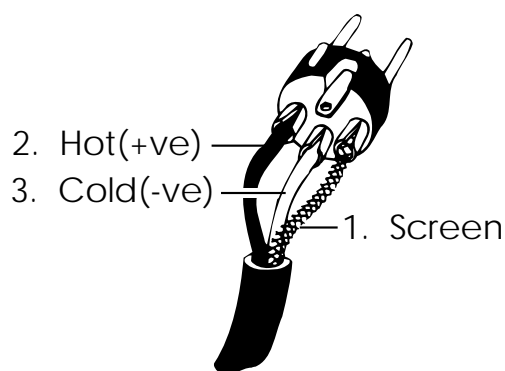

Balanced  
Input



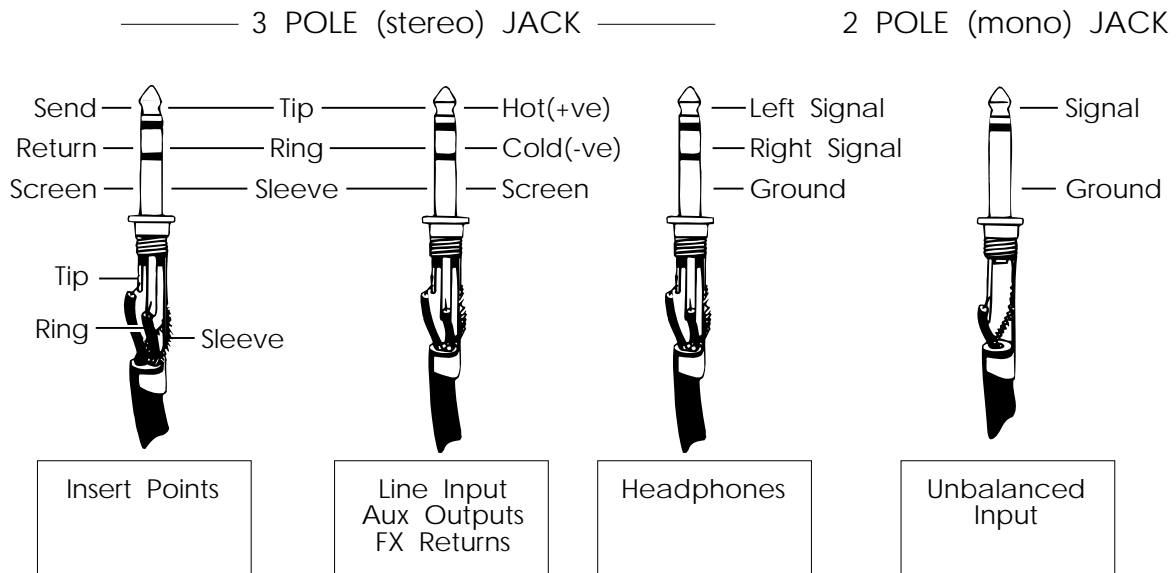

used in several configurations as shown in the diagrams below.

## Balanced and Unbalanced

All channel inputs are balanced, i.e. there are separate +ve(hot) and -ve (cold) wires for each signal plus a ground. The design of the differential input amplifiers is such that interference picked up on these wires is cancelled out. This is because, since both wires are in close proximity, the same interference will be picked up on each wire and balanced input amplifiers will only amplify the difference between +ve(hot) and -ve(cold). Any signal on both hot and cold (i.e. noise) will not be amplified - this is known as common mode rejection (CMR.). If using an unbalanced source into a balanced input, it is a good idea to connect the source ground to the negative input. Should the source device have no connection to mains ground, then connect the shield at both ends. If there is a connection to mains ground, then the shield should only be connected to the source device ground.

Note: many modern audio/musical instruments have electronically balanced outputs which should not be unbalanced by shorting one wire to ground. Always use your inputs balanced where possible.

The mix, group and auxiliary outputs are ground compensated and provide a very effective way of optimising noise immunity, without the cost and complexity of balanced outputs. These outputs employ ground compensation techniques to cancel out the effects of variation in ground potential between the mixer

and other equipment which would otherwise show up as hum. If the output is driving a device or amplifier that has an unbalanced input, connect the -ve(cold) signal to the ground at the destination, not at the output of your SPIRIT STUDIO console.

## Polarity

You will probably be familiar with the concept of polarity in electrical signals and this is of particular importance to balanced audio signals. Just as a balanced signal is highly effective at cancelling out unwanted interference, so two microphones picking up the same signal can cancel out, or cause serious degradation of the signal if one of the cables has the +ve and -ve wires reversed. This phase reversal can be a real problem when microphones are close together and you should therefore take care always to connect pins correctly when wiring audio cables.

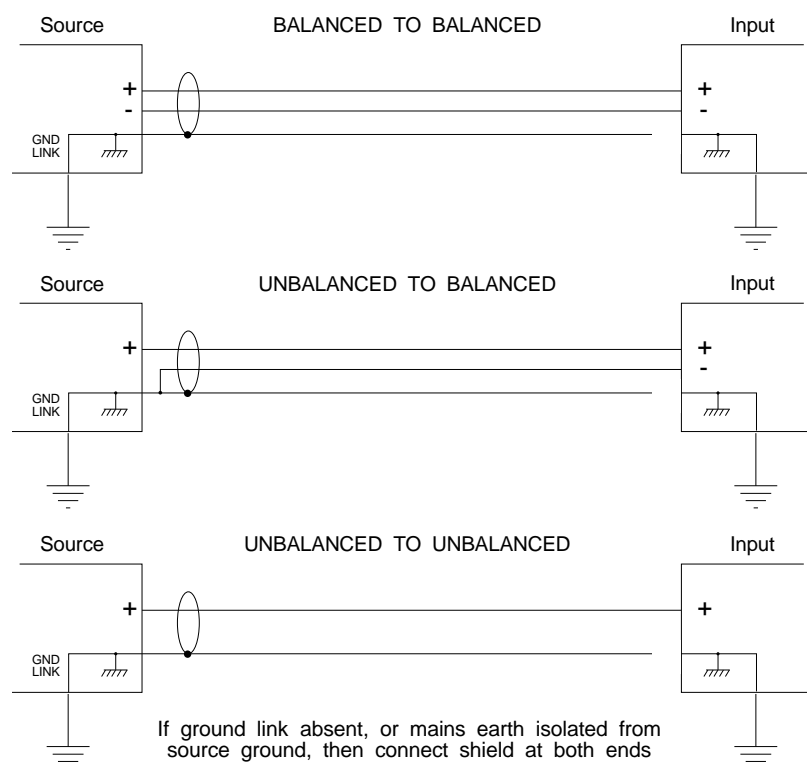

## Grounding and Shielding

For optimum performance it is vital that all signals are referenced to a solid, noise-free earthing point and that all signal cables have their screens connected to ground. To avoid earth 'loops', use balanced connections where possible and ensure that all cable screens and other signal earths are connected to ground only at their source and not at both ends.

Avoid running audio cables or placing audio equipment, close to thyristor dimmer units or power cables.

Noise immunity is improved significantly by the use of low impedance sources, such as good quality professional microphones or the outputs from most modern audio equipment. Avoid cheaper high impedance microphones, which may suffer from interference over long cable runs, even with well-made cables.

---

## Fault Finding Guide

Repairing a sound mixing console requires specialist skills, but basic Fault Finding is within the scope of any user if a few basic rules are followed.

- Get to know the Block Diagram of your console (see inside rear cover)
- Get to know what each component in the system is supposed to do.
- Learn where to look for common trouble spots.

The Block Diagram is a representative sketch of all the components of the console, showing how they connect together and how the signal flows through the system. Once you have become familiar with the various component blocks you will find the Block Diagram quite easy to follow and you will have gained a valuable understanding of the internal structure of the console.

Each Component has a specific function and only by getting to know what each part is supposed to do will you be able to tell if there is a genuine fault! Many 'faults' are the result of incorrect connection or control settings which may have been overlooked.

Basic Troubleshooting is a process of applying logical thought to the signal path through the console and tracking down the problem by elimination.

- Swap input connections to check that the source is really present. Check both Mic and Line inputs.
- Eliminate sections of the channel by using the insert point to re-route the signal to other inputs that are known to be working.

## GETTING TO KNOW YOUR CONSOLE

---

### FACILITIES

Refer to the fold-out front panel diagram at the rear of this manual, which shows the control functions on the SPIRIT STUDIO. Each facility is described below, and is identified by a reference number.

## INPUT - CHANNEL PATH

---

### 1. MICROPHONE INPUT

The Microphone input is via a standard female XLR-3 connector and is available when the LINE switch is released. It is designed to accept a wide range of balanced or unbalanced low impedance input signals.

---

### 2. +48V PHANTOM POWER

Each microphone input can provide the +48V necessary for phantom-powered mics and this may be turned on or off with the +48V switch.

NOTE: The microphone should always be plugged in before switching the +48V on or off. Also you should be aware that some microphones draw an unusually large current which may overload the power supply, resulting in distortion. Consult your microphone supplier for guidance if necessary.

Transformer-coupled dynamic microphones may be used without causing damage, even when the +48V power is connected, but care must be taken when using unbalanced sources, because of the voltage present on pins 2 and 3 of the XLR connector.

---

### 3. INSERT

The INSERT is a break point in the input channel signal path. It allows the signal to be taken out of the mixer, through an external piece of equipment and then back into the mixer to continue through to the final output. The Insert is a 3-pole 1/4" 'A' gauge Jack Socket, which is normally by-passed. When a jack plug is inserted, the signal path is broken at a point just before the MID-EQ section. When the HF/LF EQ is switched into the

channel path (see section 9) the insert is after that section, allowing equalisation of both the insert send and return. The signal from the channel appears on the TIP of the plug and is returned on the RING. The insert point allows limiters, compressors and other signal processing units to be added as required to particular input channels.

---

4. LINE INPUT

The LINE Input is a 1/4" 3 pole 'A' gauge jack socket, to accept balanced or unbalanced line level sources when the LINE switch(5) is pressed. Unlike the low impedance Microphone input, this stage presents a high impedance(>10kΩ) to the input signal, enabling many types of instruments to be plugged straight in without D.I. boxes or external preamplifiers.

Line inputs will be useful as extra Effects Returns, where additional post-effect equalisation is required.

---

5. LINE SELECT

The LINE switch selects Line input when pressed, and Microphone input when released. When Line is selected the Gain range is reduced by 20dB(see 6 below).

---

6. GAIN CONTROL

When the Microphone input is selected this control acts as a SENSITIVITY control covering a 50dB range. Channel signal level increases as the control is turned clockwise. When the Line input is selected it serves as a GAIN control, with the scaling reduced by -20dB from the printed scale. There is a line-up mark at the Line input unity gain point. Some audio equipment, particularly that intended for domestic use, operates at a nominal -10dBV level and an increased Gain setting will be required.

---

7. CHANNEL/MONITOR INPUT REVERSE

Normally the input to the Channel is the Mic/Line source, while the input to the Monitor path is the tape return. The CHANMNTR INPUT REV switch swaps over these inputs, allowing the tape return signal to be brought down the full facilities of the Channel path dur-

ing mix-down using the long-throw channel fader. This frees the Monitor path to serve as an extra input. Note that the equalisation section and auxiliary sends are both split to serve both signal paths.

---

8. DIRECT

The DIRECT switch replaces the feed to the tape send jack socket (which is normalled to the Group output) with the channel post-fade signal. This allows direct recording to a tape track from the channel, under the control of the main channel fader. Note that the Tape Send is factory-set to give a -10dBV output, even though the Group output socket is +4dBu. To change the Tape Send level to +4dBu see Selectable Options on Page 32)

---

9. HF/LF EQUALISER

The Equaliser(EQ) is configured as two separate sec-

Frequency Response Curves of the Equaliser

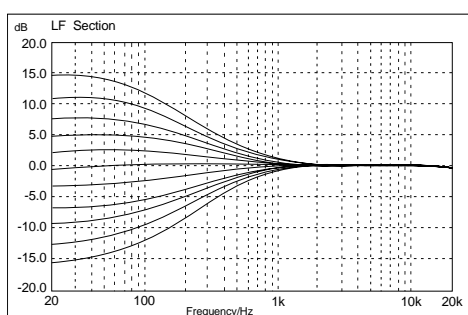
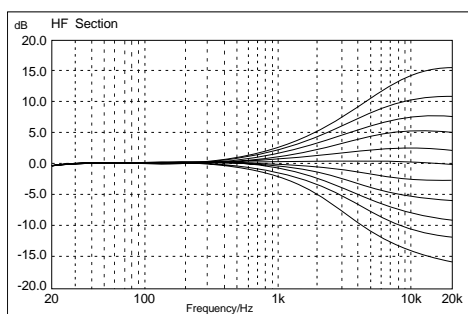

tions, to allow both the Channel and Monitor paths to be provided with a useful range of equalisation simultaneously. The HF/LF EQ is usually in the Channel path, unless the EQ to MNTR switch (10) is pressed. HF and LF are shelving controls, providing a 15dB boost or cut.

---

## 10. EQ TO MONITOR

As mentioned above, the HF/LF EQ section is usually in the Channel path. Pressing EQ TO MNTR switches these controls to the Monitor path, while leaving the HIGH MID and LOW MID controls in the Channel path.

---

## 11. HIGH AND LOW MID SWEEP EQ

The HMID and LMID EQ controls are usually in the Channel path, and by careful choice of frequency limits provide a comprehensive range of equalisation. The two pairs of knobs are arranged as a CUT/BOOST control (lower knob) of +/-15dB and a SWEEP (frequency)

Frequency Response Curves of the Equaliser

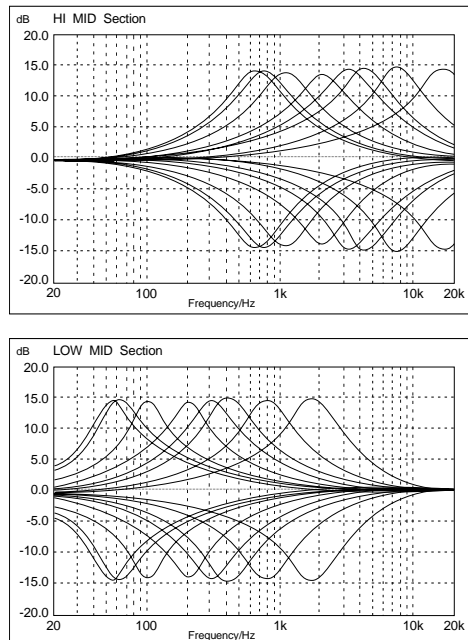

control which determines at which frequency the boost/cut action will be centred. The HMID control covers a range from 500Hz to 16kHz, and the LMID control covers a range from 50Hz to 1.6kHz.

Note that when the CHANMNTR INPUT REV switch (7) is pressed this section, along with the rest of the Channel path controls, are fed by the Tape Return signal.

---

## 12. AUXILIARY SENDS

These controls route the input channel signal to any one or more Auxiliary busses. These are separate

from the main outputs and can therefore provide additional outputs for foldback or external processing units.

The six Auxiliary busses are arranged in two sections of three, with each section comprising a pre-fade Fold-back (FB) send and two post-fade, post-cut switch auxiliary sends. Normally FB1 and AUX 1 & 2 are in the Channel path, while FB2 and AUX 3 & 4 are in the Monitor path.

---

13. CHANNEL PAN

The Pan control determines the position of the Channel signal within the stereo image. Rotation fully anticlockwise feeds the signal solely to the Left mix buss and odd-numbered Groups, while rotation clockwise sweeps the image to the Right and even-numbered Groups.

---

14. CHANNEL PFL/PEAK LED

When the PFL switch is pressed, the Pre-Fade signal is fed to the Control Room and headphones outputs, where it replaces the selected source. The PFL/AFL LED on the master section illuminates to warn that the monitor and the meters are now responding to the PFL/AFL selection and the PFL LED on the input channel lights to identify the active channel. This is a useful way of listening to any required input signal without interrupting the main mix, so that adjustments can be made or problems traced.

When the PFL switch is released the LED on the channel serves as a PEAK indicator, to warn when an excessively high signal level is present in the channel. The signal is sampled at two points in the channel, PRE INSERT, (PRE HF/LF EQ if in the Channel path), and POST EQ. The Peak LED will illuminate approximately 4dB before clipping and therefore give warning of a possible overload even if the peaks are removed by external equipment plugged into the Insert.

---

15. CHANNEL ON

This switch routes the Channel signal to the Channel PAN control and then to the routing matrix. It is positioned post-fader to ensure minimum system noise when released, while leaving the pre-fade foldback sends enabled.



---

16. MIX & GROUPS 1-8

The input channel signal is routed to the main STEREO mix (MIX) or to the GROUPS as stereo pairs (1-2, 3-4, 5-6, 7-8) as selected by these switches.

---

17. CHANNEL FADER

This long-throw fader determines the proportion of the channel in the mix and provides a clear visual indication of channel level. Normal operating position is at the '0' mark, providing 10dB of gain above that point if required.

## INPUT - MONITOR PATH

---

18. TAPE SEND & RETURN

The TAPE SEND is normally fed from one of the 8 GROUP outputs. These are repeated across each 8 channels, e.g. Group 1 feeds Tape Sends 1,9,17 and Group 2 feeds Tape Sends 2,10,18 etc. When the DIRECT switch (8) is pressed the Tape Send receives only that channel output instead.

The electronically balanced TAPE RETURN is the normal input to the MONITOR path but is swapped to the Channel path when CHANMNTNTR INPUT REV (7) is pressed.

---

19. TAPE TRIM

This centre-detented control provides -10dB to +20dB of gain trim on the Tape Return input. Note that the centre-detented position is the line-up point for +4dBu type Tape Machines. For matching -10dBV machines the control will need to be reset to about the '3 o'clock' position.

---

20. AUXILIARY SENDS (see 12 above)

The MONITOR path normally has a pre-fade Foldback (FB2) send, and two post-fade Auxiliary sends (AUX 3,4) as described for the Channel path. AUX 3 & 4 may be switched to the Channel path by the CHAN switch if required.

---

## 21. AUXILIARIES TO CHANNEL

FB2 and AUX 3 & 4 are normally in the Monitor path. Pressing CHAN routes AUX 3 & 4 to the Channel path, while FB2 remains unaltered.

---

## 22. MONITOR PAN

The Monitor PAN control determines the position of the signal within the stereo image. Rotation fully anticlockwise feeds the signal solely to the Left mix buss, while rotation clockwise sweeps the image to the Right.

---

## 23. MONITOR FADER

This rotary control determines the overall level of the Monitor signal path. Unity gain point is at approximately 7.5 on the scale.

---

## 24. MONITOR PFL/PEAK LED

When the PFL switch is pressed, the Pre-Fade signal is fed to the Control Room and headphones outputs, where it replaces the selected source. The PFL/AFL LED on the master section illuminates to warn that the monitor and the meters are now responding to the PFL/AFL selection and the PFL LED on the input channel lights to identify the active channel.

When the PFL switch is released the LED on the channel serves as a PEAK indicator, to warn when an excessively high signal level is present in the Monitor path. The signal is sampled at two points in the Monitor path, PRE FADE (PRE HF/LF EQ if in the Monitor path). The Peak LED will illuminate approximately 4dB before clipping.

---

## 25. MONITOR ON

The Monitor path is disabled unless the ON switch is pressed - except FB2 which is always active. The switch is post-fade to minimise system noise when OFF.

GROUP SECTION
---------------

26. **GROUP FADERS**
- Long-throw master faders for each Group. Unity gain is at the top of their travel.
- 
27. **GROUP OUTPUTS**
- The output from each Group is driven by a ground-compensated amplifier and fed to standard ¼" 3 pole 'A' gauge jack sockets.
- 
28. **GROUP INSERTS**
- These allow external processing equipment to be 'inserted' into the Group signal path. The ¼" 3 pole 'A' gauge jack sockets are by-passed except when a plug is inserted.
- 
29. **PFL**
- When the PFL switch is pressed, the pre-fade Group signal is fed to the Control Room Monitors and Headphones, where it replaces the selected source. The PFL/AFL LED on the master section illuminates to warn that the monitor and the meters are now responding to the PFL/AFL selection and the PFL LED on the Group lights to identify the active Group.
- 
30. **SUBGROUP MIX/MONO**
- The MIX switch routes the Groups as odd and even pairs to the stereo Mix, or if the MNO switch is pressed the groups are fed equally to both sides of the stereo Mix.
- 
31. **BARGRAPH METERS**
- A 16-segment, three colour bargraph meter provides visual monitoring of output level for each Group. The meter is factory set to a PEAK characteristic, but may be changed internally to a VU characteristic. Please refer to the Selectable Options section (Page 31) for details.

The bargraphs may be calibrated by trimmers fitted on the edge of the PCBs and accessed via holes in the panel above each meter. Adjustments may be made using a small screwdriver, taking care not to damage

### Frequency Response Curves of the Equaliser

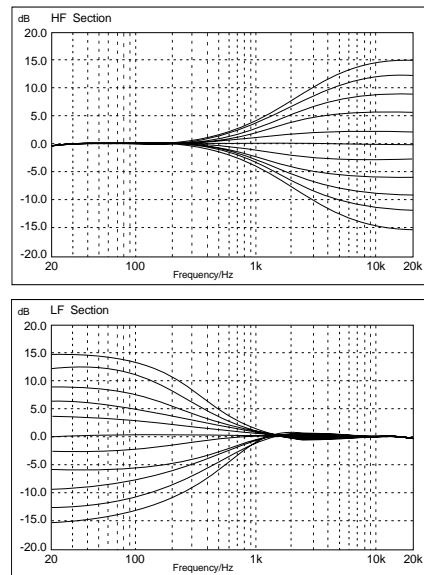

the trimmers.

---

## 32. AUXILIARY MASTER

Each of the Auxiliary Send busses is provided with a rotary master level control and an AFL switch with indicating LED which monitors the final output after the fader.

---

## 33. AUXILIARY OUTPUT

The Auxiliary Send output is driven by a ground-compensated amplifier to a standard 1/4" 3 pole 'A' gauge jack socket.

---

## 34. STEREO EFFECTS RETURN

Four Stereo Effects Returns are provided on pairs of 1/4" 3 pole 'A' gauge jack sockets, to allow external equipment to be returned to the mixer and routed to the stereo Mix or Groups, without using up valuable input channels. A mono signal may be plugged into either socket of each pair to be fed equally to left and right busses. The Effects Returns are electronically balanced.

---

## 35. TRIM

Each pair of Effects Returns has a centre-detented TRIM

---

control giving adjustment of -10dB to +20dB.

- 
36. EQUALISATION
- Each pair of Effects Returns is provided with a 2-band shelving EQ section giving +/- 15dB boost and cut.
- 
37. FOLDBACK SENDS
- Two pre-fade controls feed the Effects Return signals to FB1 and FB2 busses in mono.
- 
38. FX PAN
- The PAN control determines the contribution each Effects Return signal makes to the stereo Mix.
- 
39. FX FADER
- A stereo rotary fader provides overall master level control for the Effects Return.
- 
40. PFL
- This operates in the same way as (29) above.
- 
41. FX TO GROUP
- The Effects Return Signal may be routed in stereo to the pair of Groups immediately below it by pressing the FX to GRP switch.
- 
42. FX TO MIX
- The Effects Return signal may be routed to the stereo Mix by pressing the FX To MIX switch.

## MASTER SECTION

- 
43. MIX OUTPUTS
- The LEFT and RIGHT outputs are standard 1/4" 3 pole 'A' gauge jack sockets, driven by ground-compensated output amplifiers.

---

44. MIX INSERTS

These are similar to the Input Channel Inserts and allow external processing equipment to be 'inserted' into the output signal path. The 1/4" 3 pole 'A' gauge jack sockets are by-passed except when a plug is inserted.

---

45. BARGRAPH METERS

Two 16-segment, three colour bargraph meters provide visual monitoring of Mix L & R output levels. These are factory set to a PEAK characteristic, but may be changed internally to a VU characteristic. Please refer to the Selectable Options section (Page 31) for details.

Normally the meters display Left and Right signals. If any PFL or AFL switch is activated the left meter is turned off and the right meter displays the selected PFL or AFL signal.

The bargraphs may be calibrated by trimmers fitted on the edge of the PCBs and accessed via holes in the panel above each meter. Adjustments may be made using a small screwdriver, taking care not to damage the trimmers.

---

46. MIX MASTER FADERS

Master Faders for the Left and Right Mix outputs. Unity gain is at the top of their travel.

---

47. OSCILLATOR

The dual frequency Oscillator is simultaneously turned on and routed to the 8 Groups and the stereo Mix buses by the TAPE switch.

A second switch selects output frequency to either 1kHz (Up) or 10kHz (down). Level is determined by the rotary control.

---

48. FOLDBACK MASTER FADERS

Rotary master faders drive the FB1 and FB2 outputs via ground-compensated amplifiers. Each Foldback output has an associated AFL switch, sampling the signal after the fader.

49. LINK
- The FB1 and FB2 outputs can be linked by pressing the LINK switch, so that each output has the sum of both signals. This gives greater flexibility in deriving combined headphone feeds from the Channel and Monitor paths.
- 
50. FOLDBACK OUTPUTS
- The FB1 and FB2 outputs are driven via ground-compensated amplifiers to standard 1/4" 3 pole 'A' gauge jack sockets.
- 
51. C/RM SOURCE TO FB1 & FB2
- This rotary control feeds the selected control room source (either Mix or 2-Track Replay) directly to the FB1 and FB2 busses. This provides the operator with a very quick method of establishing a basic headphone feed, which can then be refined by the use of the FB1/FB2 sends on the input channels or groups.
- 
- 52/53. 2 TRACK REPLAY
- The source for the control room monitors is either the stereo Mix signal or an external 2-Track tape machine connected to a pair of standard 1/4" 3 pole 'A' gauge jack sockets (53). The selected signal will normally be displayed on the bargraph meters (45), unless PFL/AFL is active. This interface is factory set to suit -10dBV equipment. If a level of +4dBu is required please refer to the Selectable Options section on page 32.
- 
54. PFL/AFL TRIM & LED
- When any PFL or AFL switch is pressed the selected control room monitor source is replaced by the selected PFL or AFL signal, and the LED illuminates to show that AFL/PFL is active. The PFL/AFL signal is displayed on the Right bargraph meter and the Left meter is disabled. A rotary TRIM control provides level adjustment to allow for differences in operating levels, but AFL/PFL level will only be accurately displayed on the Right meter with the Trim control in the centre (detented) position.
- 
55. CONTROL/ROOM & PHONES LEVEL
- A rotary fader controls level to the control room outputs
-

## USING YOUR SPIRIT STUDIO CONSOLE

Your choice of a SPIRIT STUDIO console has provided you with a professional product capable of top quality recording. But good results will only come through experience and time spent understanding the facilities on your console. Recording sessions must focus on the creativity of the artists, and not be disrupted by unfamiliarity and difficulty with the operation of the console. It is important to recognise, and learn by experiment, the importance of correct choice of inputs, microphone placement and control settings.

The fold-out front panel drawing shows suitable initial control positions to get you started.

---

### INITIAL SET UP

The diagram on page 5 demonstrated how the matching of input gain to the signal source was crucial to avoid distortion at one extreme and excessive noise at the other. Set up individual input channel as follows:

- Connect the Control Room outputs to a suitable amplifier and monitor loudspeakers.
- Connect the input required (microphone, keyboard etc.)  
Note: Phantom powered mics should be connected before the +48V is switched on. Connect the Group outputs to your tape machine inputs, and the tape outputs to the tape returns on selected input channels
- Set Master and Group faders at '0' and input faders to the '0' marking.
- Provide a typical level of source signal and press the PFL button on the particular channel, monitoring the level on the right-hand meter.
- Adjust the input gain until the meter is just reaching the amber section (0dB) at a typical maximum source level. This allows sufficient headroom to accommodate peaks and establishes the maximum level for normal operation. Note that the gain may



change with alteration in EQ settings, and should be rechecked later if necessary.

- Repeat this procedure on other channels as required.

Next, the Group faders must be adjusted to give an optimum level to the tape machine.

- Route an input channel to the first pair of groups using the routing switches beside the channel fader.
- Feed the input channel with a typical maximum signal level.
- Set up the Tape Machine so that its input levels are displayed on the Track Meters.
- Adjust the Group fader to give a nominal Record Level. Refer to your Tape Machine manual for guidance if required.

Now you should set up a comfortable listening level or the Control Room Loudspeakers.

- Feed a typical maximum signal level to an input channel and press the corresponding PFL button. Adjust C/RM & PHONES Level (55) to give a maximum comfortable listening level from the loudspeakers. Release the PFL button once the adjustment is complete.

A stereo Monitor Mix can be set up using the Monitor Level and Pan controls on those channels fed by the tape machine outputs.

---

## Recording Tracks

Tape tracks may be recorded in two basic ways, and the following assumes that you have connected a suitable multitrack machine to the Tape Sends on the first few Inputs. Remember to set the appropriate tracks on the tape machine into RECORD on the required tracks,

and to return them to PLAYBACK when recording is complete. Individual input channels can be routed via the DIRECT button to feed a selected track, replacing the Group output which is normalled to the Tape Send. This provides the shortest possible signal path from input to tape.

Alternatively you may create GROUPS from a number of inputs, e.g. for a drum mix, and feed a track from the Group outputs which are normalled to the Tape Sends. A stereo Group is set up as follows:

- Decide which Channel inputs are to be mixed to form the Group, and press the appropriate Group routing button on each of those Channels.
- Adjust the level of each channel within the Group mix using the Channel fader, and the position of each channel within the Group mix using the Channel PAN.
- Adjust the overall level of the Group output using the Group fader.

---

**Microphone Placement** Careful microphone placement and the choice of a suitable type of microphone for the job is one of the essentials of successful sound recording. The aim should be to place the microphone as close as possible to the source, to cut out unwanted surrounding sounds and maintain good separation and control of the mix. Also a well-chosen and well-placed microphone should not need any appreciable equalisation.

## APPLICATIONS

SPIRIT STUDIO is designed primarily as a multitrack recording mixer, but may also be used for basic sound reinforcement. The following diagrams show typical configurations which will illustrate how the mixer is connected to other equipment.

### Example 1 - Recording

In this basic recording set-up, various sources are connected to the input channels, microphones to mic inputs and keyboards, guitars and other instruments to line inputs. A 16-track tape machine is fed from the Tape Sends on channels 1-16, with playback via the corresponding Tape Returns. The Groups 1-8 are normalled to Tracks 1-8 and 9-16 in parallel, and individual tracks can be recorded by setting the appropriate track to record on the tape machine. FB1 and FB2 provide artists foldback, and Aux 1 & 2 feed an effects processor.

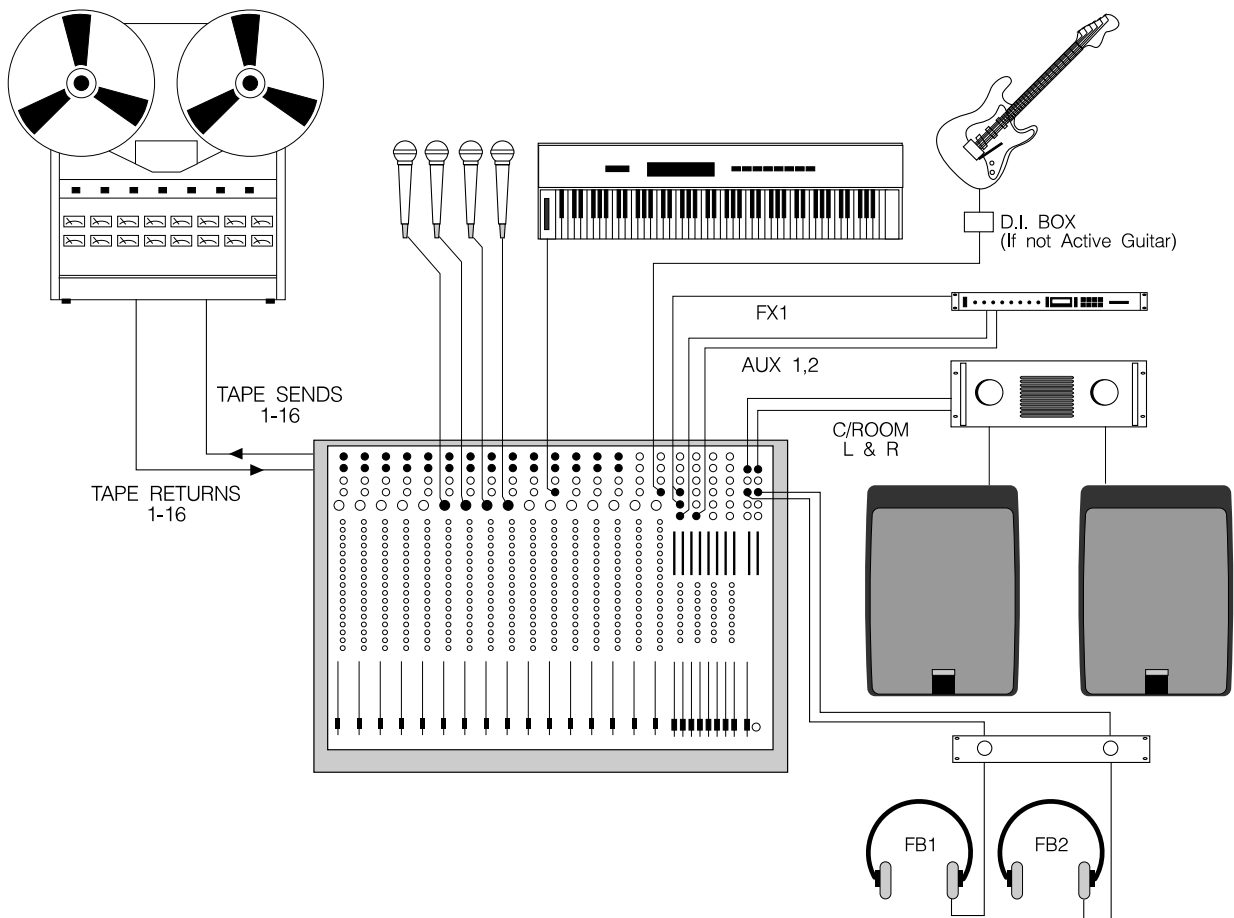

for which is returned on Effects Return 1.

## Example 2 - Playback/ Mix-Down

In this example the tracks on the multitrack machine are to be mixed down to a stereo master on a 2-track tape machine. Playback is via the Monitor path on the channels, and pressing the CHANMNTN INPUT REV switches allows mixing using the long-throw faders. Channels are routed to MIX, and the 2-track machine is fed from the Mix L & R outputs. The Monitor path on the inputs is now fed by the mic/line sockets, effectively doubling the number of inputs available and these can

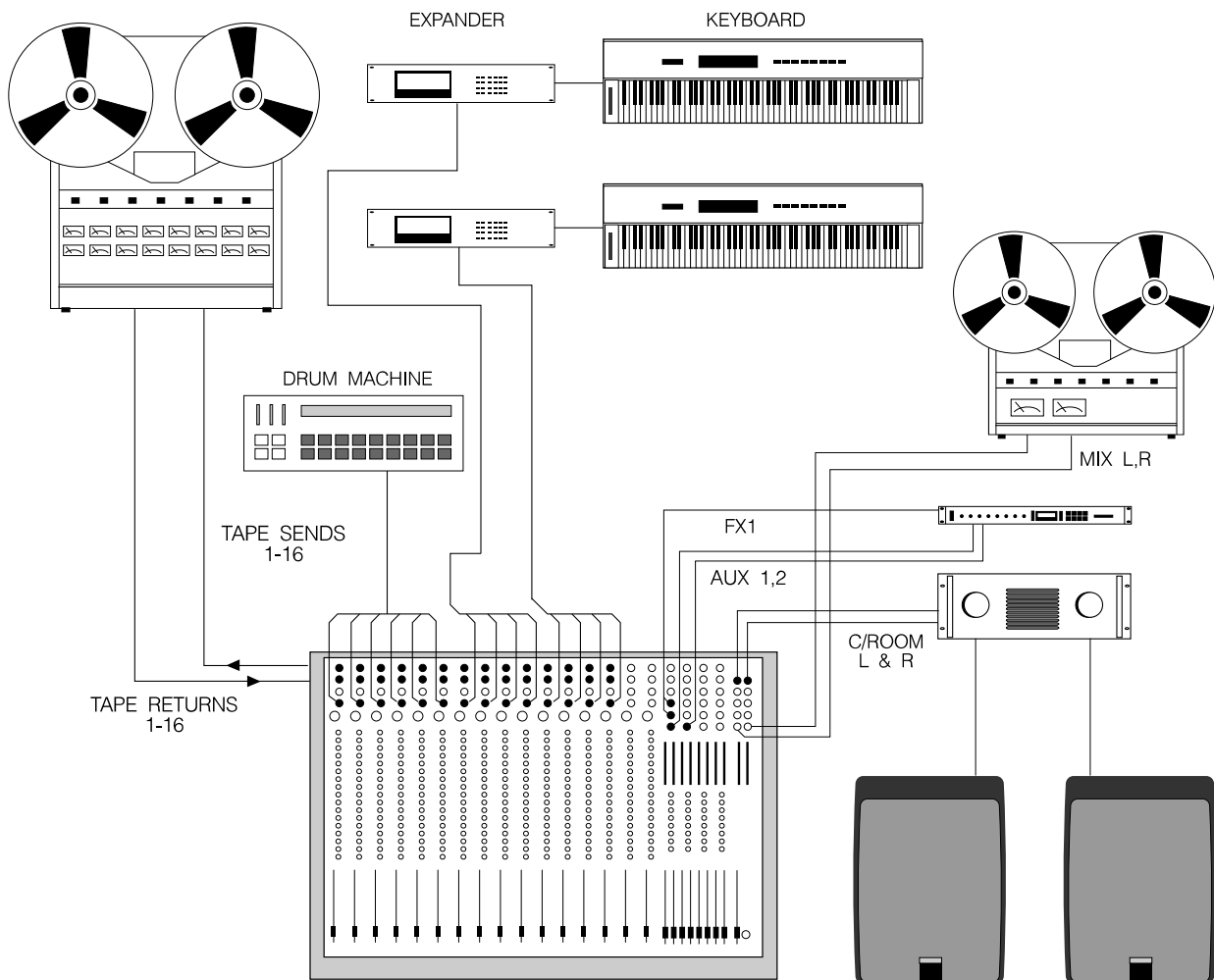

be used for extra sources, e.g. sequenced keyboards, synths, drum machines etc. during mixdown.

## Example 3 - Overdubbing

This is a variation on the mix-down configuration. Overdubbing allows one or more tracks to be recorded as other tracks are being played back in synchronisation. A Foldback mix is created for the overdub artist using FB2. All tape tracks are set in Playback (Sync) mode except the tracks to be recorded, and the signal for these can be derived from the channels (DIRECT) or by

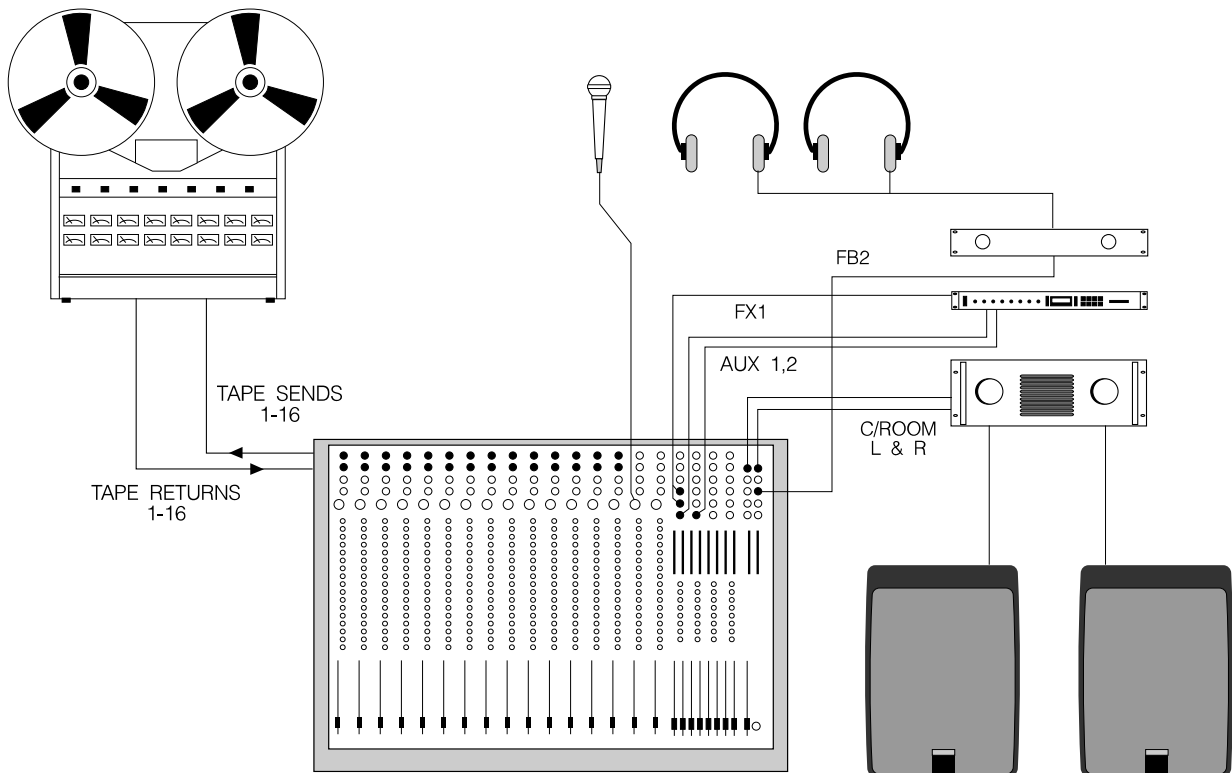

# SPIRIT STUDIO

plugging the Tape input to the appropriate Group Output.

## Example 4 - Live Public Address

Although primarily designed for recording, your SPIRIT STUDIO console can also serve very well as a mixer for live sound reinforcement. In the basic configuration shown, an assortment of sources are connected to the input channels, microphone to mic inputs and a keyboard and guitar to line inputs. Note that some guitars would not produce sufficient level for a direct connection, and would require a D.I. box connected via the microphone input. The main stereo output is connected to the power amplifiers and speakers, fed from the channels, via the subgroups if necessary. An effects processor or graphic equaliser

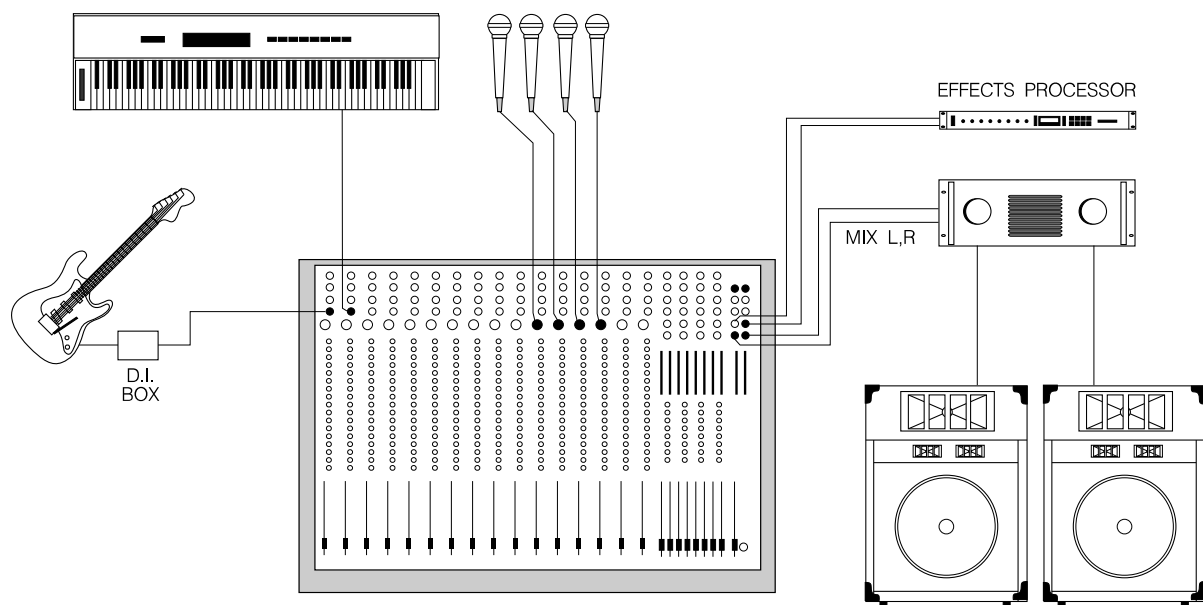

## CARE OF YOUR MIXER

---

General Precautions	<p>Avoid storing or using the mixer in conditions of excessive heat or cold, or in positions where it is likely to be subject to vibration, dust or moisture.</p> <p>Keep the mixer clean using a soft dry brush, and an occasional wipe with a damp cloth or ethyl alcohol. Do not use any other solvents which may cause damage to paint or plastic parts.</p> <p>Avoid placing drinks or smoking materials on or near the mixer. Sticky drinks and cigarette ash are frequent causes of damage to faders and switches.</p> <p>Regular care and inspection will be rewarded by a</p>
---------------------	--

---

## Glossary

auxiliary send	an output from the console comprising a mix of signals from channels and groups derived independently of the main stereo/group mixes. Typically the feeds to the mix are implemented on rotary level controls.
balance	the relative levels of the left and right channels of a stereo signal.
Channel Path	the section of the input channel which accepts normal input sources and feeds them to selected groups or stereo mix under the control of the linear channel fader.
clipping	the onset of severe distortion in the signal path, usually caused by the peak signal voltage being limited by the circuit's power supply voltage.
dB (decibel)	a ratio of two voltages or signal levels, expressed by the equation $\text{dB} = 20 \log_{10} (V_1/V_2)$ . Adding the suffix 'u' denotes the ratio is relative to 0.775V RMS.
DI(direct injection)	the practice of connecting an electric musical instrument directly to the input of the mixing console, rather than to an amplifier and loudspeaker which is covered by a microphone feeding the console.
equaliser	a device that allows the boosting or cutting of selected bands of frequencies in the signal path.

feedback	the 'howling' sound caused by bringing a microphone too close to a loudspeaker driven from its amplified signal.
foldback	a feed sent back to the artistes via loudspeakers or headphones to enable them to monitor the sounds they are producing.
frequency response	the variation in gain of a device with frequency.
(sub) group	an output into which a group of signals can be mixed.
headroom	the available signal range above the nominal level before clipping occurs.
line level signals	at a nominal level of -10 to +6dBu, usually coming from a low impedance source.
Mix-down	the operational mode in which pre-recorded tracks on the multitrack tape machine are replayed and mixed to create a final Stereo master recording.
Monitor Path	the section of the input channel which is normally fed by the tape machine outputs, and feeds to the stereo mix under the control of a rotary fader to create a Monitor mix.
Overdubbing	the operational mode in which one or more tracks can be recorded or modified as other tracks are played back.
pan (pot)	abbreviation of 'panorama': controls levels sent to left and right outputs.
peaking	an equaliser response curve affecting only a band of frequencies i.e. based on a bandpass response.
PFL (pre-fade listen)	a function that allows the operator to monitor the pre-fade signal in a channel independently of the main mix.
rolloff	a fall in gain at the extremes of the frequency response.
shelving	an equaliser response affecting all frequencies above or below the break frequency i.e. a highpass or lowpass derived response.
spill	acoustic interference from other sources.
talkback	the operator speaking to the artistes or to tape via the auxiliary or group outputs.
transient	a momentary rise in the signal level.
trim control	a variable control which gives adjustment of signal level over a limited and predetermined range usually for calibration



## Selectable Options

### Selecting Average Response on Bargraphs

The Bargraph Meters on your SPIRIT STUDIO are capable of two modes of operation: PEAK and AVERAGE.

In Peak mode the meter responds rapidly to initial signal transients and decays slowly, making it easy to detect overload. In Average mode the bargraph takes on the characteristics of a VU meter with evenly fast attack and decay times. All meters are factory-set to PEAK characteristic, but may be changed to AVERAGE response by moving a link from PeaK to AVErAge positions on the appropriate PCB as shown below. To select AVERAGE response, remove the PCB from the console and carefully unsolder the link in the PK position using the minimum of heat to avoid the possibility of tracks lifting on the PCB. Replace the link in the AVE position.

This operation should only be carried out by competent technicians who possess the necessary soldering skills.

Note: All odd Group and the LH Master meters are situ-

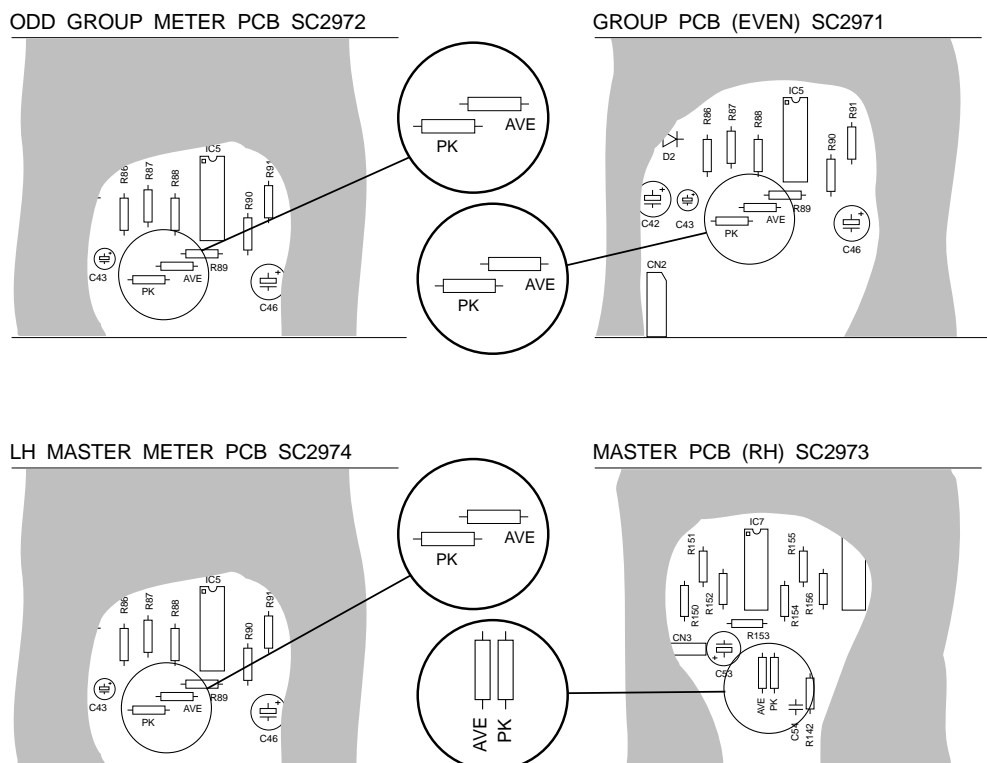

## Modification of Tape Sends & 2 Track Return Level

All input Tape Sends are factory set to suit -10dBV equipment. If a level of +4dBu is required the output level may be changed by removing resistors R130/R131 from the Input PCB SC2970. This can be done without removing the PCB by carefully cutting the leads of the resistor above the board at the points marked as shown below.

The Master 2-Track Return can similarly be changed to suit +4dBu equipment by removing resistors R14/R17/R54/R57 from the Master PCB SC2973 as shown below. The PCB will need to be removed from

INPUT PCB SC2970

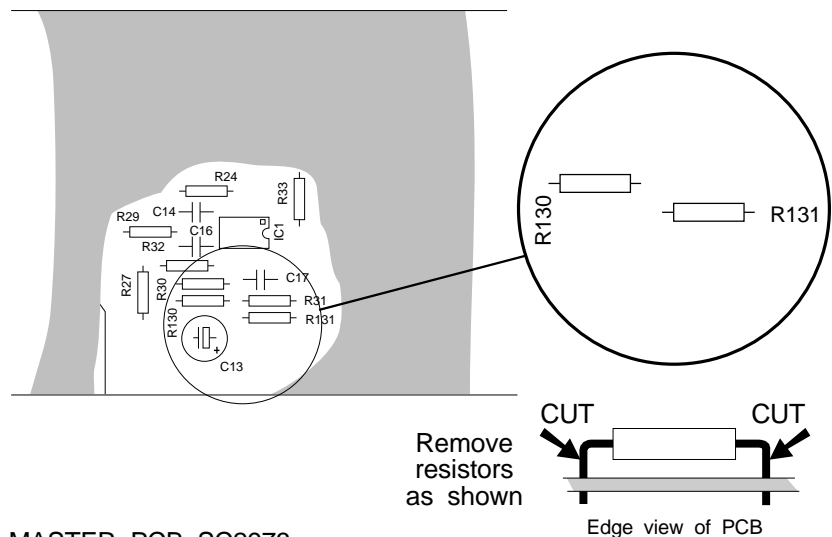

MASTER PCB SC2973

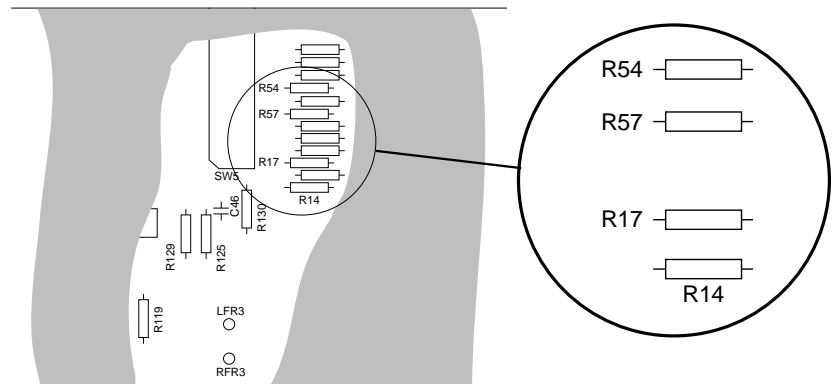

## Specifications

Noise	Measured RMS, 22Hz to 22kHz Bandwidth Line inputs selected at unity gain and terminated 150R.	
Buss Noise:	Masters Down	Masters Up, 24 Ch. Routed
Mix Left	-98dBu	-86dBu
Mix Right	-98dBu	-86dBu
Group	-95dBu	Nothing Routed
Aux (1)	-95dBu	-85dBu
Aux (4)	-95dBu	-85dBu
FB (1)	-98dBu	-84dBu
FB (2)	-98dBu	-84dBu
Mix Noise	24 Monitors Routed & 'ON'	
Mix Left	-80dBu	
Mix Right	-80dBu	
	24 Monitors & Channels Routed	
Mix Left	-80dBu	
Mix Right	-80dBu	
	24 Monitors & Channels Routed & 'ON'	
Mix Left	-76dBu	
Mix Right	-76dBu	
E.I.N.	Microphone Input. Maximum Gain, Terminated 150R	-129dBu
C.M.R.R.	Measured at 1kHz Microphone Input at Maximum Gain	-90dB
	Line Input at Unity Gain	-55dB
Distortion	THD Measured 1kHz at +20dBu, 20Hz to 20kHz Bandwidth	
	Line in to Mix out	< 0.006%
	Line in to Group out	< 0.006%
	Line in to Aux out	< 0.006%
	Line in to FB out	< 0.006%

Tape Send with +20dBu @ Group out < 0.006%

---

Crosstalk	Measured 1kHz sine wave	
	Routing Isolation (Mix L/R & Group)	> 100dB
	Max. Fader Attenuation	> 86dB Typical
	Max. Aux Send Attenuation	> 89dB Typical
	Channel Pan to Group Isolation	> 76dB
	Channel 'ON' Switch Isolation	> 100dB
	Monitor 'ON' Switch Isolation	> 100dB
	FX Return to Mix	> 100dB
	FX Return to Group	> 85dB

---

Frequency Response	Measured 20Hz to 20kHz Bandwidth, Relative to 1kHz	
	Mix Left/Right Outputs	+/- 0.5dB
	Mono Output	+/- 1dB
	Aux Outputs	+/- 0.5dB

---

#### Input & Output Impedances

Microphone Input	2k $\Omega$
Line Input	10k $\Omega$
Insert Sends	75 $\Omega$
Insert Returns	10k $\Omega$
Outputs	75 $\Omega$

---

Input & Output Levels	Mic Input Maximum Level	+10dBu
	Line Input Maximum Level	+30dBu
	Mix Out Maximum Level	+21dBu
	Mono Out Maximum Level	+21dBu
	Aux Out Maximum Level	+21dBu

---

Metering	16 Segment LED Bargraph	
	Selectable 'PEAK' or 'AVERAGE' Reading	
	Accuracy Relative to '0dB'	+/- 1dB

**INPUT**

18 SEND TRACK RETURN

3 INSERT

4 LINE

1 MIC

2 +48V

8 DIRECT

19 TAPE TRIM

5 LINE 30dB

6 GAIN

7 CHANNELTR INPUT REV

9 HF

10 EQ TO MNTR

11 LF

HIGH 100

12 LMD

12 CHAN FB1

AUX 1

AUX 2

20 MNTR FB2

AUX 3

AUX 4

21 CHAN

22 MNTR PAN

23 MNTR FOR

24 PFL

25 OR

13 CHAN PAN

14 L

15 R

16 10 15 20 25 30 40 50

17 10 15 20 25 30 40 50

**Soundcraft**

**GROUPS**

1 2 3 4 5 6 7 8 master

27 GRP-1 GRP-3 GRP-5 GRP-7

28 GRP-2 GRP-4 GRP-6 GRP-8

34 FX1-L FX2-L FX3-L FX4-L

33 FX1-R FX2-R FX3-R FX4-R

31 15 12 9 6 4 2 0 -2 -4 -6 -8 -9 -12 -15 -18 -21 -24

32 MASTER AUX 1 2 3 4

35 TRIM

36 HF LF

37 FB1 FB2

38 FX PAN

39 FX FOR

40 PFL

41 FX TO GRP

42 FX TO MIX

30 MIX SUB-GROUP MONO

29 PFL

26 10 15 20 25 30 35 40 50

**MASTER**

59 DC POWER INPUT

58 L CRM R

53 L 2TRK R

50 1 FB 2

44 L INS R

43 L MIX R

47 10Hz 15Hz

48 OSCILLATOR

49 TAPE

51 FB1 AFL

52 FB2 AFL

54 CRM SOURCE TO FB1 & FB2

55 2 TRACK REPLAY

56 PFLAFL CAL

57 CRM & PHONES

56 TB

46 TAP

57 FB

PHONES

**SPIRIT STUDIO**

59

58

53

50

44

43

45

47

48

49

51

52

54

55

56

46

57

**INPUT**

**GROUPS**

**MASTER**

# CHANNEL

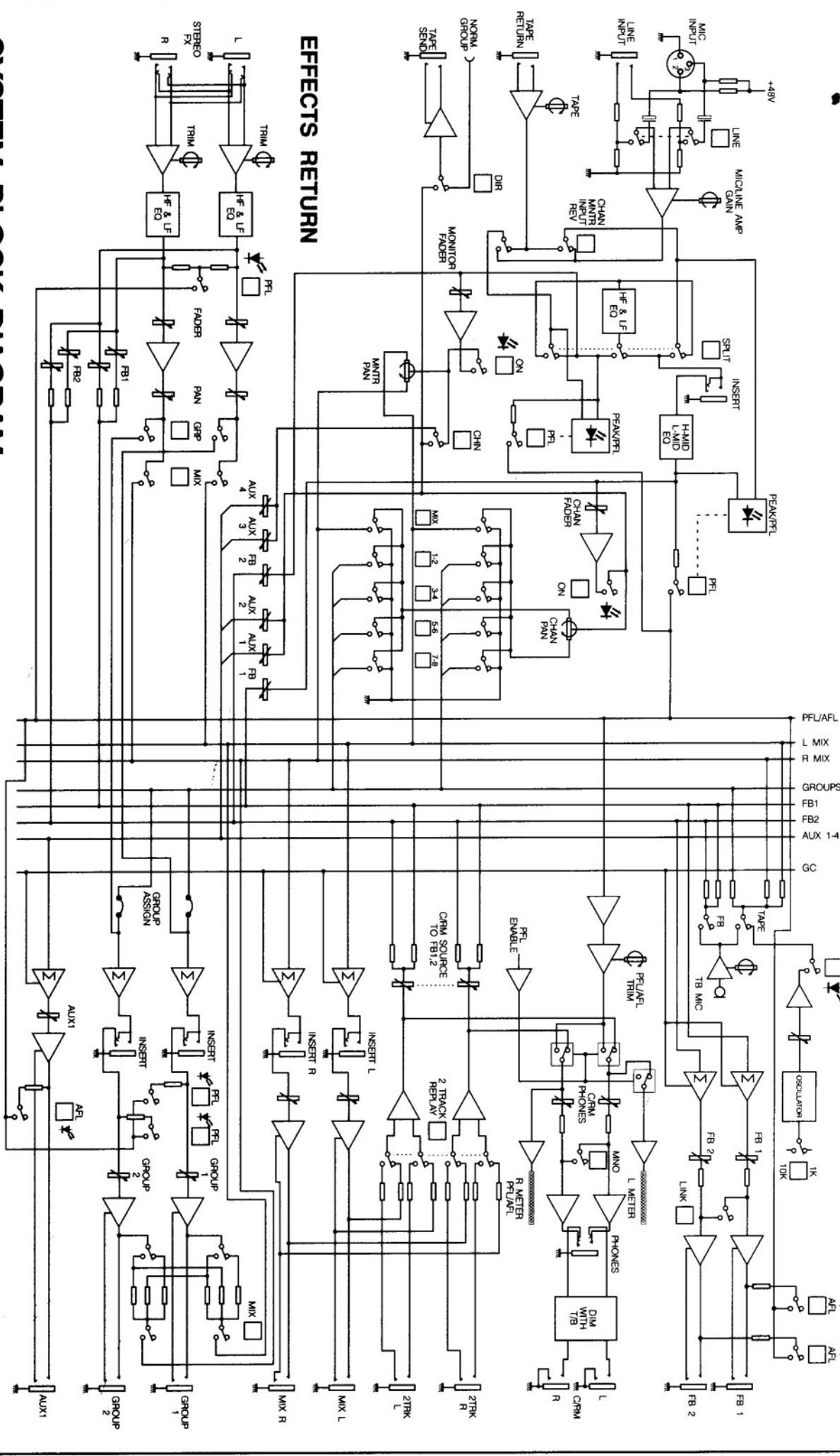

# MASTER

# SYSTEM BLOCK DIAGRAM