

USERS MANUAL



IMPORTANT SAFETY INSTRUCTIONS



The lightning flash with an arrowhead symbol within an equilateral triangle, is intended to alert the user to the presence of uninsulated "dangerous voltage" within the product's enclosure that may be of sufficient magnitude to constitute a risk of electric shock to persons.



The exclamation point within an equilateral triangle is intended to alert the user to the presence of important operating and maintenance (servicing) instructions in the literature accompanying the product.

- 1 Read these instructions.
- 2 Keep these instructions.
- 3 Heed all warnings.
- 4 Follow all instructions.
- 5 Do not use this apparatus near water.
- 6 Clean only with dry cloth.
- 7 Do not block any ventilation openings.
Install in accordance with the manufacturer's instructions.
- 8 Do not install near any heat sources such as radiators, heat registers, stoves, or other apparatus (including amplifiers) that produce heat.
- 9 Do not defeat the safety purpose of the polarized or grounding-type plug. A polarized plug has two blades with one wider than the other. A grounding type plug has two blades and a third grounding prong. The wide blade or the third prong are provided for your safety. If the provided plug does not fit into your outlet, consult an electrician for replacement of the obsolete outlet.
- 10 Protect the power cord from being walked on or pinched particularly at plugs, convenience receptacles, and the point where they exit from the apparatus.
- 11 Only use attachments/accessories specified by the manufacturer.
- 12 Unplug this apparatus during lightning storms or when unused for long periods of time.
- 13 Refer all servicing to qualified service personnel.
Servicing is required when the apparatus has been damaged in any way, such as power-supply cord or plug is damaged, liquid has been spilled or objects have fallen into the apparatus, the apparatus has been exposed to rain or moisture, does not operate normally, or has been dropped.

WARNING

- To reduce the risk of fire or electric shock, do not expose this apparatus to rain or moisture.
- This apparatus must be earthed.
- Use a three wire grounding type line cord like the one supplied with the product.
- Be advised that different operating voltages require the use of different types of line cord and attachment plugs.
- Check the voltage in your area and use the correct type. See table below:

| Voltage | Line plug according to standard. |
|----------|---|
| 110-125V | UL817 and CSA C22.2 no 42. |
| 220-230V | CEE 7 page VII, SR section 107-2-D1/IEC 83 page C4. |
| 240V | BS 1363 of 1984. Specification for 13A fused plugs and switched and unswitched socket outlets. |

- This equipment should be installed near the socket outlet and disconnection of the device should be easily accessible.
- Do not install in a confined space.
- Do not open the unit - risk of electric shock inside.

Caution:

You are cautioned that any change or modifications not expressly approved in this manual could void your authority to operate this equipment.

Service

- There are no user-serviceable parts inside.
- All service must be performed by qualified personnel.

NOTE

EMC / EMI.

This equipment has been tested and found to comply with the limits for a Class B Digital device, pursuant to part 15 of the FCC rules.

These limits are designed to provide reasonable protection against harmful interference in residential installations. This equipment generates, uses and can radiate radio frequency energy and, if not installed and used in accordance with the instructions, may cause harmful interference to radio communications. However, there is no guarantee that interference will not occur in a particular installation. If this equipment does cause harmful interference to radio or television reception, which can be determined by turning the equipment off and on. The user is encouraged to try to correct the interference by one or more of the following measures:

- Reorient or relocate the receiving antenna.
- Increase the separation between the equipment and receiver.
- Connect the equipment into an outlet on a circuit different from that to which the receiver is connected.
- Consult the dealer or an experienced radio/TV technician for help.

For the customers in Canada:

This Class B digital apparatus complies with Canadian ICES-003.

Cet appareil numérique de la classe B est conforme à la norme NMB-003 du Canada.

Certificate Of Conformity

TC Electronic A/S, Sindalsvej 34, 8240 Risskov, Denmark, hereby declares on own responsibility that following product:

M3000 Digital Signal Processor

That is covered by this certificate and marked with CE-label conforms with following standards:

| | |
|-------------------------|--|
| EN 60065 (IEC 60065) | Safety requirements for mains operated electronic and related apparatus for household and similar general use |
| EN 55103-1 | Product family standard for audio, video, audio-visual and entertainment lighting control apparatus for professional use. Part 1: Emission. |
| EN 55103-2 | Product family standard for audio, video, audio-visual and entertainment lighting control apparatus for professional use. Part 2: Immunity. |

With reference to regulations in following directives:
73/23/EEC, 89/336/EEC

Issued in Risskov, December 2002

*Anders Fauerskov
Managing Director*

TABLE OF CONTENTS

| | | | |
|---|-----|---------------------------|----|
| SAFETY & CERTIFICATE OF CONFORMITY | a-b | ADDITIONAL EFFECTS | |
| | | Delay | 47 |
| | | Pitch | 47 |
| INTRODUCTION | | EQ | 48 |
| Table of contents | 3 | Chorus-Flanger | 49 |
| Introduction | 5 | Tremolo | 50 |
| The Front Panel | 6 | Phaser | 51 |
| The Rear Panel | 8 | Expander/Gate | 51 |
| The Signal Flow | 9 | Compressor | 52 |
| | | De-esser | 53 |
| BASIC OPERATION | | APPENDIX | |
| Recall | 10 | The Reset Page | 54 |
| Recall & Snapshots | 12 | Self Test | 55 |
| Store | 13 | Troubleshooting | 56 |
| The Reverb Wizard | 14 | Glossary | 57 |
| I/O - The Signal Page | 15 | Technical Specifications | 58 |
| Levels Menu | 17 | MIDI Implementation Chart | 59 |
| Routing | 18 | Soldering Instructions | 60 |
| Routing & Studio Setup Examples | 19 | | |
| Utility and MIDI | 20 | PRESET LIST | 61 |
| MIDI Monitor | 22 | | |
| Full MIDI Implementation | 22 | | |
| Tempo | 23 | | |
| Edit | 24 | | |
| Dynamic Morphing | 25 | | |
| REVERB | | | |
| VSS™ Introduction | 26 | | |
| VSS™ FP - Film and Post | 30 | | |
| VSS™ SR - Surround | 32 | | |
| Reverb programs | | | |
| VSS™ 3 | 33 | | |
| VSS™ Gate | 35 | | |
| VSS™ FP | 39 | | |
| VSS™ SR | 42 | | |
| C.O.R.E | 45 | | |
| REV 3 | 46 | | |

INTRODUCTION

Congratulations on the purchase of your new M3000.

We hope, that you will have as much pleasure using it as we had making it.

The objective of the M3000 has been to make the best reverb unit ever heard.

Utilizing the existing reverb technology to its limit didn't satisfy the developers at TC, and we had to come up with an entirely new way of thinking about reverb. This is now known as the VSS™ Technology.

The M3000 is first and foremost a reverb unit, but we have also included a long list of well-known, tested and loved algorithms from other TC products as listed below.

- The M3000 is based on TC's award-winning Dual Processing system, which gives you numerous options of combining the different preset-algorithms.
- See the M3000 as two separate machines connected via a flexible routing system. The routings are; Serial, Parallel, Dual Input, Dual Mono, Linked and Pre-Glide.
- The M3000 comes with 600 high grade factory presets (500 Single and 100 Combined), using our new VSS™ technology in combination with well known algorithms from other TC Products.
- Store your favorite presets in the internal RAM bank. Up to 250 Single and 50 Combined user presets can be stored.
- Store your favorite presets on a standard PCMCIA-card, and you have your own "tools" with you wherever a M3000 is available. Depending on the size of the card you can store up to 250 Single and 50 Combined presets.

Main Features :

VSS™ technology giving you

- Real room simulation - giving the ability to simulate the response of actual rooms.
- Spaciousness - the ability to create a wide and natural sonic image and avoid the massive "wall of reverb".
- Piano correctness - the ability to keep the signal in 100% correct pitch, even when engaging extensive effects processing.
- Modulation Free - the ability to keep the signal 100% free of sound deteriorating modulation.
- Add Modulation - the option to add modulation to the tail of the reverb in order to add life and feel to the sound.
- With control of the Early Reflections you have the ability to simulate all relevant parameters of true ambience.

The algorithms in the M3000 are :

Reverbs

- VSS™3
- VSS™Gate
- VSS™FP
- VSS™SR
- C.O.R.E.
- Rev 3

Additional Effects

- Delay
- Pitch
- EQ
- Expander
- Compressor
- Chorus/Flanger
- Tremolo/Panner
- Phaser
- De-esser

THE FRONT PANEL

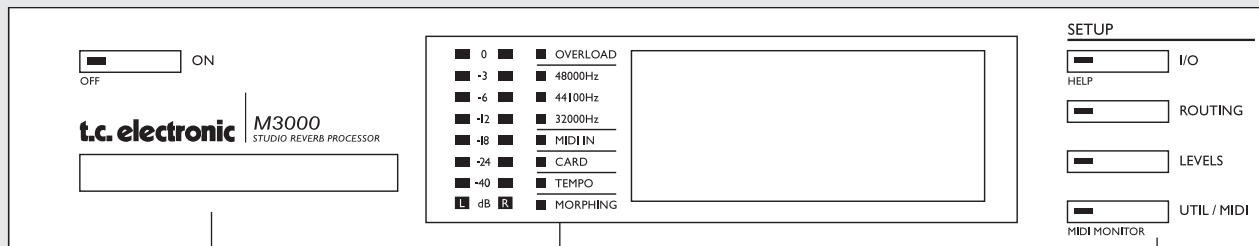

POWER + MEMORY CARD

POWER SWITCH

Turn on the machine with a single light touch. To turn off the machine you must press and hold down the POWER key approx. 3 seconds, until the display reads M3000.

This delay time is to avoid switching off the device by accident.

PCMCIA-CARD

Copy presets to/from a standard memory card.

CARD TYPES

S-RAM type 1 PCMCIA cards, with a minimum of 64KB and a maximum of 2MB memory.

PPM + INDICATORS

PPM METERS

Ranging from -40dB to 0dB.

OVERLOAD

Indicates if internal overload occurs.

SAMPLE RATE INDICATOR

48000Hz
44100Hz
32000Hz

MIDI IN

MIDI receive indicator.

CARD

Indicates presence of a valid memory card.

TEMPO

Beats per minute indicator.

MORPHING

Indicates on-going morphing between the two Engines.

SETUP SECTION

I/O

Input/Output.
Sample Rate.
Select Status bit Output.
Dithering.

ROUTING

Setup the internal routing of the 2 Engines.

LEVELS

Input/Output Analog levels.
Digital/Input level.

UTIL/MIDI

Adjust the viewing angle of the display for better comfort.
Security lock.
Glide Time setting.
Card handling.
Pedal Input.
MIDI.

SECONDARY FUNCTIONS

Help (online help function)

MIDI Monitor (Monitors all MIDI ch. at the same time)

THE FRONT PANEL

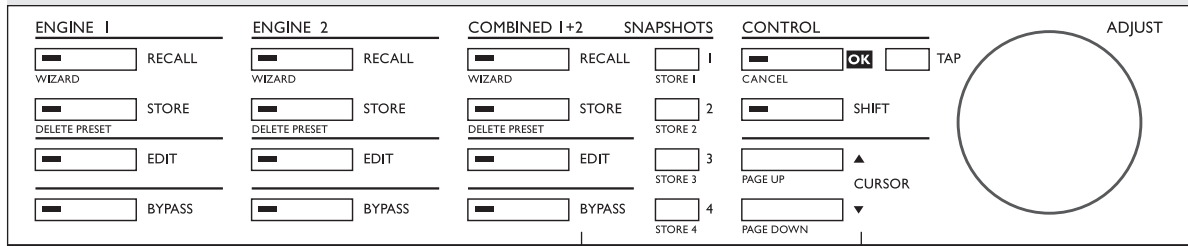

ENGINE 1 OR 2

RECALL

Recall/activate the program you have selected.

STORE

Save and name your current preset. The M3000 holds 500 single factory presets and up to 250 Single user presets.

EDIT

Enter the edit mode.

BYPASS

Individual bypass key for each Engine.

Secondary functions (with SHIFT activated)

Recall Wizard

Find a preset that matches your application

Delete preset

The fast (and only) way to delete presets

COMBINED 1+2

RECALL

Recall/activate Combined presets.

STORE

Save and name Combined presets. The M3000 holds 100 Combined factory presets and up to 50 Combined user presets.

EDIT

Engine out level.
Dynamic Morphing.

BYPASS

Bypasses the entire device.

SNAPSHOTS 1-4

Quick Store/Recall of Combined presets.

Secondary functions (with SHIFT activated)

Recall Wizard.

Delete preset.

CONTROL SECTION

OK

Confirm operations.

SHIFT

Press to access secondary functions
(Text below the buttons).

CURSORS

Move between parameters.

ADJUST wheel

Set parameter values and preset numbers.

Secondary functions (with SHIFT activated)

Cancel

Jump to the top or the bottom of the present displayed parameter list.

THE REAR PANEL

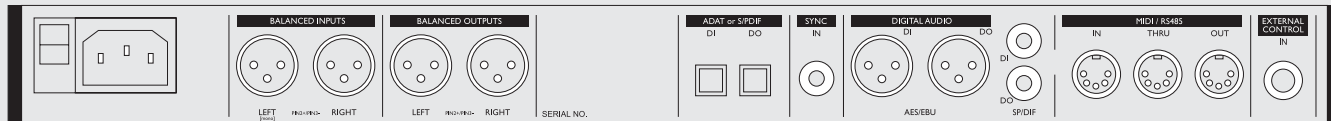

Main Power Switch
Power Input

Balanced XLR Analog Inputs

Balanced XLR Analog Outputs

Serial no.

Digital In/Out ADAT Tos-link

Wordclock RCA

Digital In/Out AES/EBU S/PDIF

MIDI In, Thru, Out

External Control Input

Notes:

To accommodate international regulations, we have also added a back panel power switch. You do not need to use the POWER switch on the rear panel. Leave this POWER switch on and use our Easy-Touch POWER switch on the front.

Be sure to select Channel Input in the I/O display when only one Input is used.

Pin 2 is »hot« on all XLR's (AES Regulations).

If you are connecting the M3000 to unbalanced equipment, you must tie pins 1 and 3 together in the cable ends away from the M3000. (Please see Soldering Instructions on page 61).

By connecting a momentary pedal to the External Control Input, you can control any one of four different features: Engine 1 bypass, Engine 2 bypass, Engine 1+2 bypass or Tap Tempo.

THE SIGNAL FLOW

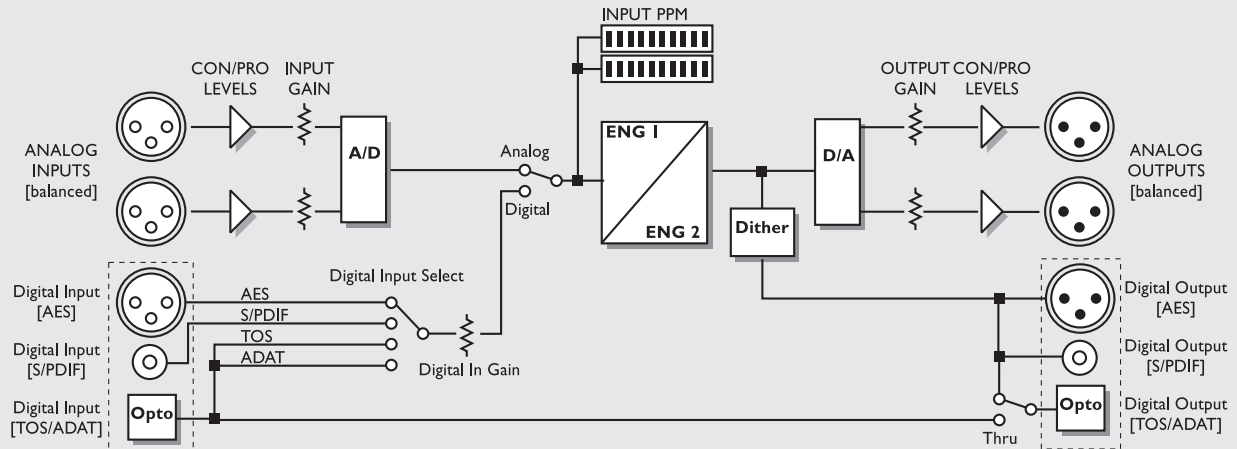

Notes regarding the signal flow:

**As shown in the block diagram signals are present on all Outputs all the time.
You can dither to 22, 20, 18, 16, or 8 bit. (See the I/O section on page 15).**

The Digital Input gain circuit is capable of »lifting« the signal level. This is a very useful feature if you e.g. are feeding the M3000 with a DAT recording that is not fully leveled to 0dB.

RECALL

The Recall Displays

The Recall displays are the "homepage" of the M3000. Whenever you exit any other display this is where you return to. As illustrated below the Recall display holds a few of the most important parameters for each of the two Engines at the same time. Engine 1 is always displayed in the upper section and Engine 2 in the lower. The "Edited flag" shows an E when you have changed a parameter in the preset. (See ill.)

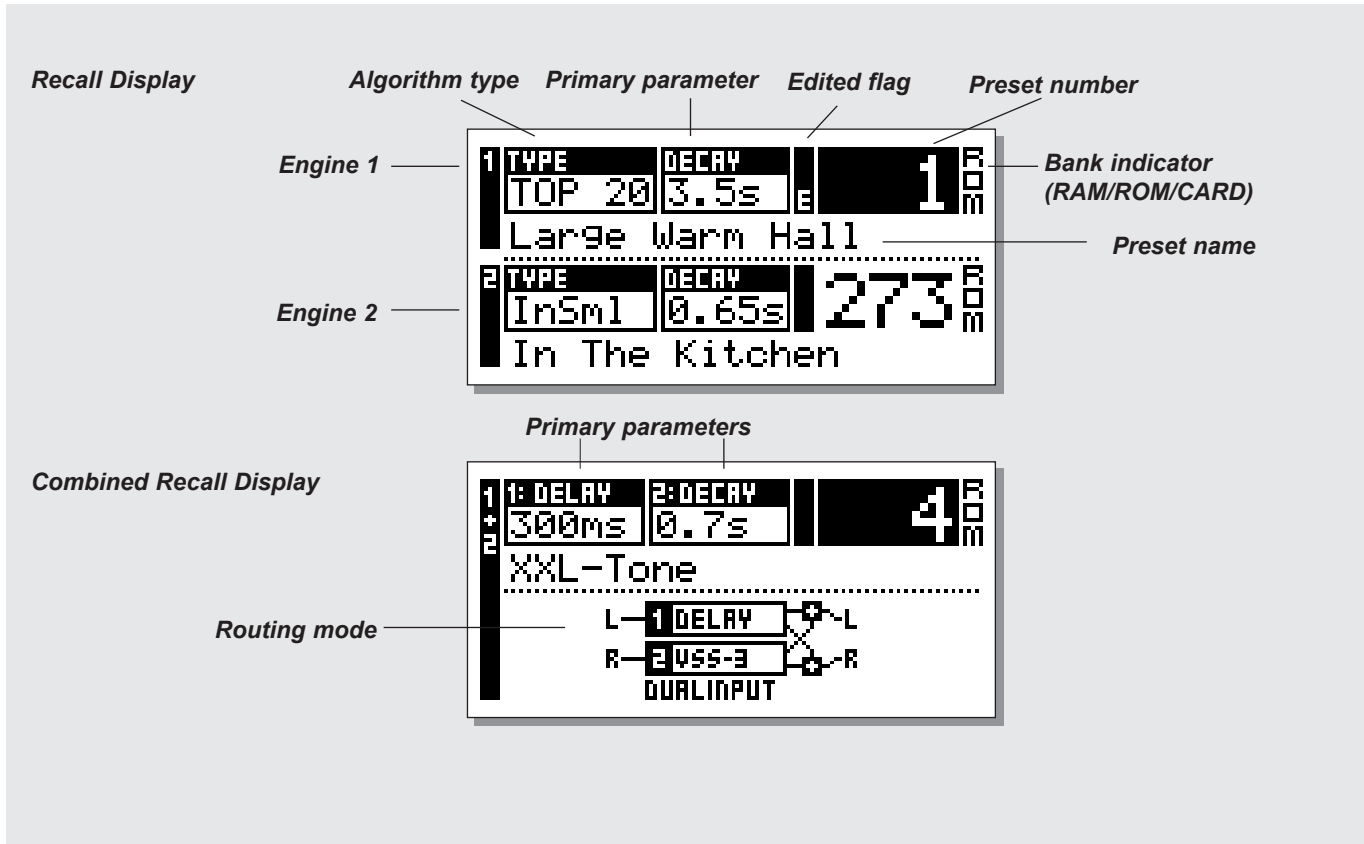

Recalling a Preset

Press the RECALL key on Engine 1 or 2 and scroll through the presets using the ADJUST wheel. Press OK to recall when you find the desired preset.

You are able to search for another preset before recalling it. This is called previewing.

Until you press OK you are previewing. At this point your OK key is blinking, indicating that the preset displayed is not yet recalled (active).

Use the CURSOR keys (or the other RECALL key) to access the other Engine.

You can also use the Wizard to recall presets. (See "The Wizard" on page 14).



If you wish to return to the original preset after editing various parameters without storing your changes, simply press the RECALL key on the appropriate Engine followed by OK.

RECALL

Combined Recall

A Combined preset consists of a specific preset in Engine 1; a specific preset in Engine 2 and the routing between them.



Get acquainted with the different routings of the two Engines. Routing is an important setting when using both Engines. (See "Routing" page 18).

As the standard Recall display, the Combined Recall display holds a few important parameters: The preset name; the Decay time for the two presets and the selected routing.

To Recall a Combined preset:

Press the Combined RECALL key and scroll through the presets using the ADJUST wheel. Press OK to recall when you find the preset you wish to use.

The preset number and the OK key will blink while you are pre-viewing, indicating that the shown preset is not yet recalled.

Factory/User Presets

| <i>SINGLE</i> | <i>COMBINED</i> | |
|------------------|-----------------|------------------------------|
| 500 ROM PRESETS | 100 ROM PRESETS | <i>Factory presets</i> |
| 250 RAM PRESETS | 50 RAM PRESETS | <i>Your own presets</i> |
| 250 CARD PRESETS | 50 CARD PRESETS | <i>Your own card presets</i> |

Preset banks

The M3000 contains four different preset banks plus two additional Card banks.

Single ROM bank:

This bank contains 500 Single factory presets. The presets are available from Engine 1 and Engine 2.

Combined ROM bank:

The Combined bank contains 100 Combined factory presets. The presets are available from the Combined Recall.

Single RAM bank:

This bank can hold up to 250 of your Single presets.

Combined RAM bank:

The Combined RAM bank can hold up to 50 of your Combined presets (see Combined presets). The RAM banks are located after the corresponding ROM banks. Scroll through the 500/100 ROM presets to enter the RAM bank. *Note! Until you have stored one or more presets in the RAM bank the RAM bank will not be accessible.*

Card banks:

Use a standard PCMCIA and you have a portable RAM bank containing up to 250 Single presets and 50 Combined presets. Use a S-RAM Type 1 PCMCIA with min. 64KB and max. 2MB of memory.



Press SHIFT and turn the ADJUST wheel one click clockwise or counter-clockwise to jump to the next preset section.

Example:

You have recalled any ROM preset between 1 and 250. Press SHIFT and turn the ADJUST wheel clockwise one click and you are now previewing preset 251. Press SHIFT again and turn the ADJUST wheel clockwise one more click. You are now previewing ROM preset 500. Opposit moves are possible by pressing SHIFT and turning the ADJUST wheel counter-clockwise.

RECALL & SNAPSHOTS

Exercise 1:

How to recall a preset

Select Engine 1 or 2 or the Combined 1+2 by pressing the corresponding RECALL key.

Turn the ADJUST wheel to scroll through the presets. While scrolling you will see both the preset number in the display and the LED of the OK key is blinking. At this point the preset is not yet recalled (active). Select ROM preset #5 and press OK to Confirm. Preset #5 is now recalled.

Exercise 2:

How to take a Snapshot

Press the Engine 1 RECALL key. Select e.g. preset #26 using the ADJUST wheel.

Press OK to confirm.

Press the Engine 2 RECALL key. Select e.g. preset #28 using the ADJUST wheel.

Press OK to confirm.

Press SHIFT followed by SNAPSHOT STORE key #1.

Your Snapshot is now stored.

To see that it works:

Recall two different presets in Engine 1 and 2.

Now press SNAPSHOT key #1, and once again you have recalled preset #26 into Engine 1 and preset #28 into Engine 2.

Snapshots

The SNAPSHOT keys, located between the Combined 1+2 and the control section, are actually four fast RECALL keys. Switch between your favorite Single presets or Combined presets with the touch of a single key or use the SNAPSHOTS as four compare keys.

A Snapshot will always include both presets and their Routing just like a Combined preset.

With the Snapshots you are able to switch between completely different configurations with the touch of a single key.

Store a Snapshot

When you want to store a Snapshot of your M3000 setup, press SHIFT followed by one of the four SNAPSHOT keys.

Recalling a Snapshot

Recall of a Snapshot is very easy as well: Simply press the relevant SNAPSHOT key and the M3000 has recalled the entire setup.

Index feature in the Recall Mode

Press and hold down the RECALL key on either Engine 1 or 2. A preset index display will pop up.

This feature gives you an overview over the Single ROM presets and enables you to quickly access the desired type of presets.

If the current recalled preset is in the range of 1 - 250, the overview will cover this range only.

| ROM PRESET TYPES | NO.: |
|--------------------|---------|
| TOP 20 | 1-20 |
| REAL/VIRTUAL HALLS | 21-136 |
| REAL/VIRTUAL ROOMS | 137-190 |
| PLATES | 191-204 |
| GATED REVERB | 205-211 |
| CLUBS | 212-225 |
| OTHER ALGORITHMS | 226-250 |

If the current recalled preset is in the range of 251 - 500 the overview will cover this range only.

| POST PRESET TYPES | NO.: |
|-------------------|---------|
| INDOOR | 250-399 |
| CARS | 400-409 |
| OUTDOOR | 410-439 |
| NATURE | 440-459 |
| EFFECT | 460-469 |
| SURROUND | 470-500 |

STORE

Storing a User preset and handling preset names.

Storing a RAM preset with the same name:

- Press the relevant STORE key (Engine 1, 2 or Combined 1+2)
- Use the ADJUST wheel to select a location for your new preset. (You can store your preset in the RAM bank).
- Press OK to store.

Storing a RAM preset with a new name:

- Press the relevant STORE key (Engine 1, 2 or Combined 1+2)
- Select a location for your new preset using the ADJUST wheel. (You can store your preset in the RAM bank)
- Move the cursor to the new name line and write the new preset name.
(Select letters with the ADJUST wheel and confirm each letter with OK)
- Select DONE and press the OK key to store name and preset.

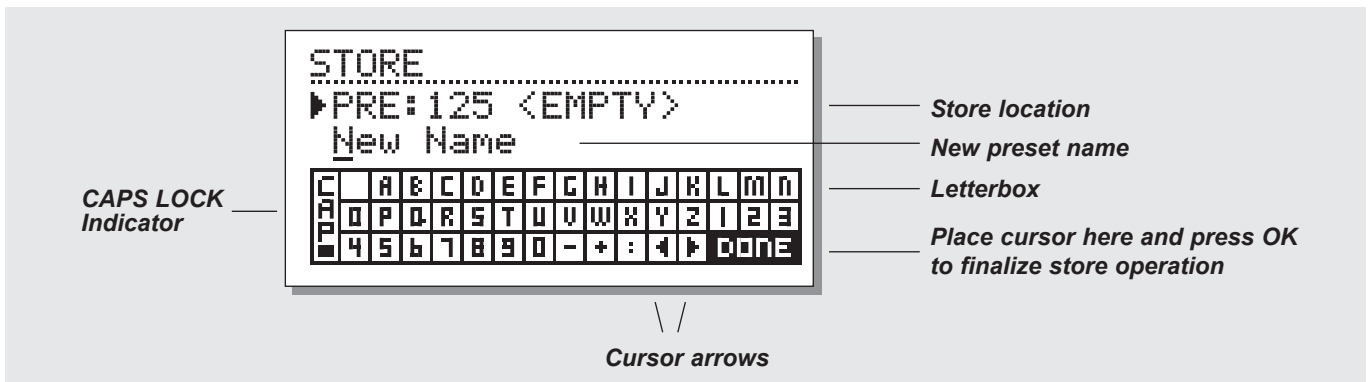

Exercise 3 :

Entering a new name step by step using the Letterbox

Changing the name of a preset is a part of the store operation.

For this exercise select Engine 1 by pressing its RECALL key.

- Press the STORE key and you will see the display similar to the one illustrated above.
- The M3000 automatically suggests a RAM location where you can store the preset. Choose one yourself by turning the ADJUST wheel.
- Use the CURSOR keys to select the name line. Use the ADJUST wheel to select a letter and press the OK key to confirm each letter. To change caps select CAP and press OK.
- Finish the operation by selecting DONE in the letterbox and press OK to store.

Combined Store

The procedure of storing a Combined preset is exactly the same as when you store a normal preset.

Note: A Combined preset stores the routing of the Engines along with the preset.

Using a Memory Card:

When inserting a memory card you gain access to the card bank. You can store up to 250 Single and 50 Combined user presets on a card depending on the size of the card.

By using the card handling features in the UTIL/MIDI menu you are able to copy a selection or an entire preset bank to a card or the other way around.

Card types

S-RAM Type 1 PCMCIA cards, with a minimum of 64 KB and a maximum of 2 MB memory.

NOTE ! If the card holds other information than M3000 presets info, the card will automatically be formatted the first time you save or dump to the card.

THE REVERB WIZARD

The Reverb Wizard is a unique guide that helps you find the optimal factory preset for your program material. By selecting an algorithm and the instrument type you wish to apply the reverb to, the Reverb Wizard suggests a selection of relevant presets.

The Wizard is easy to access and simple to use.

Try the Wizard and listen what presets our creative staff suggests for your specific application.

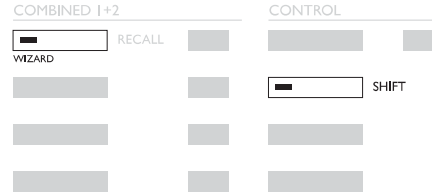

Press SHIFT and WIZARD to enter The Reverb Wizard.

The Wizard Display

Select between Music or Post production application

Select instrument or environment

Select the size of the reverb

Dial to select between the presets that utilize the search criteria. And press OK to recall

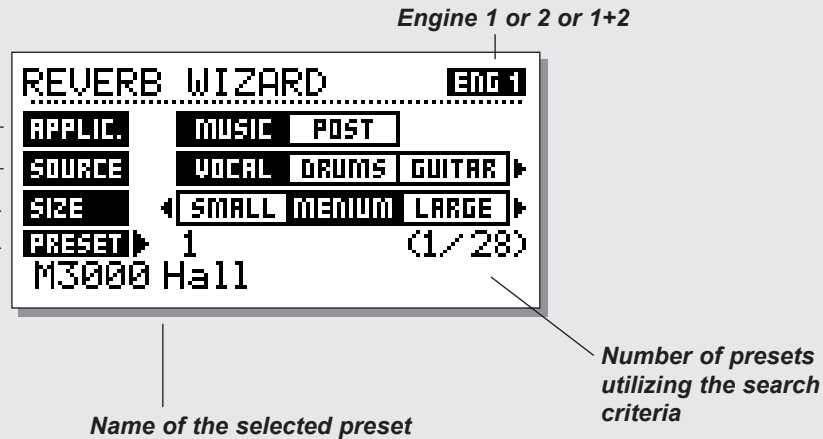

Name of the selected preset

Number of presets utilizing the search criteria

Press SHIFT and WIZARD to enter the Wizard function. Use the CURSOR keys to select the different filters and the ADJUST wheel to select filter parameters.

Set the three different categories as you desire and try out the proposed presets. The Reverb Wizard will show the name and number of the proposed preset.

Scroll through the presets using the ADJUST wheel and press OK to recall.

At first you might think of this feature as “too easy” or a feature for users less than professionals. Please don't! If the presets suggested by the Wizard are not the perfect choices in your opinion, they will at least give you a very good starting point.

I/O - THE SIGNAL PAGE

Press the I/O key to setup various I/O parameters.

Move the marker using the CURSOR keys and turn the ADJUST wheel to change values.

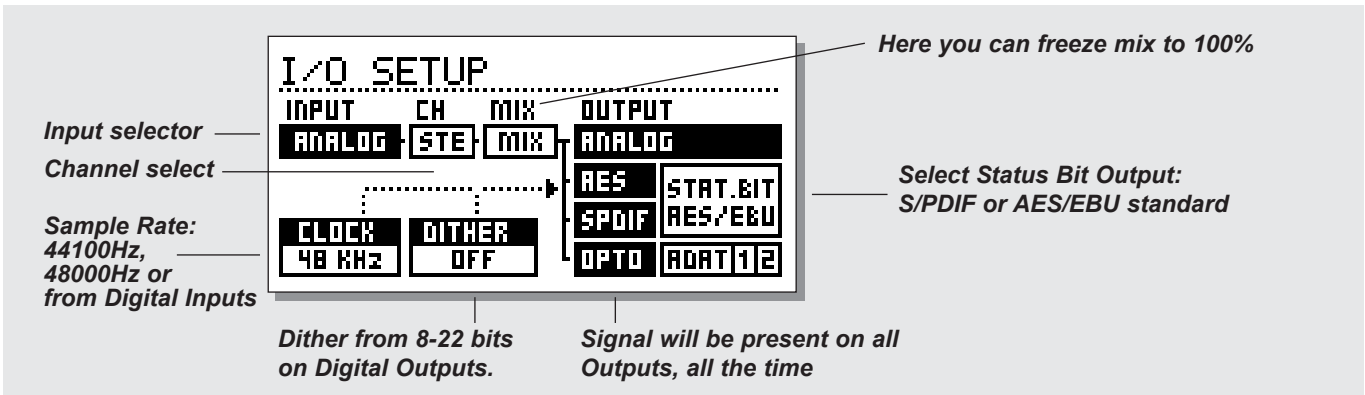

The Signal page

In the Signal page you select the Input source plus other features. Use the CURSOR keys to change cursor position, and the ADJUST wheel to change values.

Input

Select Input source Analog or Digital format.

AES/EBU - Digital AES/EBU can run up to 24 bits. Use the balanced XLR Digital Input/Output for this connection.

AES/EBU should run balanced 110 Ohm cables. If the “Digital” Sample Rate LEDs on the front panel are blinking, no clock is present or the M3000 cannot lock to the incoming Clock.

S/PDIF - S/PDIF are sometimes limited to 20 bits. All TC equipment output 24 bit on SPDIF outputs, and process 24 bit from SPDIF inputs. Use the RCA jacks Input/Output for this connection. S/PDIF should run unbalanced 75ohm cables. If the “Digital” Sample Rate LEDs on the front panel are blinking, no clock is present or the M3000 cannot lock to the incoming clock.

Tos-link - Optical Tos-link uses the S/PDIF Digital format. Use the Optical Input/Output for this connection. Tos-link uses fiberoptic cables. If the “Digital” Sample Rate LEDs on the front panel are blinking, no clock is present or the M3000 cannot lock to the incoming clock.

ADAT - When setting ADAT channels, use the CURSOR keys to change position and the ADJUST wheel to select channel number. It is possible to select two ADAT channels, process them and send them out on two different ADAT channels.

If the “Digital” Sample Rate LEDs on the front panel is blinking, no clock is present or the M3000 cannot lock to the incoming clock.

Note: The 4-6 unprocessed channels of the ADAT are not passed through the M3000.

Optical Thru

When the Optical parameter is set to Thru the Digital Input signal (DI) will pass directly and unprocessed to the Digital Output (DO).

Clock/Sample Rate

The Clock parameter determines what source the M3000 is using as Digital clock. The M3000 can use:

- Internal 44.1kHz
- Internal 48kHz
- Sync - the M3000 will lock to the incoming Digital Sample Rate (from the selected Digital Input) or the External Sync (word clock).
- Clock - which means that the M3000 is will lock to the selected input format.
- Digital - If AES/EBU or S/PDIF is selected as your Input source, the M3000 will automatically switch the Clock parameter to Digital.

The M3000 is capable of using its own internal clock while using audio from the Digital Input. This means that you can use the M3000 as master clock when working in a Digital setup. The M3000 will automatically switch to the appropriate clock when you select Input source.

Note: The External Sync Input recognizes standard Word Clock from 32kHz to 48kHz.

I/O - THE SIGNAL PAGE

The setting of MIX and CH (channel) parameters, combined with the selected Routing mode (see page 18-19), should be carefully considered to match the situation in which you use the M3000.

CH (Channel)

The Channel parameter selects which channels the M3000 are using for Input. The three possibilities are:

- Stereo (STE) - Signals on both Left and Right Input will be processed.
- Left Input (L) - Only the signal present on the Left Input will be processed.
- Right Input (R) - Only the signal present on the Right Input will be processed.

MIX

MIX - 100%. The Mix parameter of all presets will be 100%, meaning that no direct signal will pass through the M3000. The BYPASS keys will in this case work as mute in this case.

MIX - MIX. With this setting you can combine the dry signal with the effects. In this case the BYPASS key will work as a dry/wet switch.

Note: When the Engines are set to Serial Routing, the Mix parameter at Engine 1 will still be adjustable.

Status Bit

This selector changes the Channel Status bits of the Digital Output between professional and consumer format. When AES is selected, the M3000 will output the professional AES/EBU standard, and when S/PDIF is selected, the M3000 will output the S/PDIF consumer standard.

The default setting is AES/EBU but some Digital consumer products refuse to accept this professional standard. In that case change to the S/PDIF consumer standard.

Example: If you are using a non-professional DAT machine as a receiver of the M3000 Digital Output, and you cannot make it accept the Digital Input, change the Status bit Output format from AES/EBU to S/PDIF.

Note: The different Status Bit standards do not affect the quality of the Audio Output from the M3000.

Dither

The M3000 can output dither from 8 through 22 bit resolution to off. The dither type is TPDF (Triangular Probability Density Function).

The M3000 is using internal 24 bit resolution and 24 bit A/D-D/A converters and dither is therefore only present on the Digital Outputs. It is recommendable to avoid using dither until the final stage of a production.

Usually you would put the finishing touch on your production with a TC Finalizer. If this is the case dither should be applied with the Finalizer - not the M3000.

LEVELS MENU

Press the LEVELS key to access this menu.

To achieve optimal performance of the 24 bit A/D converters in the M3000, the correct setting of these levels is important. Please check the technical specifications of the connected device. The Input Peak meter should read approximately -6 to -3dB for maximum performance.

As illustrated below the Input/Output levels are displayed in dB as well as in two more visually oriented "bars".

The levels for the right and left channel can be adjusted individually or simultaneously.

Use the CURSOR keys to select either the L or R channel, and the ADJUST wheel to change value.

Placing the cursor between the L and the R enables you to adjust the left/right levels simultaneously.

Note! The Digital In level is capable of gaining +6dB.

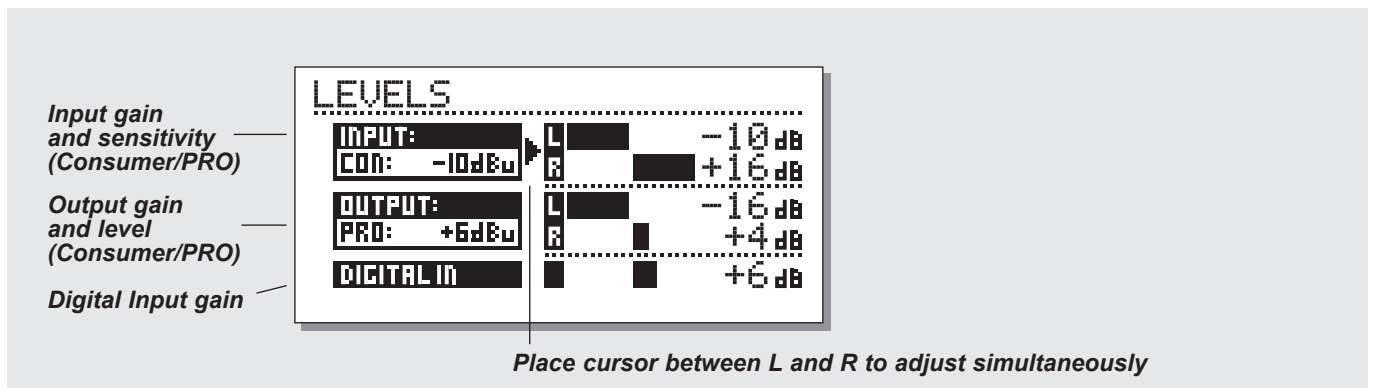

Ranges

Analog Inputs

Consumer range: -16dBu to +10dBu

Professional range: -6dBv to +16dBv

Analog Outputs

Consumer range: -10dBu to +16dBu

Professional range: -16dBv to +6dBv

Digital Input Level

Adjust the Digital Input from: -16dB to +6dB.

ROUTING

Press the **ROUTING** key in the "Setup section" to choose between six different routings. Use the **CURSOR** keys to select a new routing followed by the **OK** key to confirm your choice. A small pop-up window will tell you that the routing has changed.

Please note that how the selected Routing works, is highly affected by the settings of the **Channel** and **MIX** parameters in the I/O display. (Please see page 16).

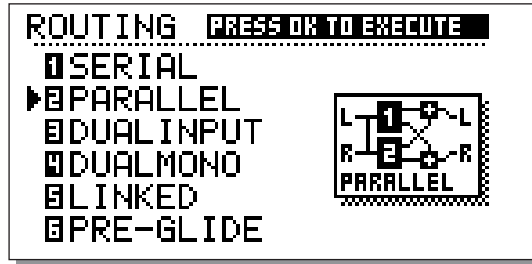
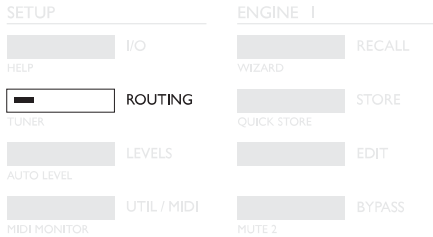

Serial



The serial mode is a stereo Input/Output routing. It gives you two independent effects in the same signal path. Please understand that the entire Output from Engine 1 is fed into the Input of Engine 2.



A common use of this particular routing could be selecting a De-esser; a Compressor or a Chorus in Engine 1 and a reverb or delay in Engine 2.

Parallel

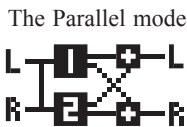

The Parallel mode is a stereo Input/Output routing. Both Engines will work as stereo effects and their Output will be mixed down to a stereo signal. With this routing, the M3000 can be used as two parallel effects on the same stereo source.

You may also set the I/O menu to left Input to get two independent stereo out effects on the M3000 from a single send on the mixer.

Dual Mono



Using this mode you actually split the M3000 into two independent mono effect units. Use left Input/Output to connect Engine 1, and right Input/Output to connect Engine 2.

Linked



When you select the Linked Routing, the two Engines will link together. This means that the preset in Engine 1 will be copied into Engine 2 and the Edit pages will lock together. The Linked Routing is indicated by the two EDIT LEDs which will be lit simultaneously. Left and Right channel audio paths are completely separated in this routing. Use this routing when you need e.g. two similar EQs, De-essers or Compressors.

ROUTING & STUDIO SETUP EXAMPLES

Dual Input (Split mode)



The Dual Input mode is a Dual Mono In/Stereo Out routing. Left In is always attached to ENGINE 1 and Right In is attached to ENGINE 2. Using this

routing enables you to get two different effects with separated Inputs; e.g. connect Aux 1 from your Mixer to Left In and Aux 2 to Right In. You now have access to two separate effects with a common stereo Output. Set the individual preset Output volumes to achieve the correct balance of the effects.

Preset Glide



When the Preset Glide Routing is selected, the M3000 will perform preset changes by crossfading the current effect and the new preset. This gives you a very smooth change of effects, e.g. allowing a Delay to keep repeating while a Chorus is being faded in.

The Glide time is located in the Utility menu (see UTIL/MIDI).

Note: Only one Engine is available while the M3000 is in the Preset Glide Mode.

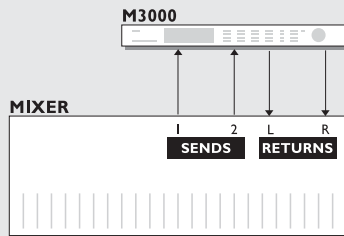

Use two sends on your mixing console

Dual Input mode

Recall two different effects. Try recalling a gated reverb for, let's say a snaredrum, in Engine 1 and a nice long hall type reverb for vocals in Engine 2. Using two different sends on your mixing console, you can now use the M3000 as two effect units sharing the same output. And - not to forget - you are saving a set of return channels.

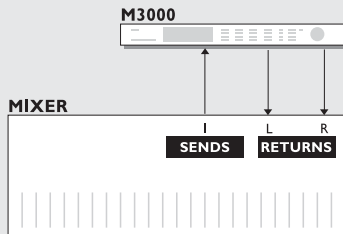

Create your own Vocal Reverb

Serial mode

You probably always wanted to have a long bright reverb on your lead vocal without “esses» hanging for seconds. You can do this with the M3000. You simply connect a “De-esser” and your favorite reverb in serial. The De-esser will cut away all sharp transients in the signal.

If you want your vocal to have a unique “live feel”, or the reverberated signal to be slightly detuned, simply connect the Pitch Shifter or Chorus in series with the reverb.

There are numerous applications in this mode - try them out.

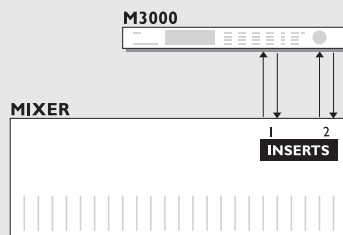

Two individual inserts on your mixing console

Dual Mono mode

In the Dual Mono mode you are able to use two completely separate mono effects at the same time. It can be Equalizers, Compressors, a De-esser or whatever you can imagine.

UTILITY

DISPLAY:

▶ Viewing Angle: 

PRESET GLIDE:

Glide Time : 1s

MIDI INPUT:

Channel : 1 2 3

Filter : PROG.ONLY

PrgOffset: 0 0 0

PrgBank : ROM1

SysEx ID : 1

MIDI OUTPUT:

Channel : 1 2 3

Filter : PROG.ONLY

PrgOffset: 0 0 0

SECURITY:

Security Lock:

Your PIN-CODE: 0

CARD:

Format Card :

MEMORY COPY:

Copy From:

RAM Start : 1

Card Start : 1

No of Presets: 200

Execute Copy :

Mem to MIDI :

EXTERNAL CONTROL IN

Function : Bypass 1+2

How to move around

In the UTIL/MIDI menu you always move by pressing the CURSOR keys and change values by dialing the ADJUST wheel.

Display

Viewing Angle:

Adjust for best contrast on the LCD display.

Preset glide:

Glide time

This parameter sets the Glide time of the incoming preset. The parameter is only active when Preset Glide routing is selected (See Routing on page 18).

In the MIDI section you are able to see the MIDI setup of both Engine 1, Engine 2 and the Combined section at the same time.

MIDI Input

Channel

Sets the Channel of which the current Engine will respond to. When set to Omni, the M3000 will respond to all channels. When set to Off, no MIDI will be received.

Filter

Sets whether the current section of the M3000 should respond to MIDI Control changes (CTRL) and MIDI Program changes (PROG) or not e.g. when Filter is set to PROG the M3000 will only respond to MIDI Program changes.

PrgOffset

With this parameter, you are able to add to or subtract from the incoming Program change; e.g. if the incoming Program change is 123, and the Offset is set to +1, the Program change will now be 124.

Program Bank Change

M3000 holds 500+100 presets. Standard MIDI Program changes range from 1-128. Therefore you must assign the incoming Program changes to one of the following banks:

| | | | |
|---------|---------|----------|----------|
| ROM 1 : | 1-128 | RAM 1 : | 1-128 |
| ROM 2 : | 129-256 | RAM 2 : | 129-250 |
| ROM 3 : | 257-384 | Card 1 : | 1-128 |
| ROM 4 : | 385-500 | Card 2 : | 129-250. |

When set to “external”, all banks can be accessed through the use of controller 0 which acts as bank selector.

Sys-Ex ID

Sets the Sys-Ex ID number of the M3000.

Note: The M3000 is always ready to receive information via MIDI dump from an external device. Be aware of this and avoid overwriting your presets by accident.

MIDI Output

Channel

Sets the sending MIDI channel of the M3000.

Filter

Sets whether the current section of the M3000 should send out MIDI Control changes (CTRL) and MIDI Program changes (PROG) or not. e.g. when Filter is set to PROG the M3000 will only send out MIDI Program changes.

Offset

With this parameter you are able to add to or subtract from the outgoing Program change. e.g. the outgoing Program change is preset 123, and the Offset is set to +1 the outgoing Program change will now be 124.

Security

Security Lock

Press OK while this parameter is selected to security lock the M3000. When locked, you will have to dial the PIN-Code shown below to access the M3000.

Your PIN-CODE

Set your own PIN-code for the Security lock by dialing the ADJUST wheel.

Note: If you should forget your PIN-code, please enter the Reset page (see page 54). This will release the M3000 from the locked state. (You do not have to run any of the reset functions).

Memory Backup

Format Card

This function will format and erase the inserted PCMCIA card. Press OK twice to confirm this action.

Warning: This action will overwrite ALL existing presets on the current card.

Memory Copy

Copy From

Decide where you want to copy from and to.

“Single to Card” copies from the Single preset RAM bank to the card. Card to Single copies the other way around. “Comb. to Card” copies from the Combined preset RAM bank to Card, and “Card to Comb.” copies the other way around.

RAM start

Select the preset number you want to start to copy from in the selected RAM bank (Single or Combined).

Card Start

Select the preset number you want to start to copy from to the card.

No of Presets

This parameter sets the number of presets to be copied

Execute Copy

Select this parameter and press OK twice to carry out the selected copy action.

Memory to MIDI

Press OK to dump the all presets to a MIDI device such as a sequencer.

External Control Input

When connecting a momentary pedal to the External Control Input, you can use it to control any one of four different features: Engine 1 Bypass, Engine 2 Bypass, Engine 1+2 Bypass, or Tap Tempo.

MIDI MONITOR & MIDI IMPLEMENTATION

»MIDI MONITOR SCREEN«

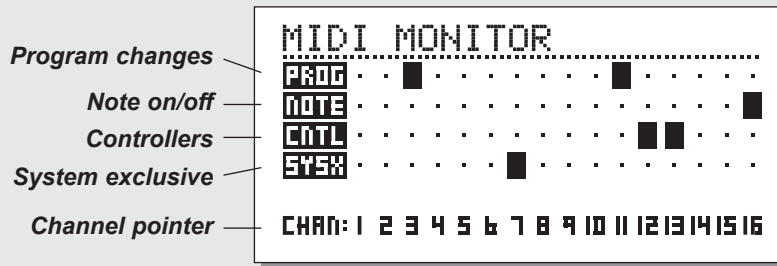

MIDI Monitor

Press **SHIFT** followed by **UTIL/MIDI** to access MIDI Monitor.

In the MIDI Monitor, you are able to see all MIDI messages received by the M3000. The actions are displayed according to the current channels.

| | |
|-------|------------------------------------|
| Prog. | Displays program changes. |
| Note | Displays Note On/Off. |
| Ctrl | Displays Control changes |
| Sys-x | Displays System exclusive commands |
| Chan | Displays the MIDI channels |

Press any key to exit MIDI Monitor.

II MIDI Implementation

The M3000 features full MIDI implementation giving you control of all parameters via an external MIDI controller.

For a complete list of MIDI controller numbers please visit our web site at www.tcelectronic.com and go to the download section.

This is useful in numerous situations. Here is a post production example showing you how to utilize the full MIDI implementation of the M3000.

Exercise 4:

Two persons have a conversation in an elevator. The elevator stops, and the two persons step out into a hall still talking. You want to use a preset with a short decay time for the "elevator-scene" and another with a longer decay time for the "hall-scene". To simulate the surroundings of the two rooms you

need two presets simulating the two rooms.

To simulate the transition between the rooms you wish to lower the Output of the first preset while increasing the Output of the second preset. For this scenario you can use a MIDI remote device with manual faders. E.g. a Peavey PC 1600.

- Use the M3000 in an aux. setup with a mixer.
- Use the Parallel or Dual Input routing mode.
- Press I/O to enter the I/O display and select Mix=100%
- Recall the presets you wish to use in the two Engines.
- Go to the MIDI input section in the UTIL/MIDI menu and select MIDI channel 1 for Engine 1 and MIDI channel 2 for Engine 2. (Any channels could be used).
- Setup the two faders you wish to use on the MIDI controller. Assign e.g. fader 1 to MIDI channel 1 and MIDI fader 2 to channel 2.
- The MIDI range on fader 1 should be: 127-70 and on Fader 2 the range should be set to: 70-127. Setting up the faders this way lets you decrease the Output of Engine 1 while increasing the Output of Engine 2. We found that for this specific operation the value of 70 gives a smooth cross-fade, but experiment with this setting according to your application.
- The MIDI controller number for the Output is 11 and therefore both faders should naturally be assigned to controller no. 11.

Now you can perform a manual smooth fade between the two engines that exactly applies the scenario.

TEMPO

Tapped or dialed BPM —
Which Engine to work on —
Define subdivision beat —

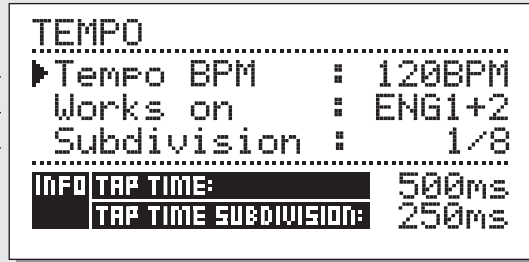

— *Tapped time in ms.*
— *Tapped time in ms.
corrected with
the subdivision factor.*

Tap Tempo

The M3000 TAP TEMPO key can control various parameters: Delay time, Decay time, Chorus speed, etc. When you press the TAP key, a Tempo menu pops up. The Tempo menu will disappear a few seconds after the last adjustment has been processed. The TAP key is attached to a default parameter in each effect type. This means that the function of the TAP key changes along with the presets. (See the default list later in this section).

The Tempo Menu

The tempo you tap is always measured in BPM (Beats Per Minute). The Tempo menu is able to recalculate the tapped time into subdivisions of the BPM. Simply set the Tempo menu to the Subdivision you like and tap the BPM on the TAP TEMPO key. You also have the possibility of changing the tempo using the BPM parameter in the Tempo menu. When a preset has been “Tapped”, the parameter attached to the Tap function will be displayed in BPM in the Tempo Menu.

Tempo BPM

The BPM will display the tapped tempo (BPM is equal to the 1/4 Subdivision). You can also set your tempo with this parameter using the ADJUST wheel.

Subdivision

Sets the subdivision of the tempo. If the subdivision is set to 1/8, the actual tempo will be twice as fast as the tapped time, etc.

The following subdivisions are possible:

1, 1/2, 1/4, 1/4T, 1/8, 1/8T, 1/16, 1/16T, 1/32, 1/32T
(T for triplets).

Tap/Subdivision

These are read only parameters displaying the Tapped time and the Subdivided time in milliseconds. Tap Time Subdivision is corresponding to the parameter in your preset.

The parameters controlled by the Tap key :

Reverb Decay parameter
Delay Delay time
Chorus Speed
Flanger Speed
Phaser Speed
Tremolo Speed



Press and hold TAP for 3 seconds to learn MIDI tempo (MIDI-Clock).

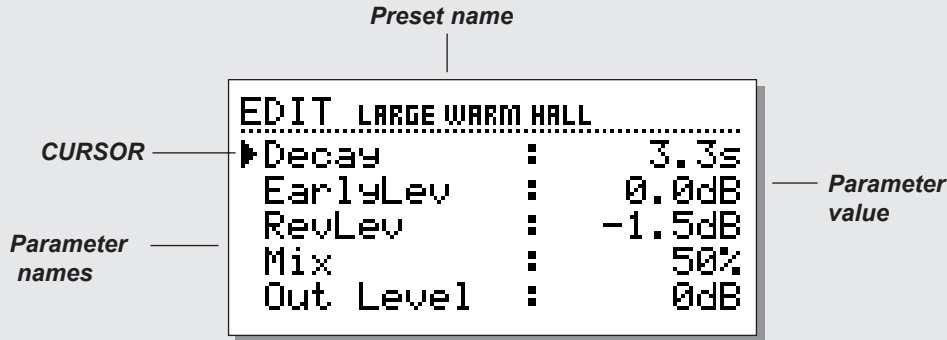

Edit

In the Edit display you use the CURSOR keys to select parameters and the ADJUST wheel to change values.

In the VSS™ algorithm presets there are two Edit modes: User and Expert.

Easy mode

The first time you edit a VSS™ preset, this is the mode you enter. The Easy mode holds the most important parameters such as Decay.

Expert mode

Select the Expert mode by placing the cursor at the Expert mode line and press OK.

The Expert mode allows you to edit a long variety of parameters, not available in the normal Edit mode.

Note: Since the two Edit modes are not compatible, it is not possible to return to the User Edit mode once you have stored a preset using the Expert mode.

Combined Edit

The relative Output levels of the two Engines can be adjusted in this display.

The range is: Off - 0.0dB.

These levels affect both the Analog and Digital Outputs.

The Output levels for Engine1 and 2 can be adjusted individually or simultaneously.

Use the CURSOR keys to select either Engine 1 or Engine 2, and the ADJUST wheel to change value.

Placing the cursor between the L and the R allows you to adjust the L/R levels simultaneously.

The Engine Out Levels are identical with the Out Level parameter in the Edit page and will always be corresponding with these.

Exercise 5 :

How to edit a preset

- Select Engine 1 by pressing its RECALL key. Use the ADJUST wheel and select ROM preset #2.
- Press the OK key to confirm and recall the preset.
- Press the EDIT key in the Engine 1 section. You are now in the User Edit mode.
- Use the CURSOR keys to select the parameter you wish to edit.
- Select e.g. Decay. Change the value using the VALUE key. Press the STORE key (still in the Engine 1 section), and select the location where you want the preset to be stored by turning the ADJUST wheel.
- Press OK to confirm. In this process you can also change the name of the preset (see the "Store" chapter on page 13).

DYNAMIC MORPHING

Engine Output levels [mix]

Dynamic Morphing section

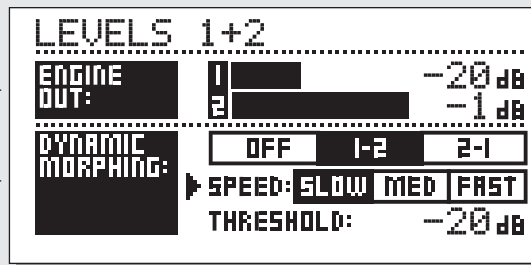

Engine Output levels

Morphing on/off and morphing direction

Morphing speed

Morphing Threshold

Dynamic Morphing

Press EDIT in the Combined section to enter Dynamic Morphing. The Dynamic Morphing function is a great new way of letting your effect interact with your source signal.

Note: The Dynamic Morphing function is only available when routing is set to Parallel.

When activated, the M3000 will morph between the two Engine Outputs according to your Input level. This is a function for quick seamless changes of an effect.

Imagine the situation where you have the vocal in a ballad being soft and subtle during the verse and then rising to heartbreaking heights in the Chorus. Now imagine the reverb automatically changing along with it, from a small discreet Room type in the verse, to a Big Bright Hall in the Chorus. This can be achieved by using Dynamic Morphing.

Simply select the two presets in the two Engines and then activate the Dynamic Morphing function. Set the Threshold and the speed of the Dynamic Morphing and check out the result.



Morph direction 1-2:

If this box is selected, Engine 1 will be active while the Input is below Threshold and Engine 2 when it's above.



Morph direction 2-1:

If this box is selected, Engine 2 will be active while the Input is below Threshold and Engine 1 when it is above.

Note! The max. level of the Engines is set by the Engine Out bars above Dynamic Morphing.

The Dynamic Morphing is stored along with Combined presets.

Constructing a Reverb Preset with the VSS™ algorithms

The following few paragraphs are thoughts about the usage of the VSS™ algorithm. They should be taken as guidelines rather than fact.

The relationship of Early Reflections and the Reverb tail is very important in this algorithm.

Adjusting the balance between the Early Lev and the Rev Lev parameters is one of the easier ways to make a HUGE difference in the sound of your reverb!

When you start building your preset you should try this:

- First turn the Rev Lev all the way down and then turn the MIX level up to between 60% and 70% if you are in mix mode, or push the return faders up on your console if you are in 100% wet mode (see I/O- The Signal Page on page15).
- Then begin changing the Early Type and Early Size parameters until you select a room shape that compliments the program material.
- Re-adjust the wet/dry balance until it is pleasing, then bring up the Rev Lev until the tail of the reverb becomes audible.
- Add just enough tail to make it work together.
- Adjust the Decay time accordingly.

On some presets you may choose to have very little Early Reflections or none at all.

Certain “ambience” style presets might have little or no “tail”. That is up to you.

The M3000 was designed to have the smoothest Reverb tail ever developed but it is the Early Reflections that define the “personality” of the room, so try to experiment with this relationship!

By using these parameters correctly you can create a BIG sound without having a mix swimming in reverb wash.

Note: When using small room sizes and short Decay times on percussive signals, the Reverb level and Early level must have an approx. level difference of 4dB in order to prevent a slap effect.

Getting the most out of the Early Reflection Patterns of the M3000

Early Reflections defines the actual feel of the room, where the Reverb tail is the less defined “bowl” of reflections that follows. The major part of the Early Reflection patterns of the M3000 are simulations of existing rooms and are based on a large number of reflections (40-100), which have been processed through an advanced algorithm.

There are a number of different types and sizes covering a lot of different acoustic spaces that you need for music and post production.

As the patterns are simulations of real rooms, the delay times of the first reflections are sonic and spatially “connected” to the direct signal. Using Pre Delay together with Early Reflections should therefore be considered very carefully, as the acoustic space created by the pattern tends to “collapse” if too much Pre Delay is added. If you want the well known slap back reverb effect, you should use Rev Delay on the Reverb tail instead and reduce the level of the Early Reflections.

Finding the right Early Type & Size for your track :

Select Early Type and Early Size in the Expert mode.

- Turn the Rev Level to -100dB.
- Turn the EarlyLevel to 0dB.
- Select an appropriate size. (Note that some sizes of the different types may overlap, e.g. Church Small is bigger than Conc Hall medium etc.)
- Switch between the different types until it matches the signal and the illusion that you wish to create.

Generally it is advisable to use small room sizes for drums and perc; medium sizes for piano, guitar & horns and large sizes for vocals & strings.

Large Church and Venue simulate very big rooms and can therefore be used to create an “echo like” effect if turned up loud.

Many of the patterns can be used as a “Doubling” effect if the Reverb tail is not added.

Using the Hi Color and Lo Cut parameter in the Early Reflection-Expert mode

Once you have selected the desired type and size you can use the Hi Color and the Lo Cut controls to filter the Early Reflections. The Hi Color parameter is an advanced Hi Cut function.

Please note that in most real rooms the reflections are generally much softer than the direct signal.

Often it can be advisable to use the Hi Color parameter in the range between -4 to -9 to make the Early Reflections blend properly with the direct signal rather than competing with it.

The Lo Cut filter is very useful if you want to reduce the Early Reflections in the area between 125-400Hz. Try this if the Early Reflections seem to make the sound too full.

To use the M3000 as a Stereo Reverb:

The VSS™ algorithm is basically a mono-input/stereo-output algorithm, but by using both Engines it is possible to turn the M3000 into an input/output Stereo Reverb.

To justify the entire discussion of stereo reverb the source material must derive from two points.

E.g. a grand piano would normally be miked up with two mics. When you hear the actual piano there will be a small delay due to the distance between the mics. To simulate this try the following example:

- select the same preset in both Engines.
- use approx. 10-20ms. of Pre Delay in Engine 1.
- use the same amount of Rev Delay in Engine 2.

This action is to ensure the Reverb tail has the same starting point in both Engines/channels.

- set the Mix parameter to 100% in the Edit menu of both Engines or select MIX=100% in the I/O section.
- use the Dual Input Routing.
- pan the Reverb in Engine 1 to the left, and the Reverb in Engine 2 to the right, using the RevBal parameter in the Expert mode.



Try out the Combined factory stereo presets no. 47 and 48, and investigate the parameter settings to learn more about using the M3000 as a Stereo Reverb.

VSS™ INTRODUCTION

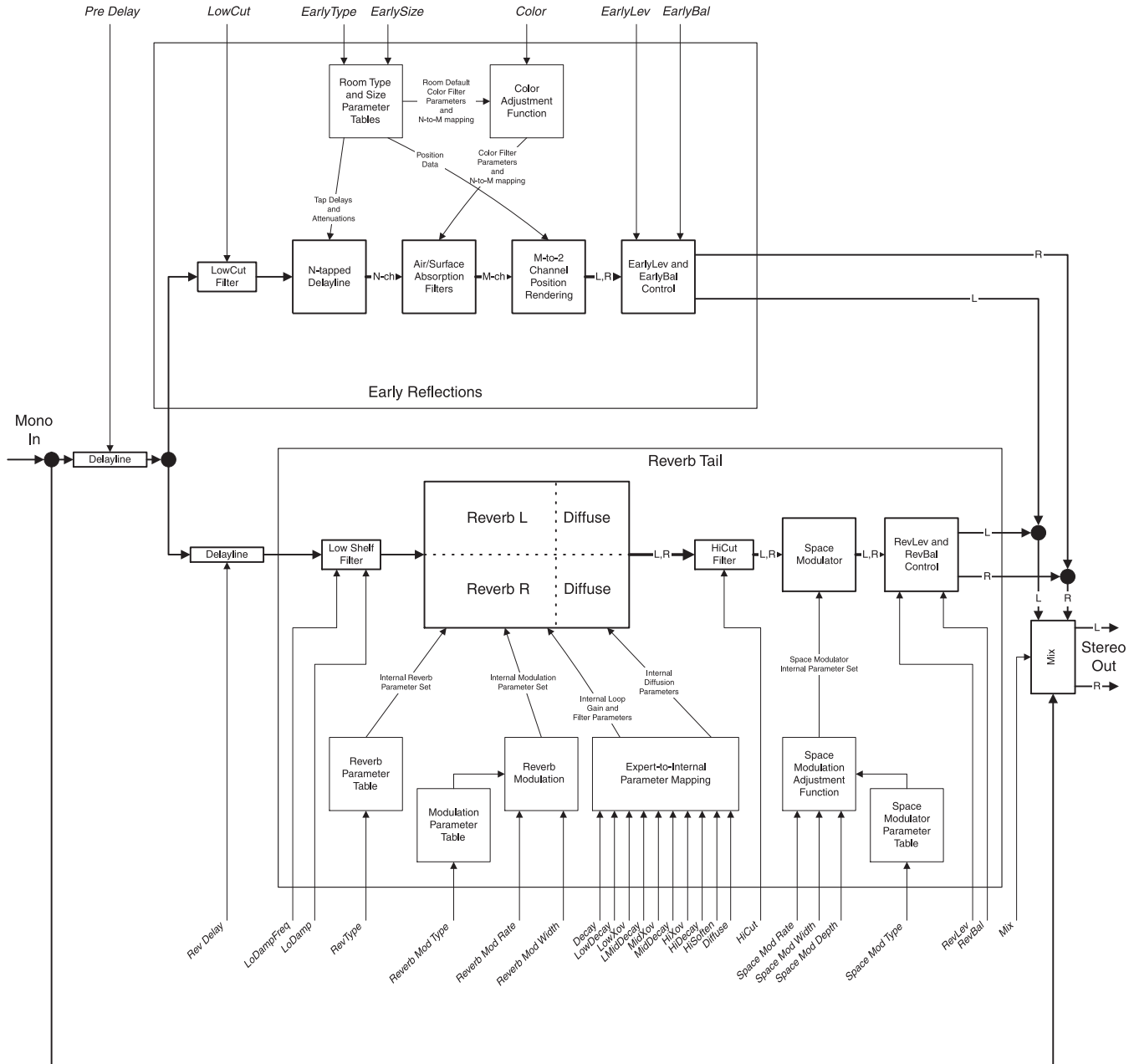

Overview of the VSS™ Reverb Section

On the opposite page you have a graphical overview of how the VSS™ Reverb algorithm is constructed. To fully utilize the possibilities of Early Reflections and the Reverb tail you should understand the relationship of these sections, and be able to control the most important parameters. As this is just an introduction on how to work the VSS™ Reverb we will only direct your attention to a few of the sections. For explanations of all the parameters you should refer to the complete algorithm descriptions on the following pages.

Please note that the illustration only covers one Engine. So the M3000 has two of the illustrated elements.

Hearing the terms "Early Reflections" and "Reverb tail", might lead you to believe that these two sections are placed in a line, with the Early Reflections first followed by the Reverb tail section. This is as you can see not the case. The two sections run parallel.

Pre Delay versus Rev Delay

The first two points we would like to bring to your attention is the Pre Delay and the Rev Delay. The Rev Delay moves the Reverb tail away from the source material. This is listed in many other reverb units as Pre Delay. In the M3000 the Pre Delay is the parameter that moves the entire Reverb section; Early Reflections as well as tail. We recommend using the Rev Delay as your first choice when moving the Reverb tail from the direct signal.

The Early Reflections take place in the first few hundred milliseconds and is what you hear before the more randomly calculated tail. Therefore the idea of delaying the Early reflections with the Pre Delay parameter should be carefully considered, and as the Early Reflection patterns are of a very complex and precisely calculated structure, adding too much Pre Delay can give you a feeling of less precision and might sound "out of phase".

Mixing the Reverb Out Levels

We recommend careful considerations concerning the level parameter on both the Early Reflections (Early Lev) and the Reverb tail (Rev Lev).

To emphasize either the Early Reflections or the Reverb tail, try setting the Early level and the Rev level with a difference of 6dB.

Modulation of the Reverb Tail

The M3000 is capable of producing an optimal precise clean Reverb tail. However in some situations you might experience that the tail is too clean/perfect. This is why we've added the modulation features. With Space Modulation and Reverb Modulation, you can tweak the tail in different directions. As shown in the illustration the Space Modulation is a separate block that works on the very Output of the Reverb, where the Reverb Modulation is an integrated part of the complex reverb calculations that works specifically on the tail.

VSS™ FOR FILM AND POST PRODUCTION

VSS™ FP & VSS™ SR

With the VSS™FP and VSS™SR algorithms for film- and post-production our main focus has been realistically sounding rooms, no matter how harsh, hard or grindy they sometimes are.

With standard Reverb units it has often been a tiresome and unsatisfying task in post production to match the sound of the room to the picture.

Once again, this is because the general main objective for Reverb units was to be able to create excellent sounding reverbs for musical production. Their focus has been the diffuse field of the Reverb rather than the important Early Reflections that define the sound of the room.

While developing the M3000 VSS™FP and VSS™SR algorithms; tests, analysis and measurements have been made in three dimensional models of different rooms, to obtain knowledge of the reflections. The results have been used to recreate all these reflections with the Early Reflection patterns.

To get a grip of the complexity of how the sound behaves at its initial stage, and why this cannot be ignored, please take a look at the illustrations below.

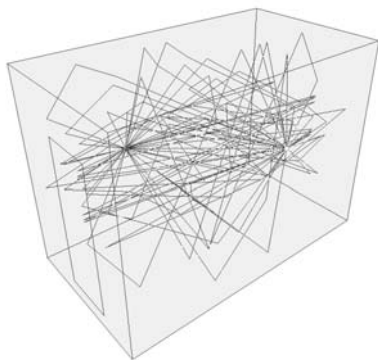

Bathroom

The drawing of the Bathroom is an example of a very small room with hard surfaces. The lines represent the complex reflections made by the sound source.

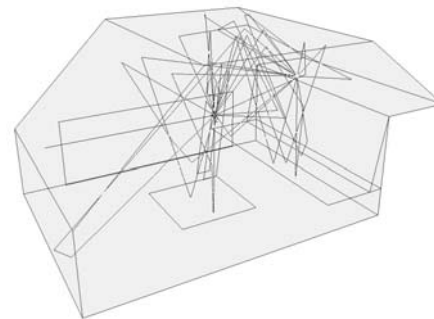

Car

A car is an example of the ultimate small room with both hard and soft surfaces, and extremely short distance between source and listener. The sound of this type of room has until today been very difficult to reproduce realistically. By using the VSS™FP in the M3000 high quality small room simulations are now extremely easy.

Stereo VSS™FP

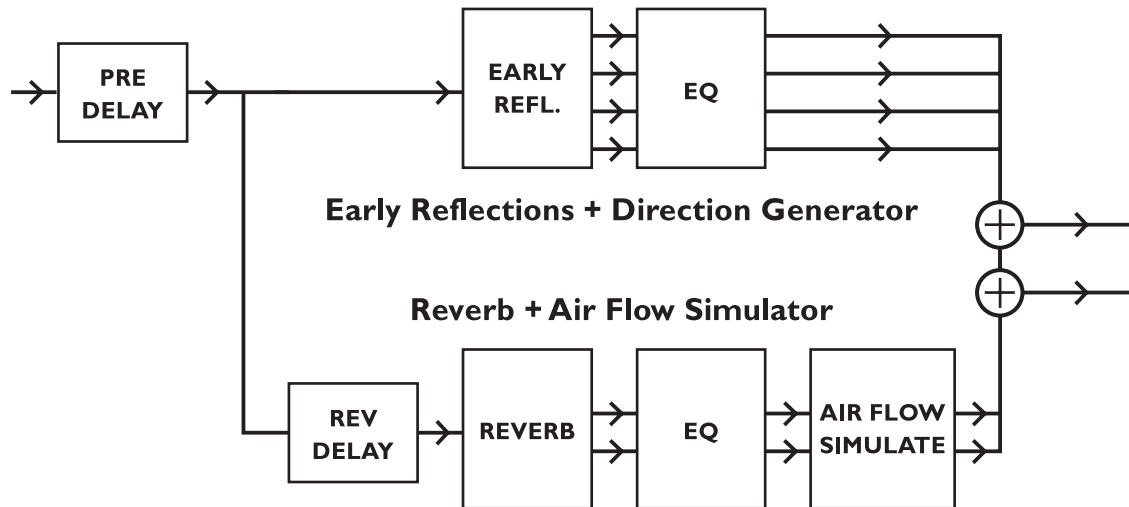

Diagram overview of the VSS™FP reverb with Early Reflection generator and stereo reverb generator in parallel.

For further details please see the illustration on page 28, and read the descriptions of the algorithms on the following pages.

VSS™SR - SURROUND

VSS™SR (Surround)

The VSS™SR (Surround) algorithm is a unique room simulator with new facilities for surround production. The diffused field of the simulation is turned into a Front/Rear composition with separate Decay, Level and Predelay parameters for front and rear. The composite output of the simulator is compatible with mono, stereo and surround reproduction. When used for surround production a surround encoder is not needed, but monitoring should be done through a Dolby SR compatible decoding system.

Surround VSS™SR

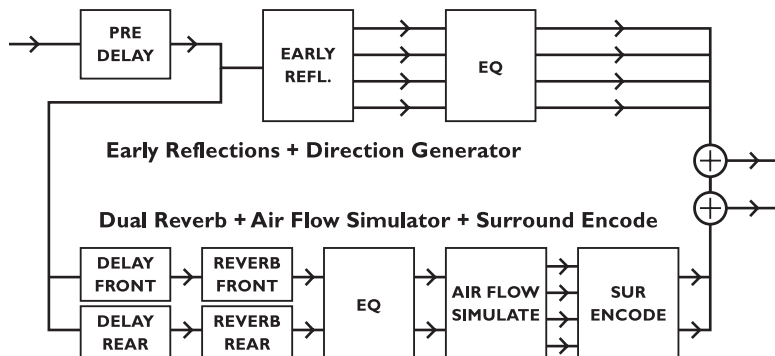

On top of the Early Reflections generator, each Engine may process two completely independent reverb systems, hereby enabling the operator to set separate Delay and Decay times in front and rear channels.

M3000 and Surround decoder setup.

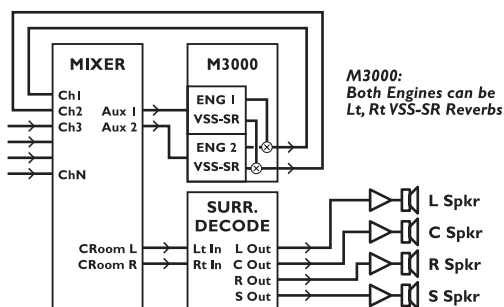

One or both M3000 engines may run VSS™SR surround algorithms. When monitored through a ProLogic™ or other 4:2:4 surround decoders, convincing surround environments are generated. The VSS™SR algorithm is fully mono and stereo compatible.

Reverb Programs

VSS™3, VSS™Gate, VSS™FP, VSS™SR, C.O.R.E. and Rev 3.

These are the basic reverb algorithms in the M3000.

VSS™3 Reverb

The VSS Reverb is a multipurpose algorithm, that with the comprehensive amount of parameters in both the Early Reflection parts; the Reverb tail and the Modulation, makes it possible to tweak the sound in a lot of different directions. The user interface is split into two levels: Easy mode, which gives access to the most common parameters, and the Expert mode with additional parameters available.

Decay

(.01 - 20s) The Decay time of the Reverb. Usually associated with the time it takes the Reverb tail to decay 60dB. This is the overall Master Decay for the four band Decay parameters (found in the REVERB section below) which are multiples of this base Reverb time.

Early Lev

(-100dB - 0dB) The Output level of the Early Reflections. When Early Lev is set all the way off, the Reverb effect will consist entirely of Reverb tail.

Rev Lev

(-100dB - 0dB) The Output level of the Reverb tail. When Rev Lev is set all the way off, the effect will consist entirely of Early Reflections.

Mix

(0% - 100%) Wet/Dry mix. Can be frozen at 100% on the I/O menu.

Out Level

(-100dB - 0dB) The overall Output level of the Reverb. This is mostly used when the two Engines are used in serial mode, or used in the Combined Mode.

Rev Delay

(0 - 200ms) A delay to the tail of the reverb. Adds additional time between the Early Reflections and the onset

of the "tail" of the reverb.

Pre Delay

(0 - 200ms) A delay placed at the Input of the algorithm. This sets how long after the dry sound the Early Reflections will begin.

Hi Color (available in easy mode only):

Adjusts the spectral balance in the high end frequencies. This is actually a simple way of adjusting a complex selection of frequencies.

Lo Color (available in easy mode only):

Adjusting the spectral balance in the low end frequencies. A simple way of adjusting a complex selection of frequencies.

Expert mode

Press OK to gain access to the following additional parameters. Note: Hi Color and Lo Color are not available in this mode.

Early Reflections

Early Type

(Several types) Pick the type that best compliments your material or best represents the effect you are going for.

Early Size

(Small, Medium, Large) Changes the size of the Early Type parameter.

Note: Some of the Early Types are only one size.

Early Bal

(-100dB R, Center, -100dB L) the left/right balance of the Early Reflections. Allows you to offset the Early Reflections from the normal center position.

Hi Color

(±50) Adjusts the spectral balance of the Early Type. The Color parameter is actually an advanced Hi Cut parameter. The default setting of this parameter is customized to each of the Early Types.

Lo Cut

(20Hz - 400Hz) This adjustable filter removes low frequencies for the Early Reflections.

Reverb (tail)

Rev Type

(Smooth, Natural, Alive, Fast St., Fast Wd.)

Adjust this parameter with the Early Lev turned all the way off and the Rev Lev all the way up. Change the type to get a feel of what each one sounds like.

Diffuse

(±50) This parameter gives you more or less diffusion than the algorithm designer intended for the given Decay time. For optimum performance the diffusion is automatically adjusted behind the scenes whenever you change decay times. This parameter gives you the added control to vary the diffusion around this automatic setting.

Rev Bal

(-100dB R, center, -100dB L) The left/right balance of the Reverb tail. Allows you to offset the tail from the normal center position.

Hi Cut

(1kHz - 20kHz) Rolls off the top end as it enters the Reverb tail. Used in conjunction with Hi Soften and Hi Decay to "darken" a room.

Hi Soften

(+/-50) Hi Soften is a special filter used to "soften" the high frequencies of Reverb tail. This is not a simple Hi Cut filter but a complex set of filters working together to remove those frequencies that make a reverb sound "brittle" or harsh sounding. Hi Soften is scaled/linked to the Hi Cut and Hi Decay parameters.

Hi Decay

(0.1 - 2.5) Multiplier for the frequencies above the Hi Xover frequency. Example: If the main Decay parameter is set to 2.0sec and the Hi Decay parameter is set to 1.5, frequencies above the Hi-Xover will decay for 3.0 sec. Conversely if this parameter is set to 0.5 the Decay time above the Hi Xover point will be 1 sec.

Hi Xover

(1kHz - 20KHZ) sets the frequency at which the transition from the mid frequencies to the high frequencies takes place.

Mid Decay

(0.01 - 2.5) The Ratio control multiplier for the mid frequencies. This parameter is normally set to 1.0 as it is the main parameter adjusted by the main Decay parameter. This mid-range decay control would normally be omitted, however, TC Engineers felt you could use this parameter as a fine adjustment tool to "tweak" a preset to sound just right without having to adjust the master Decay parameter.

Mid Xover

(200Hz - 2kHz) Sets the frequency at which the transition from the low-mid to the mid frequencies takes place.

Lo mid Decay

(0.1 - 2.5) The Ratio control multiplier for the low-mid frequencies

Lo Xover

(20Hz - 500Hz) Sets the frequency at which the transition from the low to the low-mid frequencies takes place.

Lo Decay

(0.1 - 2.5) The Ratio control multiplier for the low frequencies.

Lo Damp Freq

(20Hz - 200Hz) Sets the Lo Cut frequency for the next parameter, Lo Damp. Use these two parameters to take away any objectionable low frequencies entering the Reverb tail processor.

Lo Damp

(-18dB - 0dB) Sets the amount of cut in dBs. Used with the previous parameter, Lo Damp Freq.

Modulation

The Reverb Mod and the Space Mod work on the tail of the reverb and gives you the ability to tweak the tail in different ways.

To isolate and listen only to the tail you should turn the Early level off; set the mix to 100% and then turn the Depth parameter all the way up.

Try changing the Type of Modulation and listen to its effect on the tail. Be aware that by using extensive modulation of the tail you might get a detuning effect of the source material. In that case reduce the Width and Depth.

Reverb Mod

Type

(Off, Smooth 1, Smooth 2, Perc, Wow, Vintage, Wild)
Adjusts the type of modulation.

Rate

(-100, default, +100) Allows you to offset the speed of the LFO from the factory default assigned to each Type.

Width

(0% - 200%) Sets the Width of the modulation.

Space Mod

This group of parameters sets the way the sound moves about the room.

Type

(Off, Normal, Fast, Slow, MidFreq, Sync).

Rate

(-100, default, +100) Allows you to offset the speed of the LFO from the factory default assigned to each type.

Width

(0% - 100%) Sets the width of the modulation.

Depth

(-50, default, +50) Allows you to offset the amount of space modulation from the factory default.

VSS™ Gate

The VSS™ algorithm with Gate parameters added. The Gate function is very comprehensive, and opens up a lot of opportunities in combination with the reverb.

The user interface is split into two levels: Easy mode, which gives access to the most common parameters, and Expert mode with additional parameters available.

Threshold

When the Input signal falls below this Threshold, the Gate starts working. This means that the higher Threshold the more expansion you will get.

Attack

The Attack is the time that the Gate uses for bringing the reduced signal to 1:1, when the signal exceeds the Threshold.

Hold

Is the time that the Gate will keep the Ratio at 1:1 below the Threshold, before the Release time sets in.

Release

The Release time is the fallback time that the Gate uses to close.

Retrig

(On/off) When set to ON the gate works as a normal gate, when set to OFF the gate will run the whole “Attack, Hold, Release” time-cycle before it will be possible to retrigger the gate again. This feature is very useful when working with percussive material.

Gate Decay

(0.10 - 1.00) From the Release point, the gate takes down the Output level, but at the same time it's possible to roll-off the Decay Time in the tail (See the GateType parameter). This parameter is a multiplier on the Decay time that sets in from the start of the Release time. This allows you to “empty” the tail at the Release time so no leftovers are heard when the gate opens again.

Max Att

(0dB - 100dB) Max attenuation of the Gate.

Gate Type

(Level, Decay, Both) Selects what the Gate shall work on: Level takes down the Output level like a normal gate. Decay rolls off the Decay time according to the Gate Decay setting, but leaves the Output level unattached. Both will do Output level roll off and Decay roll off at the same time.

Decay

(0.01 - 20s) The Decay time of the Reverb. Usually associated with the time it takes the Reverb tail to decay 60dB. This is the overall Master Decay for the four band Decay parameters. (found in the REVERB section below) who are multiples of this base Reverb time.

Early Lev

(-100dB - 0dB) The Output level of the Early Reflections. When Early Lev is set to off the Reverb effect will consist entirely of Reverb “tail”.

Rev Lev

(-100dB - 0dB) The Output level of the Reverb tail. When Rev Lev is set all the way off the effect will consist entirely of early reflections.

Mix

(0% - 100%) Wet/Dry mix. Can be frozen at 100% on the I/O menu.

Out Level

(-100dB - 0dB) The overall Output level of the entire Reverb. This is mostly used when the two Engines are set in serial mode, or used in the Combined mode.

Rev Delay

(0 - 200ms) A delay to the tail of the Reverb. Adds additional time between the Early Reflections and the onset of the “tail” of the reverb.

Pre Delay

(0-200ms) A delay placed at the Input of the algorithm. This sets how long after the dry sound the Early Reflections will begin.

Hi Color (available in easy mode only)

Adjusts the spectral balance in the high end frequencies. This is actually a simple way of adjusting a complex selection of frequencies.

Lo Color (available in easy mode only)

Adjusts the spectral balance in the low-end frequencies. A simple way of adjusting a complex selection of frequencies.

Expert mode

Press OK to gain access to the following additional parameters.

Note: Hi Color and Lo Color is not available in this mode.

Early Reflections

Early Type

(Several types) Pick the type that best compliments your material or best represents the effect you are going for.

Early Bal

(-100dB R, center, -100dB L) The left/right balance of the Early Reflections. Allows you to offset the Early Reflections from the normal center position.

Color

(±50) Adjust the spectral balance of the Early Type.

Low Cut

(20Hz - 400Hz) This adjustable filter removes low frequencies for the Early Reflections.

Reverb (tail)

Rev Type:

(Smooth, Natural, Alive) Adjust this parameter with the Early Lev turned all the way off and the Rev Lev all the way up. Change the type to get a feel for what each one sounds like.

Diffuse:

(±50) This parameter gives you more or less diffusion than the algorithm designer intended for the given Decay time. For optimum performance the diffusion is automatically adjusted behind the scenes whenever you change decay times. This parameter gives you the added control to vary the diffusion around this automatic setting.

RevBal:

(-100dB R, center, -100dB L) The left/right balance of the Reverb tail. Allows you to offset the tail from the normal center position.

Hi Cut:

(1kHz - 20kHz) Rolls off the top end as it enters the Reverb tail. Used in conjunction with Hi Soften and Hi Decay to “darken” a room.

Hi Soften:

(+/-50) Hi soften is a special filter used to “soften” the high frequencies of Reverb tail. This is not a simple high cut filter but a complex set of filters working together to remove those frequencies that make a reverb sound “brittle” or harsh sounding. Hi Soften is scaled/linked to the Hi Cut and Hi Decay parameters.

Hi Decay:

(0.01 - 2.5) Multiplier for the frequencies above the Hi Xover frequency. Example: If the main Decay parameter is set to 2.0sec and the Hi Decay parameter is set to 1.5, frequencies above the Hi Xover will decay for 3.0sec. On the other hand if this parameter is set to 0.5 the decay time above the Hi-Xover point will be 1sec.

Hi Xover:

(1kHz - 20KHZ) Sets the frequency at which the transition from the mid frequencies to the high frequencies takes place.

Mid Decay:

(0.01 - 2.5) The Ratio control multiplier for the mid frequencies. This parameter is normally set to 1.0 as it is the main parameter adjusted by the main Decay parameter. This midrange Decay control would normally be omitted, however TC Engineers felt you could use this parameter as a fine adjustment tool to “tweak” a preset to sound just right without having to adjust the master Decay parameter.

Mid Xover:

(200Hz - 2kHz) Sets the frequency at which the transition from the low-mid to the mid frequencies takes place.

Lmid Decay:

(0.01 - 2.5) The Ratio control multiplier for the low-mid frequencies.

Low Xover:

(20Hz - 500Hz) Sets the frequency at which the transition from the low to the low-mid frequencies takes place.

Low Decay:

0.01 - 2.5) The Ratio control multiplier for the low frequencies.

Lo Damp Freq:

(20Hz - 200Hz) Sets the Lo Cut frequency for the next parameter, Lo Damp. Use these two parameters to take away any objectionable low frequencies entering the Reverb tail processor.

Lo Damp:

(-18dB - 0dB) Sets the amount of cut in dB. Used with the previous parameter, Lo Damp Freq.

Reverb Modulation

Type:

(Off, Smooth1, Smooth2, Perc, Wow, Vintage, Wild)
Adjusts the type of modulation. Try all of them. First turn the Depth all the way up and turn the Early Lev off and the MIX to 100% so you are only listening to the tail of the verb. Then change the Type of Mod and listen to its affect on the tail. Pick the one you like if you are going for that “Famous Sound”. Sounds cool but beware the tuning of the instruments can get a little strange. Listen on a grand piano to hear the changes, back off if the detuning gets too strange.

Rate:

(-100, default, +100) Allows you to offset the speed of the LFO from the factory default assigned to each type.

Width:

(0% - 200%) Sets the width of the modulation.

VSS™ FP

The VSS™FP (Film & Post-Production) reverb algorithm is a special version of VSS™3, incorporating dedicated Early Reflection types for motion picture use, e.g. Car, Bathroom and Conference Rooms.

VSS™ FP Reverb

Decay

(0.01 - 20s) The Decay time of the Reverb. Usually associated with the time it takes the Reverb tail to decay 60dB. This is the overall Master Decay for the four band Decay parameters (found in the REVERB section below) which are multiples of this base Reverb time.

Hi Color (available in easy mode only)

Adjusts the spectral balance in the high end frequencies. This is actually a simple way of adjusting a complex selection of frequencies.

Lo Color (available in easy mode only)

Adjusting the spectral balance in the low end frequencies. A simple way of adjusting a complex selection of frequencies.

Position (available in easy mode only)

Changes the distance from the listener to the source. The characteristics of the room are preserved, only the perceived distance changes.

Note: To obtain the intended effect, please do not use a 100% wet mix, but include some dry signal.

Early Lev

(-100dB - 0dB) The Output level of the Early Reflections. When Early Lev is set to off the Reverb effect will consist entirely of Reverb "tail".

Rev Lev

(-100dB - 0dB) The Output level of the Reverb tail. When Rev Lev is set all the way off, the effect will consist entirely of Early Reflections.

Rev Delay

(0 - 200ms) A delay to the tail of the reverb. Adds additional time between the Early Reflections and the onset of the "tail" of the reverb.

Pre Delay

(0 - 100ms) A delay placed at the Input of the algorithm. This sets how long after the dry sound the Early Reflections will begin.

Mix

(0% - 100%) Wet/Dry mix. Can be frozen at 100% on the I/O menu.

Out Level

(-100dB - 0dB) The overall Output level of the Reverb. This is mostly used when the two Engines are used in serial mode, or used in the Combined Mode.

Expert mode

Press OK to gain access to the following additional parameters.

Note: Hi Color, Lo Color and Position are not available in this mode.

Early Reflections

Early Type

(Several types)

Pick the type that best compliments your material or best represents the effect you are going for.

Early Size

(Small, Medium, Large)

Changes the size of the Early Type parameter.

Note: Some of the Early Types are only one size.

Early Pos

Here you can select between a Close and a Distant setting. This enables you to change the distance between the listening position and the source in the same Early Reflection pattern. Note that some of the Early Types only have one position available.

Early Bal

(-100dB R, Center, -100dB L) the left/right balance of the Early Reflections. Allows you to offset the Early Reflections from the normal center position.

Hi Color:

Adjusts the spectral balance in the high end frequencies. This is actually a simple way of adjusting a complex selection of frequencies.

Low Cut

(20Hz - 400Hz) This adjustable filter removes low frequencies for the Early Reflections.

Reverb Tail

Rev Type

(Smooth, Natural, Alive, Fast, Fast Wd, Alive Wd)
Adjust this parameter with the Early Lev turned all the way off and the Rev Lev all the way up. Change the type to get a feel of what each one sounds like.

Rev Width

With this parameter you can change the width of the reverb tail. The Mono setting is where the left and right reverb tails are completely identical, the Center setting opens a bit up in the middle, Stereo is the normal stereo image width and Wide are on the outside of the stereo image.

Note: The RevTypes: Fast Wd and Alive Wd only have one width (extremely wide).

Diffuse

(±50) This parameter gives you more or less diffusion than the algorithm designer intended for the given Decay time. For optimum performance the diffusion is automatically adjusted behind the scenes whenever you change decay times. This parameter gives you the added control to vary the diffusion around this automatic setting.

Rev Bal

(-100dB R, center, -100dB L) The left/right balance of the Reverb tail. Allows you to offset the tail from the normal center position.

Hi Cut

(20Hz-20kHz) Rolls off the top end as it enters the Reverb tail. Used in conjunction with Hi Soften and Hi Decay to "darken" a room.

Hi Soften

(+/-50) Hi Soften is a special filter used to "soften" the high frequencies of Reverb tail. This is not a simple Hi Cut filter but a complex set of filters working together to remove those frequencies that make a reverb sound "brittle" or harsh sounding. Hi Soften is scaled/linked to the Hi Cut and Hi Decay parameters.

Hi Decay

(0.01 - 2.5) Multiplier for the frequencies above the Hi Xover frequency. Example: If the main Decay parameter is set to 2.0sec and the Hi Decay parameter is set to 1.5, frequencies above the Hi-Xover will decay for 3.0 sec. Conversely if this parameter is set to 0.5 the Decay time above the Hi Xover point will be 1 sec.

Hi Xover

(500Hz - 20KHZ) sets the frequency at which the transition from the mid frequencies to the high frequencies takes place.

Mid Decay

(0.01 - 2.5) The Ratio control multiplier for the mid frequencies. This parameter is normally set to 1.0 as it is the main parameter adjusted by the main Decay parameter. This mid-range decay control would normally be omitted, however, TC Engineers felt you could use this parameter as a fine adjustment tool to "tweak" a preset to sound just right without having to adjust the master Decay parameter.

Mid Xover

(200Hz - 2kHz) Sets the frequency at which the transition from the low-mid to the mid frequencies takes place.

Lo mid Decay

(0.01 - 2.5) The Ratio control multiplier for the low-mid frequencies

Lo Xover

(20Hz - 500Hz) Sets the frequency at which the transition from the low to the low-mid frequencies takes place.

Lo Decay

(0.01 - 2.5) The Ratio control multiplier for the low frequencies.

Lo Damp Freq

(20Hz - 200Hz) Sets the Lo Cut frequency for the next parameter, Lo Damp. Use these two parameters to take away any objectionable low frequencies entering the Reverb tail processor.

Lo Damp

(-18dB - 0dB) Sets the amount of cut in dBs. Used with the previous parameter, Lo Damp Freq.

Modulation

The Reverb Mod and the Space Mod work on the tail of the reverb and give you the ability to tweak the tail in different ways.

To isolate and listen only to the tail you should turn the Early level off; set the mix to 100% and then turn the Depth parameter all the way up.

Try changing the Type of Modulation and listen to its effect on the tail. Be aware that by using extensive modulation of the tail you might get a detuning effect of the source material. In that case reduce the Width and Depth.

Reverb Mod

Type

(Off, Smooth 1, Smooth 2, Perc, Wow, Vintage, Wild)
Adjusts the type of modulation.

Rate

(-100, default, +100) Allows you to offset the speed of the LFO from the factory default assigned to each Type.

Width

(0% - 200%) Sets the Width of the modulation.

Space Mod

This group of parameters sets the way the sound moves about the room.

Type

(Off, Normal, Fast, Slow, MidFreq, Sync).

Rate

(-100, default, +100) Allows you to offset the speed of the LFO from the factory default assigned to each type.

Width

(0% - 100%) Sets the width of the modulation.

Depth

(-50, default, +50) Allows you to offset the amount of space modulation from the factory default.

VSS™SR (Surround)

The VSS™SR (Surround) algorithm is a unique room simulator with new facilities for surround production. The diffused field of the simulation is turned into a Front/Rear composition with separate Decay, Level and Predelay parameters for front and rear.

The composite output of the simulator is compatible with mono, stereo and surround reproduction.

When used for surround production a surround encoder is not needed, but monitoring should be done through a Dolby SR compatible decoding system.

Front Decay

(0.01 - 20) Changes the Decay time at the mono information in the signal.

Rear Decay

(0.01 - 20) Changes the Decay time at the stereo information in the signal.

Front Level

(-10dB - 0dB) Changes the level of the Front/center information in the signal.

Rear Level

(-10dB - 0dB) Changes the level of the Rear/surround information in the signal.

Early Lev

(-100dB - 0dB) The Output level of the Early Reflections. When Early Lev is set all the way off, the Reverb effect will consist entirely of Reverb tail.

Hi Color (available in easy mode only)

Adjusts the spectral balance in the high frequencies. This is actually a simple way of adjusting a complex selection of frequencies.

Lo Color (available in easy mode only)

Adjusting the spectral balance in the low frequencies. A simple way of adjusting a complex selection of frequencies.

Front Delay

(0 - 200ms) Changes the reverb feed delay time of the Front/center information in the signal.

Rear Delay

Changes the reverb feed delay time of the Rear/surround information in the signal.

Pre Delay

(0 - 100ms) A delay placed at the Input of the algorithm. This sets how long after the dry sound the Early Reflections will begin.

Mix

(0% - 100%) Wet/Dry mix. Can be frozen at 100% on the I/O menu.

Out Level

(-100dB - 0dB) The overall Output level of the Reverb. This is mostly used when the two Engines are used in serial mode, or used in the Combined Mode.

Expert mode

Press OK to gain access to the following additional parameters.

Note: Hi Color and Lo Color are not available in this mode.

Early Reflections

Early Type

(Several types) Pick the type that best compliments your material or best represents the effect you are going for.

Early Size

(Small, Medium, Large) Changes the size of the Early Type parameter.

Note: Some of the Early Types are only one size.

Early Pos

Here you can select between a Close and a Distant setting. This enables you to change the distance between the listening position and the source in the same Early Reflection pattern. Note that some of the Early Types only have one position available.

Early Bal

(-100dB R, Center, -100dB L) the left/right balance of the Early Reflections. Allows you to offset the Early Reflections from the normal center position.

Hi Color

(±50) Adjusts the spectral balance of the Early Type.

The Hi Color parameter is actually an advanced Hi Cut parameter. The default setting of this parameter is customized to each of the Early Types.

Lo Cut

(20 - 400Hz) This adjustable filter removes low frequencies for the Early Reflections.

Reverb Tail

Rev Type

(Smooth, Natural, Metal, Fast, Fast WD) Adjust this parameter with the Early Lev turned all the way off and the Rev Lev all the way up. Change the type to get a feel of what each one sounds like.

Rev Depth

With this parameter you can change the depth of the reverb tail.

Diffuse

(±50) This parameter gives you more or less diffusion than the algorithm designer intended for the given Decay time. For optimum performance the diffusion is automatically adjusted behind the scenes whenever you change decay times. This parameter gives you the added control to vary the diffusion around this automatic setting.

Hi Cut

(20 - 20kHz) Rolls off the top end as it enters the Reverb tail. Used in conjunction with Hi Soften and Hi Decay to "darken" a room.

Hi Soften

(+/-50) Hi Soften is a special filter used to "soften" the high frequencies of Reverb tail. This is not a simple Hi Cut filter but a complex set of filters working together to remove those frequencies that make a reverb sound "brittle" or harsh sounding. Hi Soften is scaled/linked to the Hi Cut and Hi Decay parameters.

Hi Decay

(0.01 - 2.5) Multiplier for the frequencies above the Hi Xover frequency. Example: If the main Decay parameter is set to 2.0 sec and the Hi Decay parameter is set to 1.5, frequencies above the Hi-Xover will decay for 3.0 sec. Conversely if this parameter is set to 0.5 the Decay time above the Hi Xover point will be 1 sec.

Hi Xover

(500Hz - 20kHz) sets the frequency at which the transition from the mid frequencies to the high frequencies takes place.

Mid Decay

(0.01 - 2.5) The Ratio control multiplier for the mid frequencies. This parameter is normally set to 1.0 as it is the main parameter adjusted by the main Decay parameter. This mid-range decay control would normally be omitted, however, TC Engineers felt you could use this parameter as a fine adjustment tool to "tweak" a preset to sound just right without having to adjust the master Decay parameter.

Mid Xover

(200Hz - 2kHz) Sets the frequency at which the transition from the low-mid to the mid frequencies takes place.

Lo mid Decay

(0.01 - 2.5) The Ratio control multiplier for the low-mid frequencies

Lo Xover

(20Hz - 500Hz) Sets the frequency at which the transition from the low to the low-mid frequencies takes place.

Lo Decay

(0.01 - 2.5) The Ratio control multiplier for the low frequencies.

Lo Damp Freq

(20Hz - 200Hz) Sets the Lo Cut frequency for the next parameter, Lo Damp. Use these two parameters to take away any objectionable low frequencies entering the Reverb tail processor.

Lo Damp

(-18dB - 0dB) Sets the amount of cut in dBs. Used with the previous parameter, Lo Damp Freq.

Reverb Mod

Type

(Off, Smooth 1, Smooth 2, Perc, Wow, Vintage, Wild)

Adjusts the type of modulation.

Rate

(-100, default, +100) Allows you to offset the speed of the LFO from the factory default assigned to each Type.

Width

(0% - 200%) Sets the Width of the modulation.

Space Mod

This group of parameters sets the way the sound moves about the room.

Type

(Off, Normal, Fast, Slow, MidFreq, Sync).

Rate

(-100, default, +100) Allows you to offset the speed of the LFO from the factory default assigned to each type.

Width

(0% - 100%) Sets the width of the modulation.

Depth

(-50, default, +50) Allows you to offset the amount of space modulation from the factory default.

C.O.R.E.

The C.O.R.E. algorithm is a well-known TC Reverb from the M5000, and is very good on short to medium decay times. C.O.R.E. has all parameters present at first layer (meaning no Expert mode).

Try e.g. presets 69, 89 and 189 to experience the C.O.R.E. algorithm.

Decay

Sets the Decay time. The value indicates the time to where the Reverb tail is damped to -60dB.

Early Level

Sets the Early Reflection level.

Reverb Level

Level of the Reverb tail.

Mix

Mix between direct and effect.

Out Level

Adjusts Output level. Use this parameter to match levels between presets.

Rev Delay

Determines how fast the reverberation will build up.

Pre Delay

The time to arrival of the first reflection.

Reflections

Room shape

Here you can choose between different room shapes. Changing the room shape will change the Early Reflections.

Size

Size multiplication factor. With this parameter you can change the size of the room. Only the Early Reflections are influenced by this factor.

Rev diff 1

Imposes the characteristics of the Early Reflections on the later reverberation.

Rev diff 2

Imposes the characteristics of the Early Reflections on the later reverberation.

Rev width

This parameter adjusts the stereo width of the Reverb tail.

Hi Cut level

Damping Ratio in dB of the Hi Cut filter.

Hi Damp

(0.01 - 2.5) Multiplier for the frequencies above the Hi Crossover frequency. Example: If the main Decay parameter is set to 2.0sec and the Hi Decay parameter is set to 1.5, frequencies above the Hi Xover will decay for 3.0sec. Conversely if this parameter is set to 0.5 the Decay time above the Hi Xover point will be 1sec.

Hi Decay

Adjusts the high frequency reverberation time.

Hi Crossover

Crossover frequency between mid and high band reverberation filter.

Lo Decay

Adjusts the low frequency reverberation time.

Lo Crossover

Crossover frequency between low and mid band reverberation filter.

Rev-3 :

Reverb 3 is a well known TC algorithm from the M5000, and is very good at medium decay times. Rev-3 has all parameters present in the first layer (meaning no Expert mode). Try e.g. presets 77, 81, 83 and 84 to experience the Rev-3 algorithm.

Pre Delay

The time to arrival of the first reflection.

Decay

Sets the Decay time. The value indicates the time to where the Reverb tail is damped to -60dB.

Distance

The relative distance control varies the mix relations between early and later reflections. Simulating how far away you are from the sound source.

Mix

Mix between direct and effect.

Out Level

Adjusts Output level. Use this parameter to match levels between presets.

Diffuser type

The natural room mode peak frequencies and the smoothness of the tail are affected by this parameter.

Diffuse

This parameter sets the degree of wall diffusion. Increasing the value will result in a more dense Reverberation tail. Do not set the value too high, as it will result in an unnatural sounding Reverberation tail.

Hi Cut freq.

Sets the cut-off frequency of the Hi Cut filter.

Hi Damp

(0.01 - 2.5) Multiplier for the frequencies above the Hi Crossover frequency. Example: If the main Decay parameter is set to 2.0sec. and the Hi Decay parameter is set to 1.5, frequencies above the Hi Xover will decay for 3.0sec. Conversely if this parameter is set to 0.5 the Decay time above the Hi Xover point will be 1sec.

Hi Decay

Adjusts the high frequency Reverberation time.

Hi Crossover

Crossover frequency between mid and high band Reverberation filter.

Mid Crossover

Crossover frequency between low-mid and high-mid band Reverberation filter.

Lo Mid Decay

Adjusts the mid frequency Reverberation time.

Lo Crossover

Crossover frequency between low and mid-band Reverberation filter.

Lo Decay

Adjusts the low frequency Reverberation time.

Modulation

Rate

The Mod Rate varies the Rate of modulation of the recirculating delay paths simulating the Reverb tail.

Depth

Controls the amount of Delay Path Modulation or “wander” in the reverb.

ADDITIONAL EFFECTS - DELAY & PITCH

Delay

The Delay presets are capable of performing up to 1350ms delay. The Feedback filters make it possible to control both high and low frequency feedback.

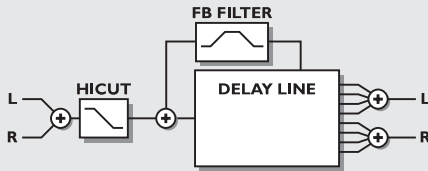

Delay time

Controls the length of delay time.

Feedback

Controls the amount of effect signal routed back to the Input.

Hi Cut Freq

Feedback Hi Cut-off frequency. Signal is damped 6dB/oct above this frequency.

Hi Cut Level

Sets maximum depth of cut above the Hi Cut shelving frequency.

Hi Cut Freq (Feedback filter)

Hicut shelving type filter (-6dB/oct) at the feedback loop.

Lo Cut Freq (Feedback filter)

Locut shelving type filter (-6dB/oct) at the feedback loop.

Mix

Mix between direct signal and effect.

Out Level

Adjusts Output level. Use this parameter to match levels between presets.

Pitch

The Pitch presets are capable of performing 6 pitched Voices at the same time. This makes it possible to produce a true Chorus effect.

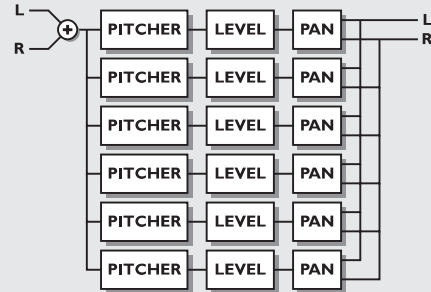

Voice

Sets which voice you are editing.

Pitch

Sets the pitch of the current Voice (0-1200).

Level

Sets the level of the current Voice.

Pan

Sets the panning of the current Voice.

Delay

Sets the delay of the current Voice.

Mix

Mix between direct signal and effect.

Out Level

Adjusts Output level. Use this parameter to match levels between presets.

ADDITIONAL EFFECTS - EQ

EQ

The EQ programs are all 3 band parametric types with separate high and low shelving bands.



Frequency

Low shelving filter ranging from 20Hz to 5kHz.

High shelving filter ranging from 500Hz to 20kHz.

Three band filters ranging from 20Hz to 20kHz.

Band width

Low and high shelving filters have 2 different slopes.

The bandwidth of the 3 bandfilters are:

- 1) 0.10 octave
- 2) 0.63 octave
- 3) 4.00 octaves

Level

All filters range +/-12dB.

EQ level

Adjustable +/-12dB.

ADDITIONAL EFFECTS - CHORUS & FLANGER

Chorus

These presets are capable of producing a smooth natural sounding stereo Chorus effect. The Hi Cut filter gives you the ability to make the Chorus very warm.

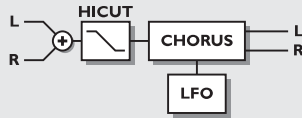

Speed

The speed of the Chorus, also known as Rate.

Depth

Adjusts the depth of the Chorus, also known as Intensity.

Delay

As described earlier, a Chorus/Flanger is basically a Delay being modulated by an LFO. This parameter makes it possible to change the length of that Delay. A typical Chorus uses delays at approximately 10ms, while a Flanger uses delays at around 5ms.

Mix

Mix between direct sound and effect.

Out level

Adjusts the Output level of the Chorus.

Golden ratio

Sets the Golden Ratio between Speed and Depth On/Off. If you want to create wild Chorus sounds you may want to turn the Golden Ratio off.

Phase Reversed

Reverses the phase of the right channel, but only on the effect signal. This function makes the stereo image much wider.

LFO Curve

Sets the curve of the LFO. Choose between Sine or Triangle. The most commonly used waveform in Chorus is Sine. (see curve figures in Tremolo).

LFO Phase

An LFO phase change causes a small delay in one of the waveform starting points. This means that left and right Outputs start the current waveform at two different points. Example: If LFO phase is set to 180°, left and right will be exactly opposite.

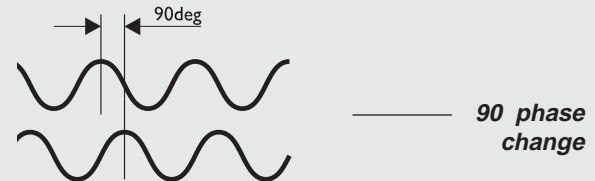

Flanger

The Feedback filters in this algorithm are capable of controlling both high frequency and low frequency feedback, which makes it very flexible and versatile.

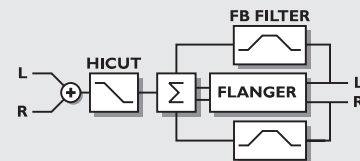

Speed

The speed of the Flanger, also known as Rate.

Depth

Adjusts the depth of the Flanger, also known as Intensity.

Delay

As described earlier, a Chorus/Flanger is basically a Delay being modulated by an LFO. This parameter makes it possible to change the length of that Delay. A typical Chorus uses delays at approximately 10ms, while a Flanger uses delays at around 5ms.

Mix

ADDITIONAL EFFECTS - FLANGER & TREMOLO

Mix between direct sound and effect.

Out Level

Controls the Output level of the block.

Feedback

Controls the amount of feedback in the Flanger.

Note that this parameter can be negative, e.g. feedback in reversed phase.

Cross Feedback

Controls the amount of feedback between the two channels.

Note that the Crossfeed can be negative, e.g. Crossfeed in reversed phase.

Golden Ratio

Sets the Golden Ratio between Speed and Depth On/Off. If you want to create wild Flanger sounds you may want to turn the Golden Ratio off.

Phase Reversed

Reverses the phase of the right channel, but only on the effected signal. This function makes the stereo image much wider.

LFO Curve

Sets the curve of the LFO. Choose between: Sine or Triangle. The most commonly used waveform in Flanging is Sine. (See curve figures in Tremolo).

LFO Phase

An LFO phase change causes a small delay in one of the waveform starting points. This means that left and right Outputs start the current waveform at two different points. Example: If LFO is set to 180°, left and right will be exactly opposite. (See the LFO phase figure in the Chorus section).

Tremolo

Speed

Controls the how fast the Tremolo is pulsing.

Depth

Will set the intensity of the Tremolo, or how deep it sweeps.

Mix

Mix between direct sound and effect.

Out Level

Controls the Output level of the block.

Curve (only in Advanced mode)

Sets the curve of the LFO. Choose between: Square, Sine, or Triangle.

The most common LFO curve in Tremolo is Triangle.

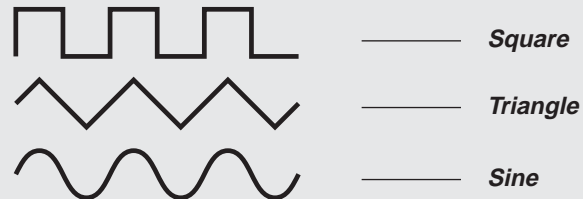

TIP Try the Square waveform with 100% Depth, to get holes in your sound (called Transforming).

Pulsewidth (only in Advanced)

Controls the division of the upper and lower part of the current waveform, e.g. if Pulsewidth is set to 75%, the upper half of the waveform will be on for 75% of the time.



LFO Phase (0, 90 or 180°)

An LFO phase change causes a small delay in one of the waveform starting points. This means that left and right Outputs start the current waveform at two different points.

TIP Use the Tremolo as a Panner by setting the LFO phase to 180°.

ADDITIONAL EFFECTS - PHASER & EXPANDER/GATE

Phaser

A Phaser in general is a group of comb filters that are swept back and forth by an LFO within a certain frequency range. When the comb filter sound is mixed with the direct signal, the moving phasing sound is created due to the constant moving phase cancellation of the combfilter frequencies in the direct signal.

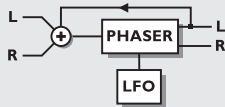

PHASER

Speed

Controls the speed of the moving filters in the Phaser.

Depth

Adjusts the depth of the phasing filters.

Mix

Mixes between direct sound and phaser sound.

Out Level

Controls the Output level of the block.

Order

Choose between 4th, 8th or 12th order.

FB Level

Controls the Level of the Feedback.

Range

Choose between Low or High.

Expander/Gate

The Expander/Gate performs Downward Expansion. Downward Expansion in general means that below a certain Threshold the Input signals gain is reduced on the Output according to a specific ratio. Expanders and gates are often used to reduce or eliminate noise.

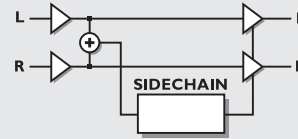

EXPANDER/GATE

Threshold

When the Input signal falls below the Threshold, the Expander/Gate starts working. This means that the higher Threshold the more expansion or gating you will get.

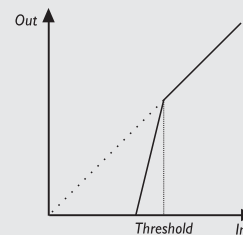

EXPANDER/GATE

Ratio

This is the Ratio of the gain reduction. If the Ratio is set to 4:1 it means that for every 1dB the Input signal decreases, the Output will decrease by 4dB.

When the Ratio is set to Infinite:1, it means that when the Input signal falls below the Threshold, the Output is turned all the way down. This is also known as Gating.

Attack

The Attack time is the fallback time that the Expander/Gate uses to reach the gain reduction specified by the Ratio parameter.

Example: If the Input signal suddenly drops 4dB below Threshold in no time, with the Ratio set to 4:1 and the Attack set to 20ms, the M3000 will use 20ms to reach a total gain reduction of 16dB.

Release

The Release is the rise time that the Expander/Gate uses to release the gain reduction when the signal exceeds the Threshold.

Out Level

Controls the Output level of the Expander/Gate.

ADDITIONAL EFFECTS - COMPRESSOR

Compressor

A Compressor is meant to reduce the dynamic content of the Input signal, and thereby keep a more constant level. When the Input signal exceeds the Threshold, the Compressor starts to reduce the signal according to the ratio. The Ratio describes how much the signal is reduced, e.g. a Ratio at 2:1 means that for every 2dB the signal exceeds the Threshold, only 1dB comes out.

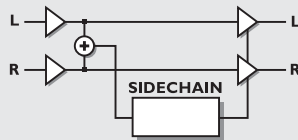

COMPRESSOR

Threshold

When the Input level exceeds the Threshold, the Compressor will be activated. This means that the lower the Threshold, the more compression you will get.

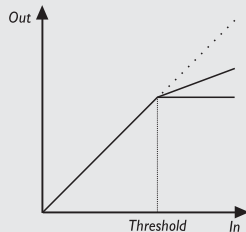

COMPRESSOR

Ratio

The Ratio of the gain reduction. Example: When the Ratio is set to 4:1 it means that for every 4dB the Input level rises, the Output level increases by only 1dB.

Attack

Attack is the amount of time the Compressor uses to reach the gain reduction specified by the Ratio parameter. Example: The Input signal rises to 4dB above Threshold in no time, with the Ratio set to 4:1 and the Attack set to 20ms. The Compressor will now use 20ms to reach a 3dB gain reduction - giving you 1dB on the output side for every 4dB the signal rises above the Threshold point.

Release

Release sets the fallback time from when the Input signal falls below Threshold until the Compressor reaches no gain reduction.

Out Gain

The Gain parameter makes it possible to compensate for the loss of level in the Compressor. This is also known as "Makeup" gain.

Out Level

Controls the Output level of the block.

ADDITIONAL EFFECTS - DE-ESSER

De-esser

A De-esser is used for removing the sibilant sounds from instruments and especially voices. This is done dynamically, which means that it's not a static EQ filter but a dynamic filter that only cuts into the sound when the high frequencies are loud in the material.

Threshold

When the Input level exceeds the Threshold, the De-esser will be activated, according to the Mode parameter.

Ratio

The Ratio of the gain reduction. When the Ratio is set to 4:1 it means that for every 4dB the defined frequency range rises, the Output level increases by only 1dB.

Attack

The Attack time is the response time that the De-esser uses to reach the gain reduction specified by the Ratio parameter. Example: If the Input signal suddenly increases to 4dB above Threshold with the Ratio set to 4:1 and the Attack set to 20ms, the De-esser will use 20ms to reach the gain reduction of 3dB.

Release

Release sets the fallback time of the De-esser, after the signal drops below the Threshold.

Freq

Sets the center frequency of the range the De-esser should work in.

Curve

Sets the bandwidth or Lo/Hi shelf setting of the range the De-esser should work in.

Mode

Decides how the Threshold shall react. When set to Relative, the Threshold will be relative to the average level of the signal. This means that also soft signals are processed. For signals where the average level is determined by signals outside the frequency range set, e.g. a vocal with sibilance, the Relative setting is useful and very musical. When Mode is set to Absolute, the Threshold set refers to full scale (0dB) and is therefore well suited for limiting the maximum level in a specified frequency range, e.g. the bass.

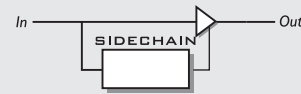

Monitor

Monitor the Sidechain signal, and hear what the De-esser actually removes from the main signal.

APPENDIX - THE RESET PAGE

*Store and load your own
default settings*

Enter User Data page

Reset system parameters

Clear all user presets

Test Programs

```
RESET
-----
▶LOAD USER DEFAULT  OK
  STORE USER DEF.   OK
  SET USER NAME     OK
  RESET SYS PARAM.  OK
  CLEAR ALL PRESETS OK
  RUN TEST PROGRAM  OK
```

Type your name here

Type your phone number

```
USER DATA
-----
▶NAME: Albert E
  PHONE: 123456789
  C  A  B  C  D  E  F  G  H  I  J  K  L  M  N
  P  Q  R  S  T  U  V  W  X  Y  Z  1  2  3
  4  5  6  7  8  9  0  -  +  :  ;  ◀ ▶  DONE
```

*Place cursor here
and press OK to
finalize session.*

To enter the Reset page:

Hold down one of the 3 Bypass keys pressed while powering up the unit.

Move the marker using the the CURSOR keys and press OK to select the desired Reset type.

Load User Default

This will reset all system parameters back to a Default setup defined by you (see Store User Def below). This reset will NOT delete the User presets of the M3000.

Store User Def

When you have a perfect setup of your M3000, you are able to store this as your own Default setup. This function is very useful, for example when you have finished a special production and wish to return to normal setup. When you have the perfect setup of your M3000, simply select this function and press OK to store your Default settings.

Set User Name

This function makes it possible to write your Name and Phone number into the M3000. Press OK to access the User data menu. Use the ADJUST wheel and the CURSOR keys to write your Name and Phone number into the M3000. Press OK to accept. Your Name and Phone number will be displayed during power-up.

Reset System Parameters

This will reset all system parameters back to the Factory Default. This reset will NOT delete the User presets of the M3000.

Reset all presets

This will clear all RAM presets .

APPENDIX - SELF TEST

PRESS ONE OF THE 3 BYPASS KEYS, WHILE POWERING UP, TO ACCESS THE RESET MENU AND SELECT »RUN TEST PROGRAM«

Turn the ADJUST wheel to scroll through Self tests

Key test

Select Key test by pressing OK.

The keys must be pressed in the order they are requested by the M3000 to pass the test.

Press CANCEL (OK with SHIFT activated) to exit Key test.

ADJUST wheel test

Select ADJUST wheel test by pressing OK.

Turn the ADJUST wheel to 30 and back to 0 to pass test.

Press CANCEL to exit the ADJUST wheel test.

LED test

Select LED test by pressing OK.

Turn ADJUST wheel to test the LED. The test is “ok” when all LEDs are lit.

Press CANCEL to exit LED test.

Display test

Select Display test by pressing OK.

Press OK to check that all pixels are lit. Press any key to leave the pixel test.

Analog I/O test

Select Analog I/O test by pressing OK.

Connect an M3000 Analog Output directly to the M3000 Analog Input, which has to be tested and press OK.

Use a balanced cable.

Press CANCEL to exit Analog I/O test

Digital I/O test

Select Digital I/O test by pressing OK.

Connect the M3000 AES/EBU Output to the M3000 AES/EBU Input.

Connect the M3000 S/PDIF Output to the M3000 S/PDIF Input.

Connect the M3000 ADAT Output to the M3000 ADAT Input.

PPM must show 0dB to pass test.

Press CANCEL to exit Digital I/O test.

MIDI I/O test

Select MIDI I/O test by pressing OK.

Connect the M3000 MIDI Output to the M3000 MIDI Input.

Prg. change 1-128 is send out on MIDI Thru. Connect this socket to a MIDI compatible device and confirm the Program changes.

Press CANCEL to exit MIDI I/O test.

Pedal test

Select Pedal test by pressing OK.

Connect a momentary pedal to the External Control In.

When pressing the pedal, the result should be OK.

When released the result should be Not OK.

Press CANCEL to exit Pedal test.

PCMCIA test

Select PCMCIA test by pressing OK.

Insert PCMCIA card. Note that all data on PCMCIA card will be destroyed.

Press OK to test.

Result reads:

Low battery - Time to change battery in your PCMCIA card.

Not OK - Try the test using another PCMCIA card.

Press CANCEL to exit PCMCIA test.

Battery test

Select Battery test by pressing OK.

Confirm that Result is “ok”.

Press CANCEL to exit Battery test.

System test

Select System test by pressing OK.

Confirm that Result is “ok”.

Result reads:

EEPROM Not Ok - The unit will most likely work ok, the message is for service matters only.

Ex. RAM is bad - , the memory will not work.

Contact your local dealer.

Press CANCEL (OK with SHIFT activated) to exit System test.

Power Off - On to start standard software.

Service note

In case of the unlikely event that the unit needs to be sent in for service, please pack the unit in the original box AND an outer box before sending it.

APPENDIX - TROUBLESHOOTING

You press the POWER switch but there is no light.

- The POWER switch on the rear panel is switched off.

The Input PPM meters don't peak out.

- You are using Analog Inputs, but the Input selector in the I/O menu is set to Digital in.
- The Analog Input level is set too low.

No sound through the M3000.

- You are using Analog Inputs, but the Input selector in the I/O menu is set to Digital in.

You can not turn off the power.

- Hold the POWER switch pressed for at least 3 seconds.

All programs sound “phased”.

- You are using the M3000 in combination with a mixing console (send/return), but have not set Mix to 100%. You can do this permanently in the I/O page.

Noise on Digital Outputs.

- If you experience Digital noise (much like “white noise”) or a hiss, you have probably set the dither to 8 bit. Unless you specifically want to dither to 8 bit please set dither to relevant value in the I/O page.

Input only present in one channel.

- If the Input meters indicates that signal is only present on either the Left or the Right side, you should check the Channel parameter in the I/O page. Appropriate setting should be selected. The options are L, R or Stereo.

APPENDIX - GLOSSARY

AES/EBU

Professional digital In/Out standard, using balanced XLR cables.

S/PDIF

Consumer digital In/Out standard, normally using coaxial phono type cables.

DITHERING

Dithering is a method to optimize the quality of a digital audio signal at low levels when truncation is taking place. E.g. going from a 24 bit format to 16 bit. A small amount of filtered noise is added to the signal, giving you a less distorted low level signal. If you are using digital outputs, the equipment you feed determines the number of bits. A signal going to a DAT or CDR recorder should always be dithered to 16 bit.

PRO/CONS LEVELS

Depending on which equipment you are using along with the M3000, you must set the PRO/CON parameters correctly in the I/O setup menu.

M3000 Analog Inputs:

Consumer range: -16dB to +10dB, nominal level = -10dB

Professional range: -6dB to +16dB, nominal level = +4dB

M3000 Analog Outputs:

Consumer range: -10dB to +16dB

Professional range: -16dB to +6dB

The levels are either listed in the technical specifications or printed on the rear panel of the connected devices.

DE-ESSING

An algorithm that removes unwanted “esses” from a vocal material.

SYSTEM EXCLUSIVE MIDI COMMANDS

Device-dependent MIDI commands, normally used for remote controlling machines.

APPENDIX - TECHNICAL SPECIFICATIONS

Digital Inputs and Outputs

| | |
|-------------------------|--|
| Connectors: | XLR (AES/EBU), RCA Phono (S/PDIF), Optical (Tos-link, ADAT) |
| Formats: | AES/EBU (24 bit), S/PDIF (24 bit), EIAJ CP-340, IEC 958, EIAJ Optical (Tos-link), ADAT Lite pipe |
| Output Dither: | HPF TPDF dither 8 to 24 bit |
| Sample Rates: | 44.1 kHz, 48 kHz |
| Processing Delay: | 0.2ms @ 48 kHz |
| Frequency Response DIO: | 20 Hz to 23.9 kHz \pm 0.01/-0.1 dB @ 48 kHz |

Analog Inputs

| | |
|--------------------------------|---|
| Connectors: | XLR balanced (pin 2 hot) |
| Impedance: | 20 kohm |
| Max. Input Level: | +22 dBu (balanced) |
| Min. Input Level (for 0 dBFS): | -10 dBu |
| Sensitivity: | @ 12 dB headroom: -22 dBu to +10 dBu |
| A to D Conversion: | 24 bit (1 bit, 128 times oversampling) |
| A to D Delay: | 0.8 ms @ 48 kHz |
| Dynamic Range: | >103 dB (unweighted), >106 dB (A) |
| THD: | -95 dB (0,0018 %) @ 1kHz, -6 dBFS (FS @ +16 dBu) |
| Frequency Response: | 10 Hz to 20 kHz: +0/-0.2 dB |
| Crosstalk: | <-80 dB, 10 Hz to 20 kHz, typical -100 dB @ 1 kHz |

Analog Outputs

| | |
|--------------------------|--|
| Connectors: | XLR balanced (pin 2 hot) |
| Impedance: | 100 ohm (active transformer) |
| Max. Output Level: | +22 dBu (balanced) |
| Full Scale Output Range: | -10 dBu to +22 dBu |
| D to A Conversion: | 24 bit (1bit, 128 times oversampling) |
| D to A Delay: | 0.57 ms @ 48 kHz |
| Dynamic Range: | >100 dB (unweighted), >104 dB(A) |
| THD: | -86 dB (0.005 %) @ 1 kHz, -6 dBFS (FS @ +16 dBu) |
| Frequency Response: | 10 Hz to 20 kHz: +0/-0.5 dB |
| Crosstalk: | <-60 dB, 10 Hz to 20 kHz, typical -90 dB @ 1 kHz |

EMC

Complies with: EN 55103-1 and EN 55103-2, FCC part 15, Class B, CISPR 22, Class B

Safety

Certified to: IEC 65, EN 60065, UL 1419, CSA E65

Environment

Operating Temperature: 32° F to 122° F (0° C to 50°C)

Storage Temperature: -22° F to 167° F (-30° C to 70°C)

Humidity: Max. 90% non-condensing

PCMCIA Interface

Connector: PC card, 68 pin type 1 cards

Standards: PCMCIA 2.0, JEIDA 4.0

Card Format: Supports up to 2 MB SRAM

Control Interface

MIDI: In/Out/Thru: 5 Pin DIN

GPI, Pedal, Fader: 1/4" phone jack, 0 ohm to 50 kohm

General

Finish: Anodized aluminum front. Plated and painted steel chassis.

Dimensions: 19" x 1.75" x 8.2" (483 x 44 x 208 mm)

Weight: 5.2 lb. (2.35 kg)

Mains Voltage: 100 to 240 VAC, 50 to 60 Hz (auto-select)

Power Consumption: <20W

Backup Battery Life: >10 years

Warranty Parts and labor: 1 year

Technical Specifications are subject to change without notice !

APPENDIX - MIDI IMPLEMENTATION CHART

STUDIO EFFECTS PROCESSOR M3000 - NOVEMBER 1 - 1998

| Function | | Transmitted | Recognized | Remarks |
|---|------------------|----------------|----------------|---|
| Basic Channel | Default | 1-3 | 1-3 | Eng1: 1, Eng2: 2, Com: 3 |
| | Changed | 1-16 | 1-16 | |
| Mode | Default | | | |
| | Messages Altered | X | X | |
| Note Number | | X | X | |
| | True Voice | X | X | |
| Velocity | Note ON | X | X | |
| | Note OFF | X | X | |
| After Touch | Key's | X | X | |
| | Ch's | X | X | |
| Pitch Bend | | X | X | |
| Control Change | | from 10 and up | from 10 and up | Cntrl.#10: Mix (If available) Cntrl.#11: Output Level Cntrl.#12: First Param. on Edit page. Cntrl.#13: Second Param. on Edit page. Cntrl.#14: Third ... Cntrl.#15: ... Cntrl.#16: ... Cntrl.#17: ... |
| <i>All Controllers are single byte type, scaled to parameter range.</i> | | | | |
| Prog Change | | O | O | |
| | True# | 0-127 | 0-127 | |
| System Exclusive | | O | O | |
| Common | :Song Pos | X | X | |
| | :Song Sel | X | X | |
| | :Tune | X | X | |
| System real time | :Clock | X | O | |
| | :Commands | X | X | |
| Aux Messages | :Local ON/OFF | X | X | |
| | :All Notes OFF | X | X | |
| | :Active Sense | X | X | |
| | :Reset | X | X | |

Notes

O: YES Mode1: OMNI ON, POLY Mode 2: OMNI ON, MONO
X: NO Mode 3: OMNI OFF, POLY Mode 4: OMNI OFF, MONO

For complete M3000 MIDI specifications, please visit our Internet Site at: www.tcelectronic.com

APPENDIX *Soldering instructions*

MIDI Cable

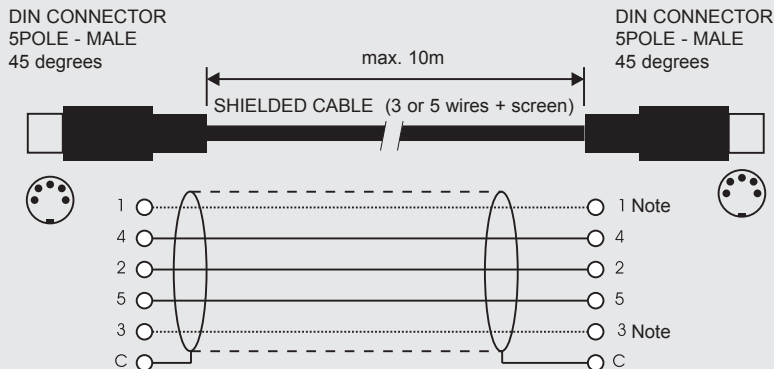

NOTE!

On TC units with RS485 interface pins 1 and 3 on the DIN connectors are reserved for RS485 connection. Therefore, if you are connecting the unit to other equipment that use these pins, please make sure to use 3-wire standard MIDI type cable (not a five wire MIDI-PLUS type).

Pedal Cable

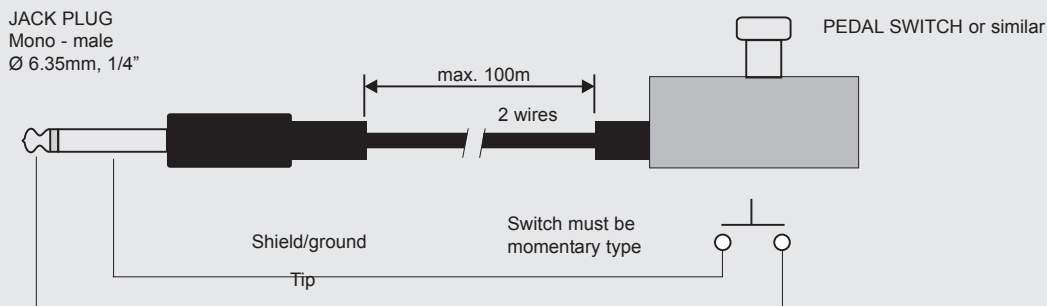

XLR - XLR

Pin 1 - Pin 1 (Ground)
Pin 2 - Pin 2 (Hot)
Pin 3 - Pin 3 (Cold)



Jack (unbalanced) - XLR

Sleeve - Pin 1 (Ground)
Tip - Pin 2 (Hot)
Sleeve - Pin 3 (Cold)

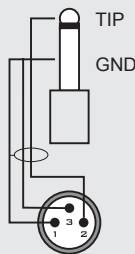

Jack (balanced) - XLR

Sleeve - Pin 1 (Ground)
Tip - Pin 2 (Hot)
Ring - Pin 3 (Cold)

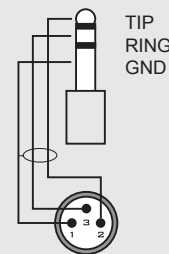

M3000 PRESET LIST

This is the preset list of all factory presets in the M3000. The M3000 holds 500 Single Engine and 100 Combined Engine presets.

When you press and hold down the RECALL key on Engine 1 or Engine 2, an index display pops up. This feature gives you an overview over the Single ROM presets enabling you to quickly access the desired type of presets.

Please note:

If the current recalled preset is in the range of 1 - 250, the overview will cover this range only.

If the current recalled preset is in the range of 251 - 500 the overview will cover this range only.

The categories

Range 1 - 250

| ROM PRESET TYPES | NO.: |
|--------------------|---------|
| TOP 20 | 1-20 |
| REAL/VIRTUAL HALLS | 21-136 |
| REAL/VIRTUAL ROOMS | 137-190 |
| PLATES | 191-204 |
| GATED REVERB | 205-211 |
| CLUBS | 212-225 |
| OTHER ALGORITHMS | 226-250 |

Range 251 - 500

| POST PRESET TYPES | NO.: |
|-------------------|---------|
| INDOOR | 250-399 |
| CARS | 400-409 |
| OUTDOOR | 410-439 |
| NATURE | 440-459 |
| EFFECT | 460-469 |
| SURROUND | 470-500 |

Note - Where nothing else is specified, the VSS™3 algorithm is used.

Top 20 Presets

The first 20 presets are a special “highlight” selection of the different preset types, covering Halls, Rooms, Plates, Gated Reverbs and Post Production presets.

- 1 Hall Large Warm
- 2 Studio 40x40ft
- 3 Queens Arena
- 4 Warm Cathedral
- 5 Singing In The Abbey
- 6 Stage And Hall
- 7 251 All Up
- 8 Vocal Bright
- 9 Space Hall
- 10 Overhead Mics
- 11 Bright Space
- 12 Small Wood Room
- 13 Band Rehearsal Room
- 14 RMX Snare Room
- 15 Bright Plate
- 16 Piano Plate
- 17 Gated Reverb VSS Gate
- 18 Empty Arena
- 19 Warehouse
- 20 The Mens Room

M3000 PRESET LIST

Halls

Presets #21 to 136.

A group of presets covering probably the most used reverbs in music production. This preset-group is divided into a Natural section from #21 to #63, which are the most realistic and natural sounding reverbs, and a Super-natural part from #64 to #136, which are more like effect reverb presets. Both groups are sorted from short to long decay times.

- | | | | |
|----|--------------------|----|----------------------|
| 21 | Small Dense Hall | 40 | Vocal Hall 1 |
| 22 | Puk Drum Ambience | 41 | Spacey Clear Hall |
| 23 | Ambient Hall | 42 | Concert Piano |
| 24 | Nice 4 Strings | 43 | Piano Hall 1st Row |
| 25 | Smokey Sax | 44 | Hall Medium Warm |
| 26 | Acoustic Gtr Space | 45 | Echo Hall |
| 27 | Full Gymnasium | 46 | Ballad Vocal Hall |
| 28 | Drews Small Hall | 47 | Vocal Hall 2 |
| 29 | Coffee House | 48 | Vocal Deep Male |
| 30 | Big Dense Studio | 49 | Modulated Hall |
| 31 | Bright Theatre | 50 | Grand Vocal Hall |
| 32 | Really True Hall | 51 | Empty Gymnasium |
| 33 | Queens Arena Full | 52 | Lively Hall |
| 34 | The Club | 53 | Church |
| 35 | Venue Clear | 54 | Hall Large Warm Wide |
| 36 | Venue Warm 1 | 55 | Hall Large ClearWide |
| 37 | Nice Hall 1 | 56 | Bright Hall |
| 38 | Venue Warm 2 | 57 | Nice Hall 2 |
| 39 | Concert Arena | 58 | Big Modulated Hall |
| | | 59 | Church Clear |
| | | 60 | Church Warm |
| | | 61 | Cathedral Strings |
| | | 62 | Cathedral |
| | | 63 | Cathedral Clear |

M3000 PRESET LIST

| | | | | | |
|----|--------------------|----------|-----|----------------------|----------|
| 64 | Club Carib | | 88 | Bright Slap Reverb | REV 3 |
| 65 | Kinky Chinks | | 89 | Lounge Lizard | C.O.R.E. |
| 66 | Bassed On What | | 90 | Slap Back Vox 2 | |
| 67 | Snare Room Bright | | 91 | Clear Hall | |
| 68 | Slap Back Sax | | 92 | Blind BG Vocals | REV 3 |
| 69 | 1 Bar Snare Tap | C.O.R.E. | 93 | Perc Modulation | |
| 70 | Drum Tile Space | | 94 | Perc Straight Tail | |
| 71 | Dickey Dickey | | 95 | Perc 1978 | |
| 72 | Smooth Garage | | 96 | Perc Straight | |
| 73 | Space Chamber | | 97 | Vocal Ballad | |
| 74 | Drums Big | | 98 | The 799A1 Sound | |
| 75 | Wide Space | | 99 | Damped Hall | |
| 76 | Leader Of The band | | 100 | 251 Long Pre Dly | |
| 77 | Medium Guitar Hall | REV 3 | 101 | Ballad Drums | |
| 78 | Medium Vocal Hall | | 102 | Vocal For Thin Voice | |
| 79 | Big Empty Club | | 103 | 251 | |
| 80 | Lap Dance Snare | | 104 | Bright Male Vox | |
| 81 | Lonely Organ | REV 3 | 105 | Vocal Female | |
| 82 | Slap Back Vox 1 | | 106 | Fiddle Heaven | |
| 83 | Bright Strings | REV 3 | 107 | Gospel verb 1 | |
| 84 | Bass Fishing | REV 3 | 108 | Slap Back Reverb | |
| 85 | Big Empty Space | | 109 | Shimmer Mod Lite | REV 3 |
| 86 | Medium Bright Hall | REV 3 | 110 | Bright Large Gym | |
| 87 | Bright Guitar Hall | | 111 | Hall Large | |

M3000 PRESET LIST

112 Nose Bleed Seats
113 Big Ballad Vocal 2
114 Sweet Basil Vocal
115 Blackface Amp
116 Large Hall Clear
117 Soupy Ballad Verb
118 Ringy Wash
119 Modulated Backwall
120 Big Vocal 2
121 Crystal Clear XXL
122 12 String Reverb
123 Big Guitar Verb
124 Windamish
125 Over Yonder Hill
126 Wild Modulation
127 Church Piano
128 String Bikini Atoll
129 In The Clouds
130 Perc 1980
131 Perc 1984
132 Freak Modulation 1
133 Vox Canyon
134 Warped Space
135 Long And Smooth

C.O.R.E.

136 Sweeping Weirdverb

Rooms

Preset #137 to 190.

Smaller and generally more tight rooms. The Natural sounding part of the presets are from #137 to #162, and the Super-natural part goes from #163 to 190. Both groups are sorted from short to long decay-times.

137 Vocal Doubler
138 Small Booth
139 Minimum Booth
140 Rhodes Thicken
141 Lively Small Room
142 12 String Doubler
143 Studio 10x10ft
144 Small Natural Room
145 Small Perc Room
146 Studio 20x20ft
147 Soft Medium Room
148 Small clear room
149 Nice Perc Ambience
150 Live Wooden Room
151 Puk Drum Ambience S
152 Acc Guitar Ambience
153 Wide Ambient Chamber
154 Tight N Clear

M3000 PRESET LIST

| | | | | |
|-----|----------------------|-----|----------------------|----------|
| 155 | Real Room | 179 | In A Cylinder | |
| 156 | Lucho 2016 Good room | 180 | RMX Ambience Wide | |
| 157 | Close Small Room | 181 | Small Guitar Room | REV 3 |
| 158 | Recital Room | 182 | Clear Guitar Room | |
| 159 | A Real Room | 183 | Dark Snare Hall | |
| 160 | Soft Guitar Ambience | 184 | Dark snare 2 | |
| 161 | Big Soft Room | 185 | Slap Back Guitar | |
| 162 | The Studio | 186 | Tom Tom Reverb | |
| 163 | Drum Stuff | 187 | Clear Room | |
| 164 | Tight vocal 1 | 188 | Slap Back Piano | |
| 165 | Kick Bass Ambience | 189 | Bossa Nova Perc Room | C.O.R.E. |
| 166 | Amb Rock Lead Gtr | 190 | Delayed Hall | |
| 167 | RMX Ambience | | | |
| 168 | Snare Room Long | | | |
| 169 | Drum Trash Stuff | | | |
| 170 | Drummin Up Business | | | |
| 171 | Vocal BG Fat | | | |
| 172 | Thick Space | | | |
| 173 | Crazy Phasey | | | |
| 174 | Filtered Vocal Dbl 1 | | | |
| 175 | Freak Modulation 2 | | | |
| 176 | Dance Snare | | | |
| 177 | Drum Room Xpander | | | |
| 178 | 3 Car Garage | | | |

Plates

Preset #191 to 204.

Reverb-simulations of vintage plate-reverbs. These presets are organised from short to long decay times.

| | |
|-----|------------------|
| 191 | Drum Booth |
| 192 | Drum Plate Stuff |
| 193 | Drum Wood Plate |
| 194 | Stairway Plate |
| 195 | Piano Plate |
| 196 | Slap Back Plate |
| 197 | Mac Perc |
| 198 | Ambient Plate |
| 199 | Silky Gold Plate |

M3000 PRESET LIST

- 200 Bright Plate
- 201 Drums Perc Soft1
- 202 Drum Perc Soft2
- 203 Oil Drum
- 204 Drum Perc Soft3

Gated Reverb Presets

Preset #205 to 211.

The VSS-Gate algorithm is a very extensive type of gated reverb. Preset #205 to #211 are some examples on this. Here you find presets for both drums and vocal.

- | | | |
|-----|--------------------|----------|
| 205 | Thick Drum Gate | VSS™GATE |
| 206 | Short Perc Gate | VSS™GATE |
| 207 | Microuzi Gate | VSS™GATE |
| 208 | Backing Vocal Gate | VSS™GATE |
| 209 | Snare Gate | VSS™GATE |
| 210 | GittinJiggyWiddit | VSS™GATE |
| 211 | Medium Band Room | VSS™GATE |

Clubs

Preset #212 to 225.

A group of very small and tight presets mainly made for drums and other percussive material.

- 212 Real Drum Booth
- 213 Small Wood Chamber
- 214 Vintage Snare Room 1
- 215 Vintage Snare Room 2

- 216 Studio Drum Ambience
- 217 Acoustic Space
- 218 Snare Booth Bright
- 219 Hard Drum Space
- 220 Dance Snare
- 221 Modulated Perc
- 222 Dark Snare Chamber
- 223 Tiny Booth
- 224 Small Space
- 225 Clear Space

Other Algorithms

Preset #226 to 250.

A selection of non-reverb Single presets, to be used alone or in any combination.

- 226 Slap Back Delay
- 227 Tap Delay
- 228 Detune Pitch
- 229 Up N Down
- 230 EQ Flat
- 231 Expander
- 232 Fast gate
- 233 Vox Comp
- 234 Allround Comp
- 235 Chorus
- 236 Wide Chorus

M3000 PRESET LIST

- 237 SRV Chorus
- 238 Flanger
- 239 Wild Flanger
- 240 Slow Tremolo
- 241 Wild Tremolo
- 242 Slow Panner
- 243 Fast Panner Wide
- 244 Old Phaser
- 245 Standard Phaser
- 246 Weird Phaser
- 247 Vocal De-esser
- 248 Dynamic Hi Cut
- 249 Dynamic Lo Cut
- 250 Muted Engine

Presets 251-500 uses the VSS™FP and VSS™SR algorithms. The se presets are dedicated to Film and Post production, and they are made by high-end film and post-production professionals from leading facilities in US and Europe. We believe it is the most extensive collection of film and post-production presets yet available.

The special thing about reverb for film and post production is that it has to sound natural and realistic. This doesn't necessarily mean nice and smooth - as it often does in music applications - but that it has to be trustworthy and fit into the scenes.

We have arranged the 250 presets in several blocks for different applications.

Note - VSS™FP is used for presets 251 to 469
VSS™SR is used for presets 470 to 500

VSS™FP Presets

**Ultra small reverb presets (Indoor Mini)
Presets #251 to 259.**

A selection of very small and tight sounding reverb settings. The characteristics of these presets are they are made almost entirely of Early Reflection patterns, because the reverb tail in such small spaces is almost non-existent.

- 251 Closet With Clothes
- 252 Walk In Closet
- 253 Too Small Mens Room
- 254 Phonebooth Tight
- 255 Phonebooth
- 256 Claustrophobia
- 257 Under A Blanket
- 258 Near The Wall
- 259 Meat Locker

M3000 PRESET LIST

Small rooms and spaces (Indoor Small)

Presets #260 to 289.

A selection of extremely natural and realistic small rooms.

Domestic rooms like kitchens and living rooms, and more public rooms like offices are represented here.

E.g. try preset 266 which is a preset simulating a standard small furnished living room.

- 260 A Small Room
- 261 The 2nd Bedroom
- 262 Drapes And Curtains
- 263 Dense Centered Room
- 264 Room Conversation
- 265 Chamber
- 266 Furnished Room
- 267 Living Room
- 268 Real Living Room
- 269 Dining Room
- 270 Corridor
- 271 Small Bathroom
- 272 Bathroom Blue
- 273 In The Kitchen
- 274 Interior Kitchen
- 275 Kitchen
- 276 ConfRoom Damped
- 277 Shrinks Office
- 278 Reception Area

- 279 Wooden Office
- 280 Store Room
- 281 Live VO Booth
- 282 Recording Booth
- 283 Studio Small
- 284 Standard Dialogue
- 285 Dialog 1
- 286 Open Mics
- 287 Close Breathing
- 288 Semifurnished Qntec
- 289 Small Foley Blue

Medium sized rooms and spaces (Indoor Medium)

Presets #290 to 319.

Domestic rooms and spaces are the dominant part of this preset block, but also public rooms are represented.

- 290 Furnished Room
- 291 Unfurnished Room
- 292 Locker Room
- 293 Livingroom Blue
- 294 Wood Floor
- 295 Natural Wood Room
- 296 Livingroom
- 297 Room With A View
- 298 Hallway

M3000 PRESET LIST

- 299 Basement 1
- 300 Furnished Basement
- 301 Wine Cellar
- 302 Toilet Stall
- 303 In The Shower
- 304 Bathroom Stall
- 305 Wide Garage
- 306 Right Side Garage
- 307 Conference Room
- 308 Glass Office
- 309 Large Office
- 310 Office
- 311 Empty Classroom
- 312 Classroom
- 313 Back Of The Glass
- 314 Watch-Tower Inside
- 315 Dialog 2
- 316 Dialog 3
- 317 Dialog 4
- 318 In The Air Vent
- 319 Kellars Cell Blue

Large rooms and spaces (Indoor XL)

Presets #320 to 369.

This section covers a wide range of presets from large domestic rooms to extra large indoor public areas.

- 320 Big Room
- 321 Empty Corridor
- 322 Plasterwalls
- 323 Centered Hallway
- 324 What A Basement
- 325 Basement 2
- 326 Basement Large
- 327 Empty Basement
- 328 Empty Stairwell
- 329 Small Stairway
- 330 Big Stairway
- 331 Home Garage
- 332 Modern Kitchen
- 333 Big Toilet
- 334 What A Toilet
- 335 Public Mens Room
- 336 Empty Store
- 337 Empty Nightclub
- 338 Storage Room
- 339 Recital Room
- 340 Hotel Lobby

M3000 PRESET LIST

341 Band Practice Room
342 Down The Hall
343 Factory
344 Dance Studio
345 Empty Restaurant
346 Tijuana Cantina
347 Store Room
348 Louvre Pyramid Hall
349 Pentagon Corridor
350 Airport PA
351 Grand Ballroom
352 Parking Garage Small
353 Garage
354 Mine Corridor
355 Mine Chamber
356 Tight+Natural
357 Tight+Smooth
358 Scoring Stage 1
359 Scoring Stage 2
360 Scoring Stage 3
361 Dialog 5
362 Dialog 6
363 Dialog 7
364 Party Chit Chat

365 Large+Stage Blue
366 Down The Hatch
367 In The Sewer
368 Scissorhands Parlor
369 In The Room

The largest indoor halls and areas (Indoor XXL)

Presets #370 to 399.

The largest indoor areas imaginable. This includes only public areas, like e.g. railway-stations and parking garage buildings.

370 Elevator Shaft
371 Big Stairwell
372 Large Lockerroom
373 Empty Auditorium
374 AES Show Lobby
375 Brill Building Lobby
376 Boston Garden Hall
377 Warehouse Blue
378 Soft Warehouse
379 Long Swimming Pool
380 Swim Distant
381 Empty Indoor Pool
382 Frankfurt Hbf
383 Budapest WestRailwSt
384 LaGuardia Terminal
385 Subway Platform 1

M3000 PRESET LIST

- 386 Subway Platform 2
- 387 Subway Tunnel
- 388 Parking Distant
- 389 Parking Garage Talk
- 390 Parking Garage Ugly
- 391 Parking Garage
- 392 Indoor Parking Lot
- 393 Public Toilet
- 394 The Abbey
- 395 Medium Church
- 396 Concrete Maze
- 397 Dark Tunnel
- 398 Back There
- 399 Really Smooth Hall

Cars

Presets #400 to 409.

Reverb settings simulating one of the most difficult rooms. The car with its extremely small room and mixture of very soft and hard surfaces makes it very difficult to make a trustworthy replacement for the real thing: Everybody knows how it sounds inside a car !!!

- 400 Beetle Interior
- 401 Limo Interior
- 402 BMW Limo
- 403 Car Frontseat Dialog
- 404 Car Front 2 Backseat

- 405 Van Interior
- 406 A Van
- 407 Inside truck
- 408 Car Interior Blue
- 409 Cardoor At Midnight

Large outdoor presets (Outdoor XL)

Presets #416 to 429.

Typical larger outdoor areas, like backyards and reverb between buildings at the street.

- 410 Courtyard
- 411 Market
- 412 Alley
- 413 HarlemStreetAtNight
- 414 Stone Garden
- 415 Boat Trip In Venice
- 416 Backyard
- 417 Backyard Qntec Wide
- 418 On The Street
- 419 Street
- 420 Dog In The Alley
- 421 Alleyway
- 422 Between Skyscrapers
- 423 Between Buildings 1
- 424 Between Buildings 2
- 425 Under The Bridge

M3000 PRESET LIST

- 426 Dock
- 427 Long Cave
- 428 Backyard Qntc
- 429 Racetrack PA

Very large outdoor settings (Outdoor XXL)

Presets #430 to #439 give you a selection of very large outdoor places such as Empty Arenas and different courts.

- 430 Slap Alley
- 431 City Foot Chase
- 432 Empty Arena XXL
- 433 Racquetball Court
- 434 Wide Jail court
- 435 Across The Plaza
- 436 Large Citypark
- 437 Big City
- 438 Down The Tunnel
- 439 Jump Off Thee Bridge

Mother Nature presets (Nature)

Presets #440 to 459.

A block of dedicated nature area reverbs.

- 440 Green Forest
- 441 Forest In Winter
- 442 Forest In Autumn
- 443 Forest On The Hill
- 444 Forest Reverb 1
- 445 Forest Reverb 2
- 446 Forest
- 447 In The Valley
- 448 Valley In Winter
- 449 Deep Valley
- 450 Back Canyon
- 451 Distance In Jungle
- 452 Jungle
- 453 Alpine Atmosphere
- 454 Stoneriver In Vitosa
- 455 Stone-Quarry
- 456 Cave Corridor
- 457 Cave-Dwelling
- 458 Rocks At See
- 459 Mountains

M3000 PRESET LIST

Effect reverb settings

Presets #460 to 469.

A small block of special reverb settings that cannot be categorized into any real-world application. These presets can be used for sound effect purposes.

- 460 Speaker In A Room
- 461 Stinger 1
- 462 Stinger 2
- 463 Stinger 3
- 464 What Dreams May Go
- 465 Clausto-Phonebooth
- 466 Enhancer Verb 2
- 467 Dialog+Music Slap
- 468 Enhancer Stereo
- 469 Watch Them Scatter

VSS™ SR algorithm presets

Preset #470 to 500.

The special VSS™SR surround algorithm offers you a so far unseen possibility to create reverb. You have control over Front and Rear Decay time, and when the signal is send through a surround sound decoder this creates very realistic three-dimensional rooms.

- 470 Dining Room SR
- 471 Real Living Room SR
- 472 Kitchen SR
- 473 Unfurnished Room SR
- 474 Room With A View SR
- 475 Hallway SR
- 476 Basement SR
- 477 Claustrophobia SR
- 478 Meat Locker SR
- 479 Live VO Booth SR
- 480 Large Office SR
- 481 LouvrePyramidHall SR
- 482 Museum SR
- 483 Railwaystation 1 SR
- 484 Railwaystation 2 SR
- 485 LaGuardiaTerminal SR
- 486 Empty Arena XXL SR
- 487 Swimmingpool SR
- 488 Between Buildings SR
- 489 Cemetery SR
- 490 Street SR
- 491 Stadium Rear SR
- 492 Alpine Atmosph SR
- 493 Rocks At The Sea SR
- 494 Jungle SR
- 495 Forest SR
- 496 Canyon SR
- 497 Arboretum SR
- 498 Mine Corridor SR
- 499 Mine Chamber SR
- 500 Cave Long SR

M3000 PRESET LIST

Combined presets

Presets #1 to 100.

The combined preset bank offers a variety of suggestions on how to gain full benefit from the two-engine structure of the M3000.

A lot of really unique reverb effects can be obtained.

The categorization is not as strict as with the Single presets due to the many different applications these settings are designed for.

Please note that presets #96 to 100 are made from the VSS™ Surround algorithm.

- | | | | |
|----|--------------------|----|----------------------|
| 1 | 70s Style | 19 | Linked Parametric EQ |
| 2 | Panned Reverb | 20 | Linked Expander |
| 3 | Giant Space | 21 | Linked Vox Comp |
| 4 | XXL-Tone | 22 | Linked Inst Comp |
| 5 | Twang Reverb | 23 | Linked Chorus |
| 6 | Wide In Your Face | 24 | Linked Flanger |
| 7 | Techno Wave | 25 | Linked Tremolo |
| 8 | Comp Reverb | 26 | Linked Panner |
| 9 | Dual Delay | 27 | Linked Phaser |
| 10 | Thick Ambience | 28 | Linked De-esser |
| 11 | Double Ambience | 29 | De-ess-Delay |
| 12 | Slap Reverb | 30 | Phaser-Delay |
| 13 | Drum Rev+Amb | 31 | Phased Delay |
| 14 | Ambience | 32 | Chorus Delay |
| 15 | Morphing Rev-Delay | 33 | Delay Reverb Morphed |
| 16 | De-ess Hall | 34 | All Around |
| 17 | Linked Delay | 35 | Phaseman |
| 18 | Linked Pitch | 36 | Speaker |
| | | 37 | Machine Voice |
| | | 38 | Floating Ambience |
| | | 39 | Small Speaker |
| | | 40 | Doubler Reverb |
| | | 41 | Party Next Door |

M3000 PRESET LIST

| | | | |
|----|----------------------|----|----------------------|
| 42 | Rev Phased Delay | 66 | Castle Normal |
| 43 | Flanged Reverb | 67 | Machine Room Large 1 |
| 44 | De-essed Medium Hall | 68 | Machine Room Large 2 |
| 45 | Stereo Hall Large | 69 | Machine Room Large 3 |
| 46 | Stereo Studio 20x20 | 70 | Submarine Corridor |
| 47 | Stereo Studio 40x40 | 71 | Castle Big |
| 48 | Stereo Large Hall | 72 | In The Louvre |
| 49 | De-essed Small Room | 73 | Glass Church |
| 50 | Stereo Venue Clear | 74 | Hybrid Cathedral |
| 51 | Machine Room Tiny | 75 | Skating Ring |
| 52 | Submarine Very small | 76 | Stereo Church |
| 53 | Submarine Small | 77 | Stereo Expo Hall |
| 54 | De-S Wood Chamber 1 | 78 | Harbor |
| 55 | Stairway Wood 1 | 79 | Hippodrome |
| 56 | Wood Hall 1 | 80 | Deep Forest |
| 57 | Wood Hall 2 | 81 | Very Deep forest |
| 58 | Court 1 | 82 | Valley In Colorado |
| 59 | Court 2 | 83 | Boating On Amazonas |
| 60 | Submarine Big | 84 | Deep Jungle |
| 61 | De-S Wood Chamber 2 | 85 | Night On Lochness |
| 62 | Stairway Wood 2 | 86 | In The Pipe 1 |
| 63 | Elevator on 3th | 87 | In The Pipe 2 |
| 64 | Elevator on 5th | 88 | Computer Voice 1 |
| 65 | Elevator on 9th | 89 | Computer Voice 2 |

M3000 PRESET LIST

- 90 Computer Voice 3
- 91 Computer in Space 1
- 92 Computer in Space 2
- 93 Reverb for Isato
- 94 Pantheon
- 95 Sewage System
- 96 Military Base SR
- 97 POW Camp SR
- 98 Football Ground SR
- 99 Seaside SR
- 100 Large Cave SR