

INSTRUCTION MANUAL MANUEL D'INSTRUCTIONS MANUAL DE INSTRUCCIONES

MPX-CD4 MPX-MD4

Multiplexer

English

GB

Multiplexeur

Français

F

Multiplexor

Español

E

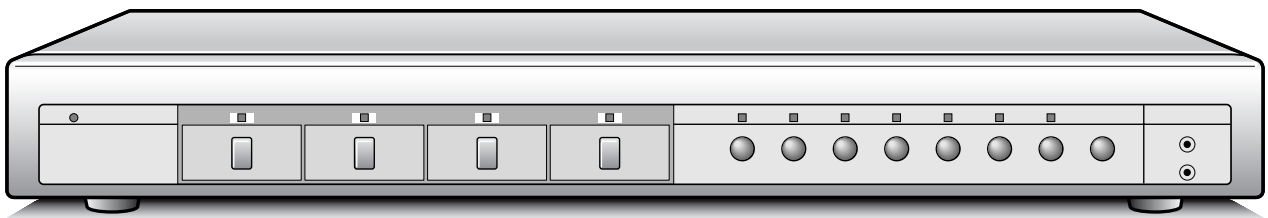

About this manual

- Before installing and using this unit, please read this manual carefully. Be sure to keep it handy for later reference.
- This manual gives basic connections and operating instructions for 2 models (Colour MPX-CD4, B/W MPX-MD4).

À propos de ce manuel

- Avant d'installer et d'utiliser cet appareil, veuillez lire ce manuel attentivement. Assurez-vous de le garder à portée de la main pour référence ultérieure.
- Ce manuel couvre les instructions de branchement et d'utilisation de base pour deux modèles (couleur MPX-CD4, noir et blanc MPX-MD4).

Acerca de este manual

- Antes de instalar y usar este aparato, lea detenidamente este manual. Asegúrese de guardarlo a mano para futuras referencias.
- Este manual le indica las conexiones básicas y las instrucciones de funcionamiento de dos modelos (Color MPX-CD4, Blanco y negro MPX-MD4).

PRECAUTION



CAUTION

RISK OF ELECTRIC SHOCK
DO NOT OPEN



CAUTION: TO REDUCE THE RISK OF ELECTRIC SHOCK, DO NOT REMOVE COVER (OR BACK). NO USER-SERVICEABLE PARTS INSIDE. REFER SERVICING TO QUALIFIED SERVICE PERSONNEL.

WARNING: To reduce the risk of fire or electric shock, do not expose this appliance to rain or moisture.

CAUTION: Changes or modifications not expressly approved by the manufacturer may void the user's authority to operate this equipment.



The lightning flash with arrowhead symbol, within an equilateral triangle, is intended to alert the user to the presence of uninsulated "dangerous voltage" within the product's enclosure that may be of sufficient magnitude to constitute a risk of electric shock to persons.



The exclamation point within an equilateral triangle is intended to alert the user to the presence of important operating and maintenance (servicing) instructions in the literature accompanying the product.

This equipment has been tested and found to comply with the limits for a Class B digital device, pursuant to Part 15 of the FCC Rules. These limits are designed to provide reasonable protection against harmful interference when the equipment is operated in a commercial environment. This equipment generates, uses, and can radiate radio frequency energy and, if not installed and used in accordance with the instruction manual, may cause harmful interference to radio communications. Operation of this equipment in a residential area is likely to cause harmful interference in which case the user will be required to correct the interference at his own expense.

For the customers in Canada

This class B digital apparatus complies with Canadian ICES-003.

CAUTION

Danger of explosion if battery is incorrectly replaced. Replace only with the same or equivalent type recommended by the manufacturer. Discard used batteries according to the manufacture's instructions.

Declaration of Conformity

Model Number : MPX-CD4/ MPX-MD4
Trade Name : SANYO
Responsible party : SANYO FISHER COMPANY
Address : 21605 Plummer Street,
Chatsworth, California 91311
Telephone No. : (818) 998-7322

- This device complies with Part 15 of the FCC Rules. Operation is subject to the following two conditions:
 - (1) this device may not cause harmful interference, and
 - (2) this device must accept any interference received, including interference that may cause undesired operation.

Location

For safe operation and satisfactory performance of your multiplexer, keep the following in mind when selecting a place for its installation:

- Shield it from direct sunlight and keep it away from sources of intense heat.
- Avoid dusty or humid places.
- Avoid places with insufficient ventilation for proper heat dissipation. Do not block the ventilation holes at the top and bottom of the multiplexer. Do not place the unit on a carpet because this will block the ventilation holes.
- Install the multiplexer in a horizontal position only.
- Avoid locations subject to strong vibrations.
- Avoid moving the multiplexer between cold and hot locations.
- Do not place the multiplexer directly on top of a monitor TV, as this may cause playback or recording problems.

Avoiding Electrical Shock and Fire

- Do not handle the power cord with wet hands.
- Do not pull on the power cord when disconnecting it from an AC wall outlet. Grasp it by the plug.
- If any liquid is spilled on the multiplexer, unplug the power cord immediately and have the unit inspected at a factory-authorized service centre.
- Do not place anything directly on top of this multiplexer.

SERVICE

This unit is a precision instruments and if treated with care, will provide years of satisfactory performance. However, in the event of a problem, the owner is advised not to attempt to make repairs or open the cabinet. Servicing should always be referred to your dealer or Sanyo Authorized Service Centre.

CONTENTS

PARTS NAMES	3
FRONT PANEL	3
REAR PANEL	4
CONNECTION	5
BASIC CONNECTIONS	5
CONNECTIONS TO THE S-VIDEO TERMINALS	5
REMOTE CONTROLLER CIRCUIT CONNECTIONS	6
INSTALLING THE RACK MOUNTING BRACKETS	6
BASIC OPERATIONS	7
MODE SWITCHING	7
SECURITY LOCK FUNCTION	8
SETTINGS BACKUP FUNCTION	8
RESET FUNCTION	8
LIVE PICTURE MODE	9
4 DIVISIONS SPLIT SCREEN OPERATIONS	10
FULL SCREEN OPERATIONS	12
SEQUENTIAL DISPLAY OPERATIONS	14
MONITOR 2 OPERATIONS	14
VCR PLAYBACK MODE	15
4 DIVISIONS SPLIT SCREEN OPERATIONS	16
FULL SCREEN OPERATIONS	18
SEQUENTIAL DISPLAY OPERATIONS	20
MENU SETTING MODE	21
LANGUAGE SETTING	22
CLOCK AND DAYLIGHT SAVING SETTING	23
CAMERA TITLE SETTING	24
ALARM SETTING	25
SENSOR SETTING	26
TIMER SETTING	28
CLOCK, TITLE DISPLAY AND MONITOR SETTINGS	29
VCR SIGNAL INPUT/OUTPUT AND COMPUTER CONTROL SETTING	31
ALARM DATA DISPLAY	33
ALARMS OPERATIONS	34
EXTERNAL ALARMS	34
VIDEO LOSS ALARM	34
RS232C CONTROL	35
CONNECTION	35
INTERFACE SPECIFICATIONS	35
COMMANDS	35
SPECIFICATIONS	39

FEATURES

- Duplexing function that allows 4 divisions split screen display even during live picture recording
- High speed single field switching
- Normal live picture display in 4 divisions split screen
- Video sensor and active recording functions for recording only when necessary
- Video loss warning function that can switch the display to colour bars or to a frozen image
- Timer function for recording live pictures only when required
- Computer control function using an RS232C connection
- Still image and zoom display modes in 4 divisions split screen and full screen display modes
- 2 monitor outputs and S-VHS input/output terminals
- Up to 100 alarm recordings log on-screen display

ACCESSORIES

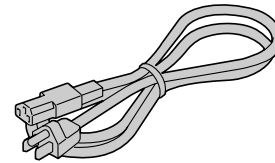

Power cord x1

Fixer
Power cord tie x1

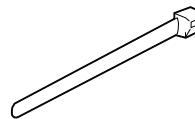

Rack mounting brackets
bolts x4

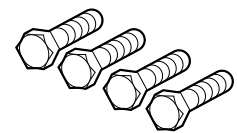

PARTS NAMES

FRONT PANEL

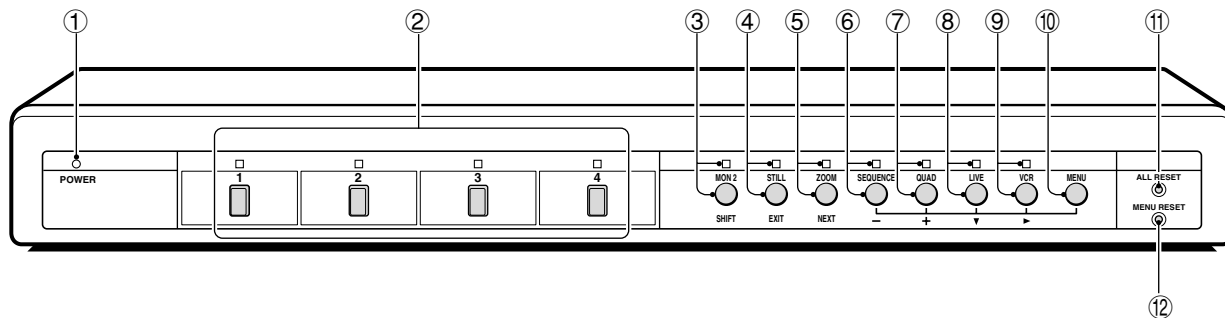

This unit is not equipped with a power switch. The power is turned on/off when the supplied power cord is connected/disconnected at the power source.

① **POWER indicator**

② **Camera select buttons and camera indicators**

Use these buttons to select the picture from the corresponding camera. Also, when in 4 divisions split screen, 4 divisions zoom, still image or sequential display modes, press one of these buttons to return to the normal picture full screen display of the corresponding camera.

③ **MON2 button and indicator**

Press this button to set the output at monitor 2.

④ **STILL button and indicator**

In 4 divisions split screen, 4 divisions zoom or full screen display modes, press this button to freeze the displayed image. Press the button one more time to cancel.

⑤ **ZOOM button and indicator**

In 4 divisions split screen or full screen display modes, press this button for a 2x zoomed in image. Press the button one more time to cancel.

⑥ **SEQUENCE button and indicator**

In 4 divisions split screen or full screen display modes, press this button for an automatic sequential full screen display of the pictures.

⑦ **QUAD button and indicator**

In full screen display or sequential display modes, press this button to switch to 4 division display mode. The default display mode is 4 division display mode.

⑧ **LIVE button and indicator**

Press this button to select the live input mode.

⑨ **VCR button and indicator**

Press this button to select the VCR playback input mode.

⑩ **MENU button**

Press this button to display the menus. Press repeatedly to select the different menus in order. Buttons ③ to ⑨ are used for menu control (for more information, please refer to page 7).

⑪ **ALL RESET button**

⑫ **MENU RESET button** (see page 8)

PARTS NAMES

REAR PANEL

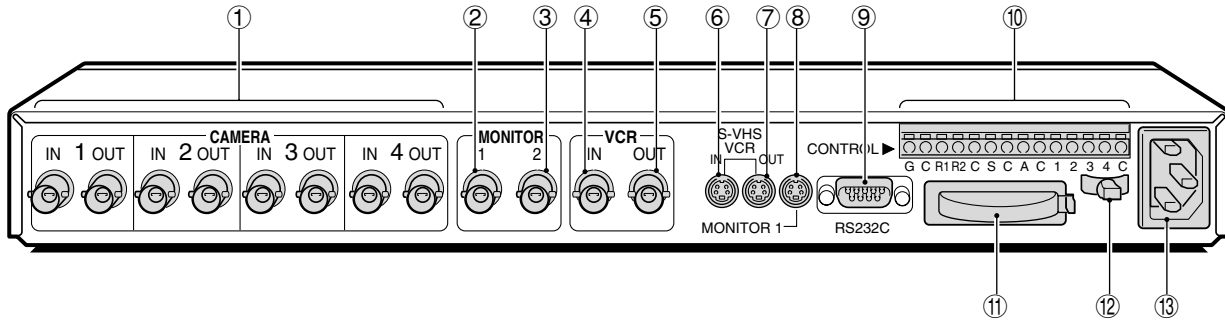

- ① **IN/OUT (Camera input/output) terminals**
Connect the cameras cable to the **IN** terminals.
You can use the **OUT** terminal to output the camera signal input at the **IN** terminal.
- ② **MONITOR 1 (Monitor 1 output) terminal**
- ③ **MONITOR 2 (Monitor 2 output) terminal**
- ④ **VCR IN (Video cassette recorder input) terminal**
- ⑤ **VCR OUT (Video cassette recorder output) terminal**
- ⑥ **S-VHS VCR IN (VCR S-VIDEO signal input) terminal**
- ⑦ **S-VHS VCR OUT (VCR S-VIDEO signal output) terminal**
- ⑧ **MONITOR 1 (Monitor 1 S-VIDEO signal output) terminal**
- ⑨ **RS232C (RS-232C) terminal**
To control this unit using a personal computer, connect the computer serial terminal to this terminal using a 9-pin D-SUB cable (sold separately).

⑩ **CONTROL terminal**

⑪ **Battery compartment**

⑫ **Power cord holder**

Using the supplied tie, attach the power cord to the holder as illustrated.

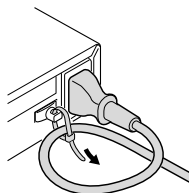

⑬ **AC Power socket**

Insert the power cord female plug firmly into this socket. When the other plug of the power cord is connect to a live power source, the POWER indicator on the front panel will light.

(RS232C terminal)

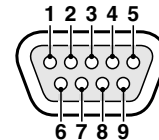

Pin No.	Signal	Function	Signal direction
1	-	-	-
2	RXD	Data reception	Computer → Multiplexer
3	TXD	Data transmission	Multiplexer → Computer
4	-	-	-
5	GND	Ground	-
6	-	-	-
7	RTS	Request to send	Multiplexer → Computer
8	-	-	-
9	-	-	-

(CONTROL terminal)

Pin	Signal
G	Ground
C	Common
R1	Remote input 1
R2	Remote input 2
C	Common
S	Switching input (DC 5V)
C	Ground
A	Alarm output (DC 5V)
C	Common
1	Alarm input 1
2	Alarm input 2
3	Alarm input 3
4	Alarm input 4
C	Common

NOTE: Model MPX-MD4 does not have **S-VIDEO IN, OUT** terminals.

CONNECTION

Before making any connection, make sure all the devices are turned off.

Before making the connections, please refer to the instruction manual accompanying each device. If the devices are not connected properly, that may cause a fire and/or damages.

BASIC CONNECTIONS

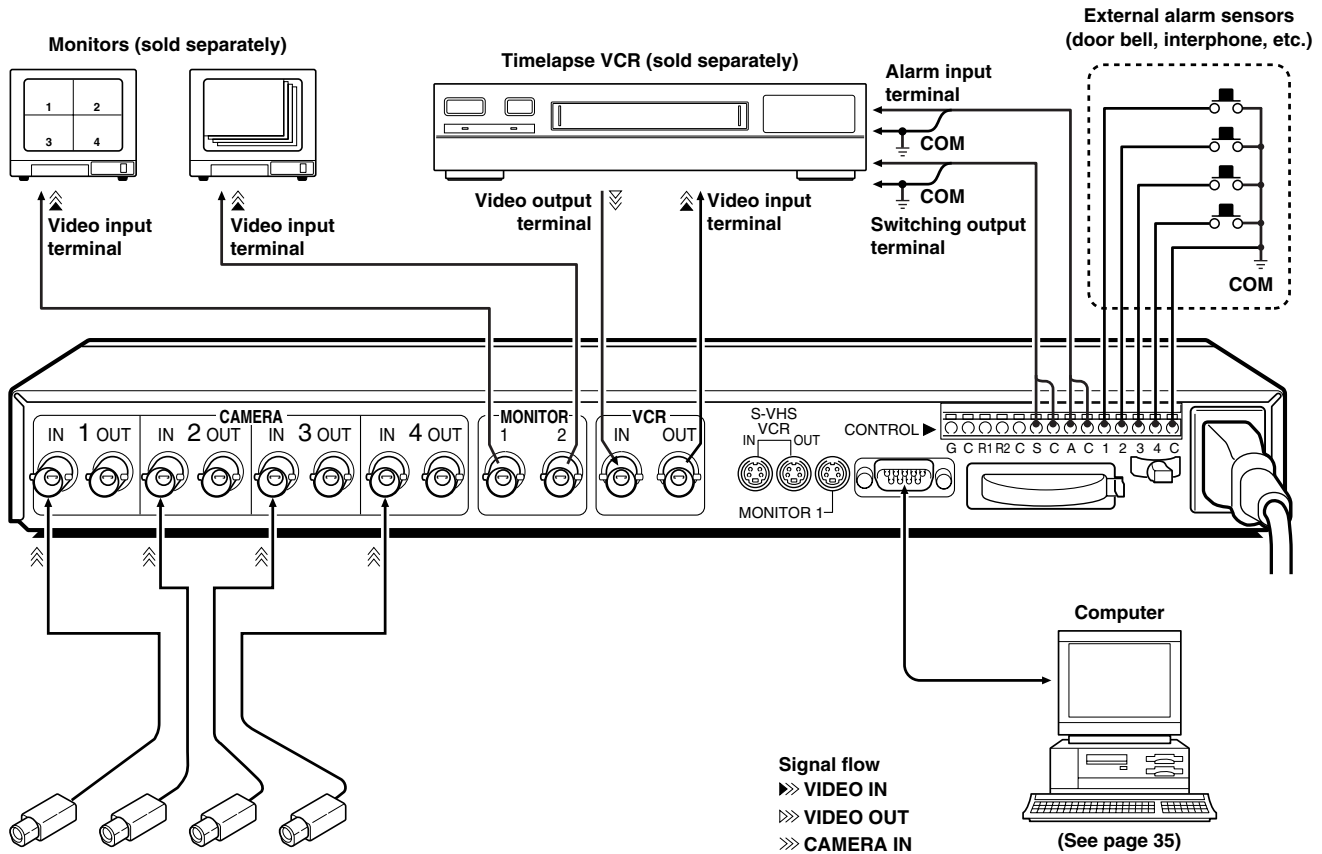

CONNECTIONS TO THE S-VIDEO TERMINALS

If connections are made to the S-VHS terminals, they will have the priority.

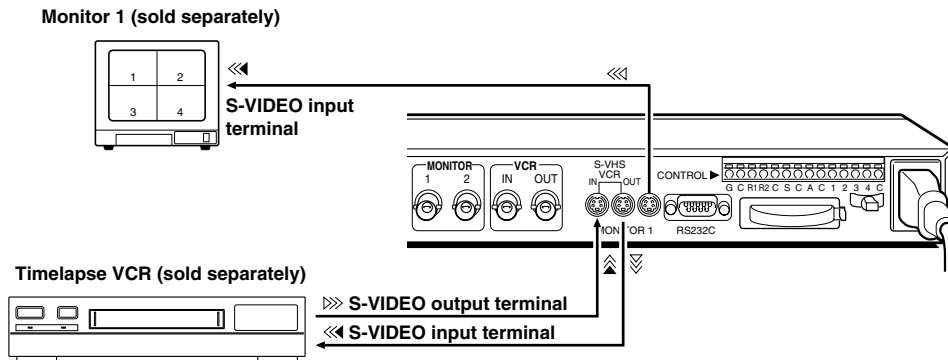

CONNECTION

REMOTE CONTROLLER CIRCUIT CONNECTIONS

Use the layout below to make a remote controller and make the connections to the remote input pins (R1, R2) of the CONTROL terminal as indicated. This will permit remote controlled operation of this unit.

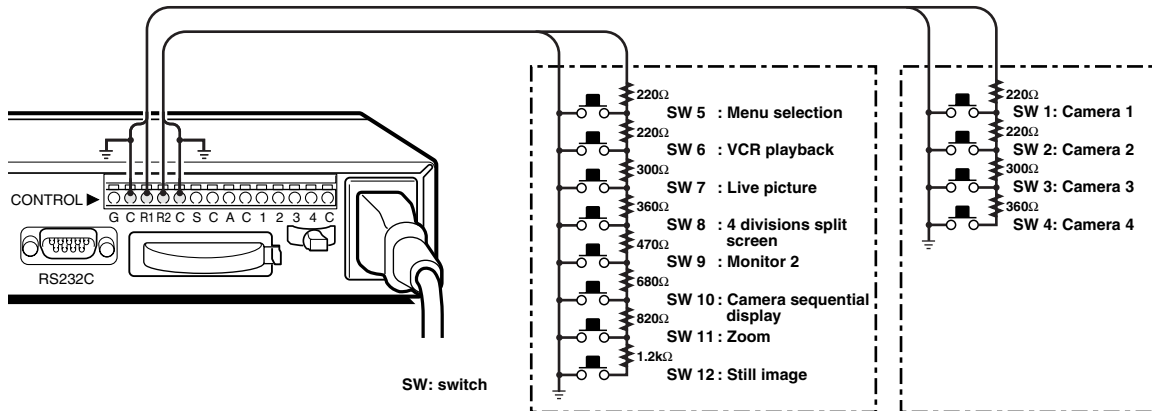

INSTALLING THE RACK MOUNTING BRACKETS (SOLD SEPARATELY)

To mount this unit onto a rack, please use the rack mount hardware (model VA-RACMK 1) sold separately.

- 1 Insert the head of two of the supplied bolts into the keyhole opening on the side of the unit.**
Insert the head of the bolt in the larger side, then slide it to the smaller side of the opening.
 - 2 Align the slot on the mounting bracket with the two bolts.**
Make sure the bolts have not moved from their position, then place a flat washer, a locking washer, and fix with a nut.
- NOTE:**
Make sure to use the bolts provided with this unit, as the bolts provided with the rack mount hardware are too short.
- 3 Install the second mounting bracket on the opposite side, then attach the unit onto the rack using the rack mount bolts.**

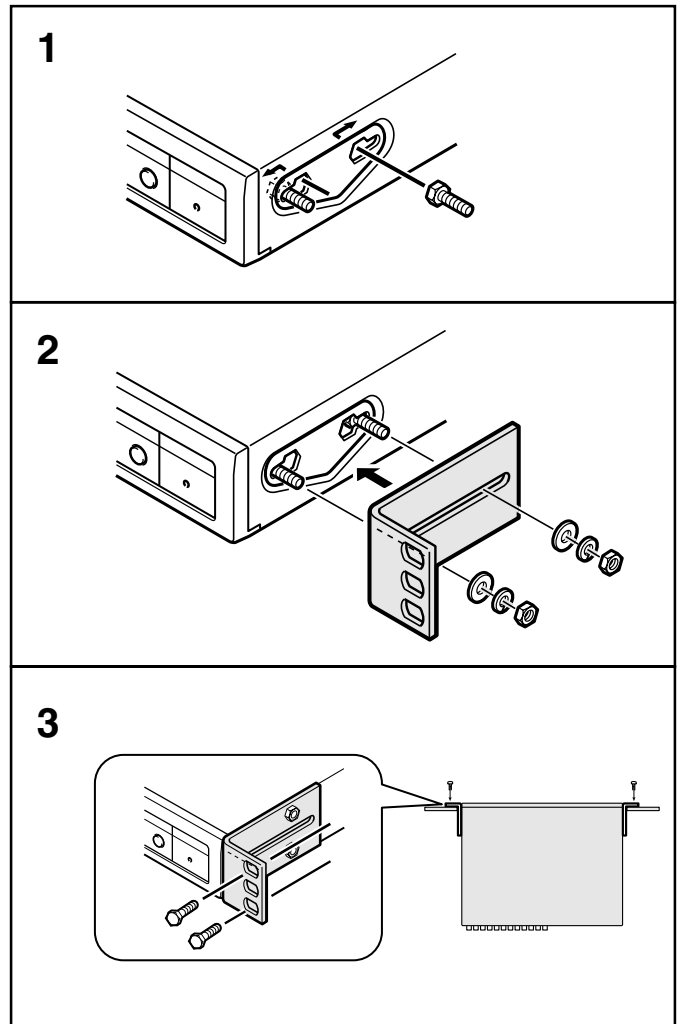

BASIC OPERATIONS

MODE SWITCHING

When the unit is connected to a power source, the default display mode will be as follows: live picture from the four cameras will be displayed in a 4 divisions split screen on monitor 1, and sequentially, full screen on monitor 2. You can use the VCR, LIVE and MENU buttons to switch to the desired mode (see below for further information).

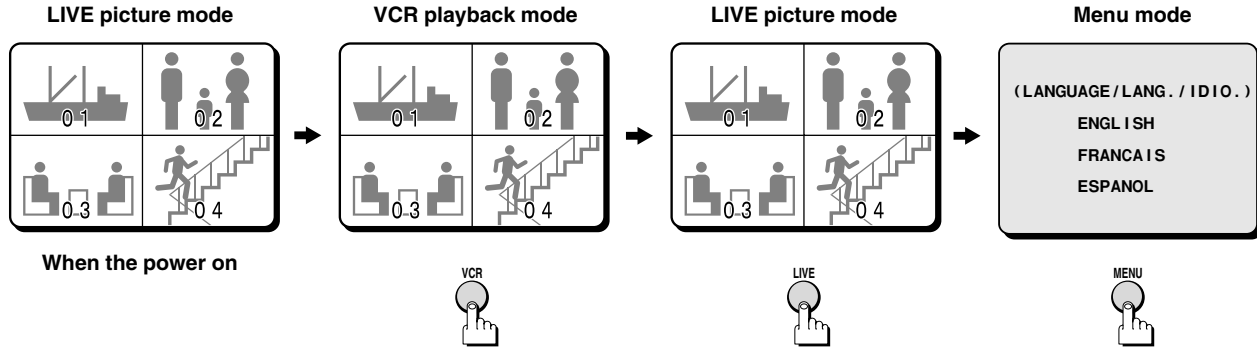

Live Picture Mode

When the **LIVE** button is pressed, the live (direct) picture from the cameras connected to the camera input terminals (1 – 4) on the unit rear panel, will be displayed. While in live picture mode you can use the still and zoom functions (see page 9).

NOTE:

- The unit will automatically start in the live picture or VCR playback display mode (4 divisions split screen, full screen or sequential display) last selected. Therefore, when a mode is selected, the display mode will remain the same.
- If a camera is not connected at one of the input terminals, "NO VIDEO" will be displayed on the monitor screen.



VCR Playback Mode

Start playback on the VCR. If the video signal is correctly recorded, the VCR playback image will be displayed on monitor 1 when the **VCR** button is pressed. While in VCR playback mode you can use the still and zoom functions (see page 15).

NOTE: If playing back a tape not recorded through this unit, "NO ID" will be displayed on the monitor screen.

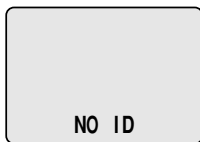

Menu Mode

Press the **MENU** button to display the menu. The buttons used for menu control (see page 21) are indicated below.

Menu control buttons

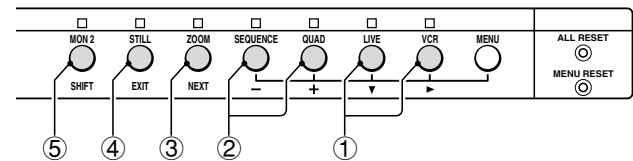

① ►, ▼ (VCR, LIVE) button

Use these buttons to move the cursor to the right or down.

- ► button: will move the cursor towards the right.
- ▼ button: will move the cursor down.

② +, - (QUAD, SEQUENCE) buttons

Use these buttons to select numbers, letters, symbols.

- + button: for forward selection
- - button: for backward selection

③ NEXT (ZOOM) button

To select a sub-menu in order to set the title position, etc. Press the **NEXT** button to switch between the menu and the sub-menu.

④ EXIT (STILL) button

To exit the menu mode.

⑤ SHIFT (MON2) button

Use this button and the ► or ▼ buttons to move the cursor to the left or up.

- Press and hold the **SHIFT** button, then press the ► button to move the cursor to the left.
- Press and hold the **SHIFT** button, then press the ▼ button to move the cursor up.

BASIC OPERATIONS

SECURITY LOCK FUNCTION

This function lets you lock the camera live picture mode or VCR playback mode, so that it cannot be switched to another mode.

Camera Live Picture Mode Lock

Press the **LIVE** button for about 3 seconds.

A buzzer will be heard, and the **VCR** and **MENU** buttons will not operate if pressed. If the buttons are pressed, a buzzer will be heard.

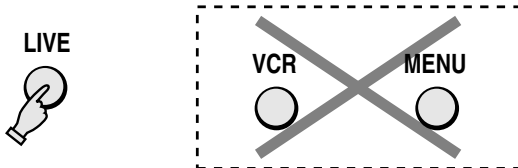

VCR Playback Mode Lock

Press the **VCR** button for about 3 seconds.

A buzzer will be heard, and the **LIVE** and **MENU** buttons will not operate if pressed. If the buttons are pressed, a buzzer will be heard.

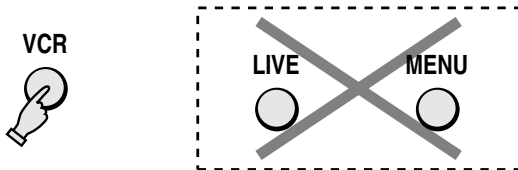

Canceling the Security Lock

To cancel the security lock, press the same (LIVE or VCR) button again for about 3 seconds. A buzzer will be heard and the mode will be unlocked.

SETTINGS BACKUP FUNCTION

This unit is equipped with a backup battery (lithium battery) to maintain the clock settings. When the unit is used under normal conditions, the backup battery is recharged. The battery is fully recharged after a minimum of about 30 hours, and will maintain the clock settings for up to 30 days.

NOTE: The settings may not be maintained properly if the backup battery has been recharged for less than 30 hours when the power goes off.

Battery Life

If the power is turned off for about one hour or more, when the power is restored, the (CLOCK SET) menu is displayed so the clock settings can be checked.

If the clock settings are reset to: 01-01-2000 SAT 00:00:00, that may indicate that the battery is dead and must be replaced.

Replacing the Battery

To replace the battery, please consult your dealer. After the battery has been replaced, press the **ALL RESET** button, then in the (CLOCK SET) menu set the date and time (see page 23).

RESET FUNCTION

The menus can be reset or cleared.

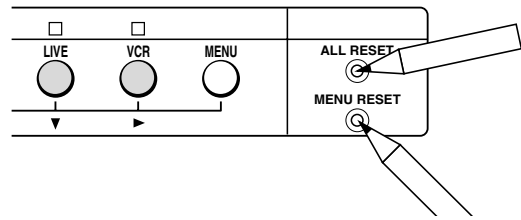

Using the MENU RESET Button

A: While a menu is displayed, press the **MENU RESET** button to reset all the values of the displayed menu to the default values.

B: If no menu is displayed, press the **MENU RESET** button to reset the time to the nearest hour.

For example, between 10:30:00 and 11:29:59 the clock will be reset to 11:00:00.

Using the ALL RESET button

Press this button to reset the following:

- Reset the time and date in the (CLOCK SET) menu to the default setting.
- The display mode on monitor 1 will return to 4 divisions split screen (default mode).
- The display mode on monitor 2 will return to sequential, full screen (default mode).

NOTE: If the multiplexer does not function properly, press the **ALL RESET** button. Please note that all the settings mentioned above will be reset.

LIVE PICTURE MODE



Press the LIVE button.

The live pictures from the cameras connected to the **CAMERA IN** terminals on the unit back panel will be displayed on monitor 1.

Refer to the diagrams below for the buttons to press in order to select the desired operation mode.

If recording, the signal at the **VCR OUT** terminal will switch according to the selected operation mode.

Please refer to (VCR SET) on page 31, for more information on settings for recording.

MONITOR 1 DISPLAYS AND FUNCTIONS

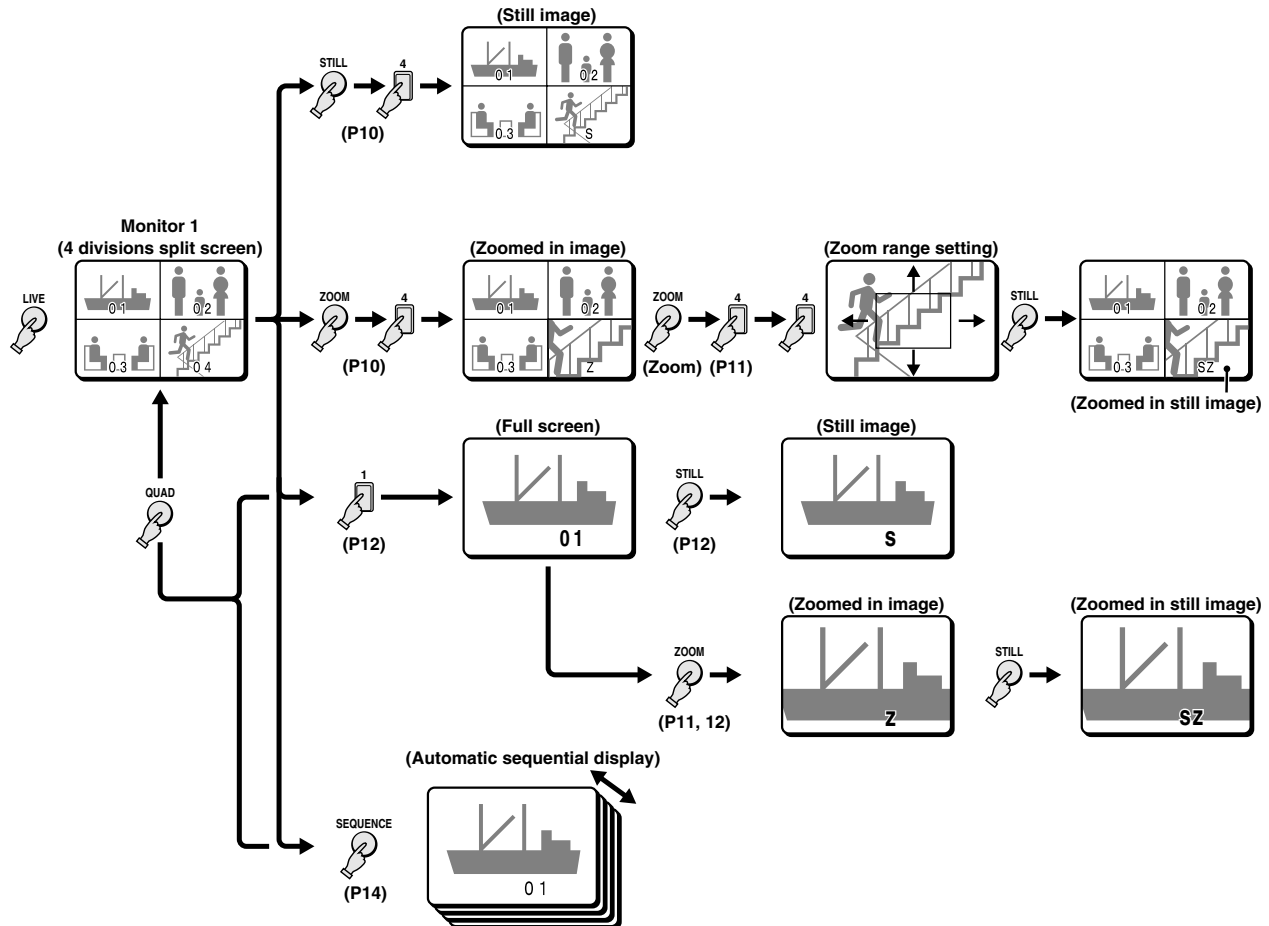

MONITOR 2 DISPLAYS AND FUNCTIONS

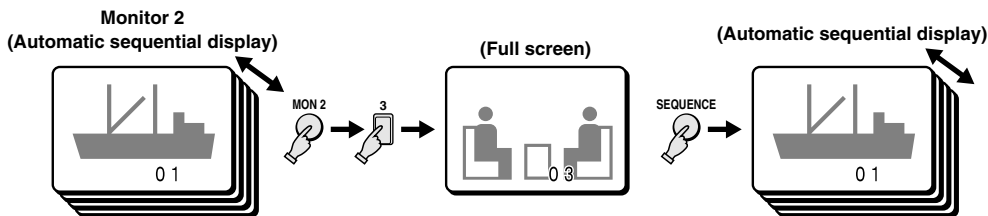

4 DIVISIONS SPLIT SCREEN OPERATIONS

(Live picture on monitor 1)



Press the QUAD button.

The 4 divisions split screen display mode will be selected.

Example 1: To freeze the image from camera 4

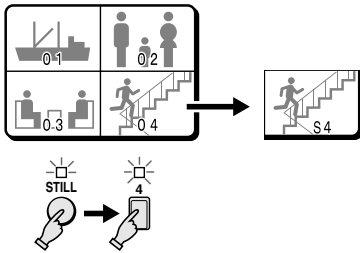

1 Press the STILL button.

The STILL indicator flashes and the still image display mode is selected.

2 Press the camera select 4 button.

The camera 4 indicator flashes, the image from camera 4 is frozen, and “S” flashes on-screen.

To cancel the still image display mode

Press the camera select 4 button one more time, then press the STILL button. The camera 4 indicator lights and the STILL indicator go off.

Example 2: To zoom in the image from camera 4

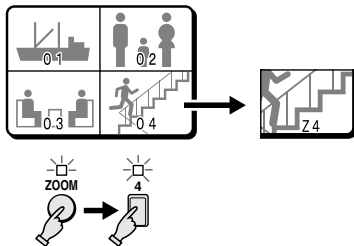

1 Press the ZOOM button.

The ZOOM indicator flashes and the zoomed in image display mode is selected.

2 Press the camera select 4 button.

The camera 4 indicator flashes, the image from camera 4 is zoomed in, and “Z” flashes on-screen.

To cancel the zoomed in image display mode

Press the camera select 4 button one more time, then press the ZOOM button. The camera 4 indicator lights and the ZOOM indicator goes off.

Example 3: To zoom in the image from camera 4 and set the zoom range

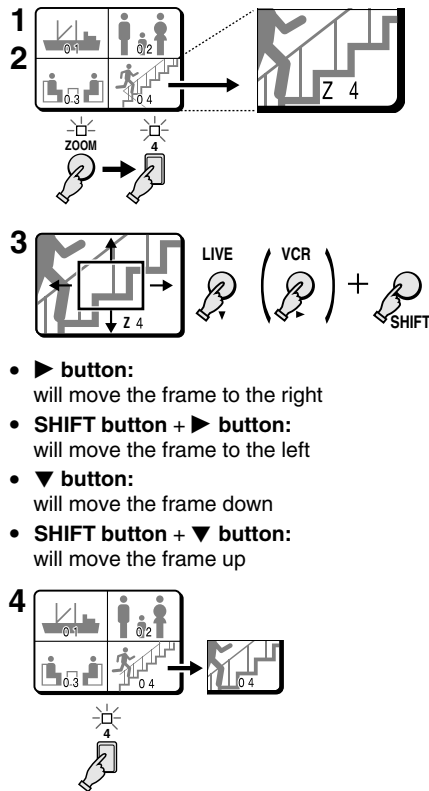

You can select the portion of the image to zoom in. The default zoomed in area is the centre of the image, but if a different zoom range is selected it will be memorized until changed or cancelled.

1 Press the ZOOM button.

The ZOOM indicator flashes and the zoomed in image display mode is selected.

2 Press the camera select 4 button for about 3 seconds.

In full screen mode, "Z" (flashes) and the zoom range frame are displayed.

NOTE: If during the zoom range setting, the frame displayed in full screen display mode is not moved for about 10 seconds, the display mode will automatically return to 4 divisions split screen display mode.

To return to the setting mode, press the camera select 4 button again, for about 3 seconds.

3 Press the ▶ (or ▼) button to move the zoom range frame to the desired area of the image.

4 Press the camera select 4 button.

The area selected by the zoom range frame is now zoomed in. If necessary, follow the same procedure to set the zoom range for the other cameras.

NOTE: You can switch from zoomed in mode to normal (no zoom) mode by pressing the camera select 4 button repeatedly.

To cancel the zoomed in image display mode.

Press the ZOOM button.

Example 4: To freeze the zoomed in image from camera 4

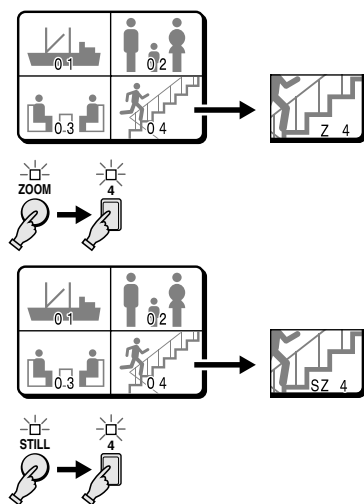

1 Press the ZOOM button.

The ZOOM indicator flashes and the zoomed in image display mode is selected.

2 Press the camera select 4 button.

The camera 4 indicator flashes, the image from camera 4 is zoomed in, and "Z" flashes on-screen.

3 Press the STILL button.

The STILL indicator flashes and the ZOOM indicator lights.

4 Press the camera select 4 button.

The camera 4 indicator flashes, the zoomed in image from camera 4 is frozen, and "SZ" flashes on-screen.

NOTE: A still image cannot be zoomed in.

To cancel the still and zoomed in image display mode.

Press the camera select 4 button, then press the STILL button.

Press the camera select 4 button, then press the ZOOM button.

To cancel all the still image displays and zoomed in image displays.

Multiple still image displays and the zoomed in displays can be set from the 4 divisions split screen, to cancel all at once, press the STILL button, then press the ZOOM button.

FULL SCREEN OPERATIONS

(Live picture on monitor 1)

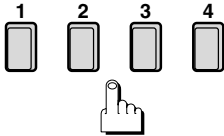

Press a camera select (1 – 4) button.

The live pictures from the selected camera will be displayed full screen.

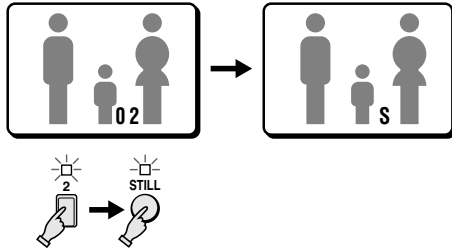

Example 5: To freeze the image from camera 2

1 Press the camera select 2 button.

The camera 2 indicator lights, the image from camera 2 is displayed.

2 Press the STILL button.

The STILL indicator flashes, the image from camera 2 is frozen, and “S” flashes on-screen.

To cancel the still image display mode

Press the **STILL** button. “S” is erased and the normal display mode returns.

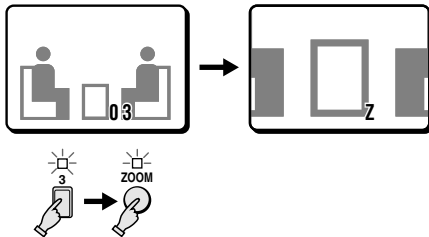

Example 6: To zoom in the image from camera 3

1 Press the camera select 3 button.

The camera 3 indicator lights, the image from camera 3 is displayed.

2 Press the ZOOM button.

The ZOOM indicator flashes, the image from camera 3 is zoomed in, and “Z” flashes on-screen.

NOTE: The zoomed in area will be as set by the zoom range frame (See example 7 on page 13).

To cancel the zoomed in image display mode

Press the **ZOOM** button. “Z” is erased and the normal display mode returns.

Example 7: To zoom in the image from camera 4 and set the zoom range

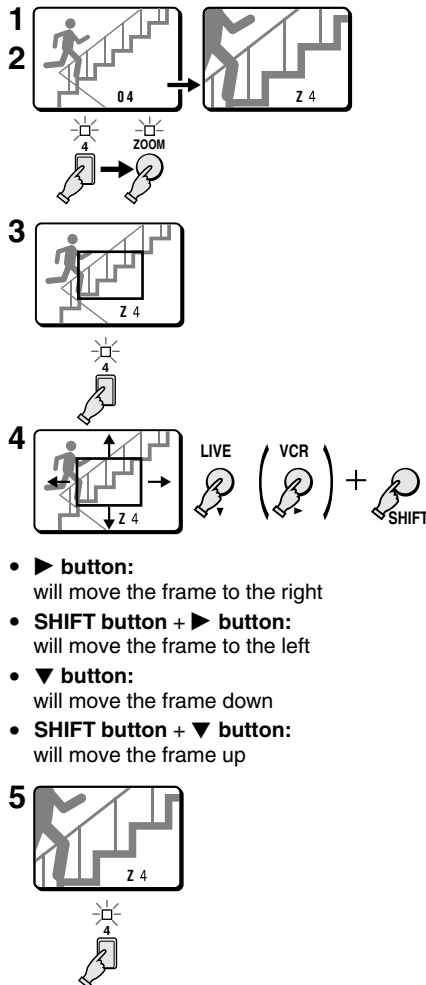

You can select the portion of the image to zoom in. The default zoomed in area is the centre of the image, but if a different zoom range is selected it will be memorized until changed or cancelled.

1 Press the camera select 4 button.

The camera 4 indicator lights, the image from camera 4 is displayed.

2 Press the ZOOM button.

The ZOOM indicator flashes, the image from camera 4 is zoomed in, and "Z" flashes on-screen.

3 Press the camera select 4 button for about 3 seconds.

The zoomed in image will switch to the normal display mode, and the zoom range frame is displayed.

NOTE: If the zoom range frame is not moved for about 10 seconds, the display will automatically return to the normal zoomed in mode.

To display the zoom range frame again, press the camera select 4 button for about 3 seconds.

4 Press the ► (or ▼) button to move the zoom range frame to the desired area of the image.

5 Press the camera select 4 button.

The area selected by the zoom range frame is now zoomed in.

If necessary, follow the same procedure to set the zoom range for the other cameras.

☞ To cancel the zoomed in image display mode.

Press the ZOOM button. "Z" is erased and the normal display mode returns.

■ While in zoom mode, if the camera select button is pressed one more time, depending on the movement of the subject, the image may be more or less clear. Pressing the camera select button repeatedly will produce the following according to the image conditions.

• Image with little or no movement

The image of a large subject will be clear, the picture quality of moving areas of the image will be coarse.

• Image with normal movement (people or vehicles)

The moving objects in the image will be clear, the picture quality of areas of the image with little movement will be coarse.

Example 8: To freeze the zoomed in image from camera 2

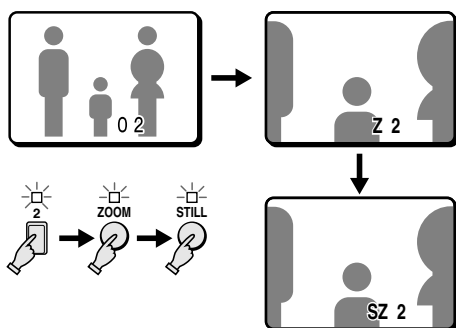

1 Press the camera select 2 button.

The camera 2 indicator lights, the image from camera 2 is displayed.

2 Press the ZOOM button.

The image from camera 2 is zoomed in, and "Z" flashes on-screen.

3 Press the STILL button.

The STILL indicator flashes and the ZOOM indicator lights. The zoomed in image is frozen, and "SZ" flashes on-screen.

☞ To cancel the still and zoomed in image display mode.

Press the STILL button, then press the ZOOM button.

SEQUENTIAL DISPLAY OPERATIONS

(Live picture on monitor 1)

Sequential display of each camera pictures at 1 second interval

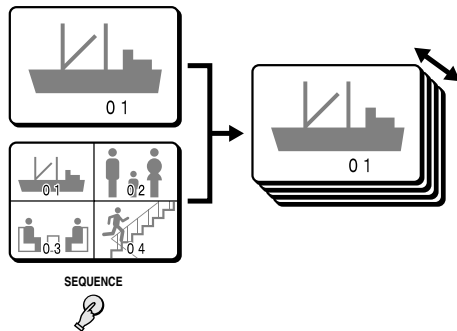

Press the **SEQUENCE** button.

The pictures from each camera are displayed sequentially at 1 second interval. The camera select indicators (1 – 4) light sequentially according to the displayed camera.

NOTE:

- The sequential display speed (image interval) is set to 1 second in the (MONITOR SET) menu. To change the sequence speed setting, refer to “**MON1 SEQ. TIMER**” on page 30.
- Only the channels where a camera is connected will be displayed. Empty channels will be skipped automatically.

MONITOR 2 OPERATIONS

Live picture will be displayed on monitor 2 even during VCR playback mode.



Press the **MON2** button.

The monitor 2 mode is selected and the MON2 indicator lights. A camera live picture will be displayed sequentially or full screen on monitor 2.

The monitor 2 display mode is memorized and the last one previously used will be automatically selected.

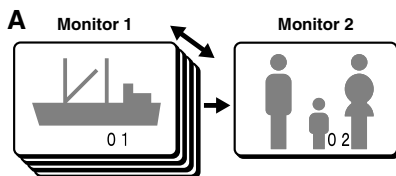

A: SEQUENTIAL DISPLAY MODE OPERATIONS

Press the camera select 2 button.

The camera 2 indicator lights, the picture from camera 2 is displayed on monitor 2.

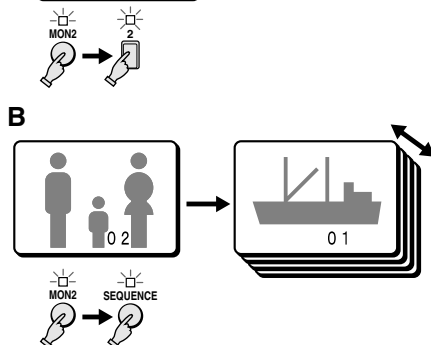

B: FULL SCREEN DISPLAY MODE OPERATIONS

Press the **SEQUENCE** button.

The SEQUENCE indicator lights, sequential display mode is selected.

To cancel the monitor 2 operations

Press the **MON2** button.

- The previously selected display mode (full screen or sequential display) will be selected.
- Live pictures will be displayed in a 4 divisions split screen on monitor 1.

■ TO DISPLAY ON MONITOR 2 THE SAME IMAGE AS ON MONITOR 1

This function can be used to monitor the images from a second location.

In the (MONITOR SET) menu, set the item “**MON2 ← MON1**” to “**Y**” (see page 30).

NOTE: When this setting is used, the **MON2** button will not operate.

VCR PLAYBACK MODE



Press the VCR button.

The VCR playback mode is selected. When a tape is played back, the recording of the live pictures will be displayed on monitor 1.

During VCR playback mode, there will be no signal output at the **VCR OUT** terminal.

MONITOR 1 DISPLAYS AND FUNCTIONS

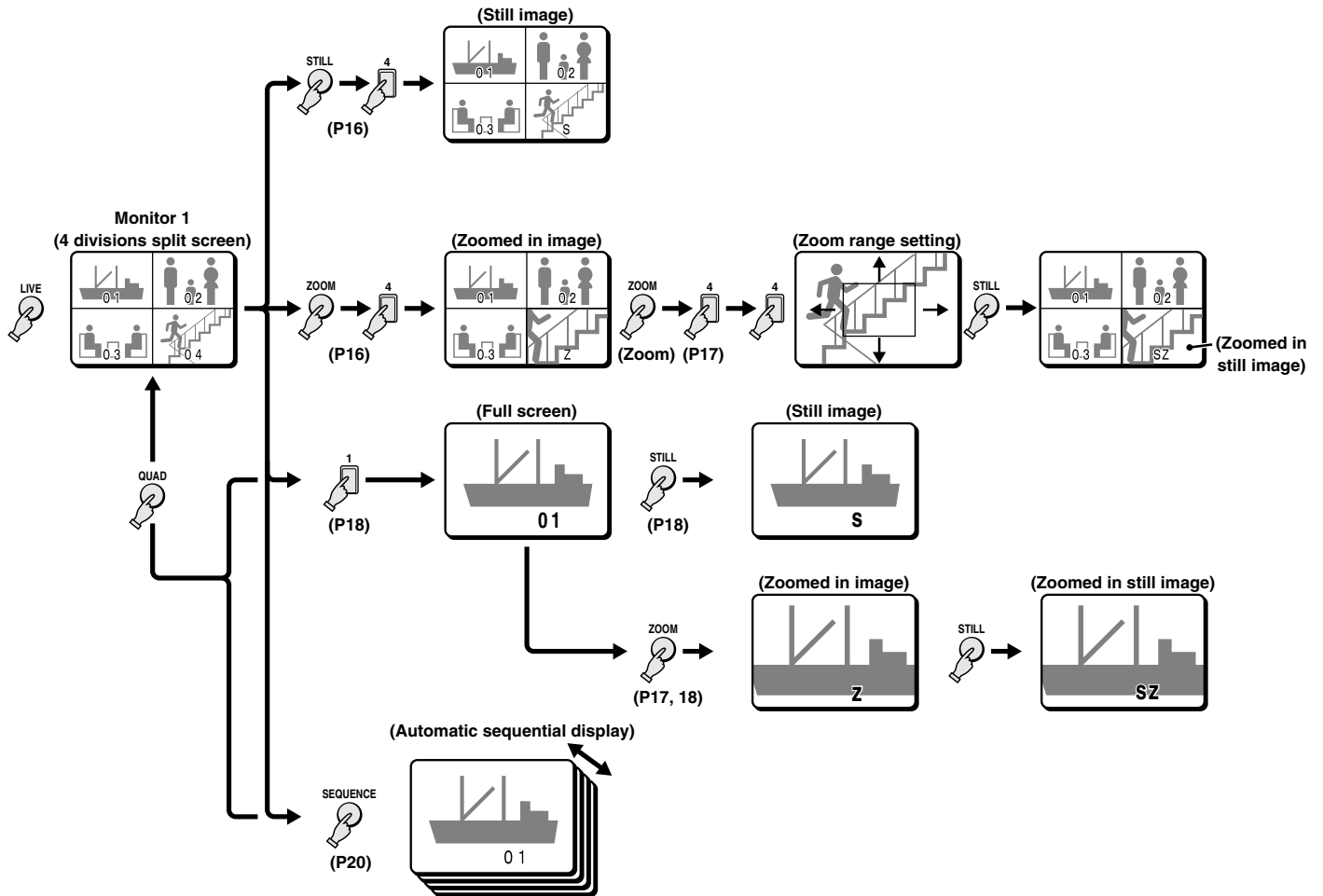

MONITOR 2 DISPLAYS AND FUNCTIONS

While the recorded pictures are displayed on monitor 1, a live picture will be displayed on monitor 2.

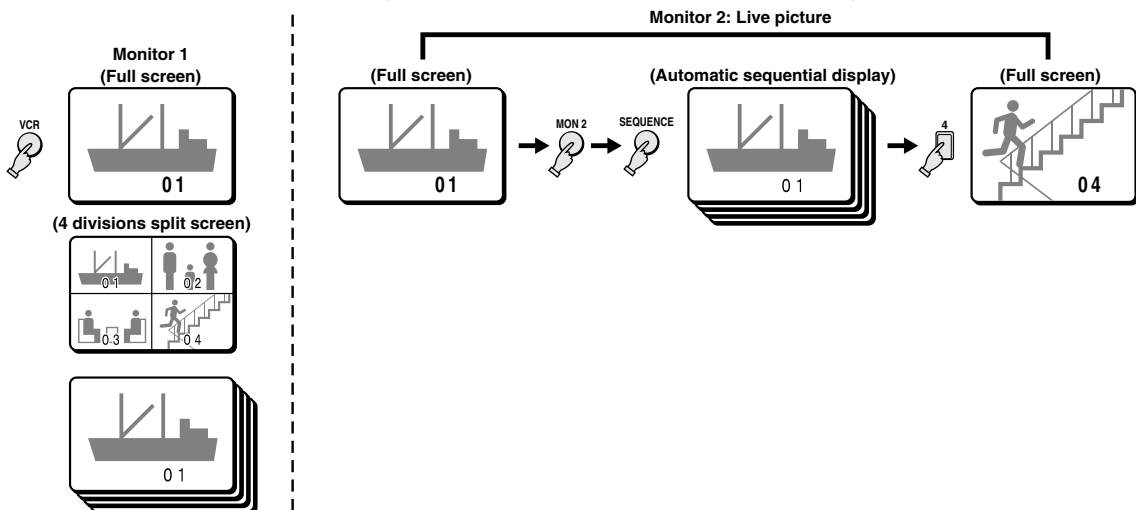

4 DIVISIONS SPLIT SCREEN OPERATIONS

(VCR playback on monitor 1)



Press the QUAD button.

The 4 divisions split screen display mode will be selected.

Example 1: To freeze the recorded image from camera 4

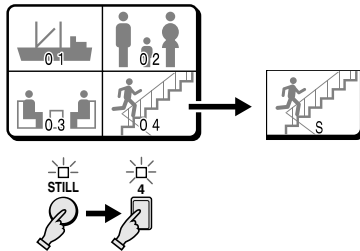

1 Press the STILL button.

The STILL indicator flashes and the still image display mode is selected.

2 Press the camera select 4 button.

The camera 4 indicator flashes, the recorded image from camera 4 is frozen, and "S" flashes on-screen.

To cancel the still image display mode

Press the camera select 4 button one more time, then press the STILL button. The camera 4 indicator lights and the STILL indicator go off.

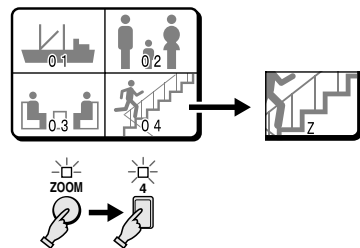

Example 2: To zoom in the recorded image from camera 4

1 Press the ZOOM button.

The ZOOM indicator flashes and the zoomed in image display mode is selected.

2 Press the camera select 4 button.

The camera 4 indicator flashes, the recorded image from camera 4 is zoomed in, and "Z" flashes on-screen.

To cancel the zoomed in image display mode

Press the camera select 4 button one more time, then press the ZOOM button. The camera 4 indicator lights and the ZOOM indicator goes off.

4 DIVISIONS SPLIT SCREEN OPERATIONS

(VCR playback on monitor 1)

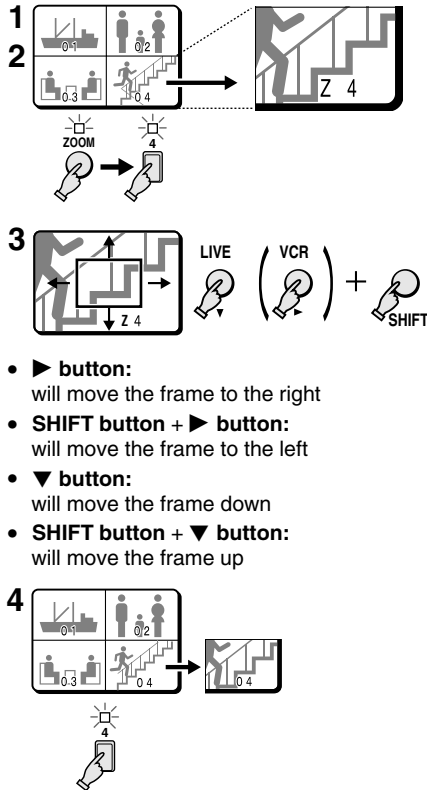

Example 3: To zoom in the recorded image from camera 4 and set the zoom range

You can select the portion of the recorded image to zoom in. The default zoomed in area is the centre of the image, but if a different zoom range is selected it will be memorized until changed or cancelled.

1 Press the ZOOM button.

The ZOOM indicator flashes and the zoomed in image display mode is selected.

2 Press the camera select 4 button for about 3 seconds.

In full screen mode, "Z" (flashes) and the zoom range frame are displayed.

NOTE: If during the zoom range setting, the frame displayed in full screen display mode is not moved for about 10 seconds, the display mode will automatically return to 4 divisions split screen display mode.

To return to the setting mode, press the camera select 4 button again, for about 3 seconds.

3 Press the ▶ (or ▼) button to move the zoom range frame to the desired area of the image.

4 Press the camera select 4 button.

The area selected by the zoom range frame is now zoomed in.

If necessary, follow the same procedure to set the zoom range for the other cameras.

NOTE: You can switch from zoomed in mode to normal (no zoom) mode by pressing the camera select 4 button repeatedly.

To cancel the zoomed in image display mode.

Press the ZOOM button.

Example 4: To freeze the zoomed recorded in image from camera 4

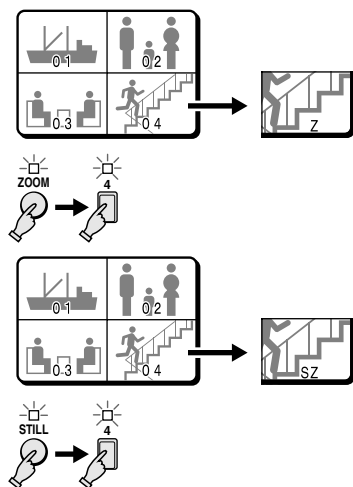

1 Press the ZOOM button.

The ZOOM indicator flashes and the zoomed in image display mode is selected.

2 Press the camera select 4 button.

The camera 4 indicator flashes, the recorded image from camera 4 is zoomed in, and "Z" flashes on-screen.

3 Press the STILL button.

The STILL indicator flashes and the ZOOM indicator lights.

4 Press the camera select 4 button.

The camera 4 indicator flashes, the zoomed in recorded image from camera 4 is frozen, and "SZ" flashes on-screen.

NOTE: A still image cannot be zoomed in.

To cancel the still and zoomed in image display mode.

Press the camera select 4 button, then press the STILL button.

Press the camera select 4 button, then press the ZOOM button.

To cancel all the still image displays and zoomed in image displays

Multiple still image displays and the zoomed in displays can be set from the 4 divisions split screen, to cancel all at once, press the STILL button, then press the ZOOM button.

FULL SCREEN OPERATIONS

(VCR playback on monitor 1)

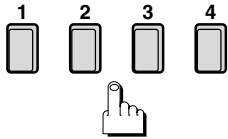

Press a camera select (1 – 4) button.

The recorded pictures from the selected camera will be displayed full screen.

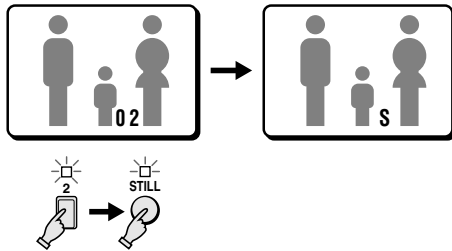

Example 5: To freeze the recorded image from camera 2

1 Press the camera select 2 button.

The camera 2 indicator lights, the recorded image from camera 2 is displayed.

2 Press the STILL button.

The STILL indicator flashes, the recorded image from camera 2 is frozen, and “S” flashes on-screen.

To cancel the still image display mode

Press the **STILL** button. “S” is erased and the normal display mode returns.

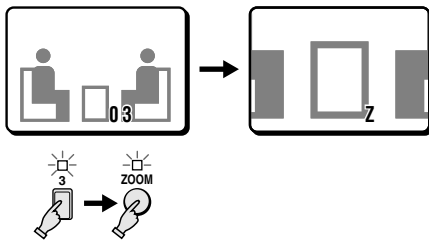

Example 6: To zoom in the recorded image from camera 3

1 Press the camera select 3 button.

The camera 3 indicator lights, the recorded image from camera 3 is displayed.

2 Press the ZOOM button.

The ZOOM indicator flashes, the recorded image from camera 3 is zoomed in, and “Z” flashes on-screen.

NOTE: The zoomed in area will be as set by the zoom range frame. (See example 7 on page 19)

To cancel the zoomed in image display mode

Press the **ZOOM** button. “Z” is erased and the normal display mode returns.

Example 7: To zoom in the recorded image from camera 4 and set the zoom range

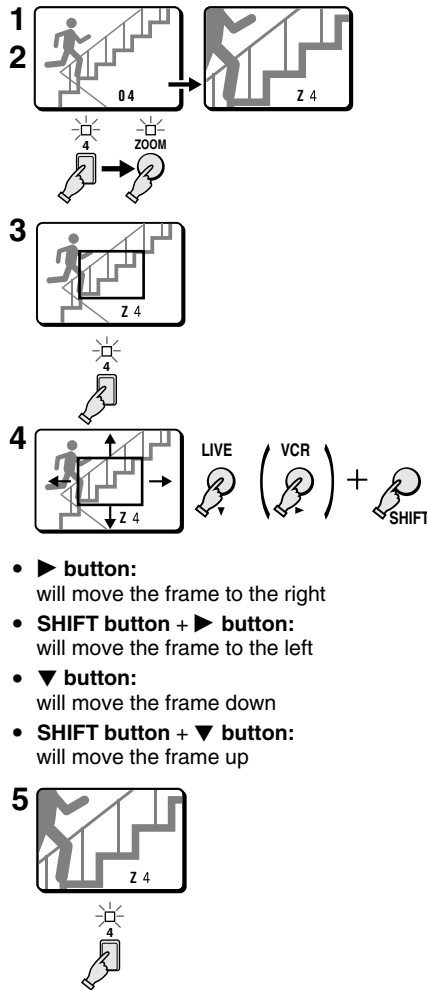

- **▶ button:**
will move the frame to the right
- **SHIFT button + ▶ button:**
will move the frame to the left
- **▼ button:**
will move the frame down
- **SHIFT button + ▼ button:**
will move the frame up

You can select the portion of the recorded image to zoom in. The default zoomed in area is the centre of the image, but if a different zoom range is selected it will be memorized until changed or cancelled.

1 Press the camera select 4 button.

The camera 4 indicator lights, the recorded image from camera 4 is displayed.

2 Press the ZOOM button.

The ZOOM indicator flashes, the recorded image from camera 4 is zoomed in, and "Z" flashes on-screen.

3 Press the camera select 4 button for about 3 seconds.

The zoomed in image will switch to the normal display mode, and the zoom range frame is displayed.

NOTE: If during the zoom range setting, the frame displayed is not moved for about 10 seconds, the display mode will automatically return to zoomed in display mode. To return to the setting mode, press the camera select 4 button again, for about 3 seconds.

4 Press the ▶ (or ▼) button to move the zoom range frame to the desired area of the image.

5 Press the camera select 4 button.

The area selected by the zoom range frame is now zoomed in. If necessary, follow the same procedure to set the zoom range for the other cameras.

🔊 To cancel the zoomed in image display mode.

Press the ZOOM button. "Z" is erased and the normal display mode returns.

Example 8: To freeze the zoomed in recorded image from camera 2

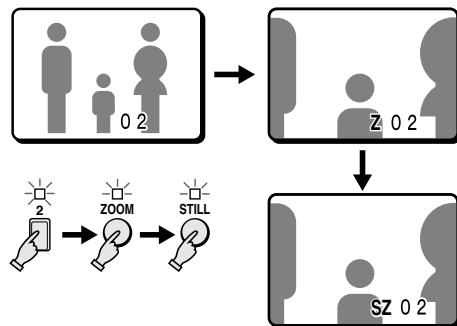

1 Press the camera select 2 button.

The camera 2 indicator lights, the recorded image from camera 2 is displayed.

2 Press the ZOOM button.

The recorded image from camera 2 is zoomed in, and "Z" flashes on-screen.

3 Press the STILL button.

The STILL indicator flashes and the ZOOM indicator lights. The zoomed in image is frozen, and "SZ" flashes on-screen.

🔊 To cancel the still and zoomed in image display mode.

Press the STILL button, then press the ZOOM button.

SEQUENTIAL DISPLAY OPERATIONS

(VCR playback on monitor 1)

Sequential display of each camera pictures at 1 second interval

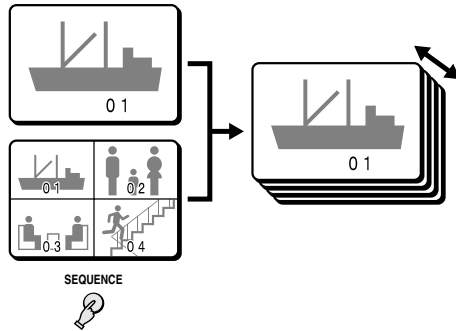

Press the **SEQUENCE** button.

The pictures from each camera are displayed sequentially at 1 second interval. The camera select indicators (1 – 4) light sequentially according to the displayed camera.

NOTE:

- The sequential display speed (image interval) is set to 1 second in the (MONITOR SET) menu. To change the sequence speed setting, refer to “**MON1 SEQ. TIMER**” on page **30**.
- Only the channels where a camera image was recorded will be displayed. Empty channels will be skipped automatically.

MENU SETTING MODE

MENUS DISPLAYS

To display the menus, press the MENU button.

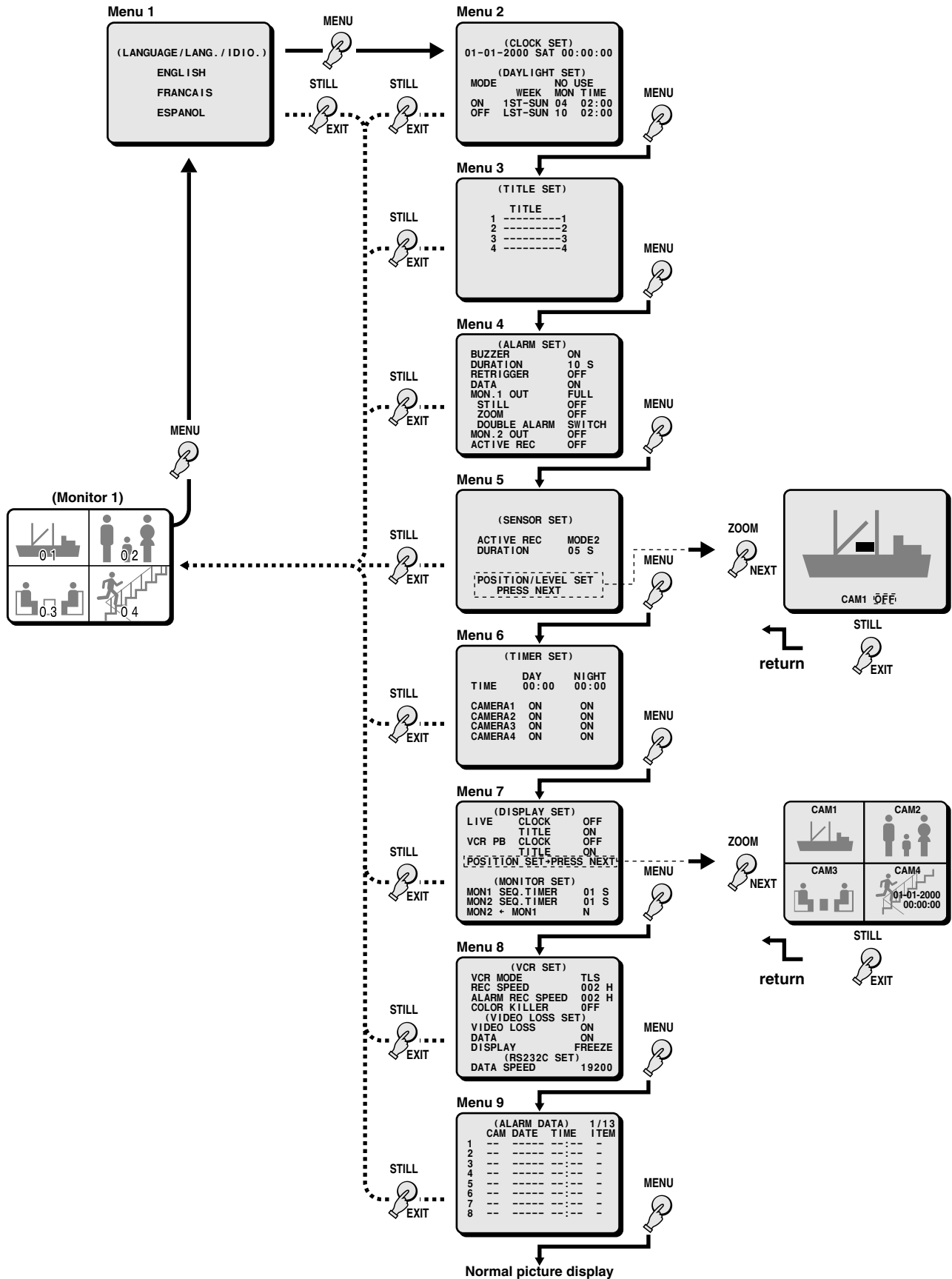

(LANGUAGE/LANG./IDIO.)

The default menu language is English. The available language settings are English, French and Spanish.

Setting the language

- 1 Press the MENU button 1 time to display the (LANGUAGE/LANG./IDIO.) menu.
- 2 Press the ▼ button to highlight the desired language.
- 3
 - ☞ Press the MENU button to go to the next menu, or
 - ☞ Press the EXIT button to exit the menu display and the selected language is set.
 - ☞ All the on-screen menus and settings will be displayed in the selected language.

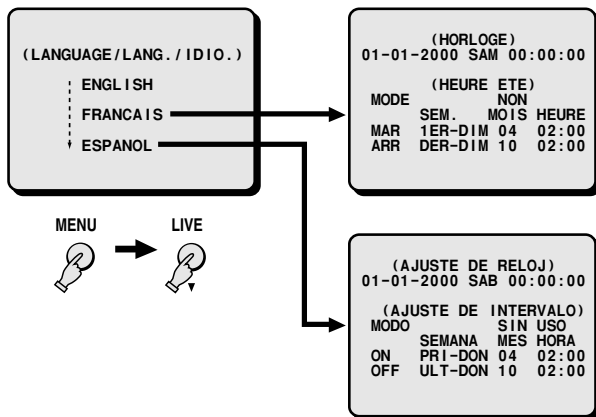

CLOCK AND DAYLIGHT SAVING SETTING

(CLOCK SET)

The default setting is as indicated below. The clock will start after the actual time and date are set and the operations under (DAYLIGHT SET) are completed.

Default clock settings: 01:01:2000 SAT 00:00:00
(January 1, 2000 at 00:00)

- 1 Press the MENU button 2 times to display the (CLOCK SET) menu.
- 2 **Example: Setting the clock to October 15, 1999 at 3:20 PM**
 - 1 Press the + (or -) button to set the month (10), then press the ► button.
 - 2 Press the + (or -) button to set the day (15), then press the ► button.
 - 3 Press the + (or -) button to set the year (1999), then press the ► button.
 - 4 Press the + (or -) button to set the hours (15), then press the ► button.
 - 5 Press the + (or -) button to set the minutes (20), then press the ► button.

NOTE: The day of the week (SAT) will be automatically set according to the date entered.
- 3
 - Press the ▼ button to go to the (DAYLIGHT SET).
 - Press the MENU button to go to the next menu screen, or
 - Press the EXIT button to exit the menu display.

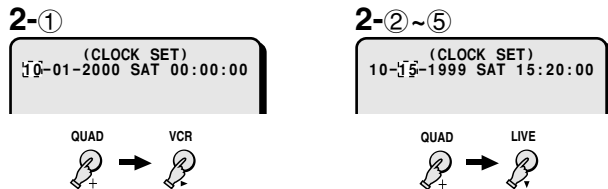

NOTE: To set the display mode for the title, refer to "DISPLAY SET (CLOCK, TITLE)" on page 29.

(DAYLIGHT SET)

The default daylight saving time function setting is "NO USE", so the daylight adjustment will not be made.

If the unit will be used in an area where there is a daylight saving time change, set it to "USE", then if necessary, set when the daylight saving time is changed.

The default settings are:

Daylight saving time from the first Sunday of April, at 2:00 AM (1ST-SUN 04 02:00) to last Sunday of October, at 2:00 AM (LST-SUN 10 02:00).

■ TO MAKE CHANGES TO THE SETTINGS

- 1 Press the ▼ button to highlight the NO USE setting, then press the + (or -) button to select "USE", and press the ▼ button one more time.
- 2 **Example: Setting the daylight saving time from the second Tuesday of May at 3:00 AM, to the fourth Tuesday of September at 3:00 AM.**
 - 1 Press the + (or -) button to set the WEEK (2ND), then press the ► button.
Menu: 1ST, 2ND, 3RD, 4TH or LST (first, second, third, fourth or last)
 - 2 Press the + (or -) button to set the WEEK (TUE), then press the ► button.
Menu: SUN, MON, TUE, WED, THU, FRI, SAT or SUN
 - 3 Press the + (or -) button to set the MON (05), then press the ► button.
Menu: 1, 2, 3, 4 11, 12
(for January, February, March December)
 - 4 Press the + (or -) button to set the TIME (03), then press the ► button.
 - Following the same procedure as above, set when the time is changed back from daylight saving time to standard time (the OFF settings).
- 3
 - Press the MENU button to go to the next menu screen, or
 - Press the EXIT button to exit the menu display.

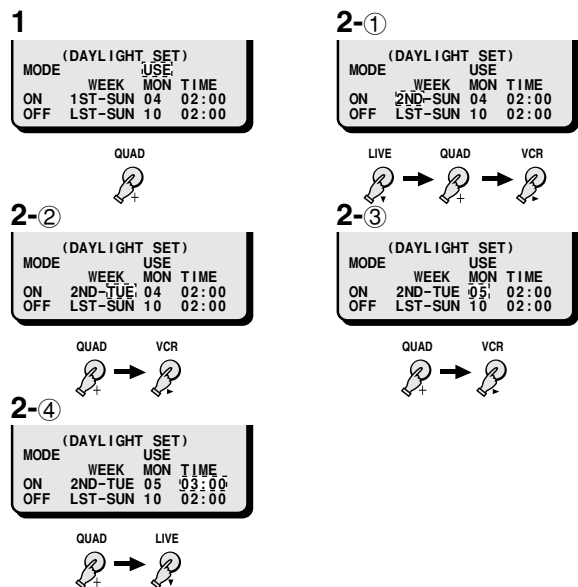

When a picture from a camera is displayed on-screen the camera number (1 to 4) is displayed at the bottom of the image. You can enter a camera title, such as the camera location (up to 10 characters), that will be displayed instead of the camera number.

(TITLE SET)

- 1** Press the MENU button 3 times to display the (TITLE SET) menu.
- 2** Example: To set the title "GATE-1F" for the camera 1 and "HALL-2F" for camera 2.
 - ① Press the + (or -) button to set the first character "G", then press the ► button.
By pressing the + (or -) button repeatedly, the characters are selected as follows:
 - **Letters:** A, B, C,...X, Y, Z
 - **Numbers:** 0, 1,...8, 9
 - **Symbols:** - : . / * _
 - ② Following the same procedure, enter the rest of the title "ATE-1F".
 - ③ Press the ▼ button to set the cursor at the first character location for camera 2.
Press the + (or -) button to set first character "H", then press the ► button.
 - ④ Following the same procedure, enter the rest of the title "ALL-2F".
- 3**
 - Press the MENU button to go to the next menu screen, or
 - Press the EXIT button to exit the menu display.

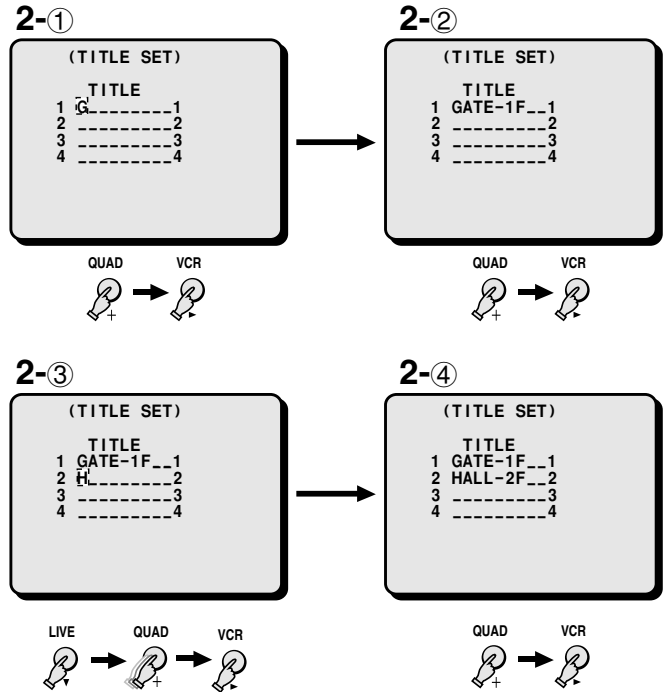

NOTE: To set the display mode for the title, refer to "DISPLAY SET (CLOCK, TITLE)" on page 29.



When an alarm trigger is received from sensors such as a door bell, movement sensor, etc. you can set the display mode and the recording mode for the pictures from the concerned camera.

(ALARM SET)

Changing the Settings

- 1 Press the **MENU** button 4 times to display the **(ALARM SET)** menu.
- 2 Press the **▼** button to highlight the setting to modify.
- 3 Using the **+** (or **-**) button, select the desired setting, then press the **▼** button.
 - Repeat step 3, until all the settings are as desired.
- 4  Press the **MENU** button to go to the next menu screen, or  Press the **EXIT** button to exit the menu display.

1, 2

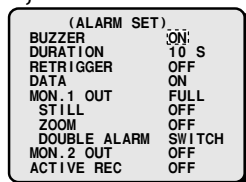

3

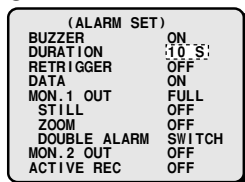

ALARM SET menu

BUZZER

ON: A buzzer will be heard when an alarm trigger is received. (Default setting)

OFF: The buzzer will not be heard.

DURATION

The alarm duration can be set to: 1, 2, 3, 4, 5, 10 (Default setting), 30 seconds, CC, NC

CC: The alarm will go on for as long as the alarm signal is received (minimum 1 second).

NC: The alarm will continue until canceled.

RETRIGGER

To set if an alarm is received while the unit is already in alarm mode.

OFF: The unit will not receive another alarm, while one is already being received. (Default setting)

ON: During alarm mode, other alarm triggers will be received and the alarm duration will be extended.

DATA

The camera number, date, time, type of the alarm can be recorded. (To view the recorded alarm data, refer to **"ALARM DATA DISPLAY"** on page 33.)

ON: The alarm data is recorded. (Default setting)

OFF: The alarm data is not recorded.

MON.1 OUT

FULL: If an alarm trigger is received while in 4 divisions split screen, the picture from the camera corresponding to the alarm input will be displayed full screen. (Default setting)
If **"FULL"** is selected, refer to **"STILL"**, **"ZOOM"** and **"DOUBLE ALARM"** below for further settings.

QUAD: If an alarm trigger is received while in full screen, the display mode will switch to 4 divisions split screen.
If **"QUAD"** is selected, refer to **"STILL"** and **"ZOOM"** below for further settings.

NC: The display mode will remain unchanged when an alarm trigger is received.

STILL

ON: The image from the camera corresponding to the alarm trigger will be frozen.

OFF: The image will not be frozen. (Default setting)

ZOOM

ON: The image from the camera corresponding to the alarm trigger will be zoomed in.

OFF: The image will not be zoomed in. (Default setting)

DOUBLE ALARM

This item is only displayed and can only be set if **"MON.1 OUT"** above is set to **"FULL"**.

SWITCH: The picture from each concerned camera will be displayed sequentially at 1 second interval. (Default setting)

FIRST: The picture from the first alarm received only is displayed.

LAST: The picture from the last alarm received is displayed.

MON.2 OUT

ON: Monitor 2 display will switch to full screen alarm display, when an alarm trigger is received.

OFF: Monitor 2 display will not change. (Default setting)

ACTIVE REC

ON: When an alarm trigger is received, the camera signals corresponding to the alarm trigger are recorded in priority.

OFF: When an alarm trigger is received, the camera signals are recorded normally. (Default setting)

NOTE: There are two ACTIVE REC alarm recording modes **"MODE1"** and **"MODE2"** that can be set in the **(SENSOR SET)** menu (see page 26).

You can set an area of the screen to be used as a sensor. You can also set the recording mode (ACTIVE REC) for sensor recording, when the sensor sends a trigger as it detects a movement.

(SENSOR SET)

Setting the ACTIVE REC Mode

- 1 Press the MENU button 5 times to display the (SENSOR SET) menu.
- 2 Press the ▼ button to highlight the setting to modify.
- 3 Using the + (or -) button, select the desired setting, then press the ▼ button.
 - Repeat step 3, until all the settings are as desired.
- 4 Press the NEXT button to go to the POSITION/LEVEL SET sub-menu, Press the MENU button to go to the next menu screen, or Press the EXIT button to exit the menu display.

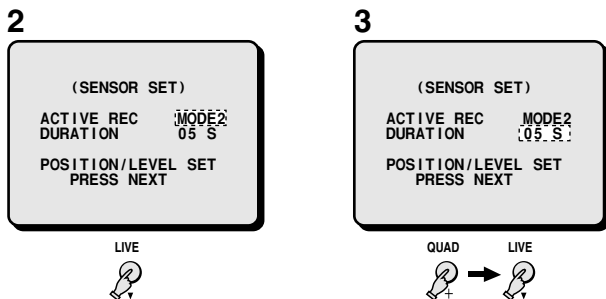

SENSOR SET menu

ACTIVE REC

MODE1: The live pictures from the camera corresponding to the alarm trigger only are recorded.

MODE2: The live pictures from the camera corresponding to the alarm trigger are recorded together with the pictures from the other cameras. (Default setting)

NOTE:

For further details, please refer to the example on the next page.

DURATION

The recording duration can be set to:

01, 02, 03, 04, 05 (Default setting), 10, 30 seconds

SETTING THE SENSOR POSITION AND SENSITIVITY LEVEL

Example: To adjust the camera 2 sensor position and sensitivity level to 3

- 1 From the (SENSOR SET) menu, press the NEXT button twice to go to the sub-menu for camera 2.
 - The sub-menu for each camera is selected by pressing the NEXT button.
 - The camera live picture is displayed, and the sensor position and sensitivity can be adjusted for that camera.
- 2 Using the ▼ (or ►) button move the sensor frame down (or right) to the desired sensor area position.
 - Press and hold the SHIFT button, then press the ▼ button to move the sensor frame up.
 - Press and hold the SHIFT button, then press the ► button to move the sensor frame to the left.
 - Press and hold the SHIFT button, then press the + (or -) button to adjust the bright of sensor frame.



- 3 Press the + (or -) button to raise (or lower) the sensor sensitivity level (03).

NOTE: The displayed frame will flash if there is movement within the sensor area during the setting.

The available sensitivity levels are:

OFF (not used), 1, 2,.....10 (10 being the most sensitive)

- 4 Press the EXIT button to return to the menu display, Press the MENU button to go to the next menu screen, or Press the EXIT button to exit the menu display.

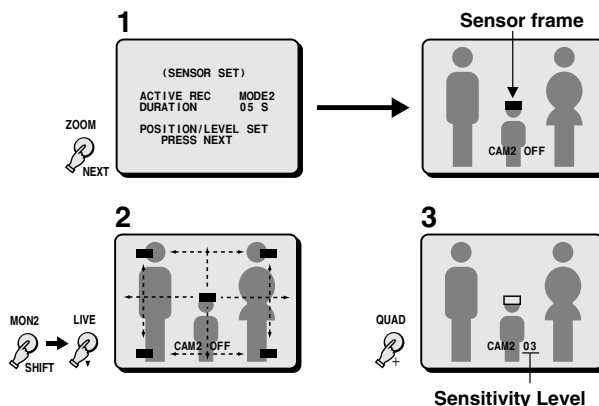

ACTIVE REC Settings Examples

Example 1: Recording on the tape when an alarm trigger is received from camera 2

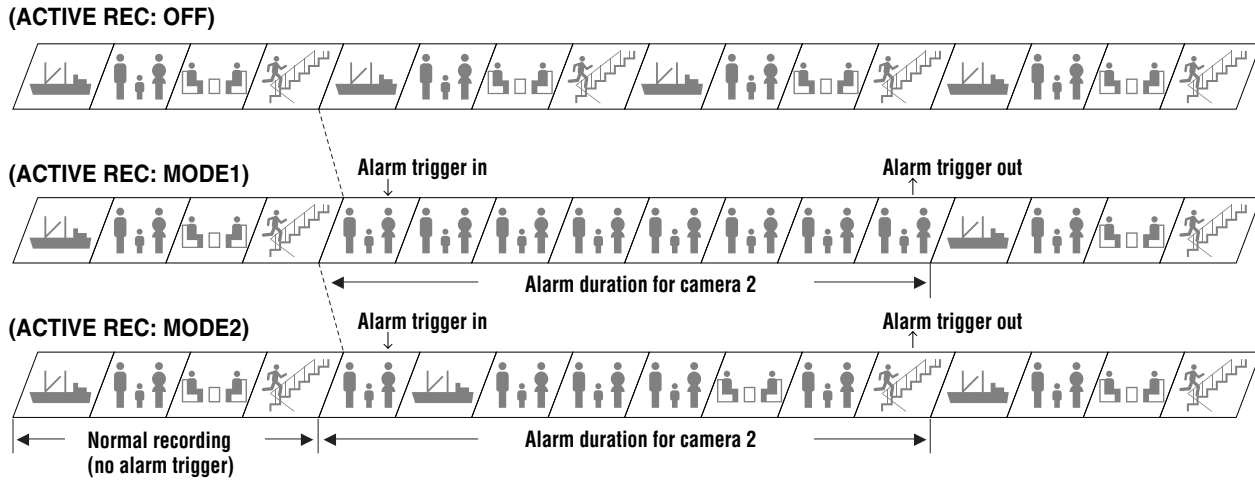

Example 2: Recording on the tape when an alarm trigger is received from camera 4 when an alarm trigger has already been received from camera 2

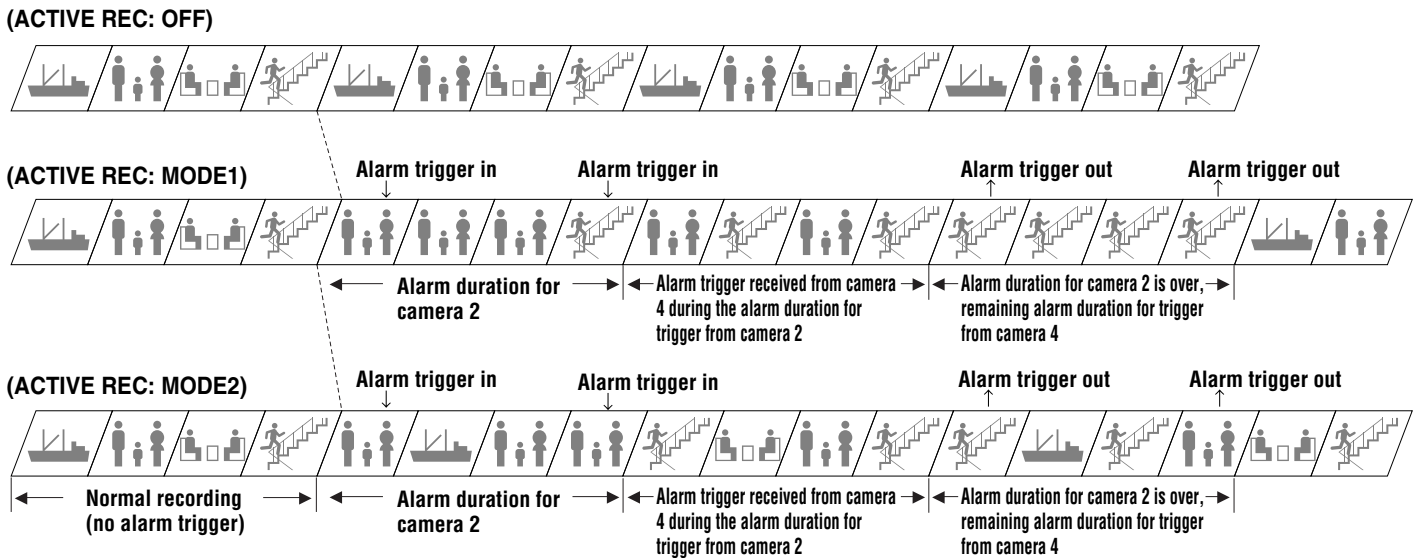

You can set a DAY and a NIGHT range for the 24 hour day period, in order to set the VCR recording for each camera accordingly.

(TIMER SET)

- 1 Press the MENU button 6 times to display the (TIMER SET) menu.
- 2 Example: Day period recording from 7:30 AM to 7:30 PM
Night period recording from 7:30 PM to 7:30 AM

- ① Using the + (or -) button, select (7) for the starting hour of the DAY period, then press the ► button.
- ② Using the + (or -) button, select (30) for the starting minutes of the DAY period, then press the ► button.
Using the same method, enter the settings for the starting hour/minutes of the NIGHT period.

- 3 Example: Setting cameras 1 and 4 to be recorded during the day but not during the night, and cameras 2 and 3 to be recorded during the night but not during the day.

CAMERA 1: Set DAY to "ON", NIGHT to "OFF".

CAMERA 2: Set DAY to "OFF", NIGHT to "ON".

CAMERA 3: Set DAY to "OFF", NIGHT to "ON".

CAMERA 4: Set DAY to "ON", NIGHT to "OFF".

- ① Press the ▼ button to highlight the CAMERA 1 setting under DAY, then if necessary press the + (or -) button to select the desired setting (ON).
- ② Press the ► button to highlight the setting under NIGHT, then if necessary press the + (or -) button to select the desired setting (OFF).
- ③ Press the ▼ button to switch to the CAMERA 2 setting, and repeat the setting procedure above.

Following the same procedure as above, select the CAMERA 3 and 4 settings.

- 4 Press the MENU button to go to the next menu screen, or
Press the EXIT button to exit the menu display.

NOTE:

- The OFF and ON settings made in this menu will not affect the display of the camera signals on the monitor. They only set when these signals are recorded if a timelapse or real time VCR is connected to this unit for recording.
- When there is an external alarm trigger and sensor alarm trigger for a camera, the signals from that camera will be recorded even if the "OFF" setting is selected in this menu.

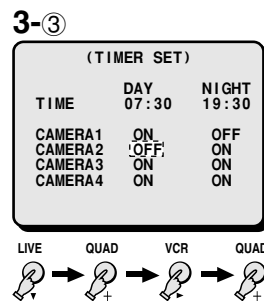
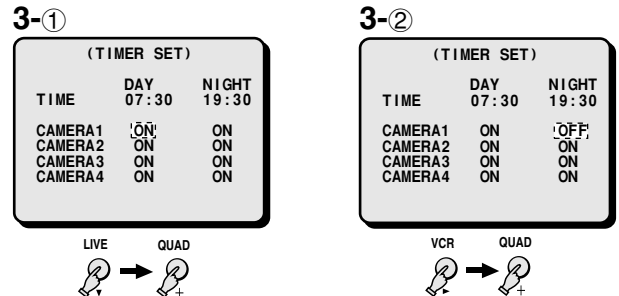
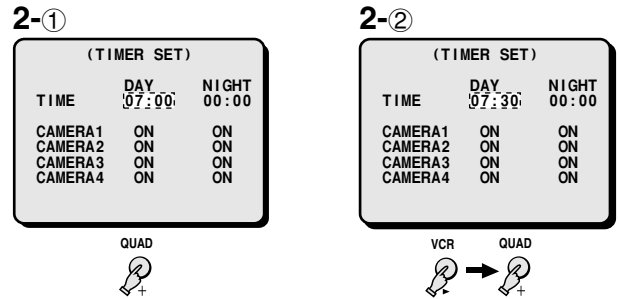

Sample setting

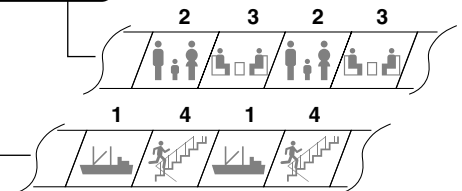
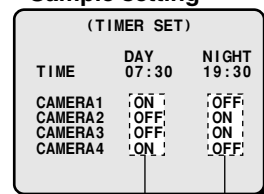

CLOCK, TITLE DISPLAY AND MONITOR SETTINGS

Menu 7

(DISPLAY SET)

The clock and the camera title settings entered in the menus (CLOCK SET) and (TITLE SET) can be displayed on-screen.

Setting the Display Mode for the Clock and Camera Title

- 1 Press the **MENU** button 7 times to display the (DISPLAY SET) menu.
- 2 Using the **+** (or **-**) button, select the desired setting, then press the **▼** button.
 - Following this procedure, select the settings for LIVE CLOCK, TITLE and VCR PB CLOCK, TITLE.
- 3 Press the **NEXT** button to go to the POSITION SET sub-menu, then one more press **NEXT** button to return to the (DISPLAY SET) menu. Press the **▼** button to go to the next menu (MONITOR SET).
- 4 Press the **MENU** button to go to the next menu screen, or Press the **EXIT** button to exit the menu display.

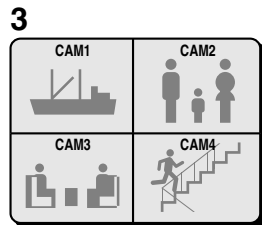
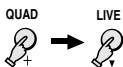
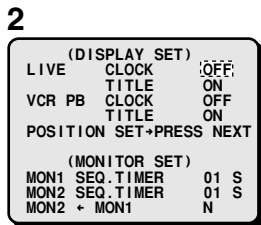

DISPLAY SET menu

LIVE CLOCK

- ON:** The clock is displayed during live picture mode.
OFF: The clock is not displayed during live picture mode. (Default setting)

LIVE TITLE

- ON:** The camera title is displayed during live picture mode. (Default setting)
OFF: The camera title is not displayed during live picture mode.

VCR PB CLOCK

- ON:** The clock is displayed during VCR playback picture mode.
OFF: The clock is not displayed during VCR playback picture mode. (Default setting)

VCR PB TITLE

- ON:** The camera title is displayed during VCR playback picture mode. (Default setting)
OFF: The camera title is not displayed during VCR playback picture mode.

SETTING THE CAMERA TITLE AND THE CLOCK DISPLAY POSITION (POSITION SET)

- 1 From the (DISPLAY SET) menu, press the **NEXT** button. The 4 divisions split screen display mode is selected.
- 2 Using the **+** (or **-**) button, set the camera title display position. (Select among the 4 positions.)
- 3 Using the **▼** button, set the clock display position.
NOTE: To move the display in the opposite direction, press and hold the **SHIFT** button, then press the **▼** button.
- 4 Press the **NEXT** button to return to the (DISPLAY SET) menu. Press the **MENU** button to go to the next menu screen, or Press the **EXIT** button to exit the menu display.

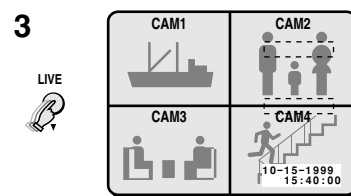
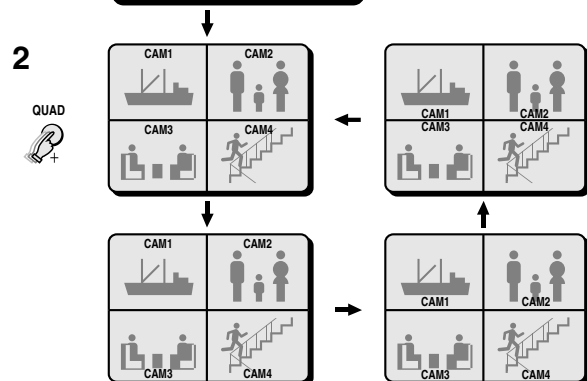
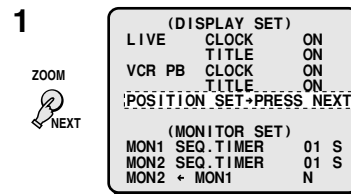

(MONITOR SET)

You can set the display sequence speed on the monitors and have monitor 1 display the same image as monitor 2.

Setting the Monitor Display

1 Press the **NEXT** button to return to the **(DISPLAY SET)**.

2 Press the **▼** button to highlight the setting to modify. Using the **+** (or **-**) button, select the desired setting, then press the **▼** button.

Following this procedure, select the settings or MON1, MON2 SEQ. TIMER and MON2 ← MON1.

3  Press the **MENU** button to go to the next menu screen, or

 Press the **EXIT** button to exit the menu display.

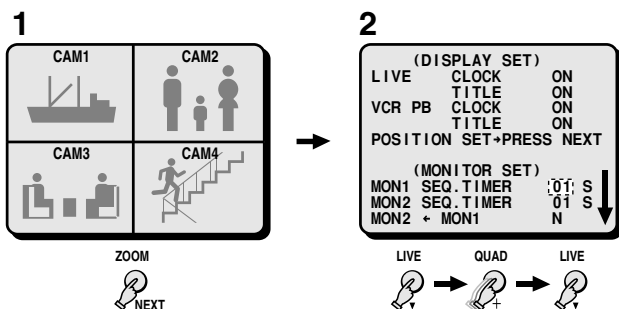

MONITOR SET menu

MON1 SEQ. TIMER

To set the display sequence speed (interval) on monitor 1.

The available intervals are:

01 (Default setting), 02, 03, 04, 05, 10, 20, 30 seconds

MON2 SEQ. TIMER

To set the display sequence speed (interval) on monitor 2.

The available intervals are:

01 (Default setting), 02, 03, 04, 05, 10, 20, 30 seconds

MON2 ← MON1

To have monitor 1 display the same image as monitor 2.

N (No): Monitor 2 will only display camera live picture, in full screen or sequential display mode. (Default setting)

Y(Yes): The display on monitor 2 will be the same as the one on monitor 1.

VCR SIGNAL INPUT/OUTPUT AND COMPUTER CONTROL SETTING

Menu 8

(VCR SET)

You must set this unit output to match the type (Timelapse or Real time VCR) and settings of the VCR used for recording.

Setting the VCR Output

- 1 Press the MENU button 8 times to display the (VCR SET) menu.
- 2 Press the ▼ button to highlight the setting to modify, then using the + (or -) button select the desired setting. Following this procedure, select the settings for VCR MODE, REC SPEED, ALARM REC SPEED and COLOR KILLER.
- 3 Press the ▼ button to go to the next menu (VIDEO LOSS SET), (RS232C SET),
 Press the MENU button to go to the next menu screen, or
 Press the EXIT button to exit the menu display.

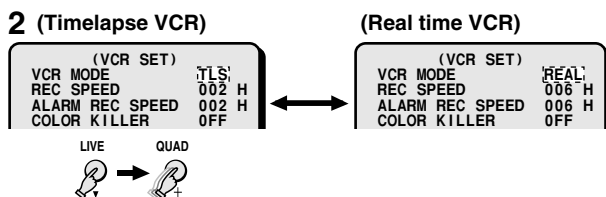

VCR SET menu

If the VCR is not Equipped with a SW (switching) Output Connector

VCR MODE

TLS: If using a timelapse VCR. (Default setting)

REAL: If using a real time VCR.

REC SPEED

The recording speed settings on this unit correspond to recording durations on a T-120 tape.

With a timelapse VCR

Set the recording speed to match the recording speed of the timelapse VCR.

The available speeds are: 002 (2H) (Default setting), 012 (12H), 024 (24H), 048 (48H), 072 (72H), 096 (96H), 120, 168, 240, 360, 480, 720, 960 (960H)

With a real time VCR

Set the recording speed to match the recording speed of the real time VCR.

The available speeds are: 006 (6H) (Default setting), 018 (18H), 030 (30H), 048 (48H), 072 (72H), 096 (96H), 120, 168, 240, 360, 480, 720, 960 (960H)

NOTE: Real time VCRs speed is based on a T-160 cassette tape. When setting this unit to 6H, 18H or 30H, refer to the **table 1** for the speed correspondence, and select the speed on the VCR accordingly.

Table 1

REC SPEED setting	Recording speed setting on the real time VCR
006 (6H)	8H (8-hour mode)
018 (18H)	24H (24-hour mode)
030 (30H)	40H (40-hour mode)

ALARM REC SPEED

With a timelapse VCR

Set the recording speed to use when an alarm trigger is received to match the alarm recording speed of the timelapse VCR.

The available speeds are:

002 (2H) (Default setting), 012 (12H), 024 (24H), NC, F2

NC: When an alarm trigger is received, the recording speed is not changed and stays as set under "REC SPEED".

F2: Use this setting when using the SW output terminal on a timelapse VCR that does not output a switching signal in 2H mode.

With a real time VCR

Set the recording speed to use when an alarm trigger is received to match the alarm recording speed of the real time VCR.

The available speeds are:

006 (6H) (Default setting), 018 (18H), NC, F6

NC: When an alarm trigger is received, the recording speed is not changed and stays as set under "REC SPEED".

F6: Use this setting when using the SW output terminal on a real time VCR that does not output a switching signal in 6H mode.

COLOR KILLER

Used to playback a tape recorded through a black and white multiplexer, using a color multiplexer.

ON: When using a black and white tape, the color killer function is active.

OFF: The color killer function is not active. (Default setting)

If the VCR is Equipped with a SW (switching) Output Connector (using the VCR switching signal)

Make the connection from this unit to the VCR SW output connector. The video signal output by this unit will be automatically switched to the recording speed according to the switching signal output by the VCR (switching pulse setting on the VCR).

The (VCR SET) menu "REC SPEED" and "ALARM REC SPEED" items do not need to be set.

If a switching signal is not output at the switching terminal

Some VCR models may not output a switching signal in 2H or 6H mode. In such a case, make the settings as indicated in the table below.

VCR SET menu settings	Timelapse VCR	Real time VCR
REC SPEED	002 (2H)	006 (6H)
ALARM REC SPEED	002 (F2)	006 (F6)

NOTE: When the alarm recording speed is set to F2 or F6, the recording speed is fixed to 2H or 6H. Therefore, when using a speed other than 2H or 6H, do not use the F2 or F6 setting.

VCR SIGNAL INPUT/OUTPUT AND COMPUTER CONTROL SETTING

Menu 8

(VIDEO LOSS SET)

When the live picture signal feed is interrupted, you can set the action taken, and if the video loss is recorded as alarm data. First set "VIDEO LOSS" to "ON", then make the "DATA" and "DISPLAY" settings as desired.

Setting the Video Loss Mode

- 1 Press the ▼ button to highlight the setting to modify.
- 2 Using the + (or -) button, select the desired setting, then press the ▼ button.
Following this procedure, select the settings for DATA and DISPLAY.
- 3 Press the ▼ button to go to the next menu,
 Press the MENU button to go to the next menu screen, or
 Press the EXIT button to exit the menu display.

1, 2

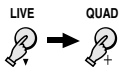
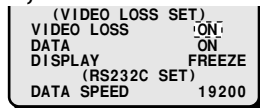

(RS232C SET)

Connect the multiplexer to a computer, using a 9-pin D-SUB cable (sold separately), then set the maximum communication speed between the unit and the computer. For detailed information, refer to "RS232C CONTROL" on page 35.

Changing the Setting

- 1 Press the ▼ button to highlight the setting to modify.
- 2 Using the + (or -) button, select the desired setting.
The available speeds are:
2400, 4800, 9600, 19200 (Default setting) bps
- 3 Press the MENU button to go to the next menu screen, or
 Press the EXIT button to exit the menu display.

1, 2

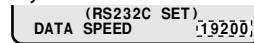

VIDEO LOSS SET menu

VIDEO LOSS

You can set the action to take when there is an interruption in the video signal feed.

- ON:** When there is video loss, the image just previous to the interruption is frozen on-screen or color bars are displayed (see "DISPLAY" below) and "VIDEO LOSS" is displayed on-screen. (Default setting)
- OFF:** When there is video loss, "NO VIDEO" is displayed on-screen.

DATA

You can set the data (date, time, etc) of the video losses to be recorded as alarm data. (To view the recorded data, refer to "ALARM DATA DISPLAY" on page 33.)

- ON:** The video losses data is recorded as alarm data. (Default setting)
- OFF:** The video losses data is not recorded.

DISPLAY



You can set the display mode when there is an interruption in the video signal feed.

- FREEZE:** When there is video loss, the image just previous to the interruption is frozen on-screen. (Default setting)
- TEST:** When there is video loss, color bars are displayed on-screen.

According to the settings entered in the (ALARM SET), (SENSOR SET) and (VIDEO LOSS SET) menus, information about the alarms (alarm data) can be recorded. Up to 100 alarm data entries can be displayed on-screen (separate 13).

(ALARM DATA)

Displaying the Alarm Data

- 1 Press the MENU button 9 times to display the (ALARM DATA) menu.
 - The first screen (1/13) of alarm data entries is displayed.
- 2 To display the next screen of alarm data entries, press the NEXT button.
- 3  Press the EXIT button to exit the menu display, or  Press the MENU button to normally picture, then press the MENU button once to display the menu display.

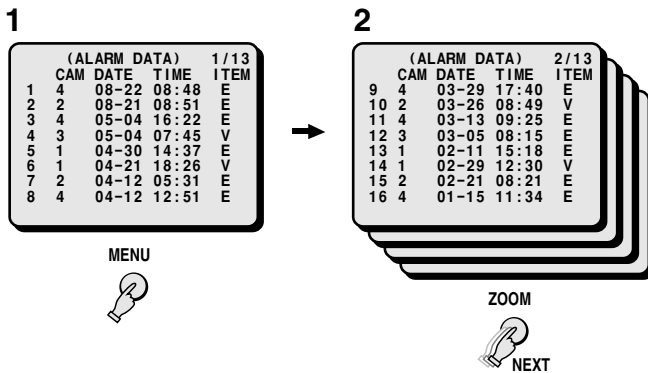

The codes in the ITEM column indicate the type of alarm data.

E: External alarm trigger (see page 25)

V: Video loss (see page 32)

NOTE:

- When the number of recorded alarm data entries reaches 100, the oldest ones are erased as new ones are recorded.
- The alarm data screens are only displayed when alarm data entries are recorded.

ALARMS OPERATIONS

There are two types of alarms; the alarms set by an external alarm trigger and the alarms set by a loss of the video signal.

EXTERNAL ALARMS

When external inputs such as a door bell, an interphone, etc., are connected to the **CONTROL** terminal (pins 1 – 4), they will send alarm triggers automatically. On the monitor screen, the alarm display will identify the camera corresponding to the alarm trigger.

Example: If an alarm trigger is received for camera 4 (in 4 divisions split screen)

- 1 The buzzer is heard and the camera 4 indicator light.**
The alarm output changes from HI (5V) to LOW (0V).
- 2 The image from camera 4 and the camera number (04) will be displayed on monitor 1, EA (External Alarm) will flash at the left of the camera number.**
The action taken here will depend on the settings entered in the (ALARM SET) menu (see page 25).

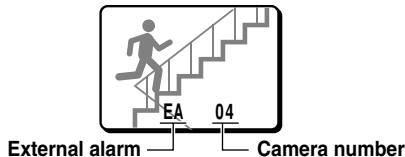

NOTE:

- When the alarm operation is over, the display will return to the mode preceding the alarm trigger.
- An alarm trigger can also be received at a terminal for which a camera is not connected to. In such a case, a grey screen will be displayed and **EA** (External Alarm) and the corresponding number will be displayed.

Resetting the Alarm

- For an alarm in full screen display mode, press the corresponding camera select button.
- For an alarm in 4 division split screen display mode, press the corresponding camera select button to switch to full screen display mode then press the corresponding camera select button one more time.

NOTE:

- The alarm display mode on monitor 1 is selected according to the settings entered in the (**MONITOR SET**) menu.
- During normal monitoring operations the camera select indicator lights according to the displayed camera. If there is an alarm trigger for another camera, the indicator will flash.

VIDEO LOSS ALARM

If there is an interruption of the video signal, the buzzer is heard, and the image just previous to the interruption is frozen on-screen or color bars are displayed and **“VIDEO LOSS”** will flash on-screen.

The action taken will depend on the settings entered in the (VIDEO LOSS SET) menu (see page 32).

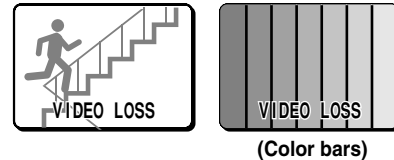

NOTE:

- If a video signal is not present from the beginning, then **“NO VIDEO”** will be displayed on a gray screen. This will not trigger a video loss alarm.
- The video loss alarm is recorded until the video signal is restored.

Resetting the Alarm

- For an alarm in full screen display mode, press the corresponding camera select button, **“NO VIDEO”** will be displayed on a grey screen.
- For an alarm in 4 division split screen display mode, press the corresponding camera select button to switch to full screen display mode. Then, press the corresponding camera select button one more time and **“NO VIDEO”** will be displayed on a grey screen.

NOTE:

- The alarm display mode on monitor 1 is selected according to the settings entered in the (**ALARM SET**) menu.
- During normal monitoring operations the camera select indicator lights according to the displayed camera. If there is an alarm trigger for another camera, the indicator will flash.
- If the alarm is not reset, **“VIDEO LOSS”** will be displayed until normal live picture signals are restored.

RS232C CONTROL

CONNECTION

Connect a 9-pin D-SUB cable (sold separately) from the RS232C terminal on the rear panel to the computer serial connector.

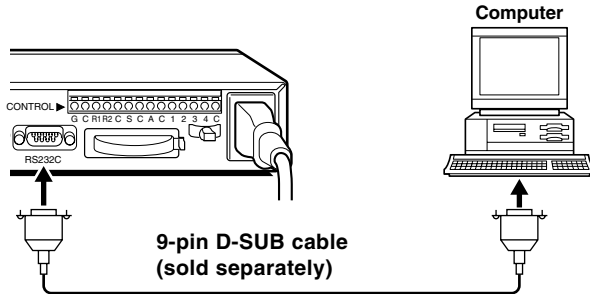

Setting the Data Transmission Speed

After the connection is made, set the data transmission speed in the (RS232C SET) menu (see page 32).

INTERFACE SPECIFICATIONS

For the RS232C terminal specifications, refer to page 4.

DATA FORMAT

Mode	Asynchronous
Character length	8 bits
Data transmission speed	2400, 4800, 9600, 19200 bps (set in the (RS232C SET) menu)
Parity check	None
Stop bit	One bit

TRANSMISSION PROTOCOL

The transmission is based on 1 byte units. After the computer has transmitted 1 byte, it will wait for an answer from this unit, then send the following byte of data.

The command ON (F6) is sent to start, and the command OFF (F7) is sent to finish. This unit will receive the commands, and will reply to each command by ACK (OA). (Refer to "Command table 4" on page 38.)

COMMANDS

COMMANDS AVAILABLE FROM THE COMPUTER

1-4 (90-93)

To select the picture from a camera to be displayed full screen on monitor 1.

QUAD (83)

To display a 4 divisions split screen on monitor 1.

SEQUENCE (87)

To switch the display mode from full screen to sequential display on monitor 1.

ZOOM (85)

To zoom in the picture on monitor 1.

STILL (86)

To freeze the picture on monitor 1.

LIVE (80)

To select the live input mode.

VCR (81)

To select the VCR playback input mode.

MON2 (88)

To set the output at monitor 2, it can be used in combination with the monitor 1 display.

MENU (74)

To display the menu on monitor 1.

+ (65), - (66)

To select settings (ON/OFF, numbers, letters, symbols) in the menus.

→ (63), ↓ (64)

To change selection in the menus. (To move the cursor up/down, right/left.)

NEXT (75)

To select the sub-menu in (SENSOR SET) and (DISPLAY SET) menus.

EXIT (76)

To go to the next menu, or to exit the menu mode.

MENU RESET (E1)

To reset all the values of the displayed menu to the default values.

CLOCK ADJUST (E0)

To reset the clock minutes and seconds setting to 00:00.

SECURITY LOCK ON (69)

To set the security lock.

SECURITY LOCK OFF (6A)

To cancel the security lock.

RS232C CONTROL

INFORMATION GATHERING COMMANDS

STATUS SENSE(D7)

When this command is sent from the computer, this unit will send a 5-byte response (see **Table 1**).



STATUS SENSE(D7) byte assignment (Table 1)

Fourth and fifth bytes are reserved.

First byte

Bit		Bit state information
7	LIVE/VCR indication	0: LIVE picture mode 1: VCR playback mode
6	Monitor 1 display mode indication	000: Full screen
5		001: 4 divisions split screen
4		010: Menu display
3	Monitor 1 displayed channel depending on the display mode indication	(Full screen mode)
2		0000: Channel 1
1		0001: Channel 2
0		0010: Channel 3
		0011: Channel 4
		(4 divisions split screen)
		0000: 4 divisions split screen (channels 1, 2, 3, 4)
		(Menu display)
		0000: (LANGUAGE/LANG./IDIO.) menu
		0001: (CLOCK SET) menu
		0010: (TITLE SET) menu
		0011: (ALARM SET) menu
		0100: (SENSOR SET) menu
		0101: (TIMER SET) menu
		0110: (DISPLAY SET) menu
		0111: (VCR SET) menu
	1000: (ALARM DATA) menu	

Second byte

Bit		Bit state information
7	EXT/ALARM indication	EXT and ALARM are ON
6	VIDEO LOSS indication	VIDEO LOSS is ON
5	SENSOR indication	SENSOR is ON
4	Reserved	0
3	Monitor 1 display state mode indication	0000: Normal display mode
2		0001: Sequential display mode
1		0010: Zoomed in mode
0		0011: Still image mode
		0100: Frozen zoomed in image
		0101: Zoomed in still image
		0110: Zoom range setting mode
		0111: Zoomed in still image range setting mode

Third byte

Bit		Bit state information
7	Reserved	—
6	Reserved	—
5	Monitor 2 operation	MON2 setup
4	Monitor 2 operation	0: Full screen 1: Sequential display
3	Monitor 2 displayed channel	0000: Channel 1
2		0001: Channel 2
1		0010: Channel 3
0		0011: Channel 4

ALARM STATUS SENSE(D5)

The external and video loss alarm states are indicated by a 6-byte response (see **Table 2**).



ALARM STATUS SENSE(D5) byte assignment (Table 2)

First byte

Bit	
7	0
6	0
5	0
4	0
3	ALARM ON 4
2	ALARM ON 3
1	ALARM ON 2
0	ALARM ON 1

Second byte

Bit	
7	0
6	0
5	0
4	0
3	0
2	0
1	0
0	0

Third byte

Bit	
7	0
6	0
5	0
4	0
3	SENSOR 4
2	SENSOR 3
1	SENSOR 2
0	SENSOR 1

Fourth byte

Bit	
7	0
6	0
5	0
4	0
3	0
2	0
1	0
0	0

Fifth byte

Bit	
7	0
6	0
5	0
4	0
3	VIDEO LOSS 4
2	VIDEO LOSS 3
1	VIDEO LOSS 2
0	VIDEO LOSS 1

Sixth byte

Bit	
7	0
6	0
5	0
4	0
3	0
2	0
1	0
0	0

RS232C CONTROL

■ COMMANDS AVAILABLE FROM THE MULTIPLEXER

ACK(0A)

Response when this unit receives a command.

NAK(0B)

Response if this unit did not receive the command.

ALARM(BF)

When there is an alarm, this command is sent as header. Then, the alarm information is sent in a 1-byte transmission (see **Table 3**).

ALARM information (Table 3)

Bit		Bit state information
7	Alarm information indication	01: External
6		10: Video loss 11: Sensor alarm
5	Reserved	0
4	Reserved	0
3	Camera number indication	0011: CAMERA NO. 4
2		0010: CAMERA NO. 3
1		0001: CAMERA NO. 2
0		0000: CAMERA NO. 1

■ OTHER COMMANDS

ENTER(40)

When numeric commands are all sent, this command is used to enter the transmitted value.

CLEAR(56)

To erase multiple byte commands.

RS232C CONTROL

COMMAND TABLE (TABLE 4)

The commands available are indicated in the table.

If a function is not available on the unit, the command will not operate even if sent.

	0	1	2	3	4	5	6	7	8	9
0				0	ENTER				LIVE	FULL 1
1				1					VCR PB	FULL 2
2				2				VERSION	(MULTI)	FULL 3
3				3		←	→	SHIFT	QUAD	FULL 4
4				4		↑	↓	MENU	PLUS	
5				5			+	NEXT	ZOOM	
6				6		CLEAR	-	EXIT	STILL	
7				7					SEQ.	
8				8					MON 2	
9				9				SECURITY LOCK ON		
A	ACK							SECURITY LOCK OFF		
B	NAK								(POWER ON/OFF)	
C									(SET ON)	
D									(SET OFF)	
E										
F										

	A	B	C	D	E	F
0					CLK. ADJ.	
1					MENU RESET	
2						
3						
4						
5					ALARM STATUS SENSE	
6						
7					STATUS SENSE	
8						
9						
A						
B						
C						
D						
E						
F		ALARM				

SPECIFICATIONS

Signal format	: Based on NTSC color signal standard (MPX-CD4) Based on NTSC B/W signal standard (MPX-MD4)
Camera signal input synchronization	: Asynchronous
Camera input terminals (IN)	: VS/VBS, 1.0 Vp-p/75 Ω, BNC connector x 4
Camera output terminals (OUT)	: Throughput of each input, 1.0 Vp-p/75 Ω, BNC connector x 4
VCR input terminal (VCR IN)	
• Composite input	: VS/VBS, 1.0 Vp-p/75 Ω, BNC connector x 1
• S-VHS input terminal (S-VHS VCR IN)	: Separate YC signals, DIN connector (S terminal) x 1 (MPX-CD4 only) Y signal: 1.0 Vp-p/75 Ω, unbalanced, synchronous; C signal: 0.286 Vp-p/75 Ω, unbalanced
VCR output terminal (VCR OUT)	
• Composite output	: VS/VBS, 1.0 Vp-p/75 Ω, BNC connector x 1
• S-VHS output terminal (S-VHS VCR OUT)	: Separate YC signals, DIN connector (S terminal) x 1 (MPX-CD4 only) Y signal: 1.0 Vp-p/75 Ω, unbalanced, synchronous; C signal: 0.286 Vp-p/75 Ω, unbalanced
Monitor 1 output terminal (MONITOR OUT 1)	: VS/VBS, 1.0 Vp-p/75 Ω, BNC connector x 1 Separate YC signals, DIN connector (S terminal) x 1 (MPX-CD4 only) Y signal: 1.0 Vp-p/75 Ω, unbalanced, synchronous; C signal: 0.286 Vp-p/75 Ω, unbalanced Camera live picture or VCR playback picture signal output: full screen, sequential display, 4 divisions split screen
Monitor 2 output terminal (MONITOR OUT 2)	: VS/VBS, 1.0 Vp-p/75 Ω, BNC connector x 1 Camera live picture signal output: full screen (can be set in (MONITOR SET) menu to display the same image as monitor 1)
Control terminal (CONTROL)	
• Alarm input (1 – 4)	: No voltage, make-contact switch input x 4 (Low input)
• Remote input (R1, R2)	: 2-wire type with resistance-based identification system
• Alarm output (A)	: DC 5 V, 5.7 kΩ (Low output)
• Switching input (S)	: Low input, for input signal from SW OUT of timelapse VCR/real time recorder (as per this manufacturer specifications)
• RS-232C terminal	: 9-pin D-SUB
Full screen sequence timing	: Available in full screen, 8 settings (1, 2, 3, 4, 5, 10, 20, 30 sec.)
Monitor on-screen display	: Title (up to 10 characters), date, time selectable
Menu settings	: 9 menus: Language, Clock, Title, Alarm, Sensor, Timer, Display, VCR, Alarm data
Alarm sensor	: Internal, 4 channel (each camera input, selectable)
Back-up function	: Back-up for up to 30 days of the clock settings after connected for 30 hours continuously
Operations	
• Still	: Available for camera live or VCR playback in 4 divisions split screen, full screen and zoomed in picture Can be set using a menu to operate automatically when there is an alarm trigger
• Zoom	: Available for camera live or VCR playback in 4 divisions split screen, full screen and frozen picture In full screen mode can switch from frozen to zoomed in picture
Power	: AC 120 V, 60 Hz
Consumption	: 19 W (MPX-CD4), 14 W (MPX-MD4)
Operating environment	: Temperature: 5 to 40°C, Humidity: 10 to 80%
Dimensions	: 420 (W) x 44 (H) x 325 (D) mm
Weight	: Approx. 3.4 kg

Products are subject to change in design and specifications without notice and without incurring any obligation.

SANYO INDUSTRIAL MULTIPLEXER LIMITED WARRANTY

OBLIGATIONS

In order to obtain warranty service, the product must be delivered to and picked up from an Authorized Sanyo Service Center at the user's expense, unless specifically stated otherwise in this warranty. The names and addresses of Authorized Sanyo Service Centers may be obtained by writing to SFS Corporation, SFC's warranty administrator, at any of the addresses listed below, or by calling (toll-free) 1-800-421-5013.

New Jersey Office
210 Riser Road Little Ferry, NJ 07643
201-641-3000

California Office
1200 W. Artesia Blvd. Compton, CA 90220
310-537-5830

Illinois Office
900 N. Arlington Heights Rd. Itasca, IL 60143
708-775-1414

THIS WARRANTY IS VALID ONLY ON SANYO PRODUCTS PURCHASED OR RENTED IN THE UNITED STATES OF AMERICA, EXCLUDING HAWAII AND ALL U.S. TERRITORIES AND PROTECTORATES. THIS WARRANTY APPLIES ONLY TO THE ORIGINAL RETAIL USER. THE ORIGINAL DATED BILL OF SALE, SALES SLIP OR RENTAL AGREEMENT MUST BE SUBMITTED TO THE AUTHORIZED SANYO SERVICE CENTER AT THE TIME WARRANTY SERVICE IS REQUESTED.

Subject to the OBLIGATIONS above and EXCLUSIONS below, SANYO FISHER (USA) CORPORATION warrants this SANYO product against defects in materials and workmanship for the periods specified below. SFC will repair or replace (at its option) the product and any of its parts which fail to conform to this warranty. The warranty period commences on the date the product was first purchased or rented at retail.

LABOR	PARTS
3 YEARS	3 YEARS

EXCLUSIONS

This warranty does not cover (A) the adjustment of customer-operated controls as explained in the appropriate model's instruction manual, or (B) the repair of any product whose serial number has been altered, defaced or removed.

This warranty shall not apply to the cabinet or cosmetic parts, broken or damaged video heads, knobs or routine maintenance.

This warranty does not apply to uncrating, setup, installation, removal of the product for repair or reinstallation of the product after repair.

This warranty does not apply to repairs or replacements necessitated by any cause beyond the control of SFC including, but not limited to, any malfunction, defect or failure caused by or resulting from unauthorized service or parts, improper maintenance, operation contrary to furnished instructions, shipping or transit accidents, modification or repair by the user, abuse, misuse, neglect, accident, incorrect power line voltage, fire, flood or other Acts of God, or normal wear and tear.

The foregoing is in lieu of all other expressed warranties and SFC does not assume or authorize any party to assume for it any other obligation or liability.

THE DURATION OF ANY WARRANTIES WHICH MAY BE IMPLIED BY LAW (INCLUDING THE WARRANTIES OF MERCHANTABILITY AND FITNESS) IS LIMITED TO THE TERM OF THIS WARRANTY. IN NO EVENT SHALL SFC BE LIABLE FOR SPECIAL, INCIDENTAL OR CONSEQUENTIAL DAMAGES ARISING FROM OWNERSHIP OR USE OF THIS PRODUCT, OR FOR ANY DELAY IN THE PERFORMANCE OF ITS OBLIGATIONS UNDER THIS WARRANTY DUE TO CAUSES BEYOND ITS CONTROL. SOME STATES DO NOT ALLOW LIMITATIONS ON HOW LONG AN IMPLIED WARRANTY LASTS AND/OR DO NOT ALLOW THE EXCLUSION OR LIMITATION OF CONSEQUENTIAL DAMAGES, SO THE ABOVE LIMITATIONS AND EXCLUSIONS MAY NOT APPLY TO YOU.

THIS WARRANTY GIVES YOU SPECIFIC LEGAL RIGHTS. YOU MAY HAVE OTHER RIGHTS, WHICH VARY FROM STATE TO STATE.

ATTENTION

For your protection in the event of theft or loss of this product, please fill in the information below for you own personal records.

Model No. _____

Serial No. _____
(Located on back or bottom side of unit.)

Date of Purchase _____

Purchase Price _____

Where Purchased _____