

SONY®

4-264-055-13(1)

Portable Blu-ray Disc™ / DVD Player

Operating Instructions

Preparations

Playback

Settings and Adjustments

Additional Information



WARNING

To reduce the risk of fire or electric shock, do not expose this apparatus to rain or moisture.

To avoid electrical shock, do not open the cabinet. Refer servicing to qualified personnel only.

The AC power cord must be changed only at a qualified service shop.

Batteries or batteries installed apparatus shall not be exposed to excessive heat such as sunshine, fire or the like.

CAUTION

The use of optical instruments with this product will increase eye hazard. As the laser beam used in this Blu-ray Disc/DVD player is harmful to eyes, do not attempt to disassemble the cabinet. Refer servicing to qualified personnel only.

CAUTION CLASS 3R VISIBLE AND INVISIBLE LASER RADIATION WHEN OPEN AND INTERLOCKS DEFEATED. AVOID DIRECT EYE EXPOSURE.

This label is located on the bottom of the unit.

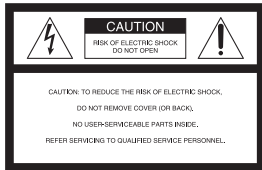

This symbol is intended to alert the user to the presence of uninsulated “dangerous voltage” within the product’s enclosure that may be of sufficient magnitude to constitute a risk of electric shock to persons.



This symbol is intended to alert the user to the presence of important operating and maintenance (servicing) instructions in the literature accompanying the appliance.

Precautions

- To prevent fire or shock hazard, do not place objects filled with liquids, such as vases, on the apparatus.
- Install this unit so that the AC power cord can be unplugged from the wall socket immediately in the event of trouble.
- The player is not disconnected from the AC power source as long as it is connected to the wall outlet, even if the player itself has been turned off.

FCC WARNING

You are cautioned that any changes or modifications not expressly approved in this manual could void your authority to operate this equipment.

The shielded Interface cable (LAN cable) must be used with the equipment in order to comply with the limits for a digital device pursuant to Subpart B of Part 15 of FCC Rules.



This equipment has been tested and found to comply with the limits for a Class B digital device, pursuant to Part 15 of the FCC Rules. These limits are designed to provide reasonable protection against harmful interference in a residential installation. This equipment generates, uses, and can radiate radio frequency energy and, if not installed and used in accordance with the instructions, may cause harmful interference to radio communications. However, there is no guarantee that interference will not occur in a particular installation. If this equipment does cause harmful interference to radio or television reception, which can be determined by turning the equipment off and on, the user is encouraged to try to correct the interference by one or more of the following measures:

- Reorient or relocate the receiving antenna.
- Increase the separation between the equipment and receiver.
- Connect the equipment into an outlet on a circuit different from that to which the receiver is connected.
- Consult the dealer or an experienced radio/TV technician for help.

Owner's Record

The model and serial numbers are located at the bottom of the unit. Record the serial number in the space provided below. Refer to them whenever you call upon your Sony dealer regarding this product.

Model No. _____
Serial No. _____

If this product is not working properly, please call 1-866-909-7669.

Important Safety Instructions

- 1) Read these instructions.
- 2) Keep these instructions.
- 3) Heed all warnings.
- 4) Follow all instructions.
- 5) Do not use this apparatus near water.
- 6) Clean only with dry cloth.
- 7) Do not block any ventilation openings. Install in accordance with the manufacturer's instructions.
- 8) Do not install near any heat sources such as radiators, heat registers, stoves, or other apparatus (including amplifiers) that produce heat.
- 9) Do not defeat the safety purpose of the polarized or grounding-type plug. A polarized plug has two blades with one wider than the other. A grounding type plug has two blades and a third grounding prong. The wide blade or the third prong are provided for your safety. If the provided plug does not fit into your outlet, consult an electrician for replacement of the obsolete outlet.
- 10) Protect the power cord from being walked on or pinched particularly at plugs, convenience receptacles, and the point where they exit from the apparatus.
- 11) Only use attachments/accessories specified by the manufacturer.
- 12) Use only with the cart, stand, tripod, bracket, or table specified by the manufacturer, or sold with the apparatus. When a cart is used, use caution when moving the cart/apparatus combination to avoid injury from tip-over.



- 13) Unplug this apparatus during lightning storms or when unused for long periods of time.

- 14) Refer all servicing to qualified service personnel. Servicing is required when the apparatus has been damaged in any way, such as power-supply cord or plug is damaged, liquid has been spilled or objects have fallen into the apparatus, the apparatus has been exposed to rain or moisture, does not operate normally, or has been dropped.

Do not take apart or remodel the player. Doing so can result in electric shock. Consult your nearest Sony dealer or Sony Service Center for exchange of rechargeable batteries, internal checks or repair.

Notes About the Discs

- To keep the disc clean, handle the disc by its edge. Do not touch the surface. Dust, fingerprints, or scratches on the disc may cause it to malfunction.



- Do not expose the disc to direct sunlight or heat sources such as hot air ducts, or leave it in a car parked in direct sunlight as the temperature may rise considerably inside the car.
- After playing, store the disc in its case.
- Clean the disc with a cleaning cloth. Wipe the disc from the center out.



- Do not use solvents such as benzene, thinner, commercially available disc/lens cleaners, or anti-static spray intended for vinyl LPs.
- If you have printed the disc's label, dry the label before playing.
- Do not use the following discs.
 - A lens cleaning disc.
 - A disc that has a non-standard shape (e.g., card, heart).
 - A disc with a label or sticker on it.
 - A disc that has cellophane tape or sticker adhesive on it.



- Do not resurface the playing side of a disc to remove surface scratches.

Precautions

Road safety

Do not use the monitor unit and headphones while driving, cycling, or operating any motorized vehicle. Doing so may create a traffic hazard and is illegal in some areas. It can also be potentially dangerous to play your headsets at high volume while walking, especially at pedestrian crossings. You should exercise extreme caution or discontinue use in potentially hazardous situations.

On safety

Should any solid object or liquid fall into the cabinet, unplug the player and have it checked by qualified personnel before operating it any further.

On power sources

- If you are not going to use the player for a long time, be sure to disconnect the player from the wall outlet. To disconnect the AC power cord, grasp the plug itself; never pull the cord.
- Do not touch the AC power cord or the AC adaptor with wet hands. Doing so may cause shock hazard.
- Use a commercially available AC plug adaptor, if necessary, depending on the design of the wall outlet.

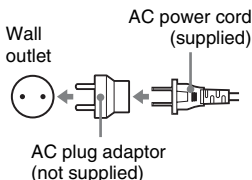

- Do not connect the AC power cord to a traveler's electric transformer, which may generate heat and cause a malfunction.

On temperature increases

Heat may build up inside the player during charging or if it is being used for a long time. This is not a malfunction.

On placement

- Do not place the player in a confined space such as a bookshelf or similar unit.
- Do not cover the ventilation of the player with newspapers, tablecloths, curtains, etc. And do not place the player on a soft surface, such as a rug.
- Do not place the player and adaptors in a location near heat sources, or in a place subject to direct sunlight, excessive dust, sand, moisture, rain, or mechanical shock, or in a car with its windows closed.
- Do not place the player in an inclined position. It is designed to be operated in a horizontal position only.
- Keep the player and discs away from equipment with strong magnet, such as microwave ovens, or large loudspeakers.
- Do not drop or apply strong shock.
- Do not place heavy objects on the player and accessories.

On operation

- If the player is brought directly from a cold to a warm location, or is placed in a very damp room, moisture may condense on the lenses inside the player. Should this occur, the player may not operate properly. In this case, remove the disc and leave the player for about half an hour until the moisture evaporates. Wipe off moisture attached to the LCD surface with tissue etc. Turn on the power again later.
- Keep the lens on the player clean and do not touch it. Touching the lens may damage the lens and cause the player to malfunction. Leave the disc lid closed except when you insert or remove discs.
- Do not use the player in an area subject to excessive dust or cigarette smoke. Dust build-up or cigarette smoke residue on internal components such as the lens may cause the player to malfunction.

On Liquid Crystal Display

- Although manufactured with high precision technology, the LCD may occasionally display dots of various colors. That is not a malfunction.
- Do not place or drop any object onto the LCD surface. Also, do not apply pressure from hands or elbows.
- Do not damage the LCD surface with a sharp edged tool.

On rechargeable battery

- Because of the battery's limited life, its capacity gradually deteriorates over time and repeated use. Exchange a new one for the old one when the battery holds about only half the normal period.
- To prevent battery deterioration, charge the battery at least once every half a year or every year.
- Certain countries may regulate disposal of the battery used to power this product. Please consult with your local authority.

On AC adaptor and car battery adaptor

- Use the supplied adaptors for the player, as other adaptors may cause a malfunction.
- Do not disassemble or reverse-engineer.
- Do not touch the metal parts, as it may cause a short and damage the adaptors, especially if touched by other metal objects.

On adjusting volume

Do not turn up the volume while listening to a section with very low level inputs or no audio signals. If you do, the speakers may be damaged when a peak level section is played.

On headphones

- Preventing hearing damage: Avoid using headphones at high volumes. Hearing experts advise against continuous, loud, and extended play. If you experience a ringing in your ears, reduce the volume or discontinue use.
- Showing consideration for others: Keep the volume at a moderate level. This will allow you to hear external sounds and still be considerate to the people around you.

On cleaning

- Clean the cabinet, panel, and controls with a soft cloth slightly moistened with a mild detergent solution. Do not use any type of abrasive pad, scouring powder or solvent such as alcohol or benzene.
- Wipe the LCD surface with the soft dry cloth lightly. To prevent dirt buildup, wipe it frequently.
Do not wipe the LCD surface with a wet cloth. If water enters, a malfunction may result.
- If picture/sound is distorted, the lens may be covered with dust. In this case, use a commercially-available blower brush for camera lenses to clean the lens. Avoid touching the lens directly during cleaning.

On cleaning discs, disc/lens cleaners

Do not use cleaning discs or disc/lens cleaners (including wet or spray types). These may cause the apparatus to malfunction.

On replacement of parts

In the events that this player is repaired, repaired parts may be collected for reuse or recycling purposes.

On connecting to the HDMI OUT jack

Observe the following as improper handling may damage the HDMI OUT jack and the connector.

- Carefully align the HDMI OUT jack on the right of the player and the HDMI connector by checking their shapes. Make sure the connector is not upside down or tilted.

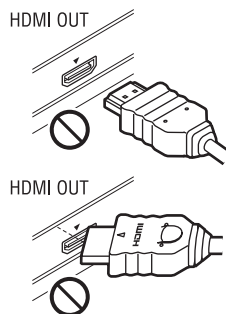

- Be sure to disconnect the HDMI cable when moving the player.



- Hold the HDMI connector straight when connecting or disconnecting the HDMI cable. Do not twist or force the HDMI connector into the HDMI OUT jack.

IMPORTANT NOTICE

Caution: This player is capable of holding a still video image or on-screen display image on your television screen indefinitely. If you leave the still video image or on-screen display image displayed on your TV for an extended period of time you risk permanent damage to your television screen. Plasma display panel televisions and projection televisions are susceptible to this.

If you have any questions or problems concerning your player, please consult your nearest Sony dealer.

Table of Contents

WARNING	2
Precautions	4
Guide to Parts and Controls	8
Rotating and Folding Down the LCD Panel	10

Preparations

Checking the Supplied Accessories	11
Charging the Rechargeable Battery	11
Using the Car Battery Adaptor	12
Connecting to the Network	13
Connecting to Other Equipment	13

Playback

Playing a Disc	15
Playing from a USB Device	16
Available Options	17

Settings and Adjustments

Using the Settings Displays	19
Network Update	19
Screen Settings	19
Audio Settings	21
BD/DVD Viewing Settings	22
Parental Control Settings	22
System Settings	23
Network Settings	23
Resetting	23

Additional Information

Troubleshooting	24
Specifications	27
Index	31

Guide to Parts and Controls

Player

The available functions of the player and remote differ depending on the disc or the situation.

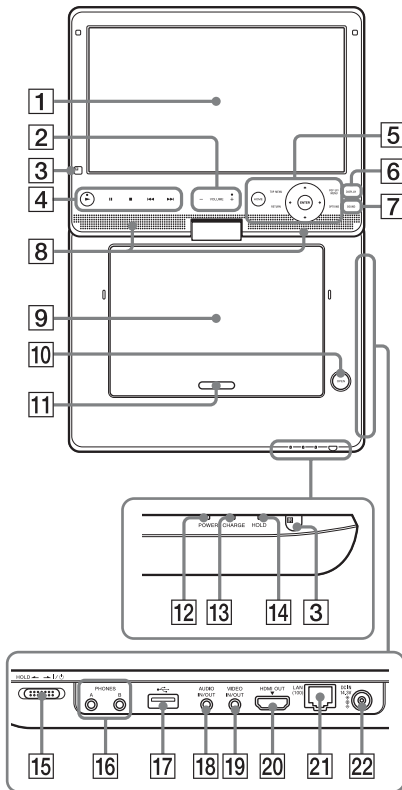

The VOLUME + and ► (play) buttons have a tactile dot. Use the tactile dot as a reference when operating the player.

1 LCD panel

2 VOLUME (sound volume) +/-
Adjusts the volume.

3 Remote sensor

The main remote sensor is located next to the HOLD indicator. The sub remote sensor is located at the lower left side of the LCD panel.

4 ► (play)

Starts or re-starts playback.

|| (pause)

Pauses or re-starts playback.

■ (stop)

Stops playback and remembers the stop point (resume point).
The resume point for a title/track is the last point you played or the last photo for a photo folder.

◀◀/▶▶ (previous/next)

Skips to the previous/next chapter, track, or file.
Hold down ◀◀/▶▶ on the player to reverse/fast forward (1 level only).

5 HOME

Enters the player's home menu.
Displays the wallpaper when pressed on the category icon of the home menu.

TOP MENU

Opens or closes the BD's or DVD's Top Menu.

POP UP/MENU

Opens or closes the BD-ROM's Pop-up Menu, or the DVD's menu.

OPTIONS (page 17)

The options menu that can be selected appears on the screen.

RETURN

Returns to the previous display.



Moves the highlight to select a displayed item.

ENTER (center button)

Enters the selected item.

6 DISPLAY (page 16)

Displays the playback information on the screen.

7 SOUND

Switches among 4 different sound modes each time pressed.

This function is available for the sound output from the player's speaker.

8 Speaker

9 Disc lid

10 OPEN button

Opens the disc lid.

11 PUSH CLOSE

Closes the disc lid.

12 POWER indicator

Lights up when the player is turned on.

13 CHARGE indicator

Lights up when charging the rechargeable battery.

Flashes when the battery is empty.

14 HOLD indicator

Lights up when the I/⏻/HOLD switch is set in the direction of HOLD.

15 I/⏻ (on/standby)/HOLD switch

- Turns on the player, or sets to standby mode.
- To avoid accidental button operation of the player, set the switch in the direction of HOLD. All the buttons on the player are locked, while the buttons on the remote remain operable.

16 PHONES (headphones) jack A, B

17 ⏻ (USB) jack

Connect a USB device to this jack.

18 AUDIO IN/OUT jack

19 VIDEO IN/OUT jack

20 HDMI OUT jack

21 LAN (100) terminal

22 DC IN 14.3V jack

Connect the AC adaptor or car battery adaptor.

Remote

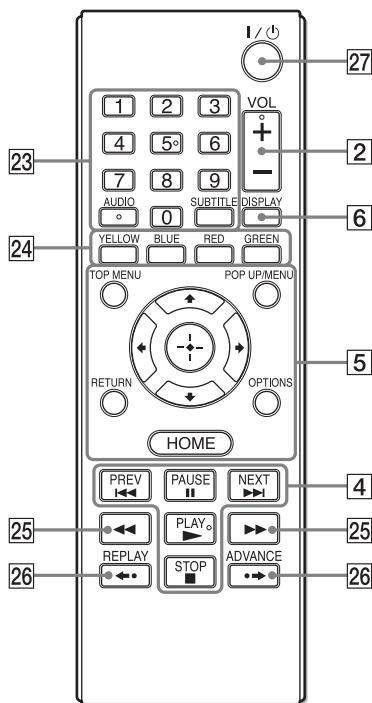

Number 5, AUDIO, VOL +, and ► PLAY buttons have a tactile dot. Use the tactile dot as a reference when operating the player.

23 Number buttons (0 - 9)

Enters the title/chapter numbers, etc.

AUDIO (page 22)

Selects the language track when multi-lingual tracks are recorded on BD-ROMs/DVD VIDEOS.

Selects the sound track on CDs.

SUBTITLE (page 22)

Selects the subtitle language when multi-lingual subtitles are recorded on BD-ROMs/DVD VIDEOS.

24 Color buttons (YELLOW/BLUE/RED/GREEN)

Shortcut keys for interactive functions.

25 ◀▶ (fast reverse/fast forward)

- Fast reverses/fast forwards the disc when pressed during playback. Each time you press the button during playback of videos, the search speed changes.
- Plays in slow motion, when pressed for more than one second in pause mode. This function is available when the remote is pointed at the main remote sensor.
- Plays one frame at a time, when pressed briefly in pause mode.

26 ◀•▶ (replay/advance)

Briefly replays the current scenes for 10 seconds/briefly fast forwards the current scenes for 15 seconds.

27 I/O (on/standby)

Turns on the player, or sets to standby mode.

Home menu display

The home menu appears when you press HOME. Select a category using ◀/▶. Select an item using ↑/↓, and press ENTER.

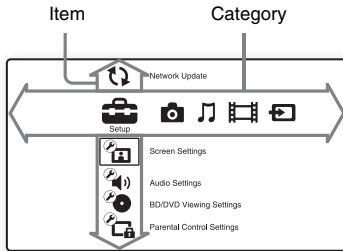

- (Setup): Adjusts the player settings.
- (Photo): Displays photos.
- (Music): Plays music.
- (Video): Plays videos.
- (Input): Plays videos/music/photos from other equipment.

Rotating and Folding Down the LCD Panel

Open the LCD panel to the vertical position, then slowly rotate it 180 degrees.

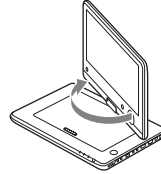

After rotating the LCD panel 180 degrees clockwise, push the LCD panel down onto the main body of the player. In this position the panel is facing up.

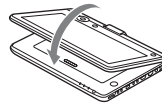

To return the LCD panel to its original position

Open the LCD panel to the vertical position and slowly rotate the LCD panel counter-clockwise.



Return the LCD panel to its original position after use, so the LCD panel will not be damaged by sudden shocks or rough treatment.

Checking the Supplied Accessories

Check that you have the following items:

- AC power cord (1)
- AC adaptor (1)
- Car battery adaptor (1)
- Audio/video cable (mini plug × 2 ↔ phono plug × 3) (1)
- Remote commander (remote) (1)
- Size AA (R6) batteries (2)

To prepare the remote

Insert two Size AA (R6) batteries by matching the ⊕ and ⊖ ends on the batteries to the markings inside the battery compartment.

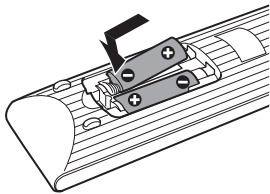

Charging the Rechargeable Battery

Charge the rechargeable battery before using the player for the first time, or when the battery is depleted.

Connect the AC adaptor.

When charging begins, the CHARGE indicator lights up in orange.

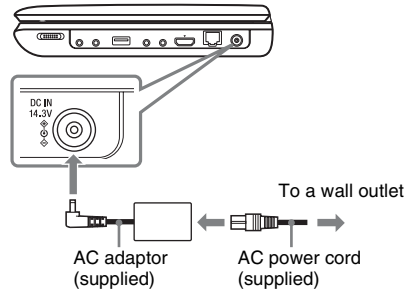

When charging ends, the CHARGE indicator lights off.

Disconnect the AC adaptor.



Charging takes longer if the player is turned on. When you only want to charge the battery, turn off the player.



Charge the battery in an ambient temperature of between 5°C (41°F) and 35°C (95°F).

Charging time and playing time

Charging time: approx. 6 hours

Playing time: approx. 5 hours

Times indicated are under the following conditions:

- Charging time
 - moderate temperature (20°C (68°F))
 - power-off
- Playing time
 - moderate temperature (20°C (68°F))
 - headphone use
 - backlight set to minimum

Depending on the ambient temperature or rechargeable battery condition, charging time may be longer, or playing time may be reduced.

To check the battery level

When the player is stopped, the battery indicator is displayed. When the battery is empty,  is displayed or the CHARGE indicator flashes.



Using the Car Battery Adaptor

The car battery adaptor is for a 12V car battery, negative earth (do not use it with a 24V car battery, positive earth).

Connect the car battery adaptor.

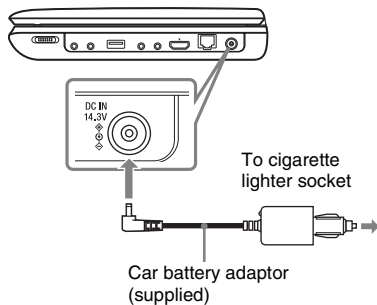

After using the player in a car

Disconnect the car battery adaptor from the cigarette lighter socket.



- The driver should not connect or disconnect the car battery adaptor while driving.
- Arrange the cord so as not to interfere with the driver. Also, do not place the LCD panel where the driver can watch.
- Clean the cigarette lighter socket. If dirty, the cigarette lighter socket may cause contact failure or malfunction.
- Use the car battery adaptor with the car engine running. If it is used with the car engine off, the car battery may become depleted.
- Do not leave the player or accessories in the car.

Connecting to the Network

Use a LAN cable to connect to the LAN (100) terminal on the player.

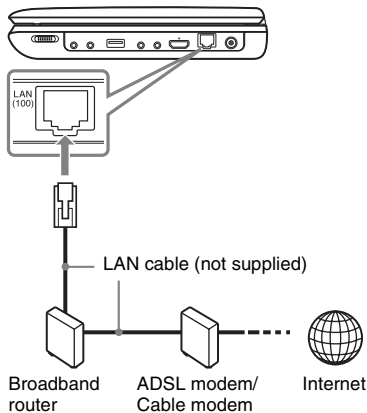

To set the network settings

Select “Network Settings,” “Internet Settings,” then “Wired Setup” (page 23), and follow the on-screen instructions to complete the setup.

Connecting to Other Equipment

By connecting the player to your TV or other equipment, you can increase your viewing options.



- Refer to the instruction manual supplied with the equipment to be connected.
- Before connecting, turn off the player and the equipment to be connected, then unplug them from their wall sockets.

Enjoying images on a connected TV

- 1 Connect the player to your TV or monitor using the audio/video or HDMI cable.

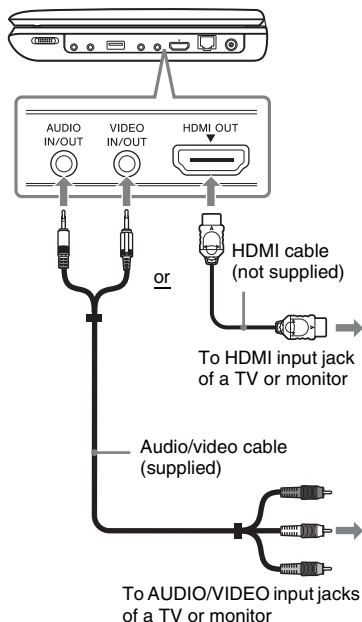

- 2 Turn on the player.

For HDMI connections, check the “HDMI/LCD Video Format” settings in the “Screen Settings” setup (page 20).



- The player can connect to an AV amplifier in the same way as a TV.
- Use an HDMI cable to enjoy high quality digital pictures and sound.





- Do not connect the player through a VCR. Video signals fed through VCRs may be affected by copyright protection systems and the picture will be distorted on the television.
- No sound is output from the player's speaker when connecting with an HDMI cable.

Enjoying images output from other equipment on the player's LCD screen

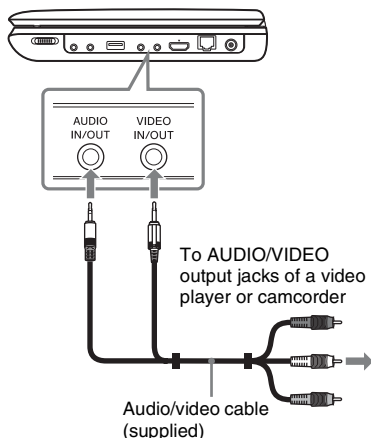
- 1** Connect the player to your video player or camcorder using the audio/video cable.



- 2** Turn on the player.
- 3** Select  (Input) on the home menu using /, and press ENTER.

To return to the home menu

Press HOME.

Playing a Disc

For playable discs, see “Playable discs” (page 27).

1 Open the LCD panel, and turn on the player.

2 Press OPEN to open the disc lid, and place the disc.

Place with the playback side down and push gently until it clicks. Do not touch the lens surface.

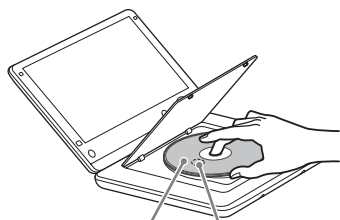





Playing side facing down

Lens

3 Close the disc lid.

Playback starts.

If playback does not start automatically, select  in the  (Video),  (Music), or  (Photo) category, and press ENTER.

Enjoying BONUSVIEW/BD-LIVE

Some BD-ROMs with the “BD-LIVE” logo* have bonus content and other data that can be downloaded for enjoyment.

* 

1 Connect a USB memory to the USB jack on the player (page 9).

As your local storage, use a 1 GB or larger USB memory.

2 Prepare for BD-LIVE (BD-LIVE only).

- Connect the player to a network (page 13).
- Set “BD Internet Connection” to “Allow” (page 22).

3 Insert a BD-ROM with BONUSVIEW/BD-LIVE.

The operation method differs depending on the disc. Refer to the instruction manual supplied with the disc.



To delete data in the USB memory, select “Erase BD Data” in the  (Video), and press ENTER. All data stored in the buda/budb folder will be erased.

Displaying the playback information

You can check the playback information, etc., by pressing DISPLAY. The displayed information differs depending on the disc type and player status.

Example: when playing a BD-ROM

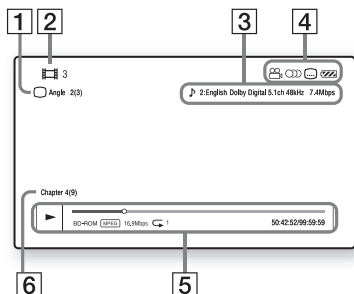

- 1 The currently selected angle
- 2 Title number or name
- 3 The currently selected audio setting
- 4 Available functions (Angle, audio, subtitle, battery status)
- 5 Displays the Play mode, Playing status bar, Disc type, Video codec, Bitrate, Repeat type, Elapsed time, and Total playing time.
- 6 Chapter number

Playing from a USB Device

You can play video/music/photo files on the connected USB device.

For playable USB devices, see “Playable types of files” (page 28).

1 Connect the USB device to the USB jack on the player.

Refer to the instruction manual supplied with the USB device before connecting.

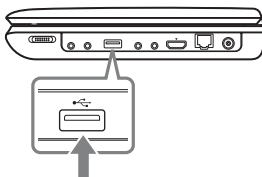

USB device

- 2 Select (Video), (Music), or (Photo) on the home menu using / .
- 3 Select (USB device) using / , and press ENTER.

Available Options

Various settings and playback operations are available by pressing **OPTIONS**. The available items differ depending on the situation.

Common options

Item	Details
LCD Mode	<ul style="list-style-type: none">• LCD Aspect: Changes the picture size.• Backlight: Adjusts the brightness.• Contrast: Adjusts the difference between light and dark areas.• Hue: Adjusts the red and green color balance.• Color: Adjusts the richness of colors.• Default: Returns all settings to the factory defaults.
Repeat Setting	Sets the repeat mode.
Play/Stop	Starts or stops the playback.
Play from beginning	Plays the item from the beginning.

(Video) only

Item	Details
A/V SYNC	Adjusts the gap between picture and sound, by delaying the sound output in relation to the picture output (0 to 120 milliseconds).
Pause	Pauses the playback.
Top Menu	Displays the BD's or DVD's Top Menu.
Menu/Popup Menu	Displays the BD-ROM's Pop-up Menu or DVD's menu.
Title Search	Searches for a title on BD-ROMs/DVD VIDEOS and starts playback from the beginning.
Chapter Search	Searches for a chapter and starts playback from the beginning.
Angle	Switches to other viewing angles when multi-angles are recorded on BD-ROMs/DVD VIDEOS.
Audio	Switches the language track when multi-lingual tracks are recorded on BD-ROMs/DVD VIDEOS.
Subtitle	Switches the subtitle language when multi-lingual subtitles are recorded on BD-ROMs/DVD VIDEOS.

(Music) only

Item	Details
Add Slideshow BGM	Registers music files in the USB memory as slideshow background music (BGM).









 (Photo) only

Item	Details
Slideshow Speed	Changes the slideshow speed.
Slideshow Effect	Sets the effect for slideshows.
Slideshow BGM	<ul style="list-style-type: none">• Off: Turns off the function.• My Music from USB: Sets the music files registered in “Add Slideshow BGM.” If no music file is registered, “(Not registered)” is displayed.• Play from Music CD: Sets the tracks in CD-DAs.
Slideshow	Plays a slideshow.
Rotate Left	Rotates the photo counterclockwise by 90 degrees.
Rotate Right	Rotates the photo clockwise by 90 degrees.

Using the Settings Displays

Select  (Setup) on the home menu when you need to change the settings of the player. The default settings are underlined.

- 1 Select  (Setup) on the home menu using \leftarrow/\rightarrow .
- 2 Select the setup category icon using \uparrow/\downarrow , and press ENTER.

Icon	Explanation
	Network Update (page 19) Updates the software of the player.
	Screen Settings (page 19) Makes the video settings.
	Audio Settings (page 21) Makes the audio settings.
	BD/DVD Viewing Settings (page 22) Makes detailed settings for BD/DVD playback.
	Parental Control Settings (page 22) Makes detailed settings for the Parental Control function.
	System Settings (page 23) Makes the player-related settings.
	Network Settings (page 23) Makes detailed settings for the Internet and network.
	Resetting (page 23) Resets the player to the factory settings.

Network Update

Connect the AC adaptor for the network update.

Select "OK" to update the player's software via the network.



- We recommend the network update every 2 months or so.
- For information about update functions, visit the following website:
<http://www.sony.com/blu-raysupport/>



- Do not disconnect the AC adaptor until the network update completes.
- Make sure that the rechargeable battery is sufficiently charged before starting the update.

Screen Settings



TV Type

<u>16:9</u>	Select this when connecting to a wide-screen TV or a TV with a wide mode function.
4:3	Select this when connecting to a 4:3 screen TV without a wide mode function.

Screen Format

<u>Original</u>	Select this when connecting to a TV with a wide mode function. Displays a 4:3 screen picture in 16:9 aspect ratio even on a wide-screen TV.
Fixed Aspect Ratio	Changes the picture size to fit the screen size with the original picture aspect ratio.

DVD Aspect Ratio

<u>Letter Box</u>	Displays a wide picture with black bands on the top and bottom. 
<u>Pan & Scan</u>	Displays a full-height picture on the entire screen, with trimmed sides. 

Cinema Conversion Mode

<u>Auto</u>	Normally select this. The player automatically detects whether the material is video-based or film-based, and switches to the appropriate conversion method.
<u>Video</u>	The conversion method suited for video-based material will always be selected regardless of the material.

HDMI/LCD Video Format

Normally select “Auto.”

Select “Original Resolution” to output the resolution recorded on the disc. When the resolution is lower than the SD resolution, it is scaled up to the SD resolution.



If no picture appears on the connected TV after setting the resolution, try another resolution setting.

BD/DVD-ROM 1080/24p Output

<u>Auto</u>	Outputs 1920 × 1080p/24 Hz video signals only when connecting a 1080/24p-compatible TV using the HDMI OUT jack.
<u>Off</u>	Normally select this when your TV is not compatible with 1080/24p video signals.



No picture appears on the LCD screen when 24p video signals are output from the HDMI OUT jack.

YCbCr/RGB (HDMI)

<u>Auto</u>	Automatically detects the connected TV type, and switches to the matching color setting.
<u>YCbCr (4:2:2)</u>	Outputs YCbCr 4:2:2 video signals.
<u>YCbCr (4:4:4)</u>	Outputs YCbCr 4:4:4 video signals.
<u>RGB</u>	Outputs RGB video signals.

Pause Mode

<u>Auto</u>	Normally select this. Dynamic moving pictures appear without blurring.
<u>Frame</u>	Displays static pictures at high resolution.



Audio Settings

Audio (HDMI)

<u>Auto</u>	Normally select this. Outputs audio signals according to the status of the connected HDMI device.
PCM	Outputs PCM signals from the HDMI OUT jack.

BD Audio MIX Setting

On	Outputs the audio obtained by mixing the interactive and secondary audio to the primary audio.
<u>Off</u>	Outputs the primary audio only. Select this to output HD audio signals to an AV amplifier (receiver).

DTS Neo:6

Cinema	Performs "DTS Neo:6 Cinema" mode decoding. A source recorded in 2-channel format is decoded into 7 channels.
Music	Performs "DTS Neo:6 Music" mode decoding. A source recorded in 2-channel format is decoded into 7 channels. This setting is ideal for normal stereo sources such as CDs.
<u>Off</u>	Turns off "DTS Neo:6" decoding.

Audio DRC

<u>Auto</u>	Performs playback at the dynamic range specified by the disc (BD-ROM only). Other discs are played back at the "On" level.
On	Performs playback at a standard compression level.
Off	No compression works. A more dynamic sound is produced.

Downmix

Surround	Outputs audio signals with surround effects. Select this when connecting an audio device that supports Dolby Surround (Pro Logic) ^{*1} or DTS Neo:6 ^{*2} .
<u>Stereo</u>	Outputs audio signals without surround effects. Select this when connecting an audio device that does not support Dolby Surround (Pro Logic) or DTS Neo:6.

^{*1} Manufactured under license from Dolby Laboratories. Dolby, Pro Logic, and the double-D symbol are trademarks of Dolby Laboratories.

^{*2} Manufactured under license under U.S. Patent #'s: 5,451,942; 5,956,674; 5,974,380; 5,978,762; 6,226,616; 6,487,535; 7,212,872; 7,333,929; 7,392,195; 7,272,567 & other U.S. and worldwide patents issued & pending. DTS and the Symbol are registered trademarks, & DTS-HD, DTS-HD Master Audio, and the DTS logos are trademarks of DTS, Inc. Product includes software. © DTS, Inc. All Rights Reserved.

BD/DVD Viewing Settings

BD/DVD Menu

Selects the default menu language for BD-ROMs or DVD VIDEOS.

When you select “Select Language Code,” the display for entering the language code appears. Enter the code for your language by referring to “Language code list” (page 30).

Audio

Selects the default track language for BD-ROMs or DVD VIDEOS.

When you select “Original,” the language given priority in the disc is selected. When you select “Select Language Code,” the display for entering the language code appears. Enter the code for your language by referring to “Language code list” (page 30).

Subtitle

Selects the default subtitle language for BD-ROMs or DVD VIDEOS.

When you select “Select Language Code,” the display for entering the language code appears. Enter the code for your language by referring to “Language code list” (page 30).

BD Hybrid Disc Playback Layer

<u>BD</u>	Plays BD layer.
DVD/CD	Plays DVD or CD layer.

BD Internet Connection

Allow	Normally select this.
<u>Do not allow</u>	Prohibits Internet connection from BD content.

Parental Control Settings

Password

Sets or changes the password for the Parental Control function. A password allows you to set a restriction on BD-ROMs or DVD VIDEOS playback. If necessary, you can differentiate the restriction levels for BD-ROMs and DVD VIDEOS.

Parental Control Area Code

Playback of some BD-ROMs or DVD VIDEOS can be limited according to the geographic area. Scenes may be blocked or replaced with different scenes. Follow the on-screen instructions and enter your four-digit password.

BD Parental Control

Playback of some BD-ROMs can be limited according to the age of the users. Scenes may be blocked or replaced with different scenes. Follow the on-screen instructions and enter your four-digit password.

DVD Parental Control

Playback of some DVD VIDEOS can be limited according to the age of the users. Scenes may be blocked or replaced with different scenes. Follow the on-screen instructions and enter your four-digit password.

System Settings

OSD

Selects your language for the player on-screen displays.

Control for HDMI

<u>On</u>	The following BRAVIA sync features are available: <ul style="list-style-type: none">– One-Touch Play– System Power-Off– Language Follow
<u>Off</u>	Turns off the function.



For details, refer to the instruction manual supplied with the TV or components.

HDMI: Linked to TV-off

<u>On</u>	Automatically turns off the player and HDMI-compatible components when the connected TV enters standby mode (BRAVIA sync).
<u>Off</u>	Turns off the function.

Auto Standby

<u>On</u>	Turns on the “Auto Standby” function. Automatically returns to standby mode if no button on the player or remote is pressed for more than 30 minutes.
<u>Off</u>	Turns off the function.

Auto Display

<u>On</u>	Automatically displays information on the screen when changing the viewing titles, picture modes, audio signals, etc.
<u>Off</u>	Displays information only when you press DISPLAY.

Screen Saver

<u>On</u>	Turns on the screen saver function. The screen saver image appears when the player is not used for more than 10 minutes while displaying an on-screen display.
<u>Off</u>	Turns off the function.

Software Update Notification

<u>On</u>	Sets the player to inform you of newer software version information (page 19).
<u>Off</u>	Turns off the function.

System Information

Displays the player’s software version information and the MAC address, etc.

Network Settings

Internet Settings

Connect the player to the network beforehand. For details, see “Connecting to the Network” (page 13).

<u>View Network Status</u>	Displays the current network status.
<u>Wired Setup</u>	Connects the player to a broadband router directly.

Network Connection Diagnostics

You can run the network diagnostic to check if the network connection has been properly made.

Resetting

Reset to Factory Default Settings

You can reset the player settings to the factory default by selecting the group of settings. All the settings within the group will be reset.

Additional Information

Troubleshooting

If you experience any of the following difficulties while using the player, use this troubleshooting guide to help remedy the problem before requesting repairs. Should any problem persist, consult your nearest Sony dealer.

Power

The power is not turned on.

- ➔ Check that the AC adaptor is securely connected (page 11).
- ➔ Check that the rechargeable battery is sufficiently charged (page 11).

The rechargeable battery cannot be charged or charging time is long.

- ➔ If the CHARGE indicator flashes with the AC adaptor connected, the ambient temperature is not appropriate. Charge the battery in an ambient temperature of between 5°C (41°F) and 35°C (95°F).
- ➔ Charging takes longer if the player is turned on. Before charging, turn off the player.
- ➔ If you have not used the player for more than a year, the battery may have deteriorated. Consult your nearest Sony dealer.

Picture

There is no picture or the picture is not output correctly.

- ➔ The pictures on the LCD are displayed in standard quality when the audio/video cable is connected. Disconnect the audio/video cable to enjoy high quality digital pictures on the LCD.
- ➔ Some digital content in commercially available BDs cannot be displayed on the LCD screen when the audio/video cable is connected. Disconnect the audio/video cable to enjoy such content on the LCD screen.

- ➔ No picture appears on the LCD screen when 24p video signals are output from the HDMI OUT jack. Set “BD/DVD-ROM 1080/24p Output” to “Off” in the “Screen Settings” setup (page 20).

The black points appear and the red, blue, green points remain on the LCD.

- ➔ This is a structural property of the LCD and not a malfunction.

Sound

There is no sound.

- ➔ The player is in pause mode or in slow play mode.
- ➔ The player is in fast forward or fast reverse mode.

The HD Audio (Dolby Digital Plus, Dolby TrueHD, DTS-HD High Resolution Audio, and DTS-HD Master Audio) is not output by bitstream.

- ➔ Set “BD Audio MIX Setting” to “Off” in the “Audio Settings” setup (page 21).

The interactive audio is not output.

- ➔ Set “BD Audio MIX Setting” to “On” in the “Audio Settings” setup (page 21).

The sound mode is not switched.

- ➔ Only “Standard” is available when the audio/video cable is connected. Disconnect the audio/video cable to enjoy other sound modes on the player.

Disc

The disc does not play.

- ➔ The disc is dirty or skewed.
- ➔ The disc is not set until it clicks (page 15).
- ➔ The disc is upside down. Insert the disc with the playback side facing down.
- ➔ The disc has a format that cannot be played back by this player (page 27).
- ➔ The player cannot play a recorded disc that is not correctly finalized.
- ➔ The region code on the BD or DVD does not match the player (page 28).

Operations

Playback does not start from the beginning of content.

- ➔ Press **OPTIONS**, and select “Play from beginning.”

Playback does not start from the resume point where you last stopped playing.

- ➔ The resume point may be cleared from memory when
 - you open the disc lid.
 - you disconnect the USB device.
 - you play other content.
 - you turn off the player.
 - you change some settings under the “Setup.”

The player does not respond to any button.

- ➔ The **I/⏸/HOLD** switch is set in the direction of **HOLD**.
- ➔ Moisture has condensed inside the player (page 4).
- ➔ Disconnect the AC power cord from the wall outlet and slide the **I/⏸/HOLD** switch in the direction of **I/⏸** and hold for 10 seconds until the **POWER** indicator on the player turns off.

USB device

The player does not detect a USB device connected to the player.

- ➔ Make sure that the USB device is securely connected to the USB jack.
- ➔ Check if the USB device or a cable is damaged.
- ➔ Check if the USB device is on.
- ➔ If the USB device is connected via a USB hub, connect the USB device directly to the player.

Network connection

The player cannot connect to the network.

- ➔ Check the network connection (page 13) and the network settings (page 23).

The message “A new software version is available. Please go to the “Setup” section of the menu and select “Network update” to perform the update.” appears on the screen when turning the player on.

- ➔ See “Network Update” (page 19) to update the player to a newer software version.

Hookup

There is no picture or the picture is not output correctly.

- ➔ Check that all the connecting cables are securely connected.
- ➔ Switch the input selector on your TV to display the signal from the player.
- ➔ For HDMI connections, try the following:
 - ① Turn the player off and on again.
 - ② Turn the connected equipment off and on again.
 - ③ Disconnect and then reconnect the HDMI cable.
- ➔ The HDMI OUT jack is connected to a DVI device that does not support copyright protection technology.
- ➔ For HDMI connections, check the “HDMI/LCD Video Format” settings in the “Screen Settings” setup (page 20).
- ➔ For BD-ROMs, check the “BD/DVD-ROM 1080/24p Output” setting in the “Screen Settings” setup (page 20).
- ➔ The pictures are displayed in standard quality on the HDMI-connected TV when the audio/video cable is connected at the same time. Disconnect the audio/video cable to enjoy high quality digital pictures on the HDMI-connected TV.

There is no sound or the sound is not output correctly.

- ➔ Check that all the connecting cables are securely connected.
- ➔ For HDMI connections, try the following:
 - ① Turn the player off and on again.
 - ② Turn the connected equipment off and on again.
 - ③ Disconnect and then reconnect the HDMI cable.
- ➔ The HDMI OUT jack is connected to a DVI device (DVI jacks do not accept audio signals).
- ➔ The device connected to the HDMI OUT jack does not support the audio format of the player. Check the audio settings (page 21).
- ➔ For HDMI connections, Set “Audio (HDMI)” to “Auto” in the “Audio Settings” setup (page 21).
- ➔ When both the HDMI and the audio/video cables are connected at the same time, no signal is output from the AUDIO IN/OUT jack. Disconnect the HDMI cable to enjoy sound on the equipment connected with the audio/video cable.
- ➔ The sound mode can be switched only for the sound output from the player’s speaker. Only “Standard” is available for the sound output from the HDMI or AUDIO IN/OUT jack.

The display language on the screen switches automatically when connected to the HDMI OUT jack.

- ➔ When “Control for HDMI” is set to “On” (page 23), the display language on the screen automatically switches according to the language setting of the connected TV (if you change the setting on your TV, etc.).

“Control for HDMI” (BRAVIA Sync)**The “Control for HDMI” function does not work (BRAVIA Sync).**

- ➔ Check that “Control for HDMI” is set to “On” (page 23).
- ➔ If you change the HDMI connection, turn the player off and on again.
- ➔ If power failure occurs, set “Control for HDMI” to “Off,” then set “Control for HDMI” to “On” (page 23).
- ➔ Check the following and refer to the instruction manual supplied with the component.
 - the connected component is compatible with the “Control for HDMI” function.
 - the connected component’s setting for the “Control for HDMI” function is correct.

The System Power-Off function does not work (BRAVIA Sync).

- ➔ Check that “Control for HDMI” and “HDMI: Linked to TV-off” are set to “On” (page 23).

Specifications

System

Laser: Semiconductor laser

Signal format system: NTSC

Inputs/Outputs

VIDEO IN/OUT (video input/output):

Minijack

AUDIO IN/OUT (audio input/output):

Stereo minijack

PHONES (headphones) A/B:

Stereo minijack

USB:

USB jack Type A (For connecting a USB memory, memory card reader, digital still camera, and digital video camera)

HDMI OUT:

HDMI 19-pin standard connector

LAN (100):

100BASE-TX Terminal

Liquid Crystal Display

Panel size (approx.):

10.1 inches wide (diagonal)

Driving system:

TFT active matrix

Resolution:

1024 × 600

General

Power requirements:

DC 14.3 V 1.6 A (AC adaptor/Car battery adaptor)

Power consumption:

15 W (when playing a BD-ROM using headphones)

Dimensions (approx.):

259 mm × 204 mm × 40.2 mm

(10 1/4 in. × 8 1/8 in. × 1 5/8 in.)

(width/depth/height) incl. projecting parts

Mass (approx.):

1.53 kg (3.37 lbs)

Operating temperature:

5 °C to 35 °C (41 °F to 95 °F)

Operating humidity:

25 % to 80 %

AC adaptor:

110-240 V AC, 50/60 Hz

Car battery adaptor:

12 V DC

Supplied accessories

See page 11.

Specifications and design are subject to change without notice.

Playable discs

Blu-ray Disc *1	BD-ROM BD-R*2/BD-RE*2
DVD *3	DVD-ROM DVD-R/DVD-RW DVD+R/DVD+RW
CD *3	CD-DA (Music CD) CD-ROM CD-R/CD-RW

*1 Since the Blu-ray Disc specifications are new and evolving, some discs may not be playable depending on the disc type and the version. The audio output differs depending on the source, connected output jack, and selected audio settings.

*2 BD-RE: Ver.2.1

BD-R: Ver.1.1, 1.2, 1.3 including organic pigment type BD-R (LTH type)

The BD-Rs recorded on a PC cannot be played if postscripts are recordable.

*3 A CD or DVD disc will not play if it has not been correctly finalized. For more information, refer to the instruction manual supplied with the recording device.

Discs that cannot be played

- BDs with cartridge
- BDXLs
- DVD-RAMs
- HD DVDs
- DVD Audio discs
- PHOTO CDs
- Data part of CD-Extras
- VCDs/Super VCDs
- HD layer on Super Audio CDs
- Audio material side on DualDiscs
- A disc recorded in a color system other than NTSC, such as PAL (this player conforms to the NTSC color system).

Note on Discs

This product is designed to playback discs that conform to the Compact Disc (CD) standard. DualDiscs and some of the music discs encoded with copyright protection technologies do not conform to the Compact Disc (CD) standard, therefore, these discs may not be playable by this product.

Note on playback operations of BDs/DVDs

Some playback operations of BDs/DVDs may be intentionally set by software producers. Since this player plays BDs/DVDs according to the disc contents the software producers designed, some playback features may not be available.

Note about double-layer BDs/DVDs

The playback pictures and sound may be momentarily interrupted when the layers switch.

Region code (BD-ROM/DVD VIDEO only)

The system that is used to protect copyrights. The region code is shown on the BD-ROM/DVD VIDEO packages according to the region of sale.

BD-ROMs labeled "A" will play on the player.



DVD VIDEOS labeled "ALL" or "1" will play on the player.



Playable types of files

Video

File format	Extensions
MPEG-1 Video/PS* ¹ MPEG-2 Video/PS, TS* ¹	“.mpg,” “.mpeg,” “.m2ts,” “.mts”
MPEG-4 AVC* ¹	“.mkv,” “.mp4,” “.m4v,” “.m2ts,” “.mts”
WMV9* ¹	“.wmv,” “.asf”
AVCHD	* ²

Music

File format	Extensions
MP3 (MPEG-1 Audio Layer III)	“.mp3”
AAC* ^{1*3}	“.m4a”
WMA9 Standard* ^{1*3}	“.wma”
LPCM	“.wav”

Photo

File format	Extensions
JPEG	“.jpg,” “.jpeg”

*¹ The player does not play coded files such as DRM.

*² The player plays AVCHD format files that are recorded on a digital video camera, etc. The AVCHD format disc will not play if it has not been correctly finalized.

*³ The player does not play coded files such as Lossless.



- Some files may not play depending on the format, the encoding, or recording condition.
- Some files edited on a PC may not play.
- The player can recognize the following files or folders in BDs, DVDs, CDs and USB devices:
 - up to folders in the 5th tree
 - up to 500 files in a single treeThe number of files or folders differs depending on the conditions.
- Some USB devices may not work with this player.
- The player can recognize Mass Storage Class (MSC) devices such as flash memory, as well as Still Image Capture Device (SICD) class devices.
- To avoid data corruption or damage to the USB memory or devices, turn the player off when connecting or removing the USB memory or devices.
- The player may not play high bit rate video files on DATA CDs smoothly. You are recommended to play such files using DATA DVDs.

Copyrights and Trademarks

- “AVCHD” and the “AVCHD” logo are trademarks of Panasonic Corporation and Sony Corporation.
- Java, the coffee cup logo, and all Java based marks are trademarks or registered trademarks of Sun Microsystems, inc. in the U.S. or other countries.
- , “XMB,” and “cross media bar” are trademarks of Sony Corporation and Sony Computer Entertainment Inc.
- This product incorporates High-Definition Multimedia Interface (HDMI™) technology. HDMI, the HDMI Logo, and High-Definition Multimedia Interface are trademarks or registered trademarks of HDMI Licensing LLC in the United States and other countries.
- “Blu-ray Disc” is a trademark.
- “Blu-ray Disc,” “DVD+RW,” “DVD-RW,” “DVD+R,” “DVD-R,” “DVD VIDEO,” and “CD” logos are trademarks.
- “BD-LIVE,” “BD-LIVE” logo, and “BONUSVIEW” are trademarks of Blu-ray Disc Association.
- “BRAVIA” is a trademark of Sony Corporation.
- “PhotoTV HD” and the “PhotoTV HD” logo are trademarks of Sony Corporation.
- MPEG Layer-3 audio coding technology and patents licensed from Fraunhofer IIS and Thomson.
- Other system and product names are generally trademarks or registered trademarks of the manufacturers. ™ and ® marks are not indicated in this document.

Language code list

For details, see “BD/DVD Viewing Settings” (page 22).

The language spellings conform to the ISO 639: 1988 (E/F) standard.

Code Language

1027	Afar	1186	Scots Gaelic	1349	Macedonian	1511	Albanian
1028	Abkhazian	1194	Galician	1350	Malayalam	1512	Serbian
1032	Afrikaans	1196	Guarani	1352	Mongolian	1513	Siswati; Swati
1039	Amharic	1203	Gujarati	1353	Moldavian	1514	Sesotho; Sotho
1044	Arabic	1209	Hausa	1356	Marathi		southern
1045	Assamese	1217	Hindi	1357	Malay	1515	Sundanese
1051	Aymara	1226	Croatian	1358	Malese; Maltese	1516	Swedish
1052	Azerbaijani	1229	Hungarian	1363	Burmese	1517	Swahili
1053	Bashkir	1233	Armenian	1365	Nauru	1521	Tamil
1057	Byelorussian	1235	Interlingua	1369	Nepali	1525	Telugu
1059	Bulgarian	1239	Interlingue	1376	Dutch	1527	Tajik
1060	Bihari	1245	Inupiak	1379	Norwegian	1528	Thai
1061	Bislama	1248	Indonesian	1393	Occitan	1529	Tigrinya
1066	Bengali	1253	Icelandic	1403	Oromo	1531	Turkmen
1067	Tibetan	1254	Italian	1408	Oriya	1532	Tagalog
1070	Breton	1257	Hebrew	1417	Punjabi; Panjabi	1534	Setswana; Tswana
1079	Catalan	1261	Japanese	1428	Polish	1535	Tonga;
1093	Corsican	1269	Yiddish	1435	Pashto; Pushto		Tonga islands
1097	Czech	1283	Javanese	1436	Portuguese	1538	Turkish
1103	Welsh	1287	Georgian	1463	Quechua	1539	Tsonga
1105	Danish	1297	Kazakh	1481	Rhaeto-Romance	1540	Tatar
1109	German	1298	Greenlandic;	1482	Kirundi; Rundi	1543	Twi
1130	Bhutani; Dzongkha		Kalaallisut	1483	Romanian	1557	Ukrainian
1142	Greek	1299	Cambodian; Khmer	1489	Russian	1564	Urdu
1144	English	1300	Kannada	1491	Kinyarwanda	1572	Uzbek
1145	Esperanto	1301	Korean	1495	Sanskrit	1581	Vietnamese
1149	Spanish	1305	Kashmiri	1498	Sindhi	1587	Volapük
1150	Estonian	1307	Kurdish	1501	Sangho; Sango	1613	Wolof
1151	Basque	1311	Kirghiz	1502	Serbo-Croatian	1632	Xhosa
1157	Persian	1313	Latin	1503	Singhalese;	1665	Yoruba
1165	Finnish	1326	Lingala		Sinhalese	1684	Chinese
1166	Fiji	1327	Laotian; Lao	1505	Slovak	1697	Zulu
1171	Faroese	1332	Lithuanian	1506	Slovenian	1703	not specified
1174	French	1334	Latvian	1507	Samoan		
1181	Frisian	1345	Malagasy	1508	Shona		
1183	Irish	1347	Maori	1509	Somali		

Parental control area code

For details, see “Parental Control Area Code” (page 22).

Code Area

2044	Argentina	2219	Hong Kong	2427	Pakistan
2047	Australia	2248	India	2424	Philippines
2046	Austria	2238	Indonesia	2428	Poland
2057	Belgium	2239	Ireland	2436	Portugal
2070	Brazil	2254	Italy	2489	Russia
2090	Chile	2276	Japan	2501	Singapore
2092	China	2304	Korea	2149	Spain
2093	Colombia	2333	Luxembourg	2499	Sweden
2115	Denmark	2363	Malaysia	2086	Switzerland
2165	Finland	2362	Mexico	2543	Taiwan
2174	France	2376	Netherlands	2528	Thailand
2109	Germany	2390	New Zealand	2184	United Kingdom
2200	Greece	2379	Norway		

Index

Words in quotations appear in the on-screen displays.

A

AUDIO 9

“Audio Settings” 21

“Auto Standby” 23

B

Batteries 11

“BD/DVD Viewing Settings” 22

BD-LIVE 15

BD-R 27

BD-RE 27

Bitstream 24

Blu-ray Disc 27

BONUSVIEW 15

BRAVIA Sync 26

C

CD 27

Charging time and playing time 11

Color buttons 9

Connecting

Network 13

Other equipment 13

“Control for HDMI” 23, 26

D

DISPLAY 8

Dolby Digital 21

DTS 21

DVD 27

H

HDMI 20, 21

HOME 8, 19

Home menu 19

L

“LCD Mode” 17

M

MAC address 23

N

“Network Settings” 23

“Network Update” 19

O

OPTIONS 8

“OSD” 23

P

Parental Control 22

“Parental Control Settings” 22

Playable discs 27

Playback information 16

POP UP/MENU 8

R

Region code 28

Remote 9, 11

“Resetting” 23

Resetting the player 23

Resume 8, 25

S

“Screen Settings” 19

“Setup” 19

Software update 19, 23

SOUND 9

SUBTITLE 9

“System Settings” 23

T

TOP MENU 8

Troubleshooting 24

“TV Type” 19

U

Update 19

USB 16

The software of this player may be updated in the future. To find out details on any available updates, please visit: <http://www.sony.com/bluraysupport/>

AVCHD™

HDMI

BD-LIVE™

DVD
VIDEO™

COMPACT
disc
DIGITAL AUDIO



BRAVIA
Sync

PhotoTV
HD

Java™
POWERED

<http://www.sony.net/>



1-426405513+