

The software of this player may be updated in the future. To find out details on any available updates, please visit: <http://support.sony-europe.com/>

 To find out useful hints, tips and information about Sony products and services please visit: [www.sony-europe.com/myproduct/](http://www.sony-europe.com/myproduct/)



<http://www.sony.net/>

Printed on 70% or more recycled paper.

4-169-142-11(1)



Printed in Hungary



## Operating Instructions

Blu-ray Disc™ / DVD Player

BDP-S370/S373

© 2010 Sony Corporation

# WARNING

To reduce the risk of fire or electric shock, do not expose this apparatus to rain or moisture.

To avoid electrical shock, do not open the cabinet. Refer servicing to qualified personnel only.

The mains lead must be changed only at a qualified service shop.

Batteries or batteries installed apparatus shall not be exposed to excessive heat such as sunshine, fire or the like.

## CAUTION

The use of optical instruments with this product will increase eye hazard. As the laser beam used in this Blu-ray Disc/DVD player is harmful to eyes, do not attempt to disassemble the cabinet.

Refer servicing to qualified personnel only.





This label is located on the laser protective housing inside the enclosure.



This appliance is classified as a CLASS 1 LASER product. The CLASS 1 LASER PRODUCT MARKING is located on the laser protective housing inside the enclosure.

## Notice for customers in the United Kingdom and Republic of Ireland

A molded plug complying with BS1363 is fitted to this equipment for your safety and convenience. Should the fuse in the plug supplied need to be replaced, a fuse of the same rating as the supplied one and approved by ASTA or BSI to BS1362, (i.e., marked with  or  mark) must be used. If the plug supplied with this equipment has a detachable fuse cover, be sure to attach the fuse cover after you change the fuse. Never use the plug without the fuse cover. If you should lose the fuse cover, please contact your nearest Sony service station.



## Disposal of Old Electrical & Electronic Equipment (Applicable in the European Union and other European countries with separate collection systems)

This symbol on the product or its packaging indicates that this product shall not be treated as household waste. Instead it shall be handed over to the applicable collection point for the recycling of electrical and electronic equipment. By ensuring this product is disposed of correctly, you will help prevent potential negative consequences for the environment and human health, which could otherwise be caused by inappropriate waste handling of this product. The recycling of materials will help to conserve natural resources. For more detailed information about recycling of this product, please contact your local Civic Office, your household waste disposal service or the shop where you purchased the product.



## Disposal of waste batteries (applicable in the European Union and other European countries with separate collection systems)

This symbol on the battery or on the packaging indicates that the battery provided with this product shall not be treated as household waste.

On certain batteries this symbol might be used in combination with a chemical symbol. The chemical symbols for mercury (Hg) or lead (Pb) are added if the battery contains more than 0.0005% mercury or 0.004% lead. By ensuring these batteries are disposed of correctly, you will help prevent potentially negative consequences for the environment and human health which could otherwise be caused by inappropriate waste handling of the battery. The recycling of the materials will help to conserve natural resources.

In case of products that for safety, performance or data integrity reasons require a permanent connection with an incorporated battery, this battery should be replaced by qualified service staff only.

To ensure that the battery will be treated properly, hand over the product at end-of-life to the applicable collection point for the recycling of electrical and electronic equipment.

For all other batteries, please view the section on how to remove the battery from the product safely. Hand the battery over to the applicable collection point for the recycling of waste batteries.

For more detailed information about recycling of this product or battery, please contact your local Civic Office, your household waste disposal service or the shop where you purchased the product.

The manufacturer of this product is Sony Corporation, 1-7-1 Konan Minato-ku Tokyo, 108-0075 Japan. The Authorized Representative for EMC and product safety is Sony Deutschland GmbH, Hedelfinger Strasse 61, 70327 Stuttgart, Germany. For any service or guarantee matters please refer to the addresses given in separate service or guarantee documents.

## Precautions

- This unit operates on 220 V – 240 V AC, 50 Hz/60 Hz. Check that the unit's operating voltage is identical with your local power supply.
- To prevent fire or shock hazard, do not place objects filled with liquids, such as vases, on the apparatus.
- Install this unit so that the mains lead can be unplugged from the wall socket immediately in the event of trouble.

## Notes About the Discs

- To keep the disc clean, handle the disc by its edge. Do not touch the surface. Dust, fingerprints, or scratches on the disc may cause it to malfunction.



- Do not expose the disc to direct sunlight or heat sources such as hot air ducts, or leave it in a car parked in direct sunlight as the temperature may rise considerably inside the car.
- After playing, store the disc in its case.

- Clean the disc with a cleaning cloth. Wipe the disc from the centre out.



- Do not use solvents such as benzine, thinner, commercially available disc/lens cleaners, or anti-static spray intended for vinyl LPs.
- If you have printed the disc's label, dry the label before playing.
- Do not use the following discs.
  - A lens cleaning disc.
  - A disc that has a non-standard shape (e.g., card, heart).
  - A disc with a label or sticker on it.
  - A disc that has cellophane tape or sticker adhesive on it.
- Do not resurface the playing side of a disc to remove surface scratches.

## Precautions

This equipment has been tested and found to comply with the limits set out in the EMC Directive using a connection cable shorter than 3 metres.

## On placement

- Place the player in a location with adequate ventilation to prevent heat build-up in the player.
- Do not place the player on a soft surface such as a rug that might block the ventilation holes.
- Do not install this player in a confined space, such as a bookshelf or similar unit.
- Do not place the player in a location near heat sources, or in a place subject to direct sunlight, excessive dust, or mechanical shock.
- Do not place the player outdoors, in vehicles, on ships, or on other vessels.
- If the player is brought directly from a cold to a warm location, or is placed in a very damp room, moisture may condense on the lenses inside the player. Should this occur, the player may not operate properly. In this case, remove the disc and leave the player turned on for about half an hour until the moisture evaporates.
- Do not install the player in an inclined position. It is designed to be operated in a horizontal position only.
- Do not place heavy or unstable objects on the player.
- Do not place any objects other than discs on the disc tray. Doing so may cause damage to the player or the object.
- Take out any discs when you move the player. If you don't, the disc may be damaged.
- Disconnect the AC power cord (mains lead) and all other cables from the player when you move the player.

## On power sources

- The player is not disconnected from the AC power source (mains) as long as it is connected to the wall outlet, even if the player itself has been turned off.
- Disconnect the player from the wall outlet if you are not going to use the player for a long time. To disconnect the AC power cord (mains lead), grasp the plug itself; never pull the cord.
- Observe following points to prevent the AC power cord (mains lead) being damaged. Do not use the AC power cord (mains lead) if it is damaged, as doing so may result in an electric shock or fire.
  - Do not pinch the AC power cord (mains lead) between the player and wall, shelf, etc.
  - Do not put anything heavy on the AC power cord (mains lead) or pull on the AC power cord (mains lead) itself.

## On adjusting volume

Do not turn up the volume while listening to a section with very low level inputs or no audio signals. If you do, your ears and the speakers may be damaged when a peak level section is played.

## On cleaning

Clean the cabinet, panel, and controls with a soft cloth. Do not use any type of abrasive pad, scouring powder or solvent such as alcohol or benzene.

## On cleaning discs, disc/lens cleaners

Do not use cleaning discs or disc/lens cleaners (including wet or spray types). These may cause the apparatus to malfunction.

## On replacement of parts

In the events that this player is repaired, repaired parts may be collected for reuse or recycling purposes.

## On connecting to the HDMI OUT jack

Observe the following as improper handling may damage the HDMI OUT jack and the connector.

- Carefully align the HDMI OUT jack on the rear of the player and the HDMI connector by checking their shapes. Make sure the connector is not upside down or tilted.

HDMI OUT

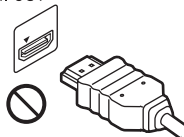

HDMI OUT

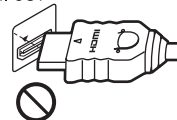

- Be sure to disconnect the HDMI cable when moving the player.



- When connecting or disconnecting, do not screw in or rotate the HDMI connector.

## IMPORTANT NOTICE

Caution: This player is capable of holding a still video image or on-screen display image on your television screen indefinitely. If you leave the still video image or on-screen display image displayed on your TV for an extended period of time you risk permanent damage to your television screen. Plasma display panel televisions and projection televisions are susceptible to this.

If you have any questions or problems concerning your player, please consult your nearest Sony dealer.

# Table of Contents

WARNING .....	2
Precautions .....	3
Guide to Parts and Controls .....	6

---

## Hookups and Settings

Step 1: Preparing the Player .....	9
Step 2: Connecting the Player .....	10
Step 3: Easy Setup .....	12
Connecting to the Network .....	12

---

## Playback

Playing a Disc .....	14
Playing from a USB Device .....	15
Playing via a Network .....	16
Available Options .....	16

---

## Settings and Adjustments

Using the Settings Displays .....	18
Network Update .....	19
Screen Settings .....	19
Audio Settings .....	20
BD/DVD Viewing Settings .....	21
Parental Control Settings .....	22
Music Settings .....	22
System Settings .....	23
Network Settings .....	24
Easy Setup .....	24
Resetting .....	24

---

## Additional Information

Troubleshooting .....	25
Specifications .....	28
Index .....	34

# Guide to Parts and Controls

## Front panel

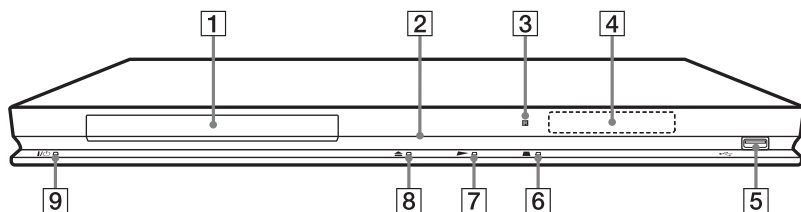

The ► button has a tactile dot. Use the tactile dot as a reference when operating the player.

**1 Disc tray**

**2 Power indicator**

Lights up in white when the player is turned on.

**3 Remote sensor**

**4 Front panel display**

►, ||: Lights up during playback or pause.

↺: Lights up when enabling the repeat setting.

HD: Lights up when outputting 720p/1080i/1080p video signals.

**5 USB jack**

Connect a USB device to this jack.

**6 ■ (stop)**

**7 ► (play)**

**8 ▲ (open/close)**

**9 I/⏻ (on/standby)**

Turns on the player, or sets to standby mode.

### To lock the disc tray (Child Lock)

You can lock the disc tray to prevent it being opened by mistake.

When the player is turned on, hold down ► on the player for more than 10 seconds. The disc tray is locked or unlocked.

## Rear panel

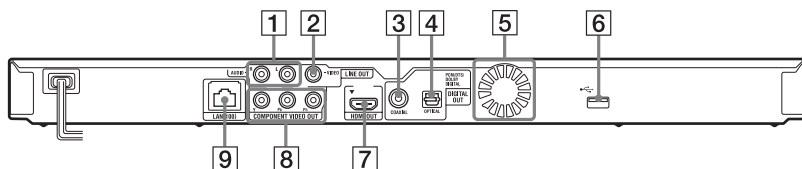

**1 LINE OUT (R-AUDIO-L) jacks**

**2 LINE OUT (VIDEO) jack**

**3 DIGITAL OUT (COAXIAL) jack**

**4 DIGITAL OUT (OPTICAL) jack**

**5 Ventilation holes**

**6 USB jack**

**7 HDMI OUT jack**

**8 COMPONENT VIDEO OUT (Y, Pb, Pr) jacks**

**9 LAN (100) terminal**

## Remote

The available functions of the remote differ depending on the disc or the situation.

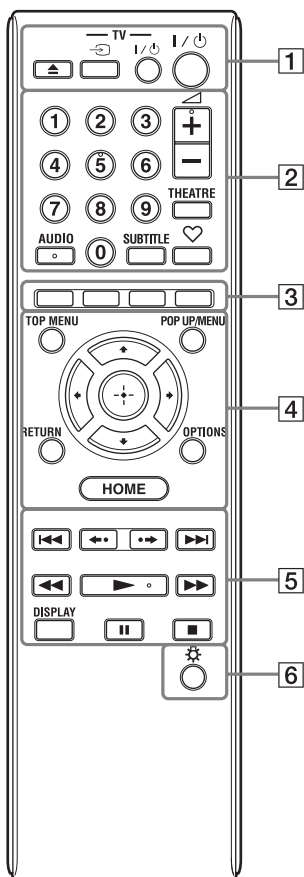

Number 5, AUDIO,  $\triangleleft$  +, and  $\blacktriangleright$  buttons have a tactile dot. Use the tactile dot as a reference when operating the player.

### 1 $\triangle$ (open/close)

Opens or closes the disc tray.

### -TV- $\rightarrow$ (TV input select)

Switches between TV and other input sources.

### -TV- I/O (TV on/standby)

Turns on the TV, or sets to standby mode.

### I/O (on/standby)

Turns on the player, or sets to standby mode.

### 2 Number buttons (0 - 9)

Enters the title/chapter numbers, etc.

### $\triangleleft$ (volume) +/-

Adjusts the TV volume.

### THEATRE (page 30)

Switches to the optimum video mode for watching movies automatically.

The THEATRE button functions only when connected to a Sony Theatre Mode-compatible AV amplifier (receiver) or Sony Theatre Mode-compatible TV.

### AUDIO (page 21)

Selects the language track when multi-lingual tracks are recorded on BD-ROMs/DVD VIDEOS.

Selects the sound track on CDs.

### SUBTITLE (page 21)

Selects the subtitle language when multi-lingual subtitles are recorded on BD-ROMs/DVD VIDEOS.

### $\heartsuit$ (favourites) (page 16)

Displays the Internet content added to the Favourites List. You can save up to 18 of your favourite Internet content programmes.

### 3 Colour buttons (red/green/yellow/blue)

Short cut keys for interactive functions.

### 4 TOP MENU

Opens or closes the BD's or DVD's Top Menu.

### POP UP/MENU

Opens or closes the BD-ROM's Pop-up Menu, or the DVD's menu.

## OPTIONS (page 16)

The options menu that can be selected appears on the screen.

## HOME

Enters the player's home menu.  
Displays the wall paper when pressed on the category icon of the home menu.

## RETURN

Returns to the previous display.



Moves the highlight to select a displayed item.

## Centre button (ENTER)

Enters the selected item.

## 5 <<</>>> (previous/next)

Skips to the previous/next chapter, track, or file.

## <-./.-> (replay/advance)

Briefly replays the current scenes for 10 seconds/briefly fast forwards the current scenes for 15 seconds.

## <<</>>> (fast reverse/fast forward)

- Fast reverses/fast forwards the disc when pressed during playback. Each time you press the button during playback of videos, the search speed changes.
- Plays in slow motion, when pressed for more than one second in pause mode.
- Plays one frame at a time, when pressed briefly in pause mode.

## ▶ (play)

Starts or re-starts playback.

## DISPLAY (page 15)

Displays the playback information on the screen.

## || (pause)

Pauses or re-starts playback.

## ■ (stop)

Stops playback and remembers the stop point (resume point).  
The resume point for a title/track is the last point you played or the last photo for a photo folder.

## 6 ⚙ (light) (BDP-S373 only)

Lights up the [4] and [5] buttons (except ←/↑/↓/→ and ENTER) and is useful for operation in the dark.

## Home menu display

The home menu appears when you press HOME. Select a category using ←/→. Select an item using ↑/↓, and press ENTER.

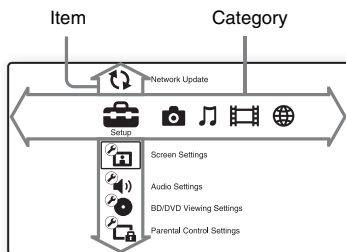

- (Setup): Adjusts the player settings.
- (Photo): Displays photos.
- (Music): Plays music.
- (Video): Plays videos.
- (Network): Displays network items.



## Step 1: Preparing the Player

### Checking the supplied accessories

Check that you have the following items:

- Remote commander (remote) (1)
- R6 (size AA) batteries (2)

### Preparing the remote

Insert two R6 (size AA) batteries by matching the  $\oplus$  and  $\ominus$  ends on the batteries to the markings inside the battery compartment.

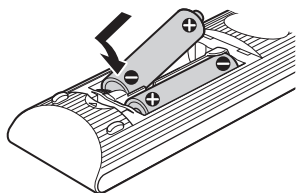

## Hookups and Settings

# Step 2: Connecting the Player

Do not connect the mains lead until you have made all the connections.

## Connecting to your TV

Select one of the following connection methods according to the input jacks on your TV. Match the colour of the plug to that of the jack when connecting.

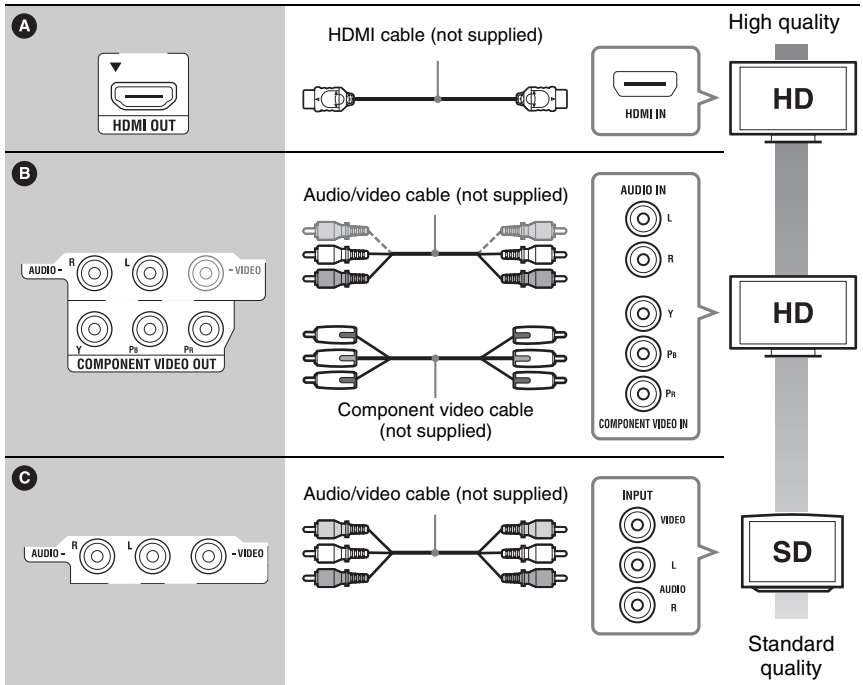
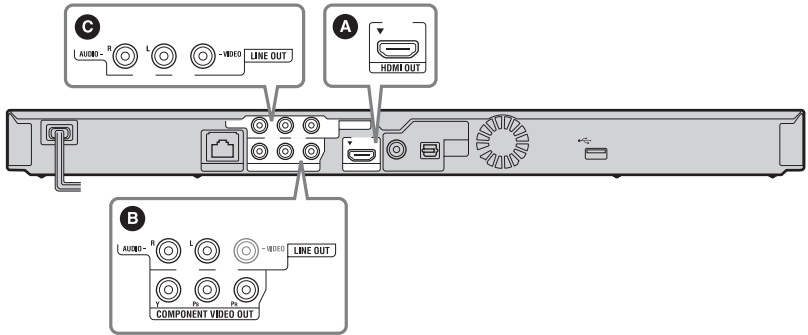



Do not connect the player through a VCR. Video signals fed through VCRs may be affected by copyright protection systems and the picture will be distorted on the television.

## Connecting to your AV amplifier (receiver)

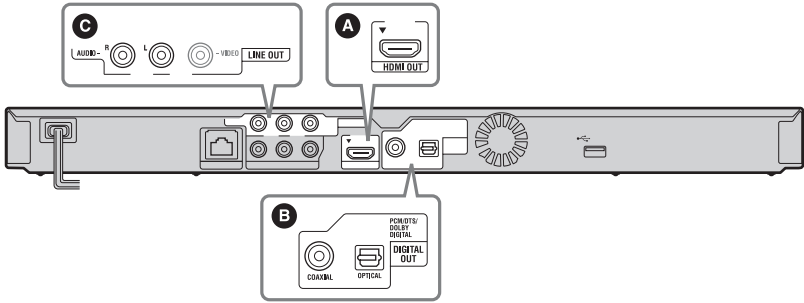
Select one of the following connection methods according to the input jacks on your AV amplifier (receiver). When you select **A** or **B**, make the appropriate settings in the “Audio Settings” setup (page 20).

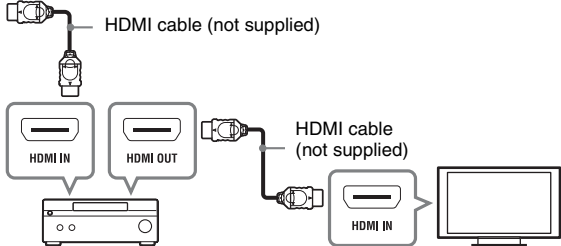
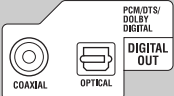
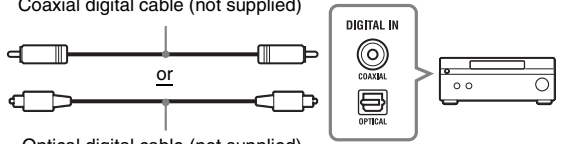

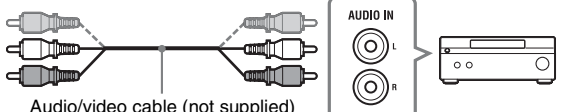
<p><b>A</b></p> 	 <p>HDMI cable (not supplied)</p> <p>→ Set “BD Audio MIX Setting” (page 20).</p>
<p><b>B</b></p> 	 <p>Coaxial digital cable (not supplied)</p> <p>or</p> <p>Optical digital cable (not supplied)</p> <p>→ Set “Dolby Digital (Coaxial / Optical)<sup>*1</sup>” (page 20) and “DTS (Coaxial / Optical)<sup>*2</sup>” (page 20).</p>
<p><b>C</b></p> 	 <p>Audio/video cable (not supplied)</p>

<sup>\*1</sup> Manufactured under license from Dolby Laboratories.  
Dolby, Pro Logic, and the double-D symbol are trademarks of Dolby Laboratories.

<sup>\*2</sup> Manufactured under license under U.S. Patent #’s: 5,451,942; 5,956,674; 5,974,380; 5,978,762; 6,226,616; 6,487,535; 7,212,872; 7,333,929; 7,392,195; 7,272,567 & other U.S. and worldwide patents issued & pending. DTS is a registered trademark and the DTS logos, Symbol, DTS-HD and DTS-HD Master Audio are trademarks of DTS, Inc.  
© 1996-2008 DTS, Inc. All Rights Reserved.

## Step 3: Easy Setup

### When turned on for the first time

Wait for a short while before the player turns on and starts “Easy Setup.”

### 1 Plug the player into the mains.

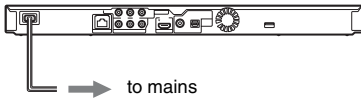

### 2 Press I/⏻ to turn on the player.

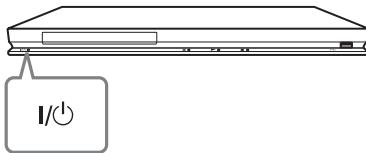

### 3 Turn on the TV, then switch the input selector on your TV so that the signal from the player appears on your TV screen.

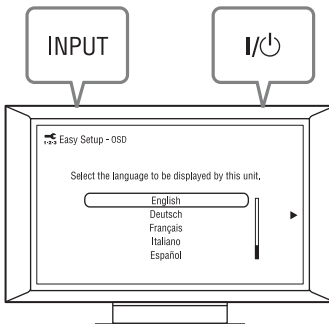

### 4 Perform “Easy Setup.”

Follow the on-screen instructions to make the basic settings using ←/↑/↓/→ and ENTER on the remote.

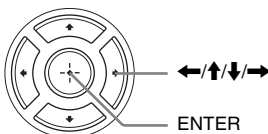

## Connecting to the Network

### Wired Setup

Use a LAN cable to connect to the LAN (100) terminal on the player.

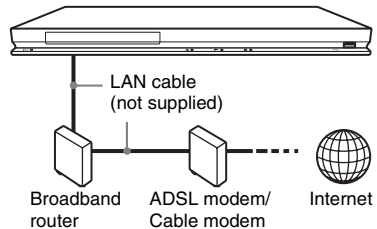

### To set the network settings

Select “Network Settings,” “Internet Settings,” then “Wired Setup” (page 24), and follow the on-screen instructions to complete the setup.

### USB Wireless Setup

Turn off the player, then connect the USB Wireless LAN Adapter (UWA-BR100 only available as of January 2010) to the USB jack on the front or rear of the player.



The USB Wireless LAN Adapter may not be available in some regions/countries.

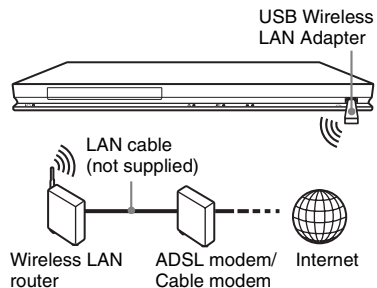

**To set the network settings**

Select “Network Settings,” “Internet Settings,” then “USB Wireless Setup” (page 24), and follow the on-screen instructions to complete the setup.

## Playback

### Playing a Disc

For playable discs, see “Playable discs” (page 29).

- 1** Switch the input selector on your TV so that the signal from the player appears on your TV screen.
- 2** Press **▲**, and place a disc on the disc tray.

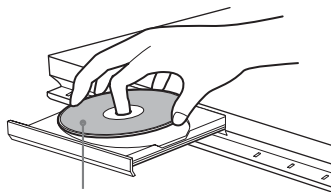

Playing side facing down

- 3** Press **▲** to close the disc tray.
  - appears on the home menu and playback starts.If playback does not start automatically, select ● in the **□** (Video), **♪** (Music), or **📷** (Photo) category, and press ENTER.

### Enjoying BONUSVIEW/BD-LIVE

Some BD-ROMs with “BD-LIVE Logo\*” have bonus content and other data that can be downloaded for enjoyment.

\* BD-LIVE™

- 1** Connect a USB memory to the USB jack on the rear of the player (page 6).  
As your local storage, use a 1 GB or larger USB memory.
- 2** Prepare for BONUSVIEW/BD-LIVE.
  - Connect the player to a network (page 12).
  - Set “BD Internet Connection” to “Allow” (page 21).

### 3 Insert a BD-ROM with BONUSVIEW/ BD-LIVE.

The operation method differs depending on the disc. Refer to the instruction manual supplied with the disc.



To delete data in the USB memory, select "Erase BD Data" in the (Video), and press ENTER. All data stored in the buda/budb folder will be erased.

## Displaying the play information

You can check the playback information, etc., by pressing DISPLAY. The displayed information differs depending on the disc type and player status.

Example: when playing a BD-ROM

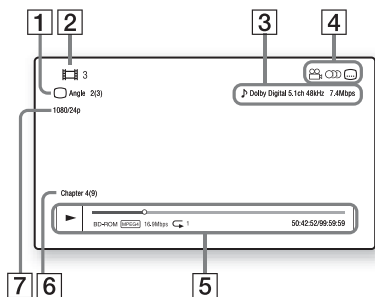

- 1 The currently selected angle
- 2 Title number or name
- 3 The currently selected audio setting
- 4 Available functions ( angle, audio, subtitle)
- 5 Playback information  
Displays the Play mode, Playing status bar, Disc type, Video codec, Bitrate, and Repeat type.
- 6 Chapter number
- 7 Output resolution/Video frequency

## Playing from a USB Device

You can play video/music/photo files on the connected USB device.

For playable USB devices, see "Playable types of files" (page 29).

### 1 Connect the USB device to the USB jack on the player.

Refer to the instruction manual supplied with the USB device before connecting.

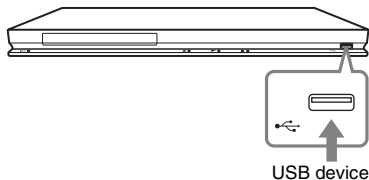







### 2 Select (Video), (Music), or (Photo) on the home menu using .

### 3 Select (USB Device) using , and press ENTER.

## Playing via a Network

### Streaming BRAVIA Internet Video





Serves as a gateway delivering the selected Internet content and a variety of on-demand entertainment straight to your player.

- 1 Prepare for BRAVIA Internet Video.**  
Connect the player to a network (page 12).
- 2 Select  (Video),  (Music), or  (Photo) on the home menu using /.**
- 3 Select an Internet content provider icon using /, and press ENTER.**  
When an Internet content list has not been acquired, an unacquired icon or a new icon is displayed.

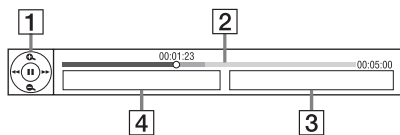
### To use the control panel

The control panel appears when the video file starts playing. The displayed items may differ depending on Internet content providers. To display again, press DISPLAY.



- 1 Control display**  
Press /// or ENTER for playback operations.
- 2 Playing status bar**  
Status bar, Cursor indicating the current position, Playing time, Duration of the video file
- 3 The next video file name**
- 4 The currently selected video file name and rating**

## Available Options

Various settings and playback operations are available by pressing OPTIONS. The available items differ depending on the situation.

### Common options

Items	Details
Playback History	Displays a title in playback history of BD-ROM/DVD-ROM/music CD based on Gracenote technology.
Repeat Setting	Sets the repeat mode.
Favourites List	Displays the Favourites List.
Play/Stop	Starts or stops the playback.
Play from start	Plays the item from the beginning.
Information Display	Displays information on the BD-ROM/DVD-ROM/music CD based on Gracenote technology.
Add to Favourites	Adds Internet content to the Favourites List.
Remove from Favourites	Removes Internet content from the Favourites List.

### (Video) only

Items	Details
AV SYNC	Adjusts the gap between picture and sound, by delaying the sound output in relation to the picture output (0 to 120 milliseconds).
Video Settings	<ul style="list-style-type: none"><li>• Picture Quality Mode: Selects the picture settings for different lighting environments.</li><li>• FNR: Reduces the random noise appearing in the picture.</li><li>• BNR: Reduces the mosaic-like block noise in the picture.</li><li>• MNR: Reduces minor noise around the picture outlines (mosquito noise).</li></ul>
Play/Pause	Starts or pauses the playback.



Items	Details
Top Menu	Displays the BD's or DVD's Top Menu.
Menu/Popup Menu	Displays the BD-ROM's Pop-up Menu or DVD's menu.
Title Search	Searches for a title on BD-ROMs/DVD VIDEOS and starts playback from the beginning.
Chapter Search	Searches for a chapter and starts playback from the beginning.
Angle	Switches to other viewing angles when multi-angles are recorded on BD-ROMs/DVD VIDEOS.





### (Photo) only











Items	Details
Slideshow Speed	Changes the slideshow speed.
Slideshow	Plays a slideshow.
Rotate Left	Rotates the photo counterclockwise by 90 degrees.
Rotate Right	Rotates the photo clockwise by 90 degrees.

## Settings and Adjustments

# Using the Settings Displays

Select  (Setup) on the home menu when you need to change the settings of the player. The default settings are underlined.

- 1 Select  (Setup) on the home menu using /.
- 2 Select the setup category icon using /, and press ENTER.

Icon	Explanation
	<b>Network Update (page 19)</b> Updates the software of the player.
	<b>Screen Settings (page 19)</b> Makes the video settings according to the type of connecting jacks.
	<b>Audio Settings (page 20)</b> Makes the audio settings according to the type of connecting jacks.
	<b>BD/DVD Viewing Settings (page 21)</b> Makes detailed settings for BD/DVD playback.
	<b>Parental Control Settings (page 22)</b> Makes detailed settings for the Parental Control function.
	<b>Music Settings (page 22)</b> Makes detailed settings for Super Audio CD playback.
	<b>System Settings (page 23)</b> Makes the player-related settings.
	<b>Network Settings (page 24)</b> Makes detailed settings for the Internet and network.
	<b>Easy Setup (page 24)</b> Re-runs the Easy Setup to make the basic settings.
	<b>Resetting (page 24)</b> Resets the player to the factory settings.

## Network Update

Select "OK" to update the player's software via the network.



- We recommend the network update every 2 months or so.
- For information about update functions, visit the following website:  
<http://support.sony-europe.com/>

## Screen Settings

### TV Type

16:9	Select this when connecting to a wide-screen TV or a TV with a wide mode function.
4:3	Select this when connecting to a 4:3 screen TV without a wide mode function.

### Screen Format

Original	Select this when connecting to a TV with a wide mode function. Displays a 4:3 screen picture in 16:9 aspect ratio even on a wide-screen TV.
Fixed Aspect Ratio	Changes the picture size to fit the screen size with the original picture aspect ratio.

### DVD Aspect Ratio

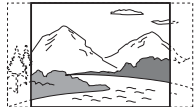
Letter Box	Displays a wide picture with black bands on the top and bottom. 
Pan & Scan	Displays a full-height picture on the entire screen, with trimmed sides. 

### Cinema Conversion Mode

Auto	Normally select this. The player automatically detects whether the material is video-based or film-based, and switches to the appropriate conversion method.
Video	The conversion method suited for video-based material will always be selected regardless of the material.

### Output Video Format

HDMI	Normally select "Auto." Select "Original Resolution" to output the resolution recorded on the disc. When the resolution is lower than the SD resolution, it is scaled up to the SD resolution.
Component Video	Select the resolution that suits your TV.
Video	Automatically sets the lowest resolution.



- When connecting the HDMI OUT jack and other video output jacks at the same time, select "Component Video."
- If no picture appears when setting "HDMI" or "Component Video" resolution, try another resolution setting.

## BD/DVD-ROM 1080/24p Output

<u>Auto</u>	Outputs 1920 × 1080p/24 Hz video signals only when connecting a 1080/24p-compatible TV using the HDMI OUT jack.
Off	Select this when your TV is not compatible with 1080/24p video signals.

## YCbCr/RGB (HDMI)

<u>Auto</u>	Automatically detects the connected TV type, and switches to the matching colour setting.
YCbCr (4:2:2)	Outputs YCbCr 4:2:2 video signals.
YCbCr (4:4:4)	Outputs YCbCr 4:4:4 video signals.
RGB	Outputs RGB video signals.

## HDMI Deep Colour Output

<u>Auto</u>	Normally select this.
12bit	Outputs 12bit/10bit video signals when the connected TV is compatible with Deep Colour.
10bit	
Off	Select this when the picture is unstable or colours appear unnatural.

## Pause Mode

<u>Auto</u>	Normally select this. Dynamic moving pictures appear without blurring.
Frame	Displays static pictures at high resolution.

## Audio Settings

### Audio (HDMI)

<u>Auto</u>	Normally select this. Outputs audio signals according to the status of the connected HDMI device.
PCM	Outputs PCM signals from the HDMI OUT jack.

### DSD Output Mode

On	Outputs DSD signals from the HDMI OUT jack when playing a Super Audio CD. When "On" is selected, analogue signals are not output when playing a Super Audio CD.
Off	Outputs PCM signals from the HDMI OUT jack when playing a Super Audio CD.

### BD Audio MIX Setting

On	Outputs the audio obtained by mixing the interactive and secondary audio to the primary audio.
Off	Outputs the primary audio only. Select this to output HD audio signals to an AV amplifier (receiver).

### Dolby Digital (Coaxial / Optical)

Downmix PCM	Converts to output Linear PCM signals. Select this when connecting an audio device without a built-in Dolby Digital decoder.
<u>Dolby Digital</u>	Select this when connecting an audio device with a built-in Dolby Digital decoder.

### DTS (Coaxial / Optical)

Downmix PCM	Converts to output Linear PCM signals. Select this when connecting to an audio device without a built-in DTS decoder.
<u>DTS</u>	Select this when connecting to an audio device with a built-in DTS decoder.

## Audio DRC

<u>Auto</u>	Performs playback at the dynamic range specified by the disc (BD-ROM only). Other discs are played back at the “Standard” level.
Standard	Performs playback at a standard compression level.
Wide Range	No compression works. A more dynamic sound is produced.

## Downmix

<u>Surround</u>	Outputs audio signals with surround effects. Select this when connecting an audio device that supports Dolby Surround (Pro Logic) or DTS Neo 6.
Stereo	Outputs audio signals without surround effects. Select this when connecting an audio device that does not support Dolby Surround (Pro Logic) or DTS Neo 6.

## BD/DVD Viewing Settings

### BD/DVD Menu

Selects the default menu language for BD-ROMs or DVD VIDEOS.

When you select “Select Language Code,” the display for entering the language code appears. Enter the code for your language by referring to “Language code list” (page 33).

### Audio

Selects the default track language for BD-ROMs or DVD VIDEOS.

When you select “Original,” the language given priority in the disc is selected. When you select “Select Language Code,” the display for entering the language code appears. Enter the code for your language by referring to “Language code list” (page 33).

### Subtitle

Selects the default subtitle language for BD-ROMs or DVD VIDEOS.

When you select “Select Language Code,” the display for entering the language code appears. Enter the code for your language by referring to “Language code list” (page 33).

### BD Hybrid Disc Playback Layer

<u>BD</u>	Plays BD layer.
DVD/CD	Plays DVD or CD layer.

### BD Internet Connection

Allow	Normally select this.
<u>Do not allow</u>	Prohibits Internet connection.

## Parental Control Settings

### Password

Sets or changes the password for the Parental Control function. A password allows you to set a restriction on BD-ROM or DVD VIDEO, and Internet video playback. If necessary, you can differentiate the restriction levels for BD-ROMs and DVD VIDEOS.

### Parental Control Area Code

Playback of some BD-ROMs, DVD VIDEOS, or Internet videos can be limited according to the geographic area. Scenes may be blocked or replaced with different scenes. Follow the on-screen instructions and enter your four-digit password.

### BD Parental Control

Playback of some BD-ROMs can be limited according to the age of the users. Scenes may be blocked or replaced with different scenes. Follow the on-screen instructions and enter your four-digit password.

### DVD Parental Control

Playback of some DVD VIDEOS can be limited according to the age of the users. Scenes may be blocked or replaced with different scenes. Follow the on-screen instructions and enter your four-digit password.

### Internet Video Parental Control

Playback of some Internet videos can be limited according to the age of the users. Scenes may be blocked or replaced with different scenes. Follow the on-screen instructions and enter your four-digit password.

### Internet Video Unrated

<u>Allow</u>	Allows the playback of unrated Internet videos.
Block	Blocks the playback of unrated Internet videos.

## Music Settings

### Super Audio CD Playback Layer

<u>Super Audio CD</u>	Plays the Super Audio CD layer.
CD	Plays the CD layer.

### Super Audio CD Playback Channels

DSD 2ch	Plays the 2ch area.
<u>DSD Multi</u>	Plays the multi-channel area.

## System Settings

### OSD

Selects your language for the player on-screen displays.

### Dimmer

<u>Bright</u>	Bright lighting.
Dark	Low lighting.
Off	Turns off the lighting during playback. Low lighting other than during playback.

### Control for HDMI

<u>On</u>	Allows you to use the “Control for HDMI” function (page 30).
Off	Turns off the function.

### Quick Start Mode

<u>On</u>	Shortens the startup time when turning on the player.
<u>Off</u>	Reduces standby power consumption.

### Auto Standby

<u>On</u>	Turns on the “Auto Standby” function. Automatically returns to standby mode if any button on the player or remote is not pressed for more than 30 minutes.
Off	Turns off the function.

### Auto Display

<u>On</u>	Automatically displays information on the screen when changing the viewing titles, picture modes, audio signals, etc.
Off	Displays information only when you press DISPLAY.

### Screen Saver

<u>On</u>	Turns on the screen saver function. The screen saver image appears when you do not use the player for more than 10 minutes while an on-screen display is displayed.
Off	Turns off the function.

### Software Update Notification

<u>On</u>	Sets the player to inform you of newer software version information (page 19).
Off	Turns off the function.

### Gracenote Settings

<u>Auto</u>	Automatically downloads disc information when disc playback stops. Connect to the network for downloading.
Manual	Downloads the disc information when “Playback History” or “Information Display” is selected in the options menu.

### DivX(R) VOD

For details, visit the following website:  
[vod.divx.com](http://vod.divx.com)

### System Information

Displays the player’s software version information and the MAC address.



## Network Settings

### Internet Settings

Connect the player to the network beforehand. For details, see “Connecting to the Network” (page 12).

View Network Status	Displays the current network status.
<u>Wired Setup</u>	Select this when you connect to a broadband router directly.
USB Wireless Setup	Select this when you use a USB Wireless LAN Adapter. For further details, visit the following website and check the FAQ contents: <a href="http://support.sony-europe.com/">http://support.sony-europe.com/</a>

### Network Connection Diagnostics

You can run the network diagnostic to check if the network connection has been made properly.

### BD Remote Device Registration

Registers your “BD Remote” device.

### Registered BD Remote Devices

Displays a list of the registered your “BD Remote” devices.



## Easy Setup

Re-runs the “Easy Setup” to make the basic settings. Follow the on-screen instructions.



## Resetting

### Reset to Factory Default Settings

You can reset the player settings to the factory default by selecting the group of settings. All the settings within the group will be reset.

### Initialize Personal Information

You can erase your personal information stored in the player.



## Additional Information

# Troubleshooting

If you experience any of the following difficulties while using the player, use this troubleshooting guide to help remedy the problem before requesting repairs. Should any problem persist, consult your nearest Sony dealer.

## Picture

### **There is no picture or the picture is not output correctly.**

- ➔ Check that all the connecting cables are securely connected (page 10).
- ➔ Switch the input selector on your TV to display the signal from the player.
- ➔ Reset the video output resolution to the lowest resolution by pressing ■ on the player for more than 10 seconds.
- ➔ For HDMI connections, try the following:
  - ① Turn the player off and on again.
  - ② Turn the connected equipment off and on again.
  - ③ Disconnect and then reconnect the HDMI cable.
- ➔ The HDMI OUT jack is connected to a DVI device that does not support copyright protection technology.
- ➔ For HDMI connections, check the “Output Video Format” settings in the “Screen Settings” setup (page 19).
- ➔ When the analogue signals are also output, set “BD/DVD-ROM 1080/24p Output” to “Off” in the “Screen Settings” setup (page 20).
- ➔ For BD-ROMs, check the “BD/DVD-ROM 1080/24p Output” setting in the “Screen Settings” setup (page 20).

### **The display language on the screen switches automatically when connected to the HDMI OUT jack.**

- ➔ When “Control for HDMI” is set to “On” (page 23), the display language on the screen automatically switches according to the language setting of the connected TV (if you change the setting on your TV, etc.).

## Sound

### **There is no sound or the sound is not output correctly.**

- ➔ Check that all the connecting cables are securely connected (page 10).
- ➔ Switch the input selector on your AV amplifier (receiver) so that the audio signals of the player are output from your AV amplifier (receiver).
- ➔ If the audio signal does not come through the DIGITAL OUT (OPTICAL/COAXIAL)/HDMI OUT jack, check the audio settings (page 20).
- ➔ For HDMI connections, try the following:
  - ① Turn the player off and on again.
  - ② Turn the connected equipment off and on again.
  - ③ Disconnect and then reconnect the HDMI cable.
- ➔ For HDMI connections, if the player is connected to a TV through an AV amplifier (receiver), try connecting the HDMI cable directly to the TV. Refer also to the instruction manual supplied with the AV amplifier (receiver).
- ➔ The HDMI OUT jack is connected to a DVI device (DVI jacks do not accept audio signals).
- ➔ The device connected to the HDMI OUT jack does not support the audio format of the player. Check the audio settings (page 20).

---

### **The HD Audio (Dolby Digital Plus, Dolby TrueHD, DTS-HD High Resolution Audio, and DTS-HD Master Audio) is not output by bitstream.**

- ➔ Set “BD Audio MIX Setting” to “Off” in the “Audio Settings” setup (page 20).
- ➔ Check that the connected AV amplifier (receiver) is compatible with each HD Audio format.

---

### **The interactive audio is not output.**

- ➔ Set “BD Audio MIX Setting” to “On” in the “Audio Settings” setup (page 20).

## Disc

### **The disc does not play.**

- ➔ The disc is dirty or skewed.
- ➔ The disc is upside down. Insert the disc with the playback side facing down.
- ➔ The disc has a format that cannot be played back by this player (page 29).
- ➔ The player cannot play a recorded disc that is not correctly finalised.
- ➔ The region code on the BD or DVD does not match the player.

## USB device

### **The player does not detect a USB device connected to the player.**

- ➔ Make sure that the USB device is securely connected to the USB jack.
- ➔ Check if the USB device or a cable is damaged.
- ➔ Check if the USB device is on.
- ➔ If the USB device is connected via a USB hub, connect the USB device directly to the player.

## BRAVIA Internet Video

### **The picture/sound is poor/certain programmes display a loss of detail, especially during fast-motion or dark scenes.**

- ➔ Picture/sound quality may be poor depending on Internet content providers.
- ➔ Picture/sound quality may be improved by changing the connection speed. We recommend the connection speed of at least 2.5 Mbps for standard definition video (10 Mbps for high definition video).
- ➔ Not all videos will contain sound.

---

### **The picture is small.**

- ➔ Press **↑** to zoom in.

## Network connection

### The player cannot connect to the network.

- ➔ Check the network connection (page 12) and the network settings (page 24).

### The message “A new software version has been found on the network. Perform update under “Network Update.”” appears on the screen when turning the player on.

- ➔ See “Network Update” (page 19) to update the player to a newer software version.

## BRAVIA Sync (“Control for HDMI”)

### The “Control for HDMI” function does not work (BRAVIA Sync).

- ➔ Check that “Control for HDMI” is set to “On” (page 23).
- ➔ If you change the HDMI connection, turn the player off and on again.
- ➔ If power failure occurs, set “Control for HDMI” to “Off,” then set “Control for HDMI” to “On” (page 23).
- ➔ Check the following and refer to the instruction manual supplied with the component.
  - the connected component is compatible with the “Control for HDMI” function.
  - the connected component’s setting for the “Control for HDMI” function is correct.
- ➔ When you connect the player to a TV through an AV amplifier (receiver),
  - if the AV amplifier (receiver) is not compatible with the “Control for HDMI” function, you may be unable to control the TV from the player.
  - if you change the HDMI connection, disconnect and reconnect the mains lead, or a power failure occurs, try the following:
    - ① Switch the input selector of the AV amplifier (receiver) so that the picture from the player appears on the TV screen.
    - ② Set “Control for HDMI” to “Off,” then set “Control for HDMI” to “On” (page 23). Refer to the instruction manual supplied with the AV amplifier (receiver).

## Others

### Playback does not start from the beginning of content.

- ➔ Press **OPTIONS**, and select “Play from start.”

### Playback does not start from the resume point where you last stopped playing.

- ➔ The resume point may be cleared from memory depending on the disc when
  - you open the disc tray.
  - you disconnect the USB device.
  - you play other content.
  - you turn off the player.

### The disc tray does not open and “LOCKED” or “TLK ON” appears on the front panel display.

- ➔ When “LOCKED” appears, the player is locked. To cancel the Child Lock, hold down **▶** on the player until “UNLOCK” appears on the front panel display (page 6).
- ➔ When “TLK ON” appears, contact your Sony dealer or local authorised Sony service facility.

### The disc tray does not open and you cannot remove the disc even after you press **▲**.

- ➔ Try the following:
  - ① Turn the player off, and disconnect the mains lead.
  - ② Reconnect the mains lead while pressing down **▲** on the player.
  - ③ Keep pressing down **▲** on the player until the tray opens.
  - ④ Remove the disc.
  - ⑤ When “WAIT” appears on the front panel display, hold down **I/⏪** on the player for more than 10 seconds until the player turns on again.

### “Exxxxx” or “FAN ERR” appears on the front panel display.

- ➔ When “Exxxxx” appears, contact your nearest Sony dealer or local authorised Sony service facility and give the error code.

- When “FAN ERR” appears, try the following: ①Check that the ventilation holes on the rear of the player are not blocked. ②Place the player in a location with adequate ventilation to prevent heat build-up in the player.

---

### The player does not respond to any button.

- Moisture has condensed inside the player (page 3).
- Hold down **I/⏻** on the player for more than 10 seconds until the indicators on the front panel display turn off. If the player still does not respond to any button, disconnect then reconnect the mains lead.

---

## Specifications

### System

**Laser:** Semiconductor laser

### Inputs and outputs

**(Jack name:**

Jack type/Output level/Load impedance)

**LINE OUT R-AUDIO-L:**

Phono jack/2 Vrms/10 kilohms

**DIGITAL OUT (OPTICAL):**

Optical output jack/-18 dBm  
(wave length 660 nm)

**DIGITAL OUT (COAXIAL):**

Phono jack/0.5 Vp-p/75 ohms

**HDMI OUT:**

HDMI 19-pin standard connector

**COMPONENT VIDEO OUT**

**(Y, P<sub>B</sub>, P<sub>R</sub>):**

Phono jack/Y: 1.0 Vp-p/  
P<sub>B</sub>, P<sub>R</sub>: 0.7 Vp-p/75 ohms

**LINE OUT VIDEO:**

Phono jack/1.0 Vp-p/75 ohms

**LAN (100):**

100BASE-TX Terminal

**USB:**

USB jack Type A (For connecting a USB memory, memory card reader, digital still camera, and digital video camera)

### General

**Power requirements:**

220–240 V AC, 50/60 Hz

**Power consumption:**

22 W

**Dimensions (approx.):**

430 mm × 219 mm × 36 mm  
(width/depth/height) incl. projecting parts

**Mass (approx.):**

2.0 kg

**Operating temperature:**

5 °C to 35 °C

**Operating humidity:**

25 % to 80 %

### Supplied accessories

See page 9.

Specifications and design are subject to change without notice.

## Playable discs

<b>Blu-ray Disc</b> <sup>*1</sup>	BD-ROM BD-R <sup>*2</sup> /BD-RE <sup>*2</sup>
<b>DVD</b> <sup>*3</sup>	DVD-ROM DVD-R/DVD-RW DVD+R/DVD+RW
<b>CD</b> <sup>*3</sup>	CD-DA (Music CD) CD-ROM CD-R/CD-RW Super Audio CD

<sup>\*1</sup> Since the Blu-ray Disc specifications are new and evolving, some discs may not be playable depending on the disc type and the version. The audio output differs depending on the source, connected output jack, and selected audio settings.

<sup>\*2</sup> BD-RE: Ver.2.1

BD-R: Ver.1.1, 1.2, 1.3 including organic pigment type BD-R (LTH type)

The BD-Rs recorded on a PC cannot be played if postscripts are recordable.

<sup>\*3</sup> A CD or DVD disc will not play if it has not been correctly finalised. For more information, refer to the instruction manual supplied with the recording device.

### Discs that cannot be played

- BDs with cartridge
- DVD-RAMs
- HD DVDs
- DVD Audio discs
- PHOTO CDs
- Data part of CD-Extras
- VCDs/Super VCDs
- Audio material side on DualDiscs

### Note on Discs

This product is designed to playback discs that conform to the Compact Disc (CD) standard. DualDiscs and some of the music discs encoded with copyright protection technologies do not conform to the Compact Disc (CD) standard, therefore, these discs may not be playable by this product.

### Note on playback operations of BDs/DVDs

Some playback operations of BDs/DVDs may be intentionally set by software producers. Since this player plays BDs/DVDs according to the disc contents the software producers designed, some playback features may not be available.

### Note about double-layer BDs/DVDs

The playback pictures and sound may be momentarily interrupted when the layers switch.

### Region code (BD-ROM/DVD VIDEO only)

Your player has a region code printed on the rear of the unit and will only play BD-ROMs/DVD-ROMs labelled with identical region codes or .

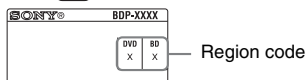

## Playable types of files

### Video

File format	Extensions
MPEG-1 Video/PS <sup>*1</sup> MPEG-2 Video/PS, TS <sup>*1</sup>	“.mpg,” “.mpeg,” “.m2ts,” “.mts”
DivX <sup>*2</sup>	“.avi,” “.divx”
MPEG-4 AVC <sup>*1</sup>	“.mkv,” “.mp4,” “.m4v,” “.m2ts,” “.mts”
WMV9 <sup>*1</sup>	“.wmv,” “.asf”
AVCHD	<sup>*3</sup>

### Music

File format	Extensions
MP3 (MPEG-1 Audio Layer III)	“.mp3”
AAC <sup>*1*4</sup>	“.m4a”
WMA9 Standard <sup>*1*4</sup>	“.wma”
LPCM	“.wav”

### Photo

File format	Extensions
JPEG	“.jpg,” “.jpeg”

<sup>\*1</sup> The player does not play coded files such as DRM.

\*2 ABOUT DIVX VIDEO: DivX® is a digital video format created by DivX, Inc. This is an official DivX Certified device that plays DivX video. Visit [www.divx.com](http://www.divx.com) for more information and software tools to convert your files into DivX video.

ABOUT DIVX VIDEO-ON-DEMAND: This DivX Certified® device must be registered in order to play DivX Video-on-Demand (VOD) content. To generate the registration code, locate the DivX VOD section in the device setup menu. Go to [vod.divx.com](http://vod.divx.com) with this code to complete the registration process and learn more about DivX VOD.

\*3 The player plays AVCHD format files that are recorded on a digital video camera, etc. The AVCHD format disc will not play if it has not been correctly finalised.

\*4 The player does not play coded files such as Lossless.



- Some files may not play depending on the format, the encoding, or recording condition.
- Some files edited on a PC may not play.
- The player can recognise the following files or folders in BDs, DVDs, CDs and USB devices:
  - up to folders in the 5th tree
  - up to 500 files in a single tree
- Some USB devices may not work with this player.
- The player can recognise Mass Storage Class (MSC) devices (such as flash memory or an HDD) that are FAT-compatible and non-partitioned, Still Image Capture Device (SICD) class devices and 101 keyboard (front USB jack only).
- To avoid data corruption or damage to the USB memory or devices, turn the player off when connecting or removing the USB memory or devices.
- The player may not play high bit rate video files on DATA CDs smoothly. You are recommended to play such files using DATA DVDs.

## About the BRAVIA Sync features (for HDMI connections only)

By connecting Sony components that are compatible with the “Control for HDMI” function with an HDMI cable (not supplied), operation is simplified as below:

- One-Touch Play  
With one touch of the following buttons, the connected TV turns on and the input selector on the TV is switched to the player automatically.
  - : HOME: The home menu appears automatically (page 8, 14, 18).
  - : Playback starts automatically.
- System Power-Off  
When you turn off the TV using -TV- or the power button on the TV’s remote, the player and HDMI-compatible components turn off automatically.
- Theatre  
When you press THEATRE, the player automatically switches to the optimum video mode for watching movies. When connected with a Sony AV amplifier (receiver) using the HDMI cable, the speaker output also switches automatically. When connected with a Theatre Mode-compatible TV using the HDMI cable, the TV’s video mode switches to Theatre Mode. Press the button again to return to the original setting.
- Language Follow  
When you change the language for the on-screen display on your TV, the player’s language for the on-screen display is also changed after turning the player off and on.

### To prepare for the BRAVIA Sync features

Set “Control for HDMI” to “On” in the “System Settings” setup (page 23). For details on settings of your TV or other connected components, refer to the instruction manual supplied with the TV or components.



- When connecting the Sony TV that is compatible with the “Control for HDMI” Easy Setting function using the HDMI cable, the “Control for HDMI” setting of the player automatically switches to “On” if the “Control for HDMI” setting on the connected TV is set to “On.” Refer to the instruction manual supplied with the TV.
- When connecting the Sony TV that is compatible with the BRAVIA Sync features using the HDMI cable, you can control the basic functions of the player with the TV’s remote if the “Control for HDMI” setting on the connected TV is set to “On.” Refer to the instruction manual supplied with the TV.



Depending on the connected component, the “Control for HDMI” function may not work. Refer to the instruction manual supplied with the component.

## About wireless LAN security

Since communication via the wireless LAN function is established by radio waves, the wireless signal may be susceptible to interception. To protect wireless communication, this player supports various security functions. Be sure to correctly configure the security settings in accordance with your network environment.

### ◆ No Security

Although you can easily make settings, anyone can intercept wireless communication or intrude into your wireless network, even without any sophisticated tools. Keep in mind that there is a risk of unauthorized access or interception of data.

### ◆ WEP

WEP applies security to communications to prevent outsiders from intercepting communications or intruding into your wireless network. WEP is a legacy security technology that enables older devices, which do not support TKIP/AES, to be connected.

### ◆ WPA-PSK (TKIP), WPA2-PSK (TKIP)

TKIP is a security technology developed to correct for the deficiencies of WEP. TKIP assures a higher security level than WEP.

### ◆ WPA-PSK (AES), WPA2-PSK (AES)

AES is a security technology that uses an advanced security method that is distinct from WEP and TKIP.

AES assures a higher security level than WEP or TKIP.

## Copyrights and Trademarks

- This product incorporates copyright protection technology that is protected by U.S. patents and other intellectual property rights. Use of this copyright protection technology must be authorized by Macrovision, and is intended for home and other limited viewing uses only unless otherwise authorized by Macrovision. Reverse engineering or disassembly is prohibited.
- “AVCHD” and the “AVCHD” logo are trademarks of Panasonic Corporation and Sony Corporation.
- Java and all Java-based trademarks and logos are trademarks or registered trademarks of Sun Microsystems, Inc.
- “XMB,” “XMB,” and “xross media bar” are trademarks of Sony Corporation and Sony Computer Entertainment Inc.
- This product incorporates High-Definition Multimedia Interface (HDMI™) technology. HDMI, the HDMI logo and High-Definition Multimedia Interface are trademarks or registered trademarks of HDMI Licensing LLC.
- “Blu-ray Disc” is a trademark.
- “Blu-ray Disc,” “DVD+RW,” “DVD-RW,” “DVD+R,” “DVD-R,” “DVD VIDEO,” and “CD” logos are trademarks.
- “BD-LIVE,” “BD-LIVE” logo, and “BONUSVIEW” are trademarks of Blu-ray Disc Association.
- “x.v.Colour” and “x.v.Colour” logo are trademarks of Sony Corporation.
- “BRAVIA” is a trademark of Sony Corporation.
- “PhotoTV HD” and the “PhotoTV HD” logo are trademarks of Sony Corporation.
- MPEG Layer-3 audio coding technology and patents licensed from Fraunhofer IIS and Thomson.
- DivX®, DivX Certified® and associated logos are registered trademarks of DivX, Inc. and are used under license.

- Music and video recognition technology and related data are provided by Gracenote®. Gracenote is the industry standard in music recognition technology and related content delivery. For more information, please visit [www.gracenote.com](http://www.gracenote.com). CD, DVD, Blu-ray Disc, and music and video-related data from Gracenote, Inc., copyright © 2000-present Gracenote. Gracenote Software, copyright © 2000-present Gracenote. One or more patents owned by Gracenote apply to this product and service. See the Gracenote website for a nonexhaustive list of applicable Gracenote patents. Gracenote, CDDB, MusicID, MediaVOCS, the Gracenote logo and logotype, and the “Powered by Gracenote” logo are either registered trademarks or trademarks of Gracenote in the United States and/or other countries.



- Other system and product names are generally trademarks or registered trademarks of the manufacturers. ™ and ® marks are not indicated in this document.

## Code numbers of controllable TVs

If more than one code number is listed, try entering them one at a time until you find the one that works with your TV.

Manufacturer	Code number
Sony	01 (default)
Grundig <sup>*1</sup>	11
Hitachi	24
ITT <sup>*1</sup>	15, 16
JVC <sup>*1</sup>	33
LG/Goldstar	76
Loewe	45
Nokia <sup>*1</sup>	15, 16, 69, 73
Panasonic	17, 49
Philips <sup>*2</sup>	06, 07, 08, 72
Saba <sup>*1</sup>	12, 13, 74
Samsung <sup>*3</sup>	22, 23, 71
Sanyo <sup>*1</sup>	25
Sharp	29
Telefunken <sup>*1</sup>	36
Thomson <sup>*1</sup>	43, 75
Toshiba	38

<sup>\*1</sup> BDP-S373 only

<sup>\*2</sup> Only 06, 08, or 72 can be selected for BDP-S370.

<sup>\*3</sup> Only 71 can be selected for BDP-S370.



## Language code list

For details, see “BD/DVD Viewing Settings” (page 21).

The language spellings conform to the ISO 639: 1988 (E/F) standard.

### Code Language

1027	Afar	1186	Scots Gaelic	1349	Macedonian	1511	Albanian
1028	Abkhazian	1194	Galician	1350	Malayalam	1512	Serbian
1032	Afrikaans	1196	Guarani	1352	Mongolian	1513	Siswati; Swati
1039	Amharic	1203	Gujarati	1353	Moldavian	1514	Sesotho; Sotho
1044	Arabic	1209	Hausa	1356	Marathi		southern
1045	Assamese	1217	Hindi	1357	Malay	1515	Sundanese
1051	Aymara	1226	Croatian	1358	Malese; Maltese	1516	Swedish
1052	Azerbaijani	1229	Hungarian	1363	Burmese	1517	Swahili
1053	Bashkir	1233	Armenian	1365	Nauru	1521	Tamil
1057	Byelorussian	1235	Interlingua	1369	Nepali	1525	Telugu
1059	Bulgarian	1239	Interlingue	1376	Dutch	1527	Tajik
1060	Bihari	1245	Inupiak	1379	Norwegian	1528	Thai
1061	Bislama	1248	Indonesian	1393	Occitan	1529	Tigrinya
1066	Bengali	1253	Icelandic	1403	Oromo	1531	Turkmen
1067	Tibetan	1254	Italian	1408	Oriya	1532	Tagalog
1070	Breton	1257	Hebrew	1417	Punjabi; Panjabi	1534	Setswana; Tswana
1079	Catalan	1261	Japanese	1428	Polish	1535	Tonga;
1093	Corsican	1269	Yiddish	1435	Pashto; Pushto		Tonga islands
1097	Czech	1283	Javanese	1436	Portuguese	1538	Turkish
1103	Welsh	1287	Georgian	1463	Quechua	1539	Tsonga
1105	Danish	1297	Kazakh	1481	Rhaeto-Romance	1540	Tatar
1109	German	1298	Greenlandic;	1482	Kirundi; Rundi	1543	Twi
1130	Bhutani; Dzongkha		Kalaallisut	1483	Romanian	1557	Ukrainian
1142	Greek	1299	Cambodian; Khmer	1489	Russian	1564	Urdu
1144	English	1300	Kannada	1491	Kinyarwanda	1572	Uzbek
1145	Esperanto	1301	Korean	1495	Sanskrit	1581	Vietnamese
1149	Spanish	1305	Kashmiri	1498	Sindhi	1587	Volapük
1150	Estonian	1307	Kurdish	1501	Sangho; Sango	1613	Wolof
1151	Basque	1311	Kirghiz	1502	Serbo-Croatian	1632	Xhosa
1157	Persian	1313	Latin	1503	Singhalese;	1665	Yoruba
1165	Finnish	1326	Lingala		Sinhalese	1684	Chinese
1166	Fiji	1327	Laothian; Lao	1505	Slovak	1697	Zulu
1171	Faroese	1332	Lithuanian	1506	Slovenian	1703	not specified
1174	French	1334	Latvian	1507	Samoaan		
1181	Frisian	1345	Malagasy	1508	Shona		
1183	Irish	1347	Maori	1509	Somali		

## Parental control/area code

For details, see “Parental Control Area Code” (page 22).

### Number, Area (Code)

2044, Argentina (ar)	2219, Hong Kong (hk)	2427, Pakistan (pk)
2047, Australia (au)	2248, India (in)	2424, Philippines (ph)
2046, Austria (at)	2238, Indonesia (id)	2428, Poland (pl)
2057, Belgium (be)	2239, Ireland (ie)	2436, Portugal (pt)
2070, Brazil (br)	2254, Italy (it)	2489, Russia (ru)
2090, Chile (cl)	2276, Japan (jp)	2501, Singapore (sg)
2092, China (cn)	2304, Korea (kr)	2149, Spain (es)
2093, Colombia (co)	2333, Luxembourg (lu)	2499, Sweden (se)
2115, Denmark (dk)	2363, Malaysia (my)	2086, Switzerland (ch)
2165, Finland (fi)	2362, Mexico (mx)	2543, Taiwan (tw)
2174, France (fr)	2376, Netherlands (nl)	2528, Thailand (th)
2109, Germany (de)	2390, New Zealand (nz)	2184, United Kingdom (gb)
2200, Greece (gr)	2379, Norway (no)	

---

# Index

Words in quotations appear in the on-screen displays.

## Symbols

♡ (favourites) 7

## A

AUDIO 7

“Audio Settings” 20

“Auto Standby” 23

## B

Batteries 9

“BD/DVD Viewing Settings” 21

BD-LIVE 14

BD-R 29

BD-RE 29

Bitstream 26

Blu-ray Disc 29

BONUSVIEW 14

BRAVIA Internet Video 16

BRAVIA Sync 27, 30

## C

CD 29

Child Lock 6, 27

Colour buttons 7

Connecting

AV amplifier

(Receiver) 11

Network 12

TV 10

“Control for HDMI” 23, 27, 30

## D

Deep Colour 20

“Dimmer” 23

DISPLAY 8

Dolby Digital 20

“DSD Output Mode” 20

DTS 20

DVD 29

## E

“Easy Setup” 12, 24

## G

“Gracenote Settings” 23

## H

HDMI 19, 20

HOME 8, 18

Home menu 18

## I

Internet content 7, 16

## L

Language Follow 30

## M

MAC address 23

“Music Settings” 22

## N

“Network Settings” 24

“Network Update” 19

## O

One-Touch Play 30

OPTIONS 8

“OSD” 23

## P

Parental Control 22

“Parental Control Settings”

22

Play information 15

Playable discs 29

POP UP/MENU 7

## Q

“Quick Start Mode” 23

## R

Region code 29

Remote 7, 9

“Resetting” 24

Resetting the player 24

Resume 8, 27

## S

“Screen Settings” 19

“Setup” 18

Software update 19, 23

SUBTITLE 7

System Power-Off 30

“System Settings” 23

## T

THEATRE 7, 30

TOP MENU 7

Troubleshooting 25

“TV Type” 19

## U

Update 19

USB 15

## W

WEP 31

WPA2-PSK (AES) 31

WPA2-PSK (TKIP) 31

WPA-PSK (AES) 31

WPA-PSK (TKIP) 31

