

## Owner's Manual

# Loudbox™ 100 | Acoustic Instrument Amplifier



# FISHMAN®

## Read Me!

---

Take a few minutes to read through this manual before you power-up the Loudbox 100. To jump in immediately, start with the **Important Safety Instructions** and the **Getting Started** sections. While this information will get you on your way, it is not considered a substitute for reading the entire manual.

## Save Your Packing Materials

---

The box and packing materials for the Loudbox 100 were specially designed to protect the amplifier during shipping. Save all this stuff in case you need to re-ship the Loudbox 100.

## Table of Contents

---

Safety Warnings	3
Welcome	4
Getting started	5
Front Panel	6-7
Rear Panel	8-9
Tone Tips	10
About Acoustic Feedback	11
Phantom Power FAQs	11
Stereo Blending	12
Block Diagram	13
Specifications	14-15
Warranty	16



CAUTION

Risk of electric shock.  
Do not open.

No user serviceable parts inside.  
Refer servicing to qualified personnel.  
Do not expose to rain or moisture.



Wherever this symbol appears, it alerts you to the presence of uninsulated dangerous voltage inside the enclosure that may be sufficient to constitute a risk of shock.



Whenever this symbol appears, it alerts you to the presence of important operating and maintenance (servicing) instructions in the user's manual for this amplifier.

## Important Safety Instructions

To ensure your personal safety and the safety of others, operate this apparatus only after reading these instructions and heeding the warnings listed below.

1. Read these instructions.
2. Keep these instructions.
3. Heed all warnings.
4. Follow all instructions.
5. Do not use this apparatus near water.
6. Clean only with a dry cloth.
7. Do not block the ventilation openings. Install in accordance with the manufacturer's instructions.
8. Do not install near any heat sources such as radiators, heat registers, stoves or other apparatus (including amplifiers) that produce heat.
9. Do not defeat the safety purpose of the polarized or grounding-type plug. A polarized plug has two blades with one wider than the other. A grounding-type plug has two blades and a third grounding prong. The wide blade or the third prong are provided for your safety. If the provided plug does not fit into your outlet, consult an electrician for replacement of the obsolete outlet.
10. Protect the power cord from being walked on or pinched, particularly at the plugs, convenience receptacles and the point where they exit from the apparatus.
11. Use only attachments/accessories specified by the manufacturer.

12. Use only with a cart, stand, tripod, bracket or table specified by the manufacturer, or sold with the apparatus. When a cart is used, use caution when moving the cart/apparatus combination to avoid injury from tip-over.



13. Unplug this apparatus during lightning storms or when unused for long periods of time.
14. Refer all servicing to qualified service personnel. Servicing is required when the apparatus has been damaged in any way, such as a power-supply cord or plug is damaged, liquid has been spilled or objects have fallen into the apparatus, the apparatus has been exposed to rain or moisture, does not operate normally, or has been dropped.

Do not expose the apparatus to dripping or splashing liquids and do not place objects filled with liquids (such as a beverage container or a vase) on the apparatus.

### Warning

To reduce the risk of fire or electric shock, do not expose this apparatus to rain or moisture.

## Hear This!

The Loudbox 100 amplifier is capable of cleanly reproducing the sound of your instrument at very high volume levels. Prolonged repeated exposure to high sound pressure levels (SPLs) without protection can cause permanent hearing loss. OSHA has set guidelines and specified permissible sound-exposure limits for those who work in high SPL environments.

### Permissible Noise Exposures

Duration per day, hours	Sound level dBA slow response
8	90
6	92
4	95
3	97
2	100
1 1/2	102
1	105
1/2	110
1/4 or less	115

To ensure against permanent hearing loss, wear hearing protection when you perform with amplification.

## Welcome ...

---

...and thank you for choosing the Fishman Loudbox 100! Our passion for acoustic instruments inspired us to create this amp – it is our sincere wish that the Loudbox 100 will inspire you as well!

With its unique bi-amplified design, the potent and portable, two-channel, 100 watt Loudbox 100 delivers more serious acoustic tone and volume than any other amp in its class. The secret to the Loudbox 100's sound lies in its two power amps and two-way speaker system. This powerful combination results in higher sound pressure levels and cleaner acoustic tones, watt-for-watt, than comparable acoustic amps.

You'll find this lightweight and compact amp is as comfortable in your home studio as it is onstage. It easily passes the "one-trip" test, for those times you carry both your instrument and your amp to the car or into the club.

The two-channel Loudbox 100 brings together a wish list of the essential features you've been looking for. The front panel includes inputs for acoustic instruments, a microphone and a CD player or drum machine. Dual EQ sections include bass, midrange and treble controls for easy, effective tone shaping. Vanquishing troublesome acoustic feedback is simple with independent anti-feedback filters and phase switches for each channel. We also include five digital effects you can really use: two halls, two plates, and a smooth chorus. A convenient mute switch keeps things quiet when you tune up or take a break. The Loudbox 100 also features a headphone jack for silent jamming or practicing.

On the rear panel, good things come in threes with D.I.s for channels 1 & 2, plus a third summed Mix-D.I. output (watch your soundperson smile). For pedal-heads, each channel has its own effects loop, a tuner out (Ch.1) and a 1/4" jack for a remote mute switch. With the Loudbox 100 on the floor, the speaker's ten-degree tilt-back angle helps to project your sound up to ear level.

So what are you waiting for? Grab your guitar and your Loudbox 100 and go out and make some music!

If you have questions or comments, please contact us through the Service and Support section of our website at [www.fishman.com](http://www.fishman.com).



## Getting Started

Here are some basic setup tips to help get you going. To operate the Loudbox 100 safely, please read the entire manual, especially the Important Safety Instructions on page 3.

If your amplifier has an operating voltage of 120V, plug the provided AC line cord into the back of the amplifier.

If your amplifier operates at 230V, you must supply your own detachable power cord. The cord you supply must have an IEC-style 320 connector at one end, and a male AC plug appropriate for your area at the other.

1. Locate the Power switch (above the rear panel power cord terminal) and switch it off (down position), then connect the power cord.
2. Plug the Loudbox 100 into an electrical outlet with the appropriate AC voltage.

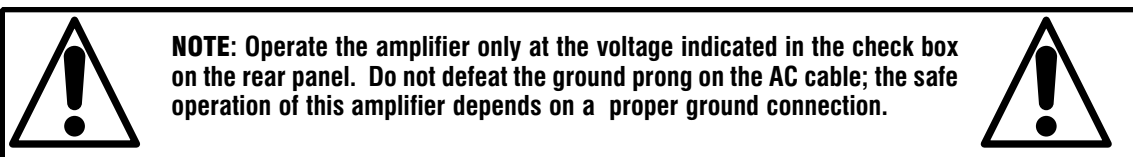

3. Push in the Mute switch and turn on the Power switch.
4. Connect your instrument to the Channel 1 input with a shielded 1/4-inch cable.
5. Play aggressively and raise Channel 1 Gain until Clip LED flashes, then back off the Gain until no clipping occurs.
6. Set the controls as illustrated below.

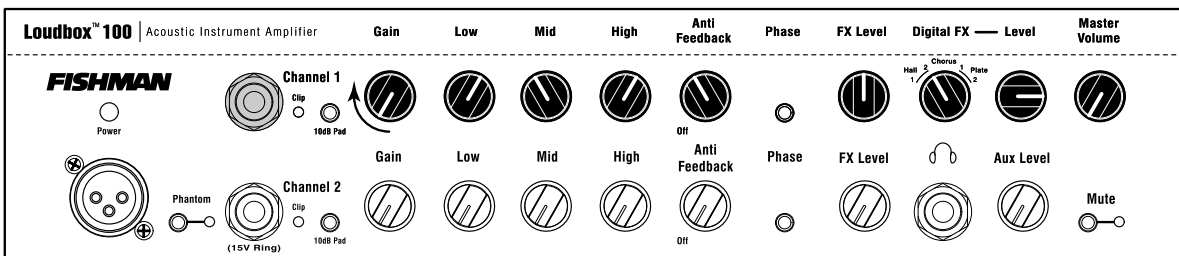

7. Push the Mute switch (out) and slowly raise the Master Volume to the desired level.



## 8. Gain

Use the Gain knob to set the level of the signal. If the Clip LED flashes when you play, lower the Gain until the flashing stops. If either channel is unused, set its Gain to 7 o'clock (off).

## 9. Low

Boost here to add weight to the sound. In general, boost bass at low volumes and flatten it out (or cut) at higher levels. With the dial set at 12 o'clock, the control is effectively out of the circuit.

## 10. Mid

This control affects how well the instrument blends in or stands out in the mix. At loud volumes a midrange cut will achieve a more natural sound. With the dial set at 12 o'clock, the control is effectively out of the circuit.

## 11. High

Boost highs to add "air" to the sound of the instrument. With the knob set at 12 o'clock, the control is effectively out of the circuit.

## 12. Anti-Feedback

If you encounter low-frequency feedback, sweep this control to isolate and eliminate it. Many guitars will benefit with the Anti-Feedback knob set at about 10 o'clock. The Anti Feedback filter is off at the 7 o'clock position.

*To read more about acoustic feedback, see page 11.*

## 13. Phase

Use the phase switch in conjunction with the Anti-Feedback filter to eliminate acoustic feedback.

*To read more about acoustic feedback, see page 11.*

## 14. FX Level

Controls the amount of digital effects in the channel. Generally set this above the Master FX Level.

## 15. Digital FX (Select)

These built-in effects have been specially chosen and voiced for acoustic instruments.

## 16. Digital FX Level (Master)

Set the overall level of the Digital FX with this knob. In general set this lower than the individual Channel 1 & 2 FX Levels.

## 17. Master Volume

Set the overall level of the Loudbox 100 with the Master Volume. In general put the Master Volume as high as possible (2 o'clock to 5 o'clock) to achieve the cleanest sound.

## 18. Headphone Jack

When you plug in stereo headphones here, the speakers shut off. This output monitors Channels 1 & 2 and the Aux input, so you can play along with pre-recorded music through the headphones.

## 19. Aux Level

Use this to control the level of the device you plug into the Aux Input. Note that the Aux channel is independent of the Mute switch, so you can play pre-recorded music on your breaks. If the Aux channel is unused, set the Aux level to off.

## 20. Mute

The Mute switch shuts off the signals from Channels 1 and 2 to the speakers and all the XLR outputs. The mute does not affect the Aux Channel, the Tuner Out or the effects sends.

Digital FX Programs
1. Hall 1
2. Hall 2
3. Chorus
4. Plate 1
5. Plate2

## Rear Panel

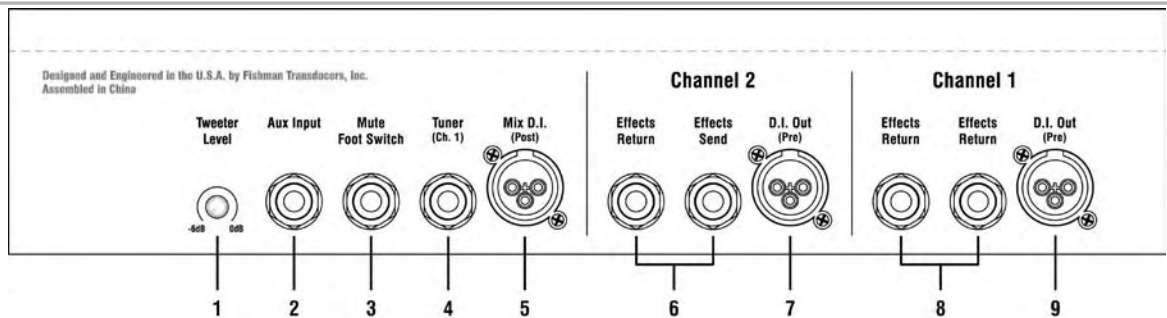

### 1. Tweeter Level

Set the front panel controls flat and adjust the tweeter level to where it sounds best to you.

### 2. Aux Input

Plug in a line level stereo audio source such as a CD or MP3 player in this input. The 1/4 inch stereo (TRS) Aux Input mixes the signals to mono when amplified, but will retain the source's stereo image through the headphones jack.

### 3. Mute Foot Switch

Plug a mono, on/off (latching type) foot switch into this jack for remote access to the Mute. The Mute Footswitch duplicates and overrides the front panel Mute switch.

### 4. Tuner Out

Plug in an electronic tuner here. This output receives only the Channel 1 signal and is independent of the mute, so you can tune with the speakers and the XLR outs muted. The Tuner Out can also be used as pre-EQ unbalanced D.I. out for Channel 1.

### 5. Mix D.I. (Post)

Plug in here when you wish to send signals from both Channel 1 and 2 to a mixing console or a slave amplifier. This post-EQ output is always ground isolated to prevent ground loop hum.

### 6. Channel 2 Effects Loop (Serial)

Patch an external effect (delay, reverb, chorus) through these jacks. Use a standard 1/4-inch shielded instrument cable to connect the Channel 2 send to the input of the effect. Connect the Channel 2 return jack to the output of the effect. The Channel 2 loop is located post-EQ and is compatible with battery-operated stompbox-style effects processors.

### 7. Channel 2 D.I. Out (Pre-EQ)

You'll find that this true direct output produces an uncolored signal that is exceptional for recording. Use this output when you want a flat D.I. signal to go to the board. In this case you leave it to the soundperson or recording engineer to dial up your tone and effects from the console. This pre-EQ output is always ground isolated to prevent ground loop hum.

### 8. Channel 1 Effects Loop (Serial)

Patch an external effect (delay, reverb, chorus) through these jacks. Use a standard 1/4-inch shielded instrument cable to connect the Channel 1 send to the input of the effect. Connect the Channel 1 return jack to the output of the effect. The Channel 1 loop is located post-EQ and is compatible with battery-operated stompbox-style effects processors.

### 9. Channel 1 D.I. Out (Pre-EQ)

You'll find that this true direct output produces an uncolored signal that is exceptional for recording. Use this output when you want a flat D.I. signal to go to the board. In this case you leave it to the soundperson or recording engineer to dial up your tone and effects from the console. This pre-EQ output is always ground isolated to prevent ground loop hum.



## Rear Panel

### Power Switch

Lower the master volume or engage the Mute switch before you turn on the amp. Flip the power switch to the up position and it will light, indicating the amp is on.

### AC Power

Operate the amplifier only at the voltage indicated in the check box on the rear panel.

For 120V amplifiers purchased in the USA, Canada and Mexico, plug in the supplied detachable AC power cable.

For 230V amplifiers purchased outside the USA and Canada, you will need to supply your own detachable AC cable. This cable must have an IEC-style 320 connector at one end, and a male AC plug appropriate for your region at the other.

### Fuse Holder

The fuse is located within the AC power receptacle on the back of the amp. Access the fuse compartment with a small slotted screwdriver.

For 120V amplifiers purchased in the USA and Canada, replace the fuse with: Littelfuse® type 218002 or equivalent 5 x 20 mm, 2A, 250V, time-delay fuse.

For 230V amplifiers purchased outside the USA and Canada, replace the fuse with: Littelfuse® type 218001 or equivalent 5 x 20 mm, 1A, 250V, time-delay fuse.

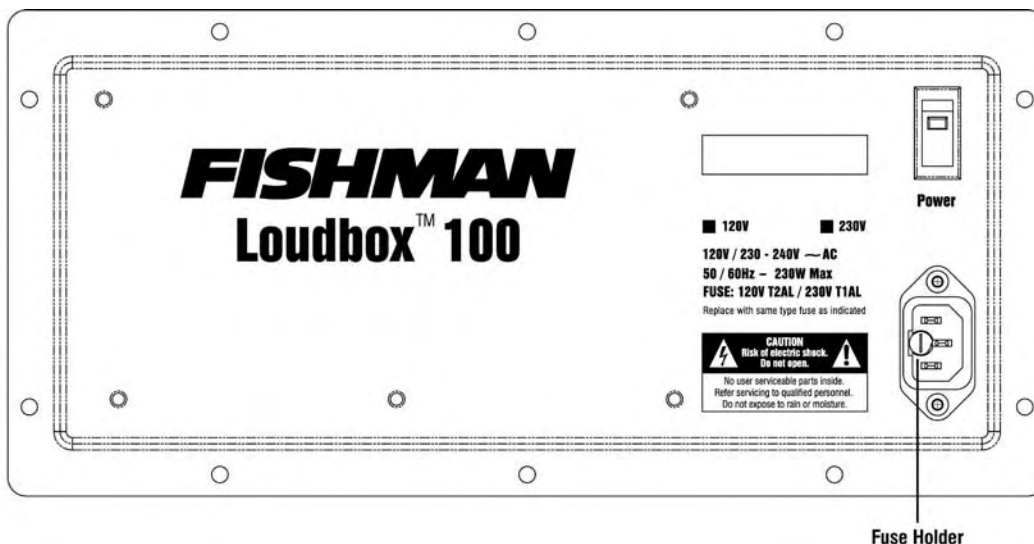

# Tone Tips

You can find a balanced tone with the Loudbox 100 when you hear how tone changes as the volume rises.

## Set Up

For reference, start with the tone controls flat (straight-up, twelve o'clock). In this position, there is no equalization applied to your sound. Begin at a very low volume and work your way up. As you turn up, try adjusting the Loudbox 100's tone controls as recommended below.

### 1. Low Volume

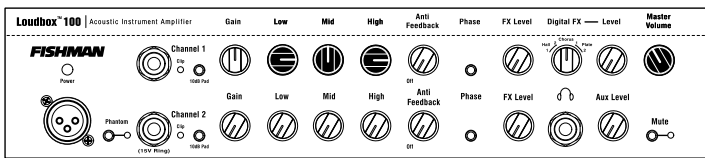

At a low volume (just above conversation level) our ears are not very sensitive to bass and treble, so give the Low and High controls a good boost. Try three o'clock on the dial.

### 2. Medium Volume

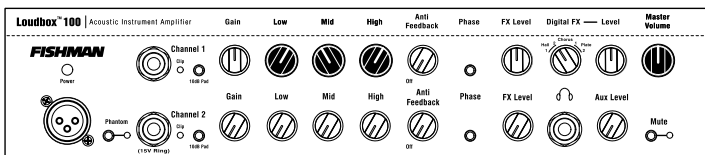

At intermediate levels, when you need to raise your voice to be heard over the music, the human ear is quite sensitive to midrange. Cut the Mid control to about ten o'clock, or to your taste. At this level our perception of bass and treble starts to catch up to the rest of the tonal spectrum, so you can back off the Low and High controls slightly for good tonal balance.

### 3. High Volume

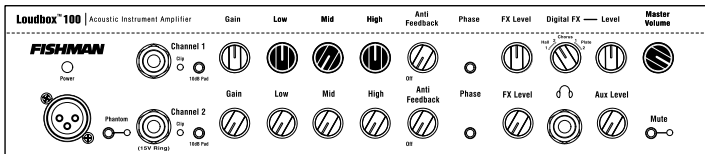

At loud levels, when you must shout to be heard over the music, your ears (and your audience) will benefit from a deep mid-range cut. Set the Mid dial between nine and seven o'clock. Our perception of bass and treble "flattens out" at high volumes, so you won't need much, if any Low or High boost. Set the Low and High knobs to between twelve and one o'clock. In many cases you can also improve the tone at very high volume if you cut bass. Try setting the Low knob between ten and eleven o'clock.

# About Acoustic Feedback

Feedback usually occurs in the lowest octave of your instrument, generally with two notes about a half step apart. The lower type of feedback (cavity resonance) starts when the sound pressure coming out of the speakers excites the resonant air chamber inside your instrument. We have found that it is effective to tune out an instrument's cavity resonance feedback with the Anti-Feedback (notch filter) in the Loudbox 100. For acoustic guitar this occurs at G# on the low E-string, or at about 100Hz. Turn the Anti-Feedback knob to about 11 o'clock to dial out this resonance. Note that the circuit can be effectively defeated by moving the dial to the OFF (7 o'clock) position.

The higher range of feedback (top resonance) usually starts about a half or whole step above cavity resonance of the instrument. Top resonance feedback happens when the sound pressure coming off the speakers excites the resonant frequency of the soundboard of your instrument. For acoustic guitar this occurs at A and above on the low E-string. Push the Phase switch in and out until you find the position that subdues top resonance feedback.

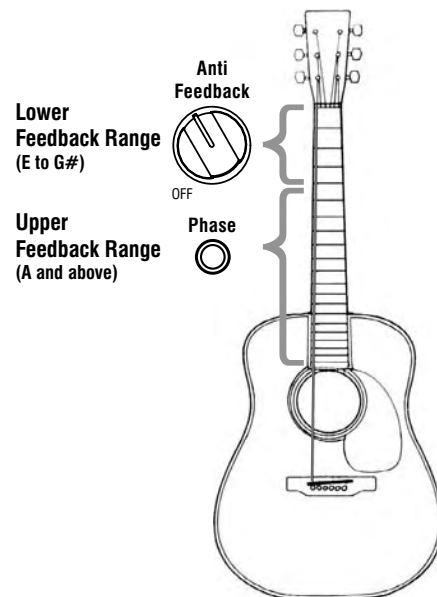

## Phantom Power FAQs

**Q: I have heard 24V phantom power can damage some audio devices. True?**

**A: Yes, phantom power can damage the following:**

1. An unbalanced dynamic mic that has been modified for XLR.
2. A balanced line-level device that is not designed to accept phantom power (ex: some effects processors). Contact the manufacturer to confirm compatibility.
3. Some older balanced wireless receivers can be damaged by phantom power. Consult the manufacturer of the wireless unit for compatibility.
4. An instrument preamp or stompbox with an unbalanced output that is modified for XLR.

**Important Note: Turn off phantom power if you plug any of the above into the XLR input.**

**Q: Which devices are safe with 24V phantom power?**

**A: All the following can be used safely with phantom power:**

1. All balanced condenser microphones.
2. All balanced dynamic microphones.
3. Many new wireless units. Check with the manufacturer for compatibility.
4. A preamp/DI designed for phantom-power operation, such as the Fishman Pro-EQ Platinum.

# Stereo Blending

If your instrument has two signal sources (typically mini-mic and pickup) and stereo output, you may route these signals into separate channels of the amp and blend them independently for your own custom mixes.

1) Plug in a stereo (TRS) instrument cable between your guitar and the Channel 2, 1/4-inch input.

2) Pickup (tip) is routed to Channel 2 and Mic (ring) is routed to Channel 1.

3) Turn on phantom power if mini-mic requires it.

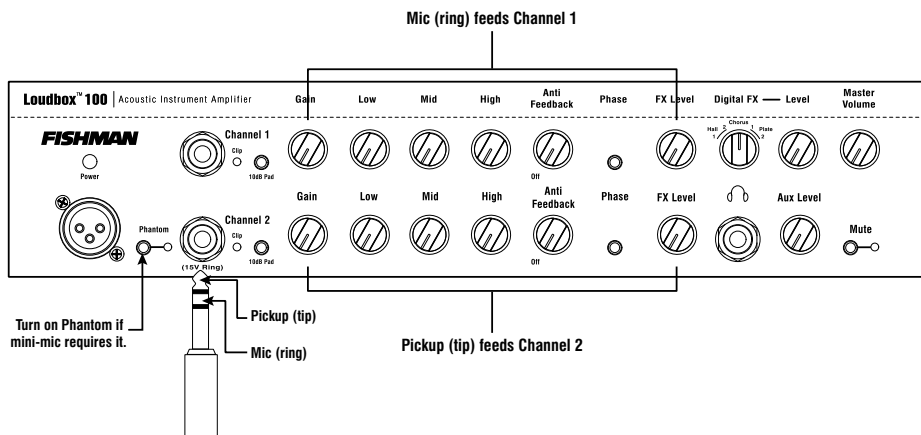
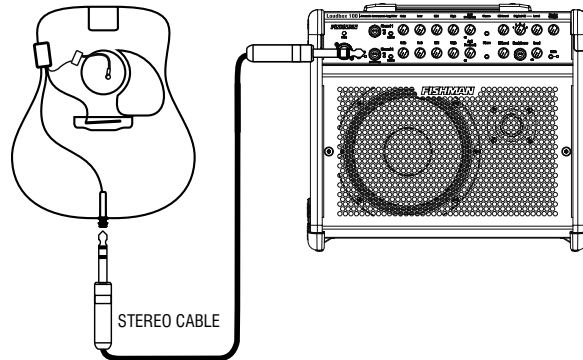

Below are setup instructions for two common Fishman products with stereo blending capability. For other products, follow the manufacturer's instructions for setup.

## Prefix Premium Blend & Prefix Stereo Blender

Open battery compartment and move switch to "stereo."

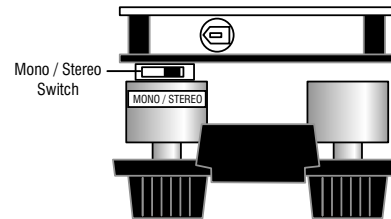

## Rare Earth Blend

- 1) Rewire jack for stereo operation
- 2) Move thumbwheel on pickup toward treble strings.

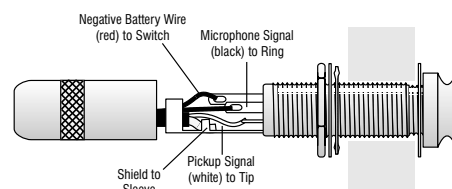

# Block Diagram

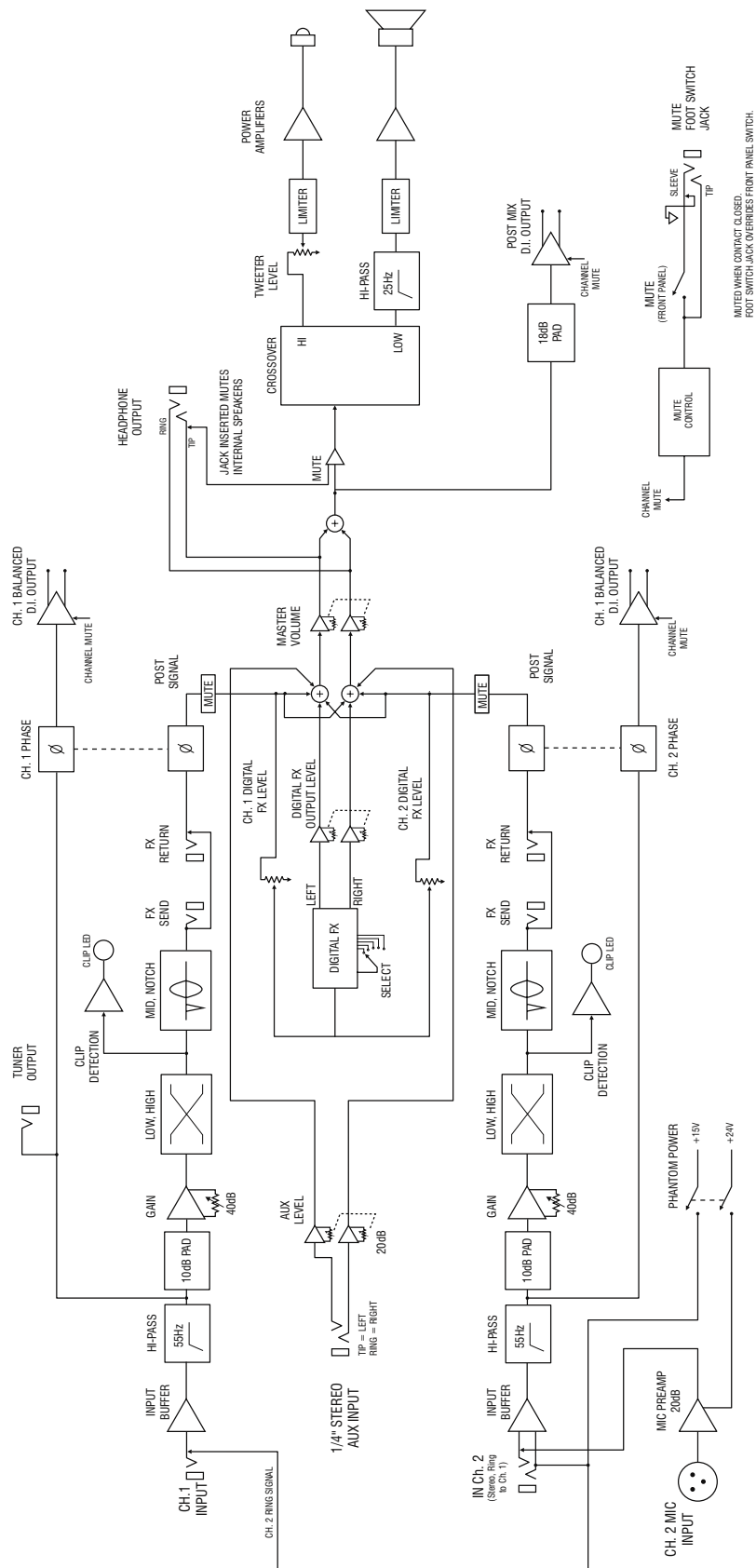

MUTE WHEN CONTACT CLOSED  
FOOT SWITCH JACK OPENS FRONT PANEL SWITCH.

## Technical Specifications

---

**Rated Power:**

Cumulative	100Wrms
Woofer Amp	90Wrms continuous
Tweeter Amp	10Wrms continuous
All measurements @ nominal line 120V, 60Hz	

---

**Acoustic Response:**

SPL @ 1 Meter	114dB SPL
Frequency Response	80Hz – 20kHz ± 4dB

---

**Power Consumption:**150W max

---

**Input Impedance:**

Ch.1	10M Ohm
Ch.2, 1/4" Jack (tip)	10M Ohm
Ch.2, 1/4" Jack (ring)	10M Ohm, 10k Ohm with 15V phantom power
Ch.2, XLR Input	2.4k Ohm Balanced
Aux Input (stereo)	10k Ohm

---

**Nominal Input Level:**

Ch.1	-20dBV/-10dBV with 10dB pad
Ch.2, 1/4" Jack (tip)	-20dBV/-10dBV with 10dB pad
Ch.2, 1/4" Jack (ring)	-20dBV/-10dBV with 10dB pad
Ch.2, XLR Input	-40dBV/-30dBV with 10dB pad
Aux Input (stereo)	-10dBV

---

**Maximum Recommended Input Level:**

Ch.1	6dBV
Ch.2, 1/4" Jack (tip)	6dBV
Ch.2, 1/4" Jack (ring)	6dBV
Ch.2, XLR Input	-14dBV
Aux Input (stereo)	6dBV

---

**Phantom Power (Ch.2 Only):**

XLR Input	24Vdc/1.2k Ohm dc Source Impedance per pin
1/4" Jack (ring)	15Vdc/10k Ohm dc source impedance

---

**Tone Controls and Anti-Feedback (Ch.1 and Ch.2):**

Low	± 10dB @ 100Hz (shelving)
Mid	± 12dB @ 1.2kHz (resonant)
High	± 12dB @ 10kHz (shelving)
Anti-Feedback Range	-14dB @ 20– 400Hz (Hi – Q resonant)

---

**Digital Effects:**

Program 1	Hall 1
Program 2	Hall 2
Program 3	Chorus
Program 4	Plate 1
Program 5	Plate 2

## Technical Specifications Cont'd

---

### Channel 1 & 2 D.I. Out

Output Impedance	600 Ohm balanced
	Phantom power tolerant, ground isolated

### Channel 1 & 2 Effects Sends:

Output Impedance	2.2k Ohm
Output Voltage	+3dBV (1.4Vrms max)
	-10dBV Nominal

### Channel 1 & 2 Effects Returns:

Input Impedance	20k Ohm
Input Voltage	+3dBV (1.4Vrms max)
	-10dBV Nominal

Sends and returns are compatible with battery operated effects processors

---

### Mix D.I. Out:

Output Impedance	600 Ohm balanced
	Phantom power tolerant, ground isolated

---

### Tuner Out:

Output Impedance	5k Ohm
------------------	--------

---

### Speaker System:

Woofers	8" paper cone
Tweeter	1" soft dome, rare earth magnet, ferrofluid cooled
Tweeter Level	Up to 6dB cut
Crossover	4kHz (Bi-amplified with active crossover)
Baffle Angle	10 Degrees

---

### Physical:

Dimensions	16" x 13.5" x 11.5" (40.5cm x 34cm x 29cm)
Weight	23 lbs (10.5 kg)

*We reserve the right to change any of the specifications and information in this manual without notice.*

## Limited Warranty

### ***Save your original sales receipt. It is your proof of purchase if you require warranty service.***

Fishman Acoustic Instrument Amplifiers ("Products") are warranted to the original consumer purchaser to be free of defects in materials and workmanship under normal use and service for a period of one (1) year from the date of purchase, with the exception of the speaker components which are warranted for a period of ninety (90) days from the date of purchase. If the Product fails to function properly due to defects in materials or workmanship during the applicable warranty period, Fishman Transducers Inc. ("Fishman"), at its option, will repair or replace the Product, with no charge for labor or materials. This warranty applies only if the Product is sold and delivered within the U.S. by an authorized Fishman Dealer.

Warranty service and repairs for Fishman Acoustic Instrument Amplifiers are to be made only at an authorized Fishman Service Center OR at the factory in Wilmington MA. Unauthorized repairs will void this warranty.

**Note:** For factory warranty service, the customer must prepay freight to Fishman.

**EXCEPT AS SPECIFICALLY PROVIDED IN THIS DOCUMENT, THERE ARE NO OTHER WARRANTIES, EXPRESSED OR IMPLIED, INCLUDING, BUT NOT LIMITED TO, IMPLIED WARRANTIES OF MERCHANTABILITY OR FITNESS FOR A PARTICULAR PURPOSE. IN NO EVENT SHALL FISHMAN BE LIABLE FOR LOSS OF PROFITS OR INCIDENTAL, INDIRECT, SPECIAL, CONSEQUENTIAL OR OTHER SIMILAR DAMAGES ARISING OUT OF ANY BREACH OF WARRANTY OR OTHER OBLIGATION CONTAINED IN THIS OWNERS' MANUAL. THE WARRANTY CONTAINED HEREIN SHALL NOT APPLY IF THE SERIAL NUMBER IS DEFACED OR REMOVED OR THE PRODUCT HAS BEEN DAMAGED BY ALTERATION, MISUSE, ACCIDENT, NEGLIGENCE OR USE WITH UNAUTHORIZED ATTACHMENTS.**

### ***To obtain warranty service from an authorized Fishman Service Center:***

1. The Fishman Dealer where you purchased your amplifier may also be authorized to perform warranty service and should be your first point of contact. If the Fishman Dealer who sold the Product is authorized to service the amplifier, bring the defective unit to the service center along with your original sales receipt. If you can't provide the original receipt, the authorized Fishman Service Center may charge you for repairs.

If your local Fishman Dealer cannot service the amplifier, contact Service & Support at [www.fishman.com](http://www.fishman.com) and we will recommend an authorized Fishman Service Center in your area. If there is no service center close to you, return the amplifier to the factory as described below.

2. Make sure you can duplicate the problem for the Service Center. If you bring in the amplifier for warranty service and the problem can't be duplicated by the technician, you may be charged a service fee.
3. Fishman Authorized Service Centers reserve the right to inspect the amplifier before beginning warranty service. Final determination of warranty coverage lies solely with Fishman Transducers or its Authorized Service Centers.
4. Fishman assumes no responsibility for the quality or timeliness of repairs performed by Fishman Authorized Service Centers.

### ***To obtain factory service:***

Amplifiers repaired under warranty at the Fishman factory will be returned to the customer UPS ground freight, prepaid by Fishman to any location within the continental United States.

### ***Important!***

***A Product that is returned to Fishman which is not covered by the terms of this warranty will be repaired and returned C.O.D. with billing for labor, materials, return freight and insurance.***

### ***For factory service, you must deliver the amplifier prepaid-freight to Fishman.***

1. Contact Fishman Transducers Factory Service via Service and Support at [www.fishman.com](http://www.fishman.com) to obtain a Return Merchandise Authorization number (RMA number). Products returned without an RMA number will be refused.
2. Pack the amplifier in its original shipping carton. If you do not have the carton, request one from us when you get your RMA number. Include your shipping address (no P.O. boxes or route numbers). Also include a copy of your sales receipt and a note that explains how to duplicate the problem. If we cannot duplicate the problem at the Factory or verify the original purchase date, we may, at our option, charge for parts/labor and return shipping.
3. Ship the amplifier freight prepaid to:

***Fishman Transducers Service Department  
340 Fordham Road, Wilmington, MA 01887 USA***

***FISHMAN***<sup>®</sup>

***www.fishman.com***

513-100-105 • Rev B • 12-05