

www.fishman.com

FISHMAN

**USER GUIDE
PRO-EQ PLATINUM BASS**

Welcome

Thank you for making Fishman a part of your acoustic experience. We are proud to offer the finest acoustic amplification products available; high-quality professional-grade tools which empower you to sound your very best.

Quick Start

1. Place XLR Pre/Post switch to "post" position.
2. Adjust the Input Gain so that the Clip/Low Battery light barely flickers with strong playing.
3. For acoustic bass only: Set Phase switch to position that sounds best and suppresses feedback.
4. Set Compression and Depth to 10:00.
5. Set EQ and re-adjust Input Gain if necessary (Clip LED should barely flicker with strong playing).

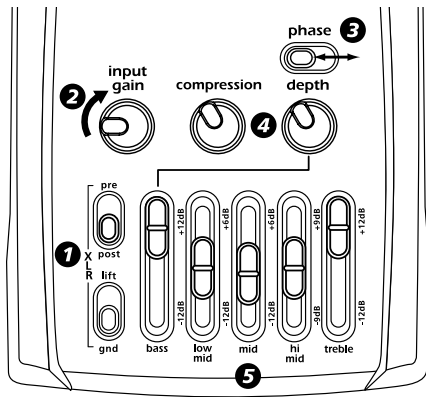

Power Options

1. 9-Volt Battery

Squeeze the tabs on top of the preamp together and the battery drawer will pop out. Snap in a fresh 9-Volt alkaline. To conserve the battery, unplug the input of the Platinum Bass when you are not using the preamp.

2. 48-Volt Phantom Power

Use an XLR cable to connect the Platinum Bass to a mixing board with 48V phantom power. When you turn on the 48V phantom at the mixer, the green 48V phantom LED lights up, the 9V battery shuts off and the Platinum Bass draws power through the XLR cable.

The green 48V phantom LED may not light up once you switch on phantom power. This means the phantom power from the mixer is not delivering enough voltage. For insurance, keep a fresh 9V battery in the preamp. The battery will take up the slack if the phantom power is too low.

3. AC Adapter Input

Use only a well filtered and regulated AC adapter with a 9-Volt DC output. We recommend the Fishman 910-R. Use of a non-recommended adapter may void the warranty and damage the unit.

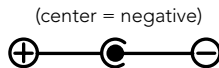

Input—Plug your bass in here

When you plug into the input jack, the 9-Volt battery switches on. Remember to unplug the input jack when you are not using the preamp to save the battery. Turn down your amp or mute your mixer input before you plug into the Platinum Bass input to protect your speakers (and your ears) from loud pops.

Input Gain

For the cleanest possible signal, adjust the Input Gain so that the Clip/Low Battery LED barely flickers with strong playing. If the Clip LED lights up brightly as you play, your bass signal is overdriving the circuit and you will hear distortion. Not every instrument will have enough signal to engage the Clip light on your Platinum. This is perfectly acceptable.

Clip/Low Battery Indicator

This light has three distinct functions:

1. Power Up Indicator

The LED flashes briefly when you plug into the input—it is telling you that the unit is powering up.

2. Clip Indicator

Flashes brightly when your bass signal overloads the preamp. Adjust the Input Gain so that the Clip LED barely flashes with strong playing.

3. Low Battery Warning

When the red LED lights with no signal present it is time to change the battery. If the Low Battery light comes on while you're playing don't worry, you'll have enough power to get through a gig (at least 4 hours).

Volume

For the cleanest sound, set the Volume as high as you can without distorting your amp or mixer.

Compression

This allows you to alter the attack, sustain and dynamics of your bass. Set the Input Gain before you turn on the compressor (compression is off at 7:00).

Compression (continued)

To gently smooth out your instrument's all-around response, set the Compression between 8:00 and 11:00. For more punch set the Compression between 12:00 and 2:00. This is especially effective for tumbao and walking bass styles.

For heavy compression with lots of sustain set the Compression knob between 3:00 and 5:00 (for best results set the Input Gain as high as possible without lighting the red Clip light).

Depth

Tighten up your sound, or dial out deep-bass feedback with the Depth control. The Depth control works hand in hand with the Bass control to bring out tight and articulate lows:

1. Start with the Depth turned up full (5:00) with the EQ set flat on your bass amp and/or PA.
2. Set the Bass control to full boost.
3. Play the bass and back off the Depth (counter-clockwise) until you hear the sound tighten up, usually between 9:00 and 12:00.
4. Re-set the Bass slider to taste.

Phase Switch

Use the Phase switch hand in hand with the Depth control to suppress feedback for upright bass and acoustic bass guitar.

Electric bassists (solid body) can ignore this section—just leave the Phase switch in either position and go!

Unlike electric bass, acoustic bass tends to feed back when you amplify it at high volumes.

Feedback generally occurs in two different ranges: deep-bass feedback (open D and below) and mid-bass feedback (above open G).

Fighting Feedback

1. Start with the Phase switch in the left position and the Depth control at 5:00.
2. Turn your amp or PA up so that it is on the verge of feedback.
3. Flip the Phase switch back and forth until you find the position that sounds good and doesn't feed back from open G and above (mid-bass feedback).
4. Turn up the amp some more until you get feedback around open D and below (deep-bass feedback).
5. Move the Depth control counter-clockwise until deep bass feedback goes away. (usually between 9:00 and 10:00).

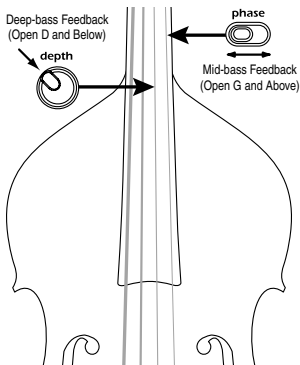

Tone Controls

Bass - We carefully voiced this control to give you the deep bass you need for your lowest notes, with plenty of mid-bass punch for the D and G strings. If the sound becomes boomy when you raise the Bass control, lower the Depth control until the sound tightens up.

Low-mid - Boost here to thicken up the low end. Cut low mids for a more transparent tone or to reduce feedback with acoustic bass.

Mid - This control subtly affects how well the instrument blends in or stands out in the mix.

Hi mid - This control zeroes in on click, fret buzz and string handling sounds produced by your fingertips.

Treble - The Platinum Bass' circuitry ensures smooth and sweet treble. Cut treble for a vintage "flatwound" sound.

Output (1/4" unbalanced)

Signal Path: Bass signal ⇒ Input Gain ⇒ Depth ⇒ EQ ⇒ Compression ⇒ Volume ⇒ Phase Switch ⇒ Output
Plug a standard instrument cable from the Platinum Bass output to your bass amp or an unbalanced input on a mixer.

XLR (balanced) Out

Plug a standard mic cable from the XLR out into a PA or recording console.

Note that the Platinum Bass can be powered by a 48V phantom supply through this output.

(See Power Options on page 4)

XLR Pre/Post Switch

Choose between a true D.I. (pre EQ) or an affected XLR output (post EQ).

1. XLR Post

Signal Path: Bass Signal ⇨ Input Gain ⇨ Depth ⇨ EQ ⇨ Compression ⇨ Volume ⇨ Phase Switch ⇨ XLR Out

Post is useful in live venues (especially if you are mixing from onstage) where you want your personal “dialed-in” sound to come through the PA.

2. XLR Pre

Signal Path: Bass Signal ⇨ Input Buffer ⇨ Phase Switch ⇨ XLR Out

You’ll find that this true direct or “DI” output produces a warm and uncluttered signal that is exceptional for recording. Set the Pre/Post switch to the Pre position when you want a “flat” DI signal going to the board and you wish to leave it to the sound-person or recording engineer to dial up the bass tone from the console.

XLR Ground Lift

Use this switch to eliminate AC ground loop hum. When you use the XLR and one of the other outputs together and you hear hum from the speakers, put the switch in the Lift position and the hum should go away. If you use all three outputs (XLR, 1/4” output and tuner/send) to three separate AC powered devices, the “lift” position may not completely eliminate ground loop hum.

Note: When you use only the XLR out, leave the Gnd/Lift switch in the “gnd” position. In these cases, if you move the switch to the “lift” position, you will hear a “pop” through your speakers and phantom power to the unit may be compromised.

Tuner/Send

Signal Path: Bass Signal ⇨ Input Buffer ⇨ Tuner/Send

Use the tuner/send output when you need an unbalanced direct signal that is not affected by any of the front panel controls. Use it for an external tuner or as an aux send to a stage amp or a second mixer for broadcast/live recording.

Sample EQ Settings

Here are a few suggested settings for the Pro-EQ Platinum Bass:

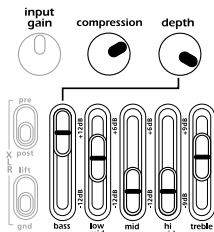

Dub/Reggae

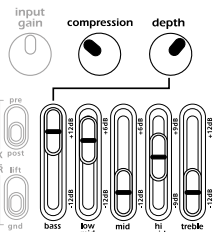

Tumbao

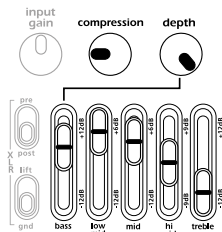

Fretless Jazz

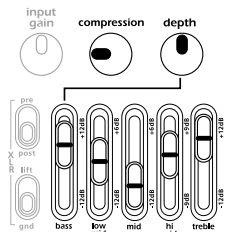

Classic Thumb-style

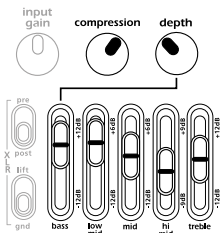

Studio Acoustic

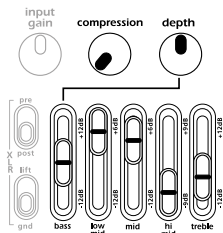

Motown

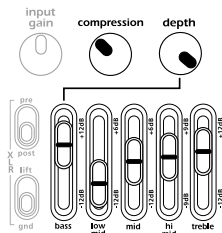

Five String

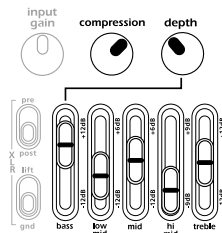

Fishman BP-100-pizz/arco

Stage Setups

1. Set the XLR Pre/Post switch to "post" when you want your personal "dialed in" sound to come through the PA.

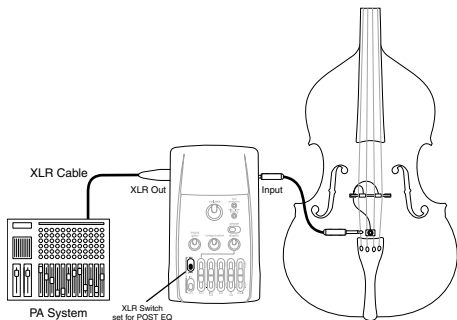

2. Plug into a bass amp. Start with the amp's tone controls set flat. Primary equalization is performed by the Platinum Bass EQ.

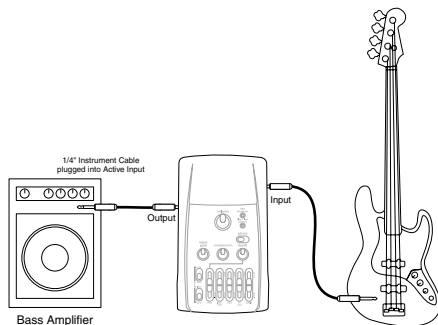

- 2a. Alternate into bass amp (especially for upright)

For a cleaner and less colored sound, try bypassing the preamp in your bass amp and plug the output from the Platinum Bass directly into the effects return or the power amp input at the back of your amp.

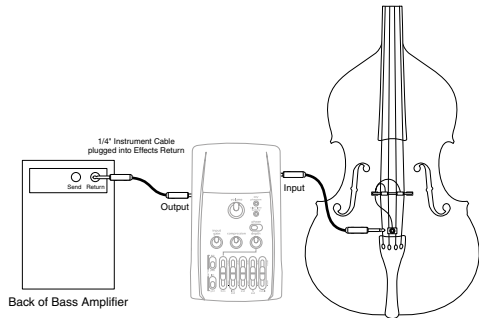

3. Splitter/ "Transparent" DI:
If you wish, you may bypass all the Platinum's controls for a true buffered DI into both the PA and a bass amp.

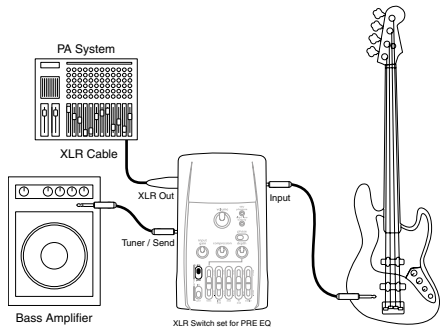

Block Diagram

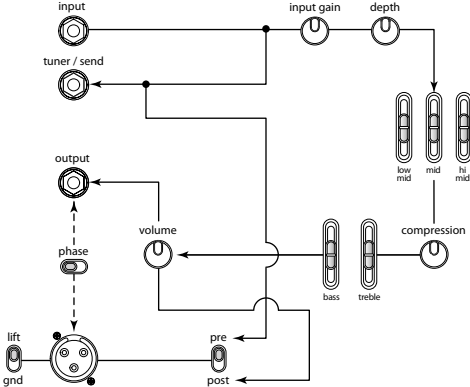

Specifications

Nominal Input Level:	-14dBu
Input Overload Level:	+10dBu
Input Impedance:	10M Ω

Nominal Output Levels and Impedances

Amp Out::	-20dBu to +10dBu (1k Ω)
Tuner/Send Out:	-14dBu to +10dBu (1k Ω)
XLR Out :	-30dBu to -6dBu (600 Ω)

Tone Controls

Bass:	± 12 dB @ 30Hz
Low mid:	+6dB, -12dB @ 200Hz
Mid:	+6dB, -12dB @ 1.25kHz
Hi Mid:	± 9 dB @ 5kHz
Treble:	± 12 dB @ 10kHz

All tone controls within ± 1 dB of nominal.

Depth Control:	12dB/octave low cut filter
Range:	15Hz (5:00) to 125Hz (7:00)
Compressor	max gain reduction: -14dB
THD @ 1kHz:	Less than .05%, -14dBu input level
A weighted S/N:	-89dBu (-91dBV)
Noise:	27 μ V (A weighted)

Power Options

9 Volt Alkaline Battery:	(Battery life est. 80+ hours continuous) Current draw: 4.5mA typical Low Battery light comes on when approx 4 hours of battery life remain
--------------------------	--

OR

48 Volt phantom power via XLR cable

OR

Fishman 910 AC adapter (center negative)

Technical support, troubleshooting tips and other product information can be found at www.fishman.com/support/

FISHMAN

www.fishman.com