

PX-410R PX-575R

USER'S GUIDE

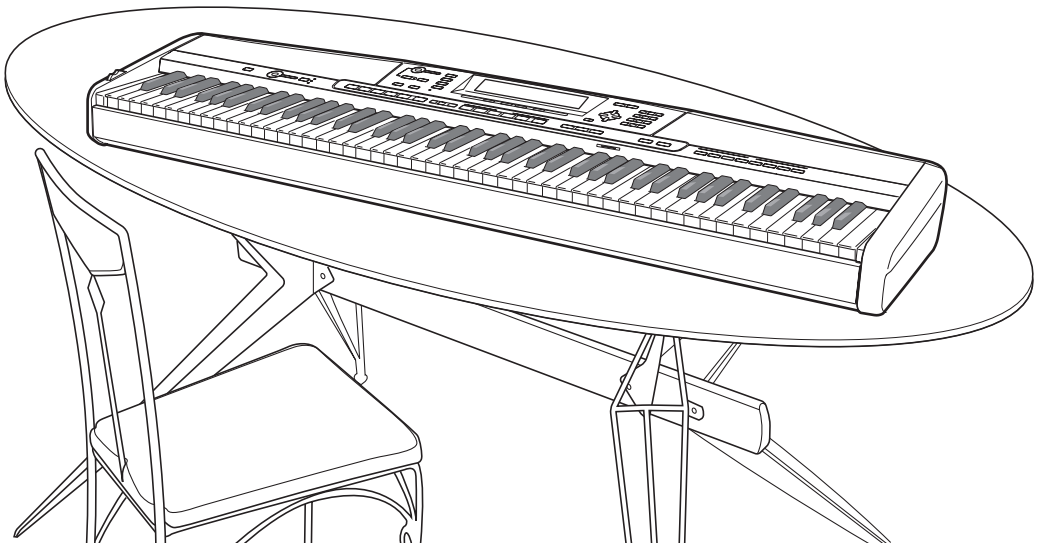

IMPORTANT SAFETY INSTRUCTIONS

1. Read these instructions.
2. Keep these instructions.
3. Heed all warnings.
4. Follow all instructions.
5. Do not use this apparatus near water.
6. Clean only with dry cloth.
7. Do not block any ventilation openings. Install in accordance with the manufacturer's instructions.
8. Do not install near any heat sources such as radiators, heat registers, stoves, or other apparatus (including amplifiers) that produce heat.
9. Do not defeat the safety purpose of the polarized or grounding-type plug. A polarized plug has two blades with one wider than the other. A grounding type plug has two blades and a third grounding prong. The wide blade or the third prong are provided for your safety. If the provided plug does not fit into your outlet, consult an electrician for replacement of the obsolete outlet.
10. Protect the power cord from being walked on or pinched particularly at plugs, convenience receptacles, and the point where they exit from the apparatus.
11. Only use attachments/accessories specified by the manufacturer.
12. Use only with the cart, stand, tripod, bracket, or table specified by the manufacturer, or sold with the apparatus. When a cart is used, use caution when moving the cart/apparatus combination to avoid injury from tip-over.



13. Unplug this apparatus during lightning storms or when unused for long periods of time.
14. Refer all servicing to qualified service personnel. Servicing is required when the apparatus has been damaged in any way, such as power-supply cord or plug is damaged, liquid has been spilled or objects have fallen into the apparatus, the apparatus has been exposed to rain or moisture, does not operate normally, or has been dropped.

The apparatus shall not be exposed to dripping or splashing and that no objects filled with liquids, such as vases, shall be placed on the apparatus.

GUIDELINES LAID DOWN BY FCC RULES FOR USE OF THE UNIT IN THE U.S.A. (not applicable to other areas).

NOTICE

This equipment has been tested and found to comply with the limits for a Class B digital device, pursuant to Part 15 of the FCC Rules. These limits are designed to provide reasonable protection against harmful interference in a residential installation. This equipment generates, uses and can radiate radio frequency energy and, if not installed and used in accordance with the instructions, may cause harmful interference to radio communications. However, there is no guarantee that interference will not occur in a particular installation. If this equipment does cause harmful interference to radio or television reception, which can be determined by turning the equipment off and on, the user is encouraged to try to correct the interference by one or more of the following measures:

- Reorient or relocate the receiving antenna.
- Increase the separation between the equipment and receiver.
- Connect the equipment into an outlet on a circuit different from that to which the receiver is connected.
- Consult the dealer or an experienced radio/TV technician for help.

FCC WARNING

Changes or modifications not expressly approved by the party responsible for compliance could void the user's authority to operate the equipment.

Declaration of Conformity

Model Number: PX-410R/PX-575R
Trade Name: CASIO COMPUTER CO., LTD.
Responsible party: CASIO, INC.
Address: 570 MT. PLEASANT AVENUE, DOVER, NEW JERSEY 07801
Telephone number: 973-361-5400

This device complies with Part 15 of the FCC Rules, Operation is subject to the following two conditions:

- (1) This device may not cause harmful interference, and (2) this device must accept any interference received, including interference that may cause undesired operation.

IMPORTANT!

Please note the following important information before using this product.

- Before using the AD-12 Adaptor to power the unit, be sure to check the AC Adaptor for any damage first. Carefully check the power cord for breakage, cuts, exposed wire and other serious damage. Never let children use an AC adaptor that is seriously damaged.
- The product is not intended for children under 3 years.
- Use only CASIO AD-12 adaptor.
- The AC adaptor is not a toy.
- Be sure to disconnect the AC adaptor before cleaning the product.



This mark applies in EU countries only.



CASIO Europe GmbH
Bornbarch 10, 22848 Norderstedt, Germany

Safety Precautions

Congratulations on your selection of the CASIO electronic musical instrument.

- Before using the instrument, be sure to carefully read through the instructions contained in this manual.
- Be sure to keep all user documentation handy for future reference.

Symbols

Various symbols are used in this user's guide and on the product itself to ensure that the product is used safely and correctly, and to prevent injury to the user and other persons as well as damage to property. Those symbols along with their meanings are shown below.

DANGER

This symbol indicates information that, if ignored or applied incorrectly, creates the danger of death or serious personal injury.

WARNING

This indication stipulates matters that have the risk of causing death or serious injury if the product is operated incorrectly while ignoring this indication.

CAUTION

This indication stipulates matters that have the risk of causing injury as well as matters for which there is the likelihood of occurrence of physical damage only if the product is operated incorrectly while ignoring this indication.

Symbol Examples



This triangle symbol (\triangle) means that the user should be careful. (The example at left indicates electrical shock caution.)



This circle with a line through it (\odot) means that the indicated action must not be performed. Indications within or nearby this symbol are specifically prohibited. (The example at left indicates that disassembly is prohibited.)



The black dot (\bullet) means that the indicated action must be performed. Indications within this symbol are actions that are specifically instructed to be performed. (The example at left indicates that the power plug must be unplugged from the electrical socket.)

WARNING

Smoke, Strange Odor, Overheating

Continued use of the product while it is emitting smoke, a strange odor, or heat creates the risk of fire and electric shock. Take the following steps immediately.

1. Turn off power.
2. If you are using the AC adaptor for power, unplug it from the wall outlet.
3. Contact your original retailer or an authorized CASIO Service Provider.

AC Adaptor

● Misuse of the AC adaptor creates the risk of fire and electric shock. Always make sure you observe the following precautions.

- Be sure to use only the AC adaptor that is specified for this product.
- Use only a power source whose voltage is within the rating marked on the AC adaptor.
- Do not overload electrical outlets and extension cords.

● Misuse of the AC adaptor's electric cord can damage or break it, creating the risk of fire and electric shock. Always make sure you observe the following precautions.

- Never place heavy objects on the cord or subject it to heat.
- Never try to modify the cord or subject it to excessive bending.
- Never twist or stretch the cord.
- Should the electric cord or plug become damaged, contact your original retailer or authorized CASIO Service Provider.

● Never touch the AC adaptor while your hands are wet.

Doing so creates the risk of electric shock.

● Use the AC adaptor where it will not be splashed with water. Water creates the risk of fire and electric shock.

● Do not place a vase or any other container filled with liquid on top of the AC adaptor. Water creates the risk of fire and electric shock.

Do not incinerate the product.

Never throw the product into fire. Doing so can cause it to explode, creating the risk of fire and personal injury.



Water and Foreign Matter

Water, other liquids, and foreign matter (such as pieces of metal) getting into the product create the risk of fire and electric shock. Take the following steps immediately.



1. Turn off power.
2. If you are using the AC adaptor for power, unplug it from the wall outlet.
3. Contact your original retailer or an authorized CASIO Service Provider.

Disassembly and Modification

Never try to take this product apart or modify it in any way. Doing so creates the risk of electric shock, burn injury, or other personal injury. Leave all internal inspection, adjustment, and maintenance up to your original retailer or authorized CASIO Service Provider.



Dropping and Impact

Continued use of this product after it has been damaged by dropping or subjecting it to strong impact creates the risk of fire and electric shock. Take the following steps immediately.



1. Turn off power.
2. If you are using the AC adaptor for power, unplug it from the wall outlet.
3. Contact your original retailer or an authorized CASIO Service Provider.

Plastic Bags

Never place the plastic bag the product comes in over your head or in your mouth. Doing so creates the risk of suffocation. Particular care concerning this precaution is required where small children are present.



Never climb onto the product or stand.*1

Never climb onto the product or hang from its edges. Doing so can cause the product to fall over, creating the risk of personal injury. Special care concerning this point is required in households where there are small children.





Do not locate the product on an unstable surface.

Never locate the product on a surface that is wobbly, tilted, or otherwise unstable*2. An unstable surface can cause the product to fall over, creating the risk of personal injury.



Always make sure you secure the product to the stand with the screws that are provided. An unsecured product can fall from the stand, creating the risk of personal injury.



CAUTION

AC Adaptor

● Misuse of the AC adaptor creates the risk of fire and electric shock. Always make sure you observe the following precautions.

- Do not locate the electric cord near a stove or other sources of heat.
- Never pull on the cord when unplugging from the electrical outlet. Always grasp the AC adaptor when unplugging.



● Misuse of the AC adaptor creates the risk of fire and electric shock. Always make sure you observe the following precautions.

- Insert the AC adaptor into the wall outlet as far as it will go.
- Unplug the AC adaptor from the wall outlet during lightening storms or before leaving on a trip or other long-term absence.
- At least once a year, unplug the AC adaptor from the wall outlet and wipe away any dust that is built up in the area around the prongs of the plug.



Relocating the Product

Before relocating the product, always unplug the AC adaptor from the wall outlet and disconnect all other cables and connecting cords. Leaving cords connected creates the risk of damage to the cords, fire, and electric shock.



Cleaning

Before cleaning the product, always unplug the AC adaptor from the wall outlet first. Leaving the AC adaptor plugged in creates the risk of damage to the AC adaptor, fire, and electric shock.



Connectors

Connect only the specified devices and equipment to the product's connectors. Connection of a non-specified device or equipment creates the risk of fire and electric shock.



Location

Avoid the following locations for this product. Such locations create the risk of fire and electric shock.

- Areas subject to high humidity or large amounts of dust.
- In food preparation areas or other areas subject to oil smoke.
- Near air conditioning equipment, on a heated carpet, in areas exposed to direct sunlight, inside of a vehicle parked in the sun, or any other area that subjects the product to high temperatures.



Display Screen

- Never push on the display screen's LCD panel or subject it to strong impact. Doing so can cause the LCD panel's glass to crack, creating the risk of personal injury.
- Should the LCD panel ever crack or break, never touch the liquid inside of the panel. LCD panel liquid can cause skin irritation.
- Should LCD panel liquid ever get inside your mouth, immediately wash out your mouth with water and contact your physician.
- Should LCD panel liquid ever get into your eyes or onto your skin, rinse with clear water for at least 15 minutes, and then contact a physician.



Sound Volume

Do not listen to music at very loud volumes for long periods. Particular care concerning this precaution is required when using headphones. High volume settings can damage your hearing.



Heavy Objects

Never place heavy object on top of the product. Doing so can make the product top heavy, causing the product to tip over or the object to fall from it, creating the risk of personal injury.



Correct Stand*1 Assembly

Failure to do so can cause the stand to fall over and the digital piano to fall from the stand, creating the risk of personal injury. Make sure you assemble the stand in accordance with the instructions that come with it, and ensure that all connections are secure. Also make sure that you choose an appropriate location for the stand.



- When placing the digital piano onto the stand, take care that you do not pinch your fingers between the digital piano and the stand.
- At least two people should lift the digital piano when placing it onto the stand or moving it. Trying to move the digital piano alone can cause the stand to fall over, creating the risk of personal injury.
- Do not drag the stand or tilt it forward or back when placing the digital piano onto the stand or moving it. Doing so can cause the digital piano to fall over, creating the risk of personal injury.
- Periodically check the screws that secure the digital piano to the stand for looseness. If a screw is loose, retighten it. Loose screws can cause the stand to tip over and the digital piano to fall, creating the risk of personal injury.

*1 Stand is available as an option.

*2 Avoid areas where there are multiple layers of carpeting, and where cables are running under the product.



Introduction

Congratulations upon your selection of this CASIO musical instrument. This digital piano provides you with the following features and functions.

❑ **620 Tones Include Rich Advanced Tones**

A total of 400 Advanced Tones are programmed with DSP tones to make them richer and more powerful. Advanced tones like Stereo Piano and Tremolo Electric Piano enhance the Piano and Electric Piano tones to create a totally new sound.

❑ **50 Drawbar Organ Tones**

In addition to the 620 standards tones, the digital piano also includes 50 realistic drawbar organ tones. Drawbar organ tones can be controlled using nine digital drawbars. You can also select percussion or key click, and even edit the parameters of preset tone and save up to 100 original tones in user tone memory.

❑ **Flash Memory**

Built-in Flash memory lets you expand your selection of tones and rhythms by downloading data from the CASIO MUSIC SITE, or by the CD-ROM that comes bundled with the digital piano. You can also store up to 200 SMF format music files for playback.

❑ **PIANO SETTING Button**

The press of a button optimizes the keyboard setup for piano play.

❑ **166 Preset Rhythms + 16 User Rhythms**

A selection of 166 rhythms includes accompaniments for everything from rock to pops and jazz.

You can also transfer accompaniment data from your computer and store up to 16 of them as user rhythms in digital piano memory.

❑ **Auto Accompaniment**

Simply play a chord and the corresponding rhythm, bass and chord parts play automatically. One-touch Preset instantly recalls the most suitable tone and tempo settings to match the rhythm you are using.

❑ **Big, Information-packed Display**

A big built-in display shows chord names, tempo setting, keyboard information, staff notation of notes played, and more for full support of all your keyboard play. A built-in backlight keeps the display easy to read, even in total darkness.

❑ **Song Memory**

Record up to six parts in memory, along with their tone, volume, pan position, and other parameters for later playback. Realistic ensemble play can also be created using the Auto Accompaniment function.

❑ **Synthesizer Mode**

Edit built-in sounds to produce your own original creations. Up to 120 of your own sounds can be stored in memory for recall, just like the built-in tones.

❑ **General MIDI compatibility**

The General MIDI tones of this digital piano let you connect to a personal computer to enjoy “desktop music” capabilities. This digital piano can be used as a desktop music input device or sound source, and it's just the thing for playback of commercially available pre-recorded General MIDI music software.

❑ **Powerful effects**

A collection of powerful effects, such as DSP, reverb, chorus, and more, give you total control over the type of sound you want. You can even change the parameters of an effect to create your own, original effects. A 4-band equalizer is also included.

□ USB port

A USB port provides quick and easy connection to a computer.*

* Note that you will need a commercially available USB cable (A-B type) to connect to a computer using the USB port.

□ Mixer

You can specify tone, volume, pan position, and other parameters for each built-in Auto Accompaniment part. You can also control the same parameters for each channel during MIDI input.

□ Registration Memory

Digital piano setups can be stored in memory for later recall and instant settings whenever you need them. Up to 32 setups (4 setups × 8 banks) can be stored in registration memory.

□ Data download from your computer (Internet Data Expansion System)

You can use your computer to download data from the CASIO MUSIC SITE.

□ SD Memory Card Slot

A built-in SD memory card slot helps to simplify transfer of data from a computer and lets you store volumes of data for later recall when you need it. You can also load a card with a standard MIDI file (SMF) and play it back on the digital piano.

Using the Separate Appendix

Whenever you see the symbol **Appendix** in this manual, it means you should refer to the separate Appendix.

The letters **A** through **H** indicate the section of the Appendix to which you should refer.

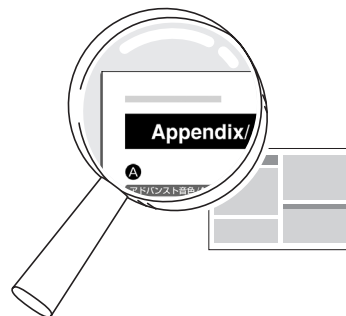



Contents

Safety Precautions E-1

Introduction E-5

General Guide E-10

Attaching the Score Stand E-11

Playing a Demo Tune E-12

Power Supply E-14

Using the AC Adaptor E-14

Turning Off the Digital Piano E-14

Memory Contents E-14

Connections E-16

Connecting Headphones E-16

Connecting to a PEDAL Jack E-16

Using the Microphone Input Jack E-17

Basic Operations E-18

Getting Ready E-18

Selecting a Tone by Tone Name E-18

Selecting a Tone by Tone Number E-18

PIANO SETTING Button E-20

Using the PITCH BEND Wheel E-20

Using the Drawbar Organ

Mode E-21

To select a drawbar organ tone E-22

To edit a drawbar organ tone E-22

Parameter Details E-23

To save an edited drawbar organ tone ... E-24

Applying Effects to Tones E-25

Effect Blocks E-25

Selecting a DSP Type E-26

About the DSP Button E-27

Selecting REVERB E-27

Selecting CHORUS E-28

Using the Equalizer E-29

Auto Accompaniment E-30

About the MODE Button E-30

Selecting a Rhythm E-30

Playing a Rhythm E-31

Adjusting the Tempo E-31

Using Auto Accompaniment E-31

Using an Intro Pattern E-34

Using a Fill-in Pattern E-34

Using a Rhythm Variation E-35

Synchro Starting Accompaniment with
Rhythm Play E-35

Finishing with an Ending Pattern E-35

Using One-touch Preset E-36

Using Auto Harmonize E-36



Adjusting the Accompaniment Volume ... E-37
Using the Metronome E-38

Mixer Function E-39

What you can do with the Mixer E-39
Turning Channels On and Off E-39
Using the Parameter Edit Mode E-40
How Parameters Work E-41

Synthesizer Mode E-43

Synthesizer Mode Functions E-43
Creating a User Tone E-46
Storing a User Tone In Memory E-48

Registration Memory E-49

Registration Memory Features E-49
To Save a Setup in Registration
Memory E-50
To Recall a Setup from Registration
Memory E-50

Song Memory Function E-51

Tracks E-51
Basic Song Memory operations E-51
Using Real-time Recording E-52
Playing Back from Song Memory E-54
Recording Melody and Chords with
Step Recording E-54
Recording Multiple Tracks E-57

Correcting Mistakes While
Step Recording E-59
Editing Memory Contents E-60
Editing a Song E-62

Digital Piano Settings E-63

Using Layer E-63
Using Split E-64
Using Layer and Split Together E-65
Transposing the Digital Piano E-66
Using Touch Response E-66
Tuning the Digital Piano E-67
Changing Other Settings E-68

Using the SMF Player E-72

Playing Back an SMF E-74
Configuring Other Settings E-75

**Connection to a
Computer E-77**

General MIDI E-78
MIDI Settings E-78
Internet Data Expansion System E-79

***Saving Data E-80***

Using an SD Memory Card	E-81
Basic Memory Card Operation	E-82
Saving Files	E-83
Loading a File	E-84
Renaming a File	E-85
Deleting a File	E-86
Formatting an SD Memory Card	E-86
Inputting Characters	E-87
SD Memory Card Error Messages	E-88

Troubleshooting E-89***Specifications E-92******Care of your Instrument E-95******MIDI messages that can be sent
and received using the USB port***

Company and product names used in this manual may be registered trademarks of others.

General Guide

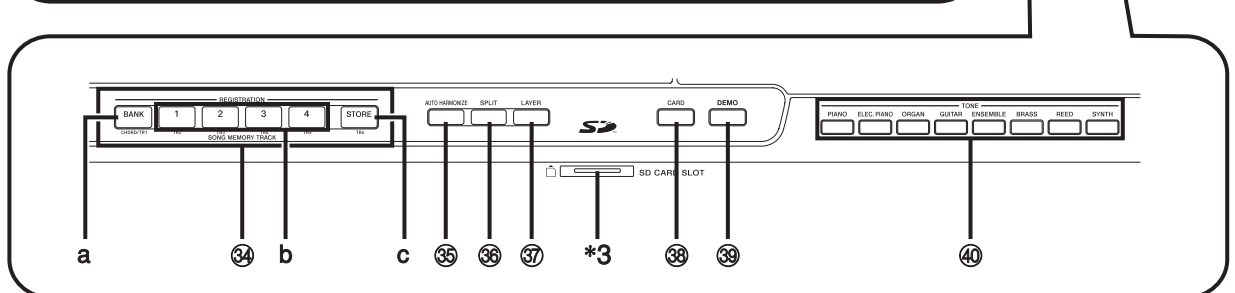
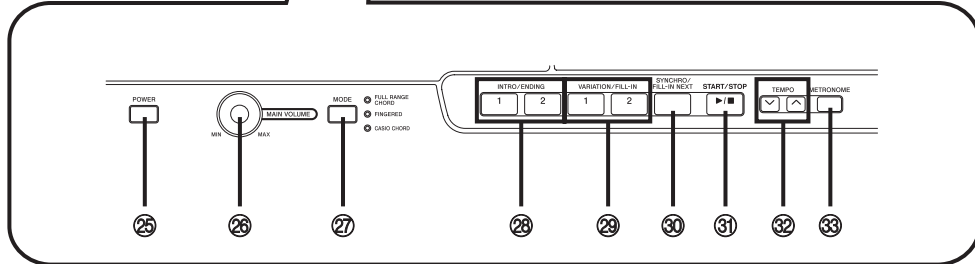
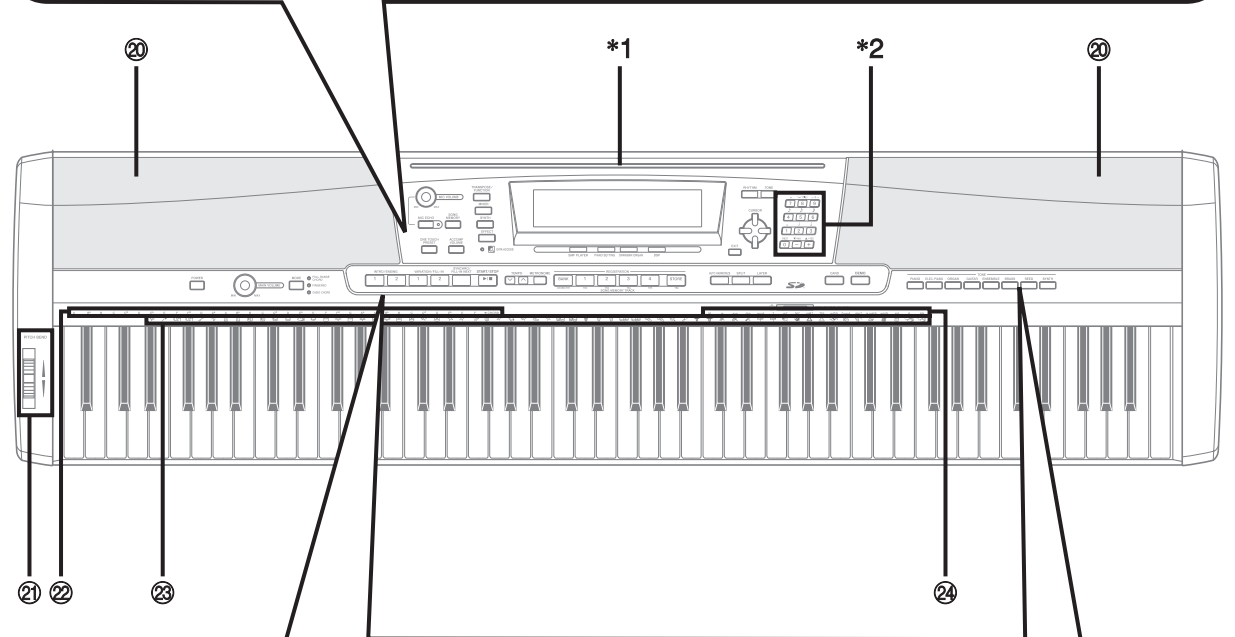
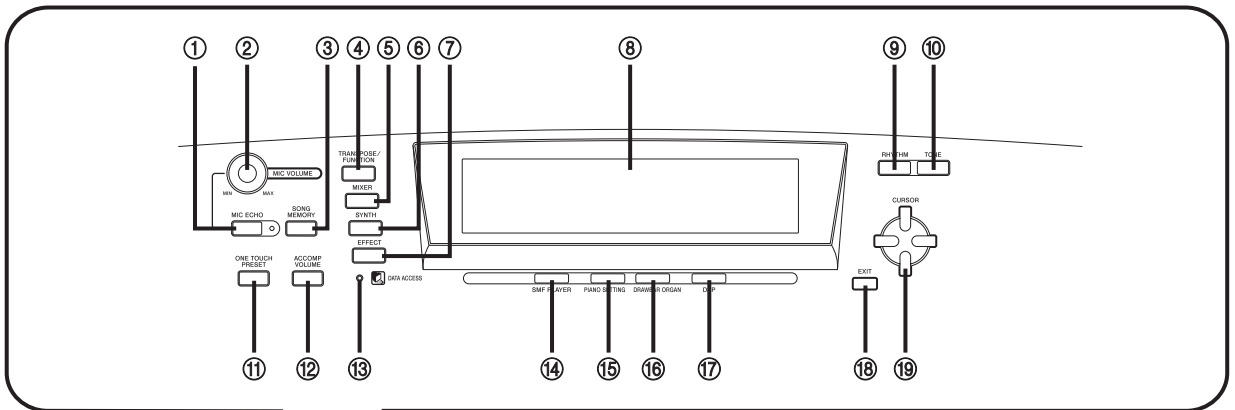

NOTE

- This digital piano has two different types of tone buttons: a TONE button next to the RHYTHM button for selecting a tone by tone number, and eight TONE name buttons for selecting a tone by tone name. In this manual, the TONE button next to the DEMO button is indicated as <TONE>.

- | | |
|----------------------------------|----------------------------------|
| ① MIC ECHO button | ②② CHORD root names |
| ② MIC VOLUME knob | ②③ Percussion instrument list |
| ③ SONG MEMORY button | ②④ Chord types name |
| ④ TRANSPOSE/FUNCTION button | ②⑤ POWER button |
| ⑤ MIXER button | ②⑥ MAIN VOLUME knob |
| ⑥ SYNTH button | ②⑦ MODE button |
| ⑦ EFFECT button | ②⑧ INTRO/ENDING 1/2 buttons |
| ⑧ Display | ②⑨ VARIATION/FILL-IN 1/2 buttons |
| ⑨ RHYTHM button | ③⑩ SYNCHRO/FILL-IN NEXT button |
| ⑩ TONE button | ③⑪ START/STOP button |
| ⑪ ONE TOUCH PRESET button | ③⑫ TEMPO buttons |
| ⑫ ACCOMP VOLUME button | ③⑬ METRONOME button |
| ⑬ DATA ACCESS lamp | ③⑭ SONG MEMORY TRACK buttons |
| ⑭ SMF PLAYER button | a) BANK button |
| ⑮ PIANO SETTING button | b) REGISTRATION buttons |
| ⑯ DRAWBAR ORGAN button | c) STORE button |
| ⑰ DSP button | ③⑮ AUTO HARMONIZE button |
| ⑱ EXIT button | ③⑯ SPLIT button |
| ⑲ [▲]/[▼]/[◀]/[▶] CURSOR buttons | ③⑰ LAYER button |
| ⑳ Speaker | ③⑱ CARD button |
| ㉑ PITCH BEND wheel | ③⑲ DEMO button*4 |
| | ④⑰ <TONE> buttons |

***1: Attaching the Score Stand**

Insert the score stand into the slot at the top of the digital piano as shown in the illustration.

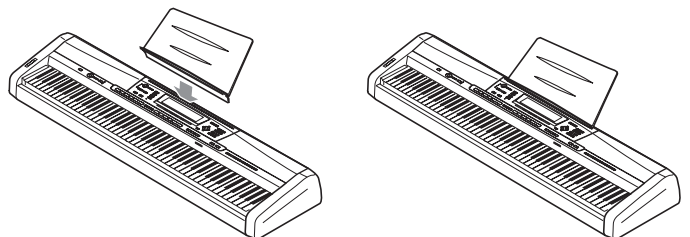

*2

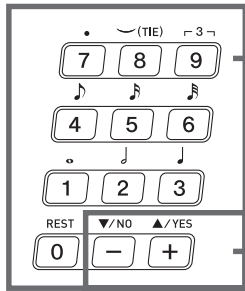

④① Number buttons

④② [+]/[-] buttons
(YES/NO)

- For input of numbers to change displayed settings.
- Negative values can be changed only by using [+] and [-] to increment and decrement the displayed value.

*3

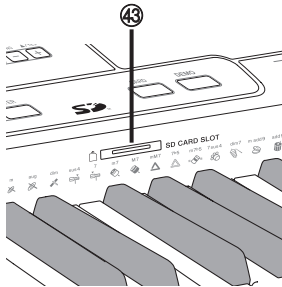

④③ SD memory card slot

*4: Playing a Demo Tune

Pressing the DEMO button starts demo tune play. There are 3 demo tunes, which continuously play in sequence. To stop demo tune play, press either the DEMO button or the START/STOP button.

NOTE

- Pressing the [+]/[-] buttons skips to the next demo tune.
- The PIANO SETTING button, Layer, and Split are disabled while a demo tune is playing.

Left Side Panel

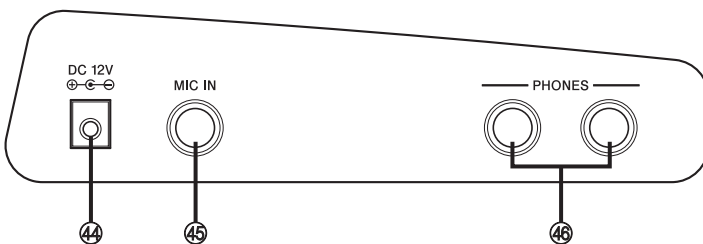

④④ DC 12V jack

④⑤ MIC IN jack

④⑥ PHONES jacks



Bottom

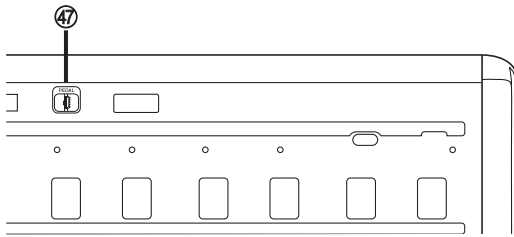

④⑦ PEDAL connector

Rear Panel

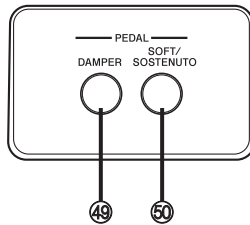
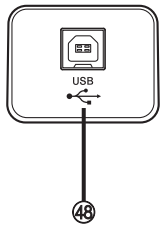

④⑧ USB port

④⑨ DAMPER PEDAL jack

④⑩ SOFT/SOSTENUTO PEDAL jack

NOTE

- Display examples shown in this User's Guide are intended for illustrative purposes only. The actual text and values that appear on the display may differ from the examples shown in this User's Guide.
- Due to LCD element characteristics, display contrast changes depending on the angle from which you view it. The initial default contrast setting is one that allows easy viewing for a musician seated directly in front of the display. You can also adjust the contrast to the level that suits your particular needs. For more information, see page E-71.

Power Supply

You can power this digital piano by plugging it into a standard household power outlet.

Be sure you turn off power and unplug the power cord from the electrical outlet whenever the digital piano is not in use.

Using the AC Adaptor

Make sure that you use only the AC adaptor specified for this digital piano.

Specified AC Adaptor: AD-12

[Left Side Panel]

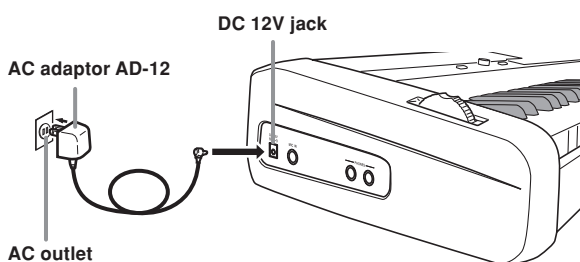

Note the following important precautions to avoid damage to the power cord.

● During Use

- Never pull on the cord with excessive force.
- Never repeatedly pull on the cord.
- Never twist the cord at the base of the plug or connector.
- The power cord should not be stretched tight while it is in use.

● During Movement

- Before moving the digital piano, be sure to unplug the AC adaptor from the power outlet.

● During Storage

- Loop and bundle the power cord, but never wind it around the AC adaptor.

IMPORTANT!

- Make sure that the digital piano is turned off before connecting or disconnecting the AC adaptor.
- Using the AC adaptor for a long time can cause it to become warm to the touch. This is normal and does not indicate malfunction.

Turning Off the Digital Piano

- Be sure to press the POWER button to turn off power and make sure that the LCD backlight is off before disconnecting the AC adaptor or doing anything else.
- Never disconnect the AC adaptor while the digital piano is turned on or try to turn off power using any other technique besides pressing the POWER button. Doing so can cause the contents of the digital piano's Flash memory to become corrupted. Strange digital piano operation and abnormal startup when power is turned on are symptoms of corrupted Flash memory contents. See "Troubleshooting" on page E-89 for more information.

IMPORTANT!

- While the following message is on the display, never turn off the digital piano by pressing the POWER button, disconnecting the AC adaptor, etc.

(message) "Pls Wait" or "Bulk In"

Turning off the digital piano while the above message is on the display can cause user data (user tones, song memory data, etc.) currently stored in digital piano memory or on SD memory cards to become corrupted. Once corrupted, you may not be able to recall the data again.

Memory Contents

Settings

Tone, rhythm, and other "main digital piano settings" in effect when you turn off the digital piano manually by pressing POWER button are still in effect the next time you turn power back on.

Main Digital Piano Settings

Tone number, layer, split, split point, drawbar organ tone settings, transpose, tuning, and contrast settings, touch response, reverb, chorus, DSP, equalizer, rhythm number, tempo, keyboard channel, MIDI In Chord Judge on/off, accomp MIDI out on/off, soft/sostenuto pedal jack setting, accompaniment volume, user area tones (Synthesizer Mode), user area accompaniments, user DSP area, pitch bend range, Auto Harmonize on/off, Auto Harmonize type, Mixer hold, DSP hold, Auto Accompaniment mode, all Mixer parameters, all Synthesizer Mode parameters, Song Memory song numbers, SMF player settings (play mode, manual play part, SMF playback volume), microphone echo on/off



Memory Contents

In addition to the above settings, data stored in the Registration Mode and Song Memory Mode is also retained when digital piano power is turned off.

Saving Setups and Memory Contents

About Flash memory

Your digital piano comes with built-in Flash memory, which can continue to hold data even when electrical power is totally cut off. Flash memory retains data even when you unplug the AC adaptor, leaving the digital piano without power. You will be able to recall data after plugging the AC adaptor back in and turning on power.

- SD Memory Card
See “Using an SD Memory Card” on page E-81.
- Computer hard disk
See “Connection to a Computer” on page E-77.

Initializing the Digital Piano

Initialization can be used to return digital piano parameters to their initial factory default settings, or to delete all data currently in digital piano memory. See page E-71 for more information about initialization.

Returning the digital piano to its initial factory defaults

You can use the CD-ROM that comes with the digital piano and your computer to return the digital piano’s flash memory and all of its parameters to their initial factory default settings. See “Bundled CD-ROM Data” on page E-79 for details.

Connections

IMPORTANT!

- Whenever connecting external equipment, first set the MAIN VOLUME knob of the digital piano and the volume controller of the external equipment to relatively low volume settings. You can later adjust volume to the level you want after connections are complete.
- Be sure also to refer to the documentation that comes with the external equipment for its proper connection procedures.

Connecting Headphones

Connect commercially available headphones to the digital piano's PHONES jacks. This cuts off the built-in speakers, which means you can practice even late at night without disturbing others. To protect your hearing, make sure that you do not set the volume level too high when using headphones.

[Left Side Panel]

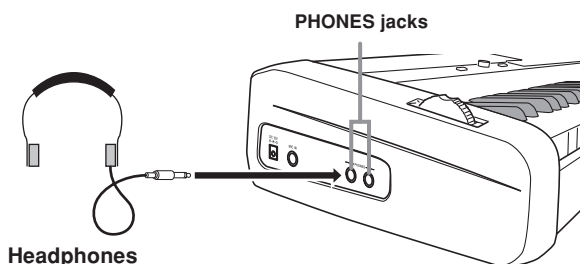

Connecting to a PEDAL Jack

Depending on the type of operation you want the pedal (SP-3) to perform, connect the pedal's cable to the digital piano's DAMPER PEDAL jack or SOFT/SOSTENUTO PEDAL jack. If you want to use both jacks at the same time, you need to purchase another optionally available pedal.

[Back Panel]

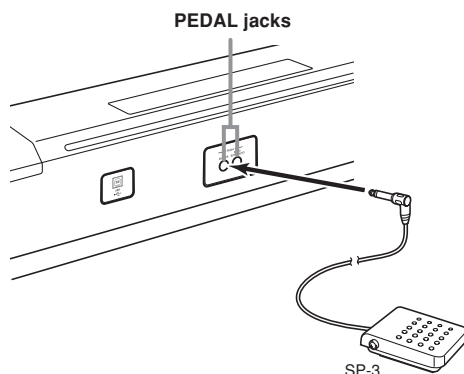

Pedal functions

• Damper Pedal

Pressing the damper pedal while playing will cause the notes you play to reverberate for a very long time. When your selected tone has the DSP 099 (Acoustic Resonance) effect applied, using this pedal causes note to reverberate just like the pedal on an acoustic grand piano.

• Soft Pedal

Pressing this pedal while playing weakens notes played on the keyboard after the pedal was pressed, and makes them sound softer.

• Sostenuto Pedal

Only the notes of the keys that are depressed when this pedal is pressed are sustained until the pedal is released.

Selecting the Pedal Function

A pedal connected to the piano's SOFT/SOSTENUTO PEDAL jack can operate as either a soft pedal or a sostenuto pedal. When you turn on the digital piano, the pedal is initially configured for soft pedal operation. For information about configuring settings, see "Changing Other Settings" on page E-68.

Adjusting the Effect Applied when the Damper Pedal is Pressed Half Way (With optional SP-30 only)

You can specify to what extent the damper effect should be applied when you press the damper pedal half way. For information about configuring settings, see "Changing Other Settings" on page E-68.

PEDAL connector

You can connect the optionally available Pedal Unit (SP-30) to the PEDAL connector. You can then use the pedals for expression that is similar to that available on an acoustic piano.

[Bottom]

PEDAL connector

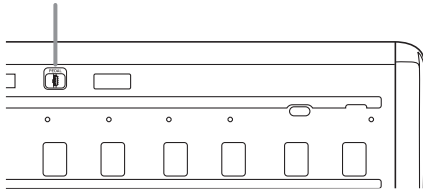

Using the Microphone Input Jack

You can use the MIC IN jack to connect a commercially available microphone and sing along as you play.

NOTE

- When connecting a microphone, be sure to first adjust the MIC VOLUME to a relatively low setting, and then adjust to the level you want after connecting.

- 1 Set the MIC VOLUME knob setting so it is on the "MIN" side.
- 2 Turn on the microphone's ON/OFF switch.
- 3 Use the MIC VOLUME knob to adjust microphone volume to the level you want.

[Left Side Panel]

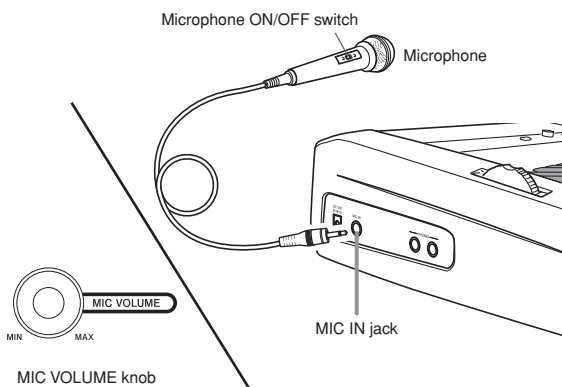

IMPORTANT!

- Be sure to use the microphone's ON/OFF switch to turn off the microphone and to disconnect the microphone from the digital piano whenever you are not using it.

Recommended Microphone Type

- Dynamic microphone (standard plug)

Howling (Feedback Noise)

Any of the following conditions can cause howling (feedback noise).

- Covering the head of the microphone with your hand
- Positioning the microphone too near to a speaker

Should howling occur, try grasping the microphone further away from the head, and move away from any nearby speaker.

Static Noise

Fluorescent lighting can cause static noise in the microphone signal. When this happens, move away from the lighting you suspect may be causing the static.

To turn on microphone echo

- 1 Press the MIC ECHO button to toggle echo on and off.
 - The MIC ECHO lamp turns on when microphone echo is turned on.

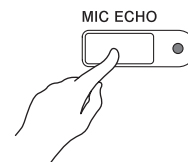

Accessories and Options

Use only the accessories and options specified for this digital piano. Use of non-authorized items creates the danger of fire, electrical shock, and personal injury.

Basic Operations

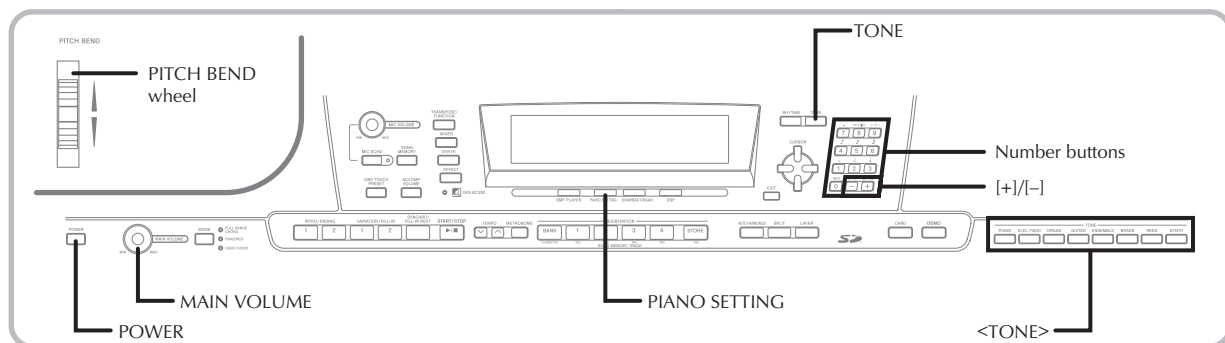

Getting Ready

- 1 Press the POWER button.
- 2 Use the MAIN VOLUME knob to adjust overall digital piano volume.
 - Before playing, it is a good idea to set the volume to a relatively low level.

Selecting a Tone by Tone Name

- 1 Press the <TONE> button for the type of tone you want to select.



Example: Press the ORGAN button to display the first tone in the organ tone group.

- 2 Try playing something on the keyboard.
 - This will play the tone whose name is on the display.
- 3 Use the [+] and [-] buttons to scroll through the tone names on the display.
 - See the separate "Appendix A" for the sequence that the tones appear when scrolled.

Selecting a Tone by Tone Number

You can input a three-digit number to specify any one of 744 different tones.

- See the separate "Appendix A" for a complete list of tones and their tone names.

"Advanced Tones" are variations of standard tones, which are created by programming in effects (DSP) and other settings.

For details about drawbar organ tones, see "Using the Drawbar Organ Mode" on page E-21.

Tone Types

Standard Tones: 620 Preset Tones + 124 User Tones

Number	Number of Tones	Tone Type	DSP Line On/Off*1
000 - 399	400	Advanced Tones	On
400 - 599	200	Preset Tones	Off
600 - 619	20	Drum Sets	Off
700 - 799	100	User Tones*2	On/Off*3
800 - 819	20	User Tones with Waves*4	On/Off*3
900 - 903	4	User Drum Sets with Waves*4	On/Off*5

Drawbar Organ Tones: 50 Preset Tones + 100 User Tones

Number	Number of Tones	Tone Type	DSP Line On/Off*1
000 - 049	50	Preset Tones	On/Off*5
100 - 199	100	User Tones*6	On/Off*3

- *1: See “Changing Tones and Configuring DSP Effect Settings” on page E-19.
- *2: Memory area for tones created by you. See “Synthesizer Mode” on page E-43. User tone areas 700 through 799 initially contain the same data as advanced tones 000 through 099.
- *3: Depends on source tone or user setting. See “Synthesizer Mode” on page E-43 for more information.
- *4: Area for data transferred from a computer. See “Internet Data Expansion System” on page E-79 for more information. For information about waveforms, see “Creating a User Tone” on page E-46.
- *5: Depends on tone. This status can be checked by viewing the DSP button. See “About the DSP Button” on page E-27 for more information.
- *6: Memory area for tones created by you. See “To edit a drawbar organ tone” on page E-22. User drawbar organ tone areas initially contain two sets of the same data as drawbar organ tones types 000 through 049.

NOTE

- You cannot select tone numbers not included in the above range (standard tones 620 through 699 and 820 through 899, and drawbar organ tones from 050 to 099). When you use the [+] and [-] buttons to scroll through tone numbers, scrolling jumps across the unused numbers. Pressing [+] when 619 is selected, for example, jumps to 700.

To select a tone

- 1 Find the tone you want to use in the tone list (the separate **Appendix A**) and note its tone number.
- 2 Press the TONE button.

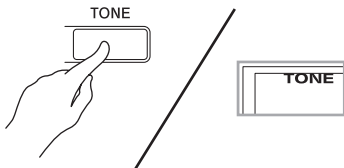

- 3 Use the number buttons to input the three digit tone number for the tone you want to select.
Example: To select “432 GM ACOUSTIC BASS”, input 4, 3 and then 2.



NOTE

- Always input all three digits for the tone number, including leading zeros (if any).
- You can also increment the displayed tone number by pressing [+] and decrement it by pressing [-].
- When one of the drum sets is selected (tone numbers 600 through 619), each keyboard key is assigned a different percussion sound. See the separate **Appendix B** for details.

Polyphony

The term polyphony refers to the maximum number of notes you can play at the same time. The digital piano has 32-note polyphony, which includes the notes you play as well as the rhythms and auto-accompaniment patterns that are played by the keyboard. This means that when a rhythm or auto-accompaniment pattern is being played by the digital piano, the number of notes (polyphony) available for keyboard play is reduced. Also note that some of the tones offer only 10-note polyphony.

Changing Tones and Configuring DSP Effect Settings

This digital piano has only a single DSP sound source. Because of this, selecting tones for which DSP is enabled for multiple parts when layering or splitting tones (pages E-63, 64) can cause conflicts. To avoid conflicts, DSP is allocated to the last DSP enabled tone, and DSP is disabled (DSP line OFF) for all other parts.

DSP line is a parameter that controls whether or not the currently selected DSP effect is applied to a part.* Each tone has a DSP line parameter. Selecting a tone for a part applies the tone’s DSP line parameter setting to all parts.

* The DSP line parameter is turned on (DSP effect is applied) for the 400 Advanced Tones numbered 000 through 399, and turned off (DSP effect not applied) for the 200 preset tones from 400 to 599. For information about other tones, see “Tone Types” on page E-18.

PIANO SETTING Button

Pressing this button changes the setup of the digital piano to optimize it for piano play.

Settings

Tone Number: "000"

Rhythm Number: "140"

Accompaniment Mode: Normal

Layer: Off

Split: Off

Auto Harmonize: Off

Transpose: 0

Touch Response:

Off: Returns to initial default

On: No change

Soft/sostenuto pedal jack setting: Soft

Local Control: On

Mixer Channel 1 Parameter Setup: Depends on tone

To optimize digital piano settings for piano play

- 1 Press the PIANO SETTING button.
- 2 Now try playing something on the keyboard.
 - The notes you play will sound with a piano tone.
 - If you want to play with rhythm accompaniment, press the START/STOP button. This causes a rhythm that is optimized for piano will start to play.
 - To stop rhythm play, press the START/STOP button again.

NOTE

- Pressing the PIANO SETTING button while a rhythm is playing stops rhythm play and then changes the digital piano setup.
- Pressing the PIANO SETTING button while the digital piano is in the Synthesizer Mode or other mode exits the current mode and then changes the digital piano setup.
- The setup of the digital piano does not change if you press the PIANO SETTING button when any one of the following exists.
 - * During real-time recording, step recording, or while using the editing function of the Song Memory
 - * While the data save or overwrite message is on the display
 - * During demo tune play

Using the PITCH BEND Wheel

As its name suggests, the PITCH BEND wheel lets you "bend" the pitch of a sound. This makes it possible to add a touch of realism to saxophone and other tones.

To use the PITCH BEND wheel

- 1 While holding down a keyboard key with your right hand, use your left hand to rotate the PITCH BEND wheel up and down.
 - Releasing the PITCH BEND wheel returns the note to its original pitch.

NOTE

- With saxophone and electrical guitar tones, the most realistic sounding effects can be produced if you play notes and operate the PITCH BEND wheel simultaneously.
- See "Pitch Bend Range (Initial Default: 12)" on page E-71 for changing the bend range of the PITCH BEND wheel.
- Never turn on digital piano power while the PITCH BEND wheel is rotated.

Using the Drawbar Organ Mode

Your digital piano has built-in “drawbar organ tones” that can be altered using nine digital drawbars whose operations are similar to the controls on a drawbar organ. You can also select percussion or key click. There is room in memory for storage of up to 100 user-created drawbar tone variations.

Drawbar Organ Mode Operational Flow

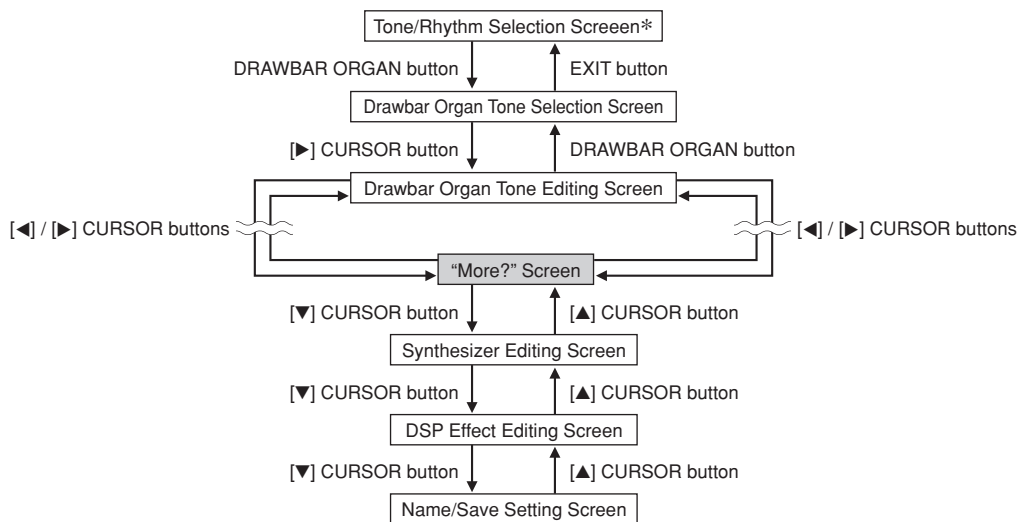

* You can also display the drawbar organ tone selection screen from the Song Memory Mode or SMF Playback Mode screen. In this case, however, the Drawbar Organ Tone Editing Screen does not appear.

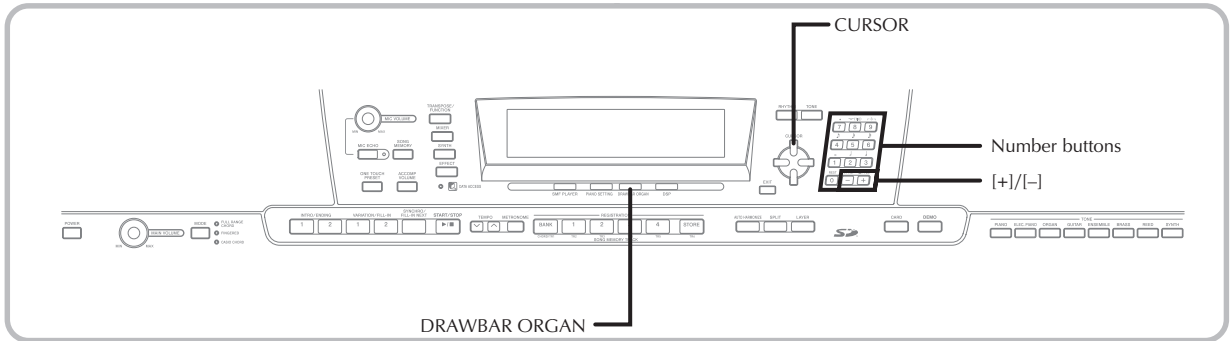

To select a drawbar organ tone

- 1 Find the drawbar organ tone you want to use in the tone list (the separate **Appendix A**) and note its tone number.
- 2 Press the DRAWBAR ORGAN button.
 - This causes the drawbar organ tone selection screen to appear.

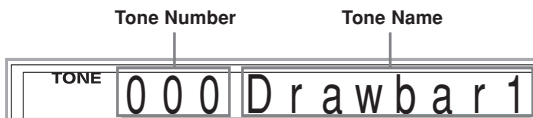

- 3 Use the number buttons to input the three digit tone number for the tone you want to select.

NOTE

- Always input all three digits for the tone number, including leading zeros (if any).
- You can also increment the displayed tone number by pressing [+] and decrement it by pressing [-].
- When using a drawbar organ tone, playing a note that is outside the range of the tone you are using, the digital piano automatically plays the same note in the nearest octave that falls within the playable range.

To edit a drawbar organ tone

- 1 Select the drawbar organ tone (000 to 049, 100 to 199) you want to edit.

- 2 Use the [◀] and [▶] CURSOR buttons to display the drawbar organ tone editing screen. Select the parameter whose setting you want to change.

Example: Selecting the “Ft16” parameter

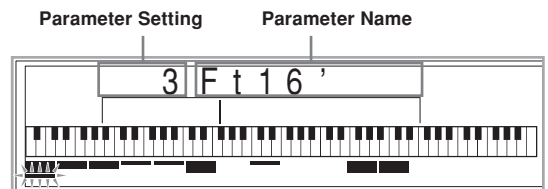

- There are a total of 13 parameters. You can use the [◀] and [▶] CURSOR buttons to cycle through them. See “Parameter Details” on page E-23 for more information.
 - While the “More?” screen is on the display, you can advance to the synthesizer and DSP effect editing screens by pressing the [▼] CURSOR button or the [+] button.
- 3 Use the [▲] and [▼] CURSOR buttons or the [+] and [-] buttons to change the setting of the currently displayed parameter.
 - You can also change a parameter setting by entering a value with the number buttons.
 - You can monitor the changes in a tone by playing notes on the keyboard as you adjust parameter settings.

NOTE

- Selecting a different tone after you edit parameters replaces parameter settings with those of the newly selected tone.
- If you have drawbar organ tones assigned to more than one channel, changing the drawbar organ setting for one of the channels causes the same setting to be applied to all of the other channels as well.
- See “To save an edited drawbar organ tone” on page E-24 for information about saving your edits.

Editing Synthesizer Mode Parameters and DSP Parameters of Drawbar Tones

As with standard (non-drawbar) tones, you can edit the Synthesizer Mode parameters and DSP parameters of drawbar organ tones. See “Drawbar Organ Mode Operational Flow” on page E-21.

- 1 Use the [◀] and [▶] CURSOR buttons to display “More?”, and then press the [▼] CURSOR button.
 - This enters the Synthesizer Mode, which is indicated by the indicator next to SYNTH on the display screen.
 - For the remainder of this procedure, perform the steps starting from step 3 under “Creating a User Tone” on page E-46.

Parameter Details

The following provides details about the parameters you can configure using the drawbar organ tone editing screen.

Drawbar Position

This parameter defines the position of each drawbar, and the volume of each overtone. The larger the value, the greater the corresponding overtone’s volume.

Parameter Name	Parameter Display Indication	Settings
Drawbar 16'	Ft 16'	0 to 3
Drawbar 5 1/3'	Ft 5 1/3'	0 to 3
Drawbar 8'	Ft 8'	0 to 3
Drawbar 4'	Ft 4'	0 to 3
Drawbar 2 2/3'	Ft 2 2/3'	0 to 3
Drawbar 2'	Ft 2'	0 to 3
Drawbar 1 3/5'	Ft 1 3/5'	0 to 3
Drawbar 1 1/3'	Ft 1 1/3'	0 to 3
Drawbar 1'	Ft 1'	0 to 3

(Ft: Feet)

Click

The parameter determines whether or not a key click is added when a sustained tone configured using the drawbars is played.

Parameter Name	Parameter Display Indication	Settings
Click	Click	Off On

Percussion

This parameter lets you add percussion sound, which provides modulation to sustained tones that you create. When you hold down a key on the keyboard, the sound produced decays until it is no longer audible. Pressing the key again sounds the note again at a louder volume. Percussion has “2nd Percussion” (2nd overtone pitch) and “3rd Percussion” (3rd overtone pitch) settings, each of which can be turned on or off.

You can also specify the percussion decay time, which controls how long it takes for the percussion sound to decay.

Parameter Name	Parameter Display Indication	Settings
2nd Percussion	Second	Off On
3rd Percussion	Third	On
Percussion Decay Time	Decay	000 to 127





Display Contents in the Drawbar Organ Mode

In the Drawbar Organ Mode, the current status of the drawbar positions, key click, and percussion parameters are indicated on the display's bar graph as shown in the illustrations below. There is one line for each parameter, and the bottom segment of the selected parameter line flashes.

The bottom segment of the bar graph column that represents the currently selected parameter flashes to indicate that it is selected.



None of the channel numbers (1 to 16) are displayed in the drawbar organ tone mode and editing mode.

Drawbar Position Graph





Setting Value	0	1	2	3
Display				



Click and Percussion On/Off Graph

Setting Value	Off	On
Display		

Percussion Decay Time Graph

Setting Value	0-31	32-63	64-95	96-127
Display				

To save an edited drawbar organ tone

- 1 After editing parameters, use the [◀] and [▶] CURSOR buttons to display "More?".
- 2 Press the [▼] CURSOR button three times to display the screen for inputting a tone name and assigning a tone number.
 - You can select a tone number in the range of 100 to 199.
- 3 Use the [+] and [-] buttons or the number buttons to select a tone number.
 - Use the [+] and [-] buttons to scroll through letters at the current cursor location.
 - Use the [◀] and [▶] CURSOR buttons to move the cursor left and right.
 - See the page E-87 for information about inputting text.
- 4 After the tone name is the way you want, press the [▶] CURSOR button to store the tone.
 - This will display a confirmation message asking whether you really want to save the data. Press the YES button to save the data.
 - After the save operation is complete, the message "Complete" appears and then the display returns to the tone selection screen.
 - To cancel save, press the EXIT button.
- 5 After everything is the way you want, press the [▼] CURSOR button to store the tone.
 - This will display a confirmation message asking whether you really want to save the data. Press the YES button to save the data.
 - After the save operation is complete, the message "Complete" appears and then the display returns to the tone selection screen.
 - To cancel save, press the EXIT button.

Applying Effects to Tones

This digital piano provides you with a selection of effects that you can apply to tones. The built-in effects include a wide variety of variations that give you access to a selection of general digital effects.

Effect Blocks

The following shows how the effects of this digital piano are organized.

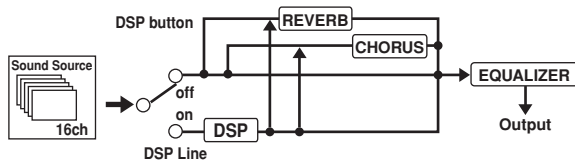

DSP

DSP effects are applied to the connection between the sound source and output. You can select distortion and modulation effects. You can create DSP effect setups and also transfer downloaded DSP data from your computer. The digital piano has memory that lets you store up to 100 DSP effect setups. See "Internet Data Expansion System" on page E-79 and "Saving the Settings of DSP Parameters" on page E-27 for more information.

REVERB

Reverb simulates the acoustics of specific types of environments. You can choose from among 16 different reverb effects, including "Room" and "Hall".

CHORUS

The chorus effect gives sound greater depth by causing it to vibrate. You can choose from among 16 different chorus effects, including "Chorus" and "Flanger".

EQUALIZER

The equalizer is another type of effect that you can use to make adjustments in tone quality. Frequencies are divided among a number of bands, and raising and lowering the level of each frequency band alters the sound.

You can reproduce the optimal acoustics for the type of music you are playing (classics, for example) by selecting the applicable equalizer setting.

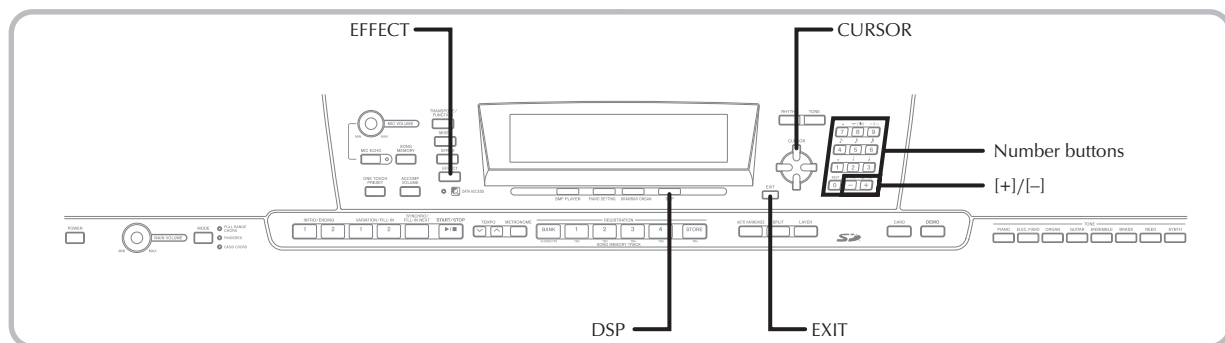

Selecting a DSP Type

In addition to the 100 built-in effect types, you can also edit effect types to create your own and store them in user memory. You can have up to 100 effect types in user memory at one time. You can also select the DSP type of the last DSP enabled tone that you used. This means you always have access to the DSP type of Advanced Tones and tones you download over the Internet. To select the DSP type of the last DSP enabled tone that you used, select “Ton” in step 3 of the procedure below.

Perform the following steps to select a DSP type.

PREPARATION

- When using a DSP effect, you should use the Mixer to confirm that the DSP lines of the required parts are turned on. See “Mixer Function” on page E-39 for more information.

- 1 Press the EFFECT button so the EFFECT indicator appears on the display.
- 2 Press the [▶] CURSOR button.
 - The DSP type setting screen (step 3) will appear automatically about five seconds after you press the button.
- 3 Use the [+] and [-] buttons or number buttons to select the type of DSP you want.
 - See the separate **Appendix E** for information about the DSP types that are available.
 - Here you could also change the parameters of the effect you selected, if you want. See “Changing the Settings of DSP Parameters” for more information.

NOTE

- The DSP type display area shows the DSP number (000 to 199), or “Ton” (user tone created using DSP).

Changing the Settings of DSP Parameters

You can control the relative strength of a DSP and how it is applied. See the following section titled “DSP Parameters” for more information.

- 1 After selecting the DSP type you want, use the [◀] and [▶] CURSOR buttons to display the parameter whose setting you want to change.
 - This displays the parameter setting screen.
- 2 Use the [+] and [-] buttons or the number buttons to make the parameter setting you want.
 - Pressing the [+] and [-] buttons at the same time returns the parameter to its recommended setting.
- 3 Press the EFFECT or EXIT button.
 - This exits the tone or rhythm setting screen.

DSP Parameters

The following describes the parameters for each DSP.

DSP

■ Parameter 0 to 7

These parameters differ in accordance with the algorithm* of the selected DSP type. For details, see the separate **Appendix E**, and the “algorithmlist_e.pdf” file in the “English” folder on the CD-ROM that comes with your digital piano.

* Effector structure and operation type

■ DSP Reverb Send (Range: 000 to 127)

Specifies how much of the post-DSP sound should be sent to reverb.

■ DSP Chorus Send (Range: 000 to 127)

Specifies how much of the post-DSP sound should be sent to chorus.



NOTE

- Whether or not an effect is applied to the parts that are sounding also depends on Mixer Mode Reverb Send, Chorus Send, and DSP on/off settings. See “Mixer Function” on page E-39 for more information.
 - Playing a demo tune (page E-12) automatically changes the effect to the one that is assigned to the tune. You cannot change or cancel a demo tune effect.
 - Changing the effect setting while sound is being output by the keyboard causes a slight break in the sound when the effect changes.
 - A number of tones, called “Advanced Tones”, automatically turn on the DSP line for richer, higher quality sound. If you assign an Advanced Tone to a keyboard part (Channels 1 through 4), the DSP line turns on automatically and the DSP selection changes in accordance with the settings of the Advanced Tone. Also, the Mixer Mode DSP line on/off setting for the keyboard part to which the Advanced Tone is assigned is turned on.*
- * The Mixer DSP line setting is automatically turned off for each part that does not have an Advanced Tone assigned.
Because of this, DSP effects previously applied to these parts are cancelled, which can make their tone sound different. In this case, display the Mixer screen and turn DSP back on.

Saving the Settings of DSP Parameters

You can save up to 100 modified DSPs in the user area for later recall when you need them.

NOTE

- User DSP areas 100 through 199 initially contain the same data as DSP types 000 through 099.

- 1 After making the DSP parameter settings you want, press the [▼] CURSOR button.
 - This causes the DSP number of the user area where the DSP will be saved to flash on the display.
- 2 Use the [+] and [-] buttons or the number buttons to select the user DSP area number where you want to save the new DSP.
 - You can select a user DSP area number in the range of 100 to 199 only.
- 3 After the user DSP area number you want is selected, press the [▶] CURSOR button.
 - Use the [+] and [-] buttons to scroll through letters at the current cursor location.
 - Use the [◀] and [▶] CURSOR buttons to move the cursor left and right.
 - See the page E-87 for information about inputting text.

- 4 After everything is the way you want, press the [▼] CURSOR button to store the effect.
 - This will display a confirmation message asking whether you really want to save the data. Press the YES button to save the data.
 - The message “Complete” appears momentarily on the display, followed by the tone or rhythm selection screen.

About the DSP Button

Checking the DSP button will tell you whether or not DSP is enabled for the tone that is currently selected for a part. The DSP button will be lit for a tone that is DSP enabled (DSP line ON), and unlit for a tone that is DSP disabled (DSP line OFF). For example, when you move each part while using the split/layer function, the DSP button lights or goes out in accordance with that parts setting.

Pressing the DSP button toggles the tone of the part you are currently playing on the keyboard between enabled (DSP line ON) and disabled (DSP line OFF).

To turn DSP line on and off

- 1 Press the DSP button to toggle DSP line for the currently selected part on and off.

Selecting REVERB

Perform the following steps to select REVERB.

- 1 Press the EFFECT button so the EFFECT indicator appears on the display.



- 2 Press the [▼] CURSOR button once.
 - This displays the reverb editing screen.
 - The reverb type setting screen (step 4) will appear automatically about five seconds after you press the button.
- 3 Press the [▶] CURSOR button.

4 Use the [+] and [-] buttons or the number buttons to scroll through the reverb types until the one you want is displayed, or use the number buttons to input the reverb number you want to select.

- See the separate **Appendix**  for information about the reverb types that are available.
- Here you could also change the parameters of the effect you selected, if you want. See “Changing the Settings of REVERB Parameters” for more information.

Changing the Settings of REVERB Parameters

You can control the relative strength of a reverb and how it is applied. See the following section titled “REVERB Parameters” for more information.

1 After selecting the reverb type you want, use the [◀] and [▶] CURSOR buttons to display the parameter whose setting you want to change.

- This displays the parameter setting screen.
- Example:* To set the Reverb Time parameter

0 7 2 S R v T i m e

2 Use the [+] and [-] buttons or the number buttons to input the parameter setting you want.

3 Press the EFFECT or EXIT button.

- This returns to the tone or rhythm selection screen.

REVERB Parameters

Reverb effects are associated with either a reverb type or delay type. Parameter settings depend upon the associated type.

Reverb Type (No. 0 to 5, 8 to 13)

■ Reverb Level (Range: 000 to 127)

Controls the reverb size. A larger number produces larger reverb.

■ Reverb Time (Range: 000 to 127)

Controls how long reverb continues. A larger number produces longer reverb.

■ ER Level (Initial Echo Sound) (Range: 000 to 127)

This parameter controls the initial reverb volume. The initial echo sound is the first sound reflected from the walls and ceiling when a sound is output by this digital piano. A larger value specifies a larger echo sound.

■ High Damp (Range: 000 to 127)

Adjusts the damping of high frequency reverberation (high sound). A smaller value damps high sounds, creating a dark reverb. A larger value does not damp high sounds, for a brighter reverb.

Delay Type (No. 6, 7, 14, 15)

■ Delay Level (Range: 000 to 127)

Specifies the size of the delay sound. A higher value produces a larger delay sound.

■ Delay Feedback (Range: 000 to 127)

Adjusts delay repeat. A higher value produces a greater number of repeats.

■ ER Level

Same as Reverb Type

■ High Damp

Same as Reverb Type

NOTE

- Whether or not an effect is applied to the parts that are sounding also depends on Mixer Mode Reverb Send, Chorus Send, and DSP on/off settings. See “Mixer Function” on page E-39 for more information.

Selecting CHORUS

Perform the following steps to select CHORUS.

1 Press the EFFECT button so the EFFECT indicator appears on the display.

2 Press the [▼] CURSOR button twice.

- This displays the chorus editing screen.
- The chorus type setting screen (step 4) will appear automatically about five seconds after you press the button.

3 Press the [▶] CURSOR button.

4 Use the [+] and [-] buttons or the number buttons to scroll through the chorus types until the one you want is displayed, or use the number buttons to input the chorus number you want to select.

- See the separate **Appendix**  for information about the chorus types that are available.
- Here you could also change the parameters of the effect you selected, if you want. See “Changing the Settings of CHORUS Parameters” for more information.

Changing the Settings of CHORUS Parameters

You can control the relative strength of an effect and how it is applied. The parameters you can control depend on the effect. See the following section titled “CHORUS Parameters” for more information.

- 1 After selecting the chorus type you want, use the [◀] and [▶] CURSOR buttons to display the parameter whose setting you want to change.
 - This displays the parameter setting screen.
- 2 Use the [+] and [-] buttons or the number buttons to input the parameter setting you want.
- 3 Press the EFFECT or EXIT button.
 - This returns to the tone or rhythm selection screen.

CHORUS Parameters

- **Chorus Level (Range: 000 to 127)**
Specifies the size of the chorus sound.
- **Chorus Rate (Range: 000 to 127)**
Specifies the undulation speed of the chorus sound. A higher value produces faster undulation.
- **Chorus Depth (Range: 000 to 127)**
Specifies the undulation depth of the chorus sound. A higher value produces deeper undulation.

NOTE

- Whether or not an effect is applied to the parts that are sounding also depends on Mixer Mode Reverb Send, Chorus Send, and DSP on/off settings. See “Mixer Function” on page E-39 for more information.

Using the Equalizer

This digital piano has a built-in four-band equalizer and 10 different settings from which you can choose. You can adjust the gain (volume) of all four equalizer bands within the range of -12 to 0 to +12.

To select the equalizer type

- 1 Press the EFFECT button so the EFFECT indicator appears on the display.

- 2 Press the [▼] CURSOR button three times.
 - This displays the equalizer editing screen.
 - The equalizer type setting screen (step 4) will appear automatically about five seconds after you press the button.
- 3 Press the [▶] CURSOR button.
- 4 Use the [+] and [-] buttons or the number buttons to select the equalizer type you want.
 - See the separate [Appendix H](#) for information about the equalizer types that are available.

Example: To select Jazz

8 J a z z

- Pressing the EXIT or EFFECT button exits the equalizer setting screen.

To adjust the gain (volume) of a band

- 1 After selecting the equalizer type you want, use the [◀] and [▶] CURSOR buttons to select the band whose gain you want to adjust.

Example: To adjust the HIGH band

0 0 M E q H i g h

- 2 Use the [+] and [-] buttons or the number buttons to adjust the band gain.

Example: To adjust the gain to 10

1 0 M E q H i g h

- Pressing the EXIT or EFFECT button exits the equalizer setting screen.

NOTE

- Changing to another equalizer type causes the band gain settings to change to the initial settings for the newly selected equalizer type automatically.

Auto Accompaniment

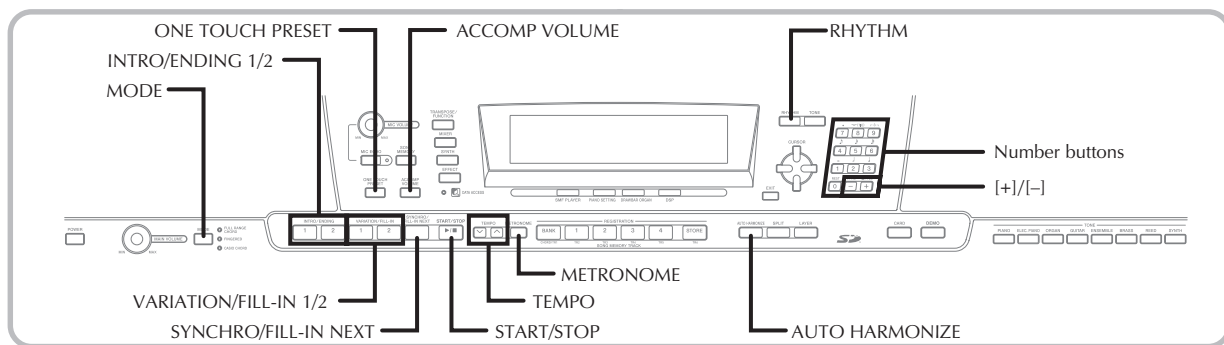

This digital piano automatically plays bass and chord parts in accordance with the chords you finger. The bass and chord parts are played using sounds and tones that are automatically selected to select the rhythm you are using. All of this means that you get full, realistic accompaniments for the melody notes you play with your right hand, creating the mood of a one-person ensemble.

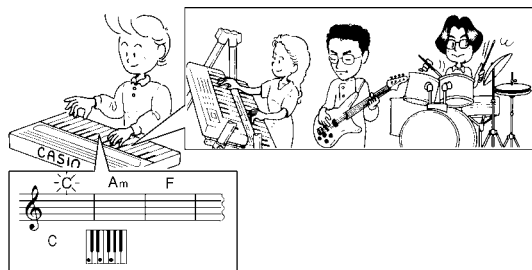

About the MODE Button

Use the MODE button to select the accompaniment mode you want to use. Each press of the MODE button cycles through the available accompaniment modes as shown in the illustration below.

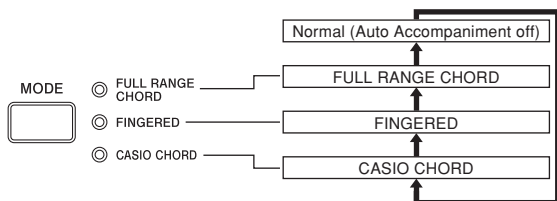

- Only rhythm sounds are produced when all accompaniment mode lamps are off.
- The currently selected accompaniment mode is shown by the mode lamps above the MODE button. Information on using each of these modes starts from page E-32.

Selecting a Rhythm

This digital piano provides you with 166 exciting rhythms that you can select using the following procedure. You can also transfer accompaniment data from your computer and store up to 16 of them as user rhythms in digital piano memory. See "Internet Data Expansion System" on page E-79 for more information.

To select a rhythm

- 1 Find the rhythm you want to use in the rhythm list (the separate **Appendix C**) and note its rhythm number.
- 2 Press the RHYTHM button.

Number and name of selected rhythm

RHYTHM 000 Mdrn 8Bt

Appears when RHYTHM button is pressed
- 3 Use the number buttons to input the three digit rhythm number for the rhythm you want to select.

Example: To select "052 POP 2", input 0, 5 and then 2.

RHYTHM 052 POP 2

NOTE

- You can also increment the displayed rhythm number by pressing [+], and decrement it by pressing [-].

Playing a Rhythm

To play a rhythm

- 1 Press VARIATION/FILL-IN button 1 or 2.
 - This starts the play of the selected rhythm.
 - To stop rhythm play, press the START/STOP button.

NOTE

- Chords will sound along with the rhythm if any of the three accompaniment mode lamps above the MODE button is lit. If you want to play the rhythm pattern without chords, press the MODE button until all of the lamps are off.
- Some rhythms consist of chord accompaniments only, without any drums or other percussion instruments. Such rhythms do not sound unless CASIO CHORD, FINGERED, or FULL RANGE CHORD is selected as the accompaniment mode.
- Accompaniment sounds (chords, bass, etc.) do not sound while a metronome rhythm (No. 160 to 165: 0, 2, 3, 4, 5, 6 Beat) is being used, even if the MODE button setting is CASIO CHORD, FINGERED, or FULL RANGE CHORD. Because of this, you should press the MODE button until all of the lamps are off.

Adjusting the Tempo

You can adjust the tempo of rhythm play within a range of 30 to 255 beats per minute. The tempo setting is used for Auto Accompaniment chord play, and song memory operations.

To adjust the tempo

- 1 Press one of the TEMPO buttons (▲ or ▼).
 - ▲ : Increments displayed value (increases tempo)
 - ▼ : Decrements displayed value (decreases tempo)



NOTE

- Pressing both TEMPO buttons (▲ and ▼) at the same time resets the tempo to the default value of the currently selected rhythm.

Using Auto Accompaniment

The following procedure describes how to use the digital piano's Auto Accompaniment feature. Before starting, you should first select the rhythm you want to use and set the tempo of the rhythm to the value you want.

To use Auto Accompaniment

- 1 Use the MODE button to select CASIO CHORD, FINGERED, or FULL RANGE CHORD as the accompaniment mode.
 - The currently selected accompaniment mode is the one whose lamp is lit. See "About the MODE Button" on page E-30 for details.
- 2 Press the START/STOP button to start play of the currently selected rhythm.
- 3 Play a chord.
 - The actual procedure you should use to play a chord depends on the currently selected accompaniment mode. Refer to the following pages for details on chord play.

CASIO CHORD Page E-32
 FINGERED Page E-33
 FULL RANGE CHORD Page E-33

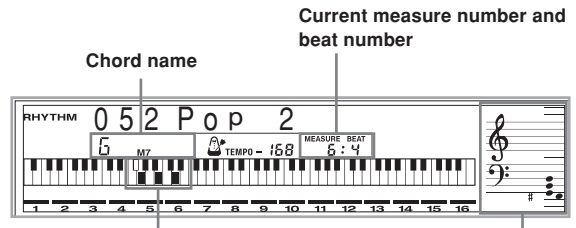

Basic fingering of current chord
 (May be different from chord actually
 being played on the keyboard.)

- 4 To stop Auto Accompaniment play, press the START/STOP button again.

NOTE

- If you press the SYNCHRO/FILL-IN NEXT button and then the INTRO/ENDING 1/2 buttons in place of the START/STOP button in step 2, accompaniment will start with an intro pattern when you perform the operation in step 3. For details about these buttons, see pages E-34 and E-35.
- If you press the INTRO/ENDING 1/2 buttons in place of the START/STOP button in step 4, an ending pattern will play before accompaniment play is ended. For details about this button, see page E-35.
- You can adjust the accompaniment part volume level independently of the main volume. For details, see "Adjusting the Accompaniment Volume" on page E-37.

CASIO CHORD

This method of chord play makes it possible for anyone to easily play chords, regardless of previous musical knowledge and experience. The following describes the CASIO CHORD "accompaniment keyboard" and "melody keyboard", and tells you how to play CASIO CHORDs.

CASIO CHORD Accompaniment Keyboard and Melody Keyboard

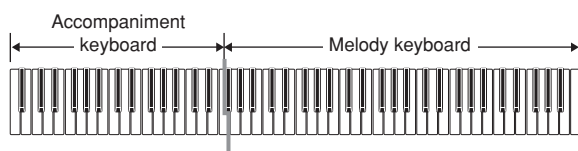

NOTE

- The accompaniment keyboard can be used for playing chords only. No sound will be produced if you try playing single melody notes on the accompaniment keyboard.

Chord Types

CASIO CHORD accompaniment lets you play four types of chords with minimal fingering.

Chord Types	Example
<p>Major chords</p> <p>Major chord names are marked above the keys of the accompaniment keyboard. Note that the chord produced when you press an accompaniment keyboard does not change octave, regardless of which key you use to play it.</p>	<p>C Major (C)</p>
<p>Minor chords (m)</p> <p>To play a minor chord, keep the major chord key depressed and press any other accompaniment keyboard key located to the right of the major chord key.</p>	<p>C minor (Cm)</p>
<p>Seventh chords (7)</p> <p>To play a seventh chord, keep the major chord key depressed and press any other two accompaniment keyboard keys located to the right of the major chord key.</p>	<p>C seventh (C7)</p>
<p>Minor seventh chords (m7)</p> <p>To play a minor seventh chord, keep the major chord key depressed and press any other three accompaniment keyboard keys located to the right of the major chord key.</p>	<p>C minor seventh (Cm7)</p>

NOTE

- It makes no difference whether you press black or white keys to the right of a major chord key when playing minor and seventh chords.

FINGERED

FINGERED provides you with a total of 15 different chord types. The following describes the FINGERED “accompaniment keyboard” and “melody keyboard”, and tells you how to play a C-root chord using FINGERED.

FINGERED Accompaniment Keyboard and Melody Keyboard

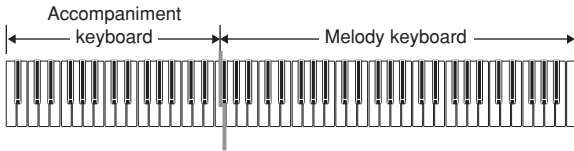

NOTE

- The accompaniment keyboard can be used for playing chords only. No sound will be produced if you try playing single melody notes on the accompaniment keyboard.

See the separate [Appendix](#) **D** for details on playing chords with other roots.

*1: Inverted fingerings cannot be used. The lowest note is the root.

*2: The same chord can be played without pressing the 5th G.

NOTE

- Except for the chords specified in note*1 above, inverted fingerings (i.e. playing E-G-C or G-C-E instead of C-E-G) will produce the same chords as the standard fingering.
- Except for the exception specified in note*2 above, all of the keys that make up a chord must be pressed. Failure to press even a single key will not play the desired FINGERED chord.

FULL RANGE CHORD

This accompaniment method provides a total of 38 different chord types: the 15 chord types available with FINGERED plus 23 additional types. The digital piano interprets any input of three or more keys that matches a FULL RANGE CHORD pattern to be a chord. Any other input (that is not a FULL RANGE CHORD pattern) is interpreted as melody play. Because of this, there is no need for a separate accompaniment keyboard, so the entire keyboard, from end to end, functions as a melody keyboard that can be used for both melody and chords.

FULL RANGE CHORD Accompaniment Keyboard and Melody Keyboard

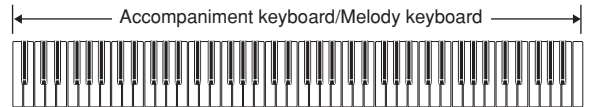

C 	Cm 	Cdim
Caug*1 	Csus4 	C7*2
Cm7*2 	Cmaj7*2 	Cm7*5
C7*5*1 	C7sus4 	Cadd9*2
Cmadd9*2 	CmM7*2 	Cdim7*1

Chords Recognized by This Digital Piano

The following table identifies patterns that are recognized as chords by FULL RANGE CHORD.

Pattern Type	Number of Variations
FINGERED	The 15 chord patterns shown under FINGERED on page E-33.
Standard Fingerings	<p>23 standard chord fingerings. The following are examples of the 23 chords available with C as the bass note.</p> <p>C₆ • Cm₆ • C₆₉</p> <p>$\frac{C^\sharp}{C}$ • $\frac{D}{C}$ • $\frac{E}{C}$ • $\frac{F}{C}$ • $\frac{G}{C}$ • $\frac{A^\flat}{C}$ • $\frac{B^\flat}{C}$</p> <p>$\frac{B}{C}$ • $\frac{C^\sharp m}{C}$ • $\frac{Dm}{C}$ • $\frac{Fm}{C}$ • $\frac{Gm}{C}$ • $\frac{Am}{C}$ • $\frac{B^\flat m}{C}$</p> <p>$\frac{Dm7^\flat5}{C}$ • $\frac{A^\flat7}{C}$ • $\frac{F7}{C}$ • $\frac{Fm7}{C}$ • $\frac{Gm7}{C}$ • $\frac{A^\flat add9}{C}$</p>

Example: To play the chord C major.

Any of the fingerings shown in the illustration below will produce C major.

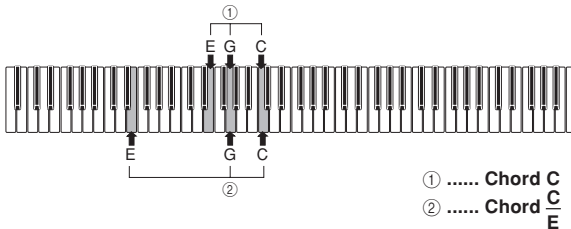

NOTE

- As with the FINGERED mode (page E-33), you can play the notes that form a chord in any combination (①).
- When the lowest note of a chord is separated from its neighboring note by six or more semitones, the lowest note becomes the bass note (②).

Using an Intro Pattern

This digital piano lets you insert a short intro into a rhythm pattern to make startup smoother and more natural.

The following procedure describes how to use the Intro feature. Before starting, you should first select the rhythm you want to use, set the tempo, and use the MODE button to select the chord play method you want to use (Normal, CASIO CHORD, FINGERED, FULL RANGE CHORD).

To insert an intro

- 1 Press INTRO/ENDING button 1 or 2.
 - With the above setup, the intro pattern is played and the auto accompaniment with intro pattern starts as soon as you play chords on the accompaniment keyboard.

NOTE

- The standard rhythm pattern starts to play after the intro pattern is complete.

Using a Fill-in Pattern

Fill-in patterns let you momentarily change the rhythm pattern to add some interesting variation to your performances.

The following procedure describes how to use the Fill-in feature.

To insert a fill-in

- 1 Press the START/STOP button to start rhythm play.
- 2 Select the fill-in variation you want.
 - To insert Fill-in 1, press the VARIATION/FILL-IN 1 button while Variation 1 of the rhythm is playing.
 - To insert Fill-in 2, press the VARIATION/FILL-IN 2 button while Variation 2 of the rhythm is playing.

NOTE

- Only the SYNCHRO/FILL-IN NEXT button is operational while an intro is playing.
- Holding down the SYNCHRO/FILL-IN NEXT or VARIATION/FILL-IN 1/2 buttons causes the fill-in pattern to repeat.

Using a Rhythm Variation

In addition to the standard rhythm pattern, you can also switch to a secondary “variation” rhythm pattern for a bit of variety .

To insert the variation rhythm pattern

- 1 Press the START/STOP button to start rhythm play.
- 2 Press the SYNCHRO/FILL-IN NEXT button.
 - If a Variation 1 rhythm is currently playing, this plays Fill-in 1, followed by Fill-in 2, and then switches to the Variation 2 rhythm.
 - If a Variation 2 rhythm is currently playing, this plays Fill-in 2, followed by Fill-in 1, and then switches to the Variation 1 rhythm.
 - Holding down the SYNCHRO/FILL-IN NEXT button causes the fill-in pattern to repeat.

Synchro Starting Accompaniment with Rhythm Play

You can set up the digital piano to start rhythm play at the same time you play the accompaniment on the keyboard.

The following procedure describes how to use synchro start. Before starting, you should first select the rhythm you want to use, set the tempo, and use the MODE button to select the chord play method you want to use (Normal, CASIO CHORD, FINGERED, FULL RANGE CHORD).

To use synchro start

- 1 Press the SYNCHRO/FILL-IN NEXT button to put the digital piano into synchro start standby.



- 2 Play a chord and the rhythm pattern starts to play automatically.

NOTE

- If the MODE button is set to Normal, only the rhythm plays (without a chord) when you play on the accompaniment keyboard.
- If you press the INTRO/ENDING button 1 or 2 before playing anything on the keyboard, the rhythm starts automatically with an intro pattern when you play something on the accompaniment keyboard.
- To cancel synchro start standby, press the SYNCHRO/FILL-IN NEXT button one more time.

Finishing with an Ending Pattern

You can end your performances with an ending pattern that brings the rhythm pattern you are using to a natural-sounding conclusion.

The following procedure describes how to insert an ending pattern. Note that the actual ending pattern played depends on the rhythm pattern you are using.

To finish with an ending pattern

- 1 While the rhythm is playing, press INTRO/ENDING button 1 or 2.
 - The timing when the ending pattern starts depends on when you press the INTRO/ENDING button 1 or 2. If you press the button before the second beat of the current measure, the ending pattern starts playing immediately.

NOTE

- Pressing the INTRO/ENDING button prior to the first half beat at the beginning of a measure plays the ending immediately. Pressing the button after the first half beat of a measure causes the ending to be played from the beginning of the following measure.

Using One-touch Preset

One-touch preset automatically makes the main settings listed below in accordance with the rhythm pattern you are using.

- Keyboard tone
- Layer on/off
- Split on/off
- Auto Harmonize on/off
- Auto Harmonize type
- Accompaniment volume level
- Tempo
- Effect settings

To use one-touch preset

- 1 Select the rhythm you want to use.
- 2 Use the MODE button to select the accompaniment mode you want to use.
- 3 Press the ONE TOUCH PRESET button.
 - This automatically makes the one-touch preset settings in accordance with the rhythm you selected.
 - The digital piano automatically enters synchro standby at this time.
- 4 Start rhythm and Auto Accompaniment, and play something on the keyboard.
 - Accompaniment is played using the one-touch preset settings.

Using Auto Harmonize

When you are using Auto Accompaniment, Auto Harmonize automatically adds additional notes to your melody in accordance with the chord that is being played. The result is a harmony effect that makes your melody line richer and fuller.

To use Auto Harmonize

- 1 Use the MODE button to select FINGERED or CASIO CHORD as the accompaniment mode.
 - The currently selected accompaniment mode is the one whose lamp is lit. See “About the MODE Button” on page E-30 for details.

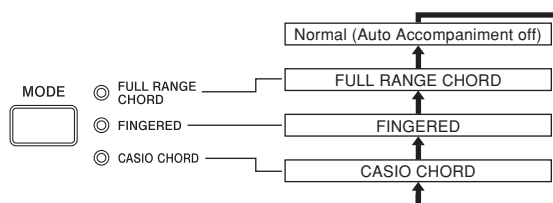

- 2 Press AUTO HARMONIZE button to turn on Auto Harmonize.
 - This causes the AUTO HARMONIZE indicator to appear on the display.

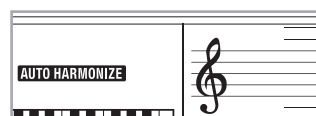

- 3 Start Auto Accompaniment play, and play something on the keyboard.
- 4 To turn off Auto Harmonize, press AUTO HARMONIZE button once.
 - This causes the AUTO HARMONIZE indicator to disappear.

NOTE

- Auto Harmonize turns off temporarily whenever you start demo tune play. It turns back on as soon as the operation or function that caused it to turn off is finished.
- Auto Harmonize is enabled only when the Auto Accompaniment mode is FINGERED or CASIO CHORD.

Auto Harmonize Types

Auto Harmonize lets you select from among the 10 Auto Harmonize types. Type changing is performed by the setting item using the TRANSPOSE/FUNCTION button. See “Changing Other Settings” on page E-68 for more information.

About Auto Harmonize notes and tones

The notes you play on the keyboard are called “melody notes”, while the notes added to the melody by Auto Harmonize is called the “harmonize notes”. Auto Harmonize normally uses the tone you selected for the melody notes as the tone for the harmonize notes, but you can use the Mixer (page E-39) to specify a different tone for the harmonize notes. The harmonize note tone is assigned to Mixer Channel 5, so change Channel 5 to the tone you want to use for the harmonize notes.

In addition to the tone, you can also use the Mixer to change a number of other parameters, such as volume balance. See “Using the Parameter Edit Mode” on page E-40 for details on these procedures.

NOTE

- The default harmonize note tone when you first turn on Auto Harmonize is the same tone as the melody note tone.
- Changing the melody tone setting automatically changes the harmonize note tone to the same setting.

Adjusting the Accompaniment Volume

You can adjust the volume of the accompaniment parts as a value in the range of 000 (minimum) to 127 (maximum).

- 1 Press the ACCOMP VOLUME button.

Current accompaniment volume setting



- 2 Use the number buttons or the [+]/[-] buttons to change the current volume setting value.

Example: 110



NOTE

- Pressing the ACCOMP VOLUME button or EXIT button returns to the tone or rhythm setting screen.
- Any channel balance settings you make with the Mixer are maintained when you change the accompaniment volume setting.
- Pressing [+] and [-] buttons at the same time automatically sets an accompaniment volume of 100.

Using the Metronome

The built-in metronome produces a bell sound for the first beat of each measure and a click sound for the remaining beats of the measure. The metronome is the perfect tool for practicing without accompaniment parts (rhythm).

NOTE

- The metronome sound is actually a type of rhythm. Because of this, you cannot sound the metronome at the same time another rhythm is sounding.
- Accompaniment sounds (chords, bass, etc.) do not sound while a metronome rhythm is being used, even if the MODE button setting is CASIO CHORD, FINGERED, or FULL RANGE CHORD. Because of this, you should press the MODE button until all of the lamps are off.

- 1 Press the METRONOME button.
 - This selects a 4-beat metronome.

RHYTHM 1 6 3 Metro 4 B t

- 2 Use the [+] and [-] buttons or number buttons to specify the rhythm number that corresponds to the number of beats you want to select.

Rhythm Number	Beat
160	0
161	2
162	3
163	4
164	5
165	6

NOTE

- Specifying a beat value of 0 causes the metronome to sound clicks only, without the bell sound at the beginning of each measure. This setting lets you practice with a steady beat.

- 3 Press the START/STOP button.
 - This starts the metronome.
- 4 Use the TEMPO buttons to adjust the tempo.
 - ∧ : Increase the tempo (indicated by a higher value)
 - ∨ : Decrease the tempo (indicated by a lower value)

NOTE

- Pressing the ∧ and ∨ buttons at the same time changes the tempo setting to 120.

- 5 To stop the metronome, press the START/STOP button.

Mixer Function

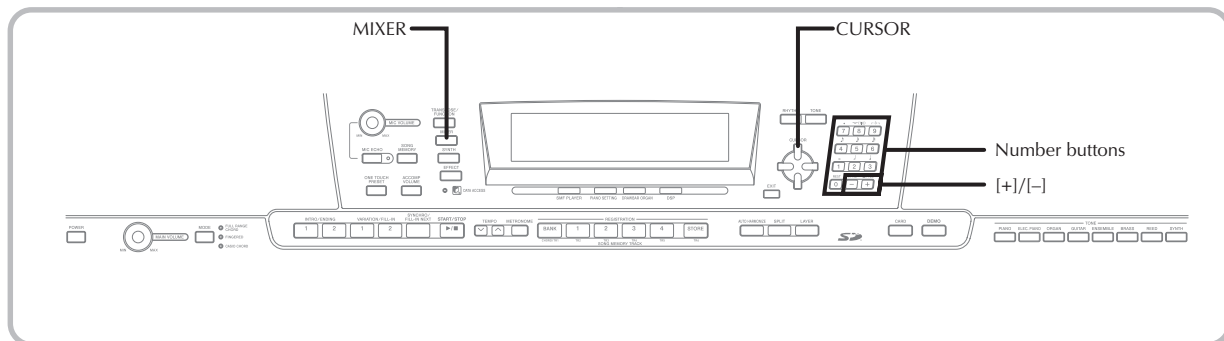

What you can do with the Mixer

This digital piano lets you play multiple different musical instrument parts at the same time during auto-accompaniment play, song memory playback, receipt of data through USB etc. The Mixer assigns each part to a separate channel (1 through 16) and lets you control the channel on/off, volume, and pan pot parameters of each channel.

In addition to channels 1 through 16, the Mixer also has a DSP channel that you can use to adjust the DSP level, DSP pan, and other DSP parameters.

Channel Assignments

The following shows the parts that are assigned to each of the 16 channels.

Channel Number	Part
Channel 1	Main tone
Channel 2	Layered tone
Channel 3	Split tone
Channel 4	Layered/split tone
Channel 5	Harmonize Tone
Channel 6	Auto Accompaniment chord part 1
Channel 7	Auto Accompaniment chord part 2
Channel 8	Auto Accompaniment chord part 3
Channel 9	Auto Accompaniment bass part
Channel 10	Auto Accompaniment rhythm part
Channel 11	Song Memory track 1
Channel 12	Song Memory track 2
Channel 13	Song Memory track 3
Channel 14	Song Memory track 4
Channel 15	Song Memory track 5
Channel 16	Song Memory track 6

See pages E-63 to E-65 for information on layered, split, and layered/split tones.

See page E-51 for information on the song memory.

NOTE

- Normally, keyboard play is assigned to Channel 1. When Auto Accompaniment is being used, each part of the accompaniment is assigned to Channels 6 through 10.
- When this digital piano is being used as the sound source for an externally connected computer or other MIDI device, all 16 channels are assigned musical instrument parts. The notes played over the channel selected by steps 1 and 2 under “Turning Channels On and Off” on page E-39 are shown on the displayed digital piano and staff.

Turning Channels On and Off

Turning a channel off mutes any instrument recorded in the channel.

To turn channels on and off

- 1 Press the MIXER button.
 - This causes a pointer to appear on the display next to MIXER.
- 2 Use the [◀]/[▶] CURSOR buttons to select a channel.

Example: To select Channel 1.

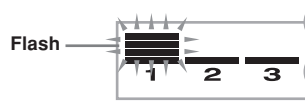

- This causes the upper three segments of the selected channel's level meter to flash.

- 3 Press the [▲]/[▼] CURSOR buttons to display the on/off selection screen.

On Channel

- 4 Use the [+]/[-] buttons to select on or off.
Example: To turn the channel off.

Off Channel

- Press the [▲] CURSOR button to return to the channel selection screen.
- Pressing the MIXER button returns to the Tone Screen.

NOTE

- The MIDI data display shows only the data for the channels selected with the Mixer.

How Channel On/Off Works

The following describes what happens and what appears on the display when you turn a channel on or off.

■ On (on)

This setting turns on the currently selected channel, which is indicated by a bar appearing at the bottom of the level meter for that channel. This is also the default setting for all channels when the digital piano is turned on.

■ Off (oFF)

This setting turns off the currently selected channel, which is indicated by the absence of the bar at the bottom of the level meter for that channel.

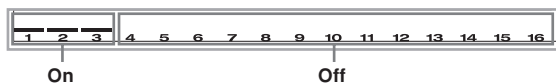

Using the Parameter Edit Mode

Editing the Parameters for Channels 1 through 16

In the Parameter Edit Mode, you can change the settings of ten different parameters (including tone, volume, and pan pot) for the channel you selected on the Mixer screen.

To change parameters

- 1 Press the MIXER button.
 - This causes a pointer to appear on the display next to MIXER.
- 2 Use the [◀] and [▶] CURSOR buttons to select the channel you want.
- 3 Use the [▲] and [▼] CURSOR buttons to select the parameter whose setting you want to change.

Example: Select volume setting by displaying “Volume”.

 - Each press of the [▲] or [▼] CURSOR buttons cycles through the parameters.
 - You can use the [◀] and [▶] CURSOR buttons to change to another channel at any time during this procedure.

Indicates channel volume of 127

127 Volume

- 4 Use the number buttons or [+] and [-] to change the parameter setting.

Example: Change the setting to “060”.

060 Volume

- Pressing the MIXER or EXIT button exits the parameter edit mode.

Editing DSP Channel Parameters

- 1 While Channel 16 is selected, press the [▶] CURSOR button.
 - This selects the DSP channel.
 - Pressing the [◀] CURSOR button while the DSP channel is selected returns to Channel 16.

How Parameters Work

The following are the parameters whose settings can be changed in the Parameter Edit Mode.

Tone Parameters

■ Tone

(Range: 000 to 903, Drawbar organ tones 000 to 199)

This parameter controls the tones assigned to each part. Anytime the tone is on the display, you can use the TONE button or DRAWBAR ORGAN button and then select a different tone, if you want.

000 St . Gr P no

■ Part On/Off (Settings: on, oFF)

This parameter can be used to turn each part on (sounds) and off (does not sound). The current on/off status of each part is indicated on the display as described below.

On Channel

■ Volume (Range: 000 to 127)

This is the parameter that controls the volume of the selected channel.

127 Volume

■ Pan Pot (Range: -64 to 00 to +63)

This parameter controls the pan pot, which is the center point of the left and right stereo channels. Setting "00" specifies center, a value less than "00" moves the point left, and a value greater than "00" moves it right.

63 Pan

■ Octave Shift (Range: -2 to 0 to +2)

You can use octave shift to shift the range of the tone up or down. When using the piccolo tone, there may be cases when very high notes you want to play are not included within the range of the keyboard. When this happens, you can use octave shift to shift the keyboard range one octave up.

0 Oct Shift

-2 : Range shifted two octaves down.

-1 : Range shifted one octave down.

0 : No shift

+1 : Range shifted one octave up.

+2 : Range shifted two octaves up.

Tuning Parameters

You can use these parameters to tune each of the parts individually.

■ Coarse Tune (Range: -24 to 00 to +24)

This parameter controls the coarse tuning of the selected channel's pitch in semitone units.

00 C . Tune

■ Fine Tune (Range: -99 to 00 to +99)

This parameter controls the fine tuning of the selected channel's pitch in cent units.

00 Fine Tune

Effect Parameters

The Mixer lets you control the effects applied to each individual part, making it different from the Effect Mode, whose settings are applied to all parts in general.

■ Reverb Send (Range: 000 to 127)

This parameter controls how much reverb is applied to a part. A setting of "000" turns reverb off, while a setting of 127 applies maximum reverb.

- "Reverb Send" does not work with some drum sounds.

0 5 6 R v b S e n d

■ Chorus Send (Range: 000 to 127)

This parameter controls how much chorus send is applied to a part. A setting of "000" turns chorus send off, while a setting of 127 applies maximum chorus send.

- "Chorus Send" does not work with drum sounds.

0 0 0 C h o S e n d

■ DSP Line (Settings: On, Off)

You can use this parameter to turn DSP line off for a particular channel, or to turn it on.

O f f D S P L i n e

DSP Part Parameters

■ DSP Level (Range: 0 to 127)

Sets the post-DSP volume.

1 2 7 D S P L e v e l

■ DSP Pan (Range: -64 to 0 to 63)

Sets the post-DSP stereo pan.

0 0 0 D S P P a n

■ DSP System Reverb Send (Range: 000 to 127)

This parameter adjusts how much reverb is applied to the DSP part.

0 0 0 D . R v b S n d

■ DSP System Chorus Send (Range: 000 to 127)

This parameter adjusts how much chorus is applied to the DSP part.

0 0 0 D . C h o S n d

NOTE

- Changing the tone, volume, pan pot, coarse tune, fine tune, reverb send, or chorus send setting causes the corresponding MIDI message to be output from the USB port.
- Changing the tone settings changes the tone, octave shift, reverb send, chorus send, and DSP line* parameter settings.
 - * When DSP is off (See the **NOTE** on page E-27).
- Turning on the Mixer's DSP Line parameter (on this page) causes the settings of the DSP Pan, DSP System Reverb Send, and DSP System Chorus parameters to be used in place of the Pan Pot, Reverb Send, and Chorus Send parameters.

Synthesizer Mode

The Synthesizer Mode of this digital piano provides the tools for creating your own original tones. Simply select one of the built-in tones and change its parameters to create your own original sound. You can even store your sounds in memory and select it using the same procedure as that used to select a preset tone.

Synthesizer Mode Functions

The following describes how to use each of the functions available in the Synthesizer Mode.

Synthesizer Mode Parameters

The preset tones that are built into this digital piano consist of a number of parameters. To create a user tone, you first recall a advanced tone (000 to 399) or a preset tone (400 to 599) and then change its parameters to change it to your own tone. Note that drum set tones (600 through 619) cannot be used as the basis of a user tone.

The illustration nearby shows the parameters that make up the preset tones and what each parameter does. As can be seen in the illustration, parameters can be divided into four groups, each of which is described in detail below.

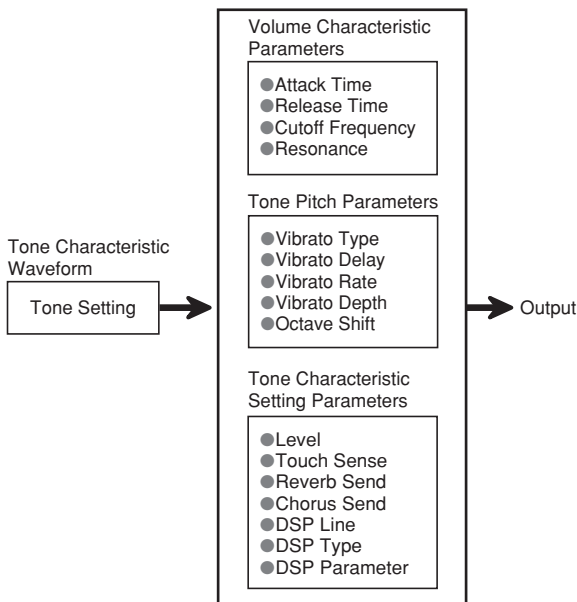

NOTE

- Note that the tone whose parameter you can edit is the one assigned to the channel (1 through 4) that is currently selected with the Synthesizer Mode.

(1) Tone Characteristic Waveform

■ Tone Setting

Specifies which of the preset tones should be used as the original tone.

(2) Volume Characteristic Parameters

These parameters control how the tone changes over time, from when the keyboard key is pressed until the tone decays. You can specify changes in volume and sound characteristics.

■ Attack time

This is the rate or time it takes for the tone to reach its highest volume level. You can specify a fast rate, where the tone reaches its highest volume level immediately, a slow rate where it gradually rises, or something in between.

■ Release time

This is the rate or time it takes for the tone volume to fall to zero. You can specify a release that ranges from a sudden fall to zero, to one that gradually falls to zero.

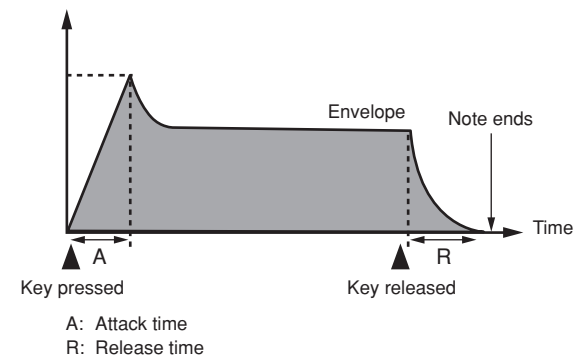

■ Cutoff Frequency

The cutoff frequency is a parameter for adjusting timbre by cutting any frequency that is higher than a specific frequency. A larger cutoff frequency produces a brighter (harder) timbre, while a smaller frequency produces a darker (softer) timbre.

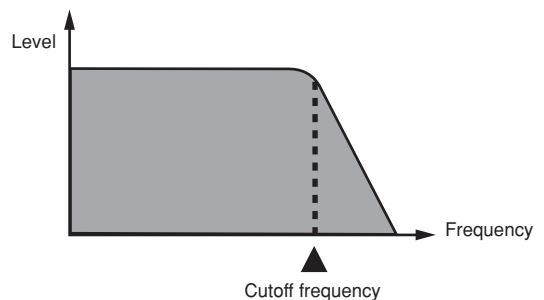

■ Resonance

Resonance enhances the harmonic components in the vicinity of the cutoff frequency, which creates a distinctive sound. A larger resonance value enhances the sound as shown in the figure.

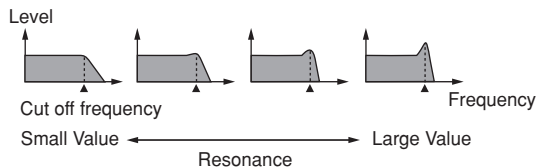

NOTE

- With some tones, a large resonance value can cause distortion or noise during the attack part of the tone.

(3) Tone Pitch Parameters

■ Vibrato Type, Vibrato Delay, Vibrato Rate, Vibrato Depth

These parameters adjust the vibrato effect, which causes periodic changes in the tone.

■ Octave Shift

This parameter controls the octave of all tones.

(4) Tone Characteristic Setting Parameters

■ Level

This parameter controls the overall volume of the tone.

■ Touch Sense

This parameter controls changes in volume and timbre in accordance with the relative amount of pressure applied to the keyboard keys. You can specify more volume for stronger pressure and less volume for a lighter pressure, or you can specify the same volume regardless of how much pressure is applied to the keys.

■ Reverb Send, Chorus Send, DSP Line, DSP Type, DSP Parameter

These parameters control the effects applied to tones.



Saving User Tones

The group of tone numbers from 700 through 799 (User 001 through User 100) is called the “user area” because they are reserved for storage of user tones. After you recall a preset tone and change its parameters to create your own user tone, you can store it in the user area for later recall. You can recall your tones using the same procedure that you use when selecting a preset tone.

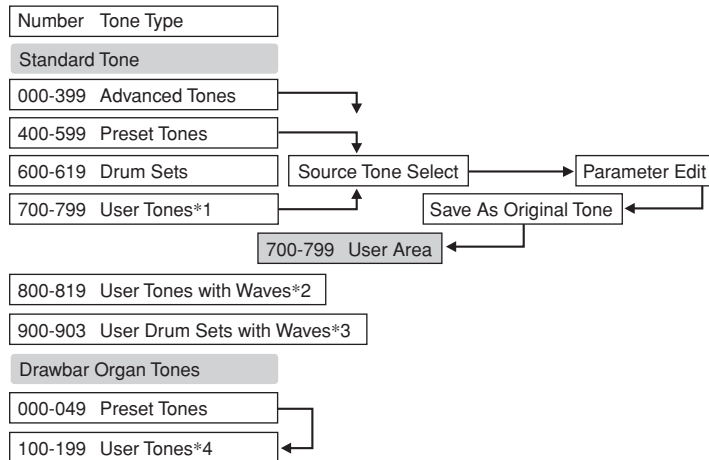

- *1: You can select any Advanced Tone, preset tone, or user tone. User tone areas 700 through 799 initially contain the same data as advanced tones 000 through 099.
- *2: Area where data transferred from computer is stored (see “Internet Data Expansion System” on page E-79). After transfer, you can use the digital piano to edit parameters, but you can only overwrite existing parameters. You cannot save the data to another number.
- *3: Area where data transferred from computer is stored (see “Internet Data Expansion System” on page E-79). Transfer only is allowed, and no parameter editing is allowed.
- *4: User tones created by modifying parameters of one of the preset tones (000 to 049). User drawbar organ tone areas initially contain two sets of the same data as drawbar organ tones types 000 through 049.

NOTE

- You can create an original tone using a user tone that includes a waveform (tone number 800 to 819). In this case, the storage area is the same as the source tone area. For example, an original tone created using tone number 800 as a source tone is stored in user area number 800.

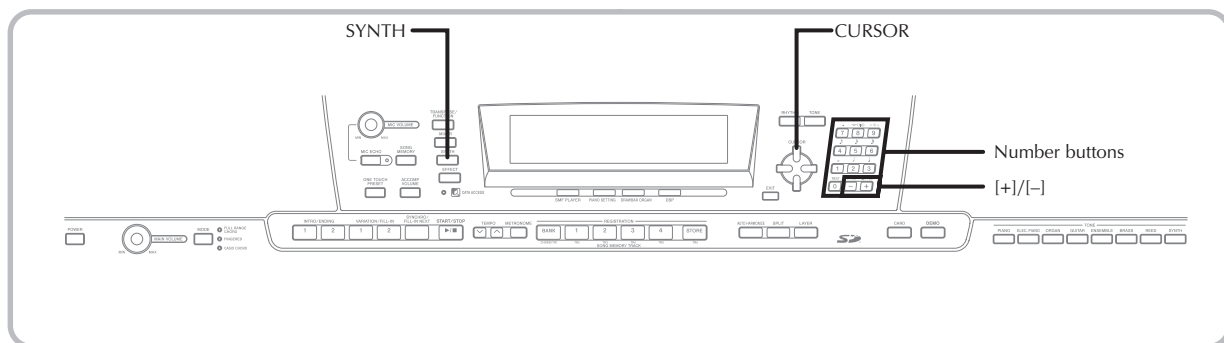

Creating a User Tone

Use the following procedure to select a preset tone and change its parameters to create a user tone.

- 1 First, select the preset tone you want to use as a basis for your user tone.
- 2 Press the SYNTH button.
 - This causes the SYNTH indicator to appear on the display.

Parameter setting value

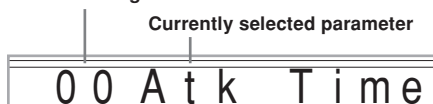

- 3 Use [◀] and [▶] CURSOR buttons to display the parameter whose setting you want to change.

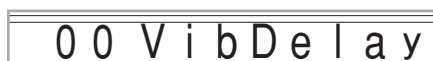

- Each press of [◀] or [▶] CURSOR button changes to the next parameter. See “Parameters and Their Settings” on this page for information on setting range for each parameter.
- 4 Use [+] and [-] to change the setting of the currently selected parameter.
 - You can also use the number buttons to input a value to change a parameter setting. See “Parameters and Their Settings” on this page for information on setting range for each parameter.
 - 5 After you are finished editing the sound, press the SYNTH button to exit the Synthesizer Mode.

NOTE

- See “Storing a User Tone In Memory” on page E-48 for details on saving user tone data to memory so it is not deleted.

Parameters and Their Settings

The following describes the function of each parameter and provides its setting range.

■ Attack Time (Range: -64 to 00 to +63)

Time it takes before the tone sounds after a key is pressed



■ Release Time (Range: -64 to 00 to +63)

Time the tone continues to sound after a key is released



■ Cutoff Frequency (Range: -64 to 00 to +63)

High-band cutoff for the harmonic components of the tone

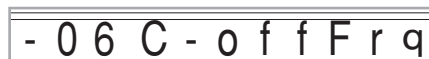

■ Resonance (Range: -64 to 00 to +63)





Resonance of the tone



■ **Vibrato Waveform (Range: See below.)**

Specifies the vibrato waveform.

Sin Vib . Type

Value	Meaning	Waveform
Sin	Sine Wave	
Tri	Triangle Wave	
Saw	Sawtooth Wave	
Sqr	Square Wave	

■ **Vibrato Delay (Range: -64 to 00 to +63)**

Specifies the amount of time before vibrato starts.

00 Vib Delay

■ **Vibrato Rate (Range: -64 to 00 to +63)**

Rate (speed) of the vibrato effect

02 Vib . Rate

■ **Vibrato Depth (Range: -64 to 00 to +63)**

Depth of the vibrato effect

12 Vib Depth

■ **Octave Shift (Range: -2 to 0 to +2)**

Up/down octave shift

-1 Oct Shift

■ **Level (Range: 000 to 127)**

This parameter controls the overall volume of the tone. The greater the value, the greater the volume. Setting a level of zero means that the tone does not sound at all.

096 Level

■ **Touch Sensitivity (Range: -64 to 00 to +63)**

This parameter controls changes in the volume of the tone in accordance with the pressure applied to the keyboard keys. A greater positive value increases the volume of the output as pressure increases, while a negative value decreases volume with increased keyboard pressure. A setting of zero specifies no change in output volume in accordance with keyboard pressure.

32 Tch Sense

■ **Reverb Send (Range: 000 to 127)**

This parameter adjusts reverb.

127 Rvb Send

■ **Chorus Send (Range: 000 to 127)**

This parameter adjusts chorus.

112 Cho Send

■ **DSP Line (Settings: On, Off)**

This parameter controls whether or not the DSP effect is used.

On DSP Line

DSP Settings

Use the DSP editing screen to select the DSP type and to edit parameters.

- 1 Select a tone, press the SYNTH button, and then configure parameter settings.
- 2 After everything is the way you want, press the [▼] CURSOR button once.
 - This advances to the DSP parameter editing screen.
 - Pressing the [▲] CURSOR button returns to the Synthesizer Mode parameter screen.

This setting specifies DSP parameters. For details, see “DSP Parameters” on page E-26, the separate **Appendix E**, and the “algorithmlist_e.pdf” file in the “English” folder on the CD-ROM that comes with your digital piano.

NOTE

- If you store an original tone with the DSP line turned on (page E-49), simply recalling the tone automatically changes the DSP line, DSP type, and DSP parameter settings. This simplifies the recall of original tones that include a DSP effect.

User Tone Creation Hints

The following hints provide helpful advice on making user tone creation a bit quicker and easier.

Use a preset tone that is similar to the one you are trying to create.

Whenever you already have a rough idea of the tone you are trying to create, it is always a good idea to start with a preset tone that is similar.

■ Experiment with various different settings.

There are no real rules about what a tone should sound like. Let your imagination run free and experiment with different combinations. You may be surprised at what you can achieve.

Storing a User Tone In Memory

The following procedure shows how to store a user tone in memory. Once a tone is stored, you can call it up just as you do with a preset tone.

To name a user tone and store it in memory

- 1 Select a preset tone to use as the basis for the user tone, press the SYNTH button to enter the Synthesizer Mode, and make the parameter settings you want.
- 2 After making parameter settings to create the user tone, press [▼] CURSOR button twice.
- 3 Use [+] and [-] buttons or the number buttons to change the user area tone number on the display until the one where you want to store the tone is shown.
 - You can select any tone number from 700 to 799.



- 4 After the tone name is the way you want, press the [▶] CURSOR button to store the tone.
 - Use the [+] and [-] buttons to scroll through letters at the current cursor location.
 - Use the [◀] and [▶] CURSOR buttons to move the cursor left and right.
 - See the page E-87 for information about inputting text.
- 5 Press [▼] CURSOR button to save the user tone.
 - This will display a confirmation message asking whether you really want to save the data. Press the YES button to save the data.
 - The message “Complete” appears momentarily on the display, followed by the tone or rhythm selection screen.
 - To abort the save operation at any time, press the SYNTH button or the EXIT button to exit the Synthesizer Mode. Pressing the SYNTH button again (before selecting another tone) returns to the Synthesizer Mode with all of your parameter settings still in place.

Registration Memory

Registration Memory Features

Registration memory lets you store up to 32 digital piano setups (4 sets × 8 banks) for instant recall whenever you need them. The following is a list of settings that are saved in registration memory.

Registration Memory Settings

- Tone
- Rhythm
- Tempo
- Layer on/off
- Split on/off
- Split point
- Auto Harmonize on/off
- Mixer settings (Channels 1 to 10)
- Effect settings
- Touch Response settings
- Soft/sostenuto pedal jack
- Transpose
- Tuning
- Accompaniment volume setting
- Pitch bend range
- Auto Harmonize type
- MODE button setting
- Synchro standby state
- Mixer Hold
- DSP Hold
- Synthesizer Mode parameters (Vibrato Waveform, Vibrato Delay, Vibrato Rate, and Vibrato Depth only)

NOTE

- Each bank of registration memory initially contains data when you first use the digital piano. Simply replace the existing data with your own data.
- Registration memory functions are disabled while you are using the SMF Player, Song Memory or demo tune function.
- Registration memory functions are also disabled while you are using the card slot (page E-81).

Setup Names

You can assign setups into one of 32 areas, which you can select using BANK buttons 1 through 4 and the four REGISTRATION buttons. Area names range from 1-1 through 8-4 as shown below.

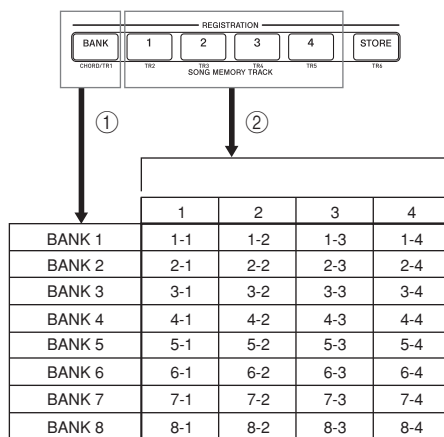

- ① Use the BANK button to select the bank. Each press of BANK cycles through the bank numbers from 1 to 8.
- ② Pressing one of the REGISTRATION buttons (1 to 4) selects the corresponding area in the currently selected bank.

NOTE

- Whenever you save a setup and assign it a setup name, any setup data previously assigned to that name is replaced with the new data.
- You can use the digital piano's USB capabilities to save your setup data to a computer or other external storage device. See "Internet Data Expansion System" on page E-79 for details.
- You can save setup data to an SD memory card, if you want. See "Saving Data" on page E-80 for more information.

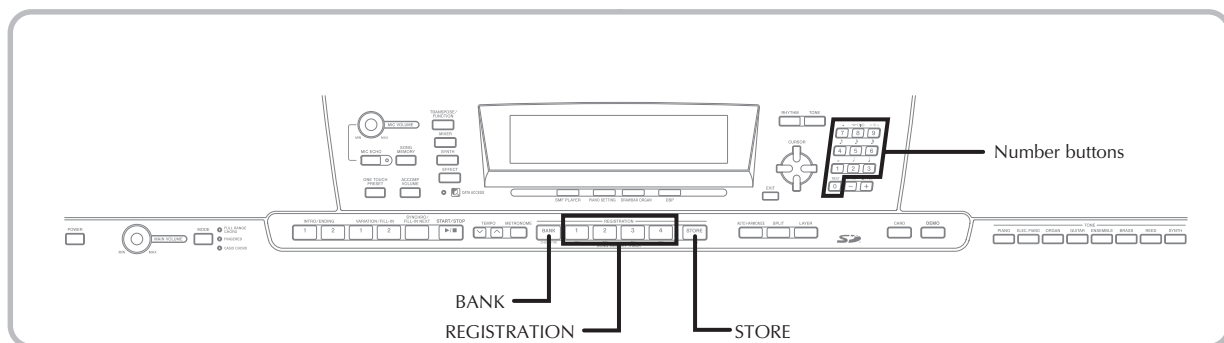

To Save a Setup in Registration Memory

- 1 Select a tone and rhythm, and otherwise set up the digital piano the way you want it.
 - See “Registration Memory Settings” on page E-49 for details on what data is stored in the registration memory.
- 2 Use the BANK button or the number buttons to select the bank you want.
 - If you do not perform any operation for about five seconds after pressing the BANK button, the display returns to the contents in step 1, above.
 - Bank 1 selected.

1 - - Bank

- 3 While holding down the STORE button, press a REGISTRATION button (1 to 4).
 - The following display appears when you press the 2 button.

1 - 2 Store

- 4 Release the STORE and REGISTRATION buttons.

NOTE

- The setup is saved as soon as you press a REGISTRATION button in step 3, above.

To Recall a Setup from Registration Memory

- 1 Use the BANK button or the number buttons to select the bank.
 - If you do not perform any operation for about five seconds after pressing the BANK button, the digital piano automatically clears the registration memory recall screen.

1 - - Bank

- 2 Press the REGISTRATION button (1 to 4) or number buttons for the area whose setup you want to recall.

1 - 2 Recall

- The setup name along with the message “Recall” appears on the display.

NOTE

- If you press a REGISTRATION button without using the BANK button to select a bank first, the last bank number selected is used.

Song Memory Function

This digital piano lets you record up to five separate songs in song memory for later playback. There are two methods you can use to record a song: real-time recording where you record the notes as you play them on the keyboard, and step recording where you input chords and notes one-by-one.

NOTE

- Layer and split cannot be used while standing by for recording or while recording is being performed in the Song Memory Mode. Also, layer and split are automatically turned off whenever the digital piano goes into record standby or starts recording.

Tracks

Digital piano song memory records and plays back much like a standard tape recorder. There are a total of six tracks, each of which can be recorded separately. Besides notes, each track can have its own tone number. Then when you play back the tracks together, it sounds like an entire six-piece band. During playback, you can adjust the tempo to change the speed of playback.

	Start	End
Track 1	Auto accompaniment (Rhythm, Bass, Chord 1/2/3), Keyboard play	→
Track 2	Keyboard play	→
Track 3	Keyboard play	→
Track 4	Keyboard play	→
Track 5	Keyboard play	→
Track 6	Keyboard play	→

Melody data recorded in track.

NOTE

- With this digital piano, Track 1 is the basic track, which can be used to record keyboard play, along with Auto Accompaniment. Tracks 2 through 6 can be used for keyboard play, so they are called melody tracks. Tracks 2 through 6 are used to add other parts to what is recorded in Track 1.
- Note that each track is independent of the others. This means that even if you make a mistake while recording, you only need to re-record the track where the mistake was made.
- You can use different Mixer settings for each track (page E-39).

Selecting a Track

Use the SONG MEMORY TRACK buttons marked CHORD/TR1 through TR6 to select the track you want.

Song Memory Track Buttons

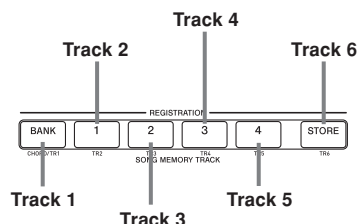

Basic Song Memory operations

The status of the Song Memory changes each time you press the SONG MEMORY button.

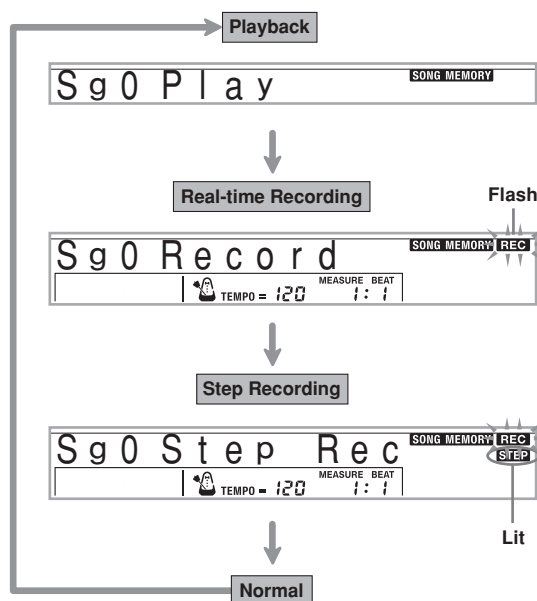

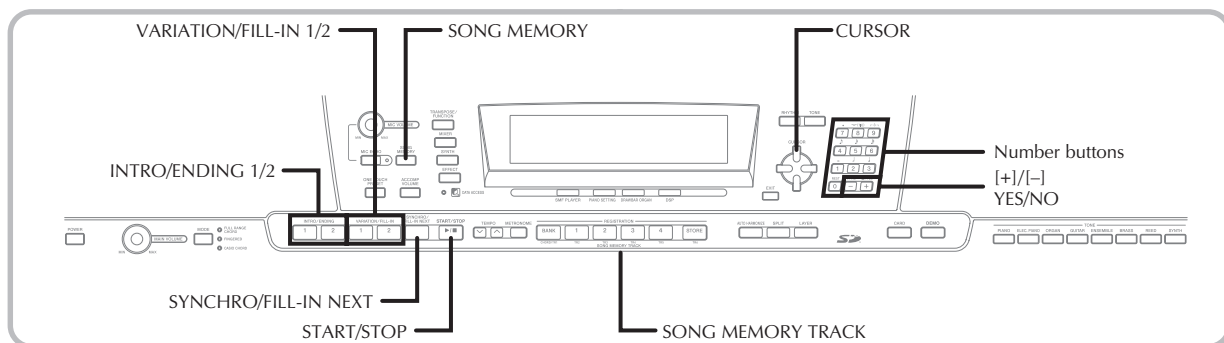

Using Real-time Recording

With real-time recording, the notes you play on the keyboard are recorded as you play them.

To record with real-time recording

- 1 Press the SONG MEMORY button twice to enter real-time record standby.
 - Perform step 2, below, within five seconds after entering record standby.

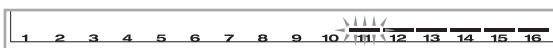

- The level meters for tracks 11 through 16 are shown on the display while the digital piano is in record standby, so you can easily check which tracks are already recorded. See “Level Meter Contents During Record/Edit Standby” on page E-58 for details.
- 2 Use the number buttons to select a song number (0 to 4).

Song number



- The above song number screen remains on the display for about five seconds. If it disappears before you have a chance to select a song number, use the [▼] CURSOR button to re-display it.
- 3 Make the following settings.
 - Tone number
 - Rhythm number
 - Tempo
 - MODE button

- 4 Press the START/STOP button to start recording.
 - When recording starts, the REC indicator flashes on the display. After a few moments the indicator stops flashing, and remains on the display.
 - Real-time recording without a rhythm starts. If you want to record with a rhythm, press the INTRO/ENDING 1/2 or VARIATION/FILL-IN 1/2.
- 5 Play something on the keyboard.
 - You can also record Auto Accompaniment chords by selecting the applicable mode with the MODE button.
 - The pedal and pitch bend operations are also recorded. See “Track 1 Contents After Real-time Recording” on page E-53 for details.
- 6 Press the START/STOP button to end recording when you are finish playing.
 - If you make a mistake while recording, you can stop the record operation and begin over again from step 1, or you can use the editing function (page E-60) to make corrections.

NOTE

- Using real-time recording to record to a track that already contains recorded data replaces the previous recording with the new one.

Track 1 Contents After Real-time Recording

In addition to keyboard notes and accompaniment chords, the following data is also recorded to Track 1 during real-time recording. This data is applied whenever Track 1 is played back.

- Tone number
- Rhythm number
- INTRO/ENDING 1 button, INTRO/ENDING 2 button, VARIATION/FILL-IN 1 button, VARIATION/FILL-IN 2 button, SYNCRHO/FILL-IN NEXT button operations
- Pedal operations

The following data is recorded in the header whenever you start a recording of a track.

- Mixer settings of other tracks
- Effect type
- Accompaniment volume
- Reverb Level
- Chorus Level
- DSP Hold On/Off
- Mixer Hold On/Off
- Pitch bend wheel operation
- Pitch bend range

Mixer Mode Settings

Channel 1 Mixer parameters (page E-39) are automatically recorded to Track 1. You can use the Mixer to change each of the parameters.

Memory Capacity

The digital piano has memory for approximately 10,000 notes.

- The measure number and note number flash on the display whenever remaining memory is less than 100 notes.
- Recording automatically stops (and auto-accompaniment and rhythm stops playing if they are being used) whenever memory becomes full.
- Initially, nothing is stored in song memory.

Memory Data Storage

- Whenever you make a new recording, anything previously stored in memory is replaced.
- Turning off the digital piano while a record operation is in progress causes the contents of the track you are currently recording to be lost.
- You can save memory data to SD memory cards, if you want. See “Saving Data” on page E-80 for more information.
- Remember that you can dump memory contents to a computer using the procedure described under “Internet Data Expansion System” on page E-79.

Track 1 Real-time Recording Variations

The following describes a number of different variations you can use when recording to Track 1 using real-time recording. All of these variations are based upon the procedure described under “To record with real-time recording” on page E-52.

To start recording with synchro start

In place of step 4, press the SYNCHRO/FILL-IN NEXT button. Auto-accompaniment and recording will both start when you play a chord on the accompaniment keyboard.

To record using an intro, ending, or fill-in

During recording, the INTRO/ENDING 1/2, SYNCHRO/FILL-IN NEXT, and VARIATION/FILL-IN 1/2 buttons (pages E-34 to 35) can all be used as they normally are.

To synchro start Auto Accompaniment with an intro pattern

In place of step 4, press the SYNCHRO/FILL-IN NEXT button and then INTRO/ENDING 1 or INTRO/ENDING 2 button. Auto-accompaniment will start with the intro pattern when you play a chord on the accompaniment keyboard.

To start Auto Accompaniment part way into a recording

In place of step 4, press the SYNCHRO/FILL-IN NEXT button and then play something on the melody keyboard to start recording without Auto Accompaniment. When you reach the point where you want accompaniment to start, play a chord on the accompaniment keyboard to start Auto Accompaniment.

Playing Back from Song Memory

Once you record tracks to song memory, you can play them back to see what they sound like.

To play back from song memory

- 1 Use the SONG MEMORY button to enter playback standby, and then use the number buttons to select a song number (0 to 4).



- The above song number screen remains on the display for about five seconds. If it disappears before you have a chance to select a song number, use the [▼] CURSOR button to re-display it.
- 2 Press the START/STOP button to playback the song you selected.
 - You can use the TEMPO buttons to adjust the playback tempo.
 - Press the START/STOP button again to stop playback.

NOTE

- You can play along on the keyboard using layer (page E-63) and split (page E-64) during playback.
- Pressing the START/STOP button to start playback from song memory always starts from the beginning of the song.
- The entire keyboard functions as a melody keyboard, regardless of the MODE button setting.

To turn off a specific track

Press the SONG MEMORY TRACK button of the track you want to turn off, or use the Mixer (page E-39) to turn off the channel of the track.

Recording Melody and Chords with Step Recording

With step recording, you can record Auto-Accompaniment chords and notes, and even specify note lengths one by one. Even those who find it difficult to play along on the keyboard with an Auto-Accompaniment can create Auto-Accompaniments based on their own original chord progressions. The following shows the type of data that can be recorded in Tracks 1 through 6.

Track 1: Chords and Auto-Accompaniment
Tracks 2 through 6: Keyboard play

With step recording, first record the chords and Auto-Accompaniment in Track 1. Next, record the melody in Tracks 2 through 6.

NOTE

- Use the procedure under "To record to Tracks 2 through 6 using step recording" on page E-58 for details on how to record to Tracks 2 through 6.

To record chords with step recording

- 1 Press the SONG MEMORY button three times to enter step recording standby, and then use the number buttons to select the song number (0 to 4).



- 2 Make the following settings.
 - Rhythm number
 - MODE button
- 3 Press the CHORD/TR1 button, which is one of the SONG MEMORY TRACK buttons, to select Track1.
 - When recording starts, the REC indicator flashes on the display. After a few moments the indicator stops flashing, and remains on the display.
- 4 Press the SYNCHRO/FILL-IN NEXT button.
- 5 Play a chord.
 - Use the chord play method that is specified by the current MODE button setting (Fingered, CASIO Chord, etc.).
 - When the MODE button is set to Normal, specify the chord using the root input keyboard and chord type input keyboard. See “Specifying Chords in the Normal Mode” on page E-56 for details.



Chord name

Measure, beat, and clock at current location*

* 96 clocks = 1 beat

- 6 Input the length of the chord (how long it should be played until the next chord is played).
 - Use the number buttons to specify the length of the chord. See “Specifying the Length of a Note” on page E-56 for details.
 - The specified chord and its length are stored in memory and the digital piano stands by for input of the next chord.
 - Repeat steps 5 and 6 to input more chords.

- 7 After you are finished recording, press the START/STOP button.
 - This enters playback standby for the song you have just recorded.
 - To play back the song at this time, press the START/STOP button.

NOTE

- Use the procedure under “Correcting Mistakes While Step Recording” on page E-59 to correct input mistakes you make during step recording.
- You can add on to a track that already contains recorded data by selecting that track in step 3 of the above procedure. Doing so automatically locates the step recording start point at the first beat immediately following the previously recorded data.
- Inputting “0” as the chord length in steps 5 and 6 of the above procedure specifies a rest, but the rest is not reflected in the accompaniment contents when the accompaniment is played.

Track 1 Contents After Step Recording

In addition to chords, the following data is also recorded to Track 1 during step recording. This data is applied whenever Track 1 is played back.

- Rhythm number
- INTRO/ENDING 1 button, INTRO/ENDING 2 button, VARIATION/FILL-IN 1 button, VARIATION/FILL-IN 2 button, SYNCHRO/FILL-IN NEXT button operations

NOTE

- You can also use number buttons 1 through 7, and button 9 to specify the button release timing for the VARIATION/FILL-IN 1, VARIATION/FILL-IN 2, and SYNCHRO/FILL-IN NEXT buttons. For more information, see “Specifying the Length of a Note” on page E-56. Specifying release timing specifies that the applicable button remains depressed for a particular amount of time. If you do not specify the release timing, it is assumed that the button is pressed and then immediately released.

Specifying Chords in the Normal Mode

When the MODE button is set to Normal during step recording, you can specify chords using a method that is different from CASIO Chord and Fingered fingerings. This chord specification method can be used to input 18 different chord types using only two keyboard keys, so chords can be specified even if you don't know how to actually play them.

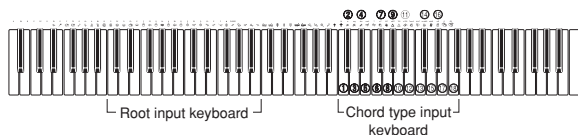

- | | |
|-----------------------|---------------------------|
| ① Major | ⑩ Seventh flat five |
| ② Minor | ⑪ Minor seventh flat five |
| ③ Augmented | ⑫ Seventh suspended four |
| ④ Diminished | ⑬ Diminished seventh |
| ⑤ Suspended four | ⑭ Minor add ninth |
| ⑥ Seventh | ⑮ Add ninth |
| ⑦ Minor seventh | ⑯ Minor sixth |
| ⑧ Major seventh | ⑰ Sixth |
| ⑨ Minor major seventh | ⑱ Sixth ninth |

To specify a chord, hold down the key on the root input keyboard that specifies the root, and press the key in the chord type input keyboard to specify the chord type. When inputting a chord with a specified bass note, pressing two keys of the root input keyboard causes the lower note to be specified as a bass note.

Example 1: To input Gm7, hold down G on the root input keyboard and press the m7 key on the chord type input keyboard.

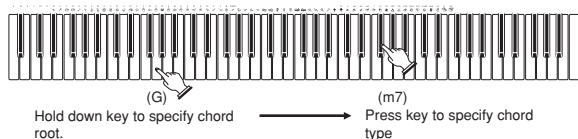

Example 2: To input Gm/C, hold down C and G on the root input keyboard and press the m key on the chord type input keyboard.

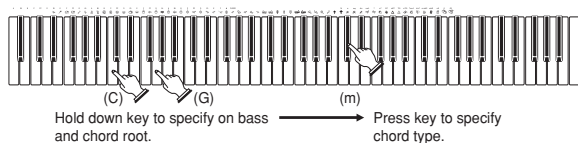

Specifying the Length of a Note

During step recording, the number buttons are used to specify the length of each note.

Note lengths

Use number buttons [1] through [6] to specify whole notes (♩), half notes (♪), quarter notes (♫), eighth notes (♮), 16th notes (♯), and 32nd notes (♯).

Example: To specify a quarter note (♫), press [3].

Dots (.) and triplicates (≡)

While holding down the [7] (dot) or [9] (triplicate), use buttons [1] through [6] to input the lengths of the notes.

Example: To input a dotted eighth note (♮.), hold down [7] and press [4].

Ties

Input the first and then the second note.

Example: To input , press [4] and then [8]. Next, press [5]. This note will be tied to the next note you input (16th note in this example).

Rest

Hold down [0] and then use number buttons [1] through [9] to specify the length of the rest.

Example: To input an eighth note rest, hold down [0] and press [4].

- Pressing the [▶] CURSOR button inputs rests up to the beginning of the next measure.

Track 1 Step Recording Variations

The following describes a number of different variations you can use when recording to Track 1 using step recording. All of these variations are based upon the procedure described under "To record chords with step recording" on page E-55.

To start accompaniment with an intro pattern

In step 4, press INTRO/ENDING 1 or INTRO/ENDING 2 button after the SYNCHRO/FILL-IN NEXT button.

To switch to a rhythm variation

In step 5, press VARIATION/FILL-IN 1 or VARIATION/FILL-IN 2 button immediately before inputting the chord.

To insert a fill in

In step 5, press VARIATION/FILL-IN 1 or VARIATION/FILL-IN 2 button at the measure or beat immediately before the chord or beat where you want to insert the fill in.

To insert an ending

In step 5, press INTRO/ENDING 1 or INTRO/ENDING 2 button at the measure or beat immediately before the chord where you want to insert the ending.

IMPORTANT!

- The length of the ending depends on the rhythm you are using. Check the length of the pattern you are using and set the length of the chord accordingly in step 6. Making the chord too short in step 6 can result in the ending pattern being cut off.

To step record chords without rhythm

Skip step 4. The specified chord of the length specified by the number buttons is recorded. A rest can be specified here, so an original chord pattern can be created.

To add chord accompaniment part way through rhythm play

In place of step 4 at the start of the recording, press VARIATION/FILL-IN 1 or VARIATION/FILL-IN 2 button and input rests. Then in step 5, input the chords. Only rhythm is played where you input the rests, and then chord play starts after the rests.

Recording Multiple Tracks

Track 1 of the digital piano's song memory records Auto Accompaniment and keyboard play. In addition, there are five other melody tracks that you can use to record melody parts only. You can record different tones to the melody tracks and build a full ensemble of instruments for your recordings. The procedure you use for recording to Tracks 2 through 6 is identical to the one you use when recording to Track 1.

To record to Tracks 2 through 6 using real-time recording

You can record to Tracks 2 through 6 while playing back what you originally recorded on Track 1 and any other tracks that are already recorded.

- 1 Press the SONG MEMORY button twice to enter record standby, and then use the number buttons to select a song number (0 to 4).
 - The song number you select should be the one where you previously input Track 1.
- 2 Use the SONG MEMORY TRACK buttons to select the track you want to record to (2 through 6).
 - While the digital piano is in record standby, the display shows the level meters for channels 11 through 16, so you can check which tracks have already been recorded. See "Level Meter Contents During Record/Edit Standby" on page E-58 for details.

- 3 Make the following settings.
 - Tone number
 - Tempo
- 4 Press the START/STOP button to start recording.
 - At this time, the contents of any tracks that are already recorded start to play back.
 - The pedal and pitch bend operations are also recorded.
- 5 Use the keyboard to play what you want to record the track you selected.
- 6 Press the START/STOP button to end recording when you are finished.

Track Contents After Real-time Recording

In addition to keyboard notes, the following data is also recorded to the selected track during real-time recording. This data is applied whenever the track is played back.

- Tone number
- Pedal operations

The following data is recorded in the header whenever you start a recording of a track.

- Mixer settings of other tracks
- Effect type
- Accompaniment volume
- Reverb Level
- Chorus Level
- DSP Hold On/Off
- Mixer Hold On/Off
- Pitch bend wheel operation
- Pitch bend range

To record to Tracks 2 through 6 using step recording

This procedure describes how to input notes one-by-one, specifying each note's pitch and length.

- 1 Press the SONG MEMORY button three times to enter real-time record standby, and then use the number buttons to select a song number (0 to 4).
 - The song number you select should be the one where you previously input Track 1.

S g 1 S t e p R e c

- 2 Use the SONG MEMORY TRACK buttons to select the track you want to record to (2 through 6).
Example: Select Track 2.

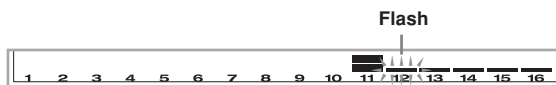

- 3 Specify a tone number.
 - Pressing a TONE button or the DRAWBAR ORGAN button displays the tone number and name on the display. You can then use the number buttons, or the [+] (increase) and [-] (decrease) buttons to change the tone.
 - After changing the tone number, press any keyboard key to clear the tone number and name screen, and return to the note input screen.
- 4 Use the keyboard keys to input notes, or the [0] button to input rests.
 - At this time, the display shows the keyboard pressure (velocity). Use the [+] (increase) and [-] (decrease) buttons to change the velocity.
 - You can also input a chord.
- 5 Use the number buttons to input the length of the note or rest (page E-56).
- 6 Repeat steps 4 and 5 to input more notes.
- 7 Press the START/STOP button to end recording when you are finished.

NOTE

- Use the procedure under “Correcting Mistakes While Step Recording” on page E-59 to correct input mistakes you make during step recording.
- You can add on to a track that already contains recorded data by selecting that track in step 2 of the above procedure. Doing so automatically locates the step recording start point at the first beat immediately following the previously recorded data.
- Whenever you are recording to Tracks 2 through 6, the entire keyboard functions as a melody keyboard, regardless of the current MODE button setting.
- When playing back data recorded with Advanced Tones at the beginning of multiple tracks, the digital piano uses the DSP type of the Advanced Tone that is recorded in the track with the largest track number.
- When playing back a track that was recorded with an Advanced Tone selected, they may be a slight delay before the first note of the track sounds. If this happens, try to insert a very short rest at the beginning of the track.

Track Contents After Step Recording

In addition to notes and rests, the following data is also recorded to the track during step recording. This data is applied whenever the track is played back.

- Tone number

Level Meter Contents During Record/Edit Standby

Channels 11 through 16 correspond to Tracks 1 through 6. Whenever the digital piano is in record or edit (page E-60) standby, the level meter display shows which tracks already contain recorded data and which are still empty. Tracks with four lit segments already contained recorded data, while tracks with one lit segment are not yet recorded.

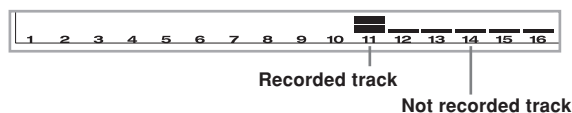

Correcting Mistakes While Step Recording

Memory data can be thought of as a musical score that progresses from left to right, with the input point normally at the far right of the recorded data.

The procedure described here lets you move the input point to the left in order to make changes in data you have already input. Note, however, that moving the input point to the left and changing data automatically deletes all of the data recorded to the right of the input point.

To correct mistakes while step recording

- Without exiting step recording, use the [◀] CURSOR button to move the input point to the left.
 - The REC indicator disappears from the display, and the STEP indicator flashes.

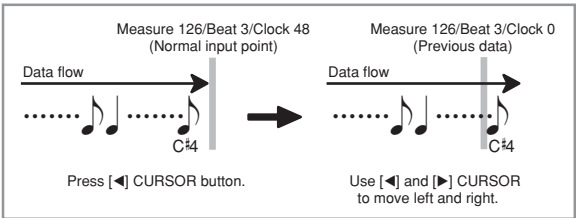
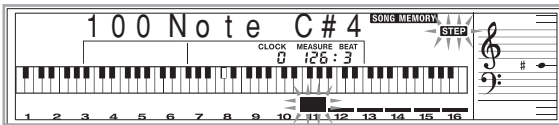

- Monitoring the data on the display, use [◀] and [▶] CURSOR buttons to move the input point to the data you want to change.

Example: To re-record all note data following the note A3 located at Measure 120, Beat 1, Clock 0.

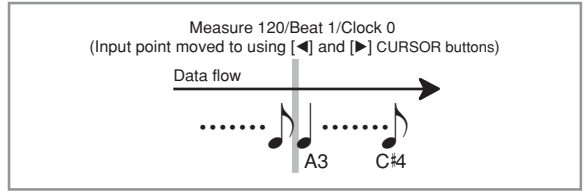
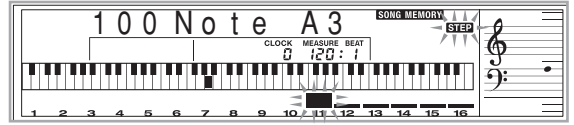

- Press the [▼] CURSOR button.



- Press the YES button.
 - This deletes all data from the location you specified and enters step record standby.
 - Pressing the [▲] CURSOR button or the NO button cancels deleting the data.

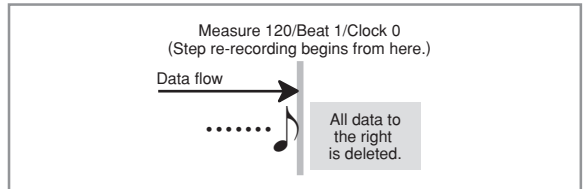

NOTE

- When you reach the end of the recording by pressing the [▶] CURSOR button, the "REC" indicator appears and the "STEP" indicator flashes on the display, indicating that you can add more data using step recording.

To delete specific note data

- 1 Perform steps 1 and 2 under “To correct mistakes while step recording” above to display the note you want to delete.
- 2 Press the [▼] CURSOR button twice.
- 3 In response to the “Delete?” message that appears on the screen, press the YES button to delete the displayed note.

Editing Memory Contents

After you record to digital piano memory, you can recall individual notes and parameter settings (such as tone number) and make any changes you want. This means you can correct misplayed notes, make changes in tone selections, etc.

The following types of data can be edited.

- Note intensity
- Notes
- Chords
- Tone numbers
- Rhythm number
- INTRO/ENDING 1 button, INTRO/ENDING 2 button, VARIATION/FILL-IN 1 button, VARIATION/FILL-IN 2 button, SYNCHRO/FILL-IN NEXT button operations

To edit memory contents

- 1 Press the SONG MEMORY button three times to enter step recording standby, and then use the [+] and [-] buttons to select a song number (0 to 4).



- 2 Use the SONG MEMORY TRACK buttons to select the recorded track that you want to edit.
- 3 Press the [◀] CURSOR button to enter the editing mode.
 - The REC indicator disappears from the display, and the STEP indicator flashes.

- 4 Use the [◀] and [▶] CURSOR buttons to move to the location in track where the note or parameter you want to change is located.

Note editing example

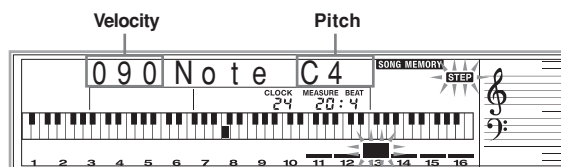

- 5 Make any changes in the value that you want.
 - The actual procedures you use to change a parameter depend on the type of data it contains. See “Editing Techniques and Display Contents” on page E-61 for details.
- 6 Repeat steps 4 and 5 to edit other parameters.
- 7 Press the START/STOP button to end editing when you are finished.

NOTE

- The only parameters that can be edited for Tracks 2 through 6 are notes and tone numbers.
- In the case of real-time recording, you later can change tone numbers you specified while recording to Tracks 1 through 6 is in progress.
- You can only change tone numbers that were originally set for Tracks 2 through 6 using step recording.
- In the case of real-time recording, you later can change rhythm numbers you specified while recording to Track 1 is in progress.
- You can only change rhythm numbers that were originally set for Track 1 using step recording.
- You cannot use the edit procedure to add more data to a recording.
- You cannot move portions of a recording to a different location within the recording.
- Note lengths cannot be changed.

Editing Techniques and Display Contents

The following describes the editing techniques you can use to change the various parameters stored in memory.

To change the key pressure (velocity) of a note

Use the number buttons or [+] and [-] to adjust the key pressure.



To change the pitch of a note

Input a new note on the keyboard or use [+] and [-] buttons to change the pitch of a note. The pitch you specify here is reflected in the keyboard and the notes shown in the staff on the display.



IMPORTANT!

- Whenever editing memory contents, never change a note so it is identical to the note before or after it. Doing so may alter the length of the changed note and the note before or after it. Should this happen, you will have to re-record the entire track.

To change a chord

Use the chord fingering method selected by the MODE button (FINGERED, CASIO CHORD, etc.) to input a chord.

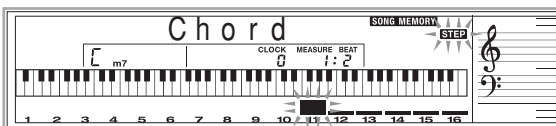

To change a tone number

Use the number buttons or [+] and [-] buttons to change a tone number.



NOTE

- In the case of real-time recording, you later can change tone numbers you specified while recording to Tracks 1 through 6 is in progress.
- You can only change tone numbers that were originally set for Tracks 2 through 6 using step recording.

To change a rhythm number

Use the number buttons or [+] and [-] buttons to change a rhythm number.

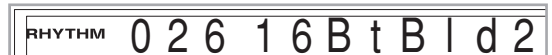

NOTE

- In the case of real-time recording, you later can change rhythm numbers you specified while recording to Track 1 is in progress.
- You can only change rhythm numbers that were originally set for Track 1 using step recording.

To change a rhythm controller operation*

* INTRO/ENDING 1 button, INTRO/ENDING 2 button, VARIATION/FILL-IN 1 button, VARIATION/FILL-IN 2 button, SYNCHRO/FILL-IN NEXT button operations
Press the rhythm controller button you want to change to.



Editing a Song

You can perform the following operations in the song editing mode.

- Delete a song
- Delete a track
- Song header data rewrite (Panel Record)

To delete a song

- 1 Press the SONG MEMORY button once to enter playback standby.
- 2 Use the [+] and [-] buttons to select the number of the song you want to delete.
- 3 Press the [▼] CURSOR button. If there is no song number on the display, press the [▼] CURSOR button twice.
 - This displays the song delete screen.
- 4 Press the YES button.
 - This causes the message "Sure?" to appear, confirming whether you really want to delete the song.
- 5 Press the YES button to delete the song and return to playback standby.

To delete a specific track

- 1 Press the SONG MEMORY button once to enter playback standby.
- 2 Use the [+] and [-] buttons to select the number of the song that contains the track you want to delete.
- 3 Press the [▼] CURSOR button twice. If there is no song number on the display, press the [▼] CURSOR button three times.
 - This displays the track delete screen.

Number of the song that contains the track
(cannot be changed)

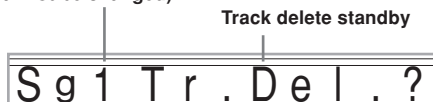

- 4 Use the SONG MEMORY TRACK buttons to select the recorded track or tracks whose data you want to delete.

Track delete standby

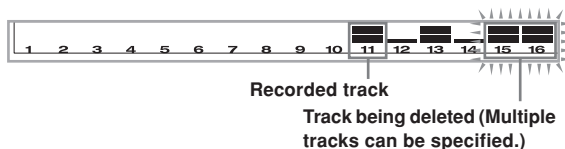

- You can specify more than one track for deletion by pressing more than one track select button.
 - To deselect a track, simply press its track select button again.
- 5 Press the YES button.
 - This causes the message "Sure?" to appear, confirming whether you really want to delete the track.
 - 6 Press the YES button to delete the track.

NOTE

- You cannot change the song number while in track delete standby.
- Pressing the SONG MEMORY button while in track delete standby returns to record standby.

To rewrite song header data (Panel Record)

You can use a procedure called "Panel Record" to change the initial Mixer, tempo and other settings stored in the song header.

- 1 Press the SONG MEMORY button once to enter playback standby.
- 2 Use the [+] and [-] buttons to select the number of the song that contains the header data you want to rewrite.
- 3 Make the changes you want to the header data.
- 4 Press the [▼] CURSOR button three times.
 - This displays the header data rewrite screen.
- 5 Press the YES button to rewrite the header data.

Digital Piano Settings

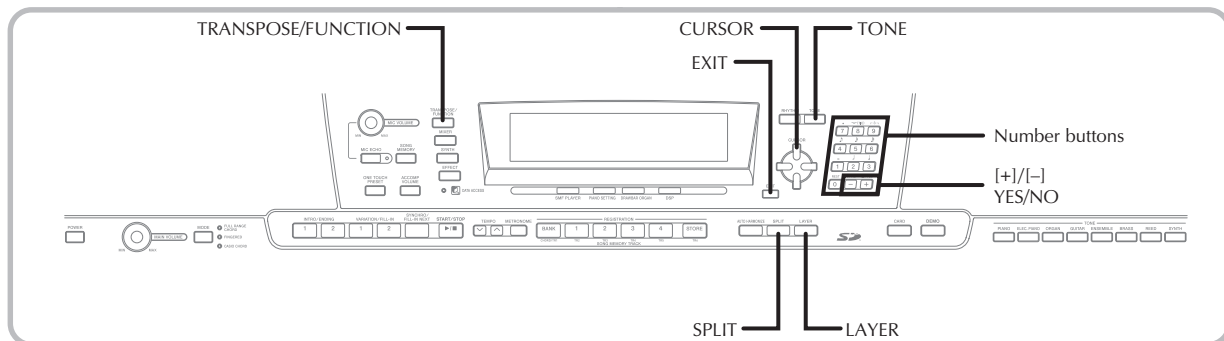

Parts

Up to four parts (numbered 1 through 4) can be used simultaneously during keyboard play. These parts can be used by the layer and split functions explained below.

- Part 1: Main tone part
- Part 2: Layered tone part
- Part 3: Split tone part
- Part 4: Layered and split tone part

Using Layer

Layer assign two different tones (a main tone and a layered tone) to the keyboard, both of which play whenever you press a key. For example, you could layer the GM FRENCH HORN tone on the GM BRASS tone to produce a rich and brassy sound.

LAYER

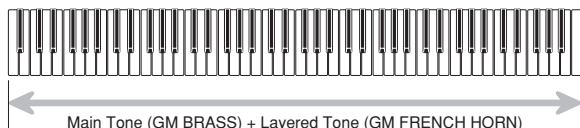

To layer tones

- 1 First select the main tone.
Example: To select "461 GM BRASS" as the main tone, press the TONE button and then use the number buttons to input 4, 6 and then 1.



- 2 Press the LAYER button.

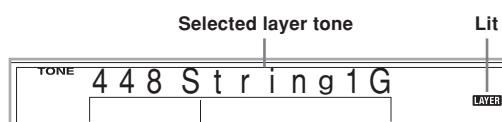

- 3 Select the layered tone.
Example: To select "460 GM FRENCH HORN" as the layered tone, use the number buttons to input 4, 6 and then 0.



- 4 Now try playing something on the keyboard.
 - Both tones are played at the same time.
- 5 Press the LAYER button again to unlayer the tones and return the keyboard to normal.

NOTE

- Turning on layering switches the currently selected part from Part 1 to Part 2, and displays the layered tone. At that time, you can use the [◀] and [▶] CURSOR buttons to switch between parts. Turning off layering returns to Part 1.
- The main tone sounds over Channel 1, while the layered tone sounds over Channel 2. You can also use the Mixer to change the tone and volume settings for these channels.
- Note that layering is not possible during record standby or recording in the Song Memory Mode, or while you are using the SMF Player Mode.

Using Split

With split you can assign two different tones (a main tone and a split tone) to either end of the keyboard, which lets you play one tone with your left hand and another tone with your right hand. For example, you could select GM STRINGS 1 as the main (high range) tone and GM PIZZICATO as the split (low range) tone, putting an entire string ensemble at your fingertips.

Split also lets you specify the split point, which is the location on the keyboard where the changeover between the two tones occurs.

NOTE

- Leave the MODE button in the Normal or FULL RANGE CHORD position.

SPLIT

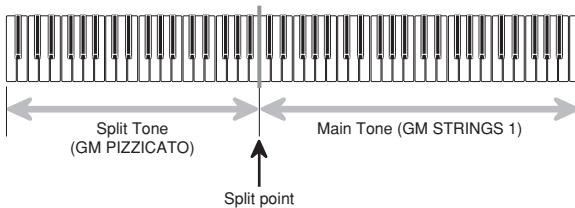

To split the keyboard

- 1 First select the main tone.

Example: To select “448 GM STRINGS 1” as the main tone, press the TONE button and then use the number buttons to input 4, 4 and then 8.



- 2 Press the SPLIT button.

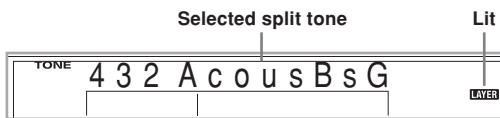

- 3 Select the split tone.

Example: To select “445 GM PIZZICATO” as the split tone, use the number buttons to input 4, 4 and then 5.



- 4 Specify the split point. While holding down the SPLIT button, press the keyboard key where you want the leftmost key of the high end range to be. *Example:* To specify G3 as the split point, press the G3 key.



- 5 Now try playing something on the keyboard.
 - Every key from F#3 and below is assigned the GM PIZZICATO tone, while every key from G3 and above is assigned the GM STRINGS 1 tone.
- 6 Press the SPLIT button again to unsplit the keyboard and return it to normal.

NOTE

- Turning on split switches the currently selected part to Part 3, and displays the split tone. At that time, you can use the [◀] and [▶] CURSOR buttons to switch between parts. Turning off split returns to Part 1.
- The main tone sounds over Channel 1, while the split tone sounds over Channel 3. You can also use the Mixer to change the tone and volume settings for these channels.
- Note that split is not possible during record standby or recording in the Song Memory Mode, or while you are using the SMF Player Mode.
- When the MODE button is set to CASIO CHORD or FINGERED, the accompaniment keyboard range is in accordance with the split point you specify with the above procedure.

Using Layer and Split Together

You can use layer and split together to create a layered split keyboard. It makes no difference whether you layer tones first and then split the keyboard, or split the keyboard and then layer tones. When you use layer and split in combination, the high range of the keyboard is assigned two tones (main tone + layered tone), and the low range two tones (split tone + layered split tone).

LAYER SPLIT

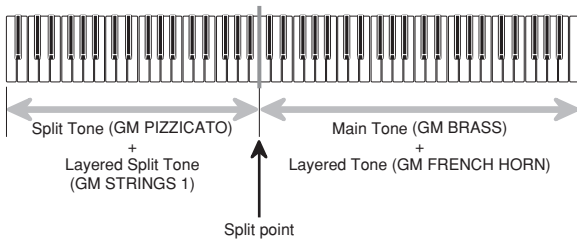

To split the keyboard and then layer tones

- 1 Press the TONE button and then input the tone number of the main tone.
Example: To set “461 GM BRASS” as the main tone.

TONE 4 6 1 B r a s s G

- 2 Press the SPLIT button and then input the number of the split tone.
Example: To set “445 GM PIZZICATO” as the split tone.

TONE 4 4 5 P i z z c a t G

- After specifying the split tone, press the SPLIT button to unsplit the keyboard.

- 3 Press the LAYER button and then input the number of the layered tone.
Example: To set “460 GM FRENCH HORN” as the layered tone.

TONE 4 6 0 F r H o r n G

- 4 Press the SPLIT button or the LAYER button so both of the SPLIT and LAYER indicators are displayed.
- 5 Input the number of the layered split tone.
Example: To specify the “448 GM STRINGS 1” tone, enter 4, 4, 8.

TONE 4 4 8 S t r i n g 1 G

- 6 While holding down the SPLIT button, press the keyboard key where you want the lowest note (the leftmost key) of the upper range (right side range) to be.
- 7 Play something on the keyboard.
 - Press the LAYER button to unlayer the keyboard, and the SPLIT button to unsplit it.

NOTE

- Turning on layer+split switches the currently selected part to Part 4, and displays the layered tone. At that time, you can use the [◀] and [▶] CURSOR buttons to switch between parts. Turning off layer returns to Part 3, while turning off split returns to part 2. Turning off both layer and split returns to Part 1.
- The main tone sounds over Channel 1, the layer tone over Channel 2, the split tone over Channel 3, and the layer/split tone over Channel 4. You can also use the Mixer to change the tone and volume settings for these channels.

Transposing the Digital Piano

Transpose lets you raise and lower the overall key of the digital piano in semitone units. If you want to play an accompaniment for a vocalist who sings in a key that's different from the digital piano, for example, simply use transpose to change the key of the digital piano.

To transpose the digital piano

- 1 Press the TRANSPOSE/FUNCTION button.
 - This causes the FUNCTION indicator to appear on the display.

00 Trans .

- 2 Use [+] and [-] to change the transpose setting of the keyboard.

Example: To transpose the digital piano five semitones upwards.

05 Trans .

- Pressing the TRANSPOSE/FUNCTION button exits the transpose screen.

NOTE

- The digital piano can be transposed within a range of -24 (two octave downwards) to +24 (two octave upwards).
 - The transpose setting also affects playback from song memory and Auto Accompaniment.
 - The allowable pitch range you can transpose within depends on the tone you are using. When transpose results in a note that is higher than the allowable pitch range, the keyboard replaces the note with one of the following.
 - The nearest note in the allowable pitch range (regardless of the pitch of the original note)
 - The same note in the nearest octave of the allowable pitch range
- In the case of a note that is lower than the allowable pitch range, the note is replaced with the nearest note in the allowable pitch range (regardless of the pitch of the original note).
- After using Transpose to raise the digital piano to a high key, notes played at the highest range of the keyboard may not sound properly for certain tones.

Using Touch Response

When touch response is turned on, the relative volume of sound output by the digital piano is varied in accordance with the amount of pressure applied, just like an acoustic piano.

To turn touch response on and off

- 1 Press the TRANSPOSE/FUNCTION button.
 - This causes the FUNCTION indicator to appear on the display.
- 2 Use the [◀] and [▶] CURSOR buttons to display the touch response setting screen.

2 Touch

- 3 Use the [+] and [-] buttons to select the touch response sensitivity level.
 - "1" outputs powerful sound even with light key pressure, while "3" requires very heavy key pressure to output powerful sound.
 - Pressing [+] and [-] at the same time returns sensitivity to the "2" setting.
 - When you select "Off", the tone does not change regardless of how much pressure you apply to the keyboard.

NOTE

- Touch response not only affects the digital piano's internal sound source, it also is output as MIDI data.
- Song Memory playback, accompaniment, and external MIDI note data do not affect the touch response setting.



Tuning the Digital Piano

The tuning feature lets you fine tune the digital piano to match the tuning of another musical instrument.

To tune the digital piano

- 1 Press the TRANSPOSE/FUNCTION button.
 - This causes the FUNCTION indicator to appear on the display.
- 2 Use the [◀] and [▶] CURSOR buttons to display the tuning screen.



00 Tune

- 3 Use [+] and [-] to change the tuning setting of the digital piano.
Example: To lower the tuning by 20.



- 20 Tune

- Pressing the TRANSPOSE/FUNCTION button exits the transpose screen.

NOTE

- The digital piano can be tuned within a range of -99 cents to +99 cents.
*100 cents is equivalent to one semitone.
- The tuning setting also affects playback from song memory and Auto Accompaniment.

Changing Other Settings

Setting Types

The table below shows the parameters whose settings you can change.

Setting menu	Description	Page
Transpose (Trans.)	Adjusts of overall digital piano tuning by semitone units.	E-66
Auto Harmonize (AutoHarm)	Selects the Auto Harmonize Type	E-70
Touch Response (Touch)	Specifies of how sound should change with keyboard pressure.	E-66
Tune (Tune)	Fine adjustment of overall digital piano tuning.	E-67
Contrast (Contrast)	Adjusts display brightness.	E-71
Half Damper Depth (HalfDamp)	Adjusts the amount of pedal effect applied when the damper pedal is pressed part way.	E-71
Soft/Sostenuto Pedal Jack (Jack)	Specifies the effect applied to the soft/sostenuto pedal jack.	E-71
Mixer Hold (MixHold)	Turns mixer hold on or off.	E-71
DSP Hold (DSP Hold)	Turn DSP hold on or off.	E-71
MIDI (MIDI)	MIDI settings	E-71
Delete/Initialize (Del/Init)	Initialization can be used to return digital piano parameters to their initial factory default settings, or to delete all data currently in keyboard memory.	E-71

NOTE

- The above settings are all saved whenever you turn off the digital piano. For details, see "Memory Contents" on page E-14.
- MIDI settings and Delete/Initialize settings are disabled while you are using the SMF Player or Song Memory function.



To use the digital piano settings menu

- 1 Press the TRANSPOSE/FUNCTION button.
 - This causes the FUNCTION indicator to appear on the display.
- 2 Use the [◀] and [▶] CURSOR buttons, and the [▲] and [▼] CURSOR buttons to recall the items whose settings you want to change.

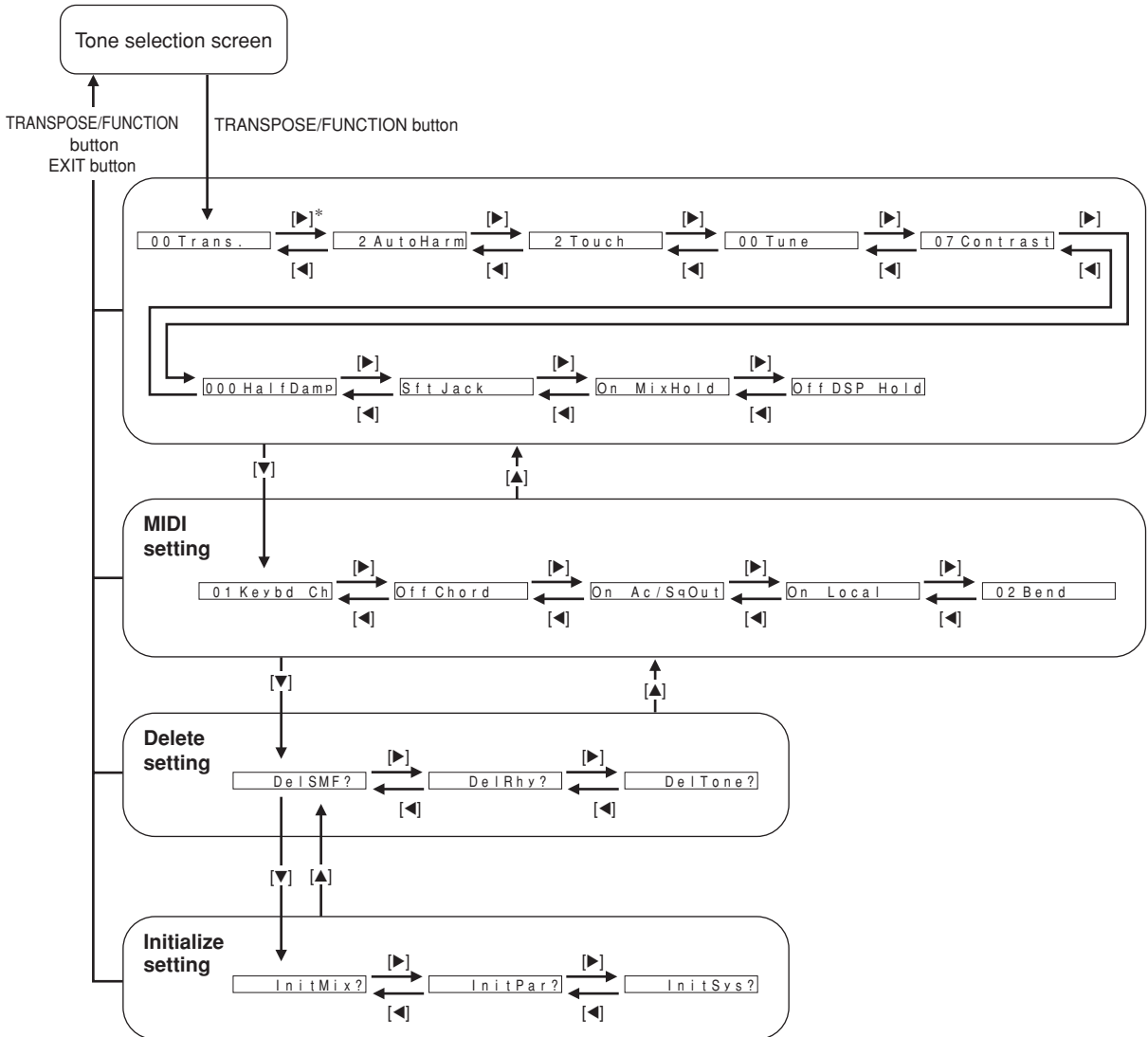

* [▲] : [▲] CURSOR button [◀] : [◀] CURSOR button
 [▼] : [▼] CURSOR button [▶] : [▶] CURSOR button

- 3 Use the [+] and [-] buttons or the number buttons to change the values.
- Settings you make are applied even if you do not press the EXIT button.
 - See the following section titled “Setting Menu Items” for details on each setting.
 - After making the settings you want, press the TRANSPOSE/FUNCTION button or EXIT button to return to the tone or rhythm selection screen.

■ In case of a delete or initialize procedure

- 4 Press the YES button.
- This displays the user area number and data name of the data to be deleted.
 - The data size value represents kilobyte units.
- 5 Now use the number buttons, or the [+] (increase) and [-] (decrease) buttons to select the data you want.
- 6 Press the [▼] CURSOR button.
- This causes the message “Sure?” to appear, confirming whether you really want to perform the delete or initialize operation.
- 7 Press the YES button to complete the operation.
- This performs the delete or initialize operation and returns to the step 5 screen.
- 8 After making the settings you want, press the TRANSPOSE/FUNCTION button or EXIT button to return to the tone or rhythm selection screen.

IMPORTANT!

- It can take one or two minutes to perform a delete or initialize procedure after you pressing the YES button in step 7 above. The message “Pls Wait” will remain on the display to indicate that a procedure is being performed. Never try to perform any operation while “Pls Wait” is displayed. Performing any operation can damage the digital piano’s memory and cause it to malfunction.

Setting Menu Items

■ Auto Harmonize Types

You can select from among the 10 different types of auto harmonize listed below.

No.	Type (Parameter Name)	Description
0	Duet1	Adds a 1-part harmony to keyboard play.
1	Duet2	Adds a 1-part harmony to keyboard play. Duet2 harmony is more open than Duet1.
2	Country	Adds a country-flavor harmony to keyboard play.
3	Octave	Adds notes one octave below notes played on the keyboard.
4	5th	Adds fifth notes above notes played on the keyboard.
5	3-Way Open	Adds two open harmony parts to notes played on the keyboard (creating three-part harmony).
6	3-Way Close	Adds two close harmony parts to notes played on the keyboard (creating three-part harmony).
7	Strings	Adds harmony suitable for strings.
8	Block	Adds block chord notes.
9	Big Band	Adds harmony suitable for big band play.

Other Settings

Setting menu	Range	Default	Description
Contrast (Contrast)	00 to 15	07	Adjusts display contrast.
Half Damper Depth (HalfDamp)	000 to 127	072	Adjusts the amount of the pedal effect applied when the damper pedal is pressed part way.
Soft/Sostenuto Pedal Jack (Jack)	Sft/Sos	Sft	Sft: Assigns the soft pedal effect to the pedal. Sos: Assigns the sostenuto pedal effect to the pedal.
Mixer Hold (MixHold)	On/Off	Off	When Mixer Hold is turned on, the parameters of accompaniment parts (Part 6 through Part 10) cannot be modified by accompaniment data.
DSP Hold (DSP Hold)	On/Off	Off	On: Current DSP line setting is maintained, even when the tone is changed. Off: Changing the tone switches to the DSP line setting of the new tone.

MIDI Setting

Setting menu	Range	Default	Description
Keyboard Channel (Keybd Ch)	01 to 16	01	Specifies the send channel for main tone play.
MIDI In Chord Judge (Chord)	On/Off	Off	Specifies whether accompaniment range MIDI Note On messages received from an external device should be interpreted as auto accompaniment chords.
Accomp/Song MIDI Out (Ac/SgOut)	On/Off	Off	Specifies whether this digital piano's auto accompaniment or song memory is sent as MIDI messages.
Local Control Setting (Local)	On/Off	On	Specifies whether the digital piano should sound the parts played on it.
Pitch Bend Range (Bend)	00 to 12	12	Specifies the maximum change in a tone that can be applied using the PITCH BEND wheel. The setting range is 00 (no change) to 12 (12 semitones).

Delete/Initialize Settings

Setting menu	Range	Default	Description
SMF Delete	—	—	Deletes selected SMF data.
User Rhythm Delete	—	—	Deletes selected user rhythm data.
User Tone Delete	—	—	Deletes selected user tone data.
Mixer Reset (InitMix?)	—	—	Initializes parameters assigned by the Mixer or by input from an external sequencer.
Parameter Reset (InitPar?)	—	—	Initializes all parameters, except for the display contrast setting.
System Reset (InitSys?)	—	—	Initializes the digital piano's parameters and registration data, and deletes all data stored in the digital piano's user area.

Using the SMF Player

The letters “SMF” stand for Standard MIDI File, which is a file format that allows MIDI data to be shared between different software and sequencers. There are actually three SMF formats, named SMF 0, SMF 1, and SMF 2. This digital piano supports the SMF 0 format, which is the one that is most widely used today, and so all mentions of “SMF data” in this manual refer to SMF 0 format data.

You can use your computer to transfer SMFs from the bundled CD-ROM to digital piano flash memory, or SMFs you have downloaded from the CASIO MUSIC SITE. SMF format music data can be stored in the digital piano’s built-in Flash memory. Data stored in Flash memory can be played back using the SMF Player Mode. You can also load SMF data from an SD memory card into the digital piano’s user area and then play it back using the SMF Player Mode. See “Saving Data” on page E-80 for details.

The follow shows the maximum number of files that can be stored on each type of media.

Flash Memory : 200 files*

SD Memory Card : 255 files*

* Note that the number of files you can store in memory also depends on the size of each file. If your files are very large, you may be able to store fewer than the number of files indicated above.

About Flash memory

Initially, your digital piano comes with three sample SMF tunes in memory.

No.	Tune Name
000	Nocturne Op.9-2
001	Fantaisie-Impromptu Op.66
002	Etude Op.10-3 “Chanson de l’adieu”
003	Etude Op.25-9
004	Prelude Op.28-7
005	Valse Op.64-1 “Petit Chien”
006	Ave Maria
007	Moments Musicaux Op.94-3
008	Fröhlicher Landmann
009	Von fremden Ländern und Menschen [Kinderszenen]
010	Träumerei [Kinderszenen]
011	Canon in D Major
012	Tambourin
013	Menuet [Klavierbüchlein für Anna Magdalena Bach]
014	Invention 1 <C Major BWV 772>
015	Invention 13 <A Minor BWV 784>
016	Praeludium 1 [Wohlt temperierte Klavier 1]
017	Jesus Bleibet Meine Freude
018	Gavotte
019	Sonatina Op.36-1 1st Mov.
020	Serenade [Eine Kleine Nachtmusik]
021	Sonata K.545 1st Mov.
022	Sonata K.331 3rd Mov. “Turkish March”
023	Ode To Joy
024	Für Elise
025	Sonata Op.13 “Pathétique” 2nd Mov.

No.	Tune Name
026	Sonata Op.27-2 “Moonlight” 1st Mov.
027	Waltz Op.39-15 (Duets)
028	Liebesträume 3
029	La Prière d’une Vierge
030	Promenade [Tableaux d’une Exposition]
031	Csikos Post
032	Sicilienne Op.78
033	Arabesque 1
034	La Fille aux Cheveux de Lin
035	Passepied [Suite Bergamasque]
036	Gymnopédie 1
037	Salut d’Amour
038	The Entertainer
039	Maple Leaf Rag
040	Chopsticks
041	Grandfather’s Clock
042	Amazing Grace
043	No.9 La Chasse [Burgmüller 25 Leichte Etüden Opus100]
044	No.14 La Styrienne [Burgmüller 25 Leichte Etüden Opus100]
045	No.19 Ave Maria [Burgmüller 25 Leichte Etüden Opus100]
046	No.23 Retour [Burgmüller 25 Leichte Etüden Opus100]
047	No.25 La Chevaleresque [Burgmüller 25 Leichte Etüden Opus100]
048	No.13 [Czerny Etudes de Mécanisme Opus 849]
049	No.26 [Czerny Etudes de Mécanisme Opus 849]

NOTE

- This is the initial factory default list. It is overwritten by storing SMF from the bundled CD-ROM or SMF data downloaded from the Internet.
- The CD-ROM that comes bundled with the keyboard can be used to return all SMF tunes to the initial factory defaults shown in this list. See “Returning the digital piano to its initial factory defaults” on page E-79 for details.

IMPORTANT!

- Note that CASIO COMPUTER CO., LTD. shall not be held liable for any loss of data stored in Flash memory, or on an SD memory card.

SMF Player Mode Operational Flow

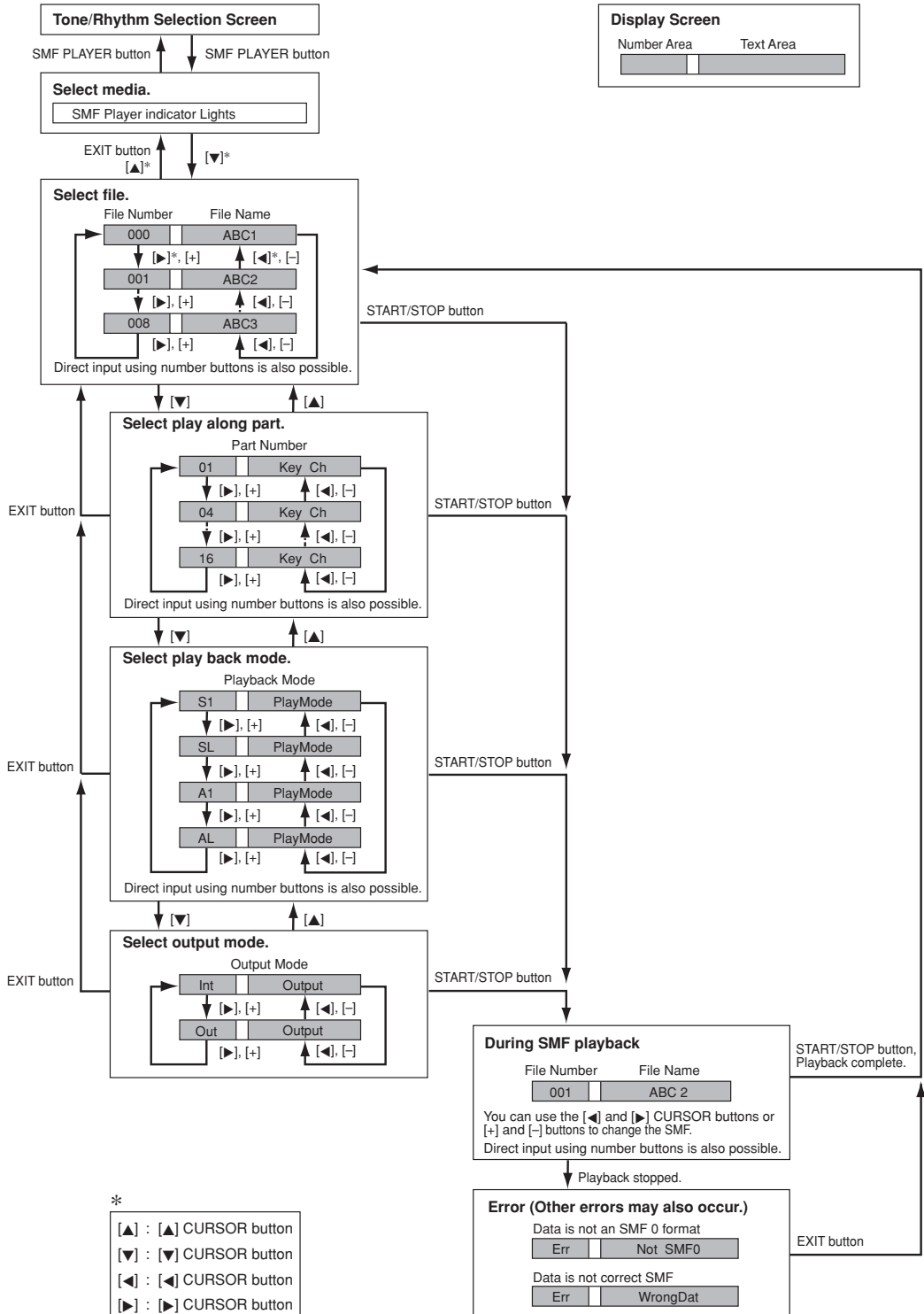

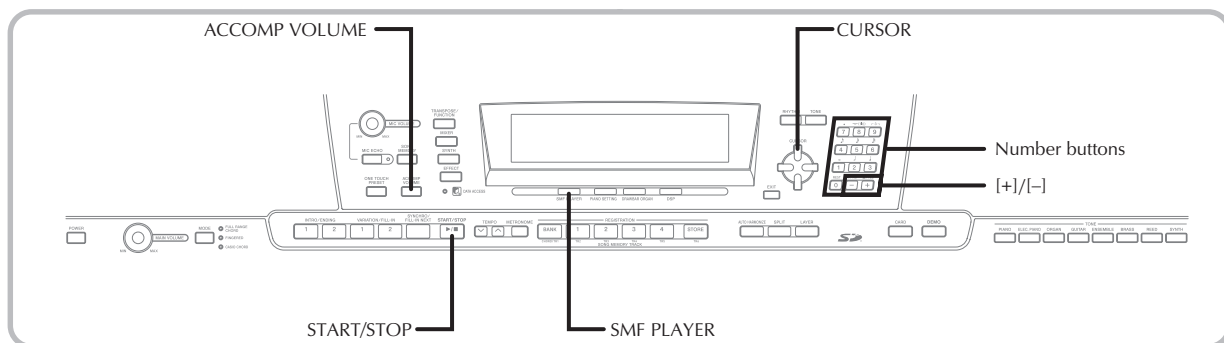

Playing Back an SMF

Note that the first step you need to perform in the procedure below depends on whether you are playing back from Flash memory or an SD memory card.

PREPARATION

- Insert the SD memory card that contains the data you want to play into the digital piano's card slot.

IMPORTANT!

- Never remove the memory card from the card slot or turn off the digital piano while card data is being accessed by a save, read, or delete operation. Doing so can corrupt the data on the memory card or even damage the card slot.

To play back an SMF

- 1 What you should do first depends on whether you are playing back from Flash memory or an SD memory card.

Flash Memory

- 2-1 Use the SMF PLAYER button to display the "Internal" indicator in the text area of the screen.
 - This causes the "SMF PLAYER" indicator to appear on the display.

Internal

- After pressing the SMF PLAYER button, you can use the [◀] and [▶] CURSOR buttons to select the SD memory card.

SD Memory Card

- 2-2 Insert the SD memory card that contains the file you want to play into the digital piano's card slot. Use the SMF PLAYER button to display the "Card" indicator in the text area of the screen.
 - This causes the "SMF PLAYER" indicator to appear on the display.
- 3 Press the [▼] CURSOR button to display the file selection screen.
 - SMFs are those shows file names end with the extension "MID". An error message appears at this time if there are no SMF files currently in storage media you are using.

- 4 Use the number buttons to input the three-digit file number of the file you want to play.
 - The name of the currently selected file will appear in the text area of the display. The file number is shown in the number area of the display. The Tempo/Measure area of the display shows the size of the file in kilobytes.
 - You can also use the [◀] and [▶] CURSOR buttons or [+] and [-] buttons to change the file.
- 5 Press the START/STOP button
 - This starts playback of the selected file.
 - You can use the TEMPO buttons to adjust the tempo within the range of 30 to 255.
 - You can turn channels 1 through 16 on and off, regardless of whether file playback is in progress or stopped. For more information, see “Turning Channels On and Off” on page E-39.
- 6 To stop file playback, press the START/STOP button again.

Adjusting SMF Playback Volume

The following procedure explains how to control the overall volume of SMF data playback. You can adjust volume while playback is stopped or ongoing.

- 1 Press the ACCOMP VOLUME button.
 - This causes the “SMF Vol.” indicator to appear on the display, along with a value that indicates the current SMF volume setting.
- 2 Use the [+] and [-] buttons or the number buttons to adjust the SMF volume.
 - You can specify a setting in the range of 000 (minimum) to 127 (maximum).
 - Pressing [+] and [-] at the same time returns the SMF volume setting to 100.
 - Note that this setting does not affect the volume of the notes you play on the keyboard.

Configuring Other Settings

To configure other settings

- 1 While playback is stopped, select the file you want to play back.
 - Perform steps 1 through 3 under “To play back an SMF” to select a file.

- 2 Press the [▼] CURSOR button to display a screen for selecting the part you want to play on the keyboard (play along part).
 - Use the [◀] and [▶] CURSOR buttons, the [+] and [-] buttons, or the number buttons to select the play along part.
 - You can specify the part you want to play on the keyboard (the play-along part) as a value in the range of 1 through 16.
 - Press the MIXER button to enter the Mixer Mode. Turn off the channel that corresponds to the play along part you selected above. See “Turning Channels On and Off” on page E-39 for more information. Performing this step turns off the applicable part so you can play it on the keyboard along with the rest of the SMF playback.

NOTE

- Entering the SMF Player Mode initializes all parts by turning on all Mixer Mode channels.
- After configuring Mixer Mode settings, press the MIXER button or EXIT button to return to the SMF Player Mode.

- 3 Press the [▼] CURSOR button to display the playback mode selection screen. Use the [◀] and [▶] CURSOR buttons or the [+] and [-] buttons to select the playback mode.

You can select from among the following four playback modes.

S1 : One file, one time
 SL : One file, repeat
 A1 : All files, one time
 AL : All files, repeat

- 4 Press the [▼] CURSOR button to display the output mode selection screen.
 - Use the [◀] and [▶] CURSOR buttons or the [+] and [-] buttons to select the output mode.
 - You can select from among the following two output types.

Int : Digital piano’s built-in speakers
 Out : USB port

NOTE

- Layer, split, and Auto Harmonize are automatically turned off in the SMF Player Mode.



SMF Player Error Messages

The following explains what you should do when an error message appears in the SMF Player Mode.

Error Message	Cause	Action
Err Not SMF0	You are attempting to play SMF data that is not Format 0.	Use only Format 0 SMF data.
Err WrongDat	There is a problem with the SMF data you are trying to play or the data is corrupted.	Use different data.

Connection to a Computer

The digital piano's USB port makes it quick and simple to connect to a computer. You can install a USB MIDI driver from the CD-ROM that comes bundled with the digital piano onto a computer equipped with a USB port. After that, you can connect your digital piano to the computer and run commercially available MIDI software on your computer to exchange MIDI data with the digital piano. You can also transfer data you downloaded from the CASIO MUSIC SITE to the digital piano, and even store digital piano data on your computer's hard disk.

To install the USB MIDI driver

- 1 On the computer to which you plan to connect, install the USB MIDI driver that comes on the CD-ROM that comes bundled with the digital piano.
 - For information about installing the USB MIDI driver, see the "CASIO USB MIDI Driver User's Guide" (USBmanual_e.pdf) on the CD-ROM.

NOTE

- Before starting actual installation of USB MIDI driver, be sure to read the contents of the "USBreadme.txt" file in the "English" folder on the CD-ROM.

- Use Adobe Reader or Acrobat Reader to access the USB MIDI driver user's guide.*

* You need to have Adobe Reader or Acrobat Reader installed on your computer in order to view the contents of the "CASIO USB MIDI Driver User's Guide" (USBmanual_e.pdf). If your computer does not have either Adobe Reader or Acrobat Reader installed, use the procedure below to install it.

Installing Adobe Reader (Acrobat Reader**)

- Place the CD-ROM that comes bundled with the digital piano into your computer's CD-ROM drive.
- On the CD-ROM, navigate to the folder named "Adobe", open the folder named "English", and then double-click "ar601enu.exe" ("ar505enu.exe"). Follow the instructions that appear on your computer screen to install Adobe Reader.

** Adobe Reader cannot be installed on a computer running Windows 98. If your computer is running under Windows 98, double-click "ar505enu.exe" to install Acrobat Reader.

Minimum Computer system Requirements

Supported Operating Systems

Operation is supported under Windows® XP, Windows® 2000, Windows® Me, Windows® 98SE, and Windows® 98.

● Universal

- IBM AT or compatible computer
- USB port that provides normal operation under Windows
- CD-ROM drive (for installation)
- At least 2MB of free hard disk space (not including space required for Adobe Reader)

● Windows XP

- 300MHz or higher Pentium processor
- At least 128MB of memory

● Windows 2000

- 166MHz or higher Pentium processor
- At least 64MB of memory

● Windows Me, Windows 98SE, Windows 98

- 166MHz or higher Pentium processor
- At least 32MB of memory

Driver Signing

● Windows XP

- 1 Log on to Windows XP using a Computer administrator account. See the documentation that comes with Windows XP for information about Computer administrator accounts.

- 2 On the Windows [Start] menu, click [Control Panel].
 - If you cannot see the [System] icon on the Control Panel, click [Switch to Classic View].

- 3 Click the [System] icon. On the dialog box that appears, click the [Hardware] tab, and then click the [Driver Signing] button.

- 4 On the dialog box that appears, select [Ignore], and then click [OK].

● Windows 2000

- 1 Log on using an Administrators group account. See the documentation that comes with Windows 2000 for information about the Administrators group.

- 2 On the Windows [Start] menu, point to [Settings] and then click [Control Panel].

- Click the [System] icon. On the dialog box that appears, click the [Hardware] tab, and then click the [Driver Signing] button.
- On the dialog box that appears, select [Ignore], and then click [OK].

NOTE

- Company and product names used herein are trademarks of their respective owners.

Using the USB port

Note that you need to purchase a commercially available USB cable to connect the digital piano to a computer using the USB port. Once you establish a USB connection between the digital piano and a computer, you can exchange data between them.

To connect to a computer using the USB port

- Use a commercially available USB cable to connect the digital piano to the computer.

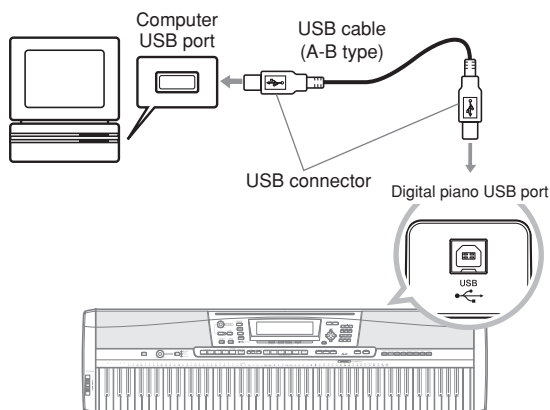

DATA ACCESS Lamp

- The DATA ACCESS lamp lights whenever the digital piano is exchanging data with a connected computer over a USB cable connection. Never disconnect the USB cable while the DATA ACCESS lamp is lit.

General MIDI

This digital piano supports General MIDI, so it can be used to play commercially available pre-recorded General MIDI data and General MIDI data sent to it from a personal computer.

See the separate **Appendix A** for details about the tones that are available with GM tones numbered 000 to 127.

MIDI Settings

You can use the parameter setting procedure (page E-68) to change the settings of the MIDI parameters described below. See pages E-68 to E-71 for details about the setting menu and procedure.

■ MIDI In Chord Judge

This parameter determines whether note data received from an external device should be interpreted as an auto accompaniment chord fingering. Turn on this parameter when you want to control auto accompaniment chords from a computer or other external device.

On: Causes note data input through USB port to be interpreted as auto accompaniment chord fingerings. The channel specified by the keyboard channel is used for specifying chords.

Off: Turns off "MIDI In Chord Judge".

■ Accomp/Song MIDI Out (Accompaniment/Song MIDI Out)

Turn on this parameter when you want sound auto accompaniment or Song Memory on an external devices sound source.

On: Outputs auto accompaniment or Song Memory as MIDI messages through the digital piano's USB port.

Off: Does not output auto accompaniment or Song Memory.

NOTE

- For detailed information about MIDI Implementation, visit the CASIO website at: <http://world.casio.com/>.



Internet Data Expansion System

The Music Data Management Software application on the CD-ROM that comes bundled with the digital piano lets you transfer data you downloaded from the CASIO MUSIC SITE from your computer to digital piano memory. You can also use it to save digital piano data to your computer's hard disk. Music Data Management Software supports transfer of the following type of data.

- SMF
- Rhythm Patterns
- Registrations
- User songs created in the Song Memory Mode
- Drum sounds with waveform
- Drawbar organ tones
- Tone
- Tones with waveforms
- DSP
- Package file
- All user data

CASIO MUSIC SITE

<http://music.casio.com/>

Music Data Management Software

Music Data Management Software makes it possible for your computer to transfer data you downloaded from the CASIO Music Site to digital piano memory, and to transfer digital piano memory data to your computer's hard disk for storage. After starting up the Music Data Management Software, you can access the following three converter applications.

■ Wave Converter

Wave Converter creates digital piano Tone With Wave data from tone data files (.wav) stored on your computer's hard disk.

■ Rhythm Converter

Rhythm Converter creates digital piano Rhythm data from SMF format rhythm data stored on your computer's hard disk.

■ Parameter Editor

Parameter Editor makes it possible to use your computer to edit digital piano parameters.

IMPORTANT!

- Never attempt to perform a data send or receive operation while the message "Pls Wait" is on the digital piano display screen.

■ To install the Music Data Management Software

- Before installing the Music Data Management Software, be sure to read the contents of the applicable readme.txt file. You can find the readme.txt file inside the same language folder where the Music Data Management Software you are installing is located.

1. To install the Music Data Management Software, navigate to the CD-ROM on your computer and double-click "ides40.exe". Next, follow the instructions that appear on your computer screen.

- * Application software documentation in various languages is available on the CD-ROM that comes bundled with the digital piano. See the folder for the particular language you want. You can access the manual by opening its HTML named "index.html" using one of the following types of web browser applications.

Internet Explorer 4 or higher
Netscape Navigator 4.04 or higher

- * Supported Computer Operating Systems

The Music Data Management Software will run under the following operating systems.

Windows 98SE
Windows Me
Windows 2000
Windows XP

IMPORTANT!

- Though Music Data Management Software is designed to run under the standard configurations of the above operating systems, note that it may not be able to run correctly under certain software and hardware environments.
- Music Data Management Software does not support operation on a Macintosh.

Downloading Data

Visit the CASIO MUSIC SITE for information about downloading data.

When you arrive at the CASIO MUSIC SITE, select a geographic area or country. Next, select an Internet Data Expansion System data download service.

Note that the services that are available at the CASIO MUSIC SITE depend on the area or country you select.

Bundled CD-ROM Data

The CD-ROM that comes bundled with the digital piano has a folder named "**DATAforPX**", which contains various data folders. For details about the data contained in the data folders, see the "list.txt" file inside of each folder.

■ Returning the digital piano to its initial factory defaults

The "**DATAforPX**" folder on the CD-ROM that comes bundled with the digital piano includes a file named "alldata.ckf", which contains factory default setup data. Transferring the "alldata.ckf" data to the digital piano's flash memory will return all settings to their initial factory defaults.

- For information about transferring data to the digital piano's flash memory, see the application software manual.

Saving Data

You can save data you create and data you transfer to the digital piano from a computer to the digital piano's built-in Flash memory, or to an SD memory card.

The types of files that can be saved to SD memory cards are listed below. Note that each type of file can be saved to a specific, pre-defined user area, as shown in the "Savable File Types" table below.

After you load SMF data from SD memory cards and store it in a user area, you can play it back using the SMF Player Mode. See "Using the SMF Player" on page E-72 for more information.

Savable File Types

Type	Display Indicator	Saved Data	User Area Number	User Memory Capacity	File Name Extension
SMF	Smf	1 Tune	000 – 199	200	MID
Rhythm Pattern	Pattern	1 Pattern	166 – 181	16	Z00
Registration	Regist	1 Bank	1 – 8	8	Z01
User song created in the Song Memory Mode	Song	1 Tune	0 – 4	5	Z02
Drum sound with waves	Dr wave	1 Set	900 – 903	4	Z03
Drawbar organ tone	Drawbar	1 Tone	100 – 199	100	Z04
Tone	Tone	1 Tone	700 – 799	100	Z05
Tone with waves	Tn wave	1 Tone	800 – 819	20	Z06
DSP	Dsp	1 Type	100 – 199	100	Z07
Package File*1	Package	1 Pack	—	1	Z08
All User Data*2	All Data	1 Set	—	1	Z09

*1: Package File

A package file combines tone settings, DSP effect settings, and other setup data into a single file that you can manage and load as a unit (package). Once you create a package file, you will be able to change the entire setup of the digital piano by loading a single package file.

*2: All of the user data (SMF to package file) in the above table can be handled as a single file.

Package File Data Contents

Data Type	User Area
SMF	190 to 199 (10 Songs)
Rhythm Patterns	174 to 181 (8 rhythms)
Registrations	7 to 8 (2 banks)
Drum Sound With Waves	903 (1 set)
Drawbar Organ Tones	190 to 199 (10 tones)
Tones	790 to 799 (10 tones)
Tones With Waves	810 to 819 (10 tones)
DSP	190 to 199 (10 effects)

IMPORTANT!

- Loading a package file loads the setting data listed in the table under "Package File Data Contents" into the user area, and replaces all current data with the data in the package file.
- When loading a package file or All Data from or writing such data to an SD memory card, the display's level meter shows the progress of the load/write operation as shown below.

[Start]

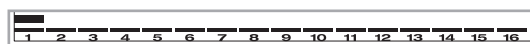

[End]



Using an SD Memory Card

Your digital piano is equipped with an SD memory card slot that supports the use of SD memory cards that you can use to store tunes you transfer from your computer, song memory data you have stored in the digital piano's flash memory, and other data. This provides you with access to virtually unlimited volumes of data that you can instantly load whenever you need it.



● Supported SD memory Cards:

1GB or less (Cards with capacity greater than 1GB are not supported.)

IMPORTANT!

- Use only an SD memory card with this digital piano. Proper operation is not guaranteed when any other type of card is used.

Memory Card and Card Slot Precautions

IMPORTANT!

- Be sure to carefully read all documentation that comes with the memory card for important information about how to handle it.
- SD memory cards have a write protect switch, which you can use to protect against accidental deletion of data. After saving important data to memory card, be sure to use the write protect switch to protect the data against accidental changes or deletion.
- Avoid storing and using memory cards in the following types of locations. Such conditions can cause corruption of data stored on the card.
 - Areas subject to high temperatures, high humidity, or corrosive agents
 - Areas subject to strong electrostatic charge or electrical noise
- Whenever handling a memory card, make sure that you never touch its contacts with your fingers.
- If the data access lamp is lit and the message "Pls Wait" is on the display, it means that data on the memory card is being accessed by a save, read, or delete operation. Never remove the memory card from the card slot or turn off the digital piano while the card is being accessed. Doing so can corrupt the data on the memory card or even damage the card slot.
- Never try to insert anything that is not an SD memory card into the digital piano's card slot. Doing so can cause malfunction of the digital piano.
- Inserting a memory card that is charged with static electricity into the card slot can cause malfunction of the digital piano. If this happens, turn the digital piano off and then back on again.

- A memory card that has been in the card slot for a long time may feel hot when you remove it. This is normal and does not indicate malfunction.
- Note that a memory card has a limited service life. After long use, you may not be able to store data to, read data from, and/or delete data from a card. When this happens, you will need to purchase a new memory card.

CASIO COMPUTER CO., LTD. assumes no responsibility for any loss or damage to you or any third party arising out of the loss or corruption of data.

Using an SD Memory Card with the Digital Piano

When using a memory card with the digital piano, first be sure to format the card on the digital piano. See "Formatting an SD Memory Card" on page E-86 for details about formatting.

Inserting and Removing a Memory Card

IMPORTANT!

- Be sure to orient the memory card correctly when inserting it. Never try to force a memory card into the card slot when you feel resistance.
- Never remove the memory card from the card slot or turn off the digital piano while card data is being accessed by a save, read, or delete operation. Doing so can corrupt the data on the memory card or even damage the card slot.

To insert a memory card into the card slot

- 1 With the front side of the memory card facing upwards, carefully slide it into the card slot. Slide the card all the way in until you hear it click securely into place.

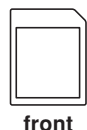
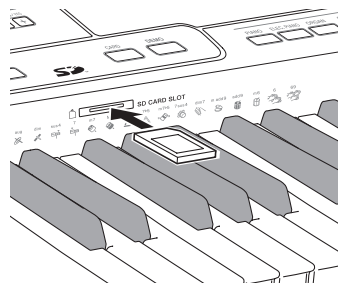

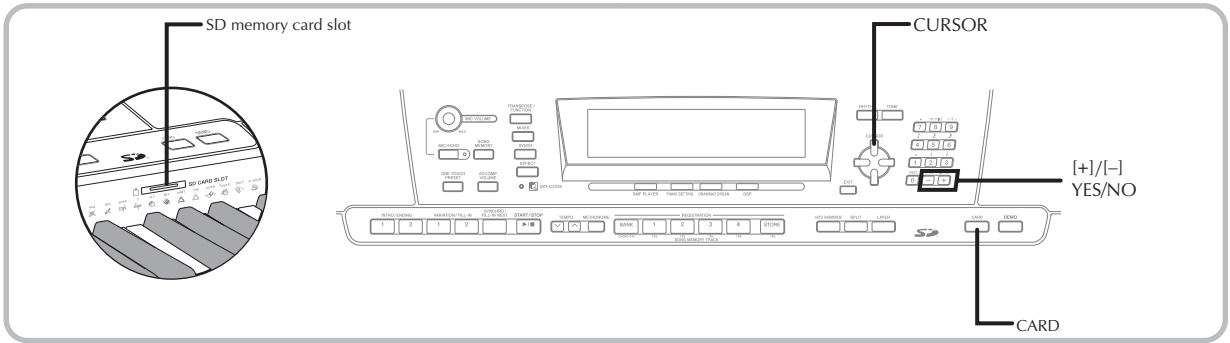

To remove a memory card from the card slot

- 1 Press the memory card into the card slot and then release it.
 - This will cause the card to come part way out of the digital piano.
- 2 Pull the memory card out of the card slot.
 - After making sure that the data access lamp is not lit, carefully pull the memory card from the card slot.*
 - * Never remove the memory card from the card slot or turn off the digital piano while any of the following conditions exists.
 - While the digital piano is in the SMF Player Mode and the CARD indicator is on the display
 - While the data access lamp is lit and the message "Pls Wait" is on the display, indicating that a card access operation is being performed

Basic Memory Card Operation

- 1 Insert the memory card into the card slot.
- 2 Press the CARD button.
 - This causes the CARD indicator to appear on the display, and also displays "Card" in the display's text area.
- 3 Press the [▼] CURSOR button to display the Card Mode menu.

- 4 Use the [◀] and [▶] CURSOR buttons to display the screen for the type of operation you want to perform.

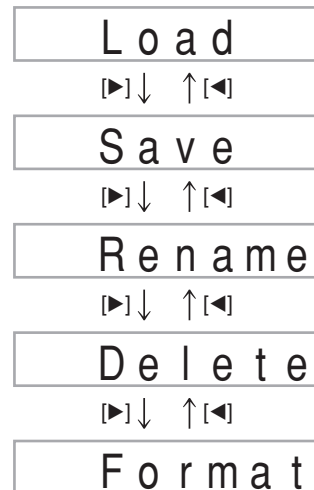

- See the pages referenced below for details about using each of the above menu operations.

Loading a file (Crd Load):	page E-84
Saving a file (Crd Save):	page E-83
Renaming a file (Crd Rename):	page E-85
Deleting a file (Crd Delete):	page E-86
Formatting an SD memory card (Crd Format):	page E-86

- 5 Press the [▼] CURSOR button to advance to the next operation screen of each menu.

NOTE

- Layer, split, and Auto Harmonize are automatically turned off while the memory card is being used. Tone and rhythm selection, and rhythm playback are also all disabled.

Saving Files

You can use the procedures in this section to save Song Memory, Synthesizer, and other data you create to SD memory cards for later loading when you need it. See “Savable File Types” on page E-80 for information about the type of data you can save.

PREPARATION

- Insert a memory card that has been formatted on the digital piano into the digital piano’s card slot. Make sure that the write-protect switch of the memory card is not in the write-protect position.

NOTE

- Depending on the type and the amount of data involved, a data save or load operation can take anywhere from a few minutes to more than 30 minutes to complete. The message “Pls Wait” will remain on the display to indicate that a data save or load operation is being performed.

IMPORTANT!

- Never try to perform any operation while “Pls Wait” is displayed. Performing any operation can cause Flash memory, or memory card data to be deleted, and damage the digital piano’s memory and cause it to malfunction.

To save a file to a memory card

- 1 Press the CARD button.
 - This causes the CARD indicator to appear on the display, and also displays “Card” in the display’s text area.
- 2 Press the [▼] CURSOR button to display the Card Mode menu.
- 3 Use the [◀] and [▶] CURSOR buttons to display the “Save” screen.
- 4 Press the [▼] CURSOR button to advance to the file type selection screen.
- 5 Use the [◀] and [▶] CURSOR buttons to select the file type.
- 6 Press the [▼] CURSOR button to advance to the user area selection screen.

- 7 Use the [◀] and [▶] CURSOR buttons or [+] and [-] buttons to select the user area where the file you want to save is located.

- The numeric area of the display will show the user area number, while the text area will show the user area name*.
 - * Except registrations and user songs
- Pressing the EXIT or [▲] CURSOR button at this time will return you to the file type selection screen.
- The user area selection screen will not appear if the file you selected is a package file or “All Data” file. In this case, skip this step and go directly to screen.

- 8 Press the [▼] CURSOR button to advance to the file name input screen.

Initial file name displayed on the screen

Rhythm Patterns	U_PTRN00
Registrations	U_RGST00
User Songs Created in the Song Memory Mode	U_SONG00
Drum Sounds with Waveform	U_DRUM00
Drawbar Organ Tones	U_ORGN00
Tones	U_TONE00
Tones with Waveforms	U_TONW00
DSP	U_EFCT00
Package File	PACKAGE0
All User Data	ALLDATA0

- The initial default file name of the SMF will be the same as the name of the user area you selected in step 7.
 - Use the [+] and [-] buttons to scroll through letters at the current cursor location. See the page E-87 for information about inputting text.
 - Use the [◀] and [▶] CURSOR buttons to move the cursor left and right.
- 9 After inputting the file name, press the [▼] CURSOR button.
 - If you are saving song data, the file type selection screen appears next. Use the [◀] and [▶] CURSOR buttons to select “SMF” or “SONG”. After selecting a file type, press the [▼] CURSOR button.
 - This will display a confirmation message asking whether you really want to save the data. If the media already contains a file with the same name, a confirmation message appears asking if you want to overwrite the existing file with a new one.

10 Press the YES button to save the data. This will cause the message “Pls Wait” to appear on the display to indicate that a memory card access operation is being performed. Never try to perform any other operation on the digital piano while the memory card is being accessed. The message “Complete” will appear on the display after data save is complete. After a few seconds, the message will be replaced by the file name selection screen.

- If you do not want to continue with data save, press the EXIT button or the NO button in response to the above confirmation message. This will return you to the user area selection screen in step 7.

11 After you are finished performing the save operation, press the CARD button to exit the Card Mode.

Loading a File

Use the procedures in this section when you want to load data from an SD memory card into the digital piano’s user area.

IMPORTANT!

- Note the following important points whenever using the SMF Player Mode to play back data saved with the above procedure.

* To perform the procedure below, you must have an SD memory card to which SMF data has been copied from a computer. Insert an SD memory card that you have formatted on the digital piano into the card slot of your computer, and copy the SMF data you want to load into the directory named “MUSICDAT”. Note that you will not be able to load the data if it is not located inside the “MUSICDAT” directory. If you create a sub-directory inside of the “MUSICDAT” directory, the digital piano will not be able to load any data inside the sub-directory.

PREPARATION

- Insert the SD memory card that contains the data you want to load into the digital piano’s card slot.

NOTE

- Depending on the type and the amount of data involved, a data save or load operation can take anywhere from a few minutes to more than 30 minutes to complete. The message “Pls Wait” will remain on the display to indicate that a data save or load operation is being performed.

IMPORTANT!

- Never try to perform any operation while “Pls Wait” is displayed. Performing any operation can cause Flash memory, or memory card data to be deleted, and damage the digital piano’s memory and cause it to malfunction.

To recall file data from an SD memory card

- 1** Press the CARD button.
 - This causes the CARD indicator to appear on the display, and also displays “Card” in the display’s text area.
- 2** Press the [▼] CURSOR button to display the Card Mode menu.
- 3** Use the [◀] and [▶] CURSOR buttons to display the “Load” screen.
- 4** Press the [▼] CURSOR button to advance to the file type selection screen.
- 5** Use the [◀] and [▶] CURSOR buttons to select the type file you want to load.
- 6** Press the [▼] CURSOR button to display the file name selection screen.
- 7** Use the [◀] and [▶] CURSOR buttons or [+] and [–] buttons to select the name of the file you want to load.
 - You could also use the number buttons to input a three-digit file number. The file number is shown in the number area of the display.
- 8** Press the [▼] CURSOR button to advance to the user area selection screen.
- 9** Use the [◀] and [▶] CURSOR buttons or [+] and [–] buttons to select the user area to which you want to import the loaded file data.
 - The numeric area of the display will show the user area number, while the text area will show the user area name*.
 - * Except registrations and user songs
 - The user area selection screen will not appear if the file you selected is a package file or “All Data” file. In this case, skip step 9 and go directly to step 10.
 - Pressing the EXIT or [▲] CURSOR button at this time will return you to the file type selection screen.

- 10 After selecting the user area, press the [▼] CURSOR button.
 - This will display a confirmation message asking whether you really want to load the data. If you already have data in the user area, the message will ask if you want to overwrite the existing data with the loaded data.
- 11 Press the YES button to recall the data.
 - This will cause the message “Pls Wait” to appear on the display to indicate that a card access operation is being performed. Never try to perform any other operation on the digital piano while the card is being accessed. The message “Complete” will appear on the display after data loading is complete. After a few seconds, the message will be replaced by the file name selection screen.
 - If you do not want to continue with data loading, press the EXIT button or the NO button in response to the above confirmation message. This will return you to the user area selection screen in step 9.
- 12 After you are finished performing the load operation, press the CARD button to exit the Card Mode.

Renaming a File

You can use the procedures in this section to change the name of a file that you previously saved to the SD memory card.

PREPARATION

- Insert the SD memory card that contains the file you want to rename into the digital piano’s card slot. Make sure that the write-protect switch of the memory card is not in the write-protect position.

To rename a file saved to the SD memory card

- 1 Press the CARD button.
 - This causes the CARD indicator to appear on the display, and also displays “Card” in the display’s text area.
- 2 Press the [▼] CURSOR button to display the Card Mode menu.
- 3 Use the [◀] and [▶] CURSOR buttons to display the “Rename” screen.
- 4 Press the [▼] CURSOR button to advance to the file type selection screen.
- 5 Use the [◀] and [▶] CURSOR buttons to select the type of the file you want to rename.
- 6 Press the [▼] CURSOR button to display the file name selection screen.
- 7 Use the [◀] and [▶] CURSOR buttons or [+] and [–] buttons to select the name of the file you want to rename.
 - You could also use the number buttons to input a three-digit file number. The file number is shown in the number area of the display.
- 8 Press the [▼] CURSOR button to advance to the file name input screen.
 - Use the [+] and [–] buttons to scroll through letters at the current cursor location. See the page E-87 for information about inputting text.
 - Use the [◀] and [▶] CURSOR buttons to move the cursor left and right.
- 9 After inputting the file name, press the [▼] CURSOR button.
 - This will display a confirmation message asking whether you really want to change the name.
- 10 Press the YES button to change the file name.
 - This will cause the message “Pls Wait” to appear on the display to indicate that a card access operation is being performed. Never try to perform any other operation on the digital piano while the card is being accessed. The message “Complete” will appear on the display after renaming is complete. After a few seconds, the message will be replaced by the file name selection screen.
 - If you do not want to continue with file renaming, press the EXIT button or the NO button in response to the above confirmation message. This will return you to the file selection screen.
- 11 After you are finished performing the rename operation, press the CARD button to exit the Card Mode.

Deleting a File

You can perform the procedure in this section to delete a file from the SD memory card.

IMPORTANT!

- Note that the file delete operation cannot be undone. Make sure that you no longer need data before you delete it.
 - Deleting a file causes all of the file numbers following it to be reduced by one. If you plan to delete another file, make sure that you do not specify the wrong file number.
-

PREPARATION

- Insert the SD memory card that contains the file you want to delete into the digital piano's card slot. Make sure that the write-protect switch of the memory card is not in the write-protect position.
-

To delete a file from the SD memory card

- 1 Press the CARD button.
 - This causes the CARD indicator to appear on the display, and also displays "Card" in the display's text area.
- 2 Press the [▼] CURSOR button to display the Card Mode menu.
- 3 Use the [◀] and [▶] CURSOR buttons to display the "Delete" screen.
- 4 Press the [▼] CURSOR button to advance to the file type selection screen.
- 5 Use the [◀] and [▶] CURSOR buttons to select the type of the file you want to delete.
- 6 Press the [▼] CURSOR button to display the file name selection screen.
- 7 Use the [◀] and [▶] CURSOR buttons or [+] and [-] buttons to select the name of the file you want to delete.
 - You could also use the number buttons to input a three-digit file number. The file number is shown in the number area of the display.
- 8 After selecting the file, press the [▼] CURSOR button.
 - This will display a confirmation message asking whether you really want to delete the file.

- 9 Press the YES button to delete the file.
 - This will cause the message "Pls Wait" to appear on the display to indicate that a card access operation is being performed. Never try to perform any other operation on the digital piano while the card is being accessed. The message "Complete" will appear on the display after file deletion is complete. After a few seconds, the message will be replaced by the file name selection screen.
 - If you do not want to continue with file deletion, press the EXIT button or the NO button in response to the above confirmation message. This will return you to the file name selection screen.
- 10 After you are finished performing the delete operation, press the CARD button to exit the Card Mode.

Formatting an SD Memory Card

Use the procedures in this section to format an SD memory card before using it for the first time, or when you want to delete all of the contents on a memory card.

IMPORTANT!

- Before performing the procedure below, check to make sure that the media does not contain any data you might need.
 - The SD memory card format operation performed by your digital piano is a "quick format". If you want to completely delete all of the data on the card, format it on you computer or using some other device.
-

PREPARATION

- Insert the SD memory card you want to format into the digital piano's card slot. Make sure that the write-protect switch of the memory card is not in the write-protect position.
-

To format an SD memory card

- 1 Press the CARD button.
 - This causes the CARD indicator to appear on the display, and also displays “Card” in the display’s text area.
- 2 Press the [▼] CURSOR button to display the Card Mode menu.
- 3 Use the [◀] and [▶] CURSOR buttons to display the “Format” screen.
- 4 Press the [▼] CURSOR button.
 - This will display a confirmation message asking whether you really want to format the media.
- 5 Press the YES button to start formatting.
 - This will cause the message “Pls Wait” to appear on the display to indicate that a card access operation is being performed. Never try to perform any other operation on the digital piano while the card is being accessed. The message “Complete” will appear on the display after media formatting is complete. After a few seconds, the message will be replaced by the screen for the type of operation.
 - If you do not want to continue with formatting, press the EXIT button or the NO button in response to the above confirmation message. This will return you to the screen for the type of operation.
- 6 After you are finished performing the format operation, press the CARD button to exit the Card Mode.

Inputting Characters

The following describes the types of characters you can input when saving data to the user area and an SD memory card.

User Area Data

!	"	#	\$	%	&	'	()	
*	+	,	-	.	/	0	1	2	3
4	5	6	7	8	9	:	;	<	=
>	?	@	A	B	C	D	E	F	G
H	I	J	K	L	M	N	O	P	Q
R	S	T	U	V	W	X	Y	Z	[
¥]	^	_	`	a	b	c	d	e
f	g	h	i	j	k	l	m	n	o
p	q	r	s	t	u	v	w	x	y
z	{		}						

SD Memory Card Data

You can input the same characters as those that are allowed for MS-DOS file names.

0	1	2	3	4	5	6	7	8	9
A	B	C	D	E	F	G	H	I	J
K	L	M	N	O	P	Q	R	S	T
U	V	W	X	Y	Z	\$	&	_	'
()	-	^	{	}	@	~	`	

SD Memory Card Error Messages

Display Message	Cause	Action
Err Card R/W	There is something wrong with the memory card.	Use a different memory card.
Err CardFull	The memory card is full.	<ol style="list-style-type: none"> 1. Use a different memory card. 2. Delete files you no longer need from the memory card (page E-86).
Err No Card	<ol style="list-style-type: none"> 1. The memory card is not set correctly in the card slot. 2. There is no memory card in the card slot or the memory card was removed part way through a card access operation. 	<ol style="list-style-type: none"> 1. Remove the memory card and reinsert it correctly (page E-81). 2. Insert a memory card into the card slot. Never remove a memory card from the card slot while a card access operation is in progress.
Err No Data	You are attempting to save data to an SD memory card while a digital piano user area that does not contain any data is selected.	Select a digital piano user area that contains data.
Err Name	<ol style="list-style-type: none"> 1. A file with the same name as the one you are trying to use already exists. 2. You are trying to use a file name that is not allowed by MS-DOS. 	<ol style="list-style-type: none"> 1. Use a different name (page E-85). 2. Name files using the allowable characters (page E-87).
Err ReadOnly	Attempt to save a file using the same name as an existing file that is read only.	Save the new file to a different card or use another name.
Err Format	<ol style="list-style-type: none"> 1. The format of the memory card is not compatible with this digital piano. 2. The memory card is not formatted. 3. The memory card is damaged. 	<ol style="list-style-type: none"> 1. Change to a memory card that has the proper format. E-81 2. Format the memory card. E-86 3. Use a different memory card.
Err Mem Full	Digital piano memory became full while importing data from a memory card.	<ol style="list-style-type: none"> 1. Delete any SMF data, waveform data, or accompaniment data that you no longer need from the keyboard's memory to free up keyboard flash memory space. E-71 2. If you have song data stored in Song Memory (SG0 to 4), delete the song data you no longer need. E-62
Err Not SMF0	The file you are reading is not an SMF 0 format file.	Use SMF 0 format files only.
Err No File	<ol style="list-style-type: none"> 1. The digital piano cannot find any file it can read on the memory card. 2. You are trying to store an SMF to an SD memory card when there is no SMF in digital piano memory. 	<ol style="list-style-type: none"> 1. Use a memory card that contains data stored by this digital piano or compatible data from another device. 2. —
Err Protect	The memory card is write protected.	<ol style="list-style-type: none"> 1. Use a different memory card. 2. Adjust the memory card's write protect switch to enable data storage. E-81
Err Convert	There is not enough unused memory available to save data produced by converting song data from SONG format to SMF format.	Delete any SMF data, waveform data, or accompaniment data that you no longer need from the keyboard's memory to free up keyboard flash memory space (page E-71).
Err WrongDat	The data on the memory card is corrupted.	Use other data or another memory card.

Troubleshooting

Problem	Possible Cause	Action	See page
No digital piano sound	<ol style="list-style-type: none"> 1. Power supply problem. 2. Power is not turned on. 3. Volume setting is too low. 4. Playing in the accompaniment digital piano area while the MODE button setting is CASIO CHORD or FINGERED. 5. Local Control is off. 6. Mixer channel 1 is turned off. 7. Mixer channel 1 volume setting is too low. 8. The DSP volume parameter is set too low. 9. The Expression value of the file data played back on the SMF player is too low. 	<ol style="list-style-type: none"> 1. Correctly attach the AC adaptor. 2. Press the POWER button to turn on power. 3. Use the MAIN VOLUME knob to increase volume. 4. None of the accompaniment mode indicators are lit, which means Auto Accompaniment is turned off. 5. Turn on Local Control. 6. Use the Mixer to turn channel 1 on. 7. Use the Mixer to raise the volume setting for channel 1. 8. Increase the DSP parameter value. 9. Exit then re-enter the SMF Player Mode, or change the SMF Player play-along part. 	<p>E-14 E-18</p> <p>E-18</p> <p>E-31</p> <p>E-71 E-39</p> <p>E-40</p> <p>E-26</p> <p>E-72</p>
Auto Accompaniment does not sound.	<ol style="list-style-type: none"> 1. Accompaniment volume is set to 000. 2. Auto Accompaniment part Channels 6 through 10 are turned off. 3. Auto Accompaniment part Channels 6 through 10 volume setting is too low. 	<ol style="list-style-type: none"> 1. Use the ACCOMP VOLUME button to increase the volume. 2. Use the Mixer to turn the channels on. 3. Use the Mixer to raise the volume setting for the applicable channel. 	<p>E-37</p> <p>E-39</p> <p>E-40</p>
Sound output does not change when key pressure is varied.	Touch response is turned off.	Press the TRANSPOSE/FUNCTION button to turn it on.	E-66
Playing the digital piano sounds two tones.	Layer is turned on.	Press the LAYER button to turn off layering.	E-63
Different tones sound when keys in different digital piano ranges are pressed.	Split is turned on.	Press the SPLIT button to turn off split.	E-64
The key or tuning does not match when playing along with another MIDI machine.	<ol style="list-style-type: none"> 1. The tuning or transpose parameter is set to a value other than 00. 2. Mixer coarse tune, fine tune, and/or octave shift settings are values other than 00. 	<ol style="list-style-type: none"> 1. Change the transpose or tuning parameter value to 00. 2. Use the Mixer to change the coarse tune, fine tune, and/or octave shift settings to 00. 	<p>E-66, 67</p> <p>E-41</p>
Parts suddenly drop out during song memory playback.	The number of tones being played at the same time exceeds the digital piano's limitation.	Use the Mixer to turn unneeded channels off and decrease the number of parts being played.	E-39
Some parts do not play at all during song memory playback.	<ol style="list-style-type: none"> 1. Channels are turned off. 2. Volume setting is too low. 	<ol style="list-style-type: none"> 1. Use the Mixer to turn channels on. 2. Use the Mixer to check the volume setting. 	<p>E-39</p> <p>E-40</p>

Problem	Possible Cause	Action	See page
Nothing happens when the LAYER or SPLIT button is pressed.	<ol style="list-style-type: none"> 1. One or more of the melody channels (2 through 4) is turned off. 2. The volume setting of one or more of the melody channels (2 through 4) is too low. 3. The digital piano is in record standby. 4. The SMF Player Mode is currently being use. 	<ol style="list-style-type: none"> 1. Use the Mixer to turn on Channels 2 through 4. 2. Use the Mixer to raise the volume setting of Channels 2 through 4. 3. The LAYER and SPLIT buttons are disabled during recording and record standby. 4. Turn off the SMF Player Mode. LAYER and SPLIT are not available while the SMF Player Mode is in use. 	<p>E-39</p> <p>E-40</p> <p>E-63, 64</p> <p>E-72</p>
No sound is produced when playing MIDI data from a computer.	<ol style="list-style-type: none"> 1. USB cable is not connected properly. 2. Channel is turned off, or volume setting is too low. 	<ol style="list-style-type: none"> 1. Connect USB cable properly. 2. Use the Mixer to turn the channel on, or raise the volume setting. 	<p>E-78</p> <p>E-39, 40</p>
Playing on the digital piano produces an unnatural sound when connected to a computer.	The computer's MIDI Thru function is turned on.	Turn off the MIDI Thru function on the computer or turn off Local Control on the digital piano.	E-71
Cannot record chord accompaniment data on a computer.	Accomp/Song MIDI Out is turned off.	Turn on Accomp/Song MIDI Out.	E-71
The digital piano starts up abnormally when it is turned on.	<ol style="list-style-type: none"> 1. Flash memory is corrupted. There is something wrong with the card. 2. The digital piano detected abnormal flash memory data and is automatically resetting the digital piano system. 	<ol style="list-style-type: none"> 1. a. Disconnect the AC adaptor and press the POWER button. b. Reconnect the AC adaptor, and then press the POWER button again to turn on power. c. Use the TRANSPOSE/FUNCTION button to perform the system reset operation. <ul style="list-style-type: none"> • If this does not solve the problem, contact your nearest authorized CASIO Service Provider to request repair. 2. Wait (about 40 seconds) until the "Pls Wait" message disappears from the display. 	<p>E-14</p> <p>E-71</p>
A downloaded tone with waveform contains noise or digital piano operations become abnormal when user data is selected.	Someone may have turned off the digital piano while data was being stored in Flash memory or something else has caused Flash memory contents to become corrupted for some reason.	Use the TRANSPOSE/FUNCTION button to perform the system reset operation. If this does not correct the problem, contact your nearest authorized CASIO Service Provider to request maintenance.	E-71



Problem	Possible Cause	Action	See page
Cannot save data to an SD memory card.	<ol style="list-style-type: none"> 1. The memory card is write-protected. 2. The memory card is not inserted correctly into the card slot. 3. There is not enough space left on the memory card . 4. You are trying to use a memory card whose capacity is not supported by this digital piano. 5. The memory card is damaged. 	<ol style="list-style-type: none"> 1. Adjust the memory card’s write protect switch to enable data storage. 2. Correctly insert the memory card into the card slot. 3. Use a different memory card or delete files you no longer need from the memory card you are using. 4. Use only a memory card of the capacity specified for this digital piano. 5. Use a different memory card . 	<p>E-81</p> <p>E-81</p> <p>E-86</p> <p>E-81</p>
Cannot recall data from an SD memory card.	<ol style="list-style-type: none"> 1. The memory card is not inserted correctly into the card slot. 2. There is not enough space available in the area into which you are trying to import the data. 3. You are trying to use a memory card whose capacity is not supported by this digital piano. 4. The memory card is damaged. 	<ol style="list-style-type: none"> 1. Correctly insert the memory card into the card slot. 2. Delete rhythm, SMF, or tone with wave data currently in the digital piano’s Flash memory to make room for the imported data. 3. Use only a memory card of the capacity specified for this digital piano. 4. Use a different memory card. 	<p>E-81</p> <p>E-71</p> <p>E-81</p>
After transferring song data from my computer, playback stops part way through.	Digital noise from the USB cable or power cord caused data communication between your computer and digital piano to be interrupted.	Stop playback, disconnect the USB cable from and then reconnect it to the digital piano’s USB port, and then try playing back the tune again. If this does not correct the problem, exit the MIDI software you are using, and then disconnect the USB cable from and then reconnect it to the digital piano’s USB port. Next, restart your MIDI software and try playback again.	E-78
A tone’s quality and volume sounds slightly different depending where it is played on the digital piano.	<p>This is an unavoidable result of the digital sampling process,* and does not indicate malfunction.</p> <p>* Multiple digital samples are taken for the low range, middle range, and high range of the original musical instrument. Because of this, there may be a very slight difference in tonal quality and volume between sample ranges.</p>		

Specifications

Models:	PX-410R/PX-575R												
Keyboard:	88 keys with touch response (Off/1/2/3)												
Tones:	400 Advanced Tones + 200 Preset Tones + 20 Drum Sets + 100 standard user tones + 20 user tones with waves*1 + 4 user drum sets with waves*1 + 50 drawbar organ tones + 100 user drawbar organ tones (894 tones total); layer/split												
Polyphony:	32 notes maximum (10 for certain tones)												
Drawbar Organ Function Drawbars: Percussion: Click:	9 (16', 5 1/3', 8', 4', 2 2/3', 2', 1 3/5', 1 1/3', 1') Second, Third On, Off												
Effects:	DSP (200 types: internal, 100 user areas) + Reverb (16 types) + Chorus (16 types) + Equalizer (10 types, 4 bands)												
Auto Accompaniment Rhythm Patterns: Tempo: Chords: Rhythm Controller: Accomp Volume: One-touch Presets: Auto Harmonize: Metronome:	182 (internal, 16 user areas*1) Variable (226 steps, ♩ = 30 to 255) 3 fingering methods (CASIO CHORD, FINGERED, FULL RANGE CHORD) START/STOP, INTRO/ENDING 1 and 2, VARIATION/FILL-IN 1 and 2, SYNCHRO/FILL-IN NEXT 0 to 127 (128 steps) Recalls settings for tone, tempo, layer on/off, and harmonize on/off in accordance with rhythm. 10 types Time Signatures: 0, 2, 3, 4, 5, 6												
Memory Function Songs: Recording Tracks: Recording Methods: Memory Capacity: Edit Function:	5 6 (2 through 6 are melody tracks) Real-time, step Approximately 10,000 notes (total for 5 songs) Equipped												
Demo Tunes:	3 <table border="1" data-bbox="488 1290 1263 1425"> <thead> <tr> <th>Tune Number</th> <th>Name</th> <th>Composer</th> </tr> </thead> <tbody> <tr> <td>0</td> <td>Toboggan Run</td> <td>TECH-NOTE INTERNATIONAL LTD.</td> </tr> <tr> <td>1</td> <td>Snow-water</td> <td>Akiko Fujimoto</td> </tr> <tr> <td>2</td> <td>Malibu Sun</td> <td>TECH-NOTE INTERNATIONAL LTD.</td> </tr> </tbody> </table>	Tune Number	Name	Composer	0	Toboggan Run	TECH-NOTE INTERNATIONAL LTD.	1	Snow-water	Akiko Fujimoto	2	Malibu Sun	TECH-NOTE INTERNATIONAL LTD.
Tune Number	Name	Composer											
0	Toboggan Run	TECH-NOTE INTERNATIONAL LTD.											
1	Snow-water	Akiko Fujimoto											
2	Malibu Sun	TECH-NOTE INTERNATIONAL LTD.											
Synthesizer Function Parameters:	Attack time; release time; resonance; cutoff frequency; vibrato type; vibrato delay; vibrato depth; vibrato rate; octave shift; level; touch sense; reverb send; chorus send; DSP line; DSP type; DSP parameter												

*1 The same memory area is used to store waveform data, accompaniment data, and SMF data.



Registration Memory Number of Setups: Memory Contents:	32 (4 setups × 8 banks) Tone, Rhythm, Tempo, Layer on/off, Split on/off, Split point, Harmonize on/off, Mixer settings (Channels 1 to 10), Effect settings, Touch Response settings, Soft/sostenuto pedal jack setting, Transpose, Tuning, Accompaniment volume setting, Pitch bend range, Auto Harmonize type, MODE button setting, Synchro standby state, Mixer Hold, DSP Hold, Synthesizer Mode parameters
Mixer Function Channels: Parameters:	16 Tone; part on/off; volume; pan pot; octave shift; coarse tune; fine tune; reverb send; chorus send; DSP line; DSP level, DSP pan, DSP system reverb send, DSP system chorus send
MIDI:	16 multi-timbre receive, GM Level 1 standard
Other Functions Pitch Bend Range: Transpose: Tuning: LCD:	Adjustable (12 semitones upwards and downwards) 49 steps (-24 semitones to +24 semitones) Variable (A4 = approximately 440Hz ±100 cents) Adjustable contrast
SMF Player: Supported Format:	Flash memory storage for up to 200 files* ¹ SMF0
Flash Memory Capacity: Shared Area:	4MB* ² Approximately 3.5MB* ² (waveform data, accompaniment data, SMF data) Further storage of waveform, accompaniment, and SMF data becomes impossible after the total of such data reaches approximately 3.5MB.
SD Memory Cards Supported SD Memory Cards: Functions:	1GB or less (Cards with capacity greater than 1 GB are not supported.) Save and load of data; playback of SMF; card formatting; file delete; file rename
Pedals:	Damper, Soft/Sostenuto (Selectable)
Terminals SD CARD SLOT USB port: Headphones: Pedal: Power: Microphone In: Pedal connector (for optional SP-30 only)	TYPE B Stereo standard jacks × 2 Output Impedance: 170Ω Output Voltage: 6.0V (RMS) MAX Standard jacks × 2 12V DC Standard jack (with microphone volume knob) Input impedance: 3.3KΩ Input sensitivity: 10mV
Speakers:	(16cm × 8cm OVAL) × 2 + Ø5cm × 2 (Output: 8.0W + 8.0W)

*1 The same memory area is used to store waveform data, accompaniment data, and SMF data.

*2 Noted capacities are calculated values based on 1MB = 1024² bytes.



Specifications

Power Supply:	AC Adaptor: AD-12
Power Consumption:	12V --- 18W
Dimensions:	134.4 × 34.9 × 15.5cm (52 ¹⁵ / ₁₆ × 13 ³ / ₄ × 6 ¹ / ₈ inch)
Weight:	Approximately 16.7 kg (36.8 lbs)



Care of your Instrument

Avoid heat, humidity or direct sunlight.

Do not overexpose the instrument to direct sunlight, or place it near an air conditioner, or in any extremely hot place.

Do not use near a TV or radio.

This instrument can cause video or audio interference with TV and radio reception. If this happens, move the instrument away from the TV or radio.

Do not use lacquer, thinner or similar chemicals for cleaning.

Clean the instrument with a soft cloth dampened in a weak solution of water and a neutral detergent. Soak the cloth in the solution and squeeze until it is almost dry.

Avoid use in areas subjected to temperature extremes.

Extremely high or low temperature can cause figures on the LCD screen to become dim and difficult to read. This condition should correct itself when the instrument is brought back to normal temperature.

NOTE

- You may notice lines in the finish of the case of this instrument. These lines are a result of the molding process used to shape the plastic of the case. They are not cracks or breaks in the plastic, and are no cause for concern.
-

MIDI messages that can be sent and received using the USB port

Version: 1.0

Function ...	Transmitted	Recognized	Remarks
Basic Channel Default Changed	1-16 1-16	1-16 1-16	
Mode Default Messages Altered	Mode 3 X *****	Mode 3 X *****	
Note Number True voice	21-108 *****	0-127 0-127 *1	*1: Depends on tone
Velocity Note ON Note OFF	0 9nH V = 1-127 X 9nH V = 0	0 9nH V = 1-127 X	
After Touch Key's Ch's	X X	X O	
Pitch Bender	O	O	
Control Change	0, 32 1 6, 38 7 10 11 16 17 18 19 64 66 67 71 72 73	O O X O O O X O O O O O O O O O O O O O O O O O O	Bank select Modulation Data entry Volume Pan Expression DSP Parameter0 DSP Parameter1 DSP Parameter2 DSP Parameter3 Hold1 Sostenuto Soft pedal Resonance Release Time Attack Time

74		<input type="radio"/>	<input type="radio"/>		<input type="radio"/>	
76		<input type="radio"/>	<input type="radio"/>		<input type="radio"/>	
77		<input type="radio"/>	<input type="radio"/>		<input type="radio"/>	
78		<input type="radio"/>	<input type="radio"/>		<input type="radio"/>	
80		<input type="radio"/>	<input type="radio"/>		<input type="radio"/>	
81		<input type="radio"/>	<input type="radio"/>		<input type="radio"/>	
82		<input type="radio"/>	<input type="radio"/>		<input type="radio"/>	
83		<input type="radio"/>	<input type="radio"/>		<input type="radio"/>	
91		<input type="radio"/>	<input type="radio"/>		<input type="radio"/>	
93		<input type="radio"/>	<input type="radio"/>		<input type="radio"/>	
98,99		<input type="radio"/>	<input type="radio"/>		<input type="radio"/>	
100,101		<input type="radio"/>	<input type="radio"/>		<input type="radio"/>	
120		<input type="radio"/>	<input type="radio"/>		<input type="radio"/>	
121		<input checked="" type="radio"/>	<input checked="" type="radio"/>		<input type="radio"/>	
	Program Change	: True #	<input type="radio"/>	O 0-127	<input type="radio"/>	O 0-127
			<input type="radio"/>	*****	<input type="radio"/>	*****
	System Exclusive		<input type="radio"/>		<input type="radio"/>	
	System Common	: Song Pos	<input checked="" type="radio"/>		<input checked="" type="radio"/>	<input checked="" type="radio"/>
		: Song Sel	<input checked="" type="radio"/>		<input checked="" type="radio"/>	<input checked="" type="radio"/>
		: Tune	<input checked="" type="radio"/>		<input checked="" type="radio"/>	<input checked="" type="radio"/>
	System Real Time	: Clock	<input type="radio"/>		<input checked="" type="radio"/>	<input checked="" type="radio"/>
		: Commands	<input type="radio"/>		<input checked="" type="radio"/>	<input checked="" type="radio"/>
	Aux Messages	: Local ON/OFF	<input checked="" type="radio"/>		<input checked="" type="radio"/>	<input checked="" type="radio"/>
		: All notes OFF	<input checked="" type="radio"/>		<input type="radio"/>	<input type="radio"/>
		: Active Sense	<input checked="" type="radio"/>		<input type="radio"/>	<input type="radio"/>
		: Reset	<input checked="" type="radio"/>		<input checked="" type="radio"/>	<input checked="" type="radio"/>
	Remarks		*2 In accordance with pedal			

Mode 1 : OMNI ON, POLY
Mode 2 : OMNI ON, MONO
Mode 3 : OMNI OFF, POLY
Mode 4 : OMNI OFF, MONO

O : Yes
X : No



This recycle mark indicates that the packaging conforms to the environmental protection legislation in Germany.

CASIO®