

LK-43

USER'S GUIDE GUÍA DEL USUARIO



P
英西
LK43-ES-1

CASIO®

GUIDELINES LAID DOWN BY FCC RULES FOR USE OF THE UNIT IN THE U.S.A. (not applicable to other areas).

NOTICE

This equipment has been tested and found to comply with the limits for a Class B digital device, pursuant to Part 15 of the FCC Rules. These limits are designed to provide reasonable protection against harmful interference in a residential installation. This equipment generates, uses and can radiate radio frequency energy and, if not installed and used in accordance with the instructions, may cause harmful interference to radio communications. However, there is no guarantee that interference will not occur in a particular installation. If this equipment does cause harmful interference to radio or television reception, which can be determined by turning the equipment off and on, the user is encouraged to try to correct the interference by one or more of the following measures:

- Reorient or relocate the receiving antenna.
- Increase the separation between the equipment and receiver.
- Connect the equipment into an outlet on a circuit different from that to which the receiver is connected.
- Consult the dealer or an experienced radio/TV technician for help.

FCC WARNING

Changes or modifications not expressly approved by the party responsible for compliance could void the user's authority to operate the equipment.

Important!

Please note the following important information before using this product.

- Before using the optional AD-5 Adaptor to power the unit, be sure to check the AC Adaptor for any damage first. Carefully check the power cord for breakage, cuts, exposed wire and other serious damage. Never let children use an AC adaptor that is seriously damaged.
- Never attempt to recharge batteries.
- Do not use rechargeable batteries.
- Never mix old batteries with new ones.
- Use recommended batteries or equivalent types.
- Always make sure that positive (+) and negative (-) poles are facing correctly as indicated near the battery compartment.
- Replace batteries as soon as possible after any sign they are getting weak.
- Do not short-circuit the battery terminals.
- The product is not intended for children under 3 years.
- Use only CASIO AD-5 adaptor.
- The AC adaptor is not a toy.
- Be sure to disconnect the AC adaptor before cleaning the product.



CASIO ELECTRONICS CO., LTD.
Unit 6, 1000
North Circular Road
London NW2 7JD, U.K.

This mark is valid in the EU countries only.
Please keep all information for future reference.

640A-E-002A

Safety Precautions

Congratulations on your selection of the CASIO electronic musical instrument.

- Before using the instrument, be sure to carefully read through the instructions contained in this manual.
- Please keep all information for future reference.

Symbols

Various symbols are used in this user's guide and on the product itself to ensure that the product is used safely and correctly, and to prevent injury to the user and other persons as well as damage to property. Those symbols along with their meanings are shown below.

DANGER

This symbol indicates information that, if ignored or applied incorrectly, creates the danger of death or serious personal injury.

WARNING

This indication stipulates matters that have the risk of causing death or serious injury if the product is operated incorrectly while ignoring this indication.

CAUTION

This indication stipulates matters that have the risk of causing injury as well as matters for which there is the likelihood of occurrence of physical damage only if the product is operated incorrectly while ignoring this indication.

Symbol Examples



This triangle symbol (\triangle) means that the user should be careful. (The example at left indicates electrical shock caution.)



This circle with a line through it (\odot) means that the indicated action must not be performed. Indications within or nearby this symbol are specifically prohibited. (The example at left indicates that disassembly is prohibited.)



The black dot (\bullet) means that the indicated action must be performed. Indications within this symbol are actions that are specifically instructed to be performed. (The example at left indicates that the power plug must be unplugged from the electrical socket.)

DANGER

Alkaline Batteries

Perform the following steps immediately if fluid leaking from alkaline batteries ever gets into your eyes.



1. Do not rub your eyes! Rinse them with water.
2. Contact your physician immediately.

Leaving alkaline battery fluid in your eyes can lead to loss of sight.

WARNING

Smoke, Strange Odor, Overheating

Continued use of the product while it is emitting smoke, a strange odor, or heat creates the risk of fire and electric shock. Take the following steps immediately.

1. Turn off power.
2. If you are using the AC adaptor for power, unplug it from the wall outlet.
3. Contact your original retailer or an authorized CASIO Service Provider.

AC Adaptor

Misuse of the AC adaptor creates the risk of fire and electric shock. Always make sure you observe the following precautions.

- Be sure to use only the AC adaptor that is specified for this product.
- Use only a power source whose voltage is within the rating marked on the AC adaptor.
- Do not overload electrical outlets and extension cords.



AC Adaptor

Misuse of the AC adaptor's electric cord can damage or break it, creating the risk of fire and electric shock. Always make sure you observe the following precautions.

- Never place heavy objects on the cord or subject it to heat.
- Never try to modify the cord or subject it to excessive bending.
- Never twist or stretch the cord.
- Should the electric cord or plug become damaged, contact your original retailer or authorized CASIO Service Provider.



AC Adaptor

Never touch the AC adaptor while your hands are wet. Doing so creates the risk of electric shock.



Batteries

Misuse of batteries can cause them to leak, resulting in damage to nearby objects, or to explode, creating the risk of fire and personal injury. Always make sure you observe the following precautions.

- Never try to take batteries apart or allow them to become shorted.
- Never expose batteries to heat or dispose of them by incineration.
- Never mix old batteries with new ones.
- Never mix batteries of different types.
- Do not charge the batteries.
- Make sure the positive (+) and negative (-) ends of the batteries are facing correctly.



Do not incinerate the product.

Never throw the product into fire. Doing so can cause it to explode, creating the risk of fire and personal injury.



Water and Foreign Matter

Water, other liquids, and foreign matter (such as pieces of metal) getting into the product create the risk of fire and electric shock. Take the following steps immediately.



1. Turn off power.
2. If you are using the AC adaptor for power, unplug it from the wall outlet.
3. Contact your original retailer or an authorized CASIO Service Provider.

Disassembly and Modification

Never try to take this product apart or modify it in any way. Doing so creates the risk of electric shock, burn injury, or other personal injury. Leave all internal inspection, adjustment, and maintenance up to your original retailer or authorized CASIO Service Provider.



Dropping and Impact

Continued use of this product after it has been damaged by dropping or subjecting it to strong impact creates the risk of fire and electric shock. Take the following steps immediately.

1. Turn off power.
2. If you are using the AC adaptor for power, unplug it from the wall outlet.
3. Contact your original retailer or an authorized CASIO Service Provider.



Plastic Bags

Never place the plastic bag the product comes in over your head or in your mouth. Doing so creates the risk of suffocation.



Particular care concerning this precaution is required where small children are present.

Keep off of the product and stand.*

Climbing onto the product or stand can cause it to tip over or become damaged. Particular care concerning this precaution is required where small children are present.



Location

Avoid locating the product on an unstable stand, on an uneven surface, or any other unstable location. An unstable location can cause the product to fall over, creating the risk of personal injury.



CAUTION

AC Adaptor

Misuse of the AC adaptor creates the risk of fire and electric shock. Always make sure you observe the following precautions.

- Do not locate the electric cord near a stove or other sources of heat. 
- Never pull on the cord when unplugging from the electrical outlet. Always grasp the AC adaptor when unplugging.

AC Adaptor

Misuse of the AC adaptor creates the risk of fire and electric shock. Always make sure you observe the following precautions.

- Insert the AC adaptor into the wall outlet as far as it will go. 
- Unplug the AC adaptor from the wall outlet during lightning storms or before leaving on a trip or other long-term absence.
- At least once a year, unplug the AC adaptor from the wall outlet and wipe away any dust that is built up in the area around the prongs of the plug.

Relocating the Product

Before relocating the product, always unplug the AC adaptor from the wall outlet and disconnect all other cables and connecting cords. Leaving cords connected creates the risk of damage to the cords, fire, and electric shock. 

Cleaning

Before cleaning the product, always unplug the AC adaptor from the wall outlet first. Leaving the AC adaptor plugged in creates the risk of damage to the AC adaptor, fire, and electric shock. 

Batteries

Misuse of batteries can cause them to leak resulting in damage to nearby objects, or to explode, creating the risk of fire and personal injury. Always make sure you observe the following precautions.

- Use only batteries that are specified for use with this product. 
- Remove batteries from the product if you do not plan to use it for a long time.

Connectors

Connect only the specified devices and equipment to the product's connectors. Connection of a non-specified device or equipment creates the risk of fire and electric shock. 

Location

Avoid the following locations for this product. Such locations create the risk of fire and electric shock. 

- Areas subject to high humidity or large amounts of dust.
- In food preparation areas or other areas subject to oil smoke.
- Near air conditioning equipment, on a heated carpet, in areas exposed to direct sunlight, inside of a vehicle parked in the sun, or any other area that subjects the product to high temperatures.

Display Screen

- Never push on the display screen's LCD panel or subject it to strong impact. Doing so can cause the LCD panel's glass to crack, creating the risk of personal injury. 
- Should the LCD panel ever crack or break, never touch the liquid inside of the panel. LCD panel liquid can cause skin irritation.
- Should LCD panel liquid ever get inside your mouth, immediately wash out your mouth with water and contact your physician.
- Should LCD panel liquid ever get into your eyes or onto your skin, rinse with clear water for at least 15 minutes, and then contact a physician.

Sound Volume

Do not listen to music at very loud volumes for long periods. Particular care concerning this precaution is required when using headphones. High volume settings can damage your hearing. 

Heavy Objects

Never place heavy object on top of the product. Doing so can make the product top heavy, causing the product to tip over or the object to fall from it, creating the risk of personal injury. 

Correct Stand* Assembly

An incorrectly assembled stand can tip over, causing the product to fall and creating the risk of personal injury. 

Make sure you assemble the stand correctly, following the assembly instructions that come with it. Make sure you mount the product on the stand correctly.

* Stand is available as an option.

IMPORTANT!

When using batteries, be sure to replace them or shift to one of the alternate power sources whenever you notice any of the following symptoms.

- Dim power indicator
- Instrument does not turn on
- Display that is flickering, dim, or difficult to read
- Abnormally low speaker/headphone volume
- Distortion of sound output
- Occasional interruption of sound when playing at high volume
- Sudden power failure when playing at high volume
- Flickering or dimming of the display when playing at high volume
- Continued sound output even after you release a key
- A tone that is totally different from the one that is selected
- Abnormal rhythm pattern and Song Bank play
- Loss of power, sound distortion, or low volume when playing from a connected computer or MIDI device



Main Features

On-screen fingering and timing indicators

- Easy-to-understand on-screen indicators help to simplify keyboard play, even for novices.

100 amazingly realistic tones

Enhanced auto-accompaniment function for greater versatility

- 50 built in auto-accompaniment patterns.

100 Built-in Song Bank tunes

- A total of 100 built-in Song Bank tunes comes built in for playback enjoyment or play-along practice.

3-Step Lesson System

- Develop your musical skills by following the keys as they light. First you become familiar with the timing of the notes by watching the keys light as you playback one of the 100 built-in Song Bank tunes. Next, practice playing along at a pace that's comfortable for you. Finally, try playing along at the normal tempo for the Song Bank tune.
- A simulated human voice is used during Step 1 or Step 2 play to call out the fingers you should use to play the required notes (Voice Fingering). The timing of notes is also indicated on the display screen.

Auto Accompaniment

- Simply specify a chord and the keyboard automatically produces the matching rhythm, bass, and chord patterns. One-touch fill-ins make accompaniments sound interesting and natural.

Transpose Function

- An easy operation instantly changes the key of the keyboard.

MIDI compatibility

- Connecting to another MIDI device lets you sound notes on both this keyboard and the connected device by playing on this keyboard.



Contents

Safety Precautions E-1

Main Features E-6

Contents E-7

General Guide E-8

About the Display E-10

Quick Reference E-11

Power Supply E-12

Using batteries E-12

Using the AC Adaptor E-12

Auto Power Off E-13

Power On Alert E-13

Connections E-14

Phones/Output Jack E-14

Sustain Jack E-14

Accessories and Options E-14

Basic Operations E-15

To switch power on and off E-15

To change tones E-15

Other Useful Functions E-17

Playing the demo tunes E-18

Playing rhythms E-18

Using auto-accompaniment E-19

Improvising with the preset patterns E-21

3-Step Lesson System E-22

Using 3-Step Lesson System E-22

Voice Fingering Guide E-24

Timing Indicator E-25

Step 1: Master the timing E-26

Step 2: Master the melody E-27

Step 3: Play at normal speed E-27

To practice the left hand part E-28

MIDI E-29

What is MIDI? E-29

General MIDI E-29

Technical Reference E-32

Troubleshooting E-32

Specifications E-34

Care of Your Keyboard E-35

Appendix A-1

GM Tone Map List A-1

Rhythm List A-2

Fingered Chord Charts A-3

MIDI Implementation Chart

General Guide

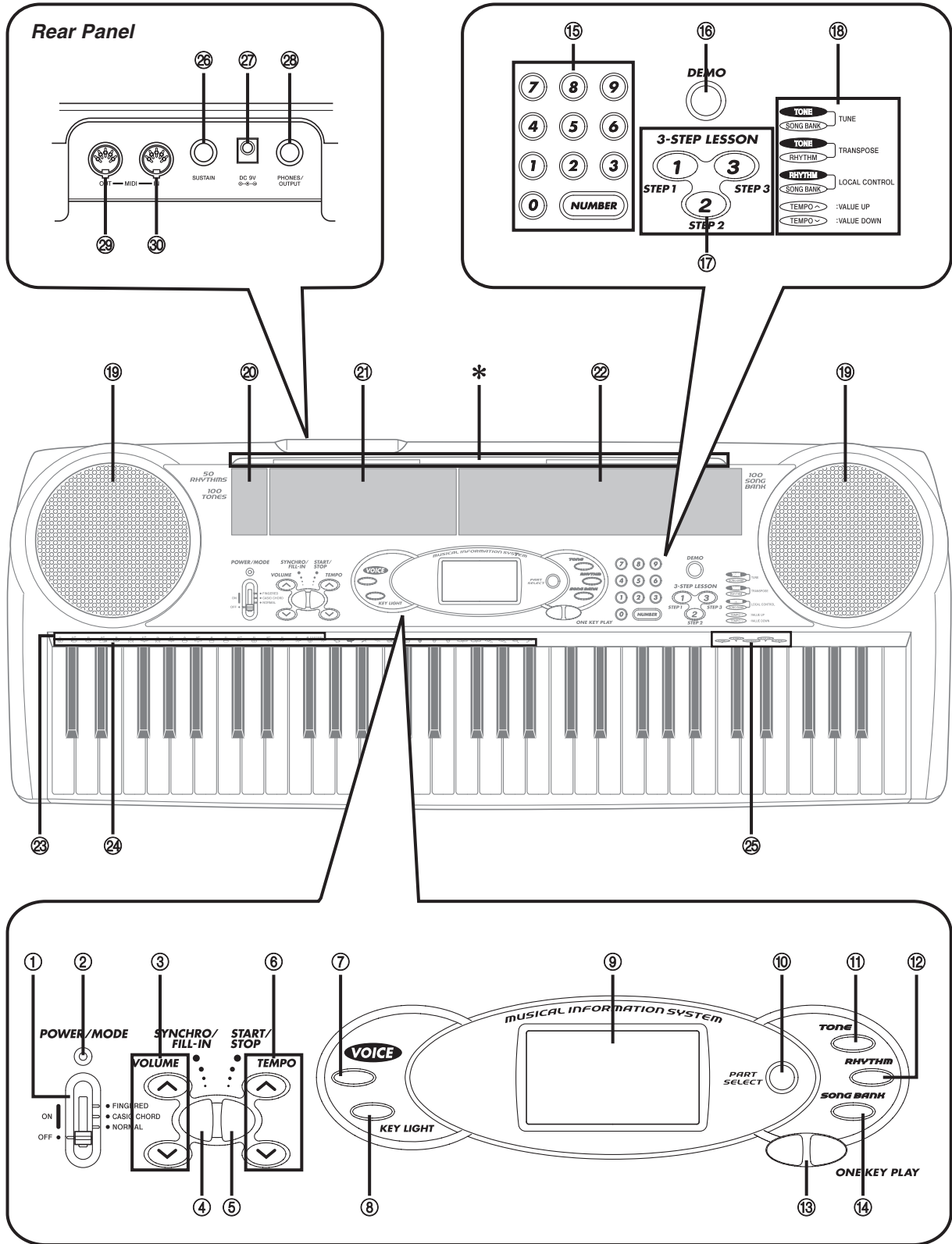

- ① POWER/MODE selector
- ② Power indicator
- ③ VOLUME buttons
- ④ SYNCHRO/FILL-IN button
- ⑤ START/STOP button
- ⑥ TEMPO buttons
- ⑦ VOICE button
- ⑧ KEY LIGHT button
- ⑨ Display
- ⑩ PART SELECT button
- ⑪ TONE button
- ⑫ RHYTHM button
- ⑬ ONE KEY PLAY buttons
- ⑭ SONG BANK button
- ⑮ Number buttons
- ⑯ DEMO button
- ⑰ 3-STEP LESSON buttons
- ⑱ TRANSPOSE/TUNE/LOCAL CONTROL operation guide
- ⑲ Speakers
- ⑳ 50 RHYTHMS list
See "Rhythm List" on page A-2 for details.
- ㉑ 100 TONES list
- ㉒ 100 SONG BANK list
- ㉓ CHORD ROOT NAMES
- ㉔ Percussion instrument list
- ㉕ Voice 1 to 5
- ㉖ SUSTAIN jack
- ㉗ DC 9V jack
- ㉘ PHONES/OUTPUT jack
For connection of commercially available headphones. Output from the speakers is automatically cut when headphones are connected.
- ㉙ MIDI OUT terminal
- ㉚ MIDI IN terminal

*** Attachment of Score Stand**

Insert the score stand into the slot at the top of the keyboard as shown in the illustration.

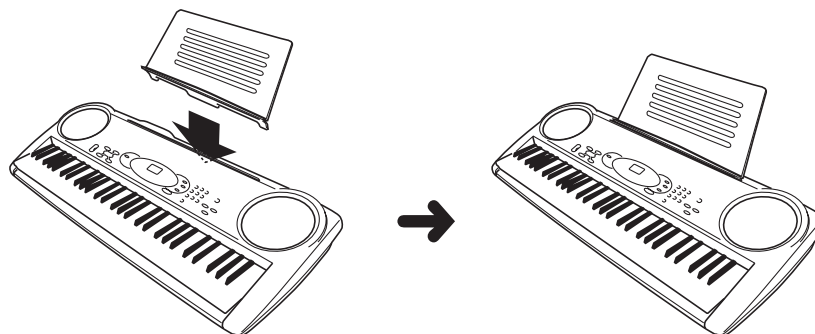

About the Display

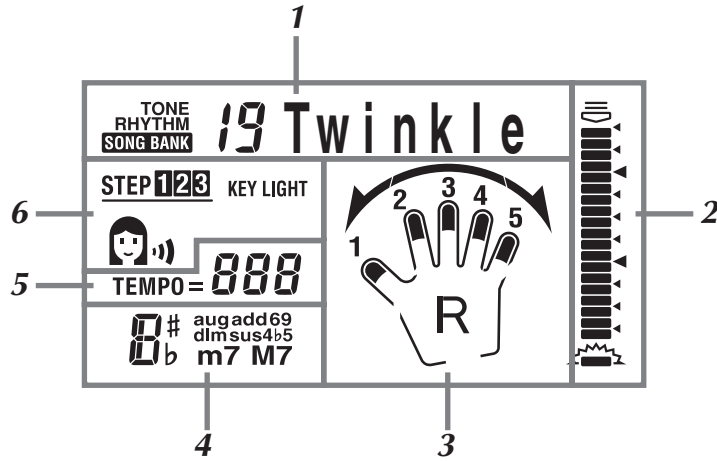

1. Currently selected tone number and name, rhythm number and name, song number and name. This area is also used to display other types of information, depending on the mode.
2. Timing Indicator shows the timing of upcoming notes during lesson and Song Bank play.
3. Fingering and finger crossing during 3-Step Lesson and Song Bank play. R indicates right-hand and L indicates left-hand.
4. Chord names during auto-accompaniment and Song Bank play.
5. Tempo (beats per minute) during rhythm, auto-accompaniment, and Song Bank play.
6. Indicators showing when key lighting or voice fingering is turned on. Also indicates the step number during 3-Step Lesson.

NOTE

- Display examples shown in this User's Guide are intended for illustrative purposes only. The actual text and values that appear on the display may differ from the examples shown in this User's Guide.

Quick Reference

This section provides a quick overview of keyboard operation using steps one and two of the 3-step lesson feature. See page E-22 for detailed explanations of these steps.

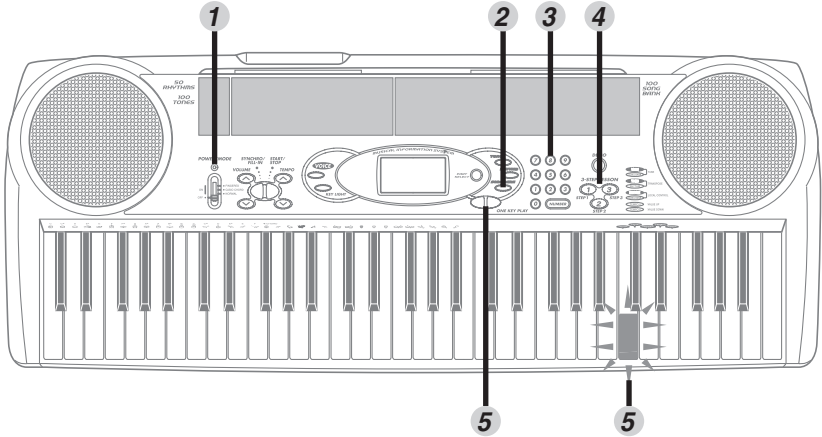

1 Set the POWER/MODE selector to NORMAL.

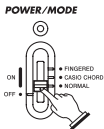

2 Press the SONG BANK button.



3 Find the tune you want to play in the Song Bank list, and then use the number buttons to input its two-digit number.

- To select "19 TWINKLE TWINKLE LITTLE STAR", input 1 and then 9.



4 Press the STEP 1 button or STEP 2 button.

- When you do, the STEP 1 indicator or STEP 2 indicator appears.
- The keyboard sounds a count beat and waits for you to play something on the keyboard. The keys that you need to press first flash.
- Play in accordance with the fingerings that appear on the display.

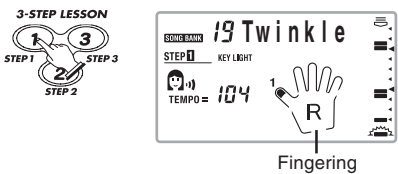

5 Play the melody part on the keyboard.

<If you pressed the STEP 1 button in **4** ...>
Play the notes with the ONE KEY PLAY buttons.

- The accompaniment tempo automatically adjusts to play along with your melody.



Play the notes on the keyboard.

- A sub-melody (obligato) plays in time with the melody.
- With Step 1, the correct melody note is played no matter which keyboard key you press.

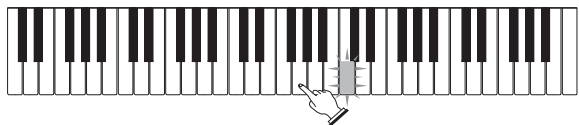

<If you pressed the STEP 2 button in **4** ...>
Play the notes on the keyboard, pressing keys as they light.

- Keep the key depressed as long as it stays lit.
- If you selected any song from number 85 through 99, the lit key goes out as soon as you press it.
- The key that corresponds to the next note you need to play will flash.
- After you press the correct melody key, accompaniment proceeds to the next note.



Power Supply

This keyboard can be powered by current from a standard household wall outlet (using the specified AC adaptor) or by batteries. Always make sure you turn the keyboard off whenever you are not using it.

Using batteries

Always make sure you turn off the keyboard before loading or replacing batteries.

To load batteries

1. Remove the battery compartment cover.
2. Load 6 AA-size batteries into the battery compartment.
 - Make sure that the positive (+) and negative (-) ends are facing correctly.
3. Insert the tabs on the battery compartment cover into the holes provided and close the cover.

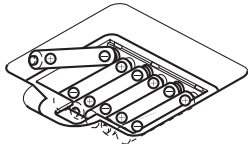

The keyboard may not function correctly if you load or replace batteries with power turned on. If this happens, turning the keyboard off and then back on again should return functions back to normal.

Important Battery Information

- The following shows the approximate battery life provided by different battery types.
 - Standard battery life: Approximately 1 hour (SUM3/R6P)
 - Approximately 4 hours (AM3/LR6)
- Both of the above values are standard battery life at normal temperature, with the keyboard volume at a medium setting. Temperature extremes or playing at very loud volume settings can shorten battery life.
- Any of the following symptoms indicate low battery power. Replace batteries as soon as possible whenever any of the following occurs.
 - Dim power indicator
 - Instrument does not turn on
 - Display that is flickering, dim, or difficult to read
 - Abnormally low speaker/headphone volume
 - Distortion of sound output
 - Occasional interruption of sound when playing at high volume
 - Sudden power failure when playing at high volume
 - Flickering or dimming of the display when playing at high volume

- Continued sound output even after you release a key
- A tone that is totally different from the one that is selected
- Abnormal rhythm pattern and Song Bank play
- Loss of power, sound distortion, or low volume when playing from a connected computer or MIDI device

⚠ WARNING

Misuse of batteries can cause them to leak, resulting in damage to nearby objects, or to explode, creating the risk of fire and personal injury. Always make sure you observe the following precautions.

- Never try to take batteries apart or allow them to become shorted. ⓧ
- Never expose batteries to heat or dispose of them by incineration.
- Never mix old batteries with new ones.
- Never mix batteries of different types.
- Do not charge the batteries.
- Make sure the positive (+) and negative (-) ends of the batteries are facing correctly.

⚠ CAUTION

Misuse of batteries can cause them to leak resulting in damage to nearby objects, or to explode, creating the risk of fire and personal injury. Always make sure you observe the following precautions.

- Use only batteries that are specified for use with this product. ⓧ
- Remove batteries from the product if you do not plan to use it for a long time.

Using the AC Adaptor

Make sure that you use only the AC adaptor specified for this keyboard.



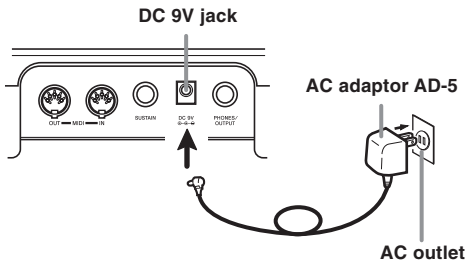

Specified AC Adaptor: AD-5



Also note the following important warnings and precautions when using the AC adaptor.



⚠ WARNING

Misuse of the AC adaptor creates the risk of fire and electric shock. Always make sure you observe the following precautions.

- Be sure to use only the AC adaptor that is specified for this product.
- Use only a power source whose voltage is within the rating marked on the AC adaptor. 
- Do not overload electrical outlets and extension cords. 
- Never place heavy objects on the cord or subject it to heat. 
- Never try to modify the cord or subject it to excessive bending.
- Never twist or stretch the cord.
- Should the electric cord or plug become damaged, contact your original retailer or authorized CASIO Service Provider. 
- Never touch the AC adaptor while your hands are wet. Doing so creates the risk of electric shock. 

⚠ CAUTION

Misuse of the AC adaptor creates the risk of fire and electric shock. Always make sure you observe the following precautions.

- Do not locate the electric cord near a stove or other sources of heat. 
- Never pull on the cord when unplugging from the electrical outlet. Always grasp the AC adaptor when unplugging.
- Insert the AC adaptor into the wall outlet as far as it will go. 
- Unplug the AC adaptor from the wall outlet during lightning storms or before leaving on a trip or other long-term absence.
- At least once a year, unplug the AC adaptor from the wall outlet and wipe away any dust that is built up in the area around the prongs of the plug.

IMPORTANT!

- Make sure that the keyboard is turned off before connecting or disconnecting the AC adaptor.
- Using the AC adaptor for a long time can cause it to become warm to the touch. This is normal and does not indicate malfunction.

Auto Power Off

When you are using battery power, keyboard power turns off automatically whenever you leave it on without performing any operation for about 6 minutes. When this happens, move the POWER/MODE selector to the OFF position and then back to NORMAL, CASIO CHORD, or FINGERED to turn power back on.

NOTE

- Auto Power Off is disabled (it does not function) when you are using the AC adaptor to power the keyboard.

Power On Alert

Keyboard keys light to alert you if you leave power on and do not perform any operation for about 6 minutes. Note that keys light only, and no sound is produced. When this happens, press any button or keyboard key to clear the power on alert.

NOTE

- Power on alert operates only when you are powering the keyboard using the AC adaptor. It does not operate when you are using batteries.

To disable Auto Power Off and power on alert

Hold down the TONE button while turning on the keyboard to disable Auto Power Off and power on alert.

NOTE

- When these functions are turned off, the keyboard does not turn off automatically and no alert is performed no matter how long it is left with no operation being performed.
- Auto Power Off and power on alert are enabled again when you manually turn off power and then turn it back on again.

Connections

Phones/Output Jack

Before connecting headphones or other external equipment, be sure to first turn down the volume settings of the keyboard and the connected equipment. You can then adjust volume to the desired level after connections are complete.

[Rear Panel]

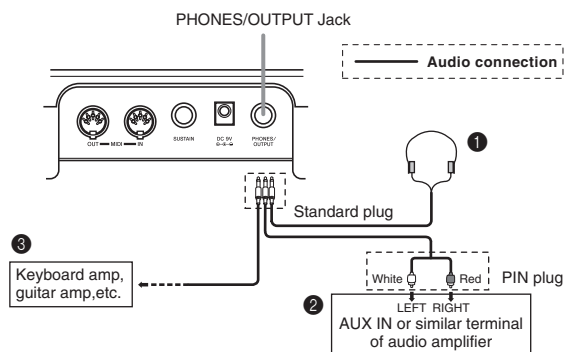

Connecting Headphones (Figure 1)

Connecting headphones cuts off output from the keyboard's built-in speakers, so you can play even late at night without disturbing anyone.

Audio Equipment (Figure 2)

Connect the keyboard to an audio equipment using a commercially available connecting cord with a standard plug on one end and two PIN plugs on the other end. In this configuration, you normally set the input selector of the audio equipment to the terminal (usually marked AUX IN or something similar) where the cord from the keyboard is connected. See the user documentation that comes with your audio equipment for full details.

Musical Instrument Amplifier (Figure 3)

Use a commercially available connecting cord to connect the keyboard to a musical instrument amplifier.

NOTE

- Be sure to use a connecting cord that has standard plugs on the ends you connect to the keyboard and amplifier.

[Connection Example]

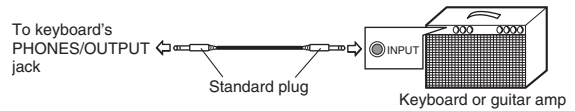

Sustain Jack

You can connect an optional sustain pedal (SP-2, SP-10, or SP-20) to the SUSTAIN jack to enable the capabilities described below.

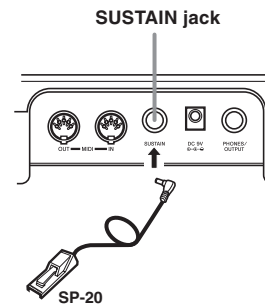

Sustain Pedal

- With piano tones, depressing the pedal causes notes to linger, much like a piano's damper pedal.
- With organ tones, depressing the pedal causes notes to continue to sound until the pedal is released.

Accessories and Options

Use only the accessories and options specified for this keyboard. Use of non-authorized items creates the danger of fire, electrical shock, and personal injury.

Basic Operations

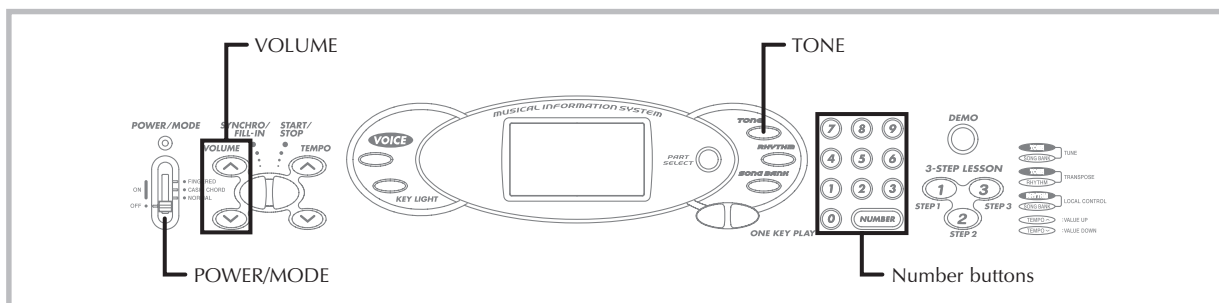

This part of the manual provides you with the basic information you need to use your keyboard.

To switch power on and off

1. Set the POWER/MODE selector to NORMAL.
2. Press the keyboard keys.
3. The VOLUME up and down arrow buttons are used to adjust main volume.
 - Volume can be adjusted over a range of 0 (minimum) to 9 (maximum).
 - Volume is set to 7 when the power is turned on.
 - A setting of 0 turns down the volume completely.
 - The volume can be changed continuously by continuously pressing down the \uparrow or \downarrow buttons.
 - Pressing the \uparrow and \downarrow buttons simultaneously sets the volume to level 7.
 - Numeric values can be entered directly with the number buttons after the VOLUME button has been pressed in step 3.
 - The amount that the volume setting raises or lowers the volume level differs according to the tone, auto accompaniment, or song you are using.
4. To switch power off, set the POWER/MODE selector to OFF position.

To change tones

1. Look at the tone list printed on the keyboard's console and find the one you want.
2. Press the TONE button.

Indicator appears



3. Use the number buttons to input the 2-digit number that identifies the tone you want to select.

Example: To select "26 ACOUSTIC BASS", input 2 and then 6.



NOTE

- Always enter two digits for the tone number. If you enter only one digit, the display will automatically return to the previous tone number setting after a few seconds.
- If you change the tone setting while a keyboard key is depressed, the tone does not change until you release the key and press a keyboard key again.
- With certain tones (such as percussion sounds and sound effects), there may be very little or no change at all in the pitch, no matter which keyboard key you press.
- If you input the wrong first digit for a tone number, you can return to the previous setting by pressing the TONE button.

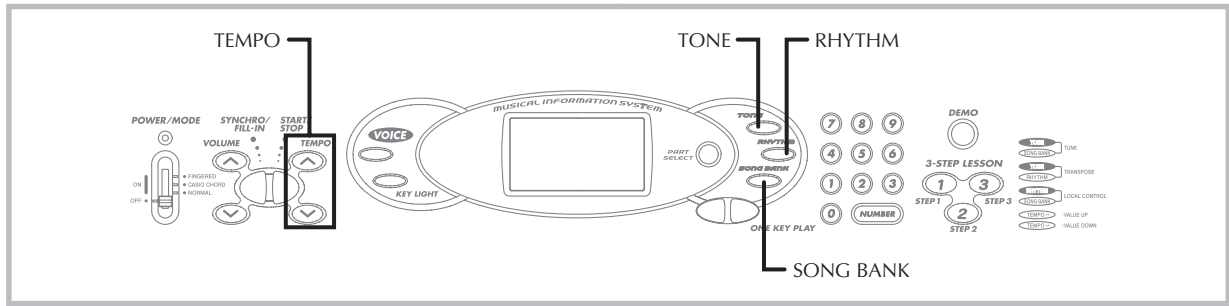

Keyboard split tones

Some of the preset tones split the keyboard and assign two or more sounds. With such a preset tone, the sound produced depends on what position of the keyboard you play. For example, BASS/PIANO (tone 90) puts BASS on the left and PIANO on the right of the keyboard.

<Example>

BASS/PIANO (No.90)

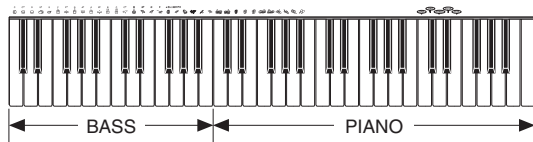

PERCUSSION (No.99)

- PERCUSSION (Tone 99) assigns 35 percussion sounds and five voice sounds to the keyboard as shown below. The sounds assigned to each key are indicated above the keyboard.

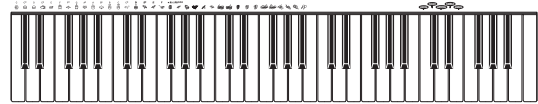

	BASS DRUM		COWBELL
	SIDE STICK		CRASH CYMBAL 2
	ACOUSTIC SNARE		CLAVES
	HAND CLAP		RIDE CYMBAL 2
	ELECTRIC SNARE		HIGH BONGO
	LOW FLOOR TOM		LOW BONGO
	CLOSED HI-HAT		MUTE HIGH CONGA
	HIGH FLOOR TOM		OPEN HIGH CONGA
	PEDAL HI-HAT		LOW CONGA
	LOW TOM		HIGH TIMBALES
	OPEN HI-HAT		LOW TIMBALES
	LOW MID TOM		HIGH AGOGO
	HIGH MID TOM		LOW AGOGO
	CRASH CYMBAL 1		CABASA
	HIGH TOM		MARACAS
	RIDE CYMBAL 1		VOICE 1
	CHINESE CYMBAL		VOICE 2
	RIDE BELL		VOICE 3
	TAMBOURINE		VOICE 4
	SPLASH CYMBAL		VOICE 5

Digital Sampling

A number of the tones that are available with this keyboard have been recorded and processed using a technique called digital sampling. To ensure a high level of tonal quality, samples are taken in the low, mid, and high ranges and then combined to provide you with sounds that are amazingly close to the originals. You may notice very slight differences in volume or sound quality for some tones when you play them at different positions on the keyboard. This is an unavoidable result of multiple sampling, and it is not a sign of malfunction.

Polyphony

The term polyphony refers to the maximum number of notes you can play at the same time. This keyboard has 12-note polyphony, which includes the notes you play as well as the rhythms and auto-accompaniment patterns that are played by the keyboard. This means that when a rhythm or auto-accompaniment pattern is being played by the keyboard, the number of notes (polyphony) available for keyboard play is reduced. Also note that some of the tones offer only 6-note polyphony.

- When rhythm or auto accompaniment is playing, the number of sounds simultaneously played is reduced.
- Though you can sound up to 12 notes at one time, only the last four keyboard keys pressed light up.

Other Useful Functions

To change the key of the keyboard

The transpose feature of this keyboard lets you raise or lower its key in semitone increments. This means you can easily match to suit someone's voice, and you can eliminate sharps and flats from music making it easier to play.

1. While in any mode besides the Song Bank Mode (indicated when the SONG BANK indicator is lit), hold down the TONE button and press the RHYTHM button.

- Perform step 2 within five seconds after performing step 1.

0 Trans

2. Use the TEMPO buttons to change the key of the keyboard.

Example: To change the tuning to B (indicated by -1 since it is one tone below C, which is the normal tuning of the keyboard).

! Trans (-)

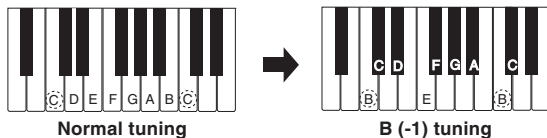

<Keys and their indicators>

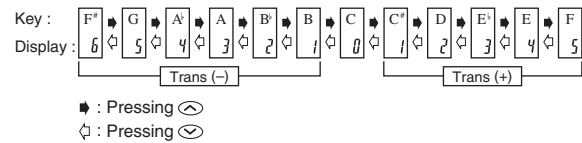

<Note Names>



! NOTE

- If you leave the transpose screen on the display for about five seconds without doing anything, the screen is automatically cleared.
- You cannot change the transpose setting while the keyboard is in the Song Bank Mode.
- In step 2 of the above operation, you could also use the number buttons 0 to 5 to specify C through F.
- Pressing both of the TEMPO buttons (◀/▶) at the same time returns the transpose setting to C(0).
- The transpose setting is automatically set to C(0) whenever you turn keyboard power on.
- The transpose setting is automatically set to C(0) whenever you press the SONG BANK button.
- The pitch of a transposed note depends on the tone you are using. If the transpose operation causes a note to exceed the range of the tone you are using, the same note in the highest octave of the tone's range is substituted.
- The transpose operation does not affect tone number 99 (PERCUSSION) or auto-accompaniment rhythms.
- Transposing tones 75 through 79 and 90 through 96 changes the range of keys to which each of the tones is assigned.
- The transpose setting is automatically set to C(0) whenever you press the DEMO button.

To tune the keyboard

A simple operation lets you tune the keyboard to another musical instrument.

1. While in any mode besides the Song Bank Mode (indicated when the SONG BANK indicator is lit), hold down the TONE button and press the SONG BANK button.

- Perform step 2 within five seconds after performing step 1.

00 Tune

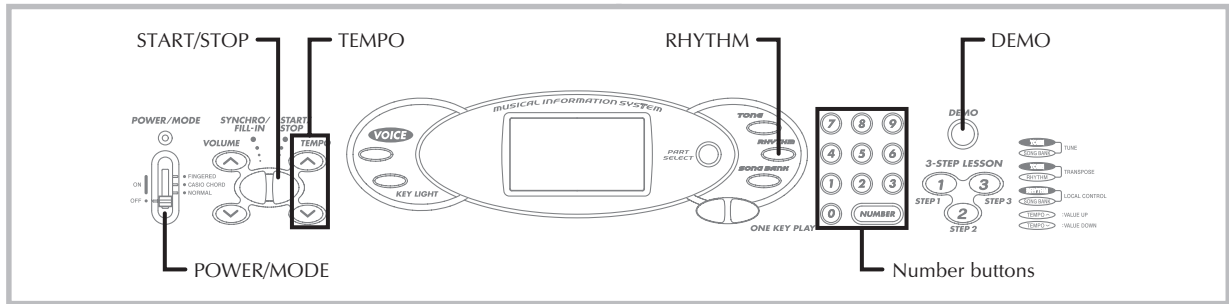

2. Use the TEMPO buttons to change the tuning of the keyboard.

Example: To lower tuning by 20



NOTE

- If you leave the tuning screen on the display for about five seconds without doing anything, the screen is automatically cleared.
- In step 2 of the above procedure, you could also use the number buttons to input a value from 00 to 50.
- Pressing both of the TEMPO buttons (▲/▼) at the same time returns the tuning setting to 00.
- Pressing the SONG BANK button changes the tuning setting to 00.
- The tuning setting does not affect any of Song Bank tunes.
- You can tune the keyboard within a range of approximately ±50 cents (100 cents = 1 semitone).
- The tuning setting is automatically set to 00 whenever you turn the keyboard on.
- Pressing the DEMO button changes the tuning setting to 00.
- The tuning operation does not affect rhythm (99 PERCUSSION).

Playing the demo tunes

You can set up the keyboard to continually play its 100 built-in Song Bank tunes. Keyboard keys light to indicate the melody notes of the demo tune as it plays.

To start demo tune play

1. Switch power on and adjust the volume level.
2. Press the DEMO button.
 - Demo tune play continues in a sequential endless loop until you switch it off.
 - The number and name of the demo tune currently playing are shown on the display.
 - You can play along on the keyboard while a demo tune is playing back.

3. You can change the demo tune play being played by pressing the number buttons.

- The Song Bank tunes play back in tune number sequence, starting from the one you select.

To stop demo tune play

Press the DEMO button or START/STOP button again to stop demo tune play.

NOTE

- Only the following buttons are enabled while a Song Bank tune is being played.
 - VOLUME buttons
 - Number buttons
 - START/STOP button
 - POWER/MODE selector (OFF)
 - DEMO button
 - KEY LIGHT button
 - VOICE button
- You cannot change the tone being used for the melody of a Song Bank tune.

Playing rhythms

This keyboard features a collection of 50 exciting built-in rhythm patterns. Each pattern provides percussion back up for all your performances.

To select and play a rhythm

1. Set the POWER/MODE selector to NORMAL.
2. Find the rhythm you want to use in the "Rhythm List" (page A-2) and note its rhythm number.
3. Press the RHYTHM button.
 - When you do, the RHYTHM indicator appears.
 - The number and name that appear on the display indicate the currently selected rhythm.

- Use the number buttons to input the 2-digit rhythm number for the rhythm you want to use.

Example: To select "37 SAMBA", input 3 and then 7.



- Be sure to always specify a 2-digit number.
- If you discover a mistake before you input the second digit, press the RHYTHM button to return to the previously set rhythm number.
- You can change to another rhythm even while the current rhythm is sounding.

- Press the START/STOP button to start play of the rhythm.

- When you do, the selected rhythm starts to sound.

- Use the TEMPO buttons to adjust the tempo of the rhythm.



- Each time you press one of the TEMPO buttons while the tempo value is displayed, the tempo setting changes one step, within the range of 040 to 255.
- The initial default tempo setting when you turn on power is 120.
- After displaying the current tempo setting by pressing the TEMPO button in step 6, you can also input the tempo setting you want by inputting a three-digit value with the number buttons.
- Holding down either of the TEMPO buttons changes the tempo setting at high speed.
- To reset the tempo to the standard value of each rhythm, press both TEMPO buttons.

- To stop rhythm play, press the START/STOP button again.

Using auto-accompaniment

This keyboard features 50 accompaniment patterns that let you add full accompaniments to your performances automatically. With auto-accompaniment, part of the keyboard is reserved as an accompaniment keyboard. As you play your chords on the accompaniment keyboard, the accompaniment pattern adjusts automatically to follow the progression you play.

You get a choice between two different methods for chord play. FINGERED lets you play chords as you normally do, while CASIO CHORD makes it possible to play fully formed chords with one finger.

About the accompaniment keyboard

The lower (left) 1.5 octaves are reserved for use as an accompaniment keyboard whenever you select CASIO CHORD or FINGERED with the POWER/MODE selector. The panel above the accompaniment keyboard keys is marked with the names of the notes they play. The remainder of the keyboard (the part that is not included in the accompaniment keyboard) is called the melody keyboard. Please be sure to remember these terms, because they will be used throughout the rest of this manual.

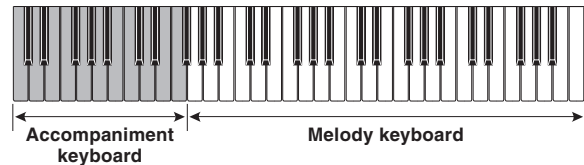

(The entire keyboard can be used for melody play while the POWER/MODE selector is set to NORMAL.)

Using the CASIO CHORD system

The CASIO CHORD system lets you easily play the four main types of chords. Play of chords is simplified as shown in the chart below.

Keys	Type	Example
Pressing one accompaniment key	Major chord	C (C Major Chord)
Pressing two accompaniment keys	Minor chord	Cm (C Minor Chord)
Pressing three accompaniment keys	Seventh chord	C7 (C Seventh Chord)
Pressing four accompaniment keys	Minor seventh chord	Cm7 (C Minor Seventh Chord)

NOTE

- The bottom (leftmost) note that you play determines the name of the chord. If the bottom note is a C for example, the keyboard produces a C chord.
- When pressing more than one accompaniment key, it makes no difference whether the keys to the right of the bottom note are white or black.

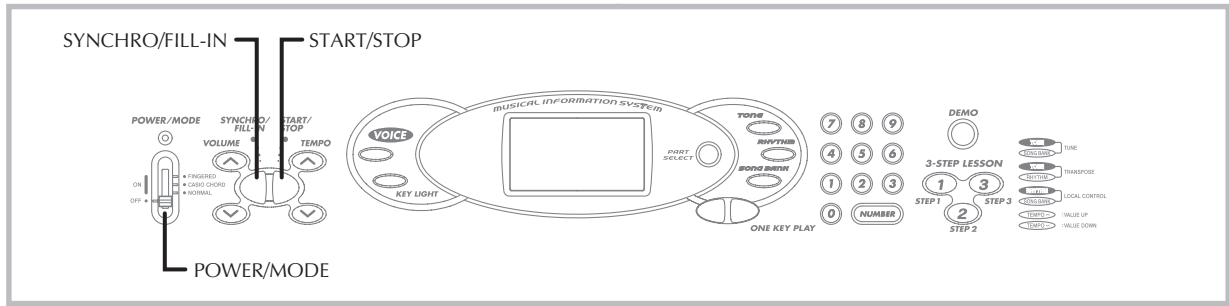

To play a CASIO CHORD auto-accompaniment

1. Use the POWER/MODE selector to select CASIO CHORD.
2. Select an auto-rhythm as described under “To select and play a rhythm” on page E-18.
3. Start play of the rhythm.
 - If you want to start play of the normal rhythm pattern, press START/STOP.
 - You can also use synchro start (page E-21) to start rhythm play.
4. Press either one or up to four keys on the accompaniment keyboard, and the corresponding accompaniment starts to play automatically.

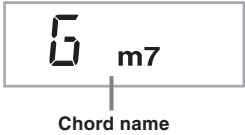

5. Continue pressing different keys on the accompaniment keyboard to play your chord progression.
6. To stop auto-accompaniment play, press the START/STOP button again.

Using standard fingerings

The FINGERED mode lets you play a wider variety of chords. In this mode, you can start play of an accompaniment pattern by pressing three or four of the accompaniment keyboard keys. This keyboard is capable of recognizing 15 different chords. The following shows the fingerings of these chords with a root of C. Note that you can omit the fifth notes (which are shown inside parentheses in the illustrations below) to produce 7, m7, M7, add9, madd9, and mM7 chords.

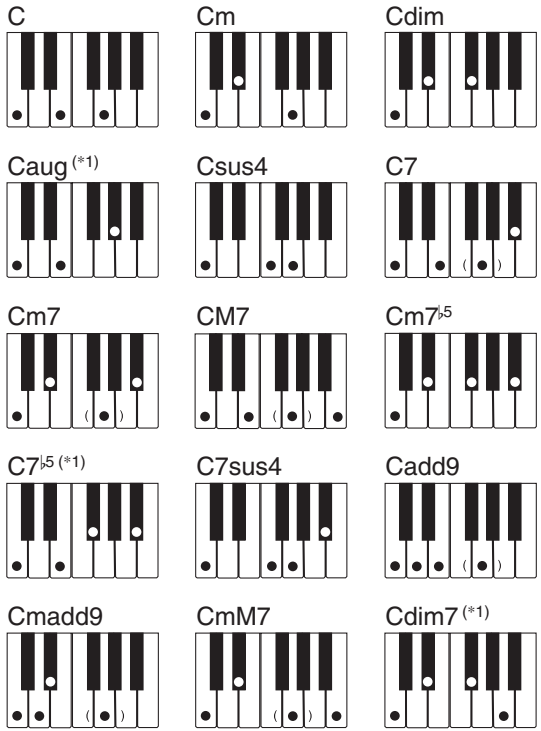

*1 With this chords, the lowest note in your fingering is always used as the root. Make sure that your fingering correctly identifies the root you want to use.

IMPORTANT!

- If you play one or two notes only in the left hand, or three notes that do not make up a recognizable chord formation, no sound will be produced. The FINGERED mode requires a conventional three or four-note chord formation to produce an auto-accompaniment. Also, note that auto-chords only work in conjunction with rhythm patterns, and not independently of them.

NOTE

- The above examples show only one of the possible fingerings for each chord. Note that you can play the notes that form a chord in any combination. Each of the following fingerings for example, produces the same C chord.

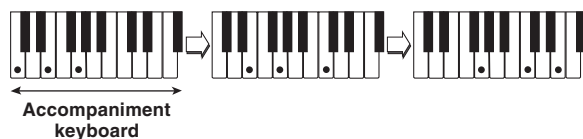

- See the “Fingered Chord Charts” on page A-3 for information on the fingerings of chords for all roots.

To play a FINGERED auto-accompaniment

1. Use the POWER/MODE selector to select FINGERED.
2. Select an auto-rhythm as described under “To select and play a rhythm” on page E-18.
3. Start play of the rhythm.
 - If you want to start play of the normal rhythm pattern, press START/STOP.
 - You can also use synchro start (on this page) to start rhythm play.
4. Play a chord on the accompaniment keyboard to start play of the auto-accompaniment.



5. Continue pressing keys on the accompaniment keyboard to play your chord progression.
6. To stop auto-accompaniment play, press the START/STOP button again.

Improvising with the preset patterns

Pressing the START/STOP button to start rhythm play causes the normal version of the pattern to be played. You can also play a variation of the rhythm using the operation described below.

Using fill-in rhythm

You can insert a fill-in rhythm by pressing the SYNCHRO/FILL-IN button while an auto-rhythm plays.

Using Synchro start

You can start the rhythm and accompaniment pattern at the same time, with your play of the accompaniment keyboard. To do this, follow the steps below.

1. Set the POWER/MODE selector to the CASIO CHORD or FINGERED position.
2. Select an auto-rhythm.
3. Press the SYNCHRO/FILL-IN button.
4. Press the accompaniment keys to play the first chord. As soon as you do, the auto-accompaniment pattern begins to play.

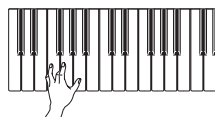

5. To stop the auto-accompaniment pattern play, press the START/STOP button.

NOTE

- If you set the POWER/MODE selector to NORMAL in step 1 on page E-18, the operation in step 4 starts play of the rhythm (percussion instruments) only.

3-Step Lesson System

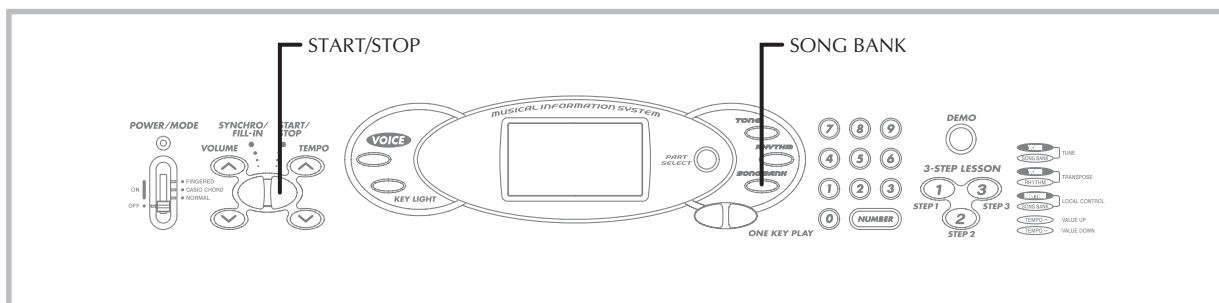

Using 3-Step Lesson System

Even individuals who cannot play the keyboard at all can follow along with the 100 built-in Song Bank tunes with the ONE KEY PLAY buttons. You can also use the 3-Step Lesson System to learn at your own pace. Play slowly at first until you are able to play along at normal speed.

Of the 100 built-in tunes, numbers 00 through 84 feature auto-accompaniment (auto-accompaniment tunes), while 85 through 99 are played using both hands (two-hand tunes).

The 3-Step Lesson System can be used with the following 3-step lesson plan to master keyboard play.

Step 1: Master the timing

Pressing the ONE KEY PLAY buttons plays the melody for an auto-accompaniment tune or the right hand part for two-hand tunes. In both cases, the auto-accompaniment (the left hand part in the case of two-hand tunes) is played automatically by the keyboard. In place of the ONE KEY PLAY buttons, you can also press any key of the keyboard to play the melody or right hand part. The purpose of this step is to familiarize yourself with the timing required to play melody notes.

Step 2: Master the melody

In this step, you use the display to learn which fingers you should use to play, and the key light system to learn which keyboard keys to press. You can play at the pace you want, because the auto-accompaniment or left hand part waits until you press the correct key.

Step 3: Play at normal speed

At this level, the keyboard's keys still light to indicate which notes to play, but they no longer wait for you to press the correct key. The auto-accompaniment or left hand part is played at normal speed.

NOTE

- You may not be able to see the keyboard keys light under direct sunlight or in other brightly lit areas.
- You can press the ONE KEY PLAY, STEP 1, STEP 2, and STEP 3 buttons at any time, except while a demo tune is playing. To return the keyboard to its normal mode, press the SONG BANK button.

3-Step Lesson System Tempo Setting

You can use the procedure in step 6 of the procedure on page E-19 to set the tempo of the left-hand part for Song Bank and 3-Step Lesson System play (Step 1 through 3).

This means you can use a slower tempo at the beginning, and then increase it as you learn. Press both of the TEMPO buttons (⊖ and ⊕) at the same time to return the tempo to its initial preset setting.

To play a built-in Song Bank tune

- Look up the number of the tune you want to play in the Song Bank list.
- Press the SONG BANK button until the SONG BANK indicator appears.
 - This causes the number and name of the currently selected Song Bank tune to appear on the display.
- Input the two digit number for the tune you want to play.

Example: To select "19 TWINKLE TWINKLE LITTLE STAR", input 1 and then 9.

SONG BANK 19 Twinkle

- Press the START/STOP button to start play of the selected tune.
 - The tune you select plays repeatedly, with the keyboard keys lighting to indicate the melody notes.

5. To stop Song Bank tune play, press the START/STOP button again.

6. To exit the Song Bank Mode, press the SONG BANK button again.

- When you do, the SONG BANK indicator goes out.

NOTE

- Always enter two digits for the Song Bank number.
- You can input a Song Bank tune number even while another Song Bank tune is playing.
- If you input the wrong first digit for a Song Bank tune number, you can return to the previous setting by pressing the SONG BANK button.
- The RHYTHM button is disabled in the Song Bank Mode. If you want to play a rhythm, press the SONG BANK button to return to the normal mode first.

Key Lighting System Operation and Display Contents During Song Bank Play

Keyboard keys light to show the keys that should be pressed to play along with Song Bank tunes as they play back. At the same time, the display shows fingerings, chord names, tempo and other information.

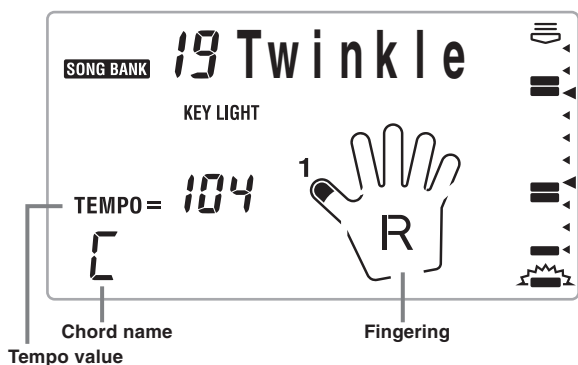

Crossed Finger Indications

The display also shows when you have to cross fingers to play notes, and in which direction your fingers should cross.

Example: Display for playing the notes below with the right hand

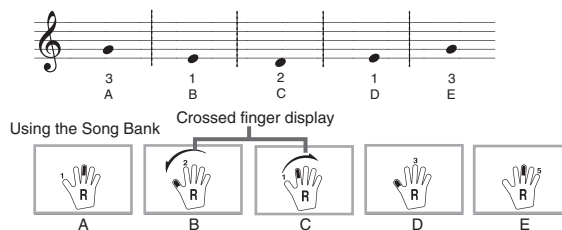

- B and C indicate that the index finger should cross over the thumb.
- C and D indicate that the thumb should cross under the index finger.

Key Lighting During Song Bank Play

When you play back a Song Bank tune, keyboard keys light to show you the notes that are being played.

Auto-accompaniment Song Bank Tune

Chord and melody part keys light.

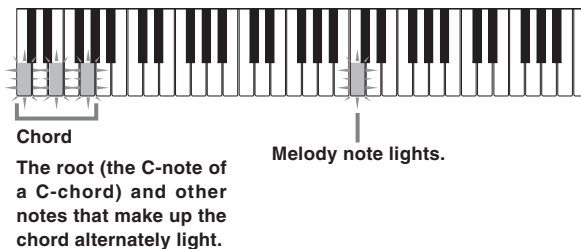

NOTE

- Some Song Bank tunes use chords (such as C6) that cannot be played with the FINGERED setting (page E-20). In the FINGERED mode, chords may sound different from the ones produced by Song Bank tune playback, even if you finger the chords as indicated by the lit keys.

Two-hand Song Bank Tune

Left hand and right hand part keys light.

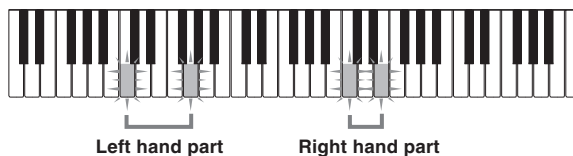

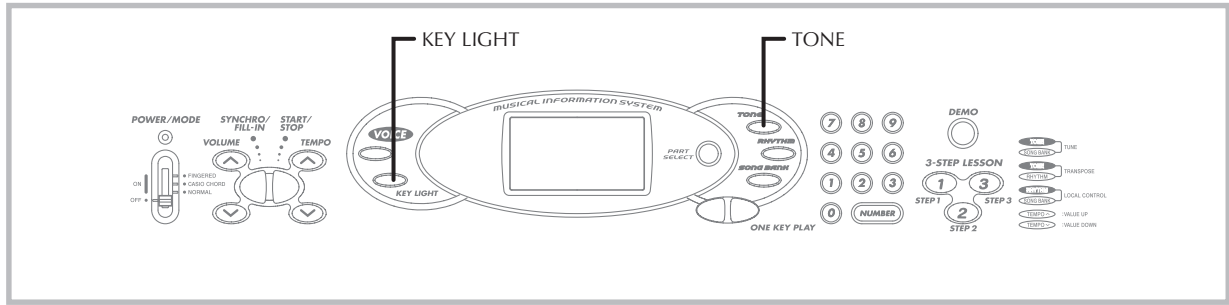

Key Lighting System Operation and Display Contents During 3-step Lesson Play

Whenever you select an Auto Accompaniment tune (00 to 84) for 3-step lesson play, the key lighting system shows you which keys to press, while the display shows you the fingerings.

Note Pitch

The keyboard key that should be pressed lights. The fingers you should use to play the notes are also shown on the display.

Note Length

Keyboard keys stay lit for as long as the note should be played. The fingerings also remain on the display for the length of the note.

Next Note

The keyboard key for the next note to be played flashes, while a number appears on the display near the finger you should use to play the next note.

Series of Same Pitch Notes

The keyboard key light turns off momentarily between the notes and lights again for each successive note. The fingerings also turn off and back on again.

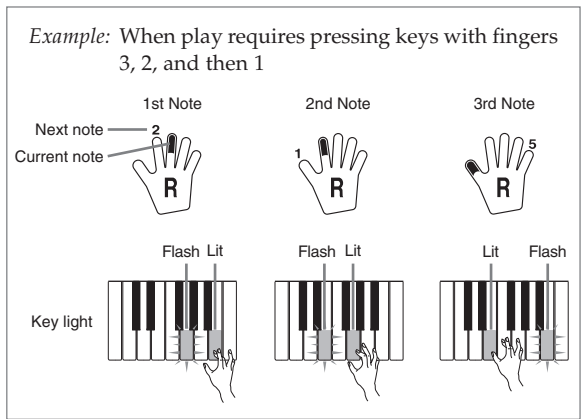

NOTE

- Note length is not indicated when you are using two-hand tunes (85 to 99) with 3-Step Lesson Steps 1 and 2. As soon as you press a lit key, it goes out and the next key to be played starts to flash.
- Note length is indicated by the key light system when you use a two-hand tune with Step 3. In this case, the next key to be pressed does not flash when you press a lit key and the next finger number does not appear on the display. Only the current finger number is shown.

Voice Fingering Guide

Voice fingering guide uses a simulated human voice to call out fingering numbers during Step 1 and Step 2 one-hand part practice. If you need to press a key with your thumb, for example, voice fingering guide says, "One!" In the case of a chord to be played with your thumb, middle and little finger, voice fingering guide says, "One, three, five!" Voice Fingering Guide calls out fingerings only when you do not press the proper key when you should.

To turn voice fingering guide on and off

Use the VOICE button to turn voice fingering guide on and off.



Voice fingering guide indicator

Timing Indicator

The timing indicator helps you become familiar with tunes you are playing for the first time by indicating the timing of notes you play on the keyboard. Timing is easier to see when you use a slow tempo during lesson play.

Using the Timing Indicator

The timing indicator shows the timing of notes contained in the currently selected part (R or L). Notes are indicated as two-segment blocks that scroll from the top of the display, down to the bottom. A note is played when its block reaches the bottom of the display.

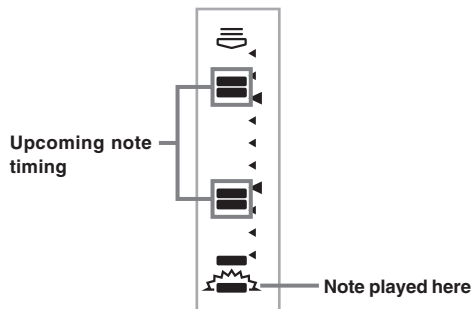

- Each two-segment block can indicate one or more notes, depending on the tune you are playing.

NOTE

- The Timing Indicator shows note timing whenever you play back a Song Bank tune and during a 3-Step Lesson.
- Note that the Timing Indicator shows approximate timing only. During a tune, the indicated timing can be anywhere from an eighth note to a 32nd off of actual timing.

Turning Off Key Lighting

1. Press the KEY LIGHT button.
 - The KEY LIGHT indicator disappears when the key light system is turned off.
 - Press the KEY LIGHT button again to turn key lighting back on.

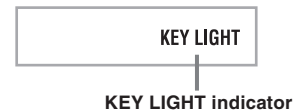

NOTE

Key lighting turns on automatically in any of the following cases:

- When keyboard power is turned on.
- When demo tune play is started.
- When the SONG BANK button is pressed in the normal mode (page E-22).
- When the power on alert function operates (page E-13).

Number of Simultaneously Lit Keys

Up to four keyboard keys can be lit at the same time.

To change the tone used for the melody of a Song Bank tune

1. Following step 3 of the procedure on page E-22, press the TONE button.
 - Both the SONG BANK indicator and TONE indicator appear, along with the tone number and name of the tone that is currently assigned to the keyboard.
2. Input a value to select the tone you want to use.

NOTE

- Selecting another Song Bank tune switches the tone setting to the newly selected tune's preset melody tone.
- The tone assigned to the keyboard is the same one specified for the melody of the Song Bank tune.
- The above procedure can be used to change the Song Bank melody tone before starting play or while play is already in progress.
- You can also change the tone of two-hand tunes (tune numbers 85 to 99). Note however, that selecting a sustainable tone (like an organ tone) when using 3-Step Lesson Step 1 or Step 2 (in which accompaniment waits for correct input from you before proceeding), can cause notes of the auto accompaniment to be sustained while the keyboard is waiting for your input. If this happens, play something on the keyboard to stop the sustained note.

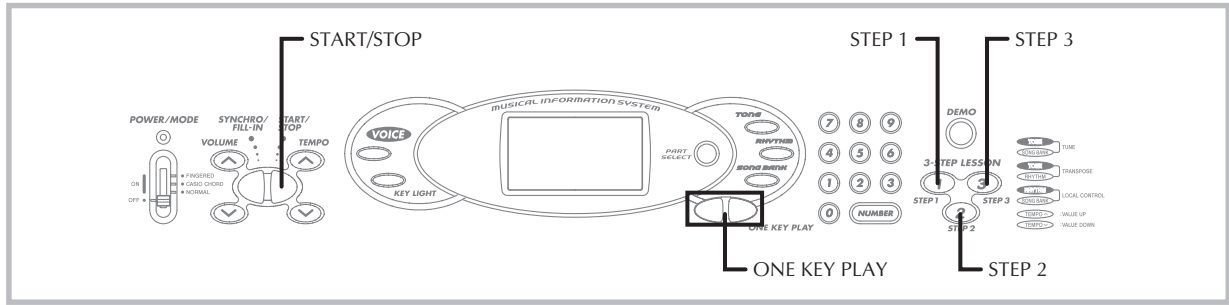

Step 1: Master the timing

You can press the ONE KEY PLAY buttons or any of the keyboard keys to play along with the melody (right hand part) of the Song Bank tune. You do not have to worry about pressing the right key, so you can concentrate on getting the timing right.

1. Press the STEP 1 button.
 - When you do, the STEP 1 indicator appears.
 - After a count sounds, the keyboard stands by and waits for you to play the first note of the tune. If the tune includes intro measures, the keyboard enters standby after the intro measures are complete.

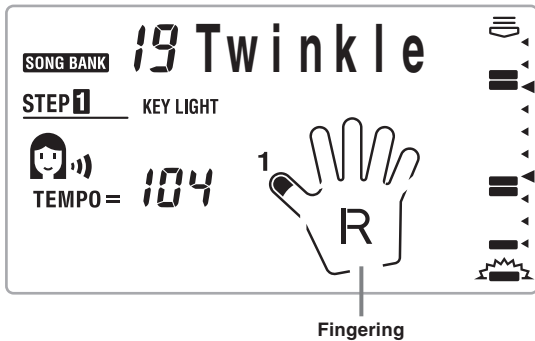

2. Press the ONE KEY PLAY buttons to play each note of the tune.
 - The accompaniment (left hand) part of the tune follows along as you play the melody (right hand) part.
 - The keyboard key that corresponds to the next note to be played flashes, and lights when you play the note.
 - The rhythm (percussion) part does not sound.
3. Try pressing any one of the keyboard keys in place of the ONE KEY PLAY buttons.
 - Pressing any keyboard key plays the correct melody (right hand part) note.
 - Pressing more than one key at the same time counts as a single melody note. Pressing a key while another key is held down is counted as two melody notes.

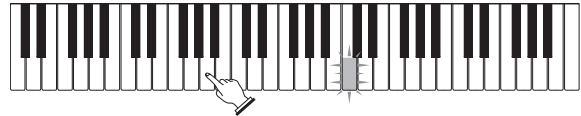

The correct note is played even if you do not press the key that is lit.

4. To stop play at any time, press the START/STOP button.
 - When you do, the STEP 1 indicator goes out.

Step 2: Master the melody

With Step 2 you have to play the note that the 3-Step Lesson System indicates. But don't worry - the accompaniment (left hand part) waits until you can play the correct note before continuing. This means you can take your time and play at your own pace.

1. Press the STEP 2 button.

- When you do, the STEP 2 indicator appears.
- After a count sounds, the keyboard stands by and waits for you to play the first note of the tune. If the tune includes intro measures, the keyboard enters standby after the intro measures are complete.

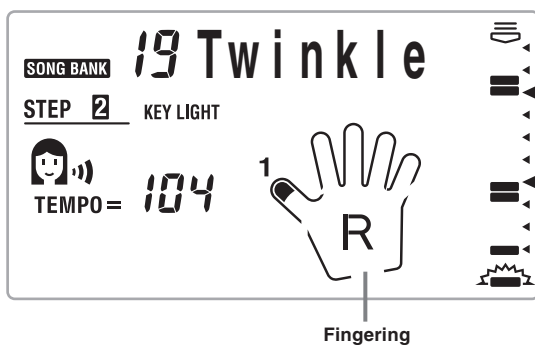

2. Play the notes indicated by the 3-Step Lesson System.

- The accompaniment (left hand) part of the tune follows along as you play the melody (right hand) part.
- The keyboard key that corresponds to the next note to be played flashes, and lights when you play the note.
- The rhythm (percussion) part does not sound.

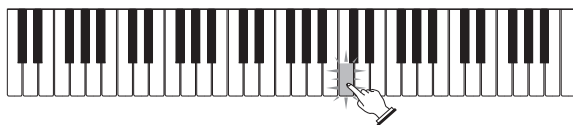

Press keyboard keys as they light. More than one key may light when you are playing a two-hand tune. Press all keys that light.

3. To stop play at any time, press the START/STOP button.

- When you do, the STEP 2 indicator goes out.

Step 3: Play at normal speed

Step 3 also shows you which notes to play, but unlike Step 2, it does not wait for you to press the key. The accompaniment part is played at normal speed, no matter what you play (or don't play) on the keyboard.

1. Press the STEP 3 button.

- When you do, the STEP 3 indicator appears.
- Play starts after a count sounds.

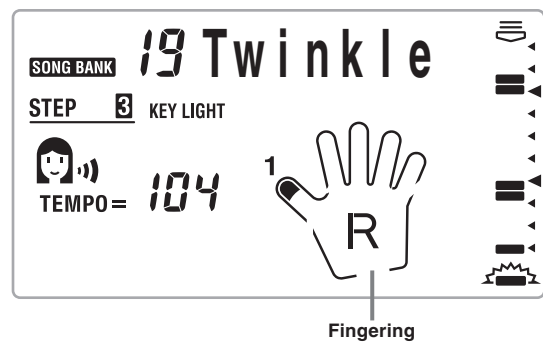

2. Play along on the keyboard, following the keys as they light.

- The accompaniment (left hand) part of the tune plays at normal speed, regardless of what you play on the keyboard.
- With an auto-accompaniment tune, the keyboard key that corresponds to the next note to be played flashes, and lights when the note should be played.
- With a two-hand tune, the applicable keyboard key remains lit as long as its note plays. In this case, however, the key for the next note to be played does not flash. Keys light when their notes start to play.

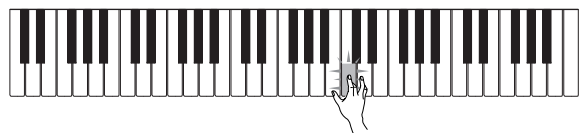

3. To stop play at any time, press the START/STOP button.

- When you do, the STEP 3 indicator goes out.

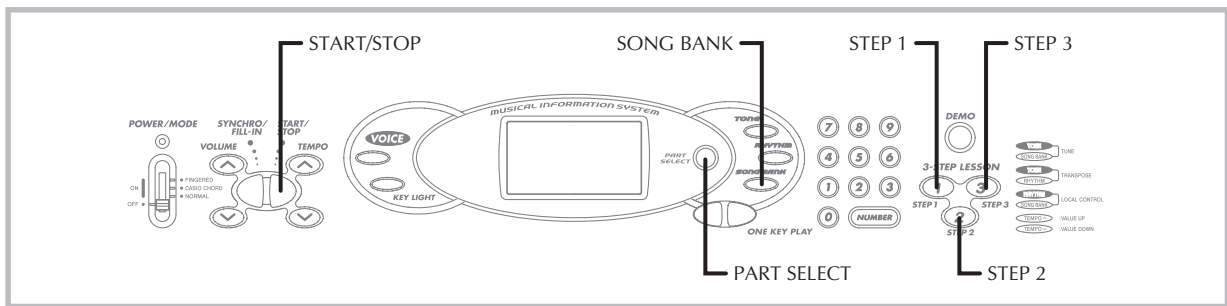

To practice the left hand part

Once you master right hand part play, you can use the two-hand tunes (numbers 85 through 99) to practice left hand part.

1. Press the SONG BANK button until the SONG BANK indicator appears.
 - This causes the number and name of the currently selected Song Bank tune to appear on the display.
2. Input the two digit number for the tune you want to play.
3. Press the PART SELECT button to switch the left hand play.

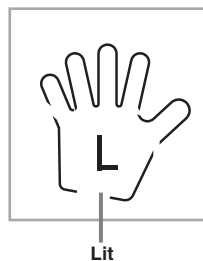

4. Press the STEP 1, STEP 2, or STEP 3 button.
 - When you do, the STEP 1, STEP 2, or STEP 3 indicator appears.
 - After a count beat sounds, the right-hand part starts to play and the keys for the left-hand part notes flash.
5. Press the PART SELECT button to return the part selection to its previous setting.
6. To interrupt play of the melody, press the START/STOP button.
 - When you do, the STEP 1, STEP 2, or STEP 3 indicator disappears.

MIDI

What is MIDI?

The letters MIDI stand for Musical Instrument Digital Interface, which is the name of a worldwide standard for digital signals and connectors that makes it possible to exchange musical data between musical instruments and computers (machines) produced by different manufacturers. MIDI compatible equipment can exchange keyboard key press, key release, tone change, and other data as messages. Though you do not need any special knowledge about MIDI to use this keyboard as a stand-alone unit, MIDI operations require a bit of specialized knowledge. This section provides you with an overview of MIDI that will help to get you going.

MIDI Connections

MIDI messages are sent out through the MIDI OUT terminal of one machine to the MIDI IN terminal of another machine over a MIDI cable. To send a message from this keyboard to another machine, for example, you must use a MIDI cable to connect the MIDI OUT terminal of this keyboard to the MIDI IN terminal of the other machine. To send MIDI messages back to this keyboard, you need to use a MIDI cable to connect the other machine's MIDI OUT terminal to the MIDI IN terminal of this keyboard.

To use a computer or other MIDI device to record and playback the MIDI data produced by this keyboard, you must connect the MIDI IN and MIDI OUT terminals of both machines in order to send and receive data.

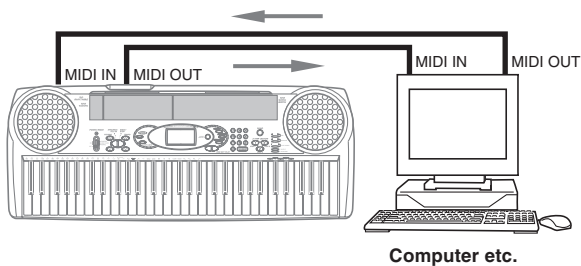

Computer etc.

MIDI Channels

MIDI allows you to send the data for multiple parts at the same time, with each part being sent over a separate MIDI channel. There are 16 MIDI channels, numbered 1 through 16, and MIDI channel data is always included whenever you exchange data (key press etc.).

Both the sending machine and the receiving machine must be set to the same channel for the receiving unit to correctly receive and play data. If the receiving machine is set to Channel 2, for example, it receives only MIDI Channel 2 data, and all other channels are ignored.

With this keyboard, messages received over MIDI Channels 1, 2, 3, 4, and 10 can be used for multi-timbre play of up to five different instrument parts. The tone and volume settings for these five channels must be controlled by messages sent from an external device.

Conversely, keyboard operations are sent to external devices over MIDI Channel 1.

General MIDI

General MIDI standardizes MIDI data for all sound source types, regardless of manufacturer. General MIDI specifies such factors as tone numbering, drum sounds, and available MIDI channels for all sound sources. This standard makes it possible for all MIDI equipment to reproduce the same nuances when playing General MIDI data, regardless of the manufacturer of the sound source.

Though the sound source of this keyboard is not General MIDI compatible, you can still connect the keyboard to a computer or other MIDI equipment to playback General MIDI data that is widely available in stores, over computer networks, and from other sources.

NOTE

- General MIDI data made up of a large number of parts may not play correctly on this keyboard.
- You will have most success playing back General MIDI data that has few parts and is made up of parts on channels 1, 2, 3, 4, and 10.

Messages

There is a wide variety of messages defined under the MIDI standard, and this section details the particular messages that can be sent and received by this keyboard.

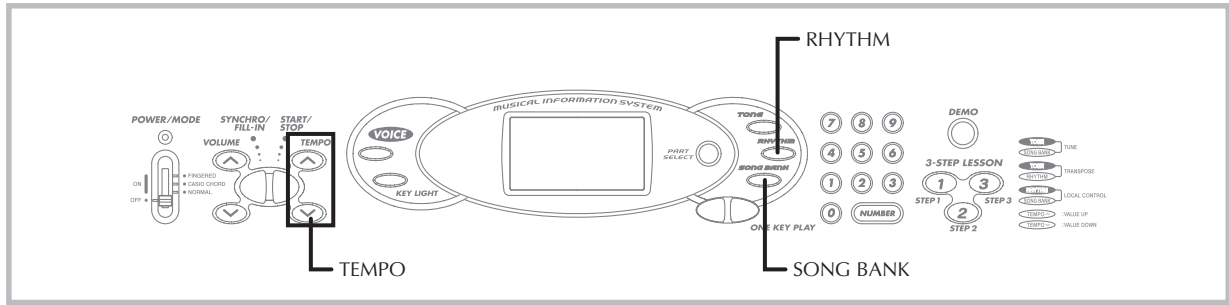

NOTE ON/OFF

This message sends data when a key is pressed (NOTE ON) or released (NOTE OFF).

A NOTE ON/OFF message includes a note number (to indicate note whose key is being pressed or released) and velocity (velocity=100 when the volume value of this unit is 9 to 2, and velocity=75 when the volume value is 1 or 0). NOTE ON velocity is always used to determine the relative volume of the note. This keyboard does not receive NOTE OFF velocity data.

Whenever you press or release a key on this keyboard, the corresponding NOTE ON or NOTE OFF message is sent by constant velocity from the MIDI OUT terminal.

PROGRAM CHANGE

This is the tone selection message. PROGRAM CHANGE can contain tone data within the range of 0 to 127.

A PROGRAM CHANGE message (0 to 99) is sent out through this keyboard's MIDI OUT terminal whenever you manually change its tone number. Receipt of a PROGRAM CHANGE message from an external machine changes the tone setting of this keyboard.

This keyboard can send tone data within the range of 00 to 99 and receive tone data within the range of 0 to 127*. Each of the 128 General MIDI tones is automatically assigned to one of the keyboard's 100 built-in tones as shown on page A-1. Select this setting when you want to listen to General MIDI data from a computer or other external equipment.

* When GM mapping is turned on (page E-31). When turned off, tone data is received in the range of 0 to 99.

NOTE

- Channel 10 is for the drum part only, and it does not receive Program Change messages. When receiving MIDI data, it sounds percussion sounds produced by this keyboard.

PITCH BEND

This message carries pitch bend information for smoothly sliding the pitch upwards or downwards during keyboard play. This keyboard does not send pitch bend data, but it can receive such data.

CONTROL CHANGE

This message adds effects such as vibrato and volume changes applied during keyboard play. CONTROL CHANGE data includes a control number (to identify the effect type) and a control value (to specify the on/off status and depth of the effect).

The following is a list of data that can be received using CONTROL CHANGE.

Effect	Control Number
VOLUME	7
HOLD1	64
MODULATION	1

LOCAL CONTROL (Default: on) /GM mapping (Default: off)

This setting determines whether or not the keyboard and sound source of this keyboard are connected internally. When recording to a computer or other external device connected to this keyboard's MIDI IN/OUT terminal, it helps if you turn LOCAL CONTROL off.

on: Anything played on the keyboard is sounded by the internal sound source and simultaneously output as a MIDI message from the MIDI OUT terminal.

off: Anything played on the keyboard is output as a MIDI message from the MIDI OUT terminal, without being sounded by the internal sound source. Turn LOCAL CONTROL off whenever you are using the MIDI THRU function of a computer or other external device. Also note that no sound is produced by the keyboard if LOCAL CONTROL is turned off and no external device is connected.

NOTE

- When you are using this keyboard in a stand-alone configuration, keyboard keys do not light while local control is turned off.

LOCAL CONTROL On

Notes played on the keyboard are sounded by the internal sound source and output as MIDI messages from the MIDI OUT terminal.

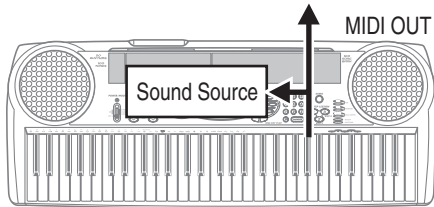

LOCAL CONTROL Off

Notes played on the keyboard are output as MIDI messages from the MIDI OUT terminal, but not sounded directly by the internal sound source. The MIDI THRU terminal of the connected device can be used to return the MIDI message and sound it on this keyboard's sound source.

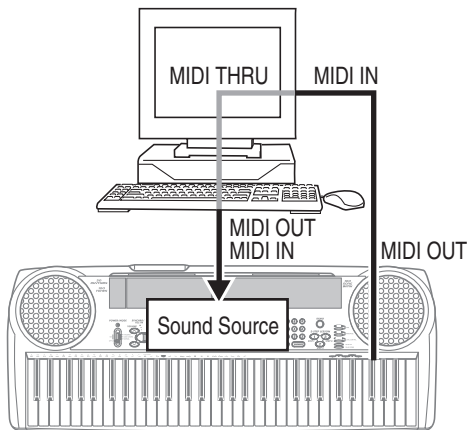

To turn off LOCAL CONTROL/To turn on GM mapping

1. While in any mode besides the Song Bank Mode (indicated when the SONG BANK indicator is lit), hold down the RHYTHM button and press the SONG BANK button.
 - Perform step 2 within five seconds after performing step 1.
2. Use the TEMPO button (⌚) to turn off local control.
 - This also turns on GM mapping.

off Local

To turn on LOCAL CONTROL/To turn off GM mapping

1. While in any mode besides the Song Bank Mode (indicated when the SONG BANK indicator is lit), hold down the RHYTHM button and press the SONG BANK button.
 - Perform step 2 within five seconds after performing step 1.
2. Use the TEMPO button (⌚) to turn on local control.
 - This also turns off GM mapping.

on Local

NOTE

- Note that LOCAL CONTROL is also turned on automatically whenever you turn on power, or when you press any of the following buttons.
 - START/STOP (to start rhythm or Song Bank tune play)
 - ONE-KEY PLAY
 - STEP 1
 - STEP 2
 - STEP 3
 - DEMO (to start demo tune play)
- See the GM Tone Map List at the back of this manual for information about tone assignments while GM mapping is turned on.

Technical Reference

Troubleshooting

Be sure to check the following table whenever you experience problems with keyboard operation.

Symptom	Cause	Action	See Page
<ul style="list-style-type: none"> No sound when keyboard keys are pressed. 	<ol style="list-style-type: none"> Power supply problem. Volume is set to 0. Headphones are plugged into the keyboard. The POWER/MODE selector is in the CASIO CHORD or FINGERED position. Tone "99 PERCUSSION" is selected and you are pressing keys that are not assigned tones. LOCAL CONTROL is off. 	<ol style="list-style-type: none"> Correctly attach the AC adaptor, make sure that batteries (+/-) are facing correctly, and check to make sure that batteries are not dead. Press the VOLUME  button. Unplug the headphones from the PHONES/OUTPUT jack. Normal play is not possible on the accompaniment keyboard while the POWER/MODE selector is set to CASIO CHORD or FINGERED. Change the POWER/MODE selector setting to NORMAL. While "99 PERCUSSION" is selected, you can use only keys that are marked on the console with illustrations of percussion instruments. Turn on LOCAL CONTROL. 	<p>Page E-12</p> <p>Page E-15</p> <p>Page E-14</p> <p>Page E-18</p> <p>Page E-16</p> <p>Page E-31</p>
<ul style="list-style-type: none"> Any of the following symptoms while using battery power. <ul style="list-style-type: none"> Dim power indicator Instrument does not turn on Display that is flickering, dim, or difficult to read Abnormally low speaker/headphone volume Distortion of sound output Occasional interruption of sound when playing at high volume Sudden power failure when playing at high volume Flickering or dimming of the display when playing at high volume Continued sound output even after you release a key A tone that is totally different from the one that is selected Abnormal rhythm pattern and Song Bank play Loss of power, sound distortion, or low volume when playing from a connected computer or MIDI device 	<ul style="list-style-type: none"> Low battery power 	<ul style="list-style-type: none"> Replace the batteries with a set of new ones or use the AC adaptor. 	<p>Page E-12</p>
<ul style="list-style-type: none"> Key light stays on. 	<ul style="list-style-type: none"> Keyboard is waiting for play of the correct note during Step 1 or Step 2 play. 	<ol style="list-style-type: none"> Press the lit key to continue with Step 1 or Step 2 play. Press the START/STOP button to quit Step 1 or Step 2 play. 	<p>Pages E-26, 27</p> <p>Pages E-26, 27</p>

Symptom	Cause	Action	See Page
<ul style="list-style-type: none"> Keyboard keys light but no sound is produced. 	<ul style="list-style-type: none"> Power on alert is telling you that power is left on. 	<ul style="list-style-type: none"> Press any button or keyboard key to resume normal operation with the keyboard in its initial power on setting. 	Page E-13
<ul style="list-style-type: none"> RHYTHM button does not work. 	<ul style="list-style-type: none"> Keyboard is in the Song Bank Mode. 	<ul style="list-style-type: none"> Press the SONG BANK button to return to the normal mode. 	Page E-23
<ul style="list-style-type: none"> Cannot change TRANSPOSE/TUNE/LOCAL CONTROL settings. 	<ul style="list-style-type: none"> Keyboard is in the Song Bank Mode. Demo tune play is in progress. 	<ul style="list-style-type: none"> Press the SONG BANK button to return to the normal mode. Stop demo tune play. 	Page E-23 Page E-18
<ul style="list-style-type: none"> No sound is produced when playing MIDI data from a computer. 	<ul style="list-style-type: none"> MIDI cables are not connected properly. 	<ul style="list-style-type: none"> Connect MIDI cables properly. 	Page E-29
<ul style="list-style-type: none"> Playing on the keyboard produces an unnatural sound when connected to a computer. 	<ul style="list-style-type: none"> The computer's MIDI THRU function is turned on. 	<ul style="list-style-type: none"> Turn off the MIDI THRU function on the computer or turn off LOCAL CONTROL on the keyboard. 	Page E-31

Specifications

Model:	LK-43
Keyboard:	61 standard-size keys; 5 octaves
Key Light System:	Can be turned on and off (up to 4 keys can be lit at the same time)
Tones:	100 presets
Polyphony:	12 notes maximum
3-Step Lesson System:	Number of simultaneously lit keys; 4 3-Steps 1 tune repeat playback On/Off
Auto-accompaniment Rhythm patterns: Tempo: Chords: Other:	50 presets Adjustable, (216 steps, ♩ = 40 to 255), initial value; 120 Two systems; CASIO CHORD, FINGERED Fill-in pattern, Synchro start
Song Bank tunes:	100 tunes
Musical Information Function:	Tone, Auto Accompaniment, Song Bank numbers and names; tempo, step lesson display, chord name, fingering, timing indicator, key lighting, voice fingering
Other Functions: Transpose: Tuning:	F# to C to F: half-note Adjustable A4 = Approx. 440 Hz ±50 cents, Initial value: A4 = Approx. 440 Hz
MIDI:	5 multi-timbre receive
Speakers:	10 cm diameter x 2 (Output: 2W+2W)
Digital Volume Control:	Main volume; 10 steps (0 to 9), initial value: 7
I/O Terminals MIDI Terminals: Sustain: Power Supply: Headphones/Output:	IN, OUT Standard jack DC 9V jack Stereo standard jack (Output is monaural.) [output impedance: 78Ω, output voltage: 4V (RMS) MAX],
Power Supply: Batteries: Battery life: AC adaptor : Auto Power Off:	2-way 6 AA-size approximately 1 hour on R6P (SUM3) manganese batteries/ 4 hours on LR6 (AM3) alkaline batteries AD-5 Approximately 6 minutes after the last operation (Operates during battery use only)
Power Consumption:	9 V --- 7.7 W
Dimensions:	94.4 x 36.3 x 11.8 cm (37 ³ / ₁₆ " x 14 ⁵ / ₁₆ " x 4 ⁵ / ₈ ")
Weight:	Approximately 4.5 kg (9.9 lbs) (without batteries)

* Designs and specifications are subject to change without notice.

Care of Your Keyboard

Avoid heat, humidity or direct sunlight.

Do not overexpose the instrument to direct sunlight, or place it near an air conditioner, or in any extremely hot place.

Do not use near a TV or radio.

This instrument can cause video or audio interference with TV and radio reception. If this happens, move the instrument away from the TV or radio.

Do not use lacquer, thinner or similar chemicals for cleaning.

Clean the keyboard with a soft cloth dampened in a weak solution of water and a neutral detergent. Soak the cloth in the solution and squeeze until it is almost dry.

NOTE

- You may notice lines in the finish of the case of this keyboard. These lines are a result of the molding process used to shape the plastic of the case. They are not cracks or breaks in the plastic, and are no cause for concern.

Appendix/Apéndice

GM Tone Map List

Lista de asignaciones de sonido GM

Tone No./Tone Name Nº de sonido/Nombre de sonido	GM No. Nº GM	Tone No./Tone Name Nº de sonido/Nombre de sonido	GM No. Nº GM
00 GRAND PIANO	0	50 SOPRANO SAX	64
01 BRIGHT PIANO	1	51 ALTO SAX	65
02 HONKY-TONK	3	52 TENOR SAX	66 67
03 E GRAND PIANO	2	53 OBOE	68
04 ELEC PIANO 1	4	54 CLARINET	71
05 ELEC PIANO 2	5	55 PICCOLO	72
06 ELEC PIANO 3	8	56 FLUTE	73
07 ELEC PIANO 4	9	57 RECORDER	74 79
08 HARPSICORD	6	58 FLUTE ENSEMBLE	75 76 77
09 CLAVI	7	59 WHISTLE	78
10 ELEC ORGAN 1	16	60 SYNTH-LEAD 1	87
11 ELEC ORGAN 2	17	61 SYNTH-LEAD 2	81 86
12 ELEC ORGAN 3	18	62 SYNTH-LEAD 3	80
13 ELEC ORGAN 4	15	63 CALLIOPE	82
14 CHURCH ORGAN	19	64 SYNTH-PAD 1	89
15 PIPE ORGAN	104	65 SYNTH-PAD 2	90
16 REED ORGAN	20	66 SYNTH-PAD 3	95
17 ACCORDION	21	67 BOWED GLASS	92 93 98
18 BANDONEON	23	68 HALO PAD	54 94
19 HARMONICA	22	69 SYNTH-BASS	38 39
20 NYLON STR GT	24	70 RAIN DROP	96
21 STEEL STR GT	25	71 SF	103
22 JAZZ GUITAR	26	72 SOUNDTRACK	97
23 CLEAN GUITAR	27	73 SPACE PAD	101
24 MUTE GUITAR	28	74 SYNTH-SFX	102
25 DIST GUITAR	29 30 31 84	75 VEHICLE	125
26 ACOUSTIC BASS	32	76 TELEPHONE	124
27 ELEC BASS	33 34 35	77 SPACE	126
28 SLAP BASS	36 37	78 INVADER	127
29 BANJO	105	79 FUNNY	123
30 VIOLIN	40 41	80 STRINGS PIANO	106
31 CELLO	42 43	81 STRINGS EP	88 107
32 HARP	45 46 47	82 CHOIR EP	108
33 STRINGS 1	48 55	83 CHOIR ORGAN	109
34 STRINGS 2	49	84 STRINGS GUITAR	99 110
35 STRINGS 3	44	85 STRINGS HARP	111
36 SYNTH-STR 1	50	86 BRASS STRINGS	112
37 SYNTH-STR 2	51	87 VIB PAD	113
38 CHOIR AAHS	52 91	88 12STR GUITAR	114
39 SYNTH-VOICE	53 85	89 CHOIR STRINGS	115
40 TRUMPET	56	90 BASS/PIANO	100 116
41 TUBA	58	91 BASS/E PIANO	117
42 BRASS SECTION	57	92 BASS/VIB	118
43 FRENCH HORN 1	60	93 BASS/NYLON STR GT	119
44 FRENCH HORN 2	59	94 BASS/DIST GUITAR	120
45 BRASS 1	61	95 STRINGS/PIANO	121
46 BRASS 2	69	96 STRINGS/TRUMPET	122
47 SYNTH-BRASS 1	62	97 VIBRAPHONE	10 11 14
48 SYNTH-BRASS 2	63 83	98 MARIMBA	12 13
49 SYNTH-BRASS 3	70	99 PERCUSSION	

Rhythm List

Lista de ritmos

POPS		DANCE/FUNK	
00	CLUB POP	26	TECHNO
01	FUNKY POP	27	TRANCE
02	SOUL BALLAD	28	DISCO
03	POP BALLAD	29	FUNK
04	LITE POP	30	RAP
05	16 BEAT FUNK	EUROPEAN	
06	8 BEAT POP	31	POLKA
07	POP ROCK	32	MARCH
08	DANCE POP	33	WALTZ
09	POP FUSION	34	SLOW WALTZ
10	FOLKIE POP	35	TANGO
ROCK		LATIN/VARIOUS I	
11	ROCK WALTZ	36	BOSSA NOVA
12	SLOW ROCK	37	SAMBA
13	SOFT ROCK	38	MAMBO
14	50'S ROCK	39	REGGAE
15	60'S SOUL	40	SKA
16	4 BEAT ROCK	41	SALSA
17	ROCK	42	FOLKLORE
18	TWIST	43	RUMBA CATALANA
19	NEW ORLNS R&R	VARIOUS II	
20	R&B	44	COUNTRY
JAZZ/FUSION		45	TOWNSHIP
21	BIG BAND	46	SLOW GOSPEL
22	SWING	47	BALADI
23	FOX TROT	48	BAROQUE
24	JAZZ WALTZ	49	NEW AGE
25	LATIN FUSION		

Fingered Chord Charts

Cuadros de acordes digitados

This table shows the left-hand fingerings (including inverted forms) for a number of often-used chords.

Esta tabla muestra las digitaciones (incluyendo las formas invertidas) para varios de los acordes más a menudo usados.

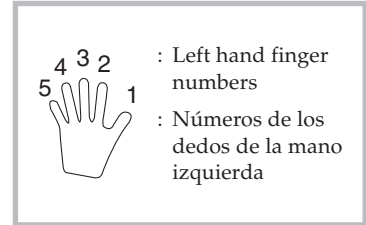

Chord Root \ Type	M	m	7	m7	dim7	M7	m7 ^b 5	dim
C	[5, 3, 1]	[5, 3, 1]	[5, 3, 2, 1]	[5, 3, 2, 1]	[5, 3, 2, 1]	[5, 3, 2, 1]	[5, 3, 2, 1]	[5, 3, 2]
C [#] (D ^b)	[5, 3, 1]	[5, 3, 1]	[5, 3, 2, 1]	[5, 3, 2, 1]	[5, 3, 2, 1]	[5, 3, 2, 1]	[5, 3, 2, 1]	[5, 3, 2]
D	[5, 3, 1]	[5, 3, 1]	[5, 3, 2, 1]	[5, 3, 2, 1]	[5, 3, 2, 1]	[5, 3, 2, 1]	[5, 3, 2, 1]	[5, 3, 2]
E ^b (D [#])	[5, 3, 1]	[5, 3, 1]	[5, 3, 2, 1]	[5, 3, 2, 1]	[5, 3, 2, 1]	[5, 3, 2, 1]	[5, 3, 2, 1]	[5, 3, 2]
E	[5, 3, 1]	[5, 3, 1]	[5, 3, 2, 1]	[5, 3, 2, 1]	[5, 3, 2, 1]	[5, 3, 2, 1]	[5, 3, 2, 1]	[5, 3, 2]
F	[5, 3, 1]	[5, 3, 1]	[5, 3, 2, 1]	[5, 3, 2, 1]	[5, 3, 2, 1]	[5, 3, 2, 1]	[5, 3, 2, 1]	[5, 3, 2]
F [#] (G ^b)	[5, 3, 1]	[5, 3, 1]	[5, 3, 2, 1]	[5, 3, 2, 1]	[5, 3, 2, 1]	[5, 3, 2, 1]	[5, 3, 2, 1]	[5, 3, 2]
G	[5, 3, 1]	[5, 3, 1]	[5, 3, 2, 1]	[5, 3, 2, 1]	[5, 3, 2, 1]	[5, 4, 2, 1]	[5, 3, 2, 1]	[5, 3, 2]
A ^b (G [#])	[5, 3, 1]	[5, 3, 1]	[5, 4, 2, 1]	[5, 4, 2, 1]	[5, 3, 2, 1]	[5, 4, 2, 1]	[5, 4, 2, 1]	[5, 3, 2]
A	[5, 3, 1]	[5, 3, 1]	[5, 4, 2, 1]	[5, 4, 2, 1]	*	[5, 4, 2, 1]	[5, 4, 2, 1]	[5, 3, 2]
B ^b (A [#])	[5, 3, 1]	[5, 3, 1]	[5, 4, 2, 1]	[5, 4, 2, 1]	*	[5, 4, 2, 1]	[5, 4, 2, 1]	[5, 3, 2]
B	[5, 2, 1]	[5, 2, 1]	[5, 3, 2, 1]	[5, 3, 2, 1]	*	[5, 3, 2, 1]	[5, 4, 2, 1]	[5, 3, 2]

Chord Root Type	aug	sus4	7 sus4	m add9	m M7	7 ^b 5	add9
C	[5, 3, 1]	[5, 2, 1]	[5, 3, 2, 1]	[4, 3, 2, 1]	[5, 3, 2, 1]	[5, 3, 2, 1]	[4, 3, 2, 1]
C [#] (D ^b)	[5, 3, 1]	[5, 2, 1]	[5, 3, 2, 1]	[4, 3, 2, 1]	[5, 3, 2, 1]	[5, 3, 2, 1]	[4, 3, 2, 1]
D	[5, 3, 1]	[5, 2, 1]	[5, 3, 2, 1]	[4, 3, 2, 1]	[5, 3, 2, 1]	[5, 3, 2, 1]	[4, 3, 2, 1]
E ^b (D [#])	[5, 3, 1]	[5, 2, 1]	[5, 3, 2, 1]	[4, 3, 2, 1]	[5, 3, 2, 1]	[5, 3, 2, 1]	[4, 3, 2, 1]
E	[5, 3, 1]	[5, 2, 1]	[5, 3, 2, 1]	[4, 3, 2, 1]	[5, 3, 2, 1]	[5, 3, 2, 1]	[4, 3, 2, 1]
F	[5, 3, 1]	[5, 2, 1]	[5, 3, 2, 1]	[4, 3, 2, 1]	[5, 3, 2, 1]	[5, 3, 2, 1]	[4, 3, 2, 1]
F [#] (G ^b)	[5, 3, 1]	[5, 2, 1]	[5, 3, 2, 1]	[4, 3, 2, 1]	[5, 3, 2, 1]	[5, 3, 2, 1]	[4, 3, 2, 1]
G	[5, 3, 1]	[5, 2, 1]	[5, 3, 2, 1]	[4, 3, 2, 1]	[5, 4, 2, 1]	[5, 3, 2, 1]	[4, 3, 2, 1]
A ^b (G [#])	[5, 3, 1]	[5, 2, 1]	[5, 4, 2, 1]	[4, 3, 2, 1]	[5, 4, 2, 1]	[5, 4, 2, 1]	[4, 3, 2, 1]
A	[5, 3, 1]	[5, 2, 1]	[5, 4, 2, 1]	[4, 3, 2, 1]	[5, 4, 2, 1]	[5, 4, 2, 1]	[4, 3, 2, 1]
B ^b (A [#])	*	[5, 2, 1]	[5, 4, 2, 1]	[4, 3, 2, 1]	[5, 4, 2, 1]	[5, 4, 2, 1]	[4, 3, 2, 1]
B	*	[5, 2, 1]	[5, 3, 2, 1]	[5, 3, 2, 1]	[5, 3, 2, 1]	[4, 3, 2, 1]	[5, 3, 2, 1]

* Cannot be specified in FINGERED setting because of accompaniment keyboard limitations, but augmented (seventh) chords made up of the same component notes (with different base note) can be used instead.

Chords with same component notes as B^b aug D aug, F[#] aug
 Chords with same component notes as B aug E^b aug, G aug
 Chords with same component notes as A dim7 C dim7, E^b dim7, F[#] dim7
 Chords with same component notes as B^b dim7 C[#] dim7, E dim7, G dim7
 Chords with same component notes as B dim7 D dim7, F dim7, A^b dim7

* No puede especificarse en el ajuste FINGERED debido a las limitaciones del teclado de acompañamiento, pero en su lugar pueden usarse los acordes aumentados y disminuidos (séptima) compuestos por las mismas notas componentes (con diferente nota básica).

Acordes con las mismas notas componentes como B^b aumentada D aumentada, F[#] aumentada.
 Acordes con las mismas notas componentes como B aumentada E^b aumentada, G aumentada.
 Acordes con las mismas notas componentes como A dim7 C dim7, E^b dim7, F[#] dim7.
 Acordes con las mismas notas componentes como B^b dim7 C[#] dim7, E dim7, G dim7.
 Acordes con las mismas notas componentes como B dim7 D dim7, F dim7, A^b dim7.

Model **LK-43**

MIDI Implementation Chart

Version: 1.0

Function ...	Transmitted	Recognized	Remarks
Basic Channel	1 1	1-4, 10 1-4, 10	
Mode	Mode 3 X *****	Mode 3 X *****	
Note Number:	36-96 *****	0-127 36-96 *1	*1: Depends on tone
Velocity	Note ON Note OFF	9nH v = 75, 100 *2 9nH v = 0	*3 = no relation
After Touch	Key's Ch's	X X	
Pitch Bender	X	O	
Control Change	1 6,38 7 10 11	X X X X X	Modulation Data entry Volume Pan Expression

<p>64 100,101 120 121</p>	<p>Program Change: True #</p>	<p>System Exclusive</p> <p>System Common : Song Pos : Song Sel : Tune</p> <p>System Real Time : Clock : Commands</p> <p>Aux Messages : Local ON/OFF : All notes OFF : Active Sense : Reset</p>	<p>64 100,101 120 121</p>	<p>Hold1 RPN LSB, MSB All sound off Reset all controller</p>
<p>O X X X</p>	<p>O 0-99 *****</p>	<p>X</p>	<p>O 0-127, 0-99 *4 *****</p>	<p>*4: Depends on GM Map setting</p>
<p>X X X X</p>	<p>X</p>	<p>X X X X</p>	<p>X X</p>	<p></p>
<p>X X X X</p>	<p>X X X X</p>	<p>X X</p>	<p>X X X X</p>	<p></p>
		<p>*2: V(Velocity)=100 when note on data when the volume value of this unit is 9 to 2, and V=75 when the volume value is 1 or 0.</p>		

O : Yes
X : No

Mode 2 : OMNI ON, MONO
Mode 4 : OMNI OFF, MONO

Mode 1 : OMNI ON, POLY
Mode 3 : OMNI OFF, POLY



This recycle mark indicates that the packaging conforms to the environmental protection legislation in Germany.

Esta marca de reciclaje indica que el empaquetado conforma a la legislación de protección ambiental en Alemania.

CASIO®

CASIO COMPUTER CO.,LTD.
6-2, Hon-machi 1-chome
Shibuya-ku, Tokyo 151-8543, Japan

P
MA0203-A (英) (西) Printed in China
LK43-ES-1