

# RV-5 Digital Reverb

## Owner's Manual

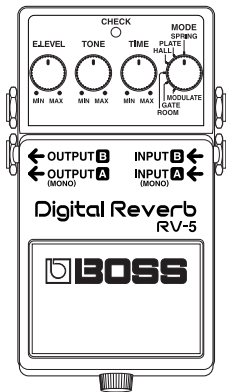

AC & BATTERY  
POWERED



**BOSS**<sup>®</sup>

---

Thank you, and congratulations on your choice of BOSS RV-5 Digital Reverb.

Before using this unit, carefully read the sections entitled: "USING THE UNIT SAFELY" and "IMPORTANT NOTES" (separate sheet). These sections provide important information concerning the proper operation of the unit.

Additionally, in order to feel assured that you have gained a good grasp of every feature provided by your new unit, this manual should be read in its entirety. The manual should be saved and kept on hand as a convenient reference.

**A battery is supplied with the unit. The life of this battery may be limited, however, since its primary purpose was to enable testing.**

**Copyright © 2002 BOSS CORPORATION**

**All rights reserved. No part of this publication may be reproduced in any form without the written permission of BOSS CORPORATION.**

---

## Features

- This high-quality, multifunction digital reverb gives you the quality of a studio effect, but condensed into a compact pedal.
- Models the sound of the spring reverb from Accutronics, a name synonymous with spring reverb. The emulation on modeling is so realistic that even the sound of the oscillations resulting from the mutual interference between dual springs is reproduced.
- Comes with a completely new “modulate” feature for the reverb, which adds modulation to the hall reverb, producing an extremely pleasant reverb sound.
- Includes a new type of “gate reverb.” This reverb produces a uniquely distinctive effect which condenses the reverberation sound.
- Thanks to a 2-in/2-out stereo configuration, the RV-5 offers three dimensional reverb sound.

*\* All product names mentioned in this document are trademarks or registered trademarks of their respective owners. These names, as used in this manual, are for the purpose of accurately describing the sounds created with modeling.*

# Panel Description

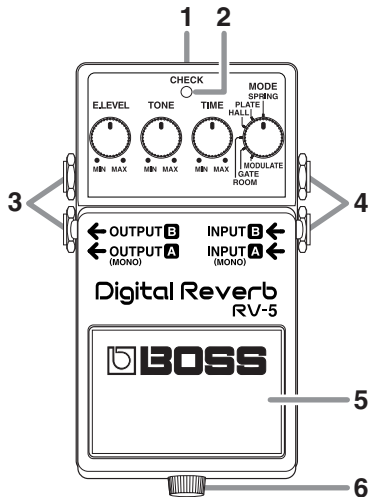

## 1. AC Adaptor Jack

Accepts connection of an AC Adaptor (optionally available BOSS PSA-Series). By using an AC Adaptor, you can play without being concerned about how much battery power you have left.

- \* As soon as you connect the AC adaptor, the unit is turned on.
- \* If there are batteries in the unit while an AC adaptor is being used, normal operation will continue should the line voltage be interrupted (power blackout or power cord disconnection).
- \* Use only the specified AC adaptor (PSA-Series).

---

## 2. CHECK Indicator

This indicator shows whether an effect is ON/OFF, and also doubles as the Battery Check indicator. The indicator lights when an effect is ON.

- \* *If this indicator goes dim or no longer lights while an effect is ON, the battery is near exhaustion and should be replaced immediately. For instructions on changing the battery, refer to “Changing the Battery” (p. 12).*
- \* *The CHECK indicator shows whether the effect is being applied or not. It does not indicate whether the power to the device is on or not.*

## 3. OUTPUT-A (MONO) Jack OUTPUT-B Jack

The output jacks are used to connect the unit to an amplifier or another effects unit.

## 4. INPUT-A (MONO) Jack INPUT-B Jack

These jacks accept input signals (coming from a guitar, some other musical instrument, or another effects unit).

- \* *The unit’s functions differ according to how it is connected. Refer to “Outputting Only the Effect” (p. 11).*
- \* *When running the unit on battery power, the INPUT-A (MONO) and INPUT-B jacks double as power switches. Power to the unit is turned on when you plug into the INPUT-A (MONO) or INPUT-B jack; the power is turned off when the cable is unplugged. Be sure to disconnect any cord plugged into the INPUT-A (MONO) or INPUT-B jack when not using this effects device. When the AC adaptor is used, the power remains on at all times, and this function is disabled.*

## 5. Pedal Switch

Used for switching effects on/off, and for inputting the tempo.

## 6. Thumbscrew

When this screw is loosened, the pedal will open, allowing you to change the battery.

*\* For instructions on changing the battery, refer to "Changing the Battery" (p. 12).*

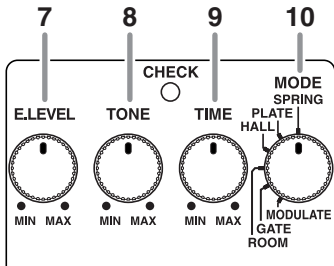

## 7. E.LEVEL (effect level) Knob

This adjusts the volume of the effect sound. Turn the knob to the right (clockwise) to increase the effect sound.

---

## 8. TONE Knob

This adjusts the tone of the reverb sound. The more you turn the knob to the right (clockwise) of center (standard), the brighter the sound becomes; turn the knob to the left of center to create a sound with greater warmth.

## 9. TIME Knob

This adjusts the length (time) of the reverb sound.

## 10. MODE Switch

Selects the reverb effect and pedal mode.

*\* Immediately after the MODE switch is switched, operating the pedal produces no result.*

### SPRING:

This simulates the sound of a guitar amp's built-in spring reverb.

### PLATE:

This simulates the sound of a plate echo (a type of reverb that uses the vibrations of a metal plate). It provides a metallic-sounding reverberation with an extended high end.

### HALL:

This simulates the reverb sound of a larger hall.

### ROOM:

This simulates the reverb sound of a smaller room.

### GATE:

Produces a uniquely distinctive effect in which the reverberation sound is condensed.

### MODULATE:

This is a completely new reverb that adds modulation to the hall reverb to produce an extremely pleasant reverb sound.

# Connections

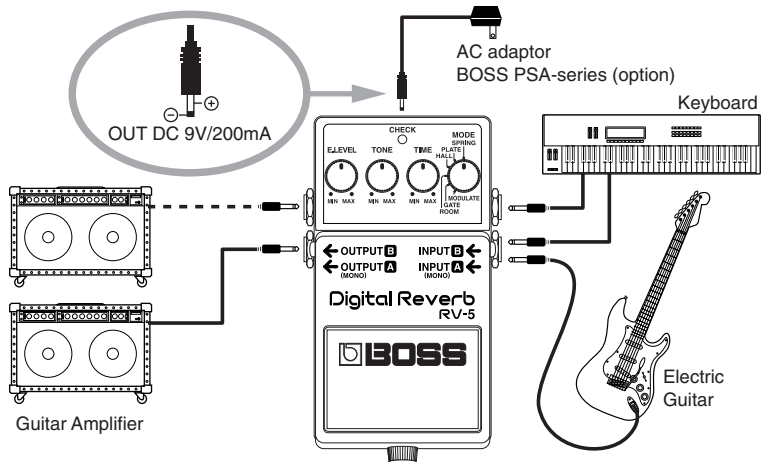

\* Be sure to lower the output level of any device being connected.



- \* *When running the unit on battery power, inserting a plug into the INPUT-A (MONO) or INPUT-B Jack will automatically switch the unit on.*
  - \* *The use of an AC adaptor is recommended as the unit's power consumption is relatively high. Should you prefer to use batteries, please use the alkaline type.*
  - \* *To prevent malfunction and/or damage to speakers or other devices, always turn down the volume, and turn off the power on all devices before making any connections.*
  - \* *If there are batteries in the unit while an AC adaptor is being used, normal operation will continue should the line voltage be interrupted (power blackout or power cord disconnection).*
  - \* *Once the connections have been completed (p. 8), turn on power to your various devices in the order specified. By turning on devices in the wrong order, you risk causing malfunction and/or damage to speakers and other devices.*
    - When powering up: Turn on the power to your guitar amp last.*
    - When powering down: Turn off the power to your guitar amp first.*
  - \* *Always make sure to have the volume level turned down before switching on power. Even with the volume all the way down, you may still hear some sound when the power is switched on, but this is normal, and does not indicate a malfunction.*
  - \* *When operating on battery power only, the unit's indicator will become dim when battery power gets too low. Replace the battery as soon as possible.*
-

# Operating the Unit

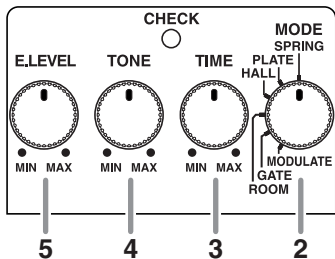

1. When you have made the necessary connections (p. 8), depress the pedal switch to turn the effect on. (the CHECK indicator turns red.)

*\* The unit's functions differ according to how it is connected. Refer to "Outputting Only the Effect" (p. 11).*

2. Select the mode with the MODE switch.
3. Adjust the reverb time with the TIME knob.
4. Adjust the tone of the reverb sound with the TONE knob.
5. Adjust the effect volume level with the E.LEVEL knob.

## Outputting Only the Effect

By plugging into INPUT-B, you can have only the effect sound be output (the direct sound is not output).

\* When the effect is off, the output from OUTPUT-A and OUTPUT-B is muted.

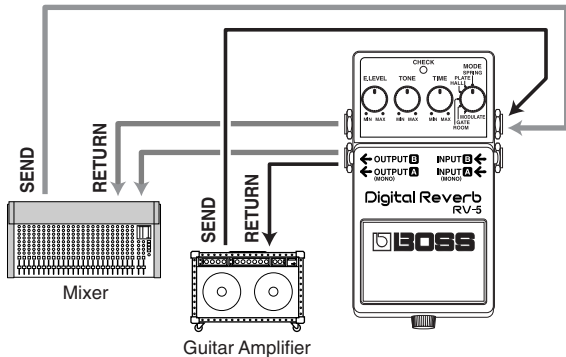

- \* Make sure the input/output levels of devices being connected are matched appropriately.
- \* When using a guitar amp to send/return the direct sound as well, connect to INPUT-A (MONO).

# Changing the Battery

When the indicator goes dim or no longer lights while an effect is on, it means that the battery is nearly dead and must be replaced. Replace the battery following the steps below.

*\* The use of an AC adaptor is recommended as the unit's power consumption is relatively high. Should you prefer to use batteries, please use the alkaline type.*

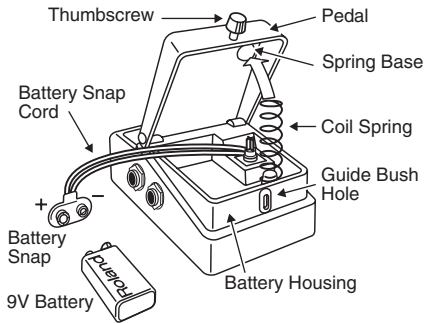

1. Loosen the thumbscrew at the front of the pedal, then lift the pedal upwards to open the unit.  
*\* The thumbscrew can be left in the pedal while changing the battery.*
2. Remove the old battery from the battery housing, and remove the snap cord connected to it.
3. Connect the snap cord to the new battery, and place the battery inside the battery housing.  
*\* Be sure to carefully observe the battery's polarity (+ versus -).*
4. Slip the coil spring onto the spring base on the back of the pedal, then close the pedal.  
*\* Carefully avoid getting the snap cord caught in the pedal, coil spring and battery housing.*
5. Finally, insert the thumbscrew into the guide bush hole and fasten it securely.

# Troubleshooting

## Power won't come on / CHECK indicator doesn't light:

- **Is the specified adaptor (PSA-series; sold separately) properly connected?**  
Check the connection once more (p. 8).
  - \* *Never use any AC adapter other than one specified for use with the RV-5.*
- **Is the battery low or dead?**  
Replace with a new battery (p. 12).
  - \* *The battery that was supplied with the unit is for temporary use, intended primarily for testing its operation. For extended use, we suggest replacing it with an alkaline battery.*
- **Is the guitar connected properly to the INPUT-A (MONO) or INPUT-B jack?**  
Check the connection once more (p. 8).
  - \* *To prevent useless depletion of the battery when the unit is running on battery power, the power is switched on only when a cable is plugged in to the INPUT-A (MONO) or INPUT-B jack.*
  - \* *The CHECK indicator shows whether the effect is being applied or not. It does not indicate whether the power to the device is on or not.*

### **No sound / Low volume:**

- **Is the RV-5 properly connected to your instrument?**  
Check the connection once more (p. 8).
- **Is the volume turned down on any guitar amp or effects device you have connected?**  
Check the settings of the connected device.
- **Do you have a stereo plug connected?**  
This device will not operate properly with stereo plugs. Please use mono plugs.
- **Are you connected only to INPUT-B?**  
The direct sound is not output when you connect only to INPUT-B. The outputs are muted when the effect is off, and no sound is output (p. 11).

### **Sound is distorted:**

- **Is the battery low?**  
As the battery is drained, the CHECK indicator dims, and the RV-5 may start to function incorrectly. Replace with a new battery (p. 12).
- **Could the level of the sound being input be excessive?**  
With some guitars, distortion may be produced. Be careful of your guitar's output level.

# Setting Samples

## Spring Reverb

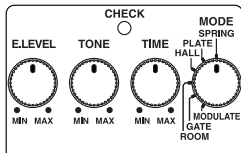

You can derive more of the spring reverb's characteristic ambience by muting the lower strings.

## Concert Hall

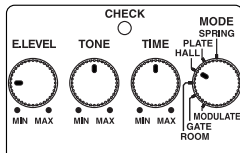

## Bright Reverb

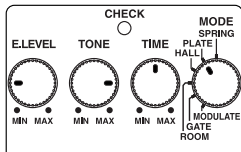

## Deep Reverb

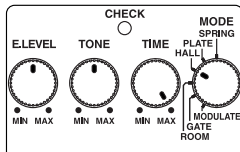

## Room

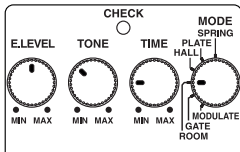

## Fat Sound

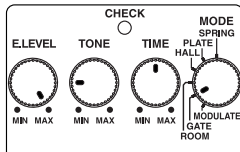

Effective when TIME is matched with the phrase's tempo. This yields an even fatter sound when used in combination with distortion effects.

## Garage Sound

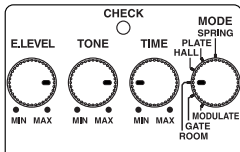

## Chorus Effect

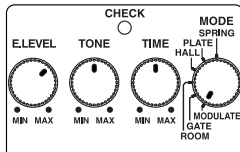

Adds a sense of greater breadth and depth to arpeggios played with a clean sound.



# Specifications

## RV-5: Digital Reverb

Nominal Input Level .....	-20 dBu
Input Impedance .....	1 M $\Omega$
Nominal Output Level .....	-20 dBu
Output Impedance .....	1 k $\Omega$
Recommended Load Impedance .....	10 k $\Omega$ or greater
Residual Noise .....	-93 dBu (IHF-A, Typ.): All knobs at center position
Controls .....	Pedal Switch, E.LEVEL knob, TONE knob, TIME knob, MODE switch
Indicator .....	CHECK Indicator (Serves also battery check indicator)
Connectors .....	INPUT-A (MONO) jack, INPUT-B jack, OUTPUT-A (MONO) jack, OUTPUT-B jack, AC adaptor jack (DC 9 V)
Power Supply .....	DC 9 V: Dry battery (9 V type) S-006P/9 V (6F22/9 V) Dry battery (9 V type) 6AM6/9 V (alkaline) AC Adaptor

## Specifications

---

Current Draw .....	50 mA (DC 9 V)
	<i>* Expected battery life under continuous use: Carbon: 2 hours, Alkaline: 6 hours These figures will vary depending on the actual conditions of use.</i>
Dimensions .....	73 (W) x 129 (D) x 59 (H) mm 2-7/8 (W) x 5-1/8 (D) x 2-3/8 (H) inches
Weight. ....	440 g / 1 lb (including Battery)
Accessories .....	Owner's Manual Leaflet ("USING THE UNIT SAFELY," "IMPORTANT NOTES," and "Information") Dry battery (9 V type) S-006P/9 V (6F22/9 V) <i>* The battery that was supplied with the unit is for temporary use- intended primarily for testing its operation. We also suggest replacing this with an alkaline dry cell.</i>
Options .....	AC Adaptor PSA-Series

*\* 0 dBu = 0.775 Vrms*

*\* In the interest of product improvement, the specifications and/or appearance of this unit are subject to change without prior notice.*



This product complies with the requirements of European Directive 89/336/EEC.

For EU Countries

## FEDERAL COMMUNICATIONS COMMISSION RADIO FREQUENCY INTERFERENCE STATEMENT

For the USA

This equipment has been tested and found to comply with the limits for a Class B digital device, pursuant to Part 15 of the FCC Rules. These limits are designed to provide reasonable protection against harmful interference in a residential installation. This equipment generates, uses, and can radiate radio frequency energy and, if not installed and used in accordance with the instructions, may cause harmful interference to radio communications. However, there is no guarantee that interference will not occur in a particular installation. If this equipment does cause harmful interference to radio or television reception, which can be determined by turning the equipment off and on, the user is encouraged to try to correct the interference by one or more of the following measures:

- Reorient or relocate the receiving antenna.
- Increase the separation between the equipment and receiver.
- Connect the equipment into an outlet on a circuit different from that to which the receiver is connected.
- Consult the dealer or an experienced radio/TV technician for help.

This device complies with Part 15 of the FCC Rules. Operation is subject to the following two conditions:

- (1) This device may not cause harmful interference, and
- (2) This device must accept any interference received, including interference that may cause undesired operation.

Unauthorized changes or modification to this system can void the users authority to operate this equipment.  
This equipment requires shielded interface cables in order to meet FCC class B Limit.

For Canada

### NOTICE

This Class B digital apparatus meets all requirements of the Canadian Interference-Causing Equipment Regulations.

### AVIS

Cet appareil numérique de la classe B respecte toutes les exigences du Règlement sur le matériel brouilleur du Canada.



**BOSS Corporation**

G6017360