

Pioneer *sound.vision.soul*

SOUND & VISION MIXER

SVM-1000

Operating Instructions

Thank you for buying this Pioneer product. Please read through these operating instructions so you will know how to operate your model properly. After you have finished reading the instructions, put them away in a safe place for future reference.

In some countries or regions, the shape of the power plug and power outlet may sometimes differ from that shown in the explanatory drawings. However the method of connecting and operating the unit is the same.

K015 En

IMPORTANT



The lightning flash with arrowhead symbol, within an equilateral triangle, is intended to alert the user to the presence of uninsulated "dangerous voltage" within the product's enclosure that may be of sufficient magnitude to constitute a risk of electric shock to persons.



CAUTION:
TO PREVENT THE RISK OF ELECTRIC SHOCK, DO NOT REMOVE COVER (OR BACK). NO USER-SERVICEABLE PARTS INSIDE. REFER SERVICING TO QUALIFIED SERVICE PERSONNEL.



The exclamation point within an equilateral triangle is intended to alert the user to the presence of important operating and maintenance (servicing) instructions in the literature accompanying the appliance.

D1-4-2-3_En-A

WARNING

This equipment is not waterproof. To prevent a fire or shock hazard, do not place any container filled with liquid near this equipment (such as a vase or flower pot) or expose it to dripping, splashing, rain or moisture.

D3-4-2-1-3_B_En

IMPORTANT NOTICE – THE SERIAL NUMBER FOR THIS EQUIPMENT IS LOCATED ON THE REAR. PLEASE WRITE THIS SERIAL NUMBER ON YOUR ENCLOSED WARRANTY CARD AND KEEP IN A SECURE AREA. THIS IS FOR YOUR SECURITY.

D1-4-2-6-1_En

Information to User

Alteration or modifications carried out without appropriate authorization may invalidate the user's right to operate the equipment.

D8-10-2_En

CAUTION: This product satisfies FCC regulations when shielded cables and connectors are used to connect the unit to other equipment. To prevent electromagnetic interference with electric appliances such as radios and televisions, use shielded cables and connectors for connections.

D8-10-3a_En

This Class B digital apparatus complies with Canadian ICES-003.

Cet appareil numérique de la Classe B est conforme à la norme NMB-003 du Canada.

D8-10-1-3_EF

CAUTION

The POWER switch on this unit will not completely shut off all power from the AC outlet. Since the power cord serves as the main disconnect device for the unit, you will need to unplug it from the AC outlet to shut down all power. Therefore, make sure the unit has been installed so that the power cord can be easily unplugged from the AC outlet in case of an accident. To avoid fire hazard, the power cord should also be unplugged from the AC outlet when left unused for a long period of time (for example, when on vacation).

D3-4-2-2-2a_A_En

WARNING: Handling the cord on this product or cords associated with accessories sold with the product will expose you to chemicals listed on proposition 65 known to the State of California and other governmental entities to cause cancer and birth defect or other reproductive harm.

Wash hands after handling

D36-P4_A_En

WARNING

To prevent a fire hazard, do not place any naked flame sources (such as a lighted candle) on the equipment.

D3-4-2-1-7a_A_En

VENTILATION CAUTION

When installing this unit, make sure to leave space around the unit for ventilation to improve heat radiation (at least 5 cm at rear, and 3 cm at each side).

WARNING

Slots and openings in the cabinet are provided for ventilation to ensure reliable operation of the product, and to protect it from overheating. To prevent fire hazard, the openings should never be blocked or covered with items (such as newspapers, table-cloths, curtains) or by operating the equipment on thick carpet or a bed.

D3-4-2-1-7b_A_En

POWER-CORD CAUTION

Handle the power cord by the plug. Do not pull out the plug by tugging the cord and never touch the power cord when your hands are wet as this could cause a short circuit or electric shock. Do not place the unit, a piece of furniture, etc., on the power cord, or pinch the cord. Never make a knot in the cord or tie it with other cords. The power cords should be routed such that they are not likely to be stepped on. A damaged power cord can cause a fire or give you an electrical shock. Check the power cord once in a while. When you find it damaged, ask your nearest PIONEER authorized service center or your dealer for a replacement.

5002_En

WARNING

This product equipped with a three-wire grounding (earthed) plug - a plug that has a third (grounding) pin. This plug only fits a grounding-type power outlet. If you are unable to insert the plug into an outlet, contact a licensed electrician to replace the outlet with a properly grounded one. Do not defeat the safety purpose of the grounding plug.

D3-4-2-1-6_A_En

IMPORTANT SAFETY INSTRUCTIONS

- 1) Read these instructions.
- 2) Keep these instructions.
- 3) Heed all warnings.
- 4) Follow all instructions.
- 5) Do not use this apparatus near water.
- 6) Clean only with dry cloth.
- 7) Do not block any ventilation openings. Install in accordance with the manufacturer's instructions.
- 8) Do not install near any heat sources such as radiators, heat registers, stoves, or other apparatus (including amplifiers) that produce heat.
- 9) Do not defeat the safety purpose of the polarized or grounding-type plug. A polarized plug has two blades with one wider than the other. A grounding type plug has two blades and a third grounding prong. The wide blade or the third prong are provided for your safety. If the provided plug does not fit into your outlet, consult an electrician for replacement of the obsolete outlet.
- 10) Protect the power cord from being walked on or pinched particularly at plugs, convenience receptacles, and the point where they exit from the apparatus.
- 11) Only use attachments/accessories specified by the manufacturer.
- 12) Use only with the cart, stand, tripod, bracket, or table specified by the manufacturer, or sold with the apparatus. When a cart is used, use caution when moving the cart/apparatus combination to avoid injury from tip-over.
- 13) Unplug this apparatus during lightning storms or when unused for long periods of time.
- 14) Refer all servicing to qualified service personnel. Servicing is required when the apparatus has been damaged in any way, such as power-supply cord or plug is damaged, liquid has been spilled or objects have fallen into the apparatus, the apparatus has been exposed to rain or moisture, does not operate normally, or has been dropped.



P1-4-2-2_En

NOTE: This equipment has been tested and found to comply with the limits for a Class B digital device, pursuant to Part 15 of the FCC Rules. These limits are designed to provide reasonable protection against harmful interference in a residential installation. This equipment generates, uses, and can radiate radio frequency energy and, if not installed and used in accordance with the instructions, may cause harmful interference to radio communications. However, there is no guarantee that interference will not occur in a particular installation. If this equipment does cause harmful interference to radio or television reception, which can be determined by turning the equipment off and on, the user is encouraged to try to correct the interference by one or more of the following measures:

- Reorient or relocate the receiving antenna.
- Increase the separation between the equipment and receiver.
- Connect the equipment into an outlet on a circuit different from that to which the receiver is connected.
- Consult the dealer or an experienced radio/TV technician for help.

D8-10-1-2_En

FEDERAL COMMUNICATIONS COMMISSION DECLARATION OF CONFORMITY

This device complies with part 15 of the FCC Rules. Operation is subject to the following two conditions: (1) This device may not cause harmful interference, and (2) this device must accept any interference received, including interference that may cause undesired operation.

Product Name: SOUND & VISION MIXER
 Model Number: SVM-1000
 Responsible Party Name: PIONEER ELECTRONICS SERVICE, INC.
 Address: 1925 E. DOMINGUEZ ST. LONG BEACH, CA 90801-1760, U.S.A.
 Phone: 1-800-421-1404

This product contains mercury. Disposal of this material may be regulated due to environmental considerations. For disposal or recycling information, please contact your local authorities or the Electronics Industries Alliance : www.eiae.org.

K057_En

The backlighting lamp of LCD in this equipment contains mercury. Disposal of this material may be regulated due to environmental considerations according to Local, State or Federal Laws. For disposal or recycling information, please contact your local authorities or the Electronics Industries Alliance: www.eiae.org



Dear Customer:

Selecting fine audio equipment such as the unit you've just purchased is only the start of your musical enjoyment. Now it's time to consider how you can maximize the fun and excitement your equipment offers. This manufacturer and the Electronic Industries Association's Consumer Electronics Group want you to get the most out of your equipment by playing it at a safe level. One that lets the sound come through loud and clear without annoying blaring or distortion-and, most importantly, without affecting your sensitive hearing.

Sound can be deceiving. Over time your hearing "comfort level" adapts to higher volumes of sound. So what sounds "normal" can actually be loud and harmful to your hearing. Guard against this by setting your equipment at a safe level BEFORE your hearing adapts.

To establish a safe level:

- Start your volume control at a low setting.
- Slowly increase the sound until you can hear it comfortably and clearly, and without distortion.

Once you have established a comfortable sound level:

- Set the dial and leave it there.

Taking a minute to do this now will help to prevent hearing damage or loss in the future. After all, we want you listening for a lifetime.

We Want You Listening For A Lifetime

Used wisely, your new sound equipment will provide a lifetime of fun and enjoyment. Since hearing damage from loud noise is often undetectable until it is too late, this manufacturer and the Electronic Industries Association's Consumer Electronics Group recommend you avoid prolonged exposure to excessive noise. This list of sound levels is included for your protection.

Decibel Level Example

30	Quiet library, soft whispers
40	Living room, refrigerator, bedroom away from traffic
50	Light traffic, normal conversation, quiet office
60	Air conditioner at 20 feet, sewing machine
70	Vacuum cleaner, hair dryer, noisy restaurant
80	Average city traffic, garbage disposals, alarm clock at two feet.

THE FOLLOWING NOISES CAN BE DANGEROUS UNDER CONSTANT EXPOSURE

90	Subway, motorcycle, truck traffic, lawn mower
100	Garbage truck, chain saw, pneumatic drill
120	Rock band concert in front of speakers, thunderclap
140	Gunshot blast, jet plane
180	Rocket launching pad

Information courtesy of the Deafness Research Foundation.



S001_En

Operating Environment

Operating environment temperature and humidity: +5 °C – +35 °C (+41 °F – +95 °F); less than 85 %RH (cooling vents not blocked)

Do not install this unit in a poorly ventilated area, or in locations exposed to high humidity or direct sunlight (or strong artificial light) D3-4-2-1-7c_A_En

WARNING

Before plugging in for the first time, read the following section carefully.

The voltage of the available power supply differs according to country or region. Be sure that the power supply voltage of the area where this unit will be used meets the required voltage (e.g., 230V or 120V) written on the bottom panel. D3-4-2-1-A_En mod

If the AC plug of this unit does not match the AC outlet you want to use, the plug must be removed and appropriate one fitted. Replacement and mounting of an AC plug on the power supply cord of this unit should be performed only by qualified service personnel. If connected to an AC outlet, the cut-off plug can cause severe electrical shock. Make sure it is properly disposed of after removal. The equipment should be disconnected by removing the mains plug from the wall socket when left unused for a long period of time (for example, when on vacation). D3-4-2-1a_A_En

Contents

CONFIRM ACCESSORIES.....	4	USING THE JPEG VIEWER	31
CAUTIONS REGARDING HANDLING.....	4	BEFORE USING THE JPEG VIEWER.....	31
Location	4	JPEG VIEWER SETUP	31
Cleaning the Unit.....	4	THE VIDEO EQUALIZER FUNCTION.....	34
Disclaimer	4	SET UP THE VIDEO EQ.....	34
About Copyright.....	4	TURNING THE EQUALIZER ON/OFF	34
FEATURES	4	FADER START FUNCTION	35
NAMES AND FUNCTIONS OF PARTS	6	CROSS FADER START PLAY AND BACK CUE PLAY.....	35
CONNECTION PANEL	6	PERFORM UTILITY SETUP	36
OPERATION PANEL	7	MIDI SETTINGS	36
CONNECTIONS	10	SYNCHRONIZING AUDIO SIGNALS TO EXTERNAL SEQUENCER, OR USING SVM-1000 INFORMATION TO OPERATE AN EXTERNAL SEQUENCER	36
CONNECTING INPUTS.....	10	MIDI CODE LIST.....	37
CONNECTING OUTPUTS	11	PERFORM VIDEO MONITOR SETUP	41
CONNECTING MICROPHONE AND HEADPHONES	12	KEYBOARD LANGUAGE SETUP	41
CONNECTING THE POWER CORD.....	12	HARDWARE SETUP.....	42
BASIC OPERATIONS.....	13	MIC SETTING	42
FADER CURVE SELECTION	14	SYSTEM SETTINGS.....	42
USING THE VIDEO CONTROL FUNCTIONS	15	MASTER OUT SETTINGS.....	43
OPERATING THE VIDEO CROSS FADER	15	LCD SETTINGS.....	43
OPERATING THE VIDEO CHANNEL SWITCH	15	MONITOR OUT SETTINGS.....	43
OPERATING IN THE VIDEO SOLO MODE	16	TOUCH PANEL SETTINGS.....	44
VIDEO MIX EFFECTS CHART	16	RETURNING TO DEFAULT SETTINGS	44
USING THE EFFECT FUNCTION.....	17	ENDING HARDWARE SET UP.....	44
USING BEAT EFFECTS	17	TROUBLESHOOTING	45
USING TOUCH EFFECTS.....	19	ABOUT THE LCD SCREEN	46
USING TEXT EFFECTS	20	ABOUT MINIATURE FLUORESCENT TUBE TECHNOLOGY	46
EDITING TEXT	22	SPECIFICATIONS.....	47
DISPLAYING/HIDING THE MASTER MONITOR	22		
EFFECT LIST.....	23		

CONFIRM ACCESSORIES

Power cord1
 Warranty card1
 Operating Instructions1

CAUTIONS REGARDING HANDLING

Location

Install the unit in a well-ventilated location where it will not be exposed to high temperatures or humidity.

- Do not install the unit in a location which is exposed to direct rays of the sun, or near stoves or radiators. Excessive heat can adversely affect the cabinet and internal components. Installation of the unit in a damp or dusty environment may also result in a malfunction or accident. (Avoid installation near cookers etc., where the unit may be exposed to oily smoke, steam or heat.)
- When the unit is used inside a carrying case or DJ booth, separate it from the walls or other equipment to improve heat radiation.

Cleaning the Unit

- Use a polishing cloth to wipe off dust and dirt.
- When the surfaces are very dirty, wipe with a soft cloth dipped in some neutral cleanser diluted five or six times with water and wrung out well, then wipe again with a dry cloth. Do not use furniture wax or cleaners.
- Never use thinners, benzene, insecticide sprays or other chemicals on or near this unit, since these will corrode the surfaces.

Disclaimer

- Microsoft and Windows are registered trademarks of Microsoft Corporation, registered in the U.S. and other countries. Apple and Mac OS are trademarks of Apple Inc., registered in the U.S. and other countries.
- The typefaces included herein are partially developed by DynaComware Taiwan Inc.

About Copyright

This product incorporates copyright protection technology that is protected by U.S. patents and other intellectual property rights. Use of this copyright protection technology must be authorized by Macrovision Corporation, and is intended for home and other limited consumer uses only unless otherwise authorized by Macrovision. Reverse engineering or disassembly is prohibited.

In the event that the above noted copy protection function operates in any channel, some effects (DELAY, ECHO, ROLL, REVERSE ROLL) will not function.

FEATURES

4-Channel Music and Video Synchronix

Most conventional image mixing devices are limited to the simple mixing of two video images, but Pioneer's own uniquely developed video blending technology makes it possible to simultaneously mix up to four channels of music and video. Since the synchro control allows the use of fader and equalizers with each channel, a new, wider range of performances is possible with the sensation of using conventional DJ mixers.

"AV Effects" support a wide variety of new performance styles by synchronizing music and video.

Equipped with AV Effects that synchronize music effects and video effects on the large 11-inch LCD touch panel display, allowing up to 30 types of effects to be applied to your music and images.

- 1 Beat effect: Automatically detects the tempo of the currently playing track, and applies effects to music and image in synch with the beat.
- 2 Touch effect: By directly touching the image displayed on the large LCD touch panel, effects can be applied to music and video more intuitively.
- 3 Text effect: Text messages created in synchronization with the automatically detected track tempo can be displayed with effects. Text messages can be entered either by the built-in keyboard or a common USB keyboard.

"JPEG VIEWER" allows use of images stored in external memory for live performances

Up to eight JPEG files saved on SD memory cards or USB memory devices can be downloaded and used as a still image sampler. By applying effects or mixing with other videos and images such as the name of the DJ or event, or graphic logos, you can broaden the potential of your performance. Additionally, JPEG files can be loaded and displayed as an automatic slide show.

Digital sound/video system for high quality sound and image

1 96 kHz/24-bit sampling digital system for high sound quality

Analog signals input from a DJ player are passed through the shortest possible signal path and digitized using a high-fidelity A/D converter with 96 kHz/24-bit sampling, producing optimum quality for digital mixing. Mixing is performed by a 32-bit DSP to eliminate any degradation in sound quality, while simultaneously using ideal filtering to produce optimum sound for DJ play.

In order to realize the greatest possible response, the unit also features a high-rigidity chassis and double-shield construction to suppress unwanted vibrations that might adversely effect sound quality, together with a powerful power section and other high-fidelity technology, thus producing clear, powerful club sounds.

2 High-performance video IC digital system for high image quality

Video signals input through the high-performance ADC are processed through a high-performance video DSP rated at 600 MHz/32-bit/4800 MIPS (Million Instructions Per Second), thus preserving the original image's dynamic range while also suppressing unwanted noise and producing images with high fidelity and quality. The same high quality has also been realized for video effects that normally tend to be a source of image degradation.

Improved design and operability for new club culture

Based on the concept of creating “a design that fascinates,” the boxy-shape of previous DJ mixers has been restyled toward an edgier and more solid design. Great attention has been given to details of materials and design, such as employing an “illumination display” on the rear panel visible from the dance floor.

Operating panel design emphasizes convenience for simultaneous performances of music and video, with a “channel symmetry layout” centered around the 11-inch LCD touch panel. By arranging each channel section symmetrically, further improvements in operability have been made to assist easy mixing between music and video, so that effects can be enabled dynamically from the LCD touch panel.

Other DJ/VJ performance functions made possible through digital technology

- 1 “VIDEO TRIM” allows adjustment of the luminance of images input to each channel.
- 2 “VIDEO EQUALIZER” assigns parameters such as **[RGB]**, **[CONTRAST]**, **[HUE]**, and **[SATURATION]** to the equalizer, allowing synchronization of audio equalizing and video controls.
- 3 “AV SYNC” allows the user to select whether audio and video controls are linked or adjusted separately.
- 4 “VIDEO MONITOR SELECTOR” allows the user to choose whether the monitor video output shows master only, all channels, master and each channel, master mixing inversion, etc.
- 5 “FULLY ASSIGNABLE MIDI” allows control of DJ effector, DJ/VJ application programs, and other external components.

Installing the SVM-1000 in an EIA rack

The screw holes located on the left and right ends of the front panel (within the side cover) match the 19-inch EIA rack.

- Remove the 10 screws (five screws each located on the left and right sides of the unit) before installing the unit to the rack.

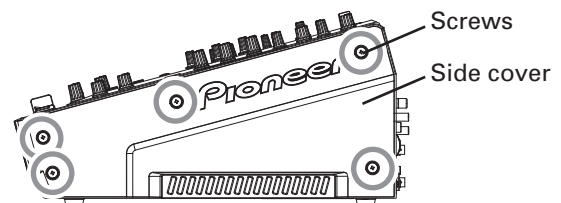

- Holes for rack installation can be located when the side covers are removed.
- Attach the unit to the rack using screws of the appropriate size (screws not provided with the unit).
- When installing the unit in a rack, take care to avoid pinching your fingers.

Note

- Never place this unit directly above a power amplifier, as the heat given off by the amplifier might result in damage to the unit. Placing the unit directly above a power amplifier might also result in ham radio signals being picked up or in other types of interference.
- Allow at least 1U (43.7 mm) space between this component and the one mounted above it, so as to assure that the cords connected to this unit’s input/output connectors and terminals do not touch the component above.
- Always be sure to remove the unit from its rack before shipping.
- When moving the unit while still installed in its rack, exercise caution to avoid subjecting the unit to shocks or vibration.

NAMES AND FUNCTIONS OF PARTS

CONNECTION PANEL

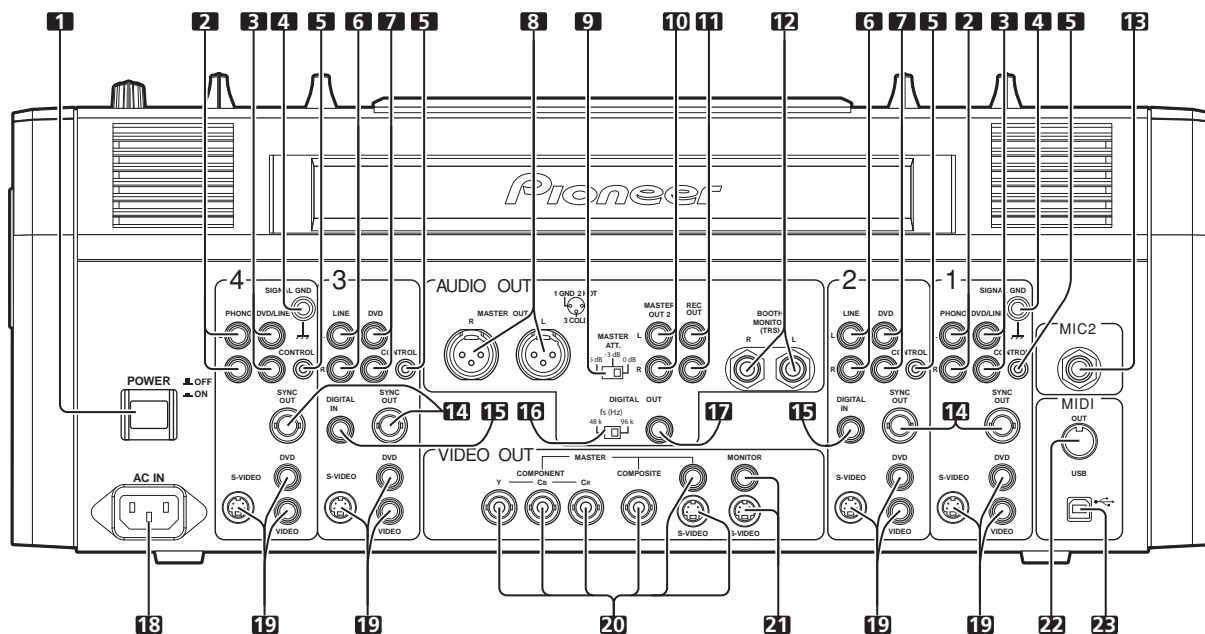

1 POWER switch

2 PHONO input connectors

RCA type phono level (MM cartridge) input connectors. Do not use for inputting line level signals.

3 DVD/LINE input connectors

RCA type line level audio input connectors. Use to connect a DJ/VJ DVD player or DJ CD player or other line level output component.

4 Signal ground terminal (SIGNAL GND)

Connect the ground wire from an analog turntable. This is not a safety ground terminal.

5 CONTROL connector

Connect the Ø 3.5 mm mini phone plug of the control cable from a DJ/VJ DVD player or DJ CD player.

When this is done, this mixer's fader controls can be used to perform start and back-cue functions on the connected DJ/VJ DVD player or DJ CD player.

6 LINE input connectors

RCA type line level audio input connectors. Use to connect a cassette deck or other line level output component.

7 DVD input connectors

RCA type line level audio input connectors. Use to connect a DJ/VJ DVD player or DJ CD player or other line level output component.

8 Audio master output 1 connectors (MASTER OUT 1)

XLR type (male) balanced output.

- When using a cord with RCA-type plug, users are recommended to connect the plug directly to the **MASTER OUT 2** connectors without using an XLR/RCA converter plug. When a conversion plug is used, the signal GND may become unstable, in rare cases resulting in the production of noise.

9 Audio master output attenuator selector (MASTER ATT.)

Attenuates the output level of the audio master 1 and audio master 2.

Attenuation level can be selected as 0 dB, -3 dB, or -6 dB.

10 Audio master output 2 connectors (MASTER OUT 2)

RCA-type unbalanced output.

11 Recording output connectors (REC OUT)

RCA type output connectors for recording.

12 BOOTH MONITOR output jacks (TRS)

Ø 6.3 mm phone-type booth monitor output jacks.

The sound level output at these connectors can be controlled by the **BOOTH MONITOR** level dial, regardless of the setting of the **MASTER LEVEL** dial. (Since the output is TRS, both balanced and unbalanced outputs are supported.)

13 Microphone 2 input jack (MIC 2)

Connect microphones equipped with phone-type plug.

14 Sync signal output connector (SYNC OUT)

Outputs video sync signal.

When connecting a Pioneer DJ/VJ DVD player (sold separately), the sync signal helps suppress any lag between video and audio signals.

15 Digital input connector (DIGITAL IN)

RCA-type digital coaxial input connector. Connect to the digital coaxial output connector from a DJ/VJ DVD player or DJ CD player.

- If the sampling frequency of the output signal changes, the sound may be interrupted briefly.

16 Sampling frequency selector switch (fs 48 k/96 k)

Use to set the sampling frequency of the digital output to 96 kHz/24-bit format or 48 kHz/24-bit format.

Turn power off before changing this switch position.

17 Digital output connector (DIGITAL OUT)

RCA type digital coaxial output connector. Master audio digital output.

18 Power inlet (AC IN)

Use the furnished power cable to connect to a household AC outlet.

19 Video input connectors (DVD, VIDEO, S-VIDEO)

Composite and S-VIDEO type video input connectors.

20 Video master output connectors (MASTER: COMPONENT, COMPOSITE, S-VIDEO)

Component, composite, and S-VIDEO type video output connectors.

21 Video monitor output connectors (MONITOR, S-VIDEO)

Composite and S-VIDEO type monitor video output connectors.

NAMES AND FUNCTIONS OF PARTS

22 MIDI OUT connector

DIN type output connector.

Use to connect to other MIDI component.

23 MIDI USB output connector

USB-B type output connector. Use to connect to a computer.

OPERATION PANEL

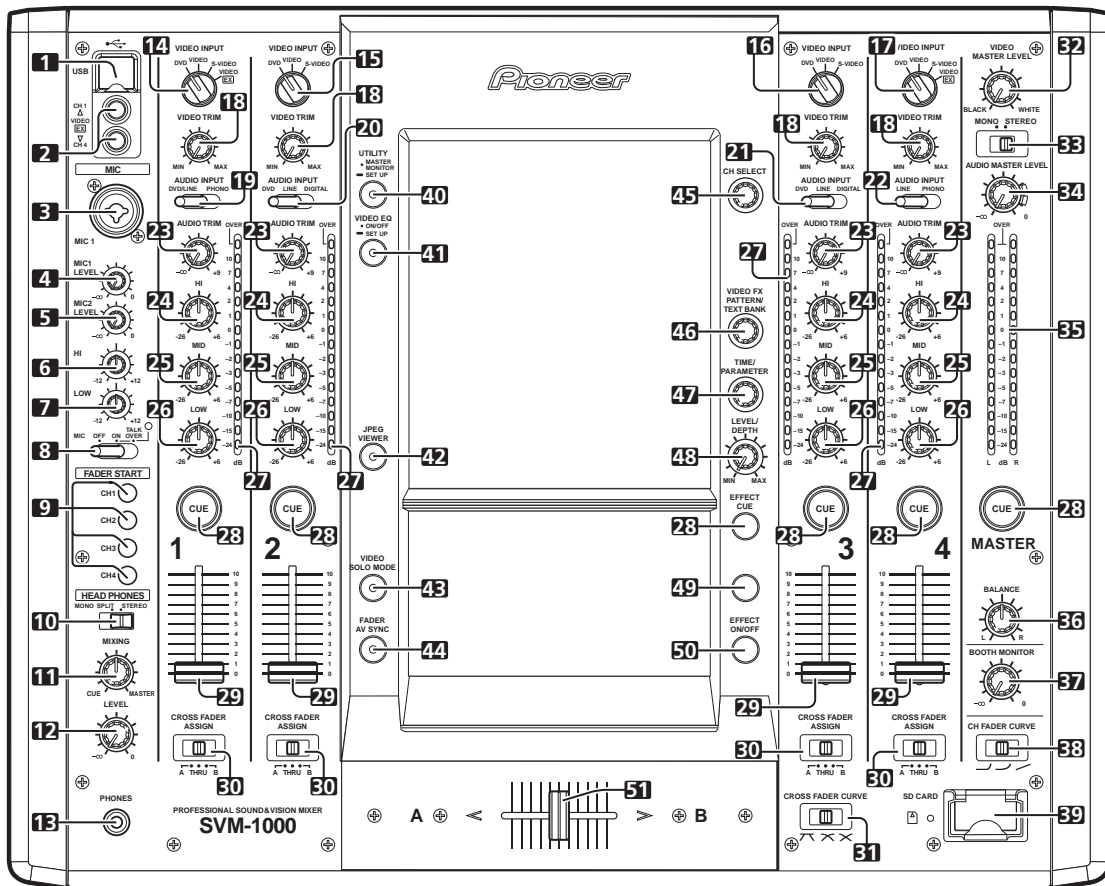

1 USB connector

Use to connect a USB memory or keyboard.

2 CH1/CH4 video input connectors (VIDEO EX)

Use to input video from an external source.

3 Microphone 1 input jack (MIC 1)

Connect microphone with XLR-type or phone-type plug.

4 Microphone 1 level control dial (MIC 1 LEVEL)

Use to adjust the volume of microphone 1. (Adjustable range $-\infty$ to 0 dB)

5 Microphone 2 level control dial (MIC 2 LEVEL)

Use to adjust the volume of microphone 2. (Adjustable range $-\infty$ to 0 dB)

6 Microphone equalizer high-range adjust dial (HI)

Use to adjust the treble (high-range) frequencies of microphones 1 and 2. (Adjustable range -12 dB to $+12$ dB)

7 Microphone equalizer low-range adjust dial (LOW)

Use to adjust the bass (low-range) frequencies of microphones 1 and 2. (Adjustable range -12 dB to $+12$ dB)

8 Microphone function selector switch (MIC)

OFF:

No microphone sound is output.

ON:

Microphone sounds are output, and the microphone function indicator lights.

TALK OVER:

Microphone sounds are output, and the microphone function indicator flashes.

When an audio signal of -15 dB or more (default setting) is input to the microphone input, the talkover function operates to reduce all output other than the mike audio by 20 dB (default setting). Values can be changed in the hardware setup (P. 42)

- When not using the TALK OVER function, it is recommended to set the switch to the [OFF] or [ON] position.

9 FADER START button/indicator (CH-1 to CH-4)

Enables the fader start/back cue function for the channel to which a DJ/VJ DVD player or DJ CD player is connected. The button lights when set to ON. When enabled, the operation differs depending on the setting of the **CROSS FADER ASSIGN** switch.

- When the **CROSS FADER ASSIGN** switch is set to the [A] or [B] position, **FADER START** button operation is linked to the operation of the cross fader (and unlinked to channel fader).
- When the **CROSS FADER ASSIGN** switch is set to the [THRU] position, **FADER START** button operation is linked to the operation of the channel fader (and unlinked to cross fader).

NAMES AND FUNCTIONS OF PARTS

10 HEADPHONES output switch (MONO SPLIT/STEREO)

MONO SPLIT:

The source sound selected with the headphone **CUE** button is output to the L channel, while the master sound is output to the R channel (only when **[MASTER]** is selected with the headphone **CUE** button).

STEREO:

The audio source selected with the headphone **CUE** button is output in stereo.

11 HEADPHONES MIXING dial

When rotated clockwise (toward **[MASTER]**), the master output audio is produced at the headphones (only when **[MASTER]** has been selected with the headphone **CUE** button); when rotated counterclockwise (toward **[CUE]**), the headphones output becomes the mixture of the effect monitor and the channel selected with the headphone **CUE** button.

12 HEADPHONES LEVEL adjust dial

Adjusts the output level of the headphones jack. (Adjustable range: $-\infty$ to 0 dB)

13 Headphones jack (PHONES)

14 Channel 1 VIDEO INPUT selector switch

Set to **[DVD]**, **[VIDEO]**, **[S-VIDEO]**, or **[VIDEO EX]** to match the type of input connected.

15 Channel 2 VIDEO INPUT selector switch

Set to **[DVD]**, **[VIDEO]**, or **[S-VIDEO]** to match the type of input connected.

16 Channel 3 VIDEO INPUT selector switch

Set to **[DVD]**, **[VIDEO]**, or **[S-VIDEO]** to match the type of input connected.

17 Channel 4 VIDEO INPUT selector switch

Set to **[DVD]**, **[VIDEO]**, **[S-VIDEO]**, or **[VIDEO EX]** to match the type of input connected.

18 VIDEO TRIM dial

Use to adjust the level of the video input signal for each channel.

- When rotated counterclockwise, the luminance level is reduced, eventually producing a black screen.
- When rotated clockwise, the luminance level is raised, eventually producing a white screen.
- At the center position, the luminance level is neutral (same level as input).

19 Channel 1 AUDIO INPUT selector switch

DVD/LINE:

Use to select **DVD/LINE** input connectors (line level analog input).

PHONO:

Use to select **PHONO** input connectors (PHONO level analog input).

20 Channel 2 AUDIO INPUT selector switch

DVD:

Use to select **DVD** input connectors.

LINE:

Use to select **LINE** input connectors (line level analog input).

DIGITAL:

Use to select **DIGITAL** input connector.

21 Channel 3 AUDIO INPUT selector switch

DVD:

Use to select **DVD** input connectors.

LINE:

Use to select **LINE** input connectors (line level analog input).

DIGITAL:

Use to select **DIGITAL** input connector.

22 Channel 4 AUDIO INPUT selector switch

DVD/LINE:

Use to select **DVD/LINE** input connectors (line level analog input).

PHONO:

Use to select **PHONO** input connectors (PHONO level analog input).

23 AUDIO TRIM dial

Use to adjust the level of the audio input signal for each channel. (Adjustable range: $-\infty$ to +9 dB, mid-position is about 0 dB)

24 Channel equalizer high-range adjust dial (HI)

Use to adjust the treble (high-range) frequency sound for each channel. Video parameters can also be assigned. See P. 34 regarding video parameters. (Adjustable range: -26 dB to +6 dB)

25 Channel equalizer mid-range adjust dial (MID)

Use to adjust the mid-range frequency sound for each channel. Video parameters can also be assigned. See P. 34 regarding video parameters. (Adjustable range: -26 dB to +6 dB)

26 Channel equalizer low-range adjust dial (LOW)

Use to adjust the bass (low-range) frequency sound for each channel. Video parameters can also be assigned. See P. 34 regarding video parameters. (Adjustable range: -26 dB to +6 dB)

27 Channel level indicator

Displays the current level for each channel, with two-second peak hold.

28 Headphone CUE buttons/indicators

These buttons are used to select from **1** to **4**, **MASTER**, or **EFFECT CUE**, to allow you to monitor the desired source through headphones. If multiple buttons are pressed simultaneously, the selected audio sources are mixed. Press the button once more to cancel the selected source. Unselected buttons glow darkly, while selected source buttons light brightly.

29 Channel fader lever

Use to adjust sound volumes and video level for each channel. (Volume adjust range: $-\infty$ to 0 dB) (Video adjust range: 0 % to 100 %)

Output is in accordance with the channel fader curve selected with the **CH FADER CURVE** switch.

When **FADER AV SYNC** function is OFF, only sound volume can be adjusted.

30 CROSS FADER ASSIGN switch

This switch assigns each channel's output to either right or left side of the cross fader (if multiple channels are assigned to the same side, the result will be the combined sum of the channels).

A:

The selected channel is assigned to the cross fader's **[A]** (left) side.

THRU:

The channel fader's output is sent as is to the master output, without being passed through the cross fader.

B:

The selected channel is assigned to the cross fader's **[B]** (right) side.

31 CROSS FADER CURVE switch

This switch allows the user to select from three types of cross fader curve response.

Sound volume changes as follows:

- At the left setting, the curve produces a rapid signal rise. (As soon as the cross fader lever leaves the **[A]** side, the **[B]** channel sound is produced.)
- At the right setting, the curve operates to produce an even, neutral rise throughout the cross fader's movement.
- At the middle setting, an intermediate curve is produced, midway between the two curves noted above.

The video level is as noted above only when the video cross fader's video mix effect is set to **[FADE]**.

32 Video master output level dial (VIDEO MASTER LEVEL)

Adjusts the video master output luminance level.

33 Master output MONO/STEREO selector switch

When set to the **[MONO]** position, audio master output is produced in L+R monaural.

34 Audio master output level dial (AUDIO MASTER LEVEL)

Use to adjust the master output level. (Adjustable range: $-\infty$ to 0 dB)

The master output is the sum combination of the sound from channels set to **[THRU]** with the **CROSS FADER ASSIGN** switch; the signal passed through the cross fader; and the signals from microphone 1 and microphone 2.

NAMES AND FUNCTIONS OF PARTS

35 Master level indicator (MASTER L, R)

These segment indicators display the audio output level from L and R channels. The indicators have a two-second peak hold.

36 Master balance dial (BALANCE)

Use to adjust the L/R channel balance for audio master output, booth monitor output, recording output, and digital output.

37 BOOTH MONITOR level control dial

This dial is used to adjust the booth monitor output volume. The volume can be adjusted independently of the master output level. (Adjustable range: $-\infty$ to 0 dB)

38 Channel fader curve switch (CH FADER CURVE)

This switch allows the user to select from three types of channel fader curve response.

The sound volume and video level changes as follows:

This setting is applied equally to channels 1 to 4.

- At the left setting, the curve operates to produce a rapid rise as the channel fader approaches its distant position.
- At the right setting, the curve operates to produce an even, neutral rise throughout the channel fader's movement.
- At the middle setting, an intermediate curve is produced, midway between the two curves noted above.

39 SD CARD slot

Insert an SD card.

40 UTILITY button (MASTER MONITOR, SET UP)

Switches between display / no display of the master monitor on the LCD. When the master monitor is set to display, the indicator lights. When the button is held depressed, the indicator changes to flashing, and the LCD screen changes to show the utility setup menu.

41 VIDEO EQ button (ON/OFF, SET UP)

Switches the video equalizer ON/OFF. The indicator lights when the video equalizer is ON. When the button is held depressed, the indicator flashes, and the LCD display changes to show the equalizer setup menu.

42 JPEG VIEWER button

Use to set the JPEG viewer mode. The indicator lights when in the JPEG viewer mode.

43 VIDEO SOLO MODE button

Use to switch the video solo mode ON/OFF. When the video solo mode is ON, the indicator will flash.

44 Fader AV synchro button (FADER AV SYNC)

This button determines whether sound and video are controlled together, or independently. When set to ON, the indicator lights, and the channel fader and cross fader operations change both sound and video simultaneously. When set to OFF, the channel fader and cross fader levers control sound only, while video is controlled by the touch panel.

45 Effect channel selector dial (CH SELECT)

Use to select the channel to which effects are applied. When [MIC] is selected, effects are applied to both microphone 1 and microphone 2.

46 VIDEO FX PATTERN/TEXT BANK dial

Use to select video effects, video effect patterns and text banks.

47 Effect parameter 1 dial (TIME/PARAMETER)

Adjusts parameter for selected effect.

- If this dial is rotated while depressing the **TAP** button, direct BPM can be set manually.

48 Effect parameter 2 dial (LEVEL/DEPTH)

Adjusts quantitative parameters for selected effect.

49 TAP button

The BPM is calculated from the intervals at which the **TAP** button is struck.

50 Effect button/indicator (EFFECT ON/OFF)

Turns selected effect ON/OFF.

When power is turned ON, the button lights (defaults to effect OFF). When effects are enabled (ON), the button flashes.

51 Cross fader lever (A/B)

This adjusts sound and video levels assigned to sides [A] and [B] in accordance with the **CROSS FADER ASSIGN** switches. When FADER AV SYNC is OFF, the control adjusts the sound only.

CONNECTIONS

Always turn off the power switch and disconnect the power plug from its outlet when making or changing connections.

CONNECTING INPUTS

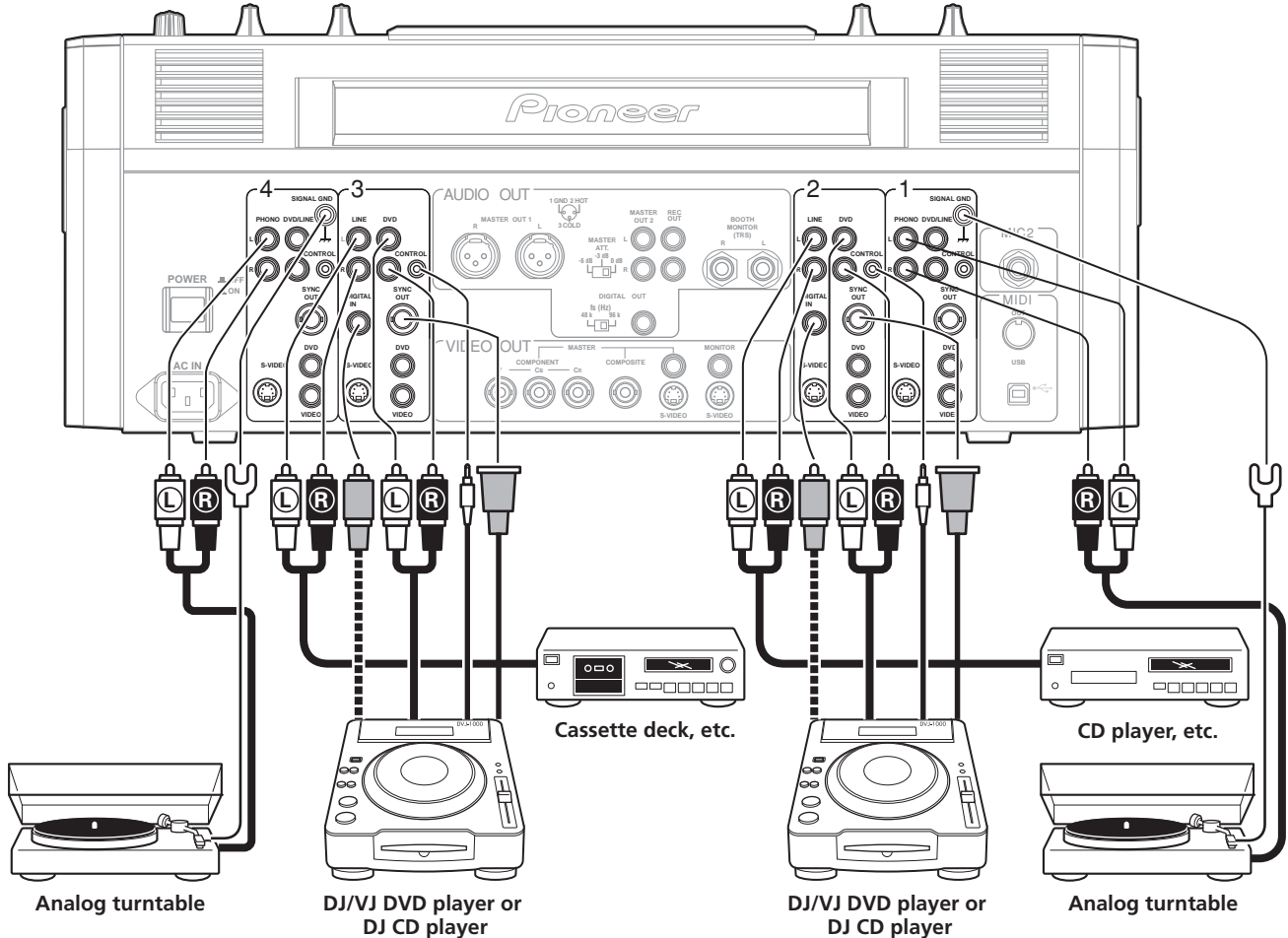

Pioneer DJ/VJ DVD players or DJ CD players

Audio cable connection

A DJ/VJ DVD or DJ CD player's audio output connectors can be connected to this unit's **DVD**, **DVD/LINE** or **LINE** connectors. When using the player's digital output, connect to this unit's channel 2 or channel 3 **DIGITAL IN** connector. Use the **AUDIO INPUT** selector switch (on top panel of this unit) to select the proper connector.

Likewise, the control cord should be connected to the **CONTROL** connector of the selected channel.

Video cable connection

A DJ/VJ DVD player's video output connectors can be connected to this unit's **DVD**, **VIDEO**, or **S-VIDEO** connectors. When this is done, use the **VIDEO INPUT** selector switch (on top panel of this unit) to select the proper connector.

Likewise, connect a commercially available sync signal cable to the **SYNC OUT** connector of the selected channel.

Connecting an analog turntable

Connect the audio output cables from an analog turntable to this unit's Channel 1 or 4 **PHONO** input connectors, then set the connected channel's **AUDIO INPUT** switch (on the upper panel of this unit) to **[PHONO]**. This unit's **PHONO** input supports MM cartridges.

Connect the ground wire from an analog turntable to the **SIGNAL GND** terminal of the SVM-1000.

- Note that no **PHONO** input connector is provided for channel 2 and 3.

Connecting other line level output devices

To use a cassette deck or ordinary CD player, connect its audio output connectors to one of the SVM-1000's **LINE** input connectors (channel 1 to 4).

CONNECTING OUTPUTS

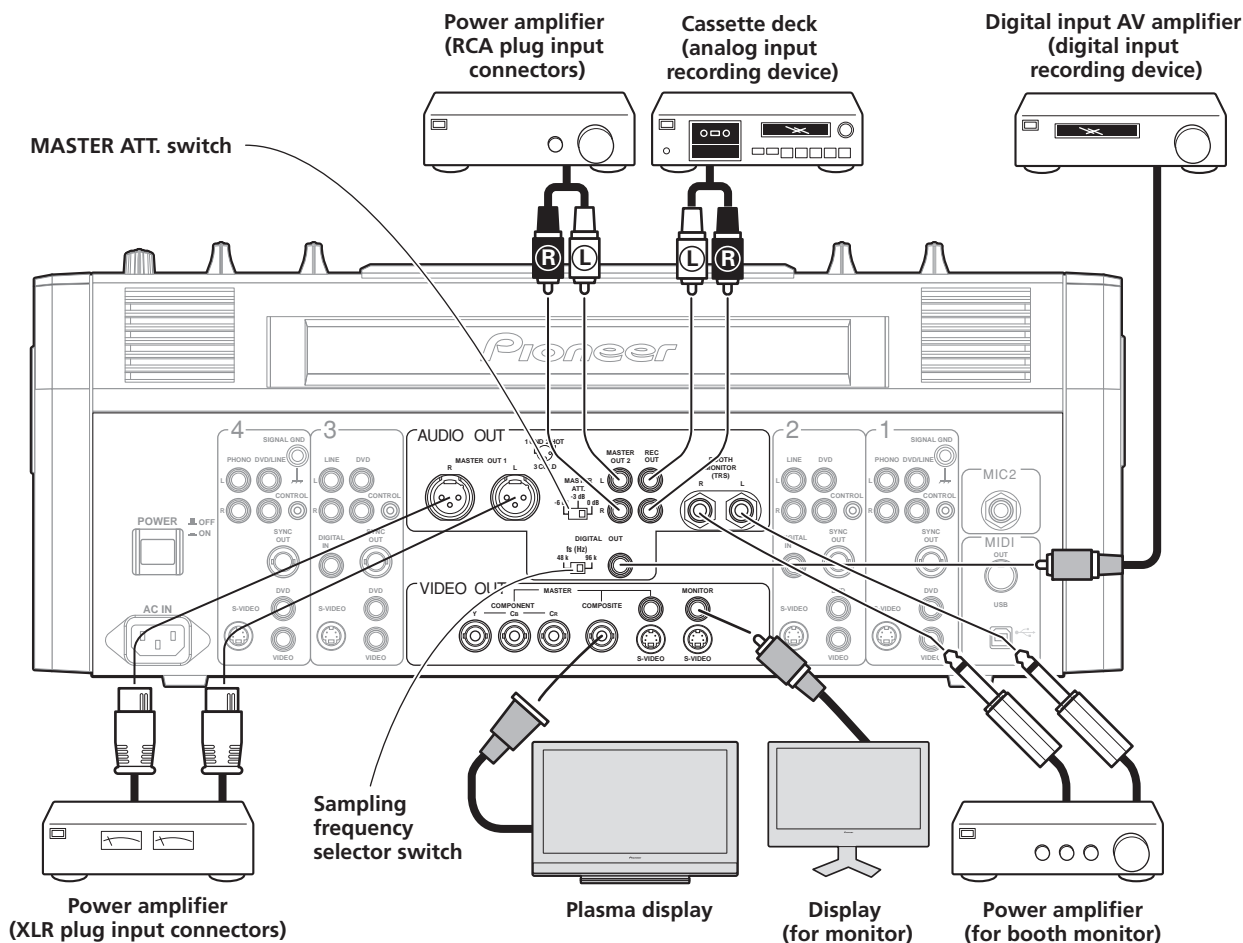

Audio master output

This unit is furnished with balanced output **MASTER OUT 1** (supporting XLR plugs), and unbalanced output **MASTER OUT 2** (supporting RCA plugs). Using the **MASTER ATT.** switch, adjust the output level to match the input sensitivity of the power amplifier used. If the operating panel's **MONO/STEREO** switch is set to **[MONO]**, the master output will be a monaural combination of L+R channels.

Booth monitor output

TRS output for $\varnothing 6.3$ mm phone plug. The sound volume for this output is controlled by the **BOOTH MONITOR** level dial, independently of the master output level setting.

Recording output

These are output connectors for recording, supporting RCA plugs.

Digital output

This is a coaxial digital output connector, supporting RCA plugs. The sampling frequency can be set to 96 kHz/24-bit format or 48 kHz/24-bit format to match the connected device. Turn power off before changing this switch position.

Video master output

Supports component, composite (RCA, BNC connector) and S-VIDEO outputs.

Monitor output

Supports composite and S-VIDEO outputs.

CONNECTING MICROPHONE AND HEADPHONES

Microphone

A microphone with XLR-type or Ø 6.3 mm phone-type plug can be connected to the **MIC 1** connector on the operation panel (upper). The **MIC 2** jack on the connection panel (rear) can be used to connect a microphone with Ø 6.3 mm phone-type plug.

- When using a microphone, set the operating panel's **MIC** switch to **[ON]** or **[TALK OVER]**, and adjust the **LEVEL** dial as necessary.
- When not using a microphone, it is recommended to set the **MIC** switch to **[OFF]** and rotate the **LEVEL** dial fully counterclockwise to the **[∞]** side.

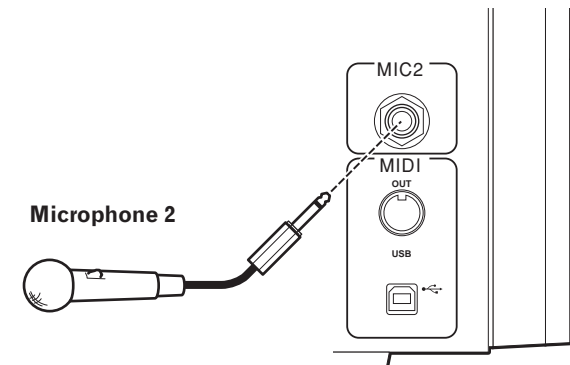
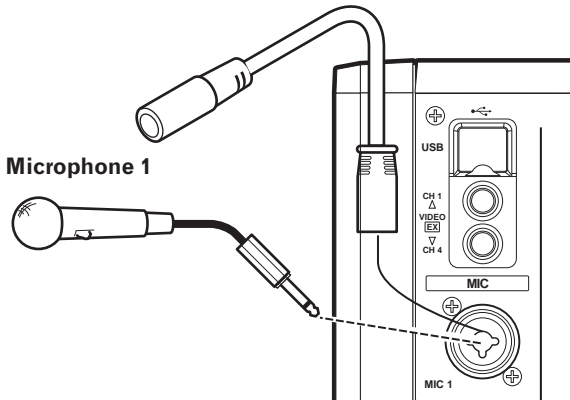

Headphones

The **PHONES** jack on the operating panel (upper) can be used to connect headphones with a Ø 6.3 mm stereo phone plug.

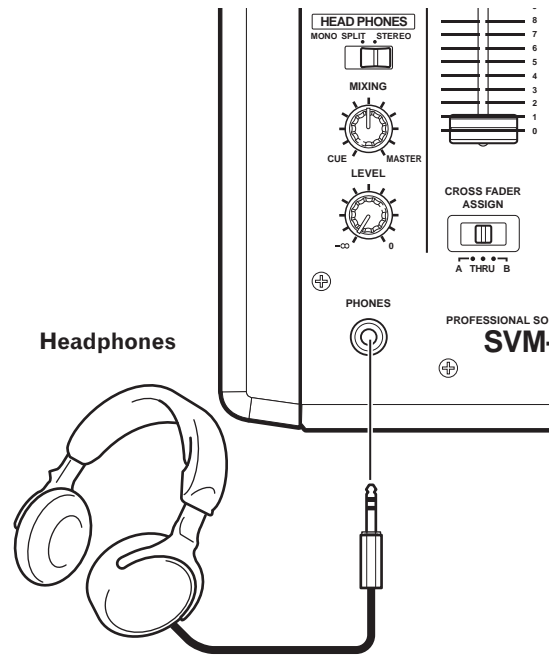

External video connector

A camera, DVD player or other video output device can be connected to the **CH 1/CH 4** video input connectors on the operating panel (top).

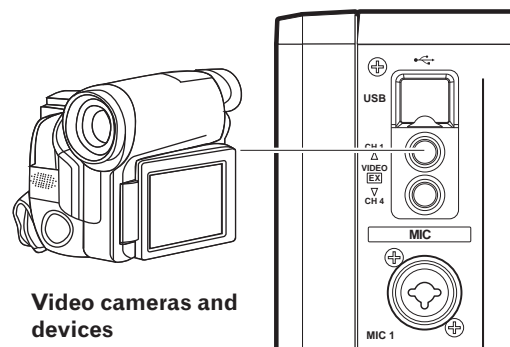

CONNECTING THE POWER CORD

Connect the power cord last.

When all connections are completed, connect one end of the furnished power cord to the AC inlet on the rear panel, and the plug on the other end to a household AC outlet, or the auxiliary power outlet on an amplifier. Use only the furnished power cord for this connection.

BASIC OPERATIONS

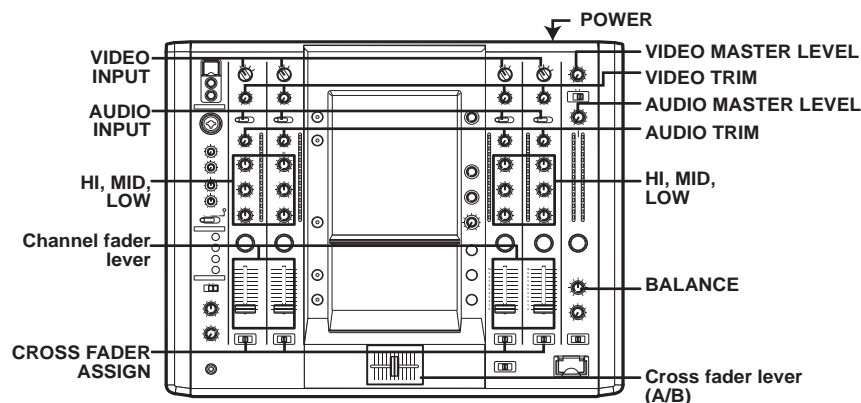

- 1 Set rear panel **POWER** switch to [ON].
- 2 Set the **AUDIO INPUT** switch for the desired channel to match the type of connected component.
 - When using the DVD input, set to [DVD].
 - When using LINE input, set to [LINE].
 - When using DVD/LINE input, set to [DVD/LINE].
 - When using DIGITAL input, set to [DIGITAL].
 - When using PHONO input, set to [PHONO].
- 3 Use the **VIDEO INPUT** switch for the selected channel to choose the video input.
- 4 Use the **AUDIO TRIM** dial to adjust the input level for each channel.
- 5 Use the **VIDEO TRIM** dial to adjust the input level for each channel.
- 6 Use the channel equalizer dials (**HI, MID, LOW**) to adjust the tone.
- 7 Use the channel fader lever to adjust the sound volume of the selected channel.
- 8 To use the cross fader on the selected channel, set the **CROSS FADER ASSIGN** switch to either cross fader channel A or channel B, and operate the cross fader lever (**A/B**).
 - When not using the cross fader, set the **CROSS FADER ASSIGN** switch to [THRU].
- 9 Use the **AUDIO MASTER LEVEL** dial to adjust the overall sound volume.
- 10 Use the **VIDEO MASTER LEVEL** dial to adjust the overall luminance level.
- 11 Use the **BALANCE** dial to adjust the sound balance between right and left.

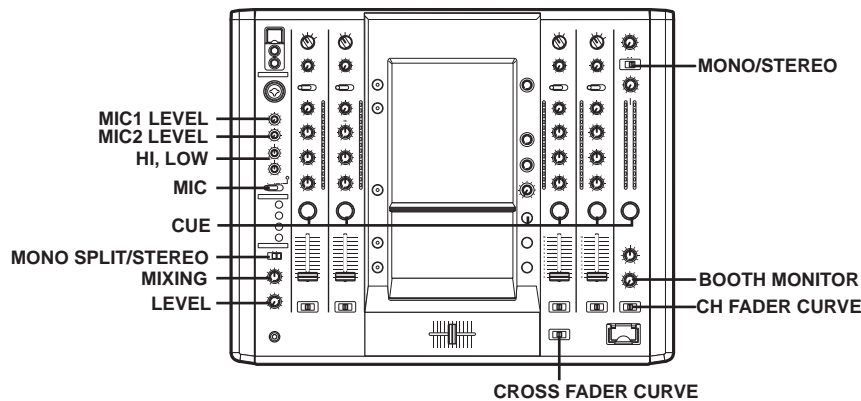

Selecting Stereo or Monaural

When the **MONO/STEREO** switch is set to **[MONO]**, the audio master output becomes a monaural combination of L+R channels.

Microphone Input

- 1 To use a microphone, set the **MIC** switch to **[ON]** or **[TALK OVER]**.
When set to **[TALK OVER]**, any time a sound of -15 dB (default setting) or more is input, all sound sources other than the microphone are attenuated by 20 dB (default setting). These default values can be changed in the hardware setup (P. 42).
- 2 Use the **MIC 1 LEVEL** dial to adjust the sound volume of **MIC 1**, and use the **MIC 2 LEVEL** dial to adjust the sound volume of **MIC 2**.
- 3 Use the microphone equalizer dials (**HI, LOW**) to adjust the tone of the microphone sound.
 - The microphone equalizer function operates simultaneously on microphone 1 and 2.

Booth Monitor Output

- 1 Use the **BOOTH MONITOR** level dial to adjust the sound volume.
 - The **BOOTH MONITOR** level dial can be used to adjust the sound volume independently of the **AUDIO MASTER LEVEL** dial.
 - Use the hardware setup (P. 42) to set whether or not the microphone sound is to be output to the booth monitor.

Headphones Output

- 1 Use the headphone **CUE** buttons (channels 1 to 4, **MASTER**, **EFFECT CUE**) to select the source.
 - The selected **CUE** button lights brightly.
- 2 Set the **HEADPHONES (MONO SPLIT/STEREO)** switch.
 - When set to the **[MONO SPLIT]** position, the sound selected with the headphone **CUE** button is output to the left channel, and the master sound is output to the right channel (only when **MASTER CUE** button is set to ON).
 - When set to the **[STEREO]** position, the sound selected with the headphone **CUE** button is output in stereo.
- 3 When **[MONO SPLIT]** is selected, use the **HEADPHONES MIXING** dial to adjust the balance of sound between the left channel (sound selected with the headphone **CUE** button), and the right channel (master sound).
 - When the **HEADPHONES MIXING** dial is rotated clockwise (toward **[MASTER]**), the master output (only when the **MASTER CUE** button is ON) increases; when rotated counterclockwise (toward **[CUE]**), the sound selected with the headphone **CUE** button increases.

- 4 Use the **HEADPHONES LEVEL** dial to adjust the headphones' sound volume.

- Rotate the **HEADPHONES LEVEL** dial to adjust the sound level.
- When the Effect mode select button (P. 17) is set to **[V]** mode, effect sounds will not be output even if the **EFFECT CUE** button is pressed.

FADER CURVE SELECTION

The response of sound volume change to the fader control can be set in three types.

Use the CH FADER CURVE switch to select the desired channel fader response curve.

The sound volume and video level changes as follows:

- At the left setting, the curve operates to produce a rapid rise as the channel fader approaches its distant position.
- At the right setting, the curve operates to produce an even, neutral rise throughout the channel fader's movement.
- At the middle setting, an intermediate curve is produced, midway between the two curves noted above.
- This setting applies equally to channels 1 to 4.

Use the CROSS FADER CURVE switch to select the cross fader curve response.

Sound volume changes as follows:

- At the left setting, the curve produces a rapid signal rise. (As soon as the cross fader lever leaves the **[A]** side, the **[B]** channel sound is produced.)
- At the right setting, the curve operates to produce an even, neutral rise throughout the cross fader's movement.
- At the middle setting, an intermediate curve is produced, midway between the two curves noted above.
- This setting produces equal curve effects for both sides A and B.

The video level is as noted above only when the video cross fader's video mix effect is set to **[FADE]**.

USING THE VIDEO CONTROL FUNCTIONS

Touch the LCD screen to control video functions. Supports video cross fader functions and video channel switch functions.

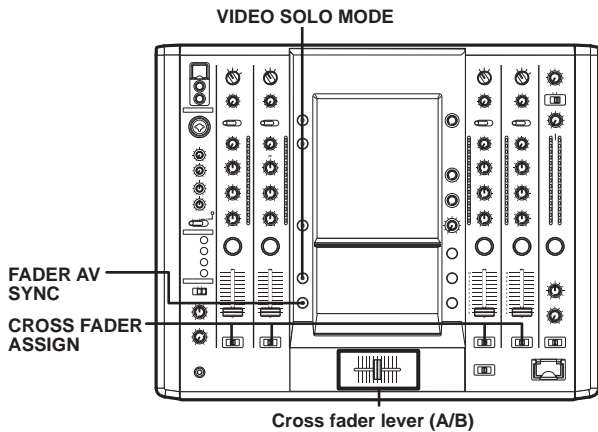

OPERATING THE VIDEO CROSS FADER

The video cross fader is used to manipulate video images.

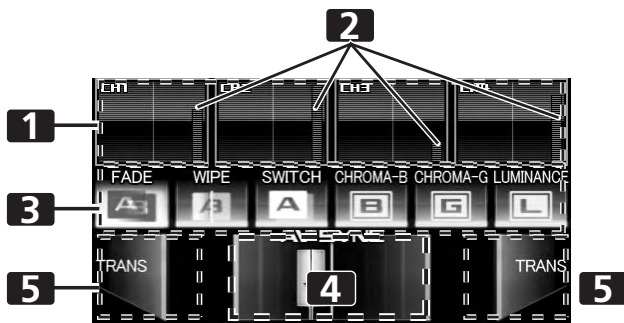

1	Channel monitor	Monitors videos from each input channel (1 through 4). Touch the channel monitor to output the video of each channel.
2	Video level	Indicates video output level. Appears red when FADER AV SYNC is ON, and appears green when FADER AV SYNC is OFF.
3	Video mix effect button	Use to select type of video change when video cross fader is operated.
4	Video Cross fader	Video cross fader.
5	Transformer button [TRANS]	Outputs video of touched side, regardless of position of video cross fader.

1 Using the CROSS FADER ASSIGN switch, choose either Channel A or Channel B of the cross fader

- When assigned to Channel [A], the border of the channel preview monitor appears blue; when assigned to Channel [B], the border of the channel preview monitor appears red. When assigned to [THRU], the border appears gray.
- When JPEG is assigned, the [JPEG] indicator will appear at the upper left of the channel monitor.

2 Touch a video mix effect button to choose a video mix effect.

- The selected button will appear white, and the icon will move as an animation.
- For each effect refer to P. 16.

3 Operate the video cross fader.

- The video will change as video mix effects are being applied.
- When FADER AV SYNC is set to ON, the video cross fader section's [AV SYNC] indicator will appear, and the video cross fader will operate in synchronization with the cross fader. Touching the video cross fader allows you to manipulate the video while you are touching it. Release to return to the same position as the cross fader.
- When FADER AV SYNC is set to OFF, the video cross fader section's [AV SYNC] indicator goes out, and the sound and video are controlled independently. The sound is controlled by the cross fader, and the video by the video cross fader.
- When the [TRANS] button is touched, the video corresponding to the touched side will be output regardless of the position of the video cross fader.
- When all cross fader assigns are set to [THRU], the video cross fader and [TRANS] button will appear gray, and if assigned, the buttons will function as video cross fader, [TRANS] buttons, with [A] side appearing blue and [B] side appearing red.

OPERATING THE VIDEO CHANNEL SWITCH

The channel monitor functions as a switch to turn that channel's video ON/OFF.

1 Touch the channel monitor.

- The touched video output will alternate ON/OFF.
- When FADER AV SYNC is set to ON, the video level will be displayed in red. If the video level is not displayed (channel fader is [0]), touch the channel to output that channel's video. Or alternately, when the video level is displayed, touching the channel monitor will cause that channel's video to turn off during the duration the screen is touched.
- When FADER AV SYNC is set to OFF, the video level is displayed in green. The channel monitor can be touched to alternate that video output ON/OFF.

USING THE VIDEO CONTROL FUNCTIONS

OPERATING IN THE VIDEO SOLO MODE

Setting video solo mode to ON allows instantaneous switching to the desired channel's video.

By combining with the **FADER AV SYNC** button ON/OFF, a variety of operations is possible.

Whenever the power is first turned ON, the video solo mode is set to OFF by default.

When the video solo mode is ON, the **VIDEO SOLO MODE** button will flash.

When FADER AV SYNC is ON

- When the channel monitor is touched, output instantaneously switches to the video of the touched channel.
- When the channel fader begins rising from the [0] position, output instantaneously switches to that channel's video.

When FADER AV SYNC is OFF

- When the channel monitor is touched, output instantaneously switches to the video of the touched channel.

Upon changing the FADER AV SYNC from ON to OFF, the original channel fader position will be maintained until the channel monitor is touched again.

Operation of the video cross fader and **[TRANS]** button are not supported in the video solo mode.

VIDEO MIX EFFECTS CHART

Video mix effects

Video cross fader

No	Name	Description of the effect
1	FADE	Switches video while mixing.
2	WIPE	Switches video while wiping away.
3	SWITCH	Switches instantaneously (without mixing).
4	CHROMA-B	Switches from the blue component of video on cross fader side [A] to the video on side [B].
5	CHROMA-G	Switches from the green component of video on cross fader side [A] to the video on side [B].
6	LUMINANCE	Switches from the dark portion of video on cross fader side [A] to the video on side [B].

USING THE EFFECT FUNCTION

This function applies effects to the selected channel's sound and video. Effects include BEAT effects, which are applied in linkage to the track's BPM; TOUCH effects, which control effects by directly touching the screen; and TEXT effects, which display onscreen characters with effects added in rhythm to the track. The **UTILITY (MASTER MONITOR)** button can be pressed to display the master monitor's image on the LCD screen.

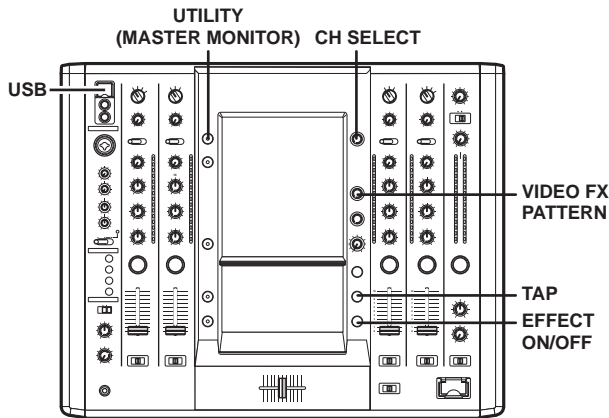

When master monitor is on

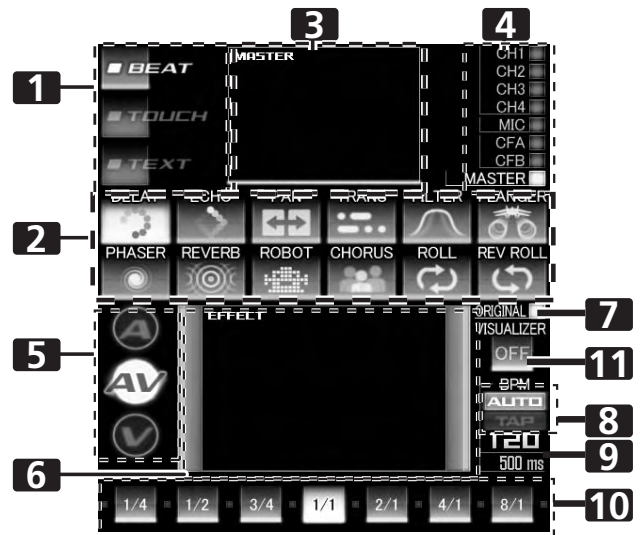

USING BEAT EFFECTS

BEAT effects can be instantaneously set in-sync with the BPM (Beat Per Minute) of the track, enabling you to apply various effects to the rhythm even during live performances.

When master monitor is off

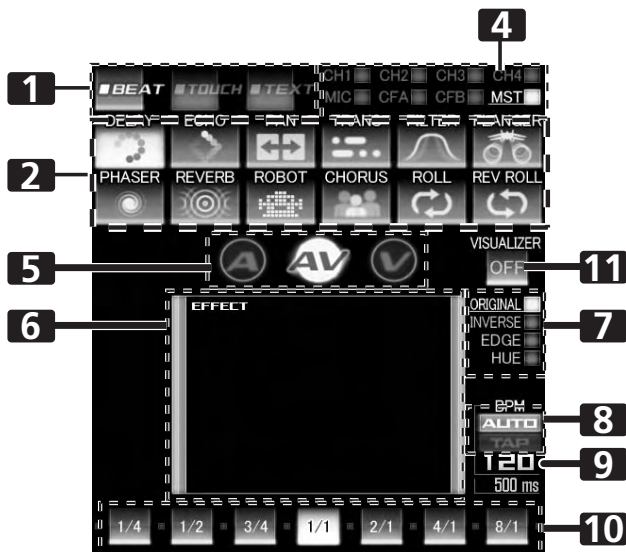

1	Effect category buttons	Selects the category of effects you wish to apply. Select from [BEAT] (red), [TOUCH] (blue), and [TEXT] (green).
2	Effect select buttons	Select and touch the desired effect button from the 12 BEAT effects.
3	MASTER monitor	When master monitor is on, displays master output.
4	Channel select display	Rotate the CH SELECT dial to select the channel to which you wish to apply the effect.
5	Effect mode select buttons	A: Touch to apply the effect to audio only. AV: Touch to apply the effect to both audio and video. V: Touch to apply the effect to video only.
6	Video EFFECT monitor	Monitors effect results.
7	Video effect pattern display	Rotate the VIDEO FX PATTERN/TEXT BANK dial to select the video effect pattern. When BEAT effect is enabled, you can choose from [ORIGINAL]/[INVERSE]/[EDGE]/[HUE].
8	[BPM AUTO/TAP] button	Touch to switch the measurement method of the BPM between AUTO and TAP.
9	BPM/parameter display	Displays the measured BPM and effect parameters.
10	Beat button	Touch to select the multiplication factor of the beat calculated from the BPM for synchronization of effects.
11	[VISUALIZER] button	Allows use of images produced internally by the unit.

USING THE EFFECT FUNCTION

1 Touch the [BPM AUTO/TAP] button to select the BPM (=Beat Per Minute) measurement mode.

AUTO: The BPM is automatically measured from the input music signal.

TAP: Tap the **TAP** button with your finger to manually input the BPM.

- Whenever power is first turned ON, [AUTO] is selected by default.
- The selected mode ([AUTO]/[TAP]) will appear in the display.
- When a BPM cannot be measured automatically, the BPM display in the display will flash.
- The measurement range of AUTO mode is BPM=70 to 180. **Depending on the track, the BPM may not be accurately measured.** In these cases, use TAP mode to manually enter the BPM.

[Manually entering the BPM using the TAP button]

When the **TAP** button is tapped to the beat (a quarter note) more than twice, the average length will be set as the BPM.

- Pressing the **TAP** button during [AUTO] mode will switch the BPM measurement mode to [TAP], and the length between the taps will be measured.
- When a BPM is set using the **TAP** button, the multiplication factor will become [1/1] or [4/1] (depending on the effect), and the effect time will be set to either the length of 1 beat (a quarter note) or 4 beats.
- Rotate the **TIME/PARAMETER** dial while pressing the **TAP** button to set the BPM directly.
- Touch the [BPM AUTO/TAP] button to return to [AUTO] mode.

2 Touch the effect category button [BEAT].

- The [BEAT] button will light brightly, and the icon will move as an animation.
- The BEAT effect screen will be displayed.
- Whenever power is first turned ON, the [BEAT] effect is selected by default.

3 Use the effect select buttons to select an effect type.

- The selected button will appear white, and the icon will move as an animation.
- For a description of each effect, refer to P. 23.

4 Use the CH SELECT dial to select the channel to which you wish to apply the effect.

- The selected effect channel display will appear white.
- If [MIC] is selected, the audio effect will be applied to both MIC 1 and MIC 2. There will be no effect on the video.
- When turning the power ON, [MASTER] will be selected.

5 Touch the effect mode select button to select the effect mode.

- The selected button will appear white, and the icon will move as an animation.

A: The effect will be applied to the audio only.

AV: The effect will be applied to both the audio and video.

V: The effect will be applied to the video only.

- When turning the power ON, [AV] will be selected.

6 Touch the beat button to choose the multiplication factor of the beat for synchronization of the effect.

- Select the beat number calculated from the BPM.
- The selected beat button will be highlighted.
- An effect time that corresponds to the multiplication factor of the beat will be automatically set.

[Example] When BPM=120

1/1 = 500 ms

1/2 = 250 ms

2/1 = 1000 ms

7 Set the EFFECT ON/OFF button to ON to apply the effect.

- Each time the button is pressed it will switch between ON and OFF (whenever power is first turned ON, the setting defaults to OFF).
- When effect is ON, the button flashes.

Video effect pattern

Rotate the **VIDEO FX PATTERN/TEXT BANK** dial to select a video effect pattern for the selected video effect.

For descriptions on the video effect pattern change caused by rotating the **VIDEO FX PATTERN/TEXT BANK** dial, refer to P. 24.

Parameter 1

Rotate the **TIME/PARAMETER** dial to adjust temporal parameters of the selected effect.

For descriptions on the changes in parameter 1 caused by turning the **TIME/PARAMETER** dial, refer to P. 23.

Parameter 2

Rotate the **LEVEL/DEPTH** dial to adjust quantitative parameters of the selected effect.

For descriptions on the changes in parameter 2 caused by rotating the **LEVEL/DEPTH** dial, refer to P. 23.

Using the visualizer

This function allows the use of images produced internally by the unit.

1 Set [VISUALIZER] button to [ON].

The video effect monitor displays the image.

2 Use the effect select buttons to choose a desired image.

3 Use the CH SELECT dial to select the desired channel.

- The image will move automatically in rhythm to the music's beat.
- In the event no input image is present, the visualizer's image can be used.

USING THE EFFECT FUNCTION

USING TOUCH EFFECTS

With TOUCH effects, many effects can be created by touching the video EFFECT performance monitor.

When master monitor is off

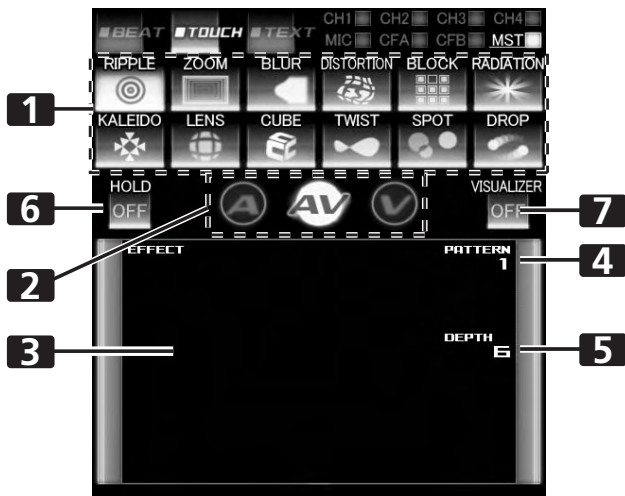

When master monitor is on

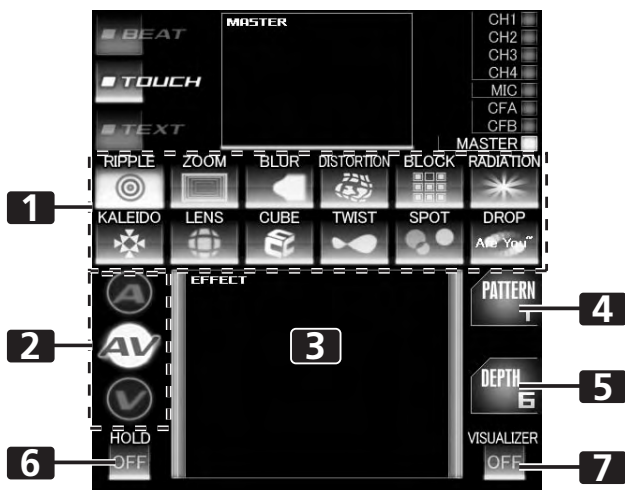

1	Effect select buttons	Select and touch the desired effect button from the 12 TOUCH effects.
2	Effect mode select buttons	A: Touch to apply the effect to audio only. AV: Touch to apply the effect to both audio and video. V: Touch to apply the effect to video only.
3	Video EFFECT performance monitor	Touch here to apply effects to the video image.
4	Video effect pattern display	Rotate the VIDEO FX PATTERN/TEXT BANK dial to select the video effect pattern. The pattern will differ depending on the effect type.
5	Parameter display	Displays the TOUCH effect parameter. The parameter will differ depending on the effect type

6	[HOLD] button	When [HOLD] button is set to [ON] , effects are recorded from the time the screen is touched until the finger is removed.
7	[VISUALIZER] button	Internally creates a video image to which TOUCH effects can be applied.

- Touch the effect category button [TOUCH].**
 - The **[TOUCH]** button will light brightly, and the icon will move as an animation.
 - The TOUCH effect screen will be displayed.
- Select an effect from the effect select buttons.**
 - The selected button will appear white, and the icon will move as an animation.
 - For a description of each effect, refer to P. 25.
- Use the CH SELECT dial to select the channel to which you wish to apply the effect.**
 - The selected effect channel display will appear white.
 - If **[MIC]** is selected, the audio effect will be applied to both MIC 1 and MIC 2. There will be no effect on the video.
- Touch the effect mode select button to select the effect mode.**
 - The selected button will appear white, and the icon will move as an animation.
 - A:** The effect will be applied to the audio only.
 - AV:** The effect will be applied to both the audio and video.
 - V:** The effect will be applied to the video only.
 - When turning the power ON, **[AV]** will be selected.
- Set the EFFECT ON/OFF button to ON to apply the effect.**
 - Each time the button is pressed it will switch between ON and OFF (whenever power is first turned ON, the setting defaults to OFF).
 - When effect is ON, the button flashes.
- Touch the video effect performance monitor to change the effects.**
 - When **[HOLD]** button is set to **[ON]**, effects are recorded from the time the screen is touched until the finger is removed (max. 8 sec.), then output repeatedly.
 - Each time the **[HOLD]** button is touched it will switch between **[ON]** and **[OFF]**.
 - Whenever power is first turned ON, the setting defaults to **[OFF]**.

Pattern

Rotate the **VIDEO FX PATTERN/TEXT BANK** dial to select a video effect pattern of the selected video effect.

For descriptions of the video pattern changes caused by rotating the **VIDEO FX PATTERN/TEXT BANK** dial, refer to P. 25.

Parameter 1

Rotate the **TIME/PARAMETER** dial to adjust the parameters for the selected effect.

For descriptions on the changes in parameter 1 caused by rotating the **TIME/PARAMETER** dial, refer to P. 25.

Parameter 2

Rotate the **LEVEL/DEPTH** dial to adjust the quantitative parameters for the selected effect.

For descriptions on the changes in parameter 2 caused by rotating the **LEVEL/DEPTH** dial, refer to P. 25.

Using the Visualizer

This function allows the use of images produced internally by the unit.

- Set [VISUALIZER] button to [ON].**

The video effect performance monitor displays the image.

USING THE EFFECT FUNCTION

- Use the effect select buttons to choose a desired image.
- Touch the image to apply changes.
- Use the CH SELECT dial to select the desired channel.
 - In the event no input image is present, the visualizer's image can be used.

USING TEXT EFFECTS

TEXT effects can be instantaneously set in-sync with the BPM (Beat Per Minute) of the track, enabling you to apply various TEXT effects to the rhythm.

When master monitor is off

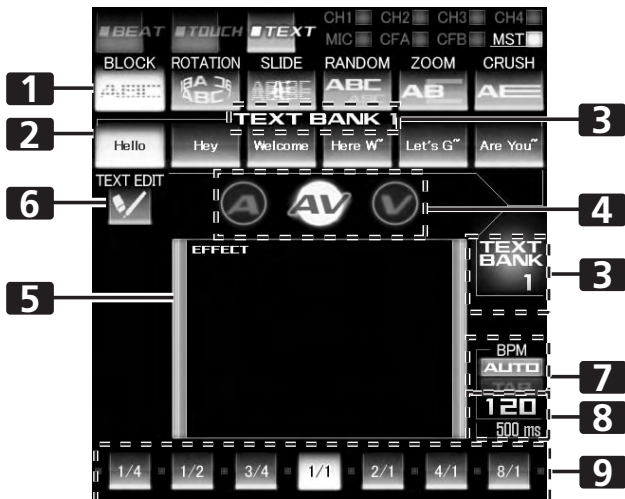

When master monitor is on

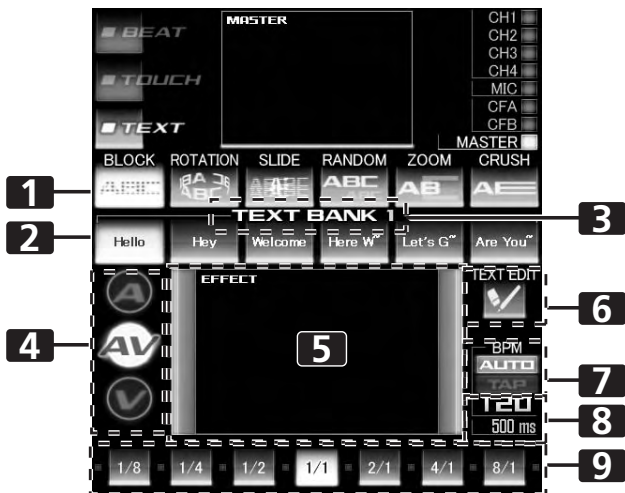

1	Effect select buttons	Select and touch the desired effect button from the 6 TEXT effects.
2	[TEXT BANK] buttons	Touch the text button of your choice from the 6 texts.
3	TEXT BANK display	Rotate the VIDEO FX PATTERN/TEXT BANK dial to select a TEXT BANK from the 10 available.
4	Effect mode select button	A: Touch to apply the effect to audio only. AV: Touch to apply the effect to both audio and video. V: Touch to apply the effect to video only.

5	Video EFFECT monitor	Monitors the TEXT effects.
6	[TEXT EDIT] button	Touch to edit the text of the selected [TEXT BANK] button.
7	[BPM AUTO/TAP] button	Touch to switch the measurement method of the BPM between AUTO and TAP. Pressing the TAP button will also switch this to TAP.
8	Parameter display	Displays the measured BPM and effect parameters.
9	Beat button/beat display	Touch to select the multiplication factor of the beat calculated from the BPM for synchronization of effects.

- Touch the **[BPM AUTO/TAP]** button to select the **BPM (=Beat Per Minute) measurement mode**.

AUTO: The BPM is automatically measured from the input music signal.

TAP: Tap the **TAP** button with your finger to manually input the BPM.

- Whenever power is first turned ON, **[AUTO]** is selected by default.
- The selected mode (**[AUTO]/[TAP]**) will appear in the display.
- When a BPM cannot be measured automatically, the BPM display in the display will flash.
- The measurement range of AUTO mode is BPM=70 to 180. **Depending on the track, the BPM may not be accurately measured.** In these cases, use TAP mode to manually input the BPM.

- Touch the effect category button **[TEXT]**.
 - The **[TEXT]** button will light brightly, and the icon will move as an animation.
 - The TEXT effect screen will be displayed.
- Select a text effect using the effect select buttons.
 - The selected button will appear white, and the icon will move as an animation.
 - For a description of each effect, refer to P. 30.
- Choose a text from **TEXT BANK**.
 - Rotate the **VIDEO FX PATTERN/TEXT BANK** dial to select **TEXT BANK** and touch the **[TEXT BANK]** button to select the text.
 - The selected button will appear white.
- Use the **CH SELECT** dial to select the channel to which you wish to apply the effect.
 - The selected effect channel display will be highlighted.
 - TEXT effects are not supported when **[MIC]** is selected. Effects are applied to audio only.
- Touch the effect mode select buttons to choose the effect mode.
 - The selected button will be highlighted and an animation will appear.
 - A:** An effect will be applied to the audio only.
 - AV:** An effect will be applied to both the audio and video.
 - V:** An effect will be applied to the video only.
 - When turning the power ON, **[AV]** will be selected.

USING THE EFFECT FUNCTION

7 Touch the beat button to choose the multiplication factor of the beat for synchronization of the effect.

- Select the beat number calculated from the BPM.
- The selected beat button will be highlighted.
- An effect time that corresponds to the multiplication factor of the beat will be automatically set.

[Example] When BPM=120

1/1 = 500 ms

1/2 = 250 ms

2/1 = 1000 ms

8 Set the effect EFFECT ON/OFF button to ON to apply the effect.

- Each time the button is pressed it will switch between ON and OFF (whenever power is first turned ON, the setting defaults to OFF).
- When effect is ON, the button is flashes.

Text bank

Rotate the **VIDEO FX PATTERN/TEXT BANK** dial to select a TEXT BANK.

Parameter 1

Rotate the **TIME/PARAMETER** dial to adjust temporal parameters of the selected effect.

For descriptions on the changes in parameter 1 caused by rotating the **TIME/PARAMETER** dial, refer to P. 30.

Parameter 2

Rotate the **LEVEL/DEPTH** dial to adjust quantitative parameters of the selected effect.

For descriptions on the changes in parameter 2 caused by rotating the **LEVEL/DEPTH** dial, refer to P. 30.

USING THE EFFECT FUNCTION

EDITING TEXT

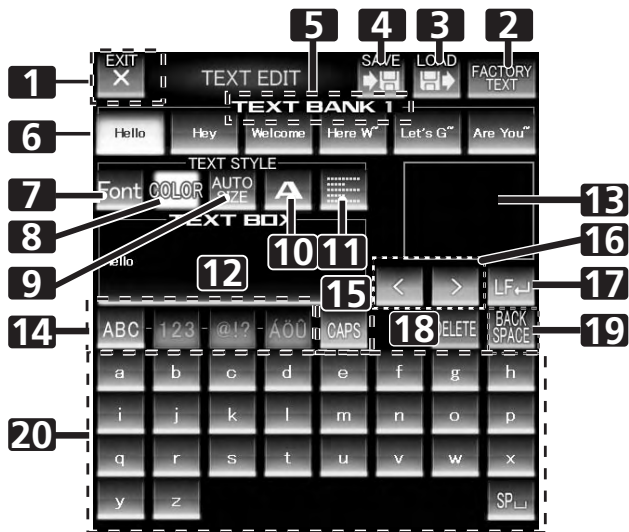

1 [EXIT] button	Touch to exit the TEXT EDIT screen and return to the TEXT effect screen.
2 [FACTORY TEXT] button	Touch to load factory text data.
3 [LOAD] button	Touch to load text data from an SD card.
4 [SAVE] button	Text entered into the TEXT BANK can be saved to an SD card.
5 TEXT BANK display	Rotate the VIDEO FX PATTERN/TEXT BANK dial to select a TEXT BANK you wish to edit from the 10 available.
6 [TEXT BANK] buttons	Entered text can be stored. Also touch to call up stored text.
7 [FONT] button	Touch to change the font of the text. The font alternates each time the button is touched.
8 [COLOR] button	Touch to change the color of the entered text. The color alternates each time the button is touched.
9 [SIZE] button	Touch to change the size of the entered text. The size alternates each time the button is touched.
10 Character button	Touch to change the character of the input text. The character alternates each time the button is touched.
11 Justify button	Touch to justify the text to the left, center, or right. The justification alternates each time the button is touched.
12 TEXT BOX	Displays the entered text.
13 TEXT effect monitor	The TEXT effect is monitored here.
14 Text type select buttons	Use to change the text type.
15 [CAPS] / [PAGE] button	Touch to alternate between upper and lower case, and between page display for page 1 and 2.
16 Cursor move button (<, >)	Touch to move the cursor.
17 Line break button (LF)	Touch to create a line break in the text.

18 [DELETE] button	Touch to delete entered text. The text behind the cursor will be deleted. Hold depressed to delete all text.
19 [BACK SPACE] button	Touch to delete entered text. The text before the cursor will be deleted.
20 Text input button	Touch to enter text.

- 1 Touch the [TEXT EDIT] button.
 - The TEXT EDIT screen appears.
 - Touch the [EXIT] button to return to the TEXT effect screen.
- 2 Rotate the VIDEO FX PATTERN/TEXT BANK dial to select TEXT BANK and touch the [TEXT BANK] button to select the text you wish to edit.
 - The selected button will be highlighted.
 - If the [TEXT BANK] button is touched, the text will appear in the TEXT BOX.
- 3 Touch the [FONT] button to change the font of the text.
 - The font will change each time the button is touched. The font alternates between six different fonts.
- 4 Touch the [COLOR] button to change the text color.
 - The color changes each time the button is touched. The color alternates between eight different colors.
- 5 Touch the [SIZE] button to change the text size.
 - The size changes each time the button is touched. The size alternates between four different sizes.
 - Under some conditions, [AUTO SIZE] and [BIG] settings will produce the same sized images.
- 6 Touch the character button to change the text character.
 - The character changes each time the button is touched. The character alternates between five different characters.
 - For the character, refer to P. 30
- 7 Touch the justify button to change the justification of the text.
 - The justification changes each time the button is touched. The justification alternates between three different justifications.
- 8 Touch the text type select button to change the text type of the text.
 - The selected button will be highlighted.
 - Touch the caps button to switch between upper case and lower case.
- 9 Touch the text input button to enter text.
 - The entered text will appear in the text box.
 - A maximum of 50 letters can be entered.
- 10 Touch the [EXIT] button to finish text edit.
 - Text can be edited in real time.
 - When power is turned off, settings return to default values.

SAVE/LOAD

- TEXT BANK can be saved to SD card. TEXT BANK saved on an SD card can also be loaded.
- The [LOAD] button and [SAVE] button will not be displayed if no SD card is detected.

USB keyboard

A USB keyboard can be connected to the USB port to allow text to be entered directly from the keyboard.

For the encoding setting of the keyboard, refer to P. 41.

DISPLAYING/HIDING THE MASTER MONITOR

- 1 Press the UTILITY (MASTER MONITOR) button.
 - Each time the button is pressed, the master monitor display alternates ON/OFF.
 - When the master monitor is set to display, the master monitor will appear in the center display, and the content of the master output video can be observed.
 - Whenever power is first turned ON, the master monitor defaults to OFF.

USING THE EFFECT FUNCTION

EFFECT LIST

BEAT effects (*1)

	Description of the effect	Beat button parameter	Parameter 1 (TIME/PARAMETER)		Parameter 2 (LEVEL/DEPTH)	
			Description	Description		
1. DELAY (*7)	AUDIO	Repeat sound will be output once to the beat.	For the time of 1 BPM beat, a 1/4 to 8/1 delay time will be set.	Sets delay time.	1 to 4 000 (ms) (*3)	Sets the balance between the original sound and the delay sound.
	VIDEO	Repeat video will be output once to the beat.	For the time of 1 BPM beat, a 1/4 to 8/1 delay time will be set.	Sets delay time.		Sets the balance between the original video and the delay video.
2. ECHO (*7)	AUDIO (*2)	Sound will be output several times to the beat as it attenuates.	For the time of 1 BPM beat, a 1/4 to 8/1 delay time will be set.	Sets delay time.	1 to 4 000 (ms) (*3)	Sets the balance between the original sound and the echo sound.
	VIDEO	Video will be output several times to the beat as it attenuates.	For the time of 1 BPM beat, a 1/4 to 8/1 delay time will be set.	Sets delay time.		Sets the balance between the original video and the echo video.
3. PAN	AUDIO	Sound sways right and left to the beat.	For the time of 1 BPM beat, a 1/8 to 8/1 sway time (for audio) will be set.	Sets effect time.	10 to 16 000 (ms)	Sets the balance between the original sound and the effect sound.
	VIDEO	Video sways right and left to the beat.	For the time of 1 BPM beat, a 1/8 to 8/1 sway time (for video) will be set.	Sets effect time.		Sets the balance between the original video and the effect video.
4. TRANS	AUDIO	Sound is cut off to the beat.	For the time of 1 BPM beat, a 1/8 to 8/1 cut time will be set.	Sets effect time.	10 to 16 000 (ms) (*4)	Sets the balance between the original sound and the effect sound.
	VIDEO	Video is cut off to the beat.	For the time of 1 BPM beat, a 1/8 to 8/1 cut time will be set.	Sets effect time.		Sets the balance between the original video and the effect video.
5. FILTER	AUDIO	Dramatically changes the sound tone by moving the cutoff frequency of the filter in rhythm to the beat.	For the time of 1 BPM beat, a 1/2 to 32/1 time will be set for the cycle in which the cutoff frequency is moved.	Sets the cycle in which the cutoff frequency moves.	10 to 32 000 (ms)	The effect is enhanced as the dial is rotated to the right.
	VIDEO	Outputs an opaque video to the beat.	For the time of 1 BPM beat, a 1/2 to 32/1 time will be set for the cycle in which the opaque filter is applied.	Sets the cycle in which the opaque filter is applied.		Sets the balance between the original video and the effect video.
6. FLANGER	AUDIO	One Flanger effect cycle is quickly and simply created to the beat.	For the time of 1 BPM beat, a 1/2 to 32/1 time will be set for the interval in which the flanger effect is moved.	Sets the interval in which the flanger effect moves.	10 to 32 000 (ms)	The effect is enhanced as the dial is rotated to the right. Only the original sound will be output when the dial is rotated completely to the left.
	VIDEO	An enlarged image of the contour of the video is output to the beat.	For the time of 1 BPM beat, 1/2 to 32/1 time will be set for the interval in which the effect screen appears.	Sets the interval in which the effect screen appears.		Sets the balance between the original video and the effect video.
7. PHASER	AUDIO	One cycle of phaser effect is quickly and simply created to the beat.	For the time of 1 BPM beat, a 1/2 to 32/1 time will be set for the interval in which the phaser effect is moved.	Sets the interval in which the phaser effect moves.	10 to 32 000 (ms)	The effect is enhanced as the dial is rotated to the right. Only the original sound will be output when the dial is rotated completely to the left.
	VIDEO	An rotating image of the contour of the video will be output to the beat.	For the time of 1 BPM beat, 1/2 to 32/1 time will be set for the interval in which the effect screen appears.	Sets the interval in which the effect screen appears.		Sets the balance between the original video and the effect video.
8. REVERB	AUDIO (*2)	Reverberation effect.	Sets the degree of the reverberation from between 10 % and 90 %.	Sets the degree of the reverberation.	1 to 100 (%)	Sets the balance between the original sound and the effect sound.
	VIDEO	Video with an afterimage will be output.	Sets the degree of the afterimage from between 10 % and 90 %.	Sets the degree of the afterimage.		Sets the balance between the original video and the effect video.

USING THE EFFECT FUNCTION

		Description of the effect	Beat button parameter	Parameter 1 (TIME/PARAMETER)		Parameter 2 (LEVEL/DEPTH)	
				Description		Description	
9. ROBOT	AUDIO	The input sound is given an effect like that created by a robot.	Sets the effect of the robotic sound pitch between -100 % and 100 %	Sets the effect of the robotic sound pitch.	-100 to 100 (%)	The effect is enhanced as the dial is rotated to the right.	
	VIDEO	A robot-like video is created by swinging the image up and down and applying a mosaic filter.	Sets the ratio of the mix between the mosaic size and the original video between -100 % and 100 %	Sets the ratio of the mix between the mosaic size and the original video.		The up and down swinging is enhanced as the dial is rotated to the right.	
10. CHORUS	AUDIO	An expansive sound as if various sources were emitting the same sound pitch.	For the time of 1 BPM beat, a 1/2 to 32/1 time will be set for the interval of the vibrato of the chorus sound.	Sets the interval in which the chorus sound is modulated.	10 to 32 000 (ms)	Sets the balance between the original sound and the chorus sound.	
	VIDEO	A video divided into RGB components is output to the beat.	For the time of 1 BPM beat, a 1/2 to 32/1 time will be set for the interval in which the image returns to the original.	Sets the interval in which the image returns to its original.		Sets the balance between the original video and the effect video.	
11. ROLL (*5, 7)	AUDIO (*2)	Records and repetitively outputs the beat sound.	For the time of 1 BPM beat, a 1/8 to 8/1 effect time is set.	Sets effect time.	10 to 4 000 (ms) (*3)	Sets the balance between the original sound and the ROLL sound.	
	VIDEO (*6)	Records and repetitively outputs the beat image.	For the time of 1 BPM beat, a 1/8 to 8/1 effect time is set.	Sets the time in which the image is repeated.		Sets the balance between the original video and the effect video.	
12. REVERSE ROLL (*5, 7)	AUDIO (*2)	Records and repetitively outputs the beat sound in reverse.	For the time of 1 BPM beat, a 1/8 to 8/1 effect time is set.	Sets effect time.	10 to 4 000 (ms) (*3)	Sets the balance between the original sound and the ROLL sound.	
	VIDEO (*6)	Records and repetitively outputs the beat video in reverse.	For the time of 1 BPM beat, a 1/8 to 8/1 effect time is set.	Sets the time in which the image is repeated.		Sets the balance between the original video and the effect video.	

(*1) When the effect channel display shows [CFA], [CFB], or [MST]/[MASTER], even if the effect monitor is turned ON, if the selected channel's sound is not output to the master output, the effect sound will not be heard.

(*2) If effect is set to OFF, the effect sound will not be audible when monitoring effects.

(*3) The shortest video effect time value is: For NTSC, 66 ms. For PAL, 80 ms.

(*4) The shortest video effect time value is: For NTSC, 99 ms. For PAL, 119 ms.

(*5) When the visualizer function is switched from ON to OFF, the visualizer's image will be subjected to ROLL in the sampling state.

(*6) When effects are set to OFF, images with effects applied will not be displayed on the video effects monitor.

(*7) Effects will be disabled in all channels if copy-protected contents are input to any channel. In other words, in this case effects will not function even if non-copy-protected contents are input to the channel to which you wish to apply effects.

Video effect pattern

No.	Name	Description of video effect pattern
1	ORIGINAL	Original image without video effect pattern.
2	INVERSE	Inverts brightness.
3	EDGE	Creates a border around the image.
4	HUE	Changes the color (except black and white).

USING THE EFFECT FUNCTION

TOUCH effects (*1)

	Description of the effect	Description of the effect when touched	Parameter 1 (TIME/PARAMETER)		Parameter 2 (LEVEL/DEPTH)	
			Description	Description		
1. RIPPLE (*2)	AUDIO	Phasing effect is applied proportional to the volume of the input bass sound.	Touch the screen toward the right to enhance the effect. Touch toward the left to reduce the effect.	–	–	Rotate the dial clockwise to enhance the effect. When dial is rotated fully counterclockwise, only original sound is output.
	VIDEO	Outputs an effect in which ripples spread from the point being touched.				
	PATTERN1	Continuously outputs five ripples.	Outputs an effect in which ripples spread from the point being touched.	Sets the strength (the amplitude) of the ripples.	1 to 10	Sets the balance between the original video and the effect video.
	PATTERN2	Continuously outputs seven ripple designs (shifts in the brightness).				
	PATTERN3	Outputs curtain-like ripples.				
PATTERN4	Continuously outputs three large ripples.					
2. ZOOM (*2)	AUDIO (*4)	Outputs a reverberation effect.	Touch the screen toward the right to enhance the effect. Touch toward the left to reduce the effect.	–	–	Sets the balance between the original sound and the effect sound.
	VIDEO	Outputs a magnified or reduced-size image.				
	PATTERN1	Outputs an image zoomed in on the point touched.	Outputs an image zoomed in on the point touched.	Sets the scale of magnification/reduction.	1 to 10	Sets the balance between the original video and the effect video.
	PATTERN2	Outputs an image stretched horizontally from the point touched.	Outputs an image stretched horizontally from the point touched.			
	PATTERN3	Outputs an image stretched vertically from the point touched.	Outputs an image stretched vertically from the point touched.			
PATTERN4	Outputs an image zoomed out from the point touched.	Outputs an image zoomed out from the point touched.				
3. BLUR (*2)	AUDIO	Outputs a sound with the cutoff frequency of the filter changed.				
	PATTERN1	Outputs a sound through a low-pass filter.	Touch the screen toward the right to enhance the effect. Touch toward the left to reduce the effect.	–	–	
	PATTERN2	Outputs a sound through a high-pass filter.	Touch the screen toward the right to enhance the effect. Touch toward the left to reduce the effect.	–	–	
	PATTERN3	Outputs a sound through a band-pass filter.	Touch the screen toward the right to enhance the effect. Touch toward the left to reduce the effect.	–	–	
	PATTERN4	Outputs a sound through a notch filter.	Touch the screen toward the right to enhance the effect. Touch toward the left to reduce the effect.	–	–	
	VIDEO	Outputs a blurred image.				
	PATTERN1	Outputs an image with blur toward the left side.	Touch more toward the right to enhance the blurred effect on the left side.	Sets color when blur effect is applied.	1 to 10	Sets the balance between the original video and the effect video.
	PATTERN2	Outputs an image with blur toward the right side.	Touch more toward the right to enhance the blurred effect on the right side.			
	PATTERN3	Outputs an image with blur toward the bottom side.	Touch more toward the right to enhance the blurred effect on the bottom side.			
PATTERN4	Outputs an image with blur toward the top side.	Touch more toward the right to enhance the out-of-focus effect on the top side.				

USING THE EFFECT FUNCTION

		Description of the effect	Description of the effect when touched	Parameter 1 (TIME/PARAMETER)		Parameter 2 (LEVEL/DEPTH)
				Description	Description	
4. DISTORTION (*2)	AUDIO (*4)	Outputs a phaser effect with reverberation.	Touch more toward the right to increase the length of the phaser effect cycle. Touch toward the left for shorter cycle length.	–	–	Sets the balance between the original sound and the effect sound.
	VIDEO	Outputs an image with a warping effect.				
	PATTERN1	Outputs an image in which the screen warps with the appearance of paint mixed with water.	The warp effect is applied centering on the touched point. The longer you touch the screen, the stronger the effect becomes.	Sets the area in which the effect is applied.	1 to 10	Sets the balance between the original video and the effect video.
	PATTERN2	Outputs an image with effect applied like pixelation distortion from the point the screen is touched.				
	PATTERN3	Outputs an image with fragmented warp.				
PATTERN4	Outputs an image with spiral warp.					
5. BLOCK	AUDIO	Modulates the input sound. The bass sound has a metallic quality.	Touch the screen toward the right to enhance the effect. Touch toward the left to reduce the effect.	–	–	Sets the balance between the original sound and the effect sound.
	VIDEO	Outputs an images lined in blocks.				
	PATTERN1	Outputs an image in which the touched block stretches and shrinks in the horizontal and vertical direction.	Outputs an image in which the touched block stretches and shrinks in the horizontal and vertical direction.	Sets the number of partitions of the blocks.	1 to 10	Sets the balance between the original video and the effect video.
	PATTERN2	Outputs an image in which the touched block stretches and shrinks in the horizontal direction.				
	PATTERN3	Outputs an image in which the touched block stretches and shrinks in the vertical direction.				
PATTERN4	Outputs an image in which the touched block changes color.					
6. RADIATION	AUDIO	Outputs audio as if the input sound has been crushed.	Touch the screen toward the right to enhance the effect. Touch toward the left to reduce the effect.	–	–	Rotate the dial clockwise to enhance the effect. When dial is rotated fully counterclockwise, only original sound is output.
	VIDEO	Outputs an image with a radial concentric effect.				
	PATTERN1	Outputs an image that appears like a light shining from behind.	The touched location will have the central coordinates of the effect.	Sets the color.	1 to 10	Sets the balance between the original video and the effect video.
	PATTERN2	Outputs an image that spreads radially.		Sets the opening of the center.		
	PATTERN3	Outputs an image of circles spreading concentrically.		Sets the opening of the center.		
PATTERN4	Outputs an image combining PATTERN 2 and PATTERN 3.	Sets the opening of the center.				

USING THE EFFECT FUNCTION

7. KALEIDO	AUDIO	Outputs the input sound as if it were being made by a robot.	Touch more toward the right to increase the pitch. Touch toward the left to lower the pitch.	–	–	Rotate the dial clockwise to enhance the effect. When dial is rotated fully counterclockwise, only original sound is output.
	VIDEO	Outputs a kaleidoscope-like effect.				
	PATTERN1	Outputs an image circularly dividing the screen from the center of the screen.	When the original image is touched and moved, the screen is divided circularly and output.	Sets the center angle of the image.	1 to 10	Sets the balance between the original video and the effect video.
	PATTERN2	Outputs an image horizontally dividing the screen (vertically stacked).	When the original image is touched and moved, the screen is divided horizontally (vertically stacked).	Sets the height of the image.		
	PATTERN3	Outputs an image vertically dividing the screen (arranged horizontally).	When the original image is touched and moved, the screen is divided vertically (arranged horizontally).	Sets the width of the image.		
PATTERN4	Outputs an image divided horizontally and vertically.	When the image is touched and moved, the screen is divided horizontally and vertically.	Sets the width and height of the image.			
8. LENS	AUDIO	Produces an effect that lowers the pitch of the input sound.	Touch the screen toward the right to enhance the effect. Touch toward the left to reduce the effect.	–	–	Sets the balance between the original sound and the effect sound.
	VIDEO	Outputs image with a lens-like effect.				
	PATTERN1	Outputs image with a lens-like effect.	The lens moves to the location that is touched.	Sets the size of the lens.	1 to 10	Sets the balance between the original video and the effect video.
	PATTERN2	Outputs image with a lens-like effect.	The lens moves to the location that is touched.			
	PATTERN3	Outputs image with a lens-like effect.	The lens moves to the location that is touched, and the image within the lens also moves in accordance with the amount of lens movement.			
PATTERN4	Inverts the luminance components, and outputs the image with a lens-like effect.	The lens moves to the location that is touched.				
9. CUBE	AUDIO	Produces phaser effect. By moving the touched position between left and right, the volume of the effect changes.	Touch the screen toward the right to enhance the effect. Touch toward the left to reduce the effect.	–	–	Rotate the dial clockwise to enhance the effect. When dial is rotated fully counterclockwise, only original sound is output.
	VIDEO	Outputs an image formulated as a cube.				
	PATTERN1	Outputs an image of the cube rotating.	Moves to the touched position.	Sets the size of the object.	1 to 10	Sets the balance between the original video and the effect video.
	PATTERN2	Outputs an image of a bottomless pyramid prism rotating.				
	PATTERN3	Outputs an image of a bottomless pentagon prism rotating.				
PATTERN4	Outputs an image of a bottomless heptagon prism rotating.					

USING THE EFFECT FUNCTION

		Description of the effect	Description of the effect when touched	Parameter 1 (TIME/PARAMETER)		Parameter 2 (LEVEL/DEPTH)
				Description	Description	
10. TWIST	AUDIO	Flanger effect is applied. Move finger on touch panel to right-left to change effect volume.	Touch more toward the right to lengthen the cycle of the flanger effect. Touch toward the left for shorter effect cycle.	–	–	Rotate the dial clockwise to enhance the effect. When dial is rotated fully counterclockwise, only original sound is output.
	VIDEO	Outputs an image with a twisting rotational effect.				
	PATTERN1	Outputs an image in which the screen twists and rotates.	The image rotates when you touch and drag your finger in a circular motion around the center of the screen.	Sets the twisting speed.	1 to 10	Sets the balance between the original video and the effect video. When enlarged more than the center, the rotating speed increases.
	PATTERN2	Outputs an image where the screen is divided and twisted individually.	The image rotates when you touch and drag your finger in a circular motion around the center of the screen.	Set the number of divisions.		Sets the balance between the original video and the effect video. When enlarged more than the center, the rotating speed increases.
	PATTERN3	As in PATTERN2, the screen image is divided, and in proportion to the audio level, the image is stretched and compressed like a graphic equalizer effect.	The block of the touched location will stretch. While touching, the stretching and shrinking correspondent to the audio level will stop.	Set the number of divisions.		Sets the balance between the original video and the effect video. When enlarged more than the center, the shrinking speed decreases, and as MAX is approached, changes to the reverse, stretching operation.
PATTERN4	Outputs an image where the screen is twisted and an afterimage is left.	The image rotates when you touch and drag your finger in a circular motion around the center of the screen.	Sets the twisting speed.		Sets the balance between the original video and the effect video. When enlarged more than the center, the rotating speed increases.	
11. SPOT (*3)	AUDIO	Outputs a sound with the cutoff frequency of the filter changed.	Touch the screen toward the right to enhance the effect. Touch toward the left to reduce the effect.	–	–	Rotate dial clockwise to enhance effect.
	VIDEO	Outputs image with a spotlight effect.				
	PATTERN1	Outputs image with a spotlight of a random size on a random location.	Outputs an image with a spotlight of a fixed size on the touched location.	Sets the interval in which the spotlight is updated.	1 to 10	Sets the balance between the original video and the effect video.
	PATTERN2	Outputs image with a spotlight of a random size on a random location.	Outputs an image with a spotlight of a random size on the touched location.			
	PATTERN3	Outputs an image with a spotlight of a random size and color on a random location.	Outputs an image with a spotlight of a fixed size and random color on the touched location.			
PATTERN4	Outputs an image with a spotlight of a random size and color on a random location.	Outputs an image with a spotlight of a random size and color on the touched location.				

USING THE EFFECT FUNCTION

12. DROP (*3)	AUDIO	Flanger effect is applied. Move finger on touch panel to right-left to change effect volume.	Touch more toward right side to enhance effect. Touch more toward left side to decrease effect.	-	-	Rotate the dial clockwise to enhance the effect. When dial is rotated fully counterclockwise, only original sound is output.
	VIDEO	Outputs an image of a circle with color in motion.				
	PATTERN1	Outputs an image of a circle with dot designs.	The circle moves towards the touched point.	Sets the size of the circle.	1 to 10	Sets the balance between the original video and the effect video.
	PATTERN2	Outputs an image of a circle with border designs.				
	PATTERN3	Outputs an image of a circle with vertically stretched image.				
PATTERN4	Outputs an image of a circle with original image.					

- (*1) When the [**HOLD**] button is set to ON, you can record the track of your finger touching the touch panel for a maximum of 8 seconds.
- (*2) The effect will not become visible unless the video effect performance monitor is touched.
- (*3) When effect is set to ON, random effects are applied.
- (*4) When effect is set to OFF, effect sounds cannot be heard even on monitor.

USING THE EFFECT FUNCTION

TEXT effects

		Description of the effect	Beat button parameters	Parameter 1 (TIME/PARAMETER)		Parameter 2 (LEVEL/DEPTH)
				Description	Description	
1. BLOCK	AUDIO	Dramatically changes the sound tone by moving the frequency of the filter in rhythm to the beat.	For the time of 1 BPM beat, a 1/2 to 32/1 time will be set for the interval in which the cutoff frequency is moved.	Sets the interval for which the cutoff frequency moves.	10 ms to 32 000 ms	Rotate dial clockwise to enhance effect.
	VIDEO	The text line chips away at dot block units and then reconstructs itself at dot block units.	For the time of 1 BPM beat, a 1/2 to 32/1 time is set for which the text disappears at dot block units and then reconstructs itself again.	Sets effect time.		Sets the balance between the original video and the text.
2. ROTATION	AUDIO	One phaser effect cycle is quickly and simply created to the beat.	For the time of 1 BPM beat, a 1/2 to 32/1 time will be set for the interval in which the phaser effect is moved.	Sets the interval in which the phaser effect moves.	10 ms to 32 000 ms	Rotate the dial clockwise to enhance the effect. When dial is rotated fully counterclockwise, only original sound is output.
	VIDEO	The text line is lines up and forms a circle as it rotates.	For the time of 1 BPM beat, a 1/2 to 32/1 time is set for which the text rotates once.	Sets effect time.		Sets the balance between the original video and the text.
3. SLIDE	AUDIO	One Flanger effect cycle is quickly and simply created to the beat.	For the time of 1 BPM beat, a 1/2 to 32/1 time is set for the interval in which the flanger effect is moved.	Sets the interval for which the flanger effect moves.	10 ms to 32 000 ms	Rotate the dial clockwise to enhance the effect. When dial is rotated fully counterclockwise, only original sound is output.
	VIDEO	The text string will glow and stretch out horizontally in a linked manner, and then return to the original string.	For the time of 1 BPM beat, a 1/2 to 32/1 time will be set in which the text begins to change and then returns to its original state again.	Sets effect time.		Sets the balance between the original video and the text.
4. RANDOM	AUDIO	Cuts the sound in rhythm to the beat.	For the time of 1 BPM beat, a 1/8 to 8/1 cut time will be set.	Sets effect time.	10 ms to 16 000 ms	Sets the balance between the original sound and the effect sound.
	VIDEO	Random text lines appear.	For the time of 1 BPM beat, a 1/8 to 8/1 time will be set for appearance of random text lines.	Sets effect time.		Sets the balance between the original video and the text.
5. ZOOM	AUDIO	Outputs audio in which the input sound starts from a high pitch and returns to its normal sound.	For the time of 1 BPM beat, a 1/8 to 8/1 effect time will be set.	Sets effect time.	10 ms to 16 000 ms	Sets the balance between the original sound and the effect sound.
	VIDEO	Beginning from zoom-in on each individual letter, a text string is formed as the letters zoom out to their set positions.	For the time of 1 BPM beat, a 1/8 to 8/1 time is set for which the letters zoom out to their set positions.	Sets effect time.		Sets the balance between the original video and the text.
6. CRUSH	AUDIO	Outputs audio as if the input sound has been crushed.	For the time of 1 BPM beat, a 1/2 to 32/1 time will be set for the interval in which the crush effect is moved.	Sets the interval for which the crush effect moves.	10 ms to 32 000 ms	Rotate the dial clockwise to enhance the effect. When dial is rotated fully counterclockwise, only original sound is output.
	VIDEO	From the first letter of the text string, the letters become stretched from left to right as they appear, and from the first letter of the text line, the letters are stretched from right to left as they disappear.	For the time of 1 BPM beat, a 1/2 to 32/1 time is set for which the text appears as it is stretched, and then disappears as it is stretched.	Sets effect time.		Sets the balance between the original video and the text.

(*1) Video effects are dependant upon image display timing, with the result that an effect may not appear precisely as intended when the set time is very short.

Character

No.	Name	Description of character
1	ORIGINAL	Sets text alone, without reflecting the character.
2	SHADOW	Applies shadow to displayed text. When COLOR is B/W, both will have the same effect.
3	TRANSPARENT	Makes text transparent.
4	OUTSIDE	Applies border to text.
5	HUE	Changes color of text (except when black and white).

USING THE JPEG VIEWER

JPEG files can be loaded and displayed from USB memory devices and SD cards. Up to eight JPEG files can be loaded.

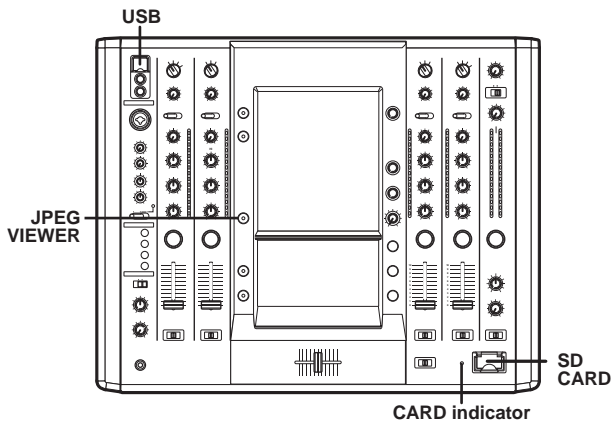

BEFORE USING THE JPEG VIEWER

Insert a USB memory device or SD card into this mixer.

Using a USB memory device

Insert a USB memory device containing JPEG files to the USB connector. Only USB memory devices formatted in FAT32 format can be used.

Using a SD card

Insert a SD card containing JPEG files into the **SD CARD** slot.

- The memory card used must be formatted according to "SD Memory Card Specifications Part2 FILE SYSTEM SPECIFICATION Version1.0" (SD memory cards are formatted in the aforementioned standard upon shipping from their manufacturers). Unformatted memory cards cannot be used.
- Memory cards formatted on computers or digital cameras may not operate properly.
- Multi-media cards (MMC) cannot be used.
- Do not remove the card or turn the power off while the CARD indicator is blinking (doing so may result in damage to the stored data).
- Memory cards are delicate electronic devices. Do not bend them, subject them to strong shocks or impacts. Additionally, do not use or store memory cards in environments likely to create static electricity or electrical noise.
- Memory cards may be damaged when exposed to impacts or static electricity. Handle them with care. It is strongly suggested that you periodically make copies of important data.
- Pioneer will not be held responsible for any loss of data or direct/indirect damages.

JPEG VIEWER SETUP

1 Press the JPEG VIEWER button.

The JPEG play mode screen will appear.

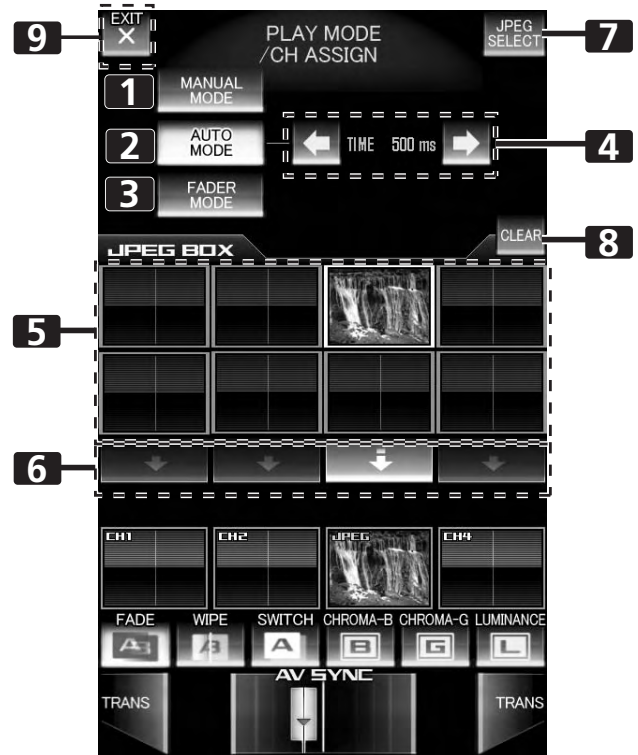

1 [MANUAL MODE] button	Sets the JPEG play mode to MANUAL.
2 [AUTO MODE] button	Sets the JPEG play mode to AUTO.
3 [FADER MODE] button	Sets the JPEG play mode to FADER.
4 [TIME] display/ Change buttons	When in AUTO mode, sets the time for changing the JPEG images.
5 [JPEG BOX]	Selects the JPEG images that are to be assigned to the channels.
6 Channel select buttons	Sets the channel to which JPEG images are to be assigned. Alternatively use to cancel the assigned JPEG.
7 [JPEG SELECT] button	Enables JPEG select mode. If operated when effects are ON, a warning message will appear and the screen will not change to the next menu.
8 [CLEAR] button	Alternates JPEG BOX clear mode ON/OFF.
9 [EXIT] button	Exits JPEG viewer setup.

USING THE JPEG VIEWER

Loading JPEG files to the SVM-1000

Use this function to load JPEG files into the JPEG BOX. When effect is ON, this function is not usable.

- 1 Touch the [JPEG SELECT] button in the JPEG play mode screen.

The JPEG select mode screen will appear.

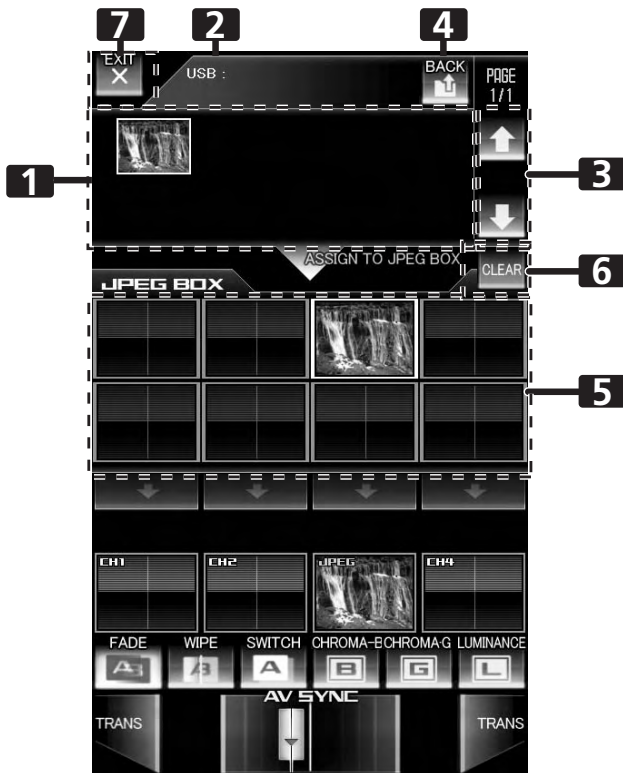

1	Media/folder/file display	Displays media, files, and folders.
2	Address display	Displays the address of the media/folders/files currently being displayed.
3	Page display/ Page change buttons	Advances the page display of the displayed media/folder/file.
4	[BACK] button	Returns to the next higher level of the folder hierarchy.
5	[JPEG BOX]	Selects the JPEG BOX into which the JPEG is to be loaded.
6	[CLEAR] button	Alternates the JPEG BOX clear mode ON/OFF.
7	[EXIT] button	Exits JPEG viewer mode and returns to JPEG play mode.

- 2 Select a JPEG file you wish to download from the media/folder/file display.

The media/folder/file display will start from the media used (USB memory/SD card).

Only JPEG files will be displayed.

Displayable folders and JPEG files are in alphabetical order, with a maximum 64 folders and 192 files per hierarchical level.
- 3 Touch the [JPEG BOX] to download the file.
- 4 Touch the [EXIT] button to end the JPEG viewer mode and return to JPEG play mode (P. 31).
 - When power is turned OFF, JPEG images read into the unit will be deleted.

Using a JPEG file by assigning it to a channel.

The JPEG play mode includes MANUAL MODE, AUTO MODE, and FADER MODE, allowing a wide range of performance styles.

Operating in MANUAL MODE

Assign JPEG image in JPEG BOX as image for designated channel.

- 1 Touch the [MANUAL MODE] button to select MANUAL mode.
- 2 From the JPEG BOX, select the image you wish to assign.

When an image is touched, the border around the image will change to white.
- 3 Select the channel to which you wish to assign the image.

Touch the channel select button for the channel you wish to assign the image to, and the selected image will be displayed on the channel monitor. In this condition, the JPEG image can be treated as the input image for that channel.

 - When the channel select button is ON, touching one of the other images in the JPEG BOX will cause the display to switch instantly to that image.
 - When a channel select button is ON, touching one of the other channel select buttons causes the assigned channel to be changed instantly.
 - A JPEG image can be assigned only to one channel selected with the channel select button.
 - If the channel select button is touched again, the assignment is canceled.

Operating in AUTO MODE

A slide show program can be created in which images in the JPEG BOX change automatically, and the slide show can be assigned to a designated channel.

- 1 Touch the [AUTO MODE] button to select AUTO mode.
- 2 From the JPEG BOX, select the images you wish to use.

Touch the multiple images you wish to use, and their borders will turn to white. Touching an image again will deselect it.
- 3 Select the channel to which you wish to assign the images.

Touch the channel select button for the desired channel and the slide show of selected multiple images will be displayed on the channel monitor. In this condition, the slide show can be treated as the input image for that channel.
- 4 Use the [TIME] change button to adjust the transition time for the slide show.

Operating in FADER MODE

Using the JPEG images in the JPEG BOX, a slide show can be created with transitions between images at chosen intervals. The channel fader for the assigned channel is used to perform the transitions.

- 1 Touch the [FADER MODE] button to select FADER mode.**
- 2 Select the images you wish to use from the JPEG BOX.**
Touch multiple images on the screen and their borders will change to white. Touch again to deselect images.
- 3 Select the channel to which you wish to assign the images.**
Touch the channel select button for the channel to which you wish to assign the images, and the image at the upper left of the group of selected images will be displayed on the channel monitor.
- 4 Operate the fader.**
Each time the channel fader for the assigned channel is raised from the [0] point, the images will change.

Deleting JPEG files downloaded to the JPEG BOX

- 1 Touch the [CLEAR] button.**
The [CLEAR] button will flash.
- 2 Touch the images on the screen that you wish to delete.**
The instant the image is touched, it disappears from the JPEG BOX. While the [CLEAR] button is flashing, you may continue by deleting other images if desired.
 - This process does not affect file data on attached SD cards or USB memory devices.
- 3 Press the [CLEAR] button once again to leave this mode.**
 - Usable JPEG files have a maximum size of 7 MB or about 12 MP.
 - If the original JPEG file does not fit within 640 x 480 pixels, the file will be automatically resized to 640 x 480 pixels when downloaded to the SVM-1000.

THE VIDEO EQUALIZER FUNCTION

Rotating the channel equalizer dial normally applies equalizer effects on audio only. However, by using the VIDEO EQ function, effects can be applied to video as well.

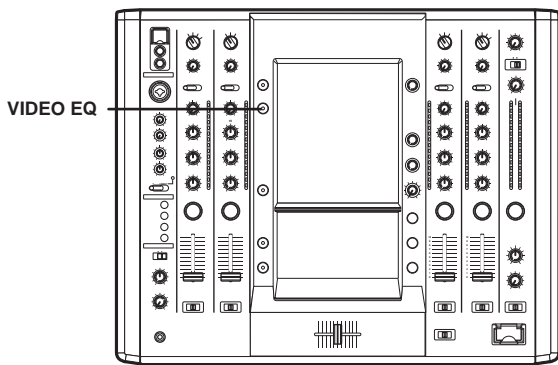

SET UP THE VIDEO EQ

1 Hold down the VIDEO EQ button.

This initiates the equalizer setup mode.

2 Touch each applicable button.

Touch each applicable button on the screen to operate the VIDEO EQ setup.

- Whenever power is first turned on, default settings are as follows:
 HI: CONTRAST
 MID: HUE
 LOW: SATURATION

Whenever power is turned OFF, the unit returns to the above status.

- Identical parameter values cannot be allocated to HI, MID and LOW.

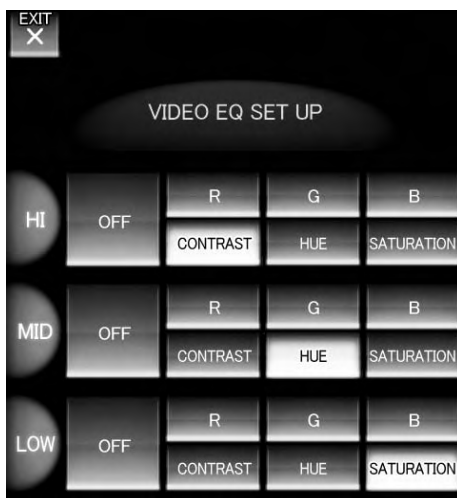

VIDEO EQ SET UP

Use to make the video effects change simultaneously when using the equalizer.

OFF: Disables the VIDEO EQ.

R: Used when assigning parameters that change the red elements of the VIDEO EQ.

Used when assigning parameters.

G: Used when assigning parameters that change the green elements of the VIDEO EQ.

Used when assigning parameters.

B: Used when assigning parameters that change the blue elements of the VIDEO EQ.

CONTRAST: Used when assigning parameters that change the contrast of the VIDEO EQ.

HUE: Used when assigning parameters that change the hue of the VIDEO EQ.

SATURATION: Used when assigning parameters that change the saturation of the VIDEO EQ.

3 Touch [EXIT].

This ends the equalizer setup mode.

TURNING THE EQUALIZER ON/OFF

1 Press the VIDEO EQ button.

The VIDEO EQ settings will alternate between enabled/disabled each time the button is pressed.

FADER START FUNCTION

By connecting the optional Pioneer DJ/VJ DVD Player or DJ CD Player control cable, the channel fader and cross fader can be used to start DVD/CD playback.

When the mixer's channel fader lever or cross fader lever are moved, the DVD/CD player is released from the pause mode and automatically –and instantly – begins playback of the selected track. Also, when the fader lever is returned to its original position, the DVD/CD player returns to its cue point (back cue), thus allowing "sampler" type play.

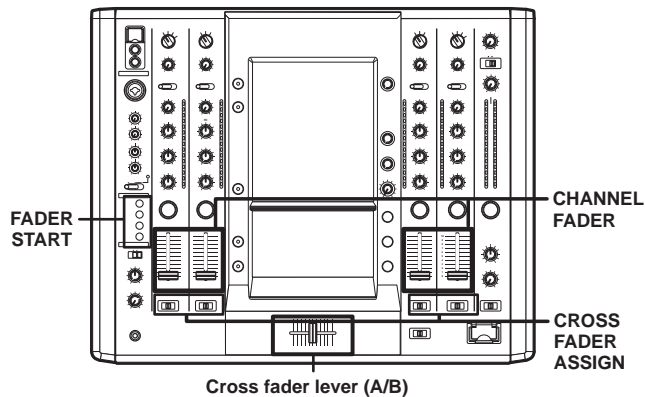

CROSS FADER START PLAY AND BACK CUE PLAY

When the DVD/CD player assigned to cross fader channel A is set to standby at a cue point, moving the cross fader lever from the right (B) side toward the left (A) side automatically starts play on the channel A DVD/CD player.

When the cross fader lever reaches the left (A) side, the DVD/CD player assigned to channel B goes to back cue (returns to cue point). Also, when the DVD/CD player assigned to channel B is set to standby at a cue point, moving the cross fader lever from the left (A) side to the right (B) side automatically starts playback on the channel B DVD/CD player. When the cross fader lever reaches the right (B) side, the DVD/CD player assigned to channel A goes to back cue (returns to cue point).

Using the Channel Fader to Start Playback

- 1 **Press the FADER START button for the channel (1 to 4) connected to the DVD/CD player you wish to control.**
 - The button for the selected channel lights.
- 2 **Set the channel fader lever to [0].**
- 3 **Set the DVD/CD player to the desired cue point, and engage cue point standby.**
 - If a cue point has already been set, it is not necessary to set the DVD/CD player to standby at the cue point.
- 4 **At the instant you wish to start playback, move the channel fader lever.**
 - DVD/CD player begins playback.
 - After playback has begun, if the channel fader lever is returned to the [0] position, the DVD/CD player returns to the cue point and re-enters standby mode (back cue).
 - Playback control is possible with the channel fader only with the **CROSS FADER ASSIGN** switch is set to [THRU].

Using the Cross Fader to Start Playback

- 1 **Press the FADER START button for the channel (1 to 4) connected to the DVD/CD player you wish to control.**
 - The button for the selected channel lights.
- 2 **Set the CROSS FADER ASSIGN switch for the selected channel to [A] or [B].**
 - Select [A] to assign to cross fader channel A (left side).
 - Select [B] to assign to cross fader channel B (right side).
- 3 **Move the cross fader lever to the full opposite side away from the DVD/CD player you wish to start.**
- 4 **Set the DVD/CD player to the desired cue point, and engage cue point standby.**
 - If a cue point has already been set, it is not necessary to set the DVD/CD player to standby at the cue point.
- 5 **At the instant you wish to start playback, move the cross fader lever (A/B).**
 - DVD/CD player begins playback.
 - After playback has begun, if the cross fader lever is moved fully to the opposite side, the DVD/CD player assigned to the opposite side channel will return to the cue point and enter standby mode (back cue).

PERFORM UTILITY SETUP

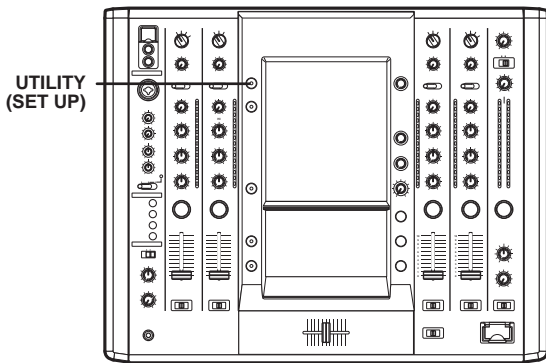

When power is turned OFF, all utility setup values other than MIDI CHANNEL and KEYBOARD LANGUAGE revert to their default values.

MIDI SETTINGS

MIDI is an acronym for “Musical Instrument Digital Interface” and refers to a protocol developed for the exchange of data between electronic instruments and computers.

A MIDI cable is used to connect components equipped with MIDI connectors to enable the transmission of data.

The SVM-1000 will use the MIDI function to send operational information for hardware and BPM (timing clock).

SYNCHRONIZING AUDIO SIGNALS TO EXTERNAL SEQUENCER, OR USING SVM-1000 INFORMATION TO OPERATE AN EXTERNAL SEQUENCER

1 Connect the DIN connector to a MIDI sequencer, and the USB port to your computer.

This unit is equipped with both DIN type and USB type output connectors.

- Supported operating systems include Windows Vista, Windows XP or Mac OSX.
- For details regarding computer setup, refer to the instruction manual for your computer and operating system. For application setup instructions, refer to the instruction manual for the application involved.
- Set the MIDI sequencer’s synch mode to “Slave”.
- MIDI sequencers that do not support MIDI timing clock cannot be synchronized.
- Synch may not be achieved if the track’s BPM cannot be detected and measured stably.
- BPM values set with the TAP mode can also be used to output the timing clock.

2 Set the MIDI OUT to ON in the MIDI setup.

- The output range of the MIDI timing clock is 40 BPM to 250 BPM.

Note:

The BPM may not be measured correctly with some tracks.

Synchronize the computer application to the audio signals, or operate the computer application using the operation data for the SVM-1000.

1 Connect the USB MIDI output connector of the SVM-1000 to your computer using the USB cable.

- Perform the MIDI settings for the application program. For further information, refer to the instruction manual for application program.
- Supported operating systems include Windows XP and Mac OSX.

Set up MIDI

- 1 Hold the UTILITY (SET UP) button depressed.**
The MIDI setup mode will be initiated.
- 2 Touch [MIDI].**
The MIDI setup screen will be displayed.
- 3 Touch each applicable button.**
Touch each applicable button on the screen to operate the MIDI setup.
- 4 Touch [EXIT].**
This will end the MIDI setup mode.

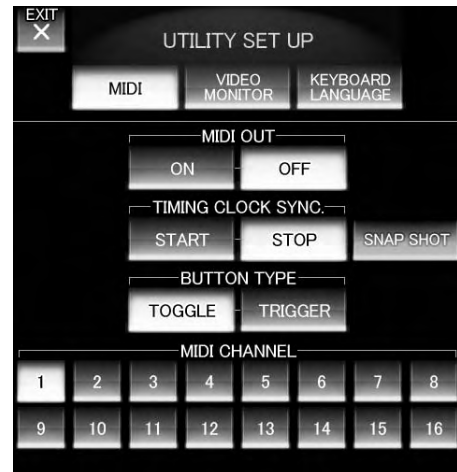

MIDI OUT	Alternates MIDI signal output ON/OFF.
TIMING CLOCK SYNC.	Switches the MIDI timing clock synchronization between start and stop.
SNAP SHOT	Current MIDI information regarding dials and buttons is transmitted.
BUTTON TYPE	Select the method in which the MIDI signal is transmitted. Options include toggle type and trigger type. In the trigger type, any MIDI codes set to OFF will not be sent, and MIDI codes set to ON will be sent each time the button is pressed.
MIDI CHANNEL	Changes the MIDI channel. Configures MIDI channels (1-16) and stores them in memory.

PERFORM UTILITY SETUP

MIDI CODE LIST

Category	Switch Name	Switch Type	MIDI Message						Comments
			MSB			LSB			
CH1	VIDEO TRIM	VR	Bn	31	dd				0 to 127
	AUDIO TRIM	VR	Bn	01	dd				0 to 127
	HI	VR	Bn	02	dd				0 to 127
	MID	VR	Bn	03	dd				0 to 127
	LOW	VR	Bn	04	dd				0 to 127
	CUE	BTN	Bn	46	dd				OFF=0, ON=127
	FADER	VR	Bn	11	dd				0 to 127
	CF ASSIGN	SW	Bn	41	dd				0, 64, 127
CH2	VIDEO TRIM	VR	Bn	32	dd				0 to 127
	AUDIO TRIM	VR	Bn	06	dd				0 to 127
	HI	VR	Bn	07	dd				0 to 127
	MID	VR	Bn	08	dd				0 to 127
	LOW	VR	Bn	09	dd				0 to 127
	CUE	BTN	Bn	47	dd				OFF=0, ON=127
	FADER	VR	Bn	12	dd				0 to 127
	CF ASSIGN	SW	Bn	42	dd				0, 64, 127
CH3	VIDEO TRIM	VR	Bn	33	dd				0 to 127
	AUDIO TRIM	VR	Bn	0C	dd				0 to 127
	HI	VR	Bn	0E	dd				0 to 127
	MID	VR	Bn	0F	dd				0 to 127
	LOW	VR	Bn	15	dd				0 to 127
	CUE	BTN	Bn	48	dd				OFF=0, ON=127
	FADER	VR	Bn	13	dd				0 to 127
	CF ASSIGN	SW	Bn	43	dd				0, 64, 127
CH4	VIDEO TRIM	VR	Bn	34	dd				0 to 127
	AUDIO TRIM	VR	Bn	50	dd				0 to 127
	HI	VR	Bn	51	dd				0 to 127
	MID	VR	Bn	5C	dd				0 to 127
	LOW	VR	Bn	52	dd				0 to 127
	CUE	BTN	Bn	49	dd				OFF=0, ON=127
	FADER	VR	Bn	14	dd				0 to 127
	CF ASSIGN	SW	Bn	44	dd				0, 64, 127
CROSS FADER	CROSS FADER	VR	Bn	0B	dd				0 to 127
FADER CURVE	CH CURVE	SW	Bn	5E	dd				0, 64, 127
	CROSS CURVE	SW	Bn	5F	dd				0, 64, 127
MASTER	VIDEO MASTER LEVEL	VR	Bn	38	dd				0 to 127
	AUDIO MASTER LEVEL	VR	Bn	18	dd				0 to 127
	BALANCE	VR	Bn	17	dd				0 to 127
	CUE	BTN	Bn	4A	dd				OFF=0, ON=127

PERFORM UTILITY SETUP

Category	Switch Name	Switch Type	MIDI Message						Comments
			MSB			LSB			
BOOTH	MONITOR	VR	Bn	19	dd				0 to 127
EFFECT	AUTO/TAP	BTN	Bn	45	dd				OFF=0, ON=127
	TAP	BTN	Bn	4E	dd				OFF=0, ON=127
	EFFECT CUE	BTN	Bn	4B	dd				OFF=0, ON=127
	CH SELECT	SW							For CHANNEL SELECT and VIDEO FX PATTERN, the logical sum of both values is sent.
	VIDEO FX PATTERN	SW	Cn	pc					
	TIME/PARAMETER	SW	Bn	0D	MSB	Bn	2D	LSB	PARAMETER 1 value; FLANGER, PHASER, FILTER, CHORUS changed to 1/2 value; minus values of ROBOT are converted to positive.
	LEVEL/DEPTH	VR	Bn	5B	dd				0 to 127
EFFECT ON/OFF	BTN	Bn	40	dd				OFF=0, ON=127	
MIC	HI	VR	Bn	1E	dd				0 to 127
	LOW	VR	Bn	1F	dd				0 to 127
(FADER START)	FADER START CH1	BTN	Bn	58	dd				OFF=0, ON=127
	FADER START CH2	BTN	Bn	59	dd				OFF=0, ON=127
	FADER START CH3	BTN	Bn	5A	dd				OFF=0, ON=127
	FADER START CH4	BTN	Bn	5D	dd				OFF=0, ON=127
(HEAD PHONES)	MIXING	VR	Bn	1B	dd				0 to 127
	LEVEL	VR	Bn	1A	dd				0 to 127
TIMING CLOCK	Timing Clock		FB						
MIDI	START	BTN	FA						
	STOP	BTN	FC						

* The MIDI SNAP SHOT outputs all MIDI commands except MIDI START/STOP.

CENTER PANEL AREA

Category	Switch Name	Switch Type	MIDI Message						Comments
			MSB			LSB			
	UTILITY	BTN	—	—	—	—	—	—	
	VIDEO EQ	BTN	—	—	—	—	—	—	
	JPEG VIEWER	BTN	—	—	—	—	—	—	
	VIDEO SOLO MODE	BTN	—	—	—	—	—	—	
	FADER AV SYNC	BTN	—	—	—	—	—	—	

PERFORM UTILITY SETUP

GUI BUTTONS

Category	Switch Name	Switch Type	MIDI Message						Comments
			MSB			LSB			
EFFECT CATEGORY	BEAT EFFECT	BTN	—	—	—				Changing the category inevitably causes an effect program change.
	TOUCH EFFECT	BTN	—	—	—				
	TEXT EFFECT	BTN	—	—	—				
	A	BTN	—	—	—				
	AV	BTN	—	—	—				
	V	BTN	—	—	—				
BEAT EFFECT	DELAY	BTN	9n	41	dd				OFF=0, ON=127
	ECHO	BTN	9n	42	dd				OFF=0, ON=127
	PAN	BTN	9n	43	dd				OFF=0, ON=127
	TRANS	BTN	9n	44	dd				OFF=0, ON=127
	FILTER	BTN	9n	45	dd				OFF=0, ON=127
	FLANGER	BTN	9n	46	dd				OFF=0, ON=127
	PHASER	BTN	9n	47	dd				OFF=0, ON=127
	REVERB	BTN	9n	48	dd				OFF=0, ON=127
	ROBOT	BTN	9n	49	dd				OFF=0, ON=127
	CHORUS	BTN	9n	4A	dd				OFF=0, ON=127
	ROLL	BTN	9n	4B	dd				OFF=0, ON=127
	REV ROLL	BTN	9n	4C	dd				OFF=0, ON=127
	Beat BUTTON 1	BTN	Bn	0D	MSB	Bn	2D	LSB	The motion of the TIME/ PARAMETER dial can be replicated by the button
	Beat BUTTON 2	BTN							
	Beat BUTTON 3	BTN							
	Beat BUTTON 4	BTN							
	Beat BUTTON 5	BTN							
	Beat BUTTON 6	BTN							
Beat BUTTON 7	BTN								
VISUALIZER	BTN	—	—	—					
BPM AUTO/TAP	BTN	—	—	—					
TOUCH EFFECT	RIPPLE	BTN	9n	51	dd				OFF=0, ON=127
	LENS	BTN	9n	52	dd				OFF=0, ON=127
	SPOT	BTN	9n	53	dd				OFF=0, ON=127
	RADIATION	BTN	9n	54	dd				OFF=0, ON=127
	CUBE	BTN	9n	55	dd				OFF=0, ON=127
	BLOCK	BTN	9n	56	dd				OFF=0, ON=127
	KALEIDO	BTN	9n	57	dd				OFF=0, ON=127
	TWIST	BTN	9n	58	dd				OFF=0, ON=127
	ZOOM	BTN	9n	59	dd				OFF=0, ON=127
	DROP	BTN	9n	5A	dd				OFF=0, ON=127
	BLUR	BTN	9n	5B	dd				OFF=0, ON=127
	DISTORTION	BTN	9n	5C	dd				OFF=0, ON=127
	HOLD	BTN	9n	50	dd				OFF=0, ON=127
	TOUCH FX MONITOR X	VR	Bn	1C	dd				0 to 127
	TOUCH FX MONITOR Y	VR	Bn	3C	dd				0 to 127
	VISUALIZER	BTN	—	—	—				

PERFORM UTILITY SETUP

Category	Switch Name	Switch Type	MIDI Message						Comments
			MSB			LSB			
TEXT EFFECT	RANDOM	BTN	9n	60	dd				OFF=0, ON=127
	ZOOM	BTN	9n	61	dd				OFF=0, ON=127
	BLOCK	BTN	9n	62	dd				OFF=0, ON=127
	ROTATION	BTN	9n	63	dd				OFF=0, ON=127
	CRUSH	BTN	9n	64	dd				OFF=0, ON=127
	SLIDE	BTN	9n	65	dd				OFF=0, ON=127
	BANK1	BTN	—	—	—				
	BANK2	BTN	—	—	—				
	BANK3	BTN	—	—	—				
	BANK4	BTN	—	—	—				
	BANK5	BTN	—	—	—				
	BANK6	BTN	—	—	—				
	TEXT EDIT	BTN	—	—	—				
	Beat BUTTON 1	BTN	Bn	0D	MSB	Bn	2D	LSB	The motion of the TIME/ PARAMETER dial can be replicated by the button
	Beat BUTTON 2	BTN							
	Beat BUTTON 3	BTN							
Beat BUTTON 4	BTN								
Beat BUTTON 5	BTN								
Beat BUTTON 6	BTN								
Beat BUTTON 7	BTN								
BPM AUTO/TAP	BTN	—	—	—					
CROSS FADER	CH1 MONITOR		—	—	—				
	CH2 MONITOR		—	—	—				
	CH3 MONITOR		—	—	—				
	CH4 MONITOR		—	—	—				
	FADE	BTN	9n	70	dd				OFF=0, ON=127
	WIPE	BTN	9n	71	dd				OFF=0, ON=127
	SWITCH	BTN	9n	72	dd				OFF=0, ON=127
	CHROMA-B	BTN	9n	73	dd				OFF=0, ON=127
	CHROMA-G	BTN	9n	74	dd				OFF=0, ON=127
	LUMINANCE	BTN	9n	75	dd				OFF=0, ON=127
	TRANS-A	BTN	Bn	4C	dd				OFF=0, ON=127
	TRANS-B	BTN	Bn	4D	dd				OFF=0, ON=127
	CROSS FADER	VR	9n	7A	dd				0 to 127

PERFORM UTILITY SETUP

PERFORM VIDEO MONITOR SETUP

Set the video monitor output method.

Video monitor setup

- 1 **Hold the UTILITY (SET UP) button depressed.**
This will initiate the utility setup mode.
- 2 **Touch [VIDEO MONITOR].**
The video monitor setup screen will be displayed.
 - When turning the power ON, [MASTER] will be selected.
- 3 **Touch each applicable button.**
Touch each applicable button on the screen to operate the video monitor setup.
- 4 **Touch [EXIT].**
This will end the utility setup mode.



MASTER	The master output is sent directly to the monitor output.
MIRROR OF MASTER	The master output is flipped horizontally and sent to the monitor output.
MASTER & CHANNEL	Both master output and channel output are sent to the monitor output.
CHANNEL	All channels' outputs are sent to the monitor output.

KEYBOARD LANGUAGE SETUP

By connecting a keyboard to the USB connector, text can be entered through the keyboard during text edit mode (P. 22). Follow these steps to set up the connected keyboard type.

Keyboard language setup

- 1 **Hold the UTILITY (SET UP) button depressed.**
This initiates the utility setup mode.
- 2 **Touch [KEYBOARD LANGUAGE].**
The keyboard language setup screen will be displayed.
- 3 **Touch each applicable button.**
Touch each applicable button on the screen to perform keyboard language setup.
- 4 **Touch [EXIT].**
This will end the utility setup mode.



* With keyboards other than those listed, the characters actually appearing may be different from those pressed.

HARDWARE SETUP

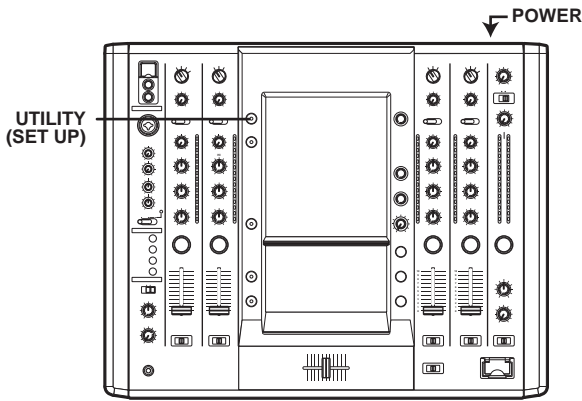

The hardware setup values are preserved even when power is turned OFF.

Initiate hardware setup

- 1 Turn the **POWER** switch on while pressing the **UTILITY (SET UP)** button.
 - Continue depressing the **UTILITY (SET UP)** button while the logo mark [**PIONEER PRO DJ**] is displayed.
 - The hardware setup screen will be displayed.

MIC SETTING

- 1 Touch [**MIC**].
The MIC setting screen will be displayed.
- 2 Choose settings by touching [**←**] or [**→**].



OUTPUT TO BOOTH MONITOR	Set whether or not to output the audio from the MIC to the booth monitor.
TALK OVER THRESHOLD LEVEL	Adjust the sensitivity of talk over.
TALK OVER LEVEL	Adjust the level of talk over.

- 3 Touch [**SAVE**] to save the settings.
The settings will not be implemented unless [**SAVE**] is touched.

SYSTEM SETTINGS

- 1 Touch [**SYSTEM**].
The **SYSTEM** setting screen will be displayed.
- 2 Choose settings by touching [**←**] or [**→**].



VIDEO SYSTEM	Selects the video signal format. When used in North America, it should be set to NTSC (7.5 IRE).
DIGITAL OUT MAX LEVEL	Selects the maximum level of the digital out circuit.

- 3 Touch [**SAVE**] to save the settings.
The settings will not be implemented unless [**SAVE**] is touched.

MASTER OUT SETTINGS

- 1 Touch [MASTER OUT].
The MASTER OUT setting screen will be displayed.
- 2 Choose settings by touching [←] or [→].

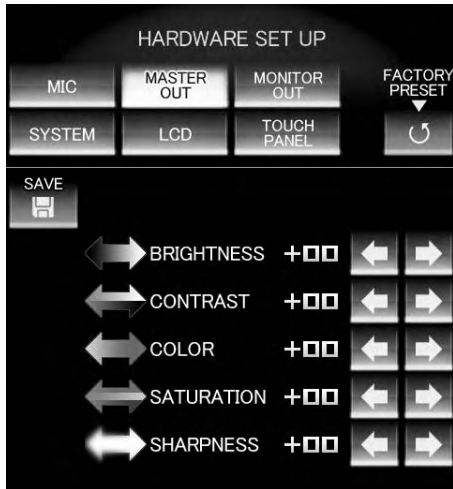

BRIGHTNESS	Adjusts the brightness of the master output monitor.
CONTRAST	Adjusts the contrast of the master output monitor.
COLOR	Adjusts the color tone of the master output monitor. <ul style="list-style-type: none"> • Cannot be adjusted when the PAL video system is used. • Component outputs cannot be adjusted.
SATURATION	Adjusts the saturation of the master output monitor.
SHARPNESS	Adjusts the sharpness of the master output monitor.

- 3 Touch [SAVE] to save the settings.
The settings will not be implemented unless [SAVE] is touched.

MONITOR OUT SETTINGS

- 1 Touch [MONITOR OUT].
The MONITOR OUT setting screen will be displayed.
- 2 Choose settings by touching [←] or [→].

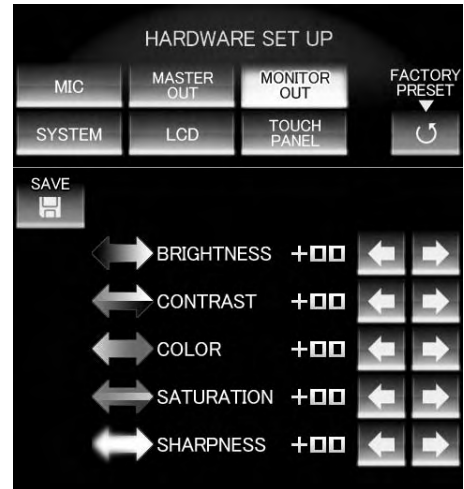

BRIGHTNESS	Adjusts the brightness of the monitor output.
CONTRAST	Adjusts the contrast of the monitor output.
COLOR	Adjusts the color tone of the monitor output.
SATURATION	Adjusts the saturation of the monitor output.
SHARPNESS	Adjusts the sharpness of the monitor output.

- 3 Touch [SAVE] to save the settings.
The settings will not be implemented unless [SAVE] is touched.

LCD SETTINGS

- 1 Touch [LCD].
The LCD setting screen will be displayed.
- 2 Choose settings by touching [←] or [→].

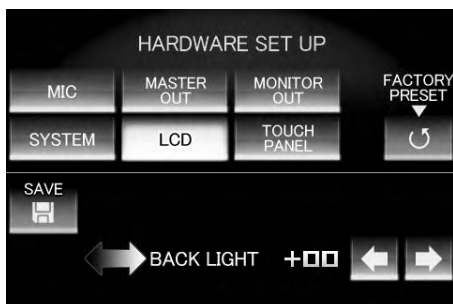

BACK LIGHT	Adjust the backlight of the LCD.
-------------------	----------------------------------

- 3 Touch [SAVE] to save the settings.
The settings will not be implemented unless [SAVE] is touched.

TOUCH PANEL SETTINGS

- 1 Touch **[TOUCH PANEL]**.
The touch panel setting screen will be displayed.
- 2 Touch either **[TOP PANEL]** or **[BOTTOM PANEL]** to select settings.

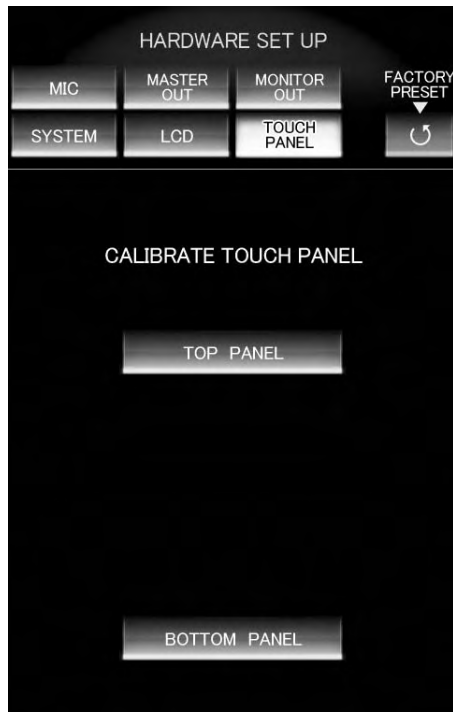

TOP PANEL	Calibrates the TOP panel.
BOTTOM PANEL	Calibrates the BOTTOM panel.

- 3 Touch the **[+]** mark with a pointed object such as a pen.
Use a stylus pen or other type pen without a sharp tip.

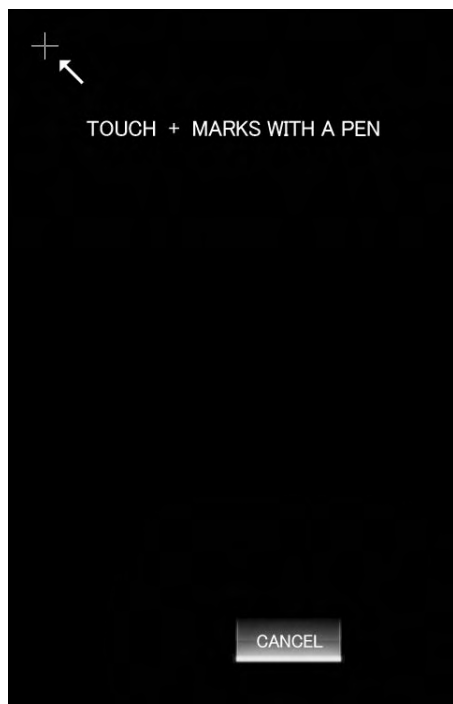

- 4 Touch all **[+]** marks and make sure the color of the **[+]** marks are inverted.

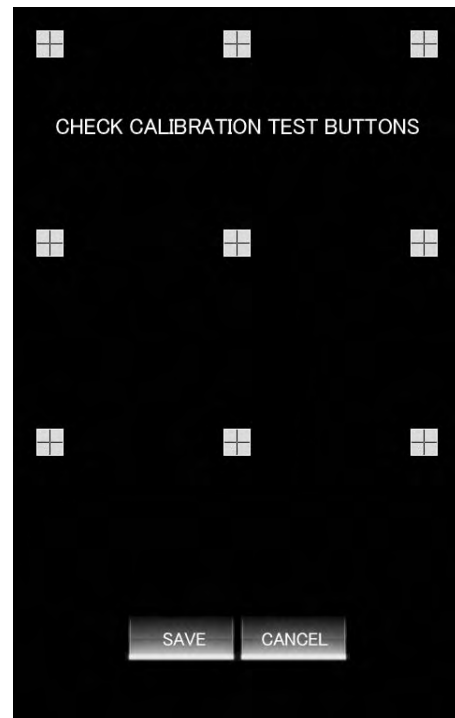

- 5 Touch **[SAVE]** to save the settings.
The settings will not be implemented unless **[SAVE]** is touched.

RETURNING TO DEFAULT SETTINGS

- 1 Touch **[FACTORY PRESET]**.
The factory preset screen will be displayed.
- 2 Touch to choose either **[YES]** or **[NO]**.

ENDING HARDWARE SET UP

- 1 Set the **[POWER]** switch to OFF.

TROUBLESHOOTING

Incorrect operations are often mistaken for trouble and malfunctions. If you think there is something wrong with this component, check the points below. Sometimes the trouble may originate from another component. Thus, also check the other electrical appliances also in use.

If the trouble cannot be rectified even after checking the following items, contact your dealer or nearest PIONEER service center.

Symptom	Possible Cause	Remedy
No power.	<ul style="list-style-type: none"> The power cord has not been connected. 	<ul style="list-style-type: none"> Connect to power outlet.
No sound, or sound volume is too low.	<ul style="list-style-type: none"> AUDIO INPUT switch is set incorrectly. Connection cables are not connected properly, or are disconnected. Connectors or plugs are dirty. The rear panel MASTER ATT. switch is set to -6 dB, etc. 	<ul style="list-style-type: none"> Set AUDIO INPUT switch to select the currently playing component. Connect correctly. Clean away any dirt before connecting. Adjust rear panel MASTER ATT. switch.
No microphone sound from BOOTH output.	<ul style="list-style-type: none"> The OUTPUT TO BOOTH MONITOR (P. 42) is set to OFF. 	<ul style="list-style-type: none"> Set OUTPUT TO BOOTH MONITOR (P. 42) to ON.
No digital output.	<ul style="list-style-type: none"> The digital output sampling frequency (fs) does not match the specifications of the connected component. 	<ul style="list-style-type: none"> Set rear panel sampling frequency selector to match the specifications of the connected component.
Sound is distorted.	<ul style="list-style-type: none"> Audio master output level is too high. Input level is too high. 	<ul style="list-style-type: none"> Adjust AUDIO MASTER LEVEL dial or the rear panel MASTER ATT. switch. Adjust the AUDIO TRIM dial so that the input level approaches 0 dB on the channel level indicator.
Cross fader doesn't work.	<ul style="list-style-type: none"> CROSS FADER ASSIGN switch setting ([A], [THRU], [B]) is incorrect. 	<ul style="list-style-type: none"> Correctly set the CROSS FADER ASSIGN switch for the desired channel.
Can't perform fader start with DVD/CD player.	<ul style="list-style-type: none"> The FADER START button is set to OFF. Rear panel CONTROL connector is not connected to DVD/CD player. Only the rear panel CONTROL connector is connected to the DVD/CD player. 	<ul style="list-style-type: none"> Set the FADER START button to ON. Use a control cable to connect the CONTROL connectors of mixer and DVD/CD player. Connect both the CONTROL connectors and analog input connectors.
Effects don't work.	<ul style="list-style-type: none"> Effect channel selector (CH SELECT) setting is incorrect. Effect parameter 2 dial (LEVEL/DEPTH) is set to [MIN]. 	<ul style="list-style-type: none"> Correctly select the channel on which you wish to apply effects. Adjust the effect parameter 2 dial (LEVEL/DEPTH).
BPM can't be measured. Measured BPM value is incorrect.	<ul style="list-style-type: none"> Input level is too high, or too low. BPM may not be correctly measurable with some tracks. 	<ul style="list-style-type: none"> Adjust the AUDIO TRIM dial so that the input level approaches 0 dB in the channel level indicator. Adjust other channels as well so that the input levels approach 0 dB in the channel level indicator. Strike the TAP button to set BPM manually.
The measured BPM value is different from the value published with the DVD/CD.	<ul style="list-style-type: none"> Some differences may occur due to differences in BPM detection methods. 	<ul style="list-style-type: none"> No remedy is necessary.
MIDI sequencer can't be synchronized.	<ul style="list-style-type: none"> MIDI sequencer's synch mode is not set to "slave". MIDI sequencer is not supported type. 	<ul style="list-style-type: none"> Set MIDI sequencer's sync mode to "slave". MIDI sequencers that do not support MIDI timing clock cannot be synchronized.

TROUBLESHOOTING

Symptom	Possible Cause	Remedy
No video image, or image is disrupted.	<ul style="list-style-type: none"> • VIDEO INPUT switch is set incorrectly. • Connection cables are not connected properly, or are disconnected. • Connectors or plugs are dirty. • Trim controls are set improperly. • Signal format of the input video source does not match the system setting selected during hardware setup. • The TV monitor's video signal format does not match the system setting selected during hardware setup. • The TV monitor's input selector is not set to the input type actually connected to the unit. • The TV monitor's component setting is set to something besides 525i (interlaced). 	<ul style="list-style-type: none"> • Set the VIDEO INPUT switch to select the currently playing component. • Connect correctly. • Clean away any dirt before connecting. • Adjust trim properly. • Select the hardware setup's system settings to match the format of the video signal for the input/output video components. • Set the TV monitor's input selector to the type of input connected to this unit. • Set the TV monitor's component setting to 525i interlaced).
The character pressed on the keyboard is not entered.	<ul style="list-style-type: none"> • The keyboard connected to the USB connector does not match the setting selected during this unit's keyboard language setup. 	<ul style="list-style-type: none"> • Set the keyboard language setup to match the type of keyboard connected to the USB connector.
No response when touch panel is touched.	<ul style="list-style-type: none"> • Touch panel's calibration is incorrect. 	<ul style="list-style-type: none"> • Set calibration properly in hardware setup's touch panel setting.

Static electricity or other external interference may cause the unit to malfunction. To restore normal operation, turn the power off and then on again.

ABOUT THE LCD SCREEN

- Some monitors may display so-called "hot pixels" or "dead pixels" (constantly bright pixels or pixels that are permanently off). This is a phenomenon characteristic of such displays and is not considered a malfunction.
- When used in cold regions, the screen may appear dark for a while after the power is first turned on. As the unit warms up with time, the screen will return to normal brightness.
- Avoid exposing the monitor to direct sunlight, since reflected light may make the image difficult to view.

ABOUT MINIATURE FLUORESCENT TUBE TECHNOLOGY

The LCD screen is illuminated by internal miniature fluorescent tube technology.

- Fluorescent tubes are rated for approximately 10 000 hours of use (lifetime may be shorter when the unit is used in cold regions).
- When a fluorescent tube reaches the end of its lifetime, the screen will become darker, making it difficult or impossible to see displayed images. In this event, consult your dealer or service center for repairs.

SPECIFICATIONS

1 General

Power source	AC 120 V, 60 Hz
Power consumption	58 W
Operating temperature	+5 °C to +35 °C (+41 °F to +95 °F)
Operating humidity	.5 % to 85 % (without condensation)
Weight	12.7 kg (28.0 lb)
Maximum dimensions	
	500 mm (W) x 202.4 mm (H) x 420.6 mm (D)
	19.69 in (W) x 7.97 in (H) x 16.56 in (D)

2 Audio section

Sampling rate	96 kHz
A/D, D/A converter	24 bits
Frequency response	
DVD/LINE	20 Hz to 20 kHz
MIC	20 Hz to 20 kHz
PHONO	20 Hz to 20 kHz (RIAA)
S/N ratio (at rated output)	
DVD/LINE	105 dB
PHONO	96 dB
MIC	89 dB
Distortion (LINE-MASTER 1)	0.005 %
Standard input level/Input impedance	
PHONO	-52 dBu/47 k Ω
MIC 1	-52 dBu/9 k Ω
DVD/LINE	-12 dBu/22 k Ω
Standard output level/Load impedance/Output impedance	
MASTER 1	+8 dBu/10 k Ω /10 Ω or less
MASTER 2	+2 dBu/10 k Ω /1 k Ω or less
REC OUT	-8 dBu/10 k Ω /1 k Ω or less
BOOTH MONITOR	+8 dBu/600 Ω /600 Ω or less
PHONES	+7.5 dBu/32 Ω /22 Ω or less
Rated output level/Load impedance	
MASTER 1	+26 dBu/10 k Ω
MASTER 2	+20 dBu/10 k Ω
Crosstalk (DVD/LINE)	89 dB
Channel equalizer response	
HI	-26 dB to +6 dB (13 kHz)
MID	-26 dB to +6 dB (1 kHz)
LOW	-26 dB to +6 dB (70 Hz)
Microphone equalizer response	
HI	-12 dB to +12 dB (10 kHz)
LOW	-12 dB to +12 dB (100 Hz)

3 Video Section

Input signal	NTSC/PAL (selectable)
Sampling rate	
	13.5 MHz, 8 bit, ITU-R BT.656, YCrCb 4:2:2
Input connector (sensitivity/impedance)	
Composite	1 Vp-p/75 Ω
S (Brightness)	1 Vp-p/75 Ω
S (Color)	0.286 Vp-p/75 Ω
Video output connector (Level/Impedance)	
Composite	1 Vp-p/75 Ω
S (Brightness)	1 Vp-p/75 Ω
S (Color)	0.286 Vp-p/75 Ω
Component Y	1 Vp-p/75 Ω
Component Cb/Cr	0.7 Vp-p/75 Ω

4 Input/output connector systems

Audio section

PHONO input connectors	
RCA pin jacks	2
DVD/LINE input connectors	
RCA pin jacks	2
DVD input connectors	
RCA pin jacks	2
LINE input connectors	
RCA pin jacks	2
MIC input connectors	
XLR connector/Phone jack (Ø 6.3 mm)	1
Phone jack (Ø 6.3 mm)	1
DIGITAL coaxial input connectors	
RCA pin jacks	2
MASTER output connectors	
XLR connectors	1
RCA pin jacks	1
BOOTH output connectors	
Phone jack (Ø 6.3 mm)	1
REC output connectors	
RCA pin jacks	1
DIGITAL coaxial output connector	
RCA pin jack	1
PHONES output connector	
Stereo phone jack (Ø 6.3 mm)	1

Video Section

DVD input connectors	
Composite input, RCA pin jacks	4
VIDEO input connectors	
Composite input, RCA pin jacks	4
VIDEO EX input connectors	
Composite input, RCA pin jacks	2
S-VIDEO input connectors	
S-Video input, S-connectors	4
MASTER output connectors	
Component output, BNC connector	1
Composite output, BNC connector	1
RCA pin jack	1
S-Video output, S-connector	1
MONITOR output connectors	
Composite output, RCA pin jack	1
S-Video output, S-connector	1

OTHER

MIDI OUT connector	
5P-DIN	1
USB	1
CONTROL connector	
Mini phone jacks (Ø 3.5 mm)	4

5 Accessories

Power cord	1
Warranty card	1
Operating Instructions	1

Specifications and appearance are subject to change without notice.

Should this product require service in the U.S.A. and you wish to locate the nearest Pioneer Authorized Independent Service Company, or if you wish to purchase replacement parts, operating instructions, service manuals, or accessories, please call the number shown below.

800 – 782 – 7210

Please do not ship your product to Pioneer without first calling the Customer Support Division at the above listed number for assistance.

**PIONEER ELECTRONICS (USA), INC.
CUSTOMER SUPPORT DIVISION
P.O. BOX 1760, LONG BEACH,
CA 90801-1760, U.S.A.**

For warranty information please see the Limited Warranty sheet included with your product.

Should this product require service in Canada, please contact a Pioneer Canadian Authorized Dealer to locate the nearest Pioneer Authorized Service Company in Canada. Alternatively, please contact the Customer Service Department at the following address:

Pioneer Electronics of Canada, Inc.

**300 Allstate Parkway
Markham, ON L3R OP2
(905) 479-4411
1 (877) 283-5901**

For warranty information please see the Limited Warranty sheet included with your product.

Published by Pioneer Corporation.
Copyright © 2007 Pioneer Corporation.
All rights reserved.

PIONEER CORPORATION

4-1, Meguro 1-Chome, Meguro-ku, Tokyo 153-8654, Japan

PIONEER ELECTRONICS (USA) INC.

Multimedia and Mass Storage Division: 2265 East 220th Street, Long Beach, CA 90810, U.S.A. TEL: 800-444-OPT1 (6784)

PIONEER ELECTRONICS OF CANADA, INC.

Industrial Products Department: 300 Allstate Parkway, Markham, Ontario L3R OP2, Canada TEL: 905-479-4411