



AIPHONE

MIXER AMPLIFIER

— INSTRUCTIONS —

PM-30



PM-60

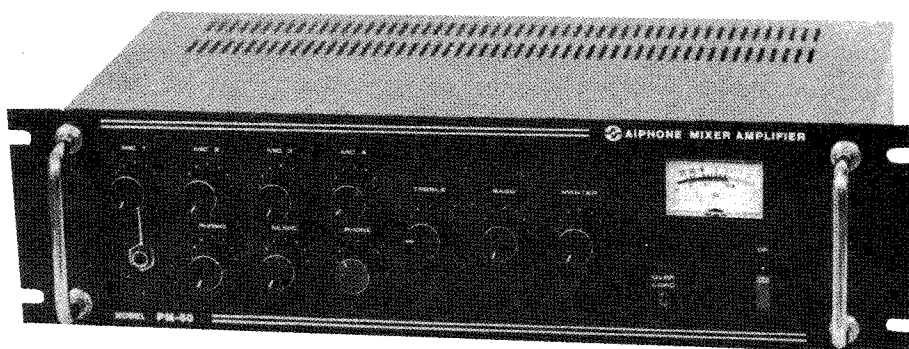

PM-100

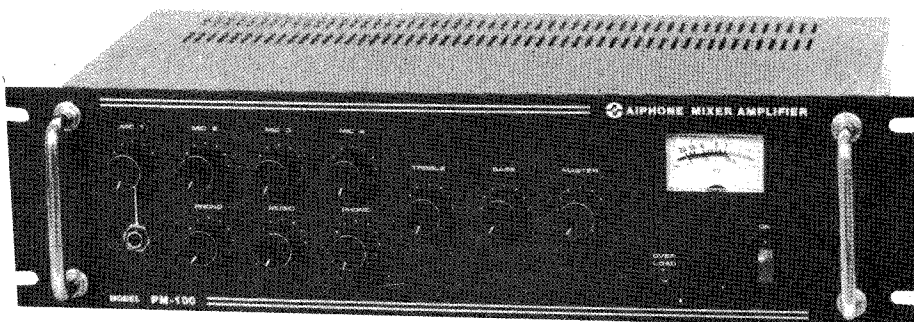

1. FEATURES:

- 1) All transistorized circuitry: high quality design and construction.
- 2) Full frequency response: 100Hz~10KHz \pm 3dB
- 3) Low distortion: less than 3% at rated output
- 4) Bass and treble tone control.
- 5) Built-in VU meter.
- 6) Output Overload Auto protected circuit.
- 7) Master volume control.
- 8) 5 inputs: 3-Mic., 1-Aux, 1-Phone with independent volume control (30W).
8 inputs: 4-Mic., 1-Aux, 1-Tape/Tuner, 1-Phono, 1-Phone with independent volume control (60W/100W).
- 9) AC 117V. 50/60Hz.
- 10) Isolated-transformer outputs: 4, 8, 16 ohms and 25, 70V.
- 11) Handsome modern styling.

2. GENERAL DESCRIPTION:

The PM series Mixer Amplifiers, PM-30(30W), PM-60(60W), PM-100(100W), are designed for years of trouble-free use in diverse commercial and industrial applications. They provide paging, announcement, intercommunication and background music systems in industrial plants, offices, churches, hotels, department stores, shopping centers, night clubs, restaurants, convention halls, auditoriums, and stadiums. Their main feature is the ability to withstand overload and open or short-circuiting of the output. The PM series requires no complicated protective circuit to withstand accidents or mismatched output connections that may occur during the installation or use of a PA system. The amplifier is protected by a circuit breaker when other abnormal electrical conditions occur.

Four microphone inputs are provided for High and low Impedance microphones.

Four auxiliary (Tape/Tuner, Phono, Phone, Aux) inputs are provided for signal sources such as FM-Tuner, cassette player, remote-microphone, ceramic or crystal phonograph cartridge, and telephone system.

Speaker outputs are complete with 4, 8, 16 ohms (usable 4-16 ohms) and 25V or 70V line connections. All the inputs and outputs are secured with screw terminals. Terminals have been covered for protection against electric-shock.

There are four microphone volume controls, four auxiliary volume controls, a master volume control, bass tone control, treble tone control, and power on/off switch, plus an overload LED pilot lamp are provided. Also, a VU meter has been added for visual monitoring.

3. SPECIFICATIONS:

Models: PM-30, PM-60, PM-100

Type : Mixer Power Amplifier

Power Output:

PM-30 : 30Watts rms. less 3% THD. at 1KHz AC 117V

PM-60 : 60Watts rms. less 3% THD. at 1KHz AC 117V

PM-100: 100Watts rms. less 3% THD. at 1KHz AC 117V

Frequency Response: 100Hz~10KHz \pm 3dB

Sensitivity and Impedance:

Mic Input: 3.0mV (-50dB)/50K ohm, 0.5mV (-66dB)/600 ohm
Tape/Tuner, AUX Inputs: 100mV (-20dB)/100K ohm
Phono Input: 55mV (-25dB)/500K ohm
Phone Input: 1V (0dB)/600 ohm

Outputs:

Voltage and impedance:

PM-30 : 11V (4 ohm), 15.5V (8 ohm), 22V (16 ohm), 25V (21 ohm),
70V (163 ohm)
PM-60 : 15.5V (4 ohm), 22V (8 ohm), 31V (16 ohm), 25V (10.4 ohm),
70V (81.6 ohm)
PM-100: 20V (4 ohm), 28.3V (8 ohm), 40V (16 ohm), 25V (6.3 ohm),
70V (49 ohm)

Noise Level:

All volume control C.C.W. -75db below rated output.
Microphone -55db below rated output.
Tape/Tuner, Phono, Phone, Aux -65db below rated output.

Tone Control:

Bass ±10dB at 100Hz
Treble ±10dB at 10KHz

Indicators: 1-Power Lamp, 1-Overload Lamp (LED), 1-Output VU Meter

Protections: 1-AC Circuit breaker, 1-overload protector (Builted in)

Terminals: Screw terminals for all inputs/outputs.

Power Supply: 110-120V AC 50/60Hz

Power Consumption:

| | No Signal AC Source | Rated Output AC Source |
|--------|---------------------|------------------------|
| PM-30 | 15VA | 100VA |
| PM-60 | 32VA | 200VA |
| PM-100 | 60VA | 320VA |

Ambient Temperature Range: 14°F to 140°F (-10°C to 60°C)

| Weight: | PM-30 | PM-60 | PM-100 |
|---------|----------|----------|----------|
| | 6.0 Kg | 9.5 Kg | 11 Kg |
| | 13.2 lbs | 20.9 lbs | 24.2 lbs |

Dimensions: (W x H x D)

| | |
|--------|---|
| PM-30 | 12.60" x 3.54" x 9.84" (320 x 90 x 250 m/m) |
| PM-60 | 17.72" x 4.92" x 11.22" (450 x 125 x 285 m/m) |
| PM-100 | 17.72" x 4.92" x 11.22" (320 x 125 x 285 m/m) |

Accessories:

PM-30: Rack mount brackets.

4. FUNCTIONS:

PM-30

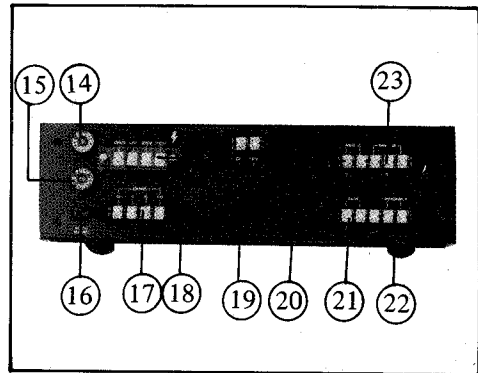
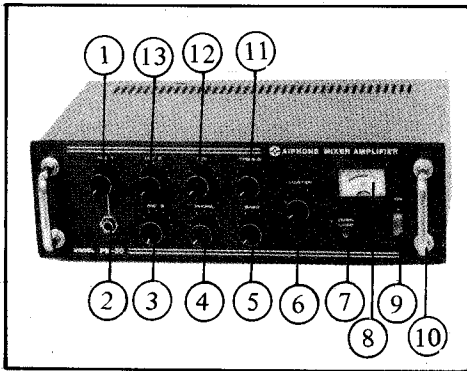

PM-60, PM-100

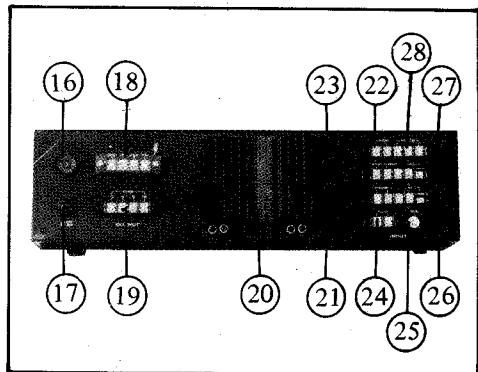
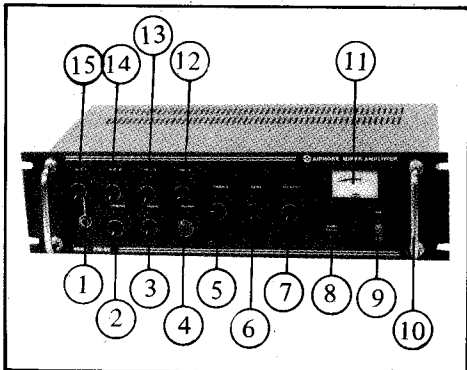

Model: PM-30

1. Mic-1 Volume Control
2. Mic-1 Input Phone Jack
3. Mic-3 Volume Control
4. Telephone Volume Control
5. Bass Tone Control
6. Master Volume Control
7. Over Load Pilot Lamp
8. Output VU Meter
9. Power Switch
10. Handle
11. Treble Tone Control
12. Aux Volume Control
13. Mic-2 Volume Control
14. Circuit Breaker (D.C.)
15. Circuit Breaker (A.C.)

PM-60, PM-100

1. Mic-1 Input Phone Jack
2. Phono Volume Control
3. Music Volume Control
4. Telephone Volume Control
5. Treble Tone Control
6. Bass Tone Control
7. Master Volume Control
8. Over Load Pilot Lamp
9. Power Switch
10. Handle
11. Output VU Meter
12. Mic-4 Volume Control
13. Mic-3 Volume Control
14. Mic-2 Volume Control
15. Mic-1 Volume Control
16. Circuit Breaker
17. AC Power Supply Cord
18. High Impedance Output Terminals (25V, 70V)
19. Low Impedance Output Terminals (4, 8, 16 ohm)
20. Heat Sink

- 21. Aux Input Terminals
- 22. Telephone Input Terminals
- 23. Mic-2 Input Terminals

- 21. Phono Input Terminals
- 22. Music (Tape/Tuner) Input Terminals
- 23. Telephone Input Terminals
- 24. AUX Input Terminals
- 25. AUX Volume Control
- 26. Mic-4 Input Terminals
- 27. Mic-3 Input Terminals
- 28. Mic-2 Input Terminals

5. INSTALLATION:

Unpacking:

Upon receiving shipment, please inspect for any damage incurred in transit. If damage is found, please notify your Aiphone distributor.

Connecting of Components:

An FM tuner, Cassette player, remote microphone, chime and other high level signal sources may be connected to high impedance inputs with a single-conductor low capacity shielded cable.

The high impedance microphone with a single-conductor shielded cable of 30' to 60' (10-20m) length can be plugged into the Mic. 1 input.

Make certain that all input cables are kept away from speaker cables, power cables and power transformers.

Speaker cables must be also kept away from power cables.

Grounding the Unit

The chassis of the unit must be grounded by using GND (\perp) terminal located on rear side and connected to an earth ground (eg: cold water pipe).

If additional equipment is connected to the amplifier, make sure that these chassis are individually secured to the same ground.

6. OPERATIONS:

Over Load

If the external load exceeds the rated power, a safety circuit will respond and protect this unit immediately. (Even if the load is short-circuited), the protective circuit will be activated by loading 1.5 times over the rated power. If the "OVER LOAD" lamp is illuminating or the circuit breaker on rear panel is turned off, please turn off the power and check the output circuit. When a correct circuit has been secured, push circuit breaker back to original position and turn power on. Make sure overload lamp is off, otherwise re-check the output circuit.

Volume Control Setting

For the average input signals, the master gain control should be set to the middle. In relation to the levels of inputs, it is recommended that the gains or losses be equally divided between individual controls and the master control.

Tone-Controls

The separate tone controls provide boost and attenuation of bass and treble response. The flat position is obtained when the knobs are set to mechanical center.

Turn BASS control knob and TREBLE control knob respectively, clockwise to raise tone level by approximate +10dB, turn counter-clockwise to lower tone level by approximate -10dB.

7. INPUT CONNECTION:

Microphones

Four microphone inputs are provided. They may be used with balanced or unbalanced high impedance (50K ohm) or Low impedance (600 ohm) microphone. A microphone with an unbalanced connection cable of 30' to 60' (10-20m.) may be used, but it depends on the microphone and its characteristic..

Mic-1, Mic-2, Mic-3, and Mic-4

Mic-1 is unbalanced-High impedance and is provided with a double pole phone jack located on the front panel.

Mic-2 is balanced Low impedance, and Mic-3, and 4 are unbalanced-Low Impedance, and are located on the rear panel.

Balanced Low Impedance Microphone

Connect to the double conductor shielded cable.

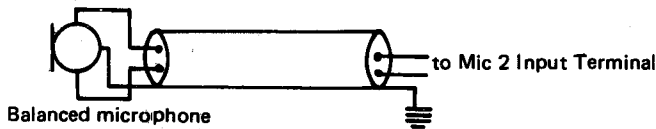

Unbalanced High Impedance Microphone

May also be connected to the single conductor shielded cable of unbalanced high impedance microphone.

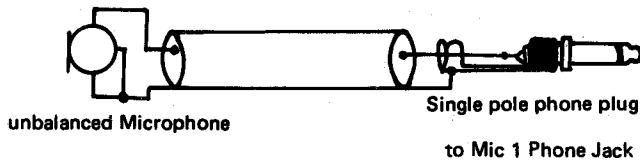

Unbalanced Low Impedance Microphone

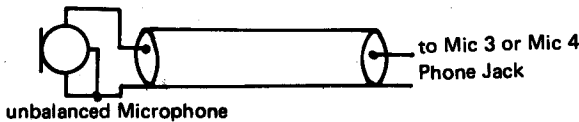

Phonograph

Connect ceramic or crystal cartridge pick-up to Phono input (55mV 500Kohm). Use a single-conductor or double-conductor shielded cable.

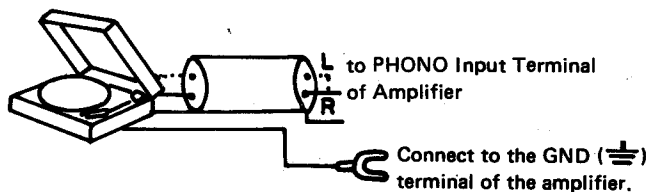

Auxiliary (AUX, PHONO, TAPE PLAYER, TUNER)

An FM tuner or tape player may be connected to the TAPE/TUNER input.

In Addition

A remote microphone, Chime, Mixer, Preamplifier or other high level signal sources may be connected to the AUX. Use single or double conductor shielded cable.

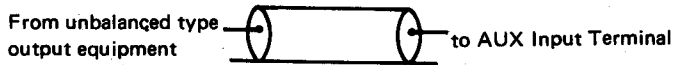

Telephone:

A voice signal from the telephone system (600 ohm, balanced output) may be connected to the PHONE input. Use two conductor shielded cable.

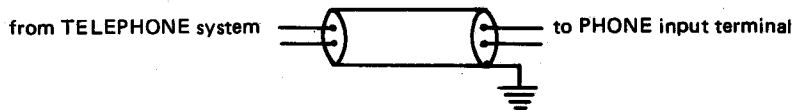

8. OUTPUT CONNECTIONS:

Speaker Output

The amplifier may be used in conjunction with a speaker rated at 4, 8, 16 ohms or with balanced output 25 Volt or 70 Volt constant-voltage speaker systems.

Low Impedance Speaker Output: 4, 8, 16 ohm

The 4, 8, 16 ohms terminal is provided for the connection of a few large-output speakers. This applies when constant-voltage speaker system is unnecessary or in case the distance between the amplifier and the speakers is short enough (less than 200ft). It is requested that the total speaker load impedance be correctly matched to the output impedance of the amplifier for most efficient transfer of power.

Be sure that total impedance of speaker is above 4, 8 and 16 ohms. However, do not raise amplifier output power over the endurable input power of speaker, otherwise the speaker would be damaged.

25V and 70 Volts Speaker Output

When it is desired to operate the speaker from a distance of over 200' from the amplifier, it is recommended that line matching transformers be installed on the speaker units to prevent excessive line losses.

This method of load matching known as the constant voltage distribution system eliminates the calculation of load impedance and series-parallel speaker arrangements. In this method, all speakers are connected in parallel.

These constant voltage outputs are most convenient for distribution of power when a number of speakers are installed. Each speaker must have 25 volt or 70 volt line transformer with a tap that gives the power desired for that speaker. The total number of power settings for all speakers should be equal to the amplifier power rating or less.

Wiring instruction is indicated as follows:

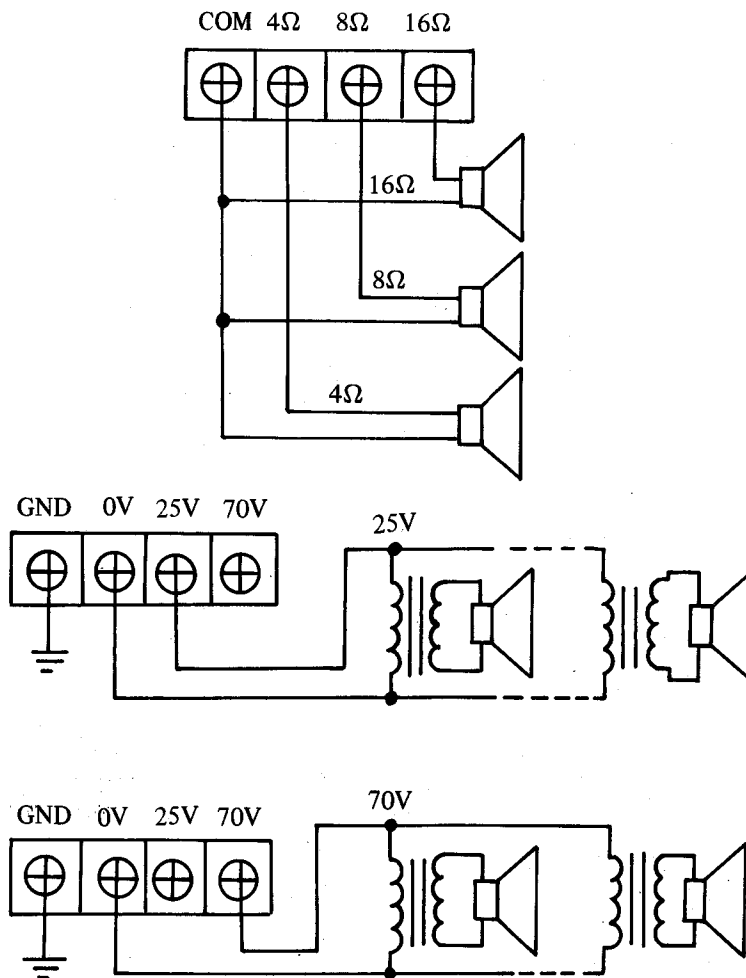

Output Meter

The swing of the output meter indicates output level. When voice or music is amplified, set the volume control knob at the position where the maximum output meter reading (max, swing of arm) is below 100%.

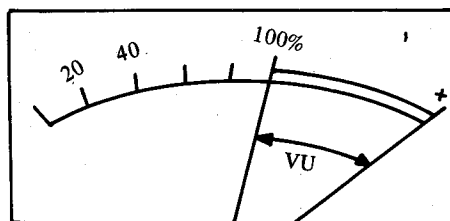
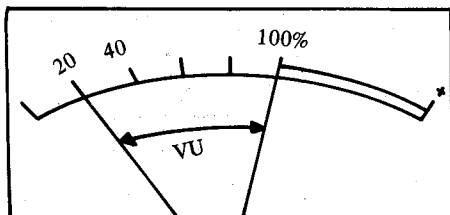

9. TYPICAL CONNECTIONS:

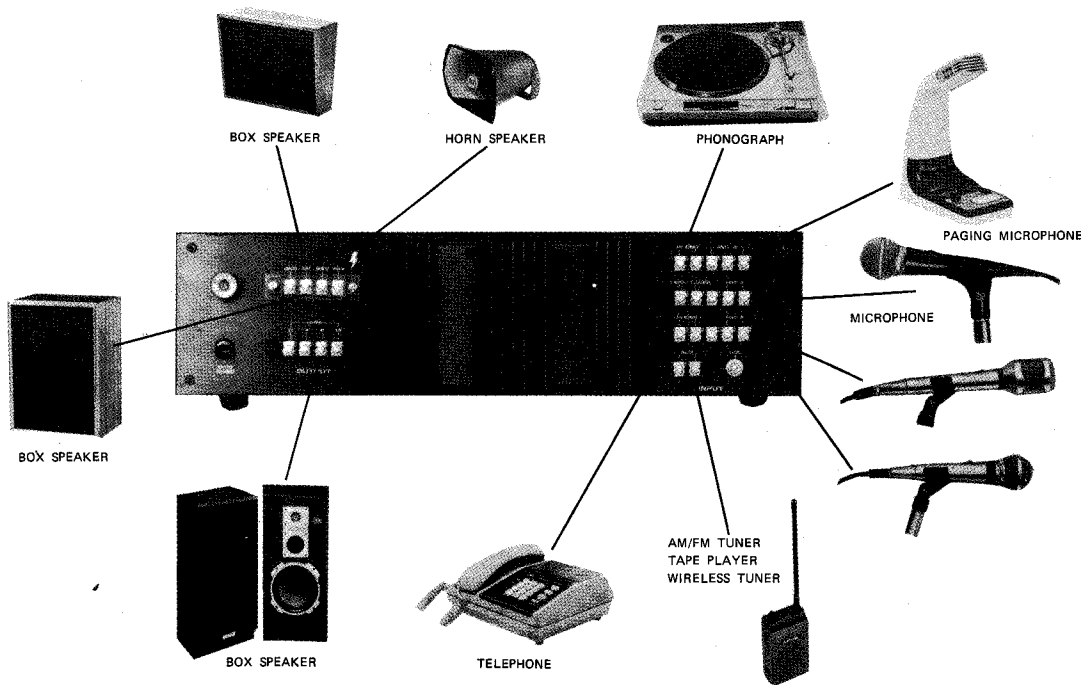

We at AIPHONE are proud of our products. Our designers and engineers strive to bring you the finest in sound equipment. Each item has been carefully tested and inspected before leaving our factory. Properly installed and used, your Aiphone system will give years of troublefree service.

WARRANTY

Aiphone warrants its products to be free from defects of material and workmanship under normal use and service for a period of one year after delivery to the ultimate user and will repair free of charge or replace at no charge, should it become defective upon which examination shall disclose to be defective and under warranty. Aiphone reserves unto itself the sole right to make the final decision whether there is a defect in materials and/or workmanship; and whether or not the product is within the warranty.

This warranty shall not apply to any Aiphone product which has been subject to misuse, neglect, accident, or to use in violation of instructions furnished, nor extended to units which have been repaired or altered outside of the factory.

This warranty does not cover batteries or damage caused by batteries used in connection with the product.

This warranty covers bench repairs only, and any repairs must be made at the shop or place designated in writing by Aiphone. Aiphone will not be responsible for any costs incurred involving on site service calls.