

SONY®

DIGITAL AUDIO MIXING CONSOLE

OXF-R3

OPERATION MANUAL English

1st Edition (Revised 3)

Software Version 3.0 and Later

CAUTION

Installation has to be done by a SONY authorized technician.

WARNING

To prevent fire or shock hazard, do not expose the unit to rain or moisture.

To avoid electrical shock, do not open the cabinet. Refer servicing to qualified personnel only.

VORSICHT

Um Feuergefahr und die Gefahr eines elektrischen Schlages zu vermeiden, darf das Gerät weder Regen noch Feuchtigkeit ausgesetzt werden.

Um einen elektrischen Schlag zu vermeiden, darf das Gehäuse nicht geöffnet werden. Überlassen Sie Wartungsarbeiten stets nur einem Fachmann.

For customers in the U.S.A

WARNING

This equipment has been tested and found to comply with the limits for a Class A digital device, pursuant to Part 15 of the FCC Rules. These limits are designed to provide reasonable protection against harmful interference when the equipment is operated in a commercial environment. This equipment generates, uses, and can radiate radio frequency energy and, if not installed and used in accordance with the instruction manual, may cause harmful interference to radio communications. Operation of this equipment in a residential area is likely to cause harmful interference in which case the user will be required to correct the interference at his own expense.

You are cautioned that any changes or modifications not expressly approved in this manual could void your authority to operate this equipment.

The shielded interface cable recommended in this manual must be used with this equipment in order to comply with the limits for a digital device pursuant to Subpart B of Part 15 of FCC rules.



This symbol is intended to alert the user to the presence of important operating and maintenance (servicing) instructions in the literature accompanying the appliance.

For customers in Europe

This product with CE marking complies with both the EMC Directive (89/336/EEC) and the Low Voltage Directive (73/23/EEC) issued by the Commission of the European Community.

Compliance with these directives implies conformity to the following European standards:

- EN60950 : Product Safety
- EN55103-1: Electromagnetic Interference (Emission)
- EN55103-2: Electromagnetic Susceptibility (Immunity)

This product is intended for use in the following Electromagnetic Environment(s)
E4 (controlled EMC environment, ex. TV studio)

Pour les clients européens

Ce produit portant la marque CE est conforme à la fois à la Directive sur la compatibilité électromagnétique (EMC) (89/336/CEE) et à la Directive sur les basses tensions (73/23/CEE) émises par la Commission de la Communauté européenne.

La conformité à ces directives implique la conformité aux normes européennes suivantes:

- EN60950 : Sécurité des produits
- EN55103-1 : Interférence électromagnétiques (émission)
- EN55103-2 : Sensibilité électromagnétique (immunité)

Ce produit est prévu pour être utilisé dans les environnements électromagnétiques suivants:

E4 (environnement EMC contrôlé ex. studio de télévision).

Für Kunden in Europa

Dieses Product besitzt die CE-Kennzeichnung und erfüllt sowohl die EMV-Directive (89/336/EEC) als auch die Directive Niederspannung (73/23/CEE) der EG-Kommission.

Die Erfüllung dieser Directiven bedeutet Konformität für die folgenden Europäischen Normen:

- EN60950 : Produktsicherheit
- EN55103-1 : Electromagnetische Interferenz (Emission)
- EN55103-2 : Electromagnetische Empfindlichkeit (Immunität)

Dies Produkt ist für den Einsatz unter folgenden electromagnetischen Bedingungen ausgelegt:
E4 (kontrollierter EMV-Bereich, z.B. Fernsehstudio)

Peak Inrush Current

OXF-CP3048PS

- (1) Power ON, current probe method:
50A (100V)
110A (240V)
- (2) Hot switching inrush current, measured in accordance with European standard EN55103-1:
40A (230V)

OXF-SP3000

- (1) Power ON, current probe method:
40A (100V)
80A (240V)
- (2) Hot switching inrush current, measured in accordance with European standard EN55103-1:
80A (230V)

OXF-IO3000

- (1) Power ON, current probe method:
20A (100V)
70A (240V)
- (2) Hot switching inrush current, measured in accordance with European standard EN55103-1:
30A (230V)

Appel de Courant de Crête

OXF-CP3048PS

- (1) Mise sous tension (ON), méthode de sondage du courant:
50A (100V)
110A (240V)
- (2) Mesuré conformément à la norme européenne EN55103-1:
40A (230V)

OXF-SP3000

- (1) Mise sous tension (ON), méthode de sondage du courant:
40A (100V)
80A (240V)
- (2) Mesuré conformément à la norme européenne EN55103-1:
80A (230V)

OXF-IO3000

- (1) Mise sous tension (ON), méthode de sondage du courant:
20A (100)
70A (240V)
- (2) Mesuré conformément à la norme européenne EN55103-1:
30A (230V)

Spitzenstrom

OXF-CP3048PS

- (1) Einschaltstrom, Stromsonde:
50A (100V)
110A (240V)
- (2) Gemessen in EN55103-1:
40A (230V)

OXF-SP3000

- (1) Einschaltstrom, Stromsonde:
40A (100V)
80A (240V)
- (2) Gemessen in EN55103-1:
80A (230V)

OXF-IO3000

- (1) Einschaltstrom, Stromsonde:
20A (100V)
70A (240V)
- (2) Gemessen in EN55103-1:
30A (230V)

OXF-CP3048PS only

WARNING

This unit has no power switch.

When installing the unit, incorporate a readily accessible disconnect device in the fixed wiring, or connect the power cord to a socket-outlet which must be provided near the unit and easily accessible.

If a fault should occur during operation of the unit, operate the disconnect device to switch the power supply off, or disconnect the power cord.

WARNUNG

Dieses Gerät hat keinen Netzschalter.

Beim Einbau des Geräts ist daher im Festkabel ein leicht zugänglicher Unterbrecher einzufügen, oder das Netzkabel muß mit einer in der Nähe des Geräts befindlichen, leicht zugänglichen Wandsteckdose verbunden werden.

Wenn während des Betriebs eine Funktionsstörung auftritt, ist der Unterbrecher zu betätigen bzw. das Netzkabel abzuziehen, damit die Stromversorgung zum Gerät unterbrochen wird.

WARNING: THIS WARNING IS APPLICABLE FOR USA ONLY.

If used in USA, use the UL LISTED power cord specified below.

DO NOT USE ANY OTHER POWER CORD.

Plug Cap	Parallel blade with ground pin (NEMA 5-15P Configuration)
Cord	Type SJT, three 16 or 18 AWG wires
Length	Less than 2.5 m (8 ft 3 in)
Rating	Minimum 10 A, 125 V

Using this unit at a voltage other than 120V may require the use of a different line cord or attachment plug, or both.

To reduce the risk of fire or electric shock, refer servicing to qualified service personnel.

Table of Contents

	About This Manual.....	5
Chapter 1		
Overview	1-1 Overview	1-2
	1-2 Data Flow.....	1-4
	1-3 Signal Flow.....	1-6
Chapter 2		
Powering The OXF-R3	2-1 OXF-R3 Start-Up.....	2-2
	2-1-1 Start-Up Procedure	2-2
	2-2 OXF-R3 Shutdown.....	2-4
	2-2-1 Shutdown Procedure	2-4
Chapter 3		
Getting Started	3-1 The Control Surface.....	3-2
	3-2 Fader Paging.....	3-8
	3-3 Assignable Channel Processing.....	3-9
	3-4 Input Channel, Equaliser and Filters.....	3-10
	3-5 Free Assign Area and Dynamics.....	3-11
	3-6 Multitrack, Routing for Multitrack, Super Send Groups and Multi-Format.....	3-12
	3-7 Sends.....	3-13
	3-8 Select To Faders.....	3-14
	3-9 Select To Pans.....	3-17
	3-10 Basic Console Operations.....	3-18
	3-10-1 To Route a Mic or Line Input to the Main Output Bus ...	3-19
	3-10-2 To Set Up a Super Send Group from Channel Inputs	3-20
	3-10-3 To Send Signals to Tracks on Tape	3-21
	3-10-4 To Monitor Signals to and from Tape	3-22
	3-10-5 To Set Up a Stereo Headphone Mix for Foldback 1 O/P	3-23
	3-10-6 To Equalise Signal Feeding the Multitrack	3-24
	3-10-7 To Equalise Monitor Signal Post Multitrack	3-25
	3-10-8 To Insert Dynamics Pre Multitrack Send	3-26
	3-10-9 To Insert Dynamics Post Multitrack Return	3-27
	3-10-10 To Bounce Tracks	3-28
	3-10-11 To Set Up Super Send Groups from Multitrack	3-29
	3-10-12 To Set Up a De-Esser Using Dynamics Side-Chain EQ..	3-30
	3-10-13 To Link Compressor Side-Chains in a Group	3-31
	3-10-14 To Link Compressor Side-Chains so that One Channel Controls a Second Channel	3-32

Table of Contents

Chapter 4 Signal Paths

4-1 The Basic (Default) Signal Path.....	4-2
4-2 Stereo Mix-Down Signal Path with Processing Inserted.....	4-4
4-3 Mix-Down with Post Channel Fader Insert.....	4-6
4-4 Recording to a Multitrack.....	4-7
4-5 In-Line Channel Multitrack Recording Set-up.....	4-8
4-6 In-Line Channel with Insert Post Channel Fader (Monitor Function).....	4-9
4-7 SEND 1 Pre Fader Headphones Feed.....	4-10
4-8 SEND 1 Post Fader Headphones Feed.....	4-11
4-9 Broadcast Mode.....	4-12
4-10 Channel Metering.....	4-15
4-10-1 Channel Meter Default.....	4-15
4-10-2 Channel Meters to Input	4-15
4-10-3 Send Monitor	4-16
4-10-4 Return Monitor	4-16
4-10-5 MULTI in Channel Path	4-17
4-11 Dynamics Side-Chain Linking.....	4-18
4-11-1 Dynamics Side-Chain Link Right.....	4-18
4-11-2 Dynamics Side-Chain Busses 1-4.....	4-20
4-12 Mixing to the Main Output Bus.....	4-22
4-12-1 Main Output Bus Set-up	4-24
4-12-2 Channel Signal to the Main Output	4-26
4-13 Multi-Stem Set-up.....	4-29
4-13-1 Multi-Stem Set-up Procedure	4-32
4-13-2 Multi-Stem Monitor Path	4-36
4-13-3 Multi-Stem Source Channels	4-40
4-13-4 STEM Monitor Switching	4-48
4-13-5 STEM Monitor Switching GUI Set-up	4-50
4-13-6 Fold-Down Matrix GUIs	4-52

Chapter 5 Control Screens

5-1 The Master Control Screens.....	5-2
5-2 Channel Screens.....	5-5
5-2-1 Routing GUI.....	5-8
5-2-2 I/O GUI	5-11
5-2-3 Equaliser & Filters GUI	5-28
5-2-4 Dynamics GUI	5-29
5-2-5 Preferences GUI.....	5-30
5-2-6 Master GUI (Includes Main Bus Outputs)	5-39

Chapter 6 Technical Descriptions

6-1 10XF-R3 System Description.....	6-2
6-1-1 Control Surface Configurations	6-3
6-2 Channels Section Panels.....	6-6
6-2-1 Fader Panel.....	6-6
6-2-2 Select to Faders Panel	6-9
6-2-3 Pans Panel	6-13
6-2-4 Select to Pans Panel	6-15
6-2-5 Input and Equaliser Panel	6-17
6-2-6 Free Assign Area & Dynamics Panel	6-20
6-2-7 Multitrack Panel	6-25

**Chapter 6
Technical Descriptions**

6-2-8	Routing Panel	6-28
6-2-9	LCD Channel Screen Panel	6-31
6-2-10	Sends 1-24 Panel	6-32
6 - 3	Central Section Panels.....	6 - 38
6-3-1	Master Fader Panel	6-38
6-3-2	Monitor Panel.....	6-39
6-3-3	Control Keyboard Panel	6-62
6-3-4	Super Send Groups, Send Outputs and Multi-Format Panel	6-76
6-3-5	Central Section Faders	6-86
6-3-6	Control LCD Screen Panel.....	6-87
6-3-7	QWERTY Keyboard.....	6-88
6-3-8	Trackerballs.....	6-89
6 - 4	Meter Bridge.....	6 - 90
6-4-1	Mono Channel Meters.....	6-90
6-4-2	Stereo Centre Section Meters.....	6-92
6-4-3	Other Meter Bridge Indicators	6-95
6 - 5	Signal Processing Rack.....	6 - 96
6-5-1	SP Rack Modules	6-96
6 - 6	I/O Racks.....	6 - 97
6-6-1	I/O Rack Modules	6-97

**Chapter 7
Session Management™**

7 - 1	The Basics.....	7 - 2
7 - 2	Files Hierarchy and Automatable Controls...	7 - 3
7-2-1	Files Hierarchy	7-3
7-2-2	Automatable Controls	7-6
7 - 3	File Data Storage.....	7 - 7
7 - 4	Programme Material.....	7 - 8
7 - 5	Mixing Overview.....	7 - 9
7-5-1	Getting Started	7-9
7-5-2	Name the Artist/Project and Title	7-10
7-5-3	To Set Cue Points.....	7-11
7-5-4	To Automate Cuts	7-13
7-5-5	To Save a Mix	7-19
7-5-6	To Automate Fader Moves	7-20
7-5-7	Dropping Out of Write on Subsequent Mix Passes	7-21
7-5-8	To Record Absolute Moves for a Number of Faders	7-22
7-5-9	To Trim Fader Moves	7-22
7-5-10	To Trim Moves for a Number of Faders.....	7-22
7-5-11	To Automate a Pan Move (or any other Knob)	7-23
7-5-12	To Assemble a Mix	7-24

(Continued)

Table of Contents

Chapter 7 Session Management™

7-6 The Session Management™ Screen Pages	7-27
7-6-1 The Start-up Logo Screen	7-27
7-6-2 The System Screen	7-28
7-6-3 The Machines Screen	7-30
7-6-4 Artists/Projects & Titles Screen	7-32
7-6-5 Mixes & Cues Screen	7-35
7-6-6 Merge/Assemble Screen	7-40
7-6-7 Track Lists Screen	7-46
7-6-8 Snapshots, Copy & Link Screen	7-49
7-6-9 Copy Channel Fader Balance to M/T Faders and M/T to Channels	7-60
7-6-10 Copy Monitor and M/T Send Fader Balance to Cues	7-60
7-6-11 Quick Copy EQ A to B and B to A	7-60
7-6-12 Machine Remotes Screen	7-61
7 - 7 Dynamic Automation Moves	7 - 64
7-7-1 Motorised Fader Controls	7-64
7-7-2 Automating Faders	7-65
7-7-3 To Automate Cuts	7-70
7-7-4 To Automate Other Switches	7-76
7-7-5 To Automate a Pan Move (or any other knob)	7-77
7-7-6 Dropping Out of Write on Subsequent Mix Passes for Knobs	7-78
7-7-7 To Trim Pan Moves (or any other knob)	7-78
7-7-8 Automation Off and Selective Automation Isolate	7-79
7-7-9 Film Mode	7-80
7-7-10 Global Ready Enable	7-81
7 - 8 Offline Automation.....	7 - 84
7 - 9 MIDI.....	7 - 89
7-9-1 MIDI Control Pages	7-89
7-9-2 Setting MIDI parameters.....	7-90
7-9-3 MIDI Bars & Beats	7-93
7-10 Backups.....	7 - 95
7-11 Preferences	7 - 101

Appendixes

Software Installation/Upgrades	A-2
Multi-Format LS Calibration.....	A-3
Specifications.....	A-6
OXF-R3 Diagnostics.....	A-17
Index.....	I-1

About This Manual

Purpose and intended readers

This is the operation manual for the OXF-R3 digital audio mixing console. It explains how to use the OXF-R3 to record, mix and output digital audio signals.

This manual is aimed at professionals such as operators and engineers working in high-end recording studios, production companies and broadcasting stations. It is assumed that the reader has prior experience of using professional audio equipment. Use this manual as a reference, by referring to the chapters as summarised below. If however you have limited experience of using this kind of equipment, we recommend that you read through the entire manual. The block diagrams contained in this manual are intended to help you understand the signal flow and operation of the OXF-R3.

Model numbers covered by this manual

This manual refers in general terms to the OXF-R3. The illustrations show the 24-C-24 version, which is the current model.

Organisation

This manual is divided into the following seven chapters and four appendixes:

Chapter 1 Overview

Introduces the features of the OXF-R3 and how it may be used to configure a complete system.

Chapter 2 Powering the OXF-R3

Includes the system power-up procedure and the boot-up sequence for the host computer.

Chapter 3 Getting Started

Gives an overview of the OXF-R3 control surface describing the principles of operation. The panels are described in enough detail to allow the experienced operator to start using the OXF-R3.

Chapter 4 Signal Paths

Explains the general principles of building signal paths and gives examples of types of signal paths that may be built from the basic default signal path existing at 'fire-up'.

Chapter 5 Control Screens

Lists all the control screens available in the OXF-R3. The screens related to the channels and mixer functions are described in detail.

Chapter 6 Technical Descriptions

Provides the descriptions of all the modules of the OXF-R3, including the names, locations and functions of the controls. This chapter also includes descriptions of the associated SP Rack and I/O Rack system.

Chapter 7 Session Management™ System

Describes the sophisticated and flexible Session Management™ system available to OXF-R3 users, including automation of functions - a key feature of the Session Management™ system. Both static and dynamic automation is possible using the OXF-R3.

Appendixes

Provide the information for the following:

- Software installation/upgrades
- Multi-format LS calibration
- Specifications
- Diagnostic facilities (There are no user operable diagnostic facilities provided in this version of the OXF-R3).

Conventions used in this manual

This manual uses the following conventions:

Chapter 3, Section 10

• **3-10 Basic Console Operations**

Subsection 5 within Section 10

• **3-10-5 To Equalise Signal To Multitrack**

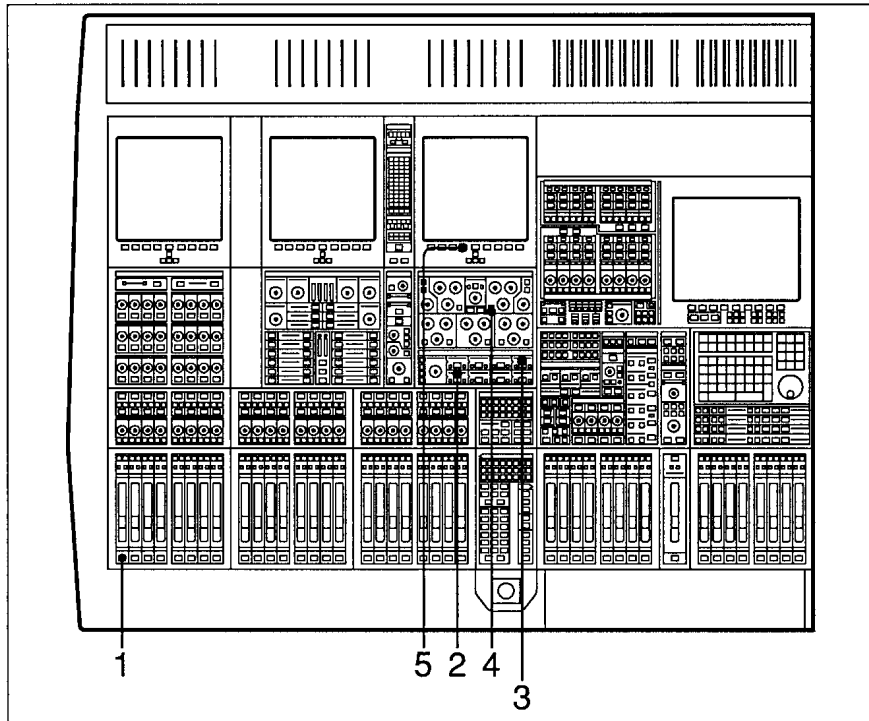

To equalise the signal to multitrack

Operation
Step number

- **1** Press the ACCESS button for the desired Channel.
- **2** At the Input Channel & Inserts panel, select 'MULTI' in 'window' no. 5. Select the large IN button to insert the multitrack into the signal path.
- **3** At the same panel, select 'EQ' in 'window' no. 4 and select the large IN button to insert the equaliser into the signal path.
- **4** On the upper section of the same panel, press the individual IN buttons for the bands required. Adjust as necessary.
- **5** Select the EQ soft key for the screen above the equaliser panel to view the parameters and response curve graph.

Cross-reference within the manual

(Refer to Chapter 5 – Control Screens, for details of this screen)

Important note

Note:
The screen defaults to a combination display of 5 Band Equaliser and High and Low Filter curves.

Related manuals

In addition to this operation manual, the following manuals are available for the OXF-R3:

- Installation Manual
- Service Manual

Glossary of Terms

ABS	Absolute	O/B	Outside Broadcast
ADC	Analogue to Digital Converter	O/L	Overload
AES	Audio Engineering Society		
AFL	After Fader Listen	PAN	Panoramic
ATR	Audio Tape Recorder	PCB	Printed Circuit Board
AUX	Auxiliary	PCM	Pulse Code Modulation
		PFL	Pre Fader Listen
CAL	Calibrated or Calibration	PSU	Power Supply Unit
CH	Channel		
CMRR	Common Mode Rejection Ratio	RET	Return
CR	Control Room	RSL	Remote Studio Link
DAC	Digital to Analogue Converter	S-C	Side Chain
DAT	Digital Audio Tape	SDDS	Sony Dynamic Digital Sound
DIV	Divergence	SDIF	Sony Digital Interface Format
DYN	Dynamics	SEL	Select
		SIG	Signal
EBU	European Broadcasting Union	SM	Session Management
EDL	Edit Decision List	SMPTE	Society of Motion Picture & Television Engineers
EQ	Equaliser or Equalisation		
EXT	External	SMS	Session Management System
		SP	Signal Processing
FILT	Filter	SPL	Sound Pressure Level
FS	Sampling Frequency	SRC	Sample Rate Converter
		SSG	Super Send Group
GDC	Global Delay Compensation	STER	Stereo
GPI	General Purpose Interface	SUR	Surround
GUI	Graphical User Interface	S/W	Software
HF	High Frequency	T/B	Talkback
HMF	Higher Mid Frequency	TC	Time Code
H/W	Hardware	TCF	Time Code Frame
		TFT	Thin Film Transistor
I/O	Input/Output	T/LIST	Track List
		TRM	Trim
LCD	Liquid Crystal Display	VCA	Voltage Controlled Amplifier
LED	Light Emitting Diode	VDU	Video Display Unit
LF	Low Frequency	VGA	Video Graphics Array
LMF	Lower Mid Frequency		
L/R	Left/Right		
LS	Loudspeaker		
MADI	Multi-Channel Audio Digital Interface		
MF	Mid Frequency		
MIC	Microphone		
MIDI	Musical Instrument Digital Interface		
M.O.	Magneto-Optical (disk)		
MON	Monitor		
M/T	Multitrack		
MTR	Meter		

Chapter 1 – Overview

This chapter introduces the OXF-R3 digital audio mixing console and describes the main features. An example system configuration and a signal flow diagram are included.

Chapter 1 Contents

1-1 Overview	1-2
1-2 Data Flow	1-4
1-3 Signal Flow	1-6

1-1 Overview

The OXF-R3 is a 'high end' digital audio mixing console system. It comprises four main components:

- Control Console with Modular Control Surface
- Host Computer
- Signal Processing (SP) Rack
- Digital and Analogue I/O Racks

The following illustration shows a basic system concept diagram.

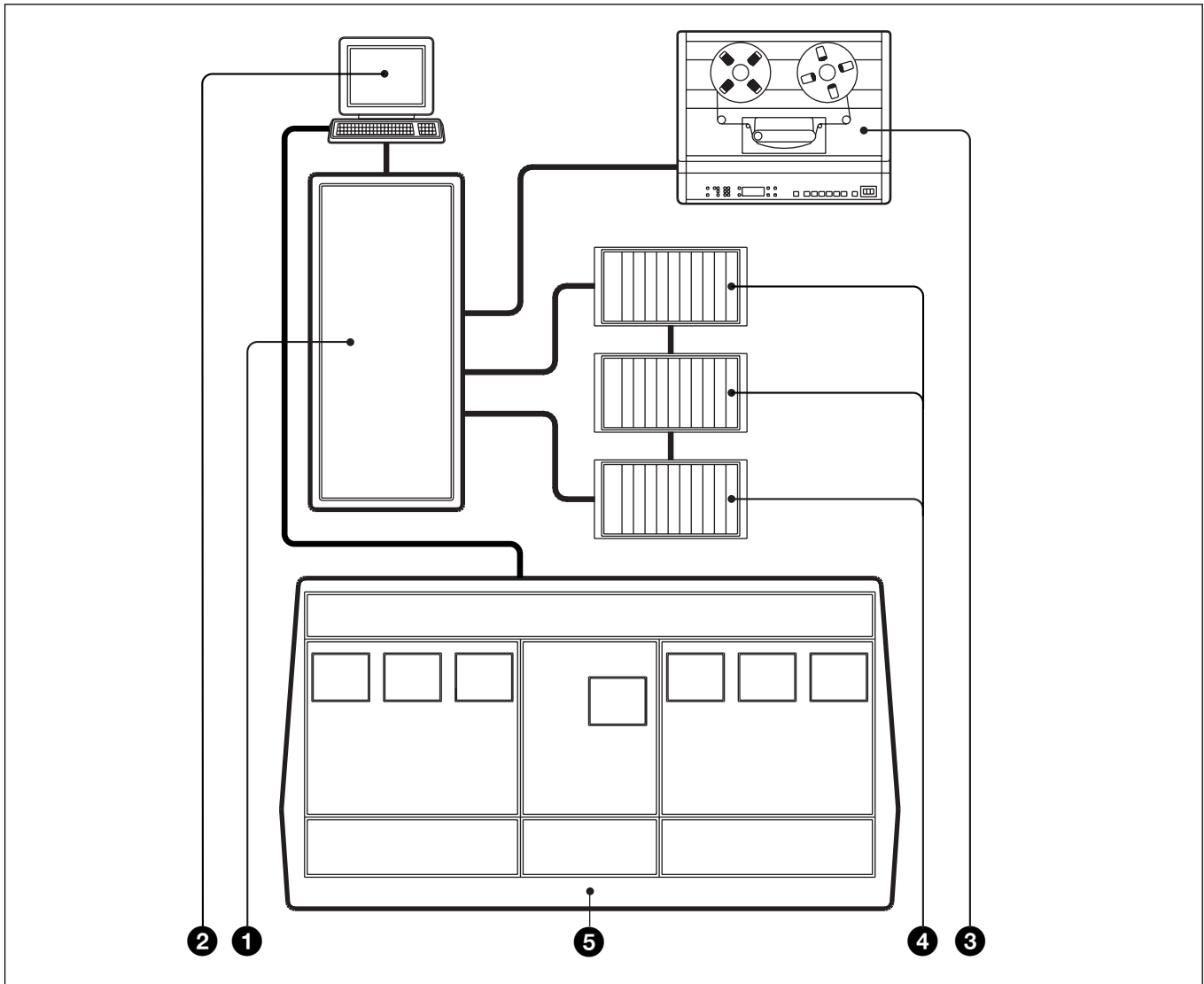

System Concept diagram

- ❶ SP Rack
- ❷ Host Computer
- ❸ Multitrack Tape Recorder(s)
- ❹ Digital and Analogue I/O Racks
- ❺ Control Console

Control Console

Compared with traditional console designs, the OXF-R3 offers greater flexibility within more compact dimensions by using an assignable control surface.

Modular Control Surface

The control surface of the OXF-R3 makes extensive use of assignable panels to provide a console of manageable size for either one or two operators, whilst giving greatly increased functionality. The current system is capable of controlling up to 96 full channels and 12 stereo return channels. The modular system divides functionally into the master section, located in the centre, and the channel sections located either side of the master section.

Signal Processing (SP) Rack

The SP rack is designed to use the minimum number of signal processing cards depending on the system size. A high level Software Design Tools System is used to generate automatically the low level software microcode which runs the SP system. Data links to and from the control console are via Ethernet connections, whilst a MADI interface is used between the SP rack and the I/O racks. Additional bandwidth, available within the MADI signal, is used to pass data for purposes such as remote control of analogue amplifier gain.

Digital and Analogue I/O Racks

The I/O racks are designed to be located close to the equipment with which they interface. Each I/O rack can contain a mix of up to 56 high quality analogue inputs and/or outputs on 10 analogue I/O cards. Each analogue card handles 4 or 8 inputs and 4 or 8 outputs according to its type. A mix of input and output cards in the same I/O rack may, for example, allow cue outputs for headphones to be local to appropriate microphone sources.

The digital and analogue I/O are housed in a single rack type. Digital I/O has the same capability as the analogue, of up to 56 inputs and 56 outputs per rack via AES/EBU and SDIF-2 (24) modules. The digital I/O system also includes modules for Timecode, 9-Pin, GPI and MIDI. MADI connections may be made directly to the SP rack.

Machine Control

Machine control for the OXF-R3 is accomplished via Sony 9-Pin control and third party devices such as the “motionworker”, supplied by Motionworks Ltd.

Note:

Refer to the Appendixes in this manual for further details of OXF-R3 capabilities.

1-2 Data Flow

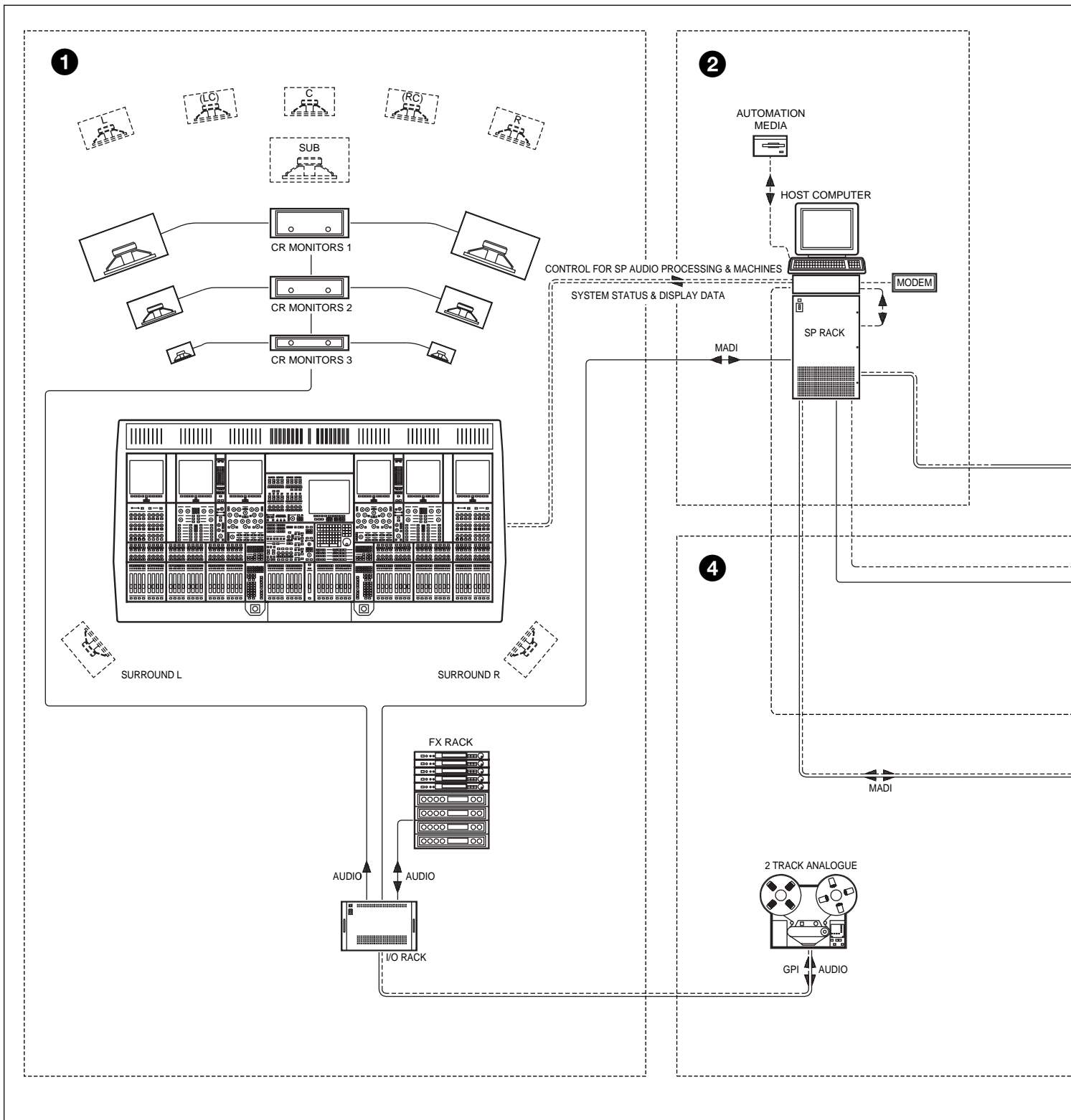

Sample installation illustrating Audio & Control Data flow

- ❶ Control Room
- ❷ Rack Room

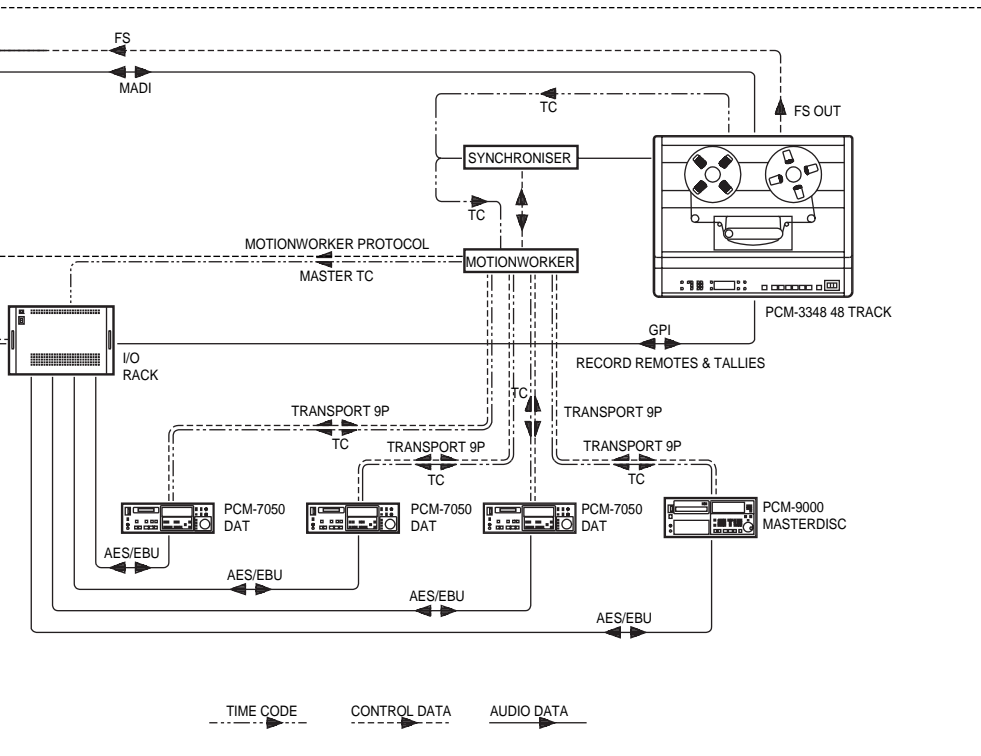
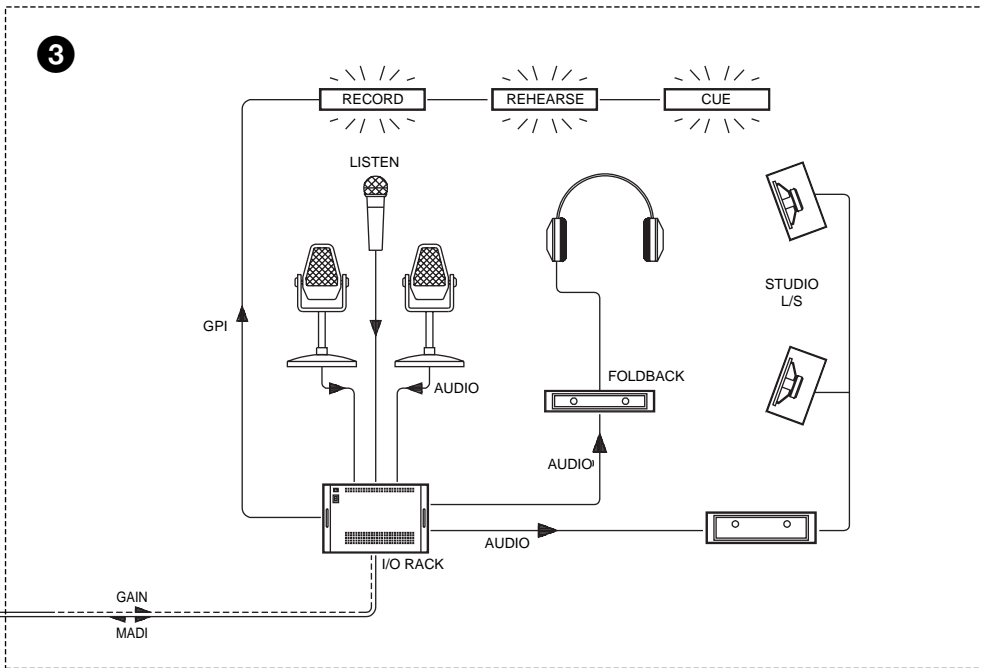

3 Studio

4 Machine Room

1-3 Signal Flow

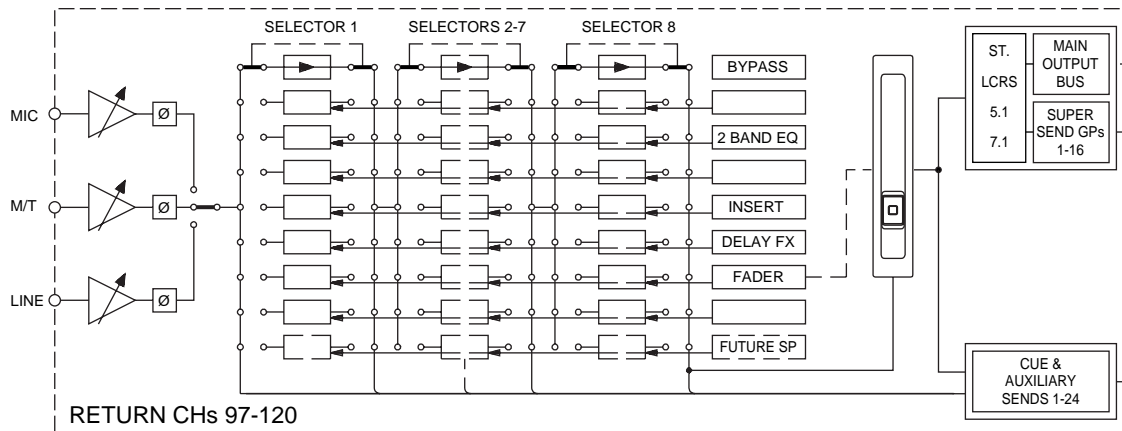
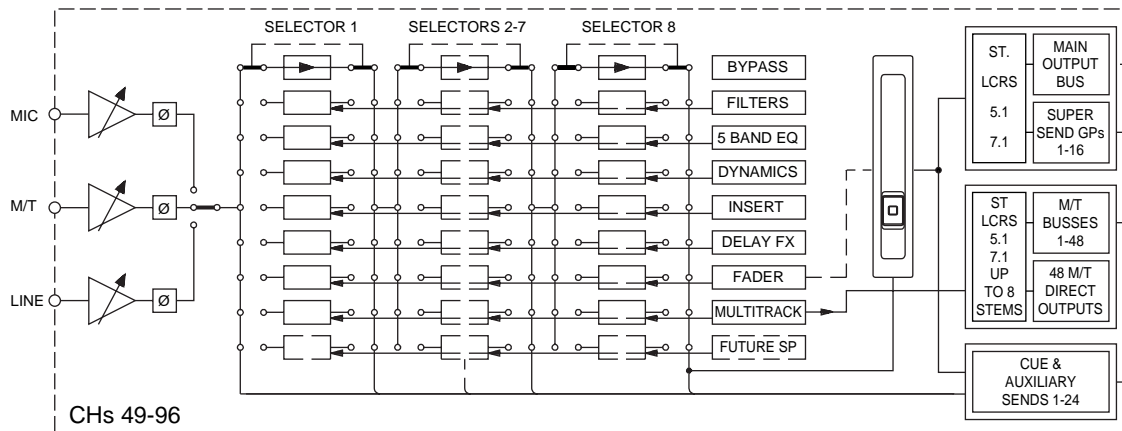
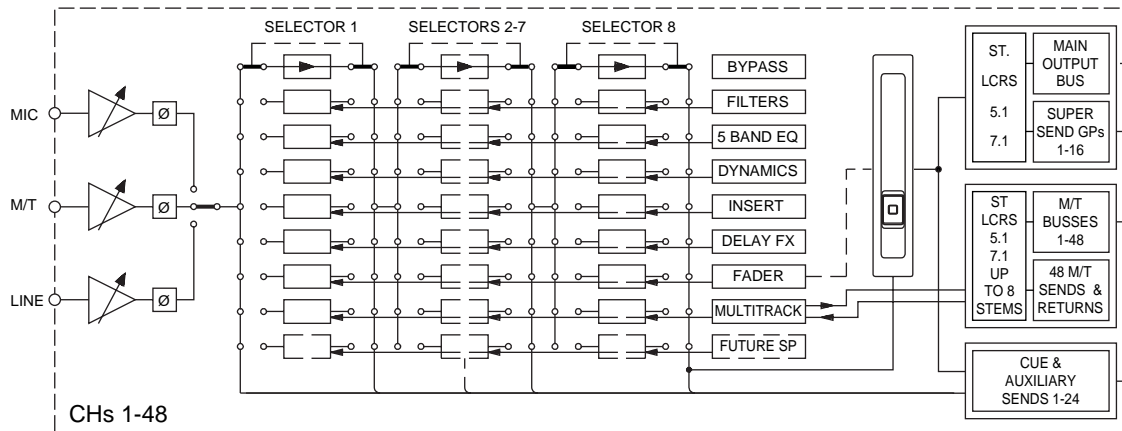

OXF-R3 signal flow

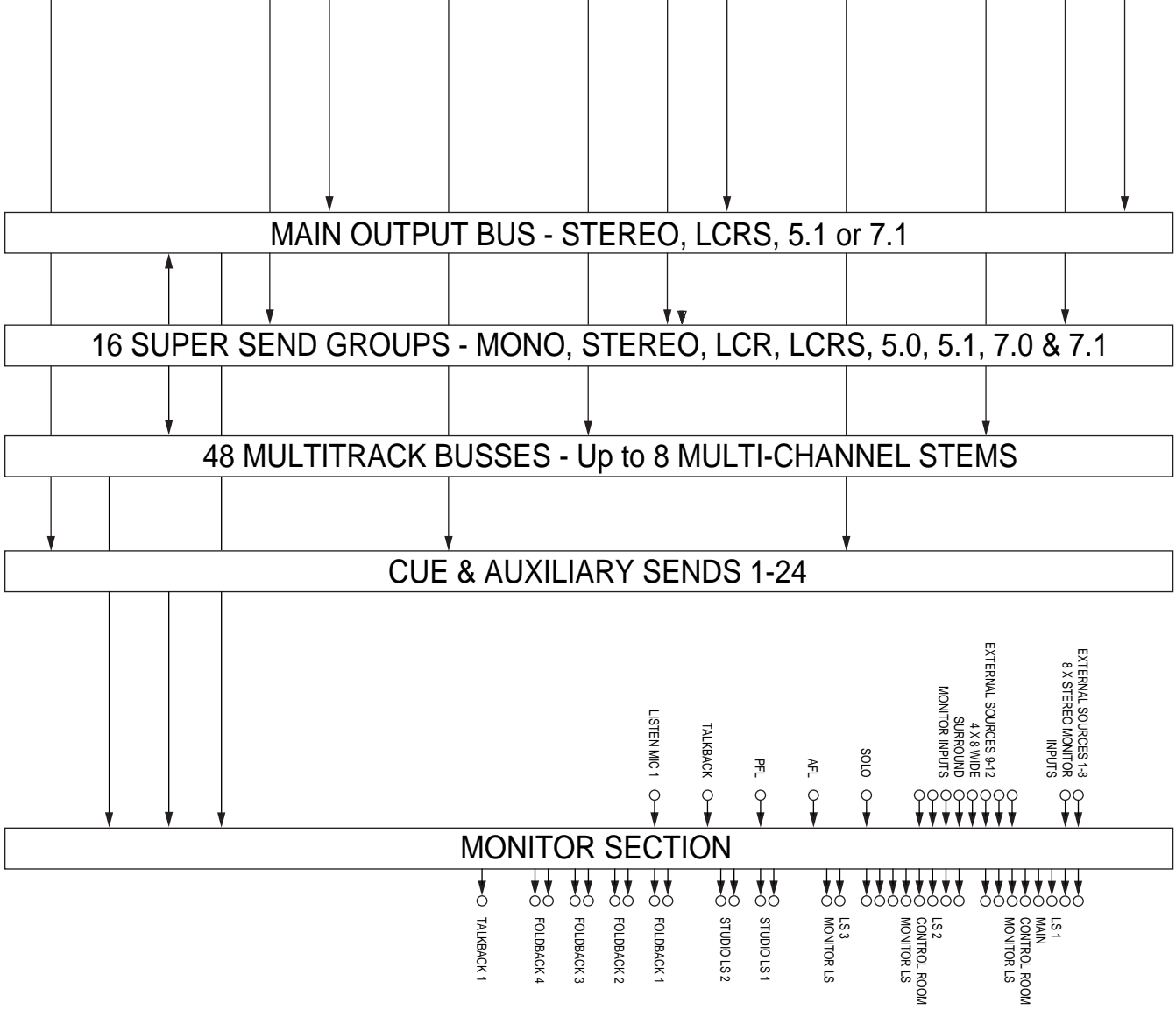

Chapter 2 – Powering The OXF-R3

This chapter provides step-by-step procedures for starting up the OXF-R3, including the power-up sequence and the booting of the Host Computer. It also includes the procedure for controlled shutdown of the OXF-R3.

Chapter 2 Contents

2-1 OXF-R3 Start-Up	2-2
2-1-1 Start-up Procedure	2-2
2-2 OXF-R3 Shutdown	2-4
2-2-1 Shutdown Procedure	2-4

2-1 OXF-R3 Start-Up

CAUTIONS:

1. Before starting-up the OXF-R3, check that all Monitor Loudspeaker Power Amps are turned off or muted.
2. Switch on equipment in the sequence given here, to ensure trouble-free start-up.

2-1-1 Start-Up Procedure

1. Check that the motionworker and Lynx Time Code Module are already switched on and running normally.
2. Switch on the power to the SP Rack.
3. Switch on the power to the Host Computer.
4. Switch on the power to the I/O Racks.

Note:

It is important that the I/O racks are switched on in the sequence of the Sync Clock wiring loop connected to the clock inputs of the I/O Racks.

5. The Host Computer performs its start-up and self-test routines. At the end of these routines, a triple chevron prompt >>> should be displayed on the monitor.
6. Type **b** then press **RETURN** to start the boot-up process for the OXF-R3 system.

Note:

If your Host Computer has been configured for Auto-boot (an option at set-up), the triple chevron prompt will not be displayed and boot-up will proceed automatically.

7. At the end of the boot-up procedure, the Login field will be displayed on the monitor.
8. Now switch on the power to the control panel. All 7 LCD screens will show activity as programs are downloaded from the Host Computer to the computers within the console. When downloading is completed, an 'X' is displayed in the centre of each screen.

9. Log in at the Host Computer. Note that the user name and password below are the system defaults.

Type **sm** (case-sensitive) then press **RETURN**.

Type in the password: **oxf-r3** (case-sensitive), then press **RETURN**.

Notes:

- 1 **oxf-r3** is the default password. This may be changed but its modification must be carried out with help from Sony personnel.
- 2 Login can be initiated while programs are still being downloaded from the Host Computer. It is not necessary to wait until all the console LCD screens are displaying 'X' in their centres.

10. Once logged-in, a window is displayed on the monitor of the Host Computer. Use the mouse to move the cursor into this window entitled STIF. Note that the window surround changes colour from green to red, to indicate that this is now the active window.

11. Check that the console LCD screens are all displaying 'X' before proceeding, then:

Type: **run_r3** (case-sensitive) then press **RETURN**.

12. Observe that the centre LCD screen in the console displays a summary of the processes being executed by the Host Computer which are displayed in greater detail on the monitor.
13. When the loading of the Netlist is complete, the centre screen of the console displays the OXF-R3 logo.
14. Switch-on is now complete, but wait until all controls on the control panel are initialised (indicated by their lighting up) before operating the system.

2-2 OXF-R3 Shutdown

CAUTION:

Turn off or mute all monitor amplifiers connected to the OXF-R3.

Unless the OXF-R3 is to remain switched off for a prolonged period, it will be more convenient to leave the Clock Synchronisation source running.

2-2-1 Shutdown Procedure

1. At the centre LCD screen on the OXF-R3 control surface, use the appropriate softkey to select SYSTEM.

Note:

If necessary, retrace a number of steps through the screens hierarchy to reach this point. Refer to the Screens Structure diagram in Chapter 5 for detailed information on the screen page hierarchy.

2. On the SYSTEM screen page, click on SYSTEM SHUTDOWN on the right side of the screen if it is displayed.
3. If SHUTDOWN is not displayed click on the 'User field' for a pop-up and click on ADMIN. Enter the admin password (default is **admin** in lower case) and click on OK. The field which includes SYSTEM SHUTDOWN will then appear in the right side of the screen. Click on it. A dialogue box will appear on the screen to request confirmation of Shutdown and ask if current work should be saved. Press **ENTER** on the Control Keyboard or click on OK.
4. The console now shuts down and power to the control surface can be turned off but the STIF and UNIX windows on the Host Computer monitor remain.
5. On the Host Computer, place the mouse cursor in the STIF window and

Type: **exit** (case-sensitive) then press **RETURN**.

Note:

It is important to switch off the power to the control surface for a minimum of 10 seconds before attempting a re-start.

6. For a re-boot, turn on the power to the control surface again and follow the Start-Up Procedure, in the previous section, from step 11. For a complete power-down, continue with step 7 in this section.

-
7. To shut down the Host Computer, place the cursor in the UNIX window, and

Type: **su** (case-sensitive) which stands for 'superuser', then press **RETURN**.

8. At the 'password' prompt:

Type the superuser password, **oxf-r3** (case sensitive) is the default, then press **RETURN**.

9. At the prompt which follows:

Type: **shutdown -h now** (case sensitive), then press **RETURN**.

10. Wait for the >>> prompt to appear before powering down the Host Computer, SP and I/O Racks.

Chapter 3 – Getting Started

This chapter gives an overview of the control surface layout and functionality. It also provides easy to follow, step-by-step procedures for basic operations of the console. These are designed to help the experienced operator become familiar with the OXF-R3 within a short period of time.

Chapter 3 Contents

3-1	The Control Surface	3-2
3-2	Fader Paging	3-8
3-3	Assignable Channel Processing	3-9
3-4	Input Channel, Equaliser and Filters	3-10
3-5	Free Assign Area and Dynamics	3-11
3-6	Multitrack, Routing for Multitrack, Super Send Groups and Multi-Format	3-12
3-7	Sends	3-13
3-8	Select To Faders	3-14
3-9	Select To Pans	3-17
3-10	Basic Console Operations	3-18
3-10-1	To Route a Mic or Line Input to the Main Output Bus ...	3-19
3-10-2	To Set Up a Super Send Group from Channel Inputs	3-20
3-10-3	To Send Signals to Tracks on Tape	3-21
3-10-4	To Monitor Signals to and from Tape	3-22
3-10-5	To Set Up a Stereo Headphone Mix for Foldback 1 O/P	3-23
3-10-6	To Equalise Signal Feeding the Multitrack	3-24
3-10-7	To Equalise Monitor Signal Post Multitrack	3-25
3-10-8	To Insert Dynamics Pre Multitrack Send	3-26
3-10-9	To Insert Dynamics Post Multitrack Return	3-27
3-10-10	To Bounce Tracks	3-28
3-10-11	To Set Up Super Send Groups from Multitrack	3-29
3-10-12	To Set Up a De-Esser Using Dynamics Side-Chain EQ..	3-30
3-10-13	To Link Compressor Side-Chains in a Group	3-31
3-10-14	To Link Compressor Side-Chains so that One Channel Controls a Second Channel	3-32

3-1 The Control Surface

The OXF-R3 comes in two configurations known as the 24-C-24 and the 24-C-0. The basic elements are illustrated below.

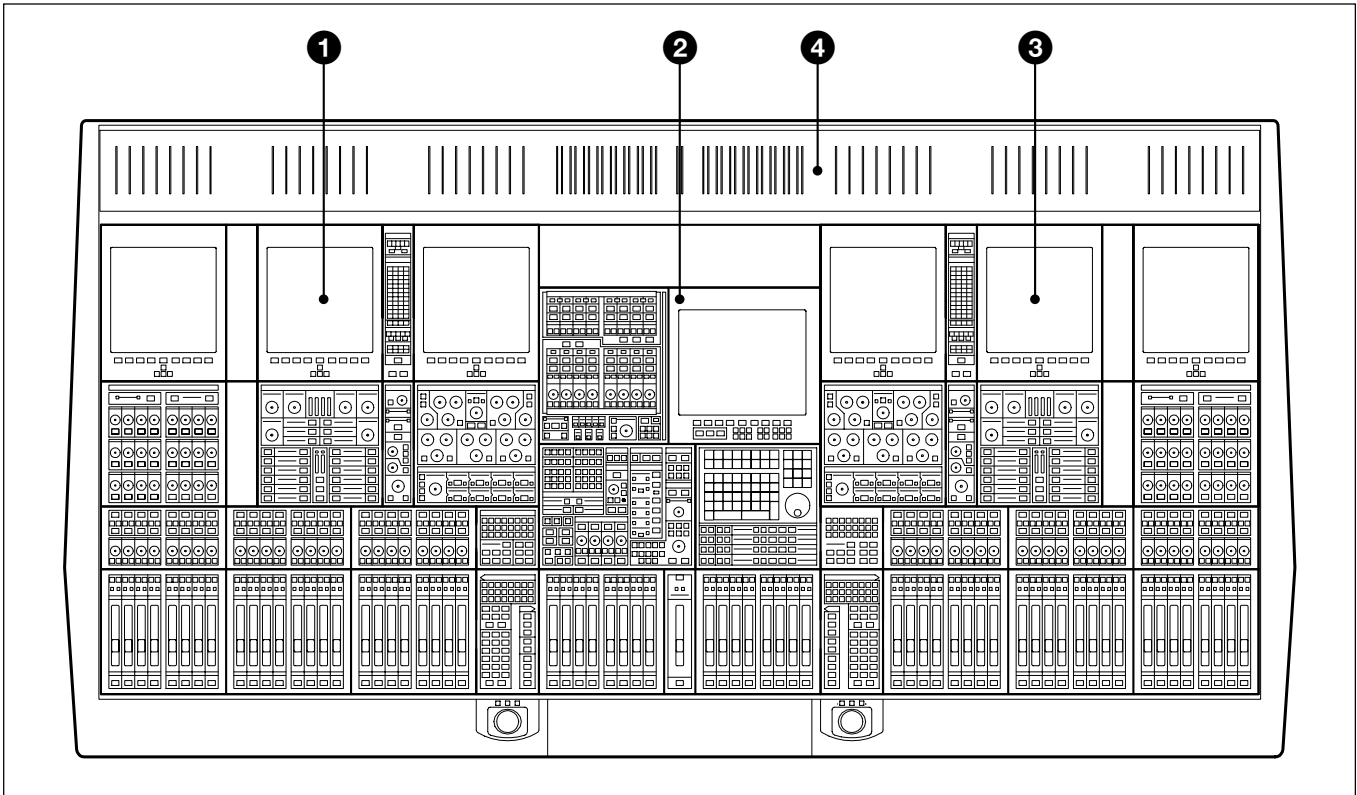

24-C-24 Control Surface Configuration

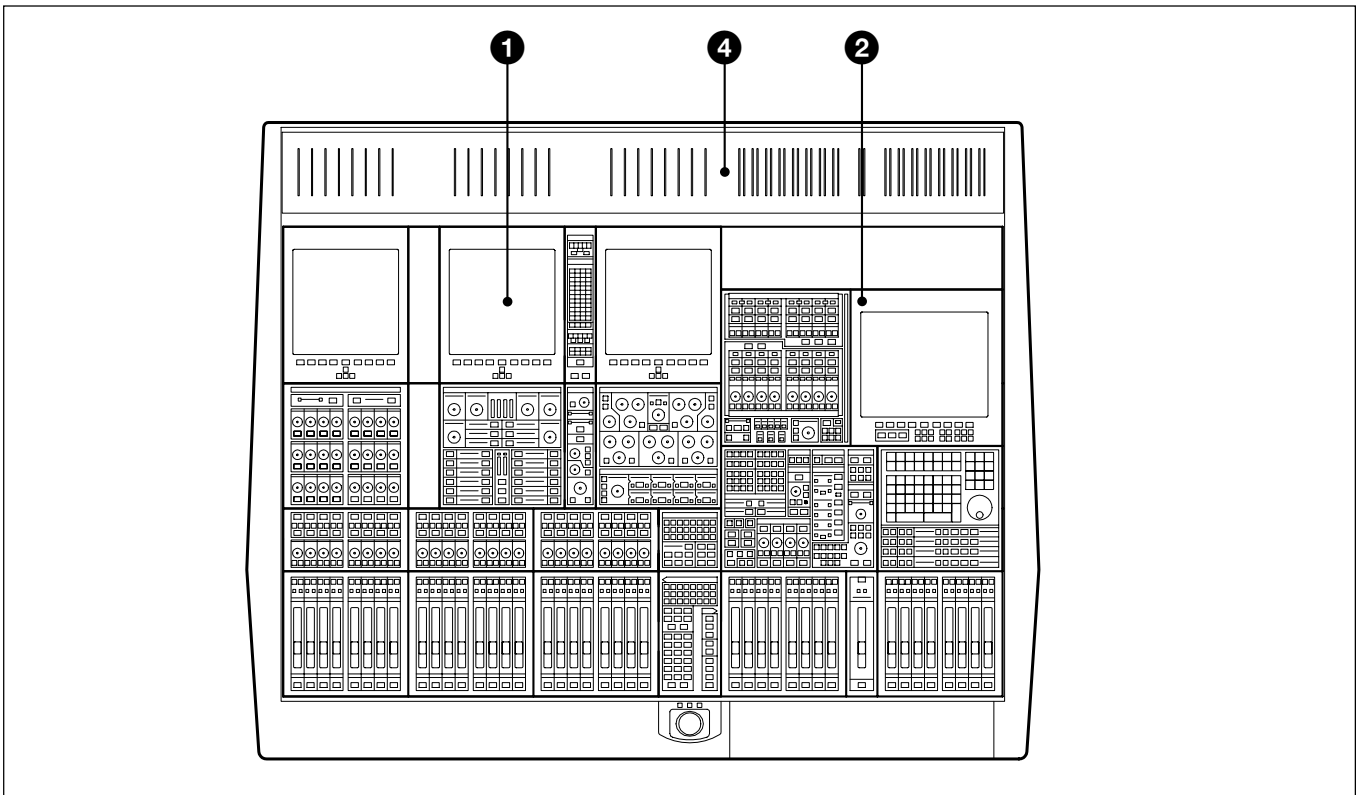

24-C-0 Control Surface Configuration

Control Surface Elements

- ❶ Left hand 24 Fader Channels Section
- ❷ Central Master Section
- ❸ Right hand 24 Fader Channels Section
- ❹ Meter Bridge

The Control Surface in general

A key feature of the OXF-R3 is its Assignable Panels, which divide further into four basic areas:

- **INPUT CHANNEL, EQUALISER and FILTERS**
- **FREE ASSIGN AREA & DYNAMICS**
- **MULTITRACK, ROUTING for MULTITRACK, SUPER SEND GROUPS and MULTI-FORMAT**
- **SENDS** (For Foldback and Effects feeds)

The channel section panel areas are mirrored so that every function can be operated from either side of the console, allowing two operators to work on the same channels simultaneously. The ability to have 48 channel faders and their related functions on view at all times is an advantage but everything can be operated from just one 24 fader channel bank and the centre section, as in the more compact 24-C-0 design.

Use the following two diagrams for reference to identify each area as it is explained whilst reading through this manual.

Operation of the control surface can be split into 5 main areas:

1. **USE OF FADER PAGING**
2. **USING ASSIGNABLE SIGNAL PROCESSING**
3. **SELECT TO FADERS FUNCTIONS**
4. **SELECT TO PANS FUNCTIONS**
5. **BUILDING SIGNAL PATHS**
(Described in detail in Chapter 4)

3-1 The Control Surface

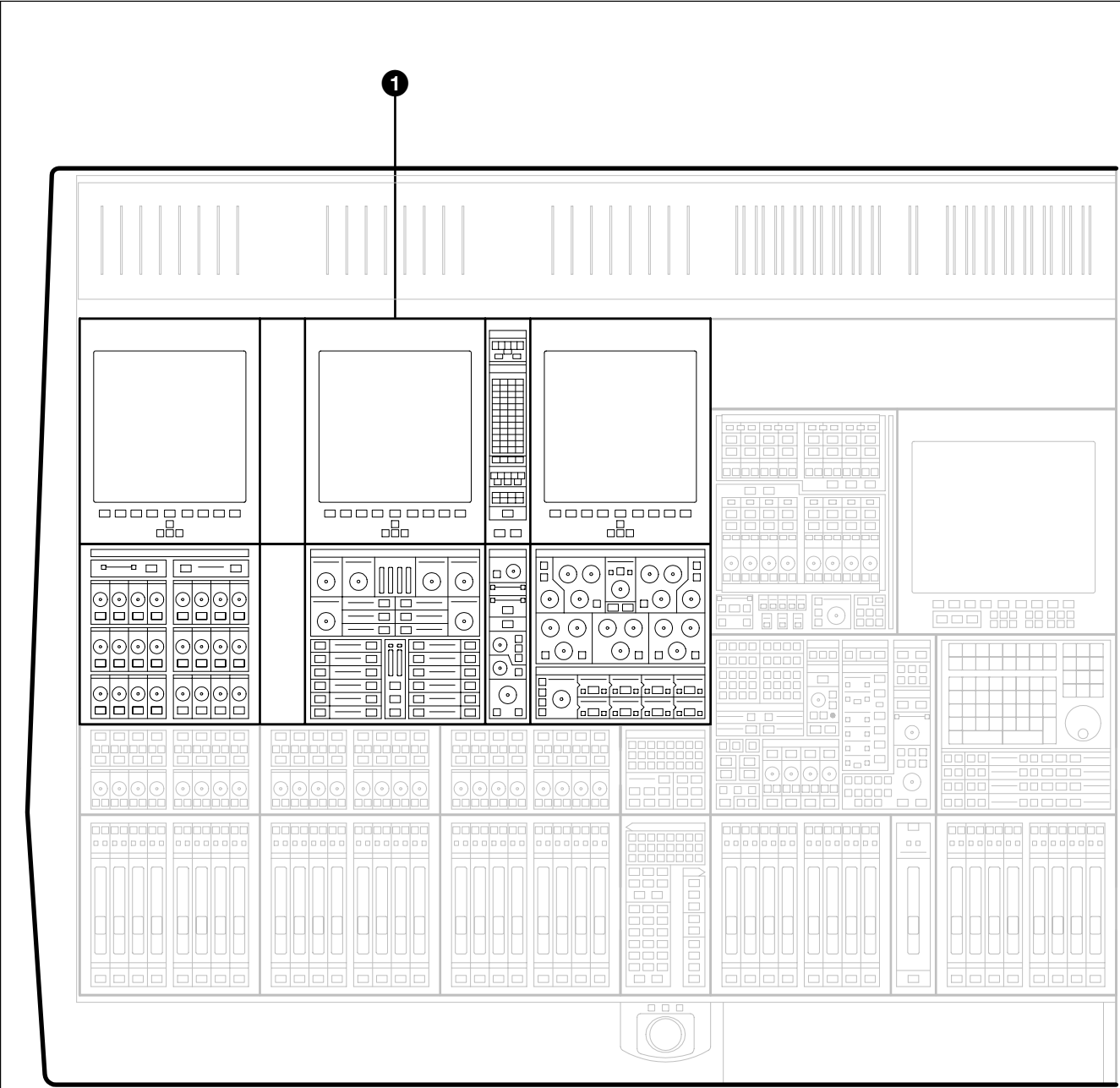

OXF-R3 Assignable Channel Areas

① Left hand assignable channel controls

② Right hand assignable channel controls

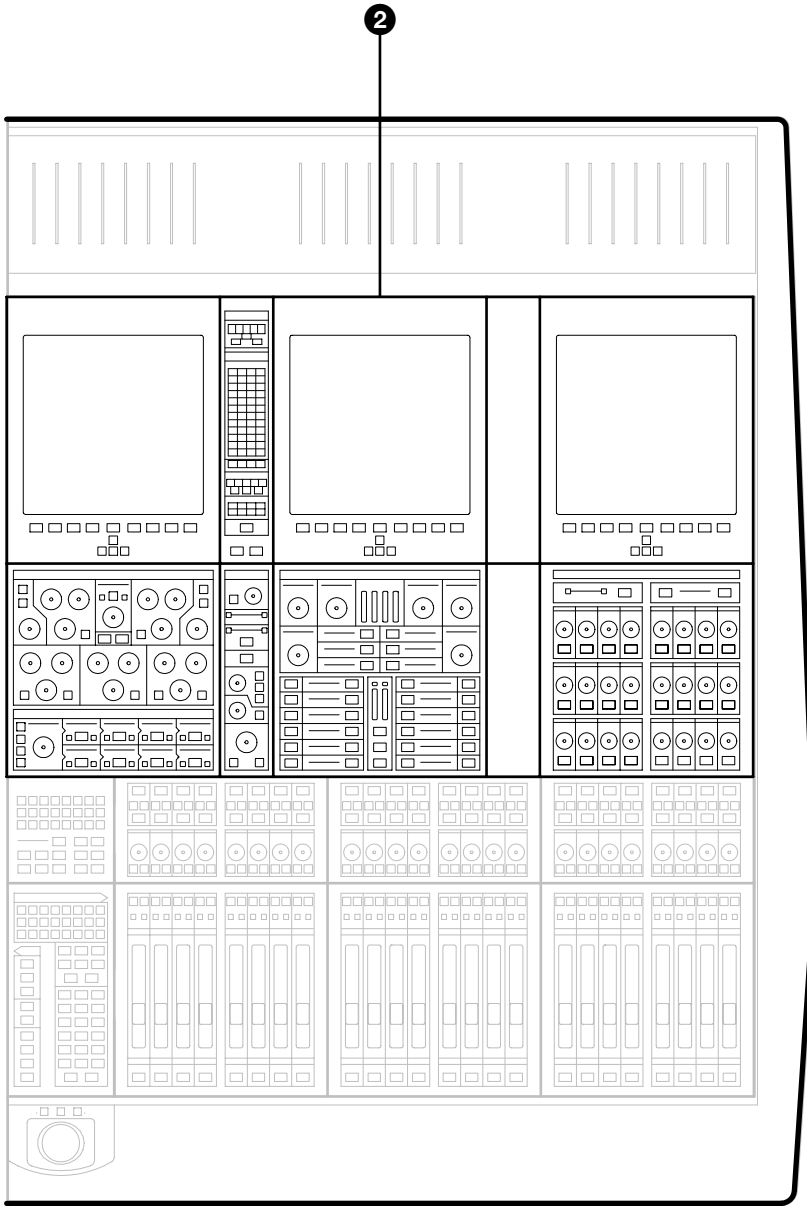

3-1 The Control Surface

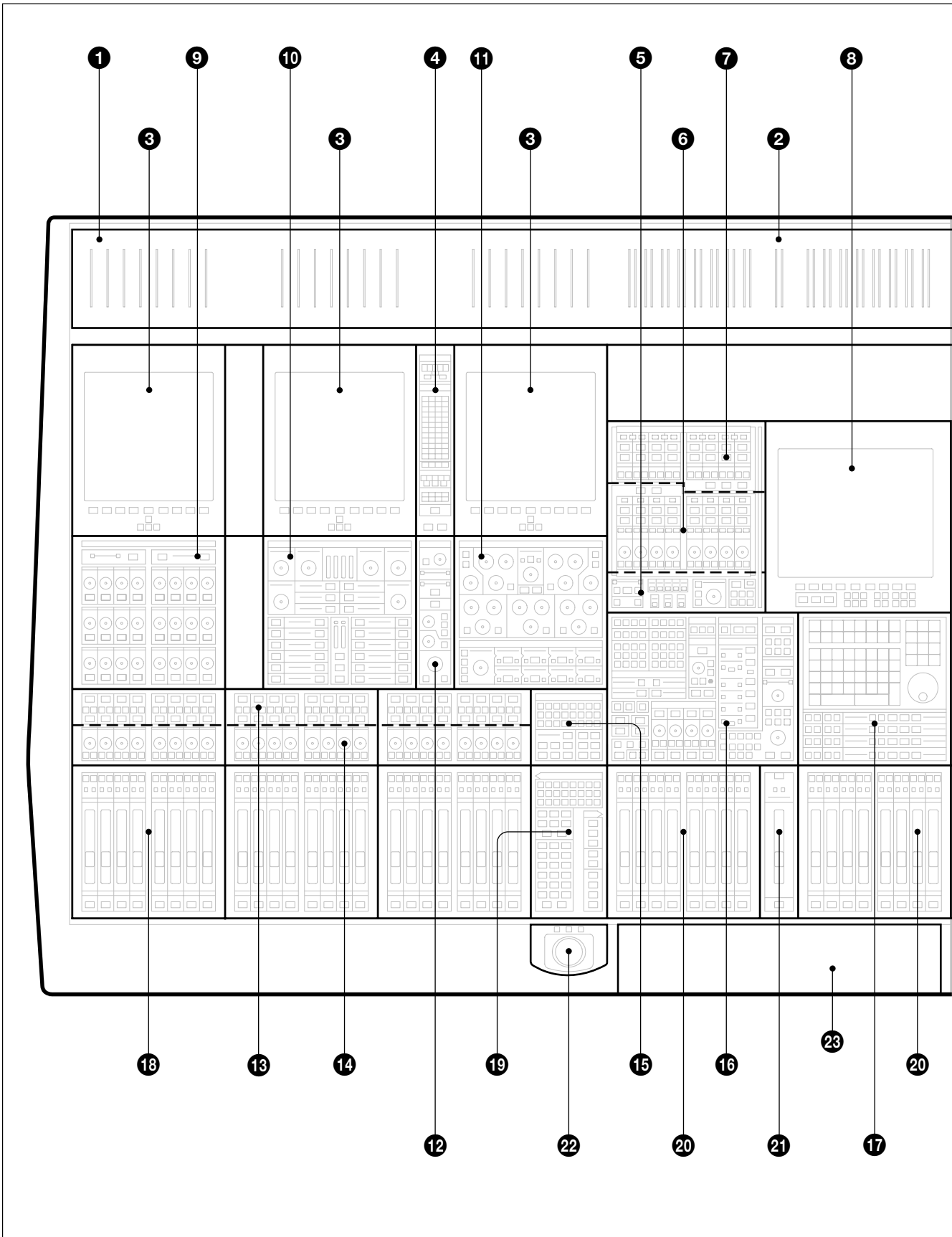

OXF-R3 panel locations

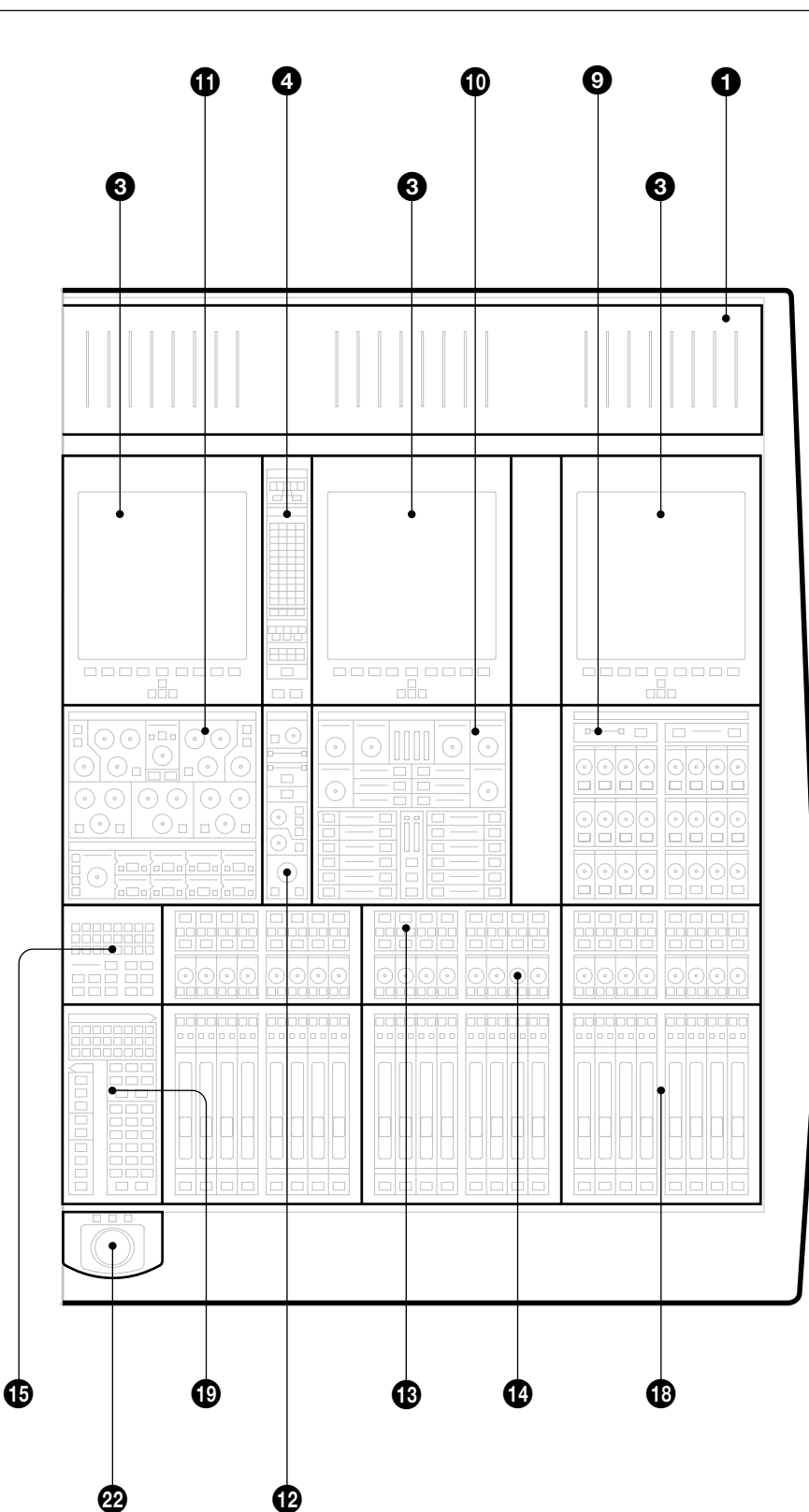

- ❶ Meter Bridge – Mono Meters
- ❷ Meter Bridge – Stereo Meters
- ❸ Channel Screens (6)
- ❹ Routing Panels
- ❺ Multi-Channel Set-up Panel
- ❻ Super Send Group Masters
- ❼ Sends Masters
- ❽ Central Control Screen
- ❾ Sends Panels
- ❿ Free Assign Area/Dynamics Panels
- ⓫ Input & Equaliser Panels
- ⓬ Multitrack Panels
- ⓭ Track Monitoring Controls
- ⓮ Assignable Pan Knobs
- ⓯ Select to Pans Panels
- ⓰ Monitor & Foldback Panel
- ⓱ Control Keyboard & Automation Controls
- ⓲ Assignable Channel Faders
- ⓳ Select to Faders Panels
- ⓴ Multi-Purpose Faders
- ⓵ Main Output Fader
- ⓶ Trackerballs
- ⓷ QWERTY Keyboard (beneath sliding cover)

3-2 Fader Paging

The OXF-R3 has 48 (or 24 on a 24-C-0) channel faders on its control surface but Fader Paging enables control of a much greater number of channels. Fader Paging allows banks of 24 channels to be selected on either side of the centre section at any time. The diagram illustrates how Fader Paging relates to a standard in-line console. Use the **SELECT TO FADERS** panel to select the fader bank required. Within that panel, there are a number of buttons marked CHS 1-24, CHS 25-48 and so on. There is a **SELECT TO FADERS** panel for each set of 24 channel faders, left and right of the centre section.

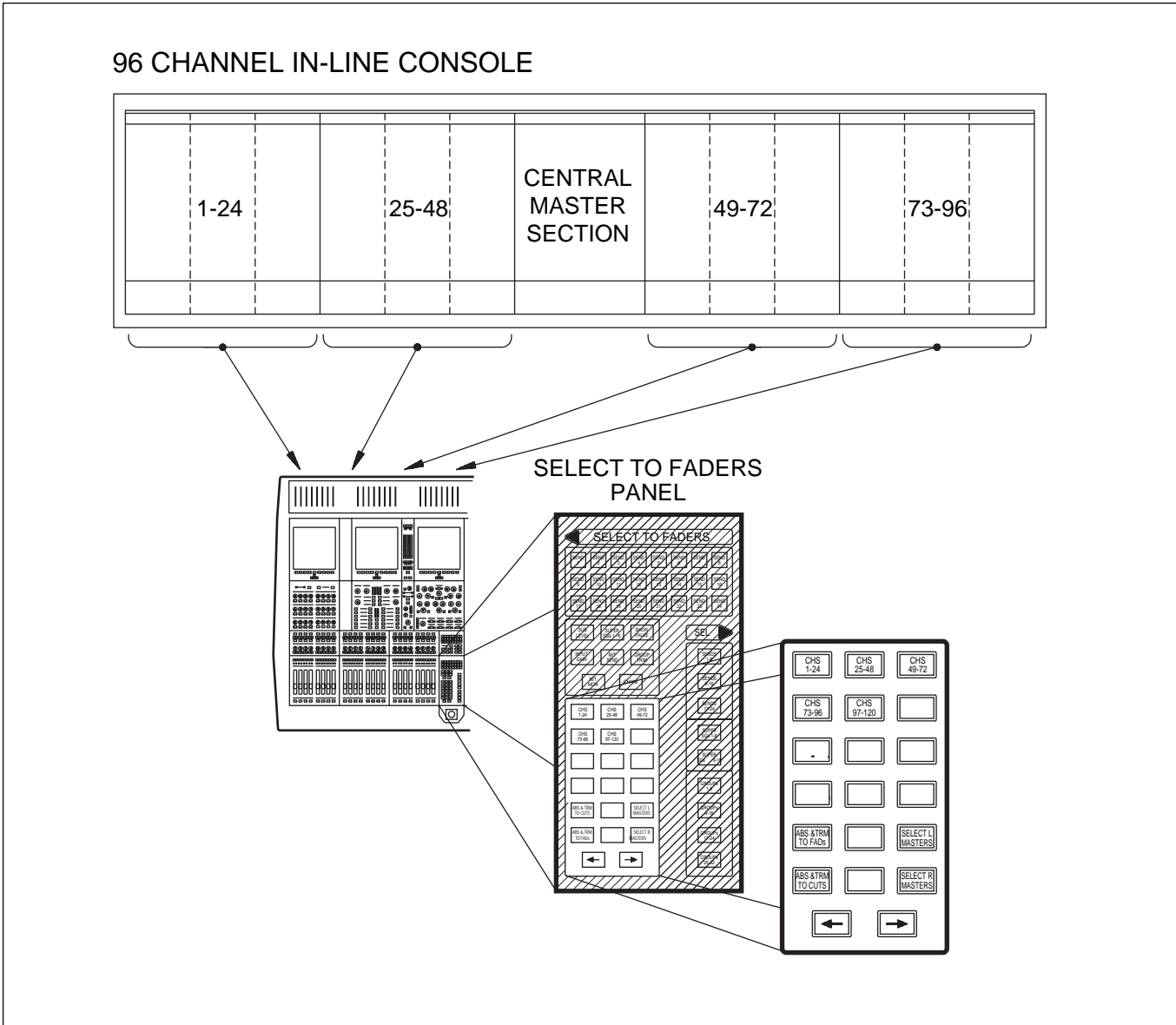

Paging of Faders for the left side of the control surface

3-3 Assignable Channel Processing

Once the appropriate bank of 24 channel faders is selected, individual channel controls can be adjusted. To do this, press the **ACCESS** button below the fader for the channel required. Then all the **ASSIGNABLE PANELS** belong to the channel, displaying its settings. Adjust as necessary.

As can be seen from the diagram, the functions on an in-line vertical channel strip become horizontal on the OXF-R3. In other words, the whole panel is equivalent to an exceptionally comprehensive channel strip. This is assigned to each channel individually, simply by pressing the appropriate channel **ACCESS** button.

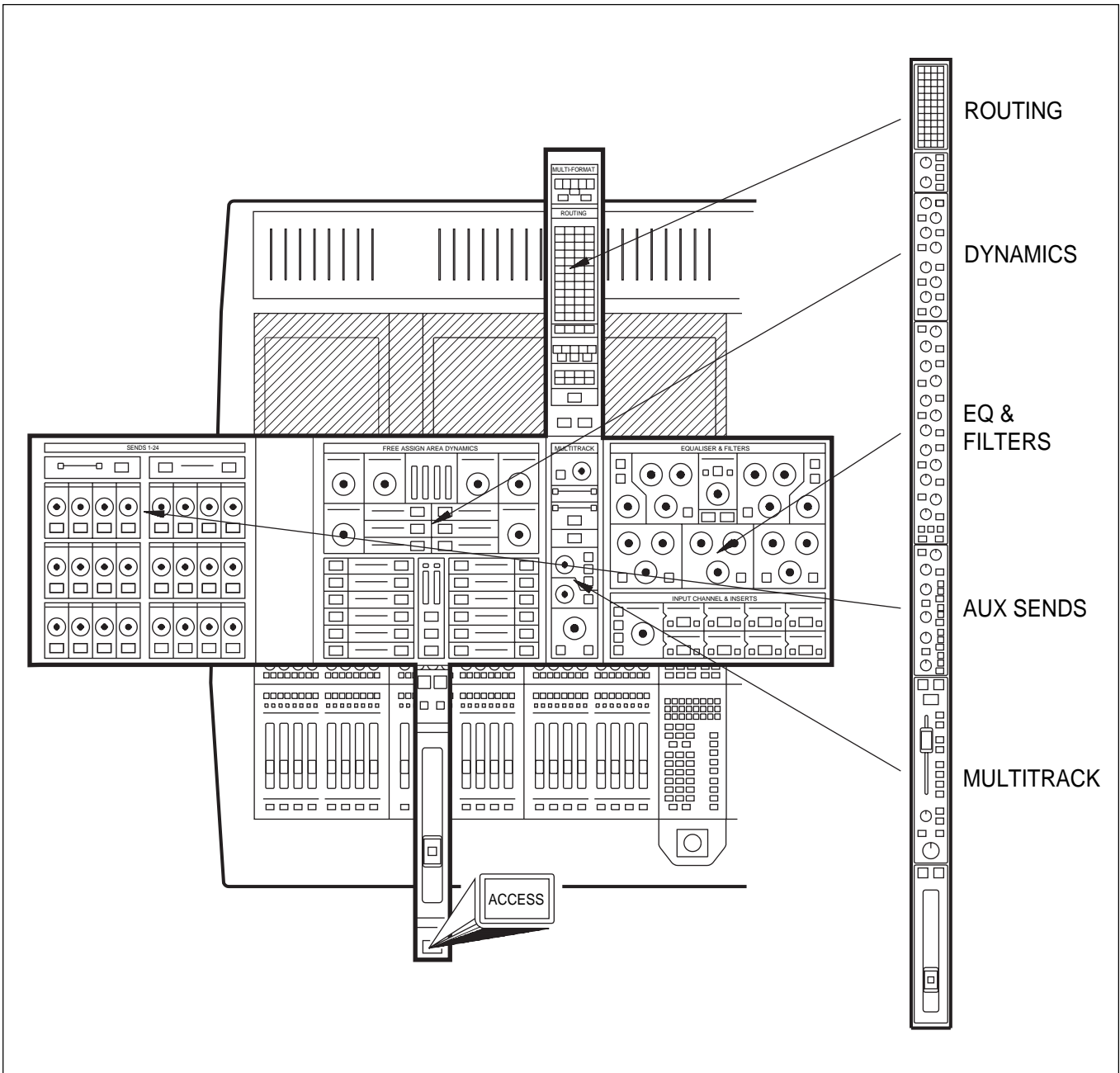

Assignable panels

3-4 Input Channel, Equaliser and Filters

The Input Channel section is much more flexible than a conventional in-line analogue channel strip in that it allows processing elements to be configured in almost any order. The eight boxes towards the bottom of the panel enable up to eight functions to be placed in each channel path with individual IN switches. The order of the processes can be totally different on every channel, as desired.

The 5 Band Equaliser and High & Low Filters sections are independent and can be assigned separately within the channel signal path. To view parameters and curves whenever EQ and Filters are in use, access the EQ page available on the channel screens.

Various EQ options are available which are selected using the **IN** and **+ / -** buttons situated in the upper middle section of the panel.

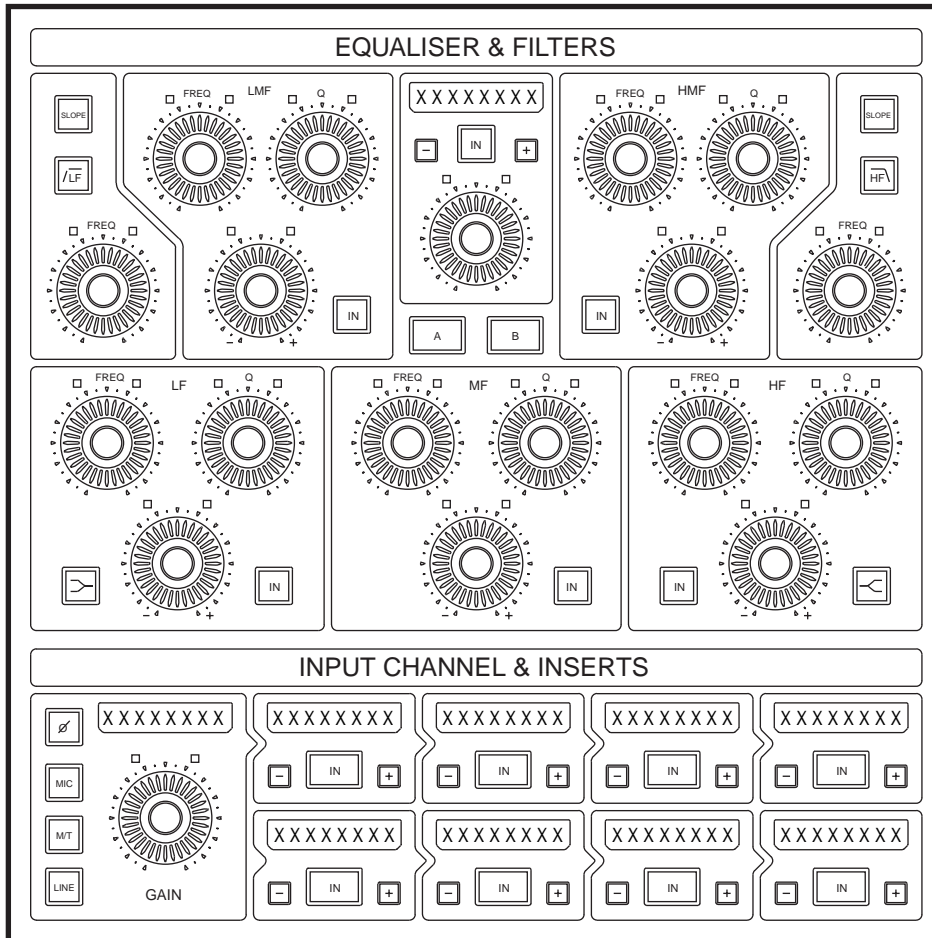

Input Channel & Inserts, Equaliser and Filters panel

3-5 Free Assign Area and Dynamics

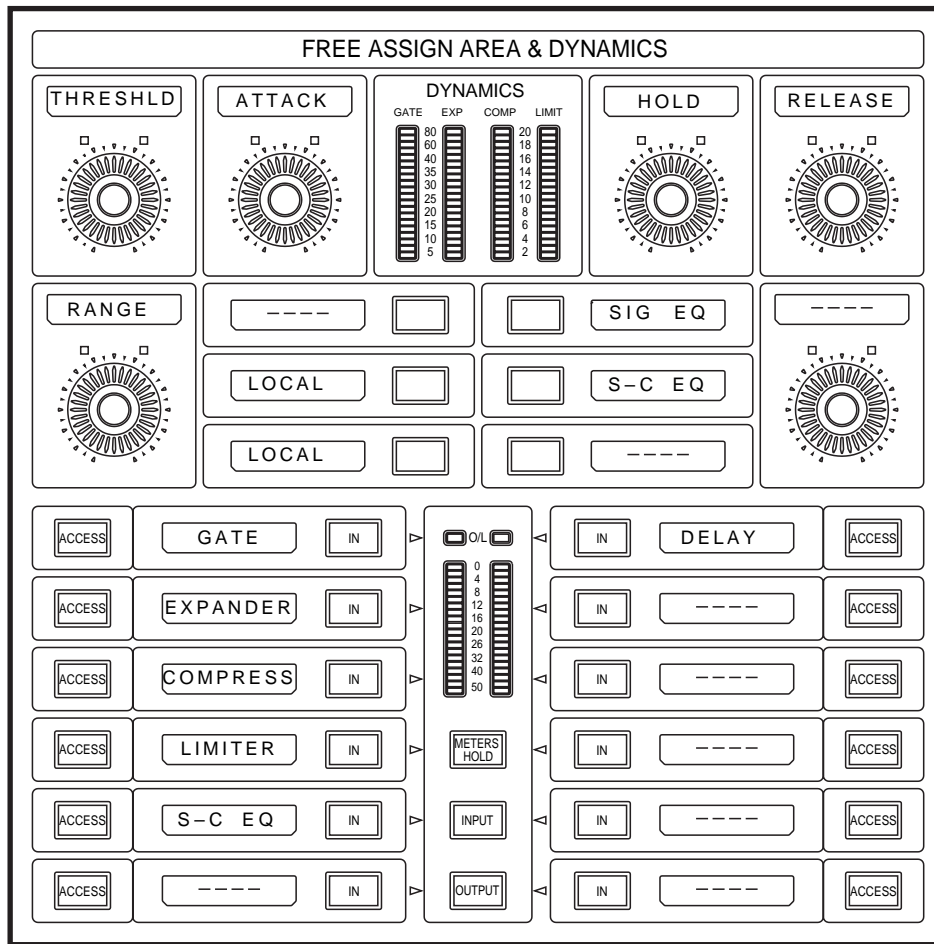

Free Assign Area & Dynamics panel

The Dynamics function area (lower left) contains:

- GATE
- EXPANDER
- COMPRESSOR (there are a number of Compressor options)
- LIMITER
- SIDE-CHAIN EQUALISER (S-C EQ).

Each section of the Dynamics has its own side-chain and allows very comprehensive control, equivalent to that of high specification units. All four side-chains operate on a single gain control element. The Side-Chain EQ is a fully parametric 2-band element which may be inserted in three ways:

- in the Dynamics Side-Chain only
- in the Signal Path only as a second EQ
- in the Signal Path and the Side-Chain.

The current Free Assign Area (lower right) contains:

- DELAY Effect

This area includes space for additional effects as and when software upgrades are introduced in the future.

3-6 Multitrack, Routing for Multitrack, Super Send Groups and Multi-Format

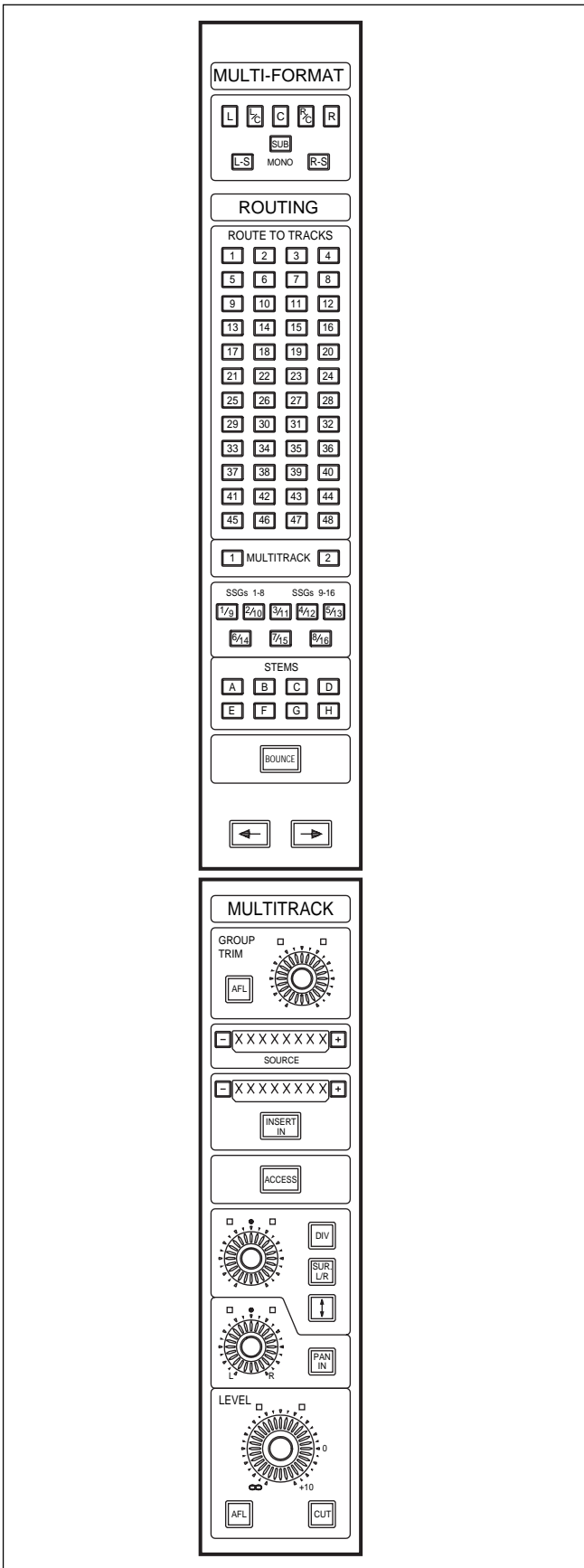

Routing for Multitrack, Super Send Groups & Multi-Format and Multitrack panels

MULTI-FORMAT Buttons

These routing buttons have a layout matching a set of 7.1 surround LS. Their function depends on what is selected to the faders at the SELECT TO FADERS panel. In other words, they set the destinations for the signals currently passing through the faders.

ROUTING Buttons 1-48, (GRP) & (DIR)

Two sets of buttons on each side of the console allow channel sources to be assigned to Multitrack Group Busses 1-48 ((GRP) - default) or Direct Outputs ((DIR)). The routing for 48 channels can be displayed simultaneously by showing 8 channels on each of the associated six channel screens, three per side. The screens display further channels automatically, consistent with fader paging.

SSGs 1-8 & SSGs 9-16

These buttons allow post channel fader and pan feeds to Super Send Groups 1-16. They are paged and legends lit depending on whether (SUPERSGs1-8) or (SUPERSGs9-16) is selected in the centre section.

STEM Selectors (A) - (H)

These buttons are operational in Multi-Format Mode to assign channel outputs to stems set up on the multitrack busses.

(BOUNCE) Push-Button

Redirects the output of a channel from the Main Output Bus to the multitrack routing buttons in the MULTITRACK section for bounce-down purposes. One of the stems A-H must be selected to bounce down a surround source or a signal with surround panning.

MULTITRACK

This panel contains controls related to the multitrack except individual track remotes and monitor switching. These are above the pan controls in line with their equivalent number channel faders. All level controls can be assigned to faders. Surround panning is available at this panel in parallel with the joysticks and individual pans above the faders. These pan controls are operational on what is selected to the faders at the SELECT TO FADERS panel.

The OXF-R3 allows the multitrack to be used 'in-line' for normal record/remix work or 'on-the-side' where a live mix requires a multitrack backup. A separate stereo monitor bus is included specifically for monitoring the multitrack when used in parallel with a live mix.

3-7 Sends

There are currently 24 mono Sends that can be linked as odd/even pairs, set up at the **SEND OUTPUTS 1-24** panel in the centre section, to provide up to 12 stereos. The levels to the busses can be set via the individual dedicated controls on the channels **SENDS 1-24** panels for each channel individually. Alternatively Sends can be assigned, one bus at a time, to the faders or assignable knobs (PANs). This allows a mix to an effect or foldback to be set up using the faders or a row of knobs on a console-wide basis. The source points for each Send can be set individually on each channel or on a console-wide basis.

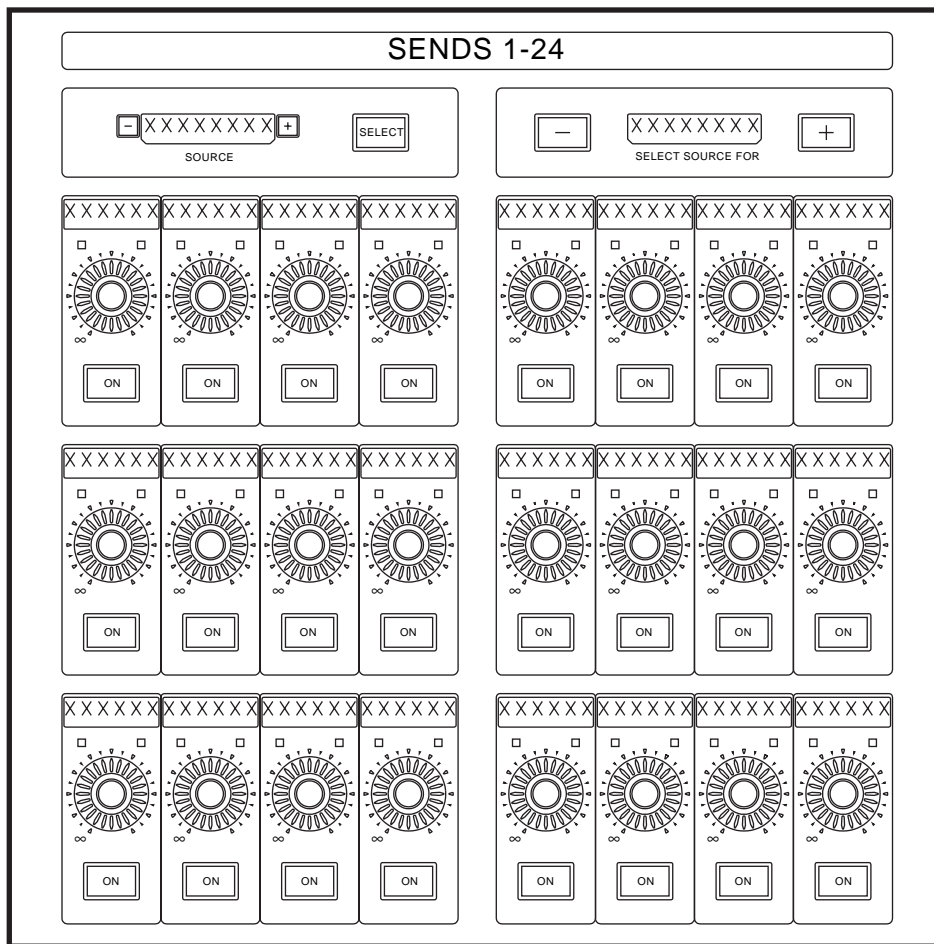

Sends 1-24 panel

3-8 Select To Faders

The main purpose of faders on a mixing console is to control the levels of the signals through the channels. Once a balance is achieved, the fader positions give an extremely useful graphical representation.

It is common with in-line analogue console channel strips to split the signal flow into channel and monitor paths with a fader for each. The OXF-R3 takes this concept a stage further, allowing all level and gain control to be accomplished using the faders. This is achieved by assigning the faders to all gain and level functions via the **SELECT TO FADERS** panel.

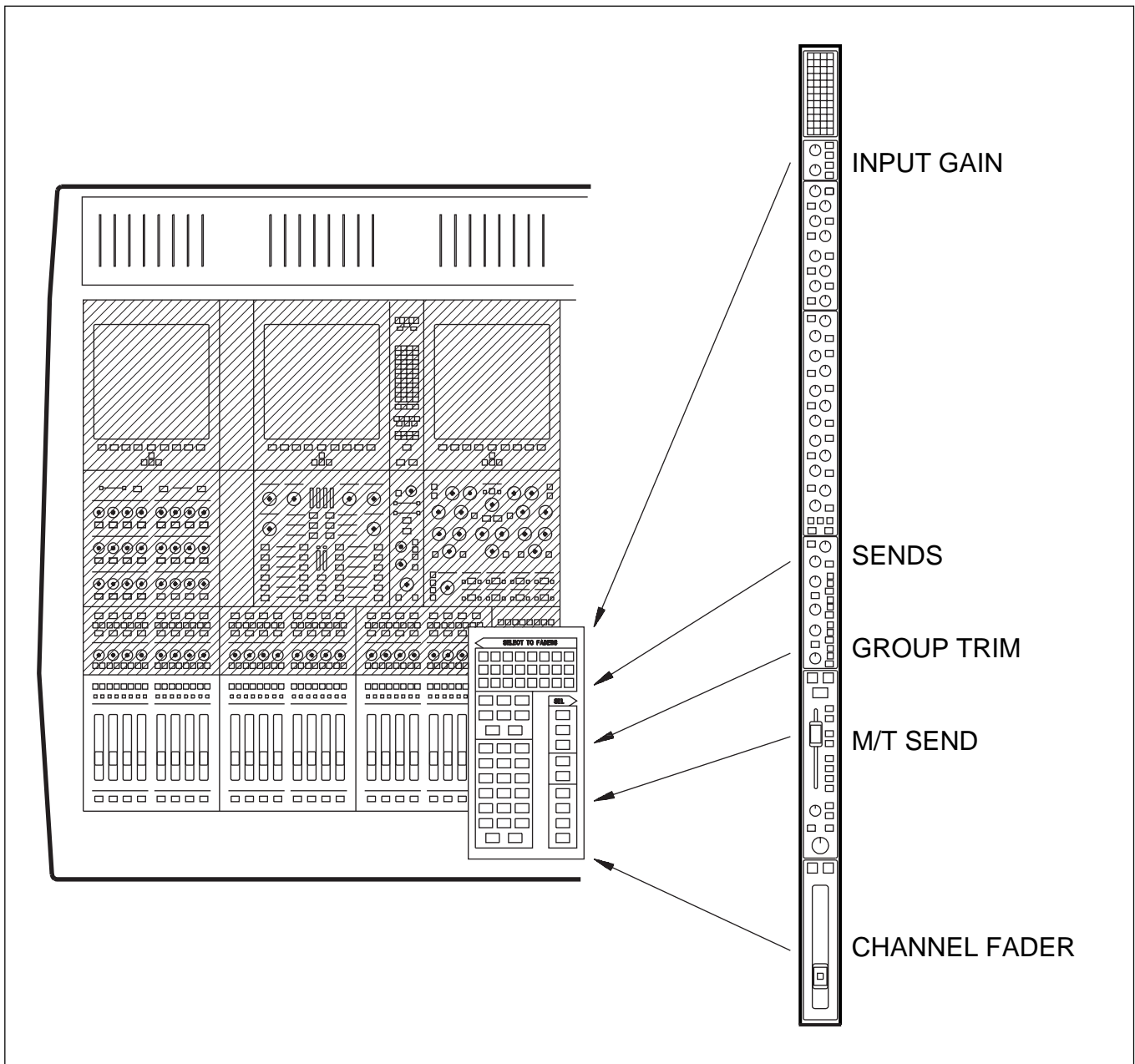

Select to Faders

As an example, on the SELECT TO FADERS panels, adjacent to the channel faders on either side of the centre section, there are buttons marked:

- 1 **CHANS**
- 2 **M/T SEND**

The default is **CHANS**, which assigns the faders to the channel outputs when they control the level to the Main Output Bus. Selecting **M/T SEND** is equivalent to selecting the ‘small fader’ function to the OXF-R3 faders. The combined use of Fader Paging and the Select to Faders functionality allows control of all channel level functions, using the 48 conveniently placed, high quality faders in the left and right channels sections.

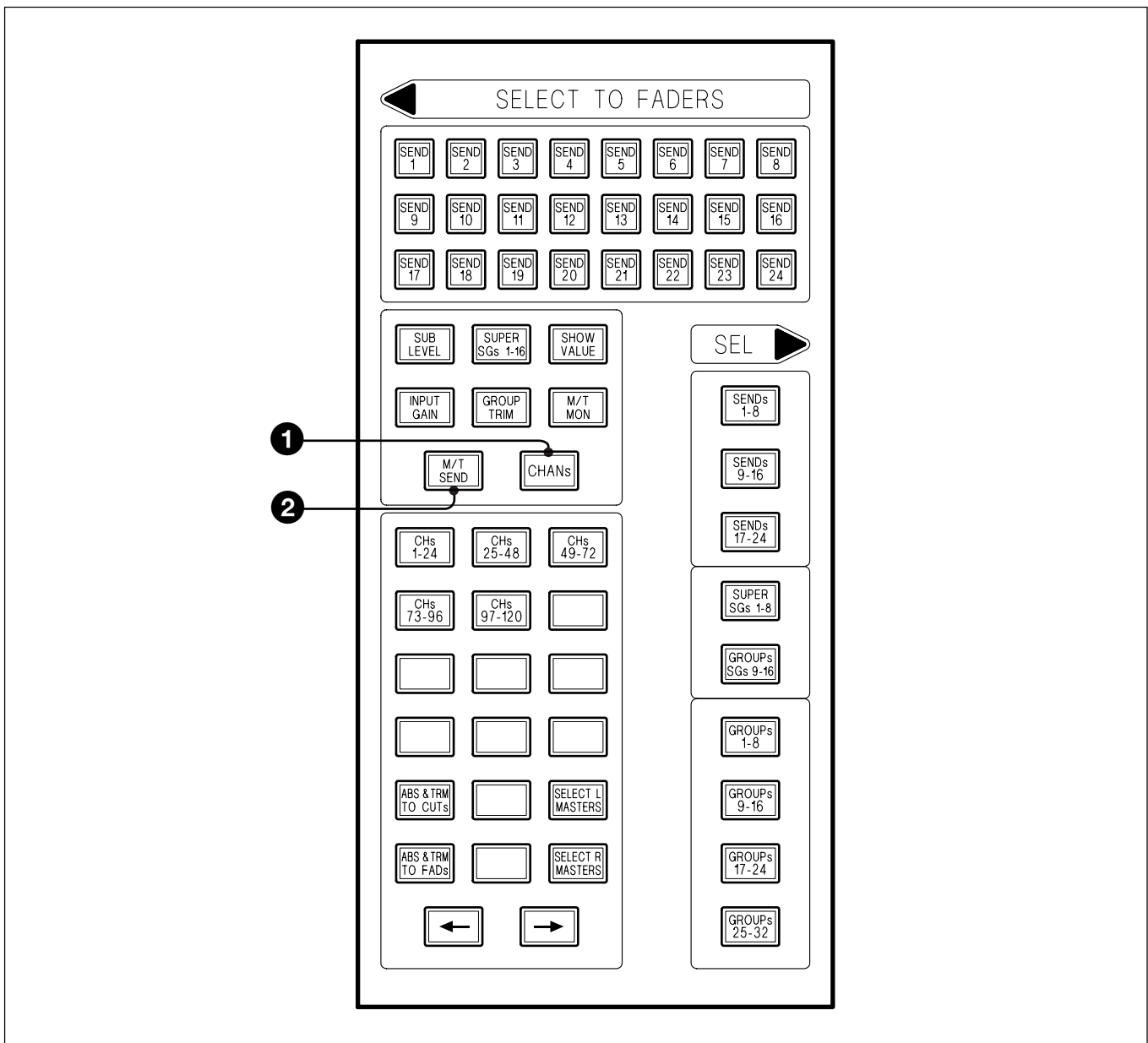

Select To Faders panel layout

3-8 Select To Faders

Exploiting this approach even further, the faders can also be assigned to control Input Gain, Group Trim and all Send Bus levels.

The Select to Faders diagram at the beginning of this section is a visual guide showing how the OXF-R3 accommodates conventional in-line channel strip level controls on its faders. Note that all level controls are still available in parallel within the assignable panels in a more conventional manner.

This approach is very convenient for checking foldback or effects send balances. The faders and their selector system are very close at hand, allowing any balance to be quickly checked at a glance and adjusted.

A copy function allows the user to take the balance set-up as the monitor mix and transfer it to any of the Send Bus mixes. The fader balance copy function applies to M/T Send Faders to Channel Faders and vice versa. This is described in detail in Chapter 6.

The 16 centre section master faders are also assignable in two groups of 8 faders. They are assigned via the **SEL** area on the **SELECT TO FADERS** panel and may control:

- **SENDS** (Send Master levels)
- **SUPER SGs** (Super Send Group master levels)
- **GROUPs** (VCA style control group masters)

3-9 Select To Pans

The Pan Knobs above the faders are assignable in a similar manner to the faders. Although their primary job is panning, they can also be used to perform all channel level adjustments, such as input gain settings and Send Bus levels. They are really Definable Knobs rather than just Pans.

As can be seen in the diagram below, the SELECT TO PANS panel performs a function for the Pans similar to that of the SELECT TO FADERS panel for the faders. All equivalent level and gain control functions, on an in-line channel strip, may be assigned to the row of Definable Knobs whose default setting is channel Pan.

A typical set-up could have Mic Gain controlled by the knobs, whilst the faders control the M/T Send. With this set-up, all levels are easily adjusted during tracking. Remember that dedicated knobs are always available on the assignable panel areas in parallel for all level controls.

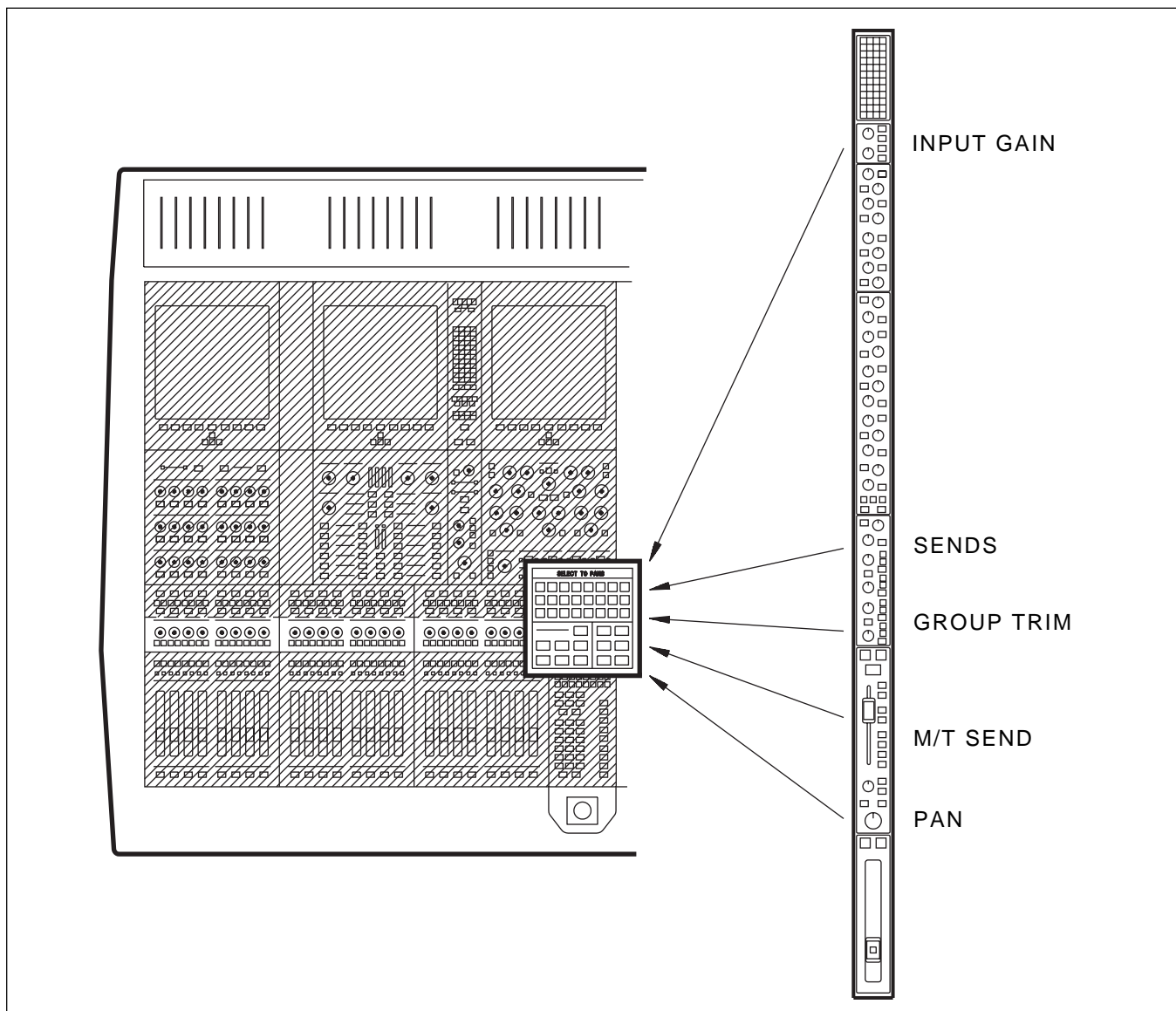

Select to Pans

3-10 Basic Console Operations

General

The following series of illustrations and brief step by step procedures are designed to allow new OXF-R3 operators to begin using the console in a very short space of time, without having detailed knowledge of the system.

System Set-up

The examples shown assume that signal sources, such as microphones, line level signals and multitrack or hard disc recorder, are already connected and routed to appropriate inputs, with machine control in place. They also assume that the control room monitor LS are hooked up to the OXF-R3 system.

Main Bus Set-up

The Main Output Bus can be set for the following 'widths': Stereo, LCRS, 5.1 and 7.1. For the purposes of the examples, the fire-up default of Stereo will be assumed.

3-10-1 To Route a Mic or Line Input to the Main Output Bus

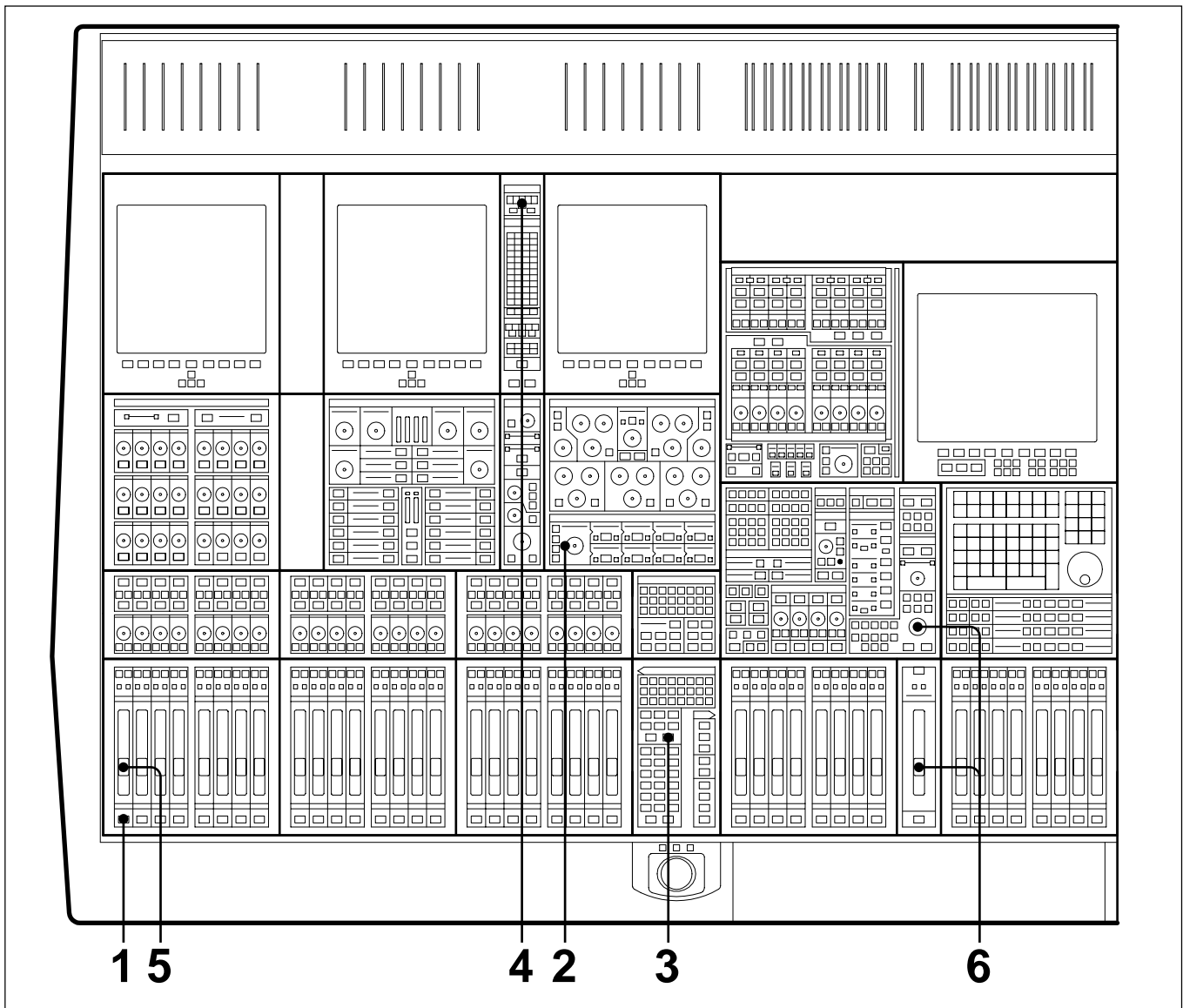

- 1** Press **ACCESS** for the desired Channel.
- 2** At the Input Channel & Inserts panel, press either **MIC** or **LINE** as required, and set the input **GAIN** knob to a suitable setting.
- 3** Make sure **CHANS** is selected on the Select To Faders panel (fire-up default).
- 4** At the Routing panel, select **L** and **R** (fire-up default) if not already lit.
- 5** Adjust the level to the Main Output Bus with the Channel Fader.
- 6** Open the Main Fader and turn up the CR Monitor level.

3-10 Basic Console Operations

3-10-2 To Set Up a Super Send Group from Channel Inputs

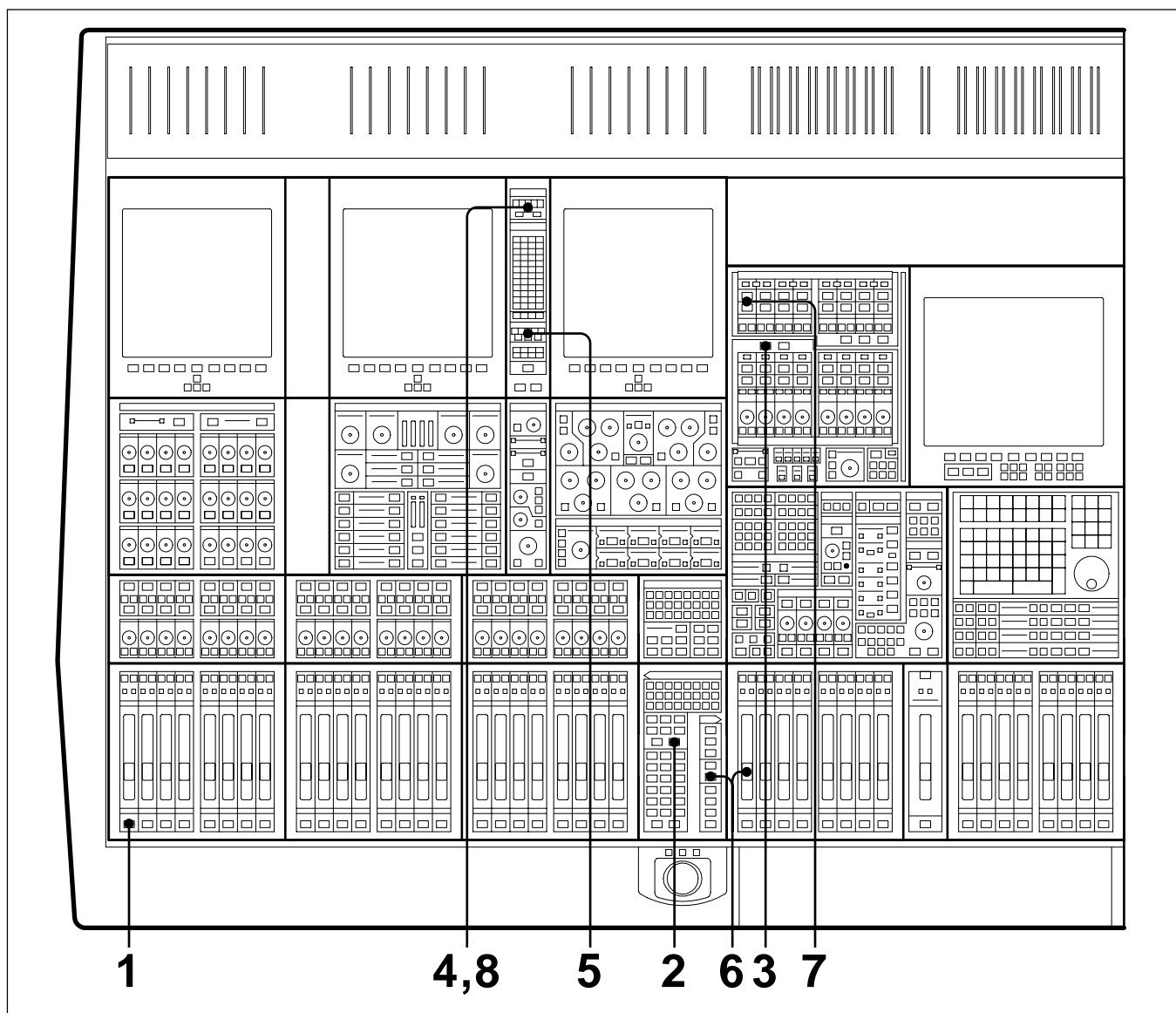

- 1 Press **ACCESS** for the first Channel to be routed to a Super Send Group (SSG).
- 2 Make sure **CHANS** is selected on the Select To Faders panel (fire-up default).
- 3 Make sure **SUPER SGs 1-8** is selected in the SSG masters section.
- 4 At the Routing panel, de-select **L** and **R**.
- 5 At the same panel, select the SSGs required, **1/9** and **2/10** in this case.
- 6 At the Select To Faders panel (SEL section), select **SUPER SGs 1-8**, then adjust the Fader to 0dB in the Central Faders panel.
- 7 Above the SSG 1 level knob select **MAIN** and its **ACCESS**.
- 8 At the top of the Routing panel select **L**.
- 9 Repeat steps 7 and 8 for SSG 2 but select **R** at the Routing panel.
- 10 Repeat steps 1 to 5 for further channels.

3-10-3 To Send Signals to Tracks on Tape

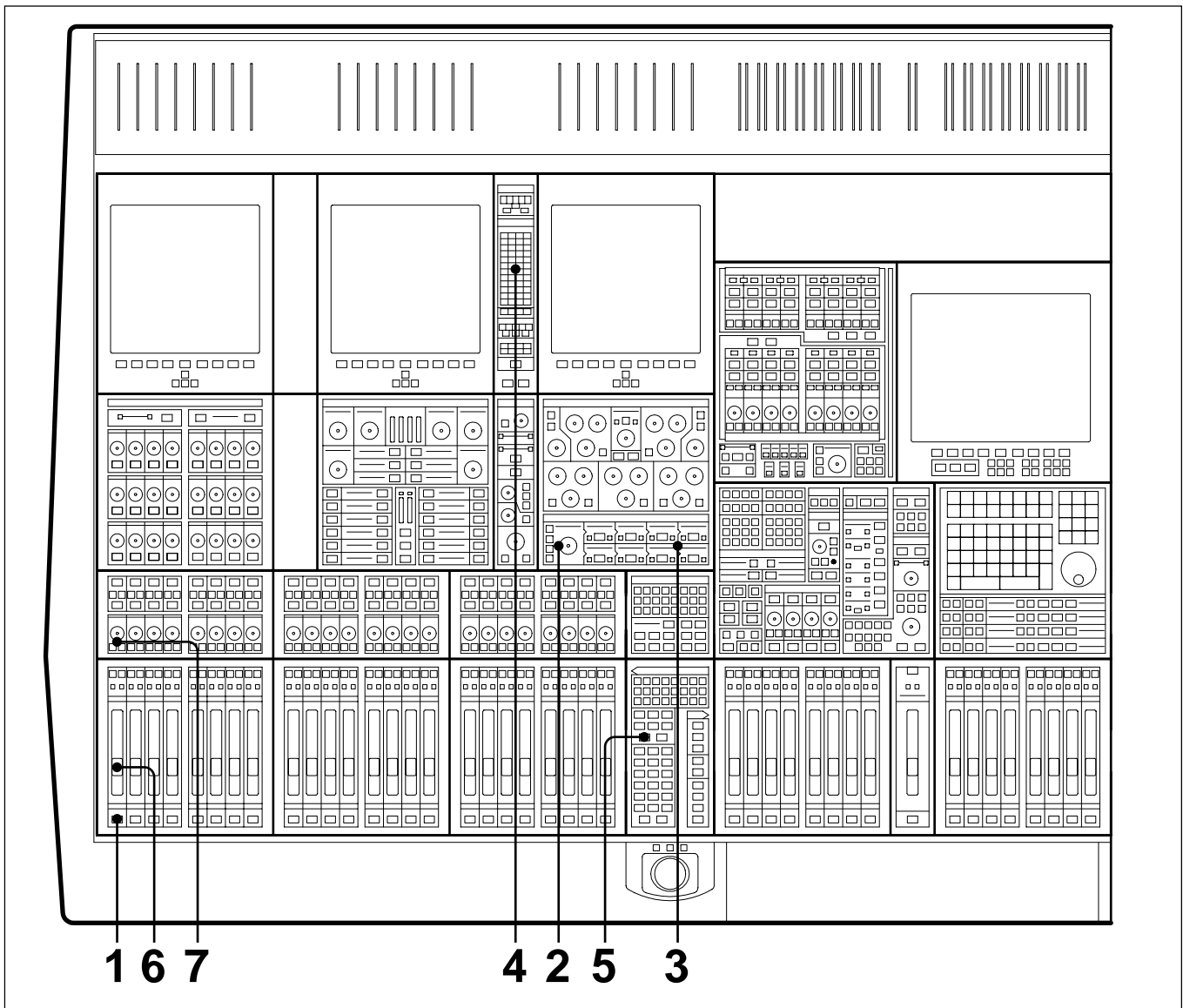

- 1** Press **ACCESS** for the desired Channel.
- 2** At the Input Channel & Inserts panel, press either **MIC** or **LINE** as required, and set the input **GAIN** knob to a suitable setting.
- 3** At the same panel, select 'MULTI' in one of the eight windows. Do this using the **+** and **-** buttons, and then press the large **IN** button.
- 4** At the Routing panel, select the tracks required in the **ROUTE TO TRACKS** section. The Pan works across odd and even numbers in Stereo.
- 5** To pan between tracks, press **CUT**, if it is lit which sets the pan into operation, and adjust the Pan Knob accordingly.
- 6** On the Select To Faders panel, press **M/T SEND**.
- 7** Adjust the level to tape using the Fader. Check the meter level for the track to which the signal is routed.

3-10 Basic Console Operations

3-10-4 To Monitor Signals To and From Tape

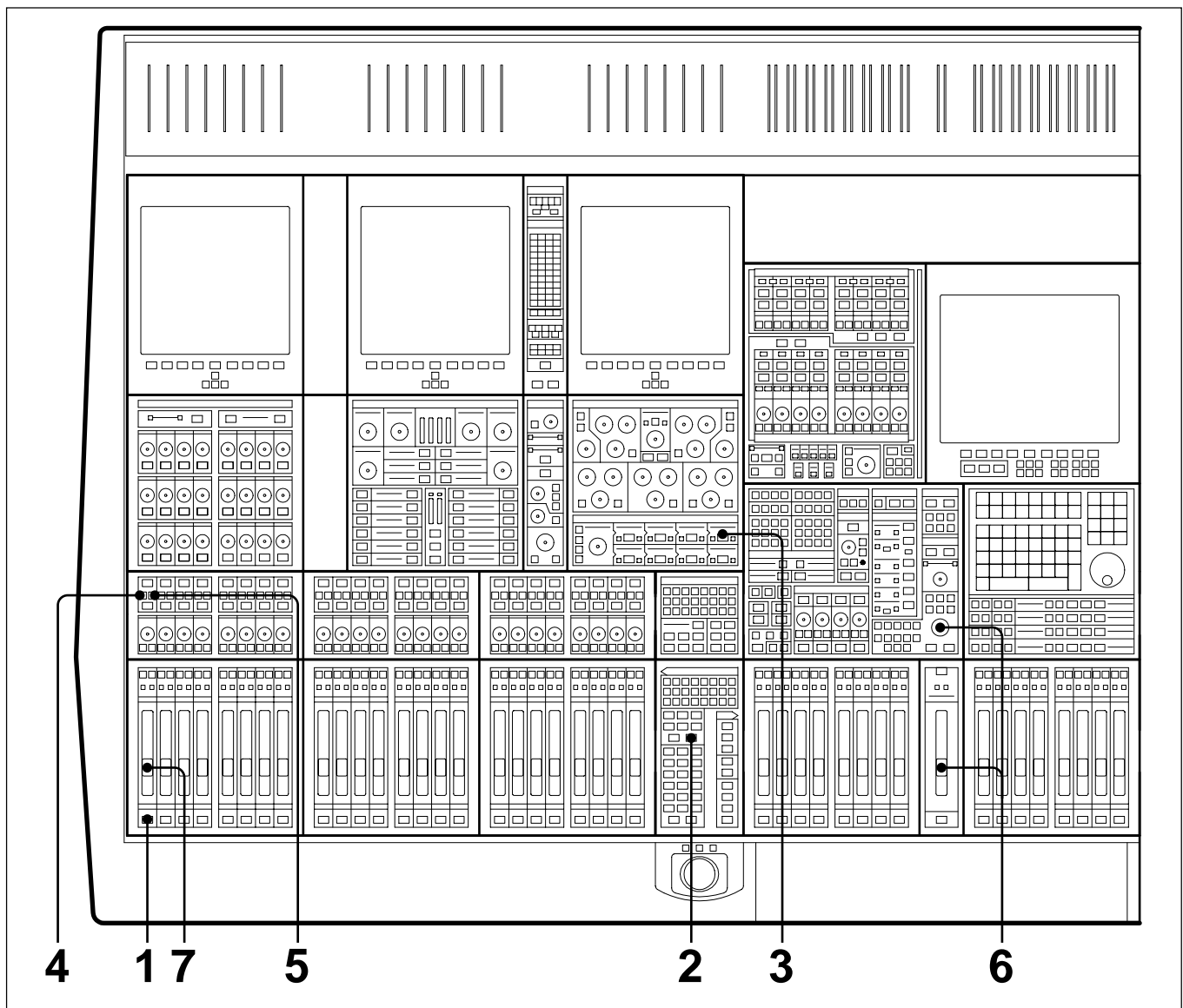

- 1 Press **ACCESS** for the desired Channel.
- 2 Select **CHANS** on the Select To Faders panel (fire-up default).
- 3 At the Input Channel & Inserts panel, select 'MULTI' in window number 4 using the **+** and **-** buttons either side. Select its large **IN** button to insert the multitrack into the signal path.
- 4 At the Pans panel, press **SEND** to select the signal being fed to tape
- 5 Or press **SEND** to select the signal from tape.
- 6 Open the Main Fader and turn up the CR Monitor level.
- 7 Use the Channel Fader to adjust monitor level via the Main Output Bus.

3-10-5 To Set Up a Stereo Headphone Mix for Foldback 1 O/P

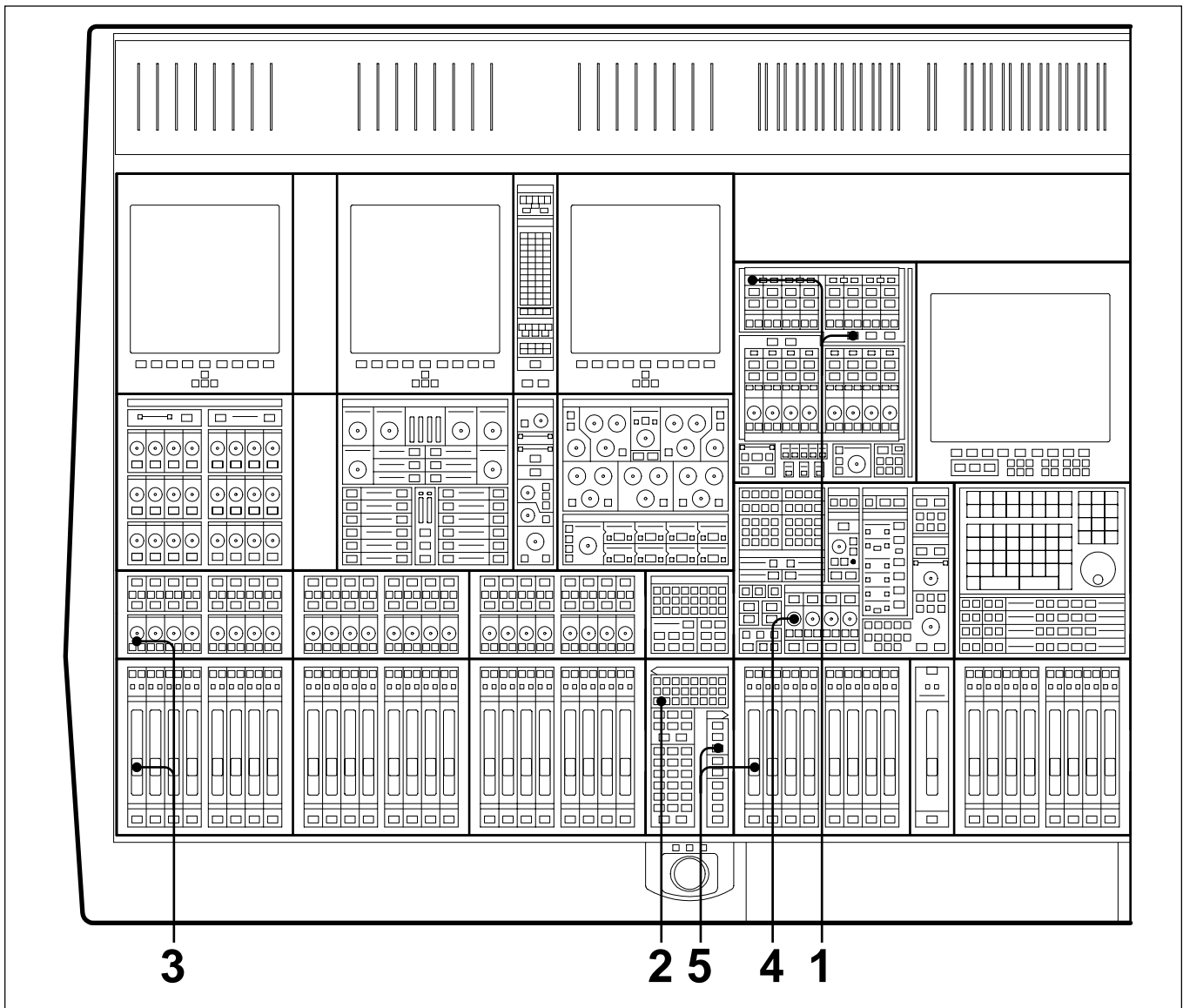

- 1 At the Send Outputs 1-24 panel in the console centre section, select **[17-24]** and then select **[STEREO]** between Send Masters 17 and 18. Sends 17 and 18 are a dedicated assignment to Stereo Foldback 1. Select **[AFL]** to audition the balance.

Note:

Send Masters 19 and 20 are assigned to Stereo Foldback O/P 2; 21 and 22 to Foldback 3; 23 and 24 to Foldback 4.

- 2 At the Select To Faders panel, select **[SEND 17]** or **[SEND 18]**. Pressing either will light both.
- 3 Turn off the **[CUT]** buttons and set up the balance and pan positions using the Faders and their Pans. Turn off the Pan **[CUT]** if necessary.
- 4 At the Foldback Groups 1-4 section, located in the central Monitor panel, adjust the LEVEL pot for a suitable level in the headphones. (Make sure **[CUT]** is not lit) Use the **[T/B F/Back 1]** button to talk to the artist(s).
- 5 The bus level itself, which defaults to unity gain, can be adjusted using the central faders. On the Select To Faders panel, SEL section, select **[SENDS 17-24]** and adjust Fader 17 or 18.

3-10-6 To Equalise Signal Feeding the Multitrack

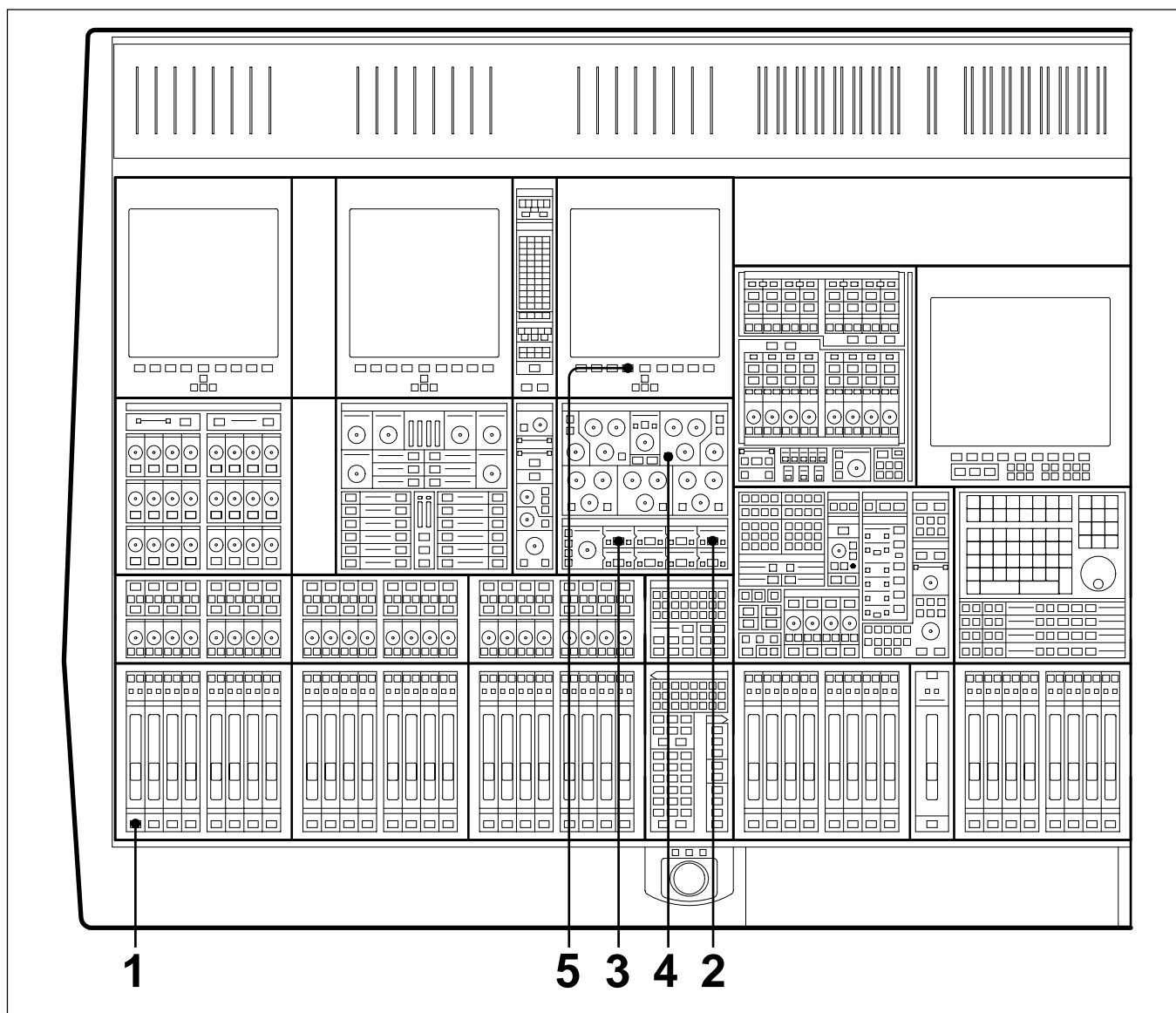

- 1 Press **ACCESS** for the desired Channel.
- 2 At the Input Channel & Inserts panel, select 'MULTI' in window number 4 using the **+** and **-** buttons either side. Select its large **IN** button to insert the multitrack into the signal path.
- 3 At the same panel, select 'EQ' in a window before window 4, window 1 for example, and select the large **IN** button to insert the equaliser into the signal path before the multitrack.
- 4 On the upper section of the same panel, select the individual **IN** buttons for the bands required and adjust as necessary.
- 5 Select the EQ softkey for the screen above the equaliser panel to view the parameters and response curve graph.

3-10-7 To Equalise Monitor Signal Post Multitrack

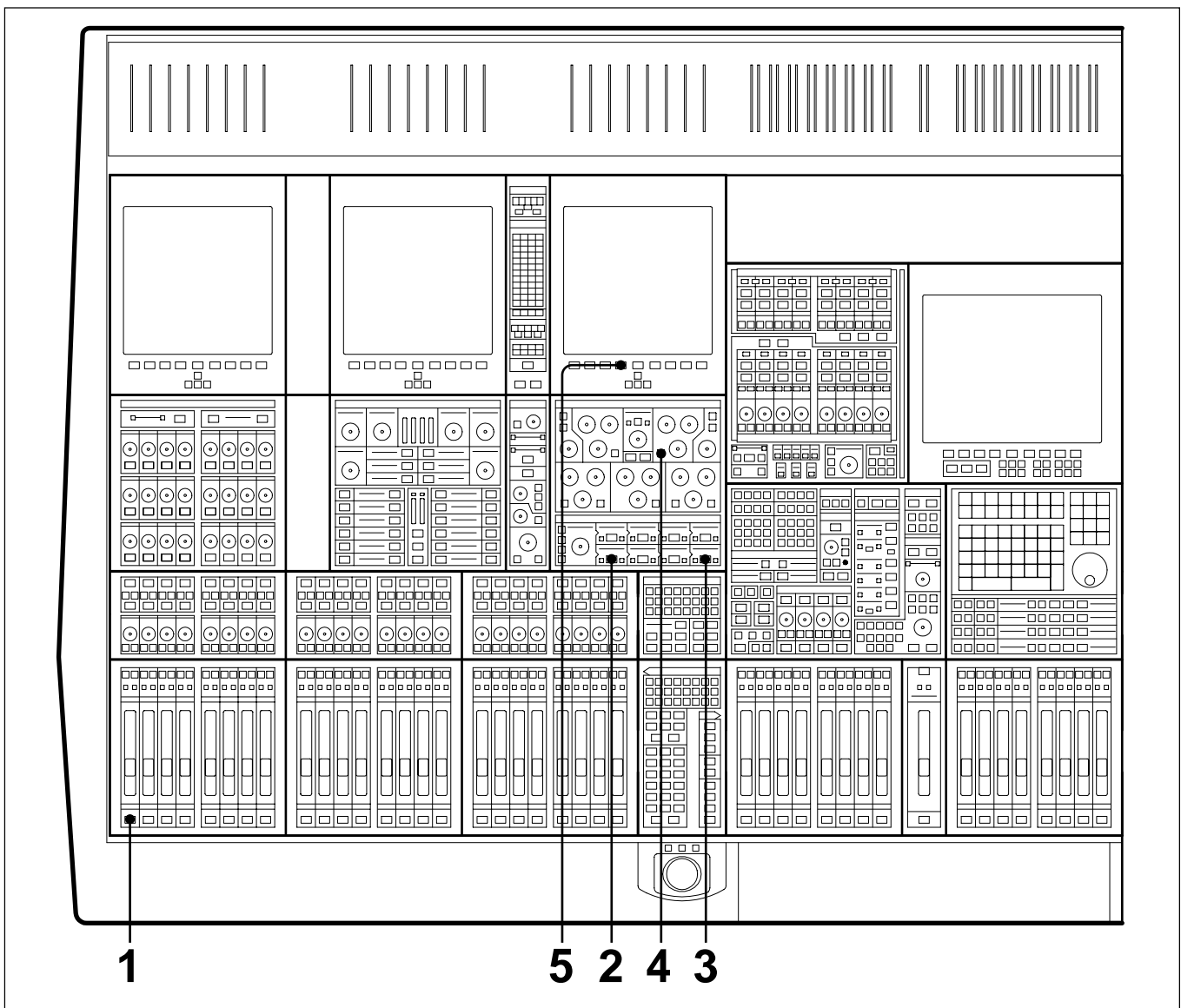

- 1** Press **ACCESS** for the desired Channel.
- 2** At the Input Channel & Inserts panel, select 'MULTI' in window number 5 using the **+** and **-** buttons either side. Select its large **IN** button to insert the multitrack into the signal path.
- 3** At the same panel, select 'EQ' in a window after window 5, window 8 for example, and select the large **IN** button to insert the equaliser into the signal path after the multitrack.
- 4** On the upper section of the same panel, select the individual **IN** buttons for the bands required and adjust as necessary.
- 5** Select the EQ softkey for the screen above the equaliser panel to view the parameters and response curve graph.

3-10-8 To Insert Dynamics Pre Multitrack Send

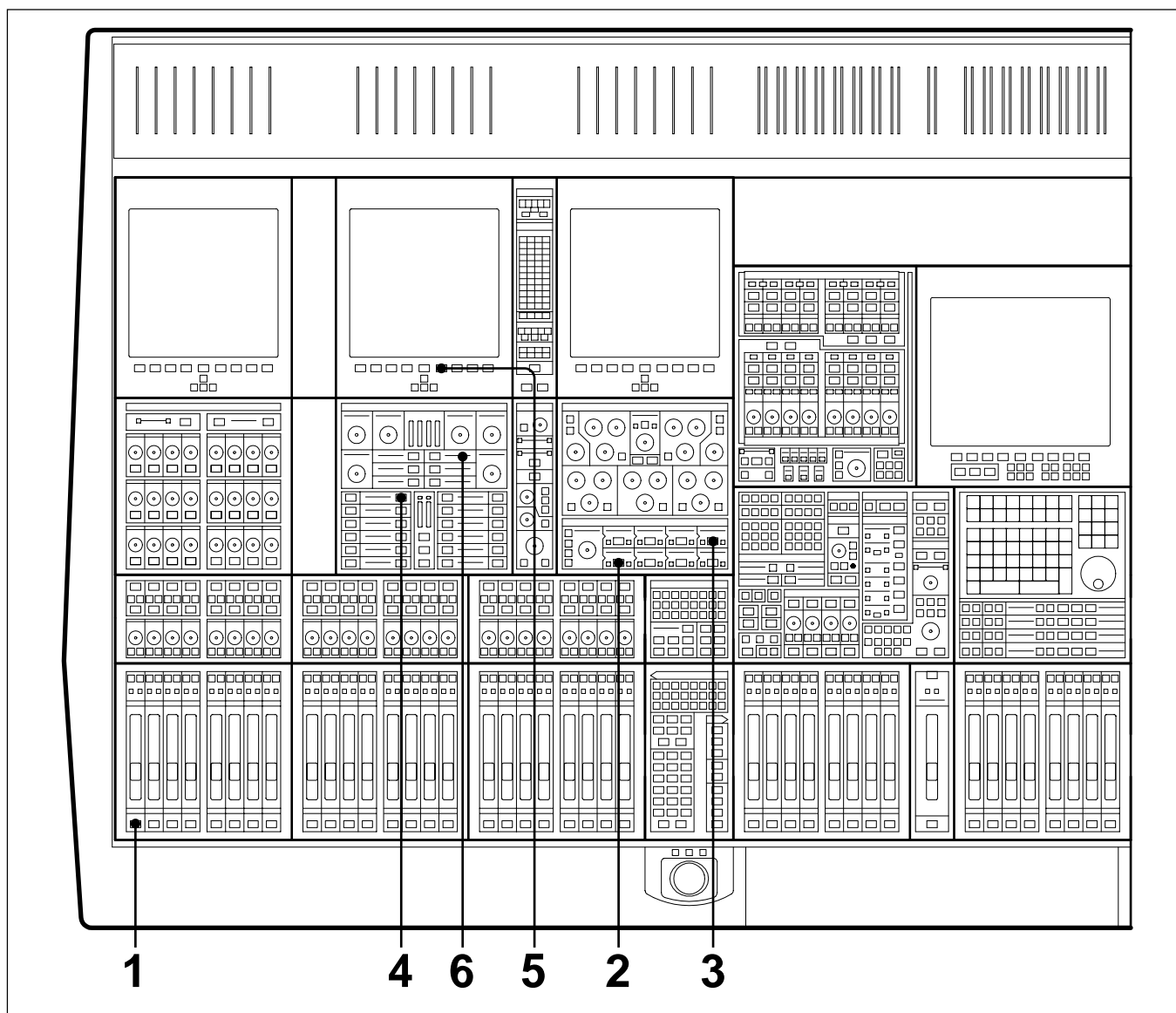

- 1** Press **ACCESS** for the desired Channel.
- 2** At the Input Channel & Inserts panel, select 'MULTI' in window number 5 using the **+** and **-** buttons either side. Select its large **IN** button to insert the multitrack into the signal path.
- 3** At the same panel, select 'DYN' in a window before window 5, window 4 for example, and select the large **IN** button to insert the dynamics processor into the signal path before the multitrack.
- 4** In the Dynamics section, located in the Free Assign Area, select **IN** buttons for the processing required: Gate, Compressor, etc., indicated by 8 character dot displays.
- 5** On the LCD screen above the dynamics controls, press the Dynamics softkey to view the parameters and transfer curve graph.
- 6** The dynamics processing is set and displayed via definable knobs and switches. Set their functions via the local **ACCESS** keys according to the processes in use. Adjust whilst viewing the settings on the LCD screen. The settings for all functions are displayed simultaneously.

3-10-9 To Insert Dynamics Post Multitrack Return

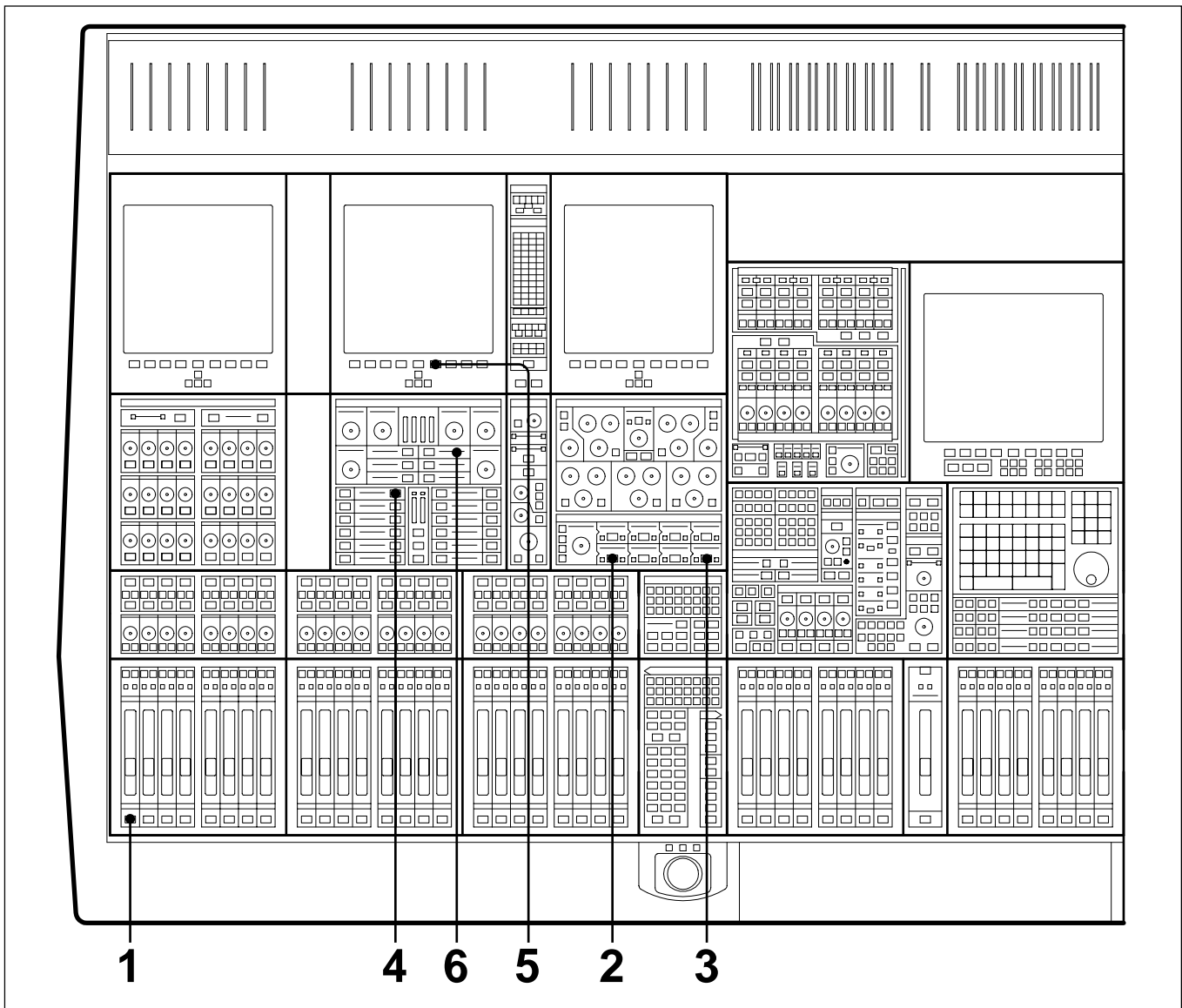

- 1** Press **ACCESS** for the desired Channel.
- 2** At the Input Channel & Inserts panel, select 'MULTI' in window number 5 using the **+** and **-** buttons either side. Select its large **IN** button to insert the multitrack into the signal path.
- 3** At the same panel, select 'DYN' in a window after window 5, window 8 for example, and select the large **IN** button to insert the dynamics processor into the signal path before the multitrack.
- 4** In the Dynamics section, located in the Free Assign Area, select **IN** buttons for the processing required: Gate, Compressor, etc., indicated by 8 character dot displays.
- 5** On the LCD screen above the dynamics controls, press the Dynamics softkey to see the parameters and transfer curve graph.
- 6** The dynamics processing is set and displayed via definable knobs and switches. Set their functions via the local **ACCESS** keys according to the processes in use. Adjust whilst viewing the settings on the LCD screen. The settings for all functions are displayed simultaneously.

3-10 Basic Console Operations

3-10-10 To Bounce Tracks

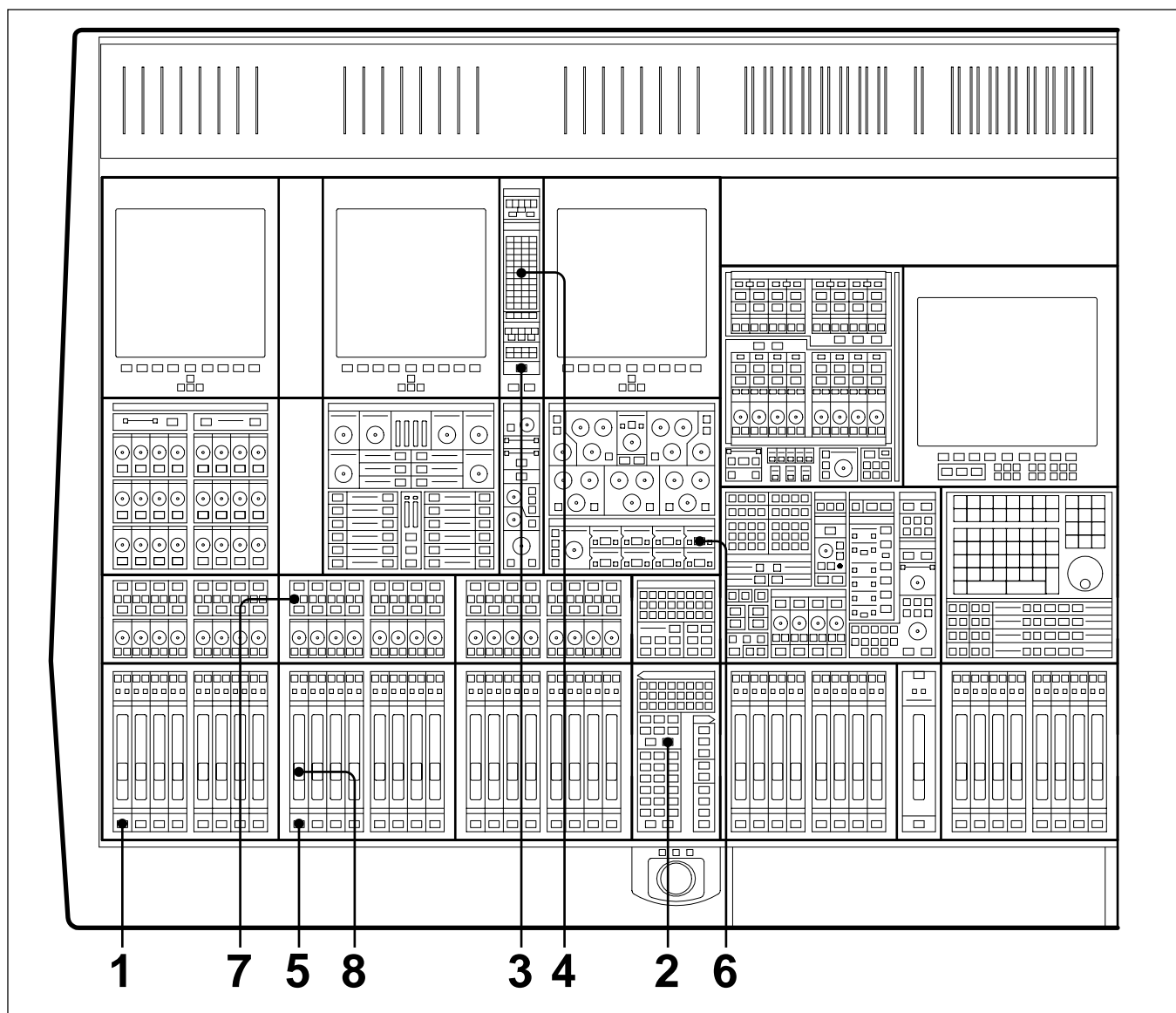

- 1 Press **ACCESS** for the desired Channel.
- 2 Make sure **CHANS** is selected on the Select To Faders panel (fire-up default).
- 3 At the Routing panel, select **CHANS**. The **L** and **R** buttons will be de-selected automatically so that the channel output is no longer routed to the Main Output Bus.
- 4 At the same panel select the destination tracks required for the bounce, in the **ROUTE TO TRACKS** section. Fader and Pan settings will be retained (L to odd-numbered tracks, R to even).
- 5 Select **ACCESS** for the first of the new tracks.
- 6 On the Input Channel & Inserts panel, select 'MULTI' and its large **IN** button in one of the eight windows. Repeat for other bounce tracks.
- 7 Select the **SEND** on the channels to which the bounce is routed, for a monitor signal for those tracks.
- 8 Set the monitor level for the new track(s).
- 9 The original balance will be bounced down to the selected multitrack tracks. Repeat steps 1 to 4 for other tracks to be bounced down.

3-10-11 To Set Up Super Send Groups from Multitrack

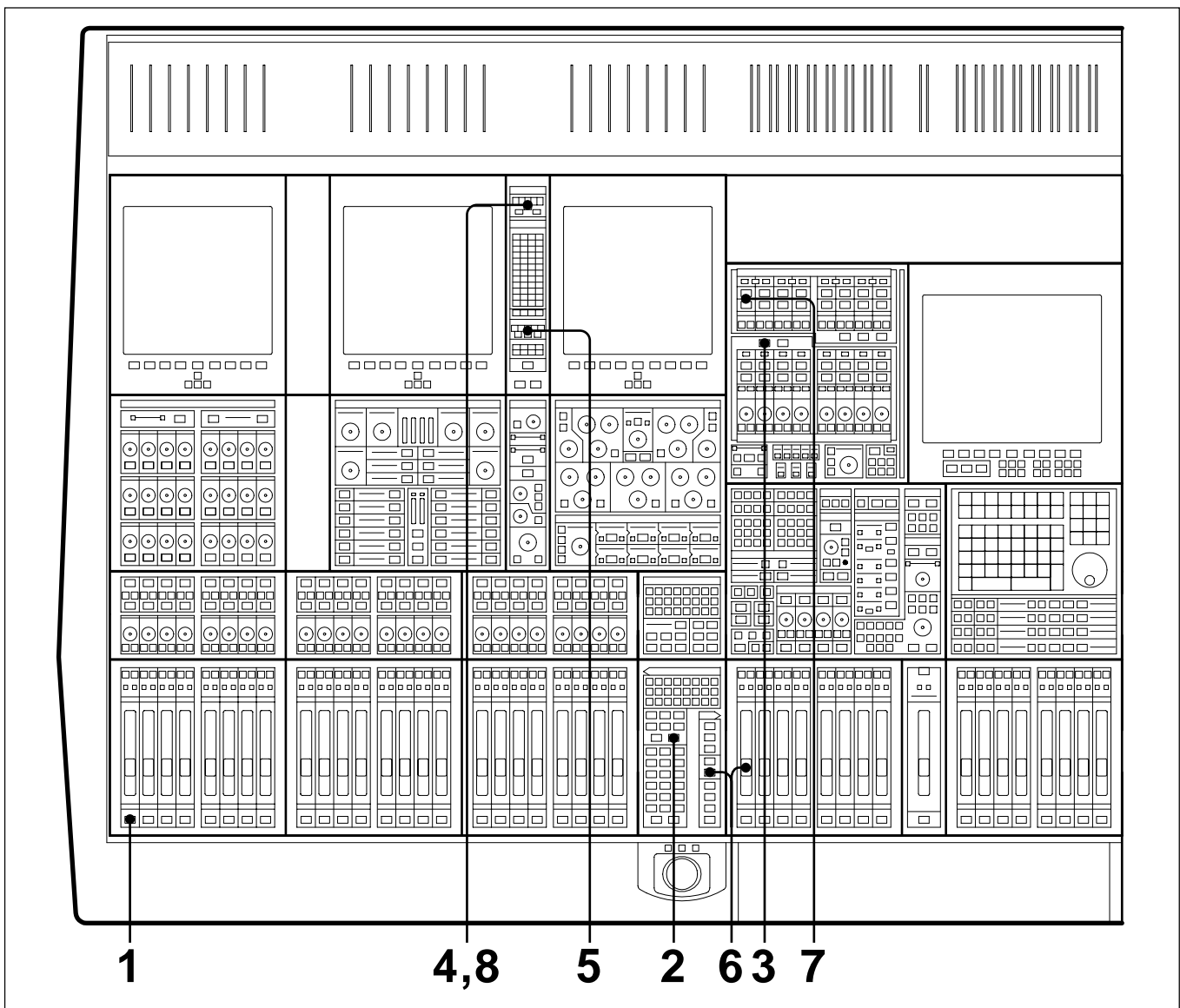

- 1** Press **[ACCESS]** for the first Channel to be routed to a Super Send Group (SSG).
- 2** Make sure **[CHANS]** is selected on the Select To Faders panel (fire-up default).
- 3** Make sure **[SUPER SGs 1-8]** is selected in the SSG masters section.
- 4** At the Routing panel, de-select **[L]** and **[R]**.
- 5** At the same panel, select the SSGs required, **[1/9]** and **[2/10]** in this case.
- 6** At the Select To Faders panel (SEL section), select **[SUPER SGs 1-8]**, then adjust the Fader to 0dB in the Central Faders panel.
- 7** Above the SSG 1 level knob select **[MAIN]** and its **[ACCESS]**.
- 8** At the top of the Routing panel select **[L]**.
- 9** Repeat steps 7 and 8 for SSG 2 but select **[R]** at the Routing panel.
- 10** Repeat steps 1 to 5 for further channels.

3-10-12 To Set Up a De-Esser Using Dynamics Side-Chain EQ

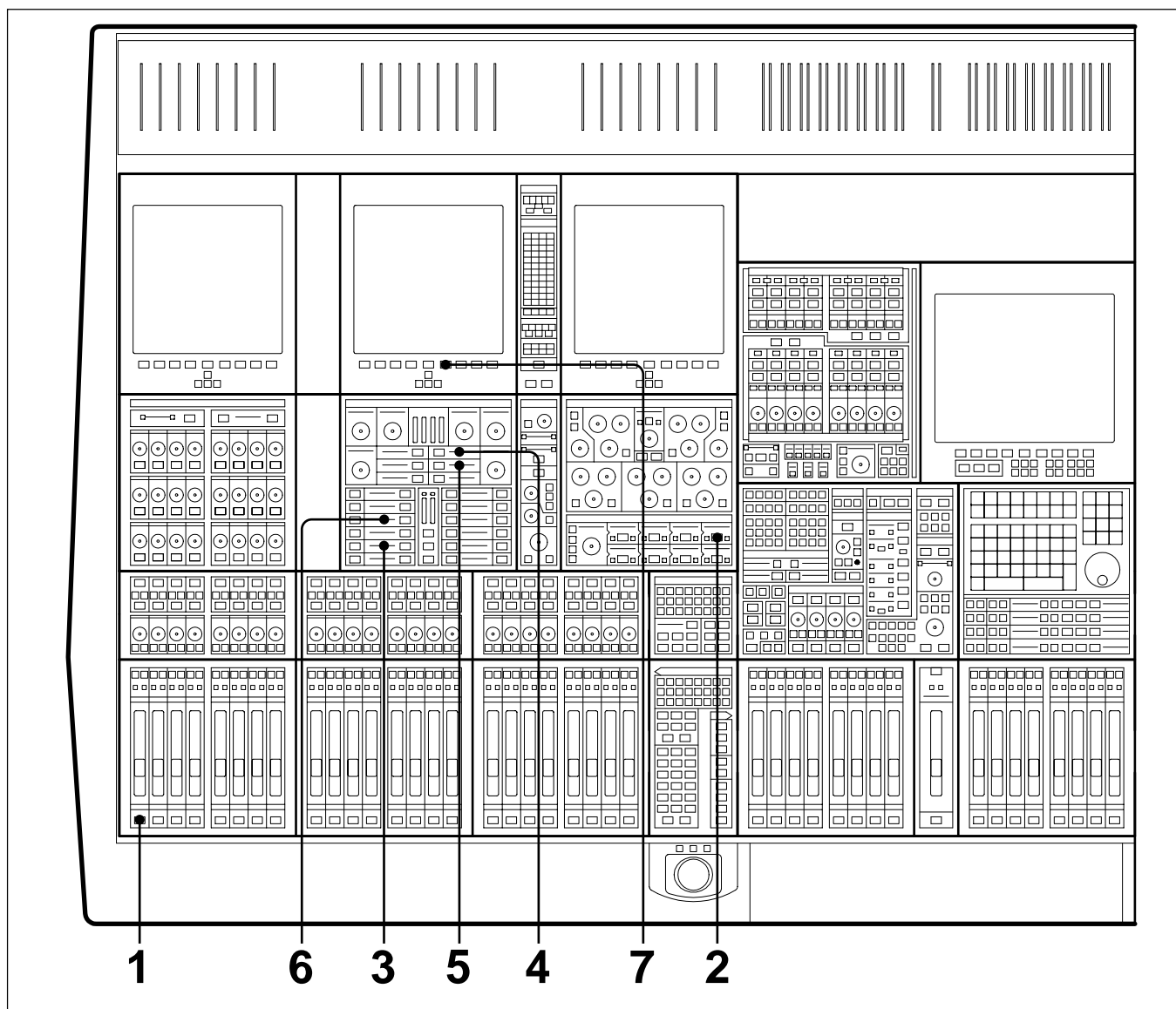

- 1** Press **ACCESS** for the desired Channel.
- 2** At the Input Channel & Inserts panel, select 'DYN' in one of the eight windows. Do this using the **+** and **-** buttons, and then press the large **IN** button.
- 3** At the Free Assign Area & Dynamics panel, select **SC EQ IN**; its **ACCESS** button will light automatically.
- 4** At the same panel, press the button adjacent to the **SIG EQ** display and adjust the HF controls to boost the frequency band to be attenuated.
- 5** Now de-select **SIG EQ** and select **S-C EQ** to affect just the side-chain signal.
- 6** At the same panel, select **COMPRESS IN**. The Compressor **ACCESS** will be selected automatically, allowing the compressor to be set.
- 7** Select the Dynamics softkey to view compressor parameters and transfer curve graph on the LCD screen.

3-10-13 To Link Compressor Side-Chains in a Group

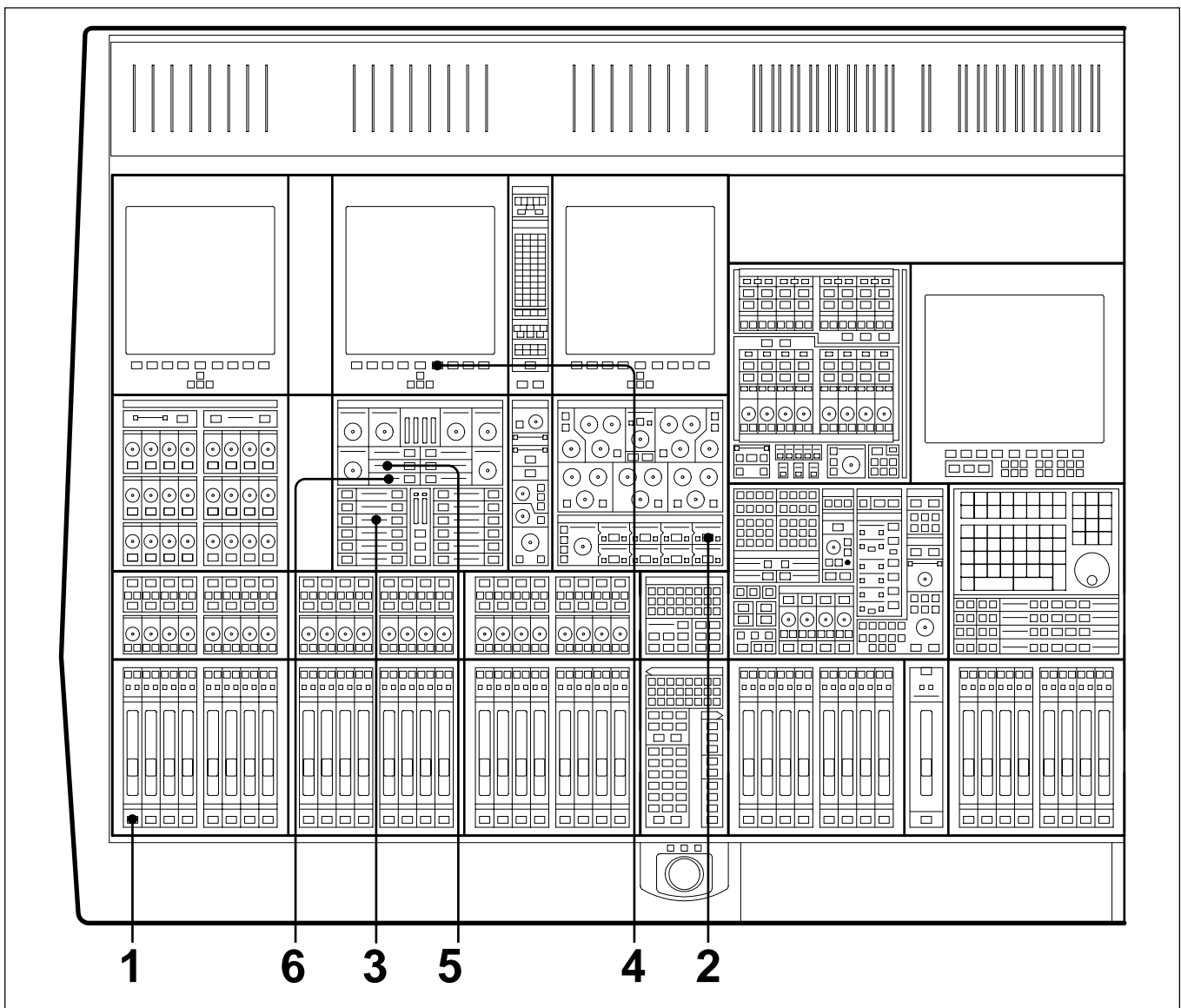

- 1** Press **ACCESS** for the first Channel to have a dynamics side-chain link.
- 2** At the Input Channel & Inserts panel, select 'DYN' in one of the eight windows. Do this using the **+** and **-** buttons, and then press the large **IN** button.
- 3** At the Free Assign Area & Dynamics section, select the **COMPRESS IN**. Its **ACCESS** will be selected automatically, assigning the Compressor controls to the panel for adjustment.
- 4** On the LCD screen above the dynamics controls, press the Dynamics softkey to view the parameters and transfer curve graph.
- 5** Select **SC TO G1** in the middle window.
- 6** Select **SC FM G1** in the lower window.
- 7** Repeat Steps 1 to 4 for further channels required in the side-chain link group.

3-10 Basic Console Operations

3-10-14 To Link Compressor Side-Chains so that One Channel Controls a Second Channel

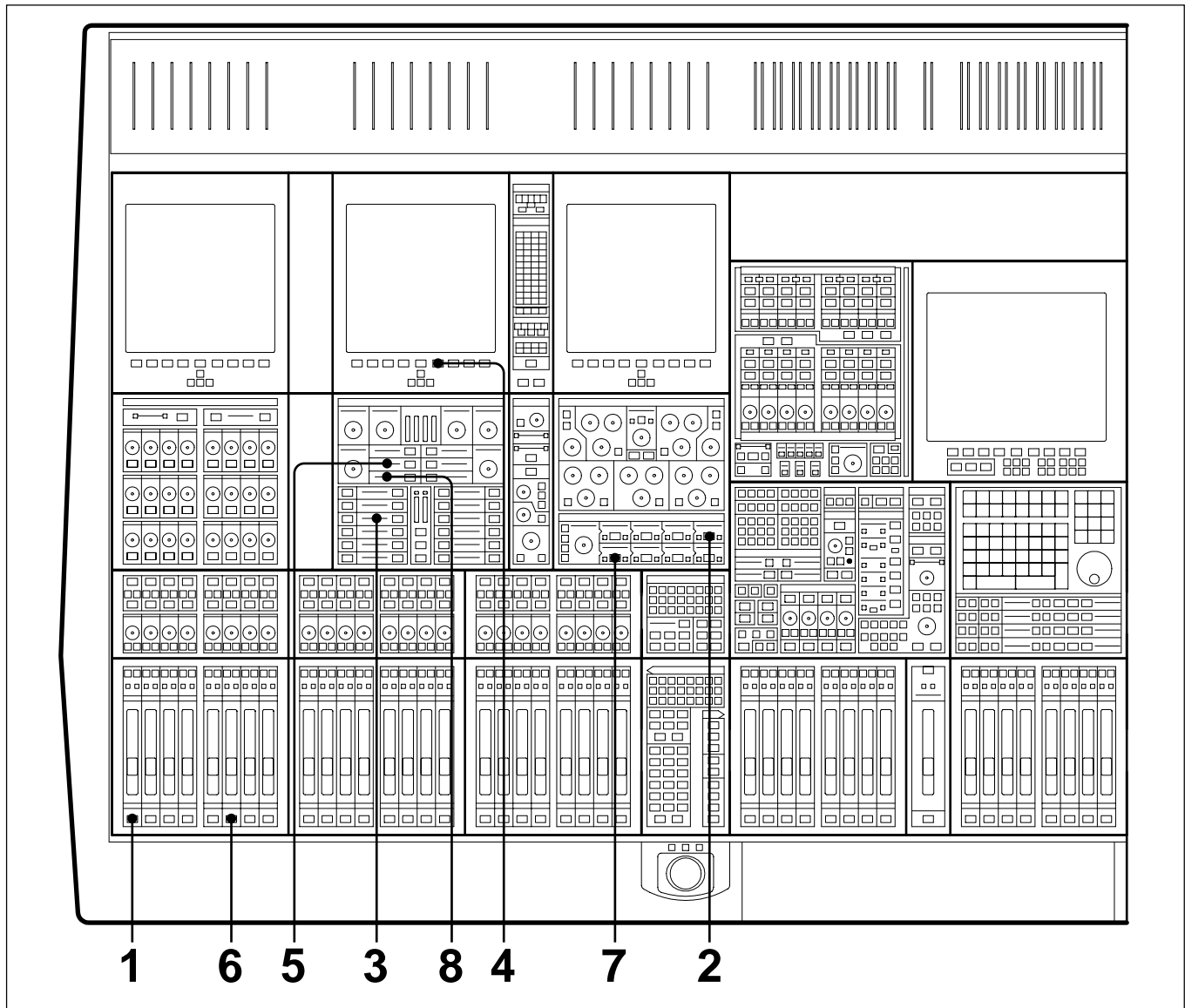

- 1 Press the **ACCESS** button for the controlling Channel.
- 2 At the Input Channel & Inserts panel, select 'DYN' in one of the eight windows. Do this using the **+** and **-** buttons, and then press the large **IN** button.
- 3 At the Free Assign Area & Dynamics section, select the **COMPRESS IN**. Its **ACCESS** will be selected automatically, assigning the Compressor controls to the panel for adjustment.
- 4 On the LCD screen above the dynamics controls, press the Dynamics softkey to view the parameters and transfer curve graph.
- 5 Select **SC TO G1** button (sends the side-chain control signal to side-chain bus 1). Make sure **LOCAL** is selected in the lower window.
- 6 Press **ACCESS** for the second channel.
- 7 At the Input Channel & Inserts panel, select 'DYN' and its **IN** button in one of the eight windows.

8 At the Free Assign Area & Dynamics section, select **SC FM G1** in the lower window.

9 All adjustments are made on the first channel.

