



4-254-568-12(1)

The player

Portable USB Memory Player with FM Radio

Operating Instructions

pavit

AZ-RS1/RS128/RS256

©2004 Sony Corporation

WARNING

To prevent fire or shock hazard, do not expose the unit to rain or moisture.

Do not install the appliance in a confined space, such as a bookcase or built-in cabinet.

To prevent fire, do not cover the ventilation of the apparatus with news papers, table cloths, curtains, etc. And don't place lighted candles on the apparatus.

To prevent fire or shock hazard, do not place objects filled with liquids, such as vases, on the apparatus.

Certain countries may regulate disposal of the battery used to power this product. Please consult with your local authority.

The validity of the CE marking is restricted to only those countries where it is legally enforced, mainly in the countries EEA (European Economic Area).

For the customers in the USA

Owner's Record

The model number and the serial number are located at the rear. Record the serial number in the space provided below. Refer to these numbers whenever you call upon your Aiwa dealer regarding this product.

Model No. _____

Serial No. _____

If you have any questions about this product, you may call;

Aiwa Customer Information Service Center

1-800-289-2492 or

<http://www.us.aiwa.com/>.

Declaration of Conformity

Trade Name: AIWA

Model No.: AZ-RM256

AZ-RM128

Responsible Party: Sony Electronics Inc.

Address: 16450 W. Bernardo Dr, San Diego, CA
92127 U.S.A.

Telephone No.: 858-942-2230

This device complies with part 15 of the FCC rules. Operation is subject to the following two conditions: (1) This device may not cause harmful interference, and (2) this device must accept any interference received, including interference that may cause undesired operation.

AZ-RS1: No "pavit"

AZ-RS128: AZ-RM128 (one 128-MB "pavit")

AZ-RS256: AZ-RM256 (one 256-MB "pavit")

This device complies with Part 15 of the FCC Rules. Operation is subject to the following two conditions: (1) This device may not cause harmful interference, and (2) this device must accept any interference received, including interference that may cause undesired operation.

NOTE

This equipment has been tested and found to comply with the limits for a Class B digital device, pursuant to Part 15 of the FCC Rules. These limits are designed to provide reasonable protection against harmful interference in a residential installation. This equipment generates, uses, and can radiate radio frequency energy and, if not installed and used in accordance with the instructions, may cause harmful interference to radio communications. However, there is no guarantee that interference will not occur in a particular installation. If this equipment does cause harmful interference to radio or television reception, which can be determined by turning the equipment off and on, the user is encouraged to try to correct the interference by one or more of the following measures:

- Reorient or relocate the receiving antenna.
- Increase the separation between the equipment and receiver.
- Connect the equipment into an outlet on a circuit different from that to which the receiver is connected.
- Consult the dealer or an experienced radio/TV technician for help.

You are cautioned that any changes or modifications not expressly approved in this manual could void your authority to operate this equipment.

CAUTION

You are cautioned that any changes or modifications not expressly approved in this manual could void your authority to operate this equipment.

Table of Contents

Overview

| | |
|--|---|
| What you can do with your player | 4 |
| Main features | 5 |

Getting started

| | |
|--|---|
| Step 1: Check the package contents. | 6 |
| Step 2: Insert a battery. | 7 |
| Locating controls | 9 |

Basic operations

| | |
|---|----|
| Listening to music | 11 |
| 1. Connect the headphones. | 11 |
| 2. Insert the “pavit” into the player. | 11 |
| 3. Start playback. | 12 |

► Playback options 15

| | |
|--|----|
| Changing the sound quality (M.D.S.E) | 15 |
| Playing a track repeatedly (REP1) / Playing all tracks in random order (SHUF) | 15 |

► Listening to the radio 16

| | |
|---------------------------------|----|
| Listening to the radio | 16 |
| Presetting radio stations | 17 |

► Available features 19

| | |
|--|----|
| Using the stopwatch | 19 |
| Using the countdown timer | 20 |
| Locking the controls (HOLD) | 21 |
| Turning off the beep sounds (BEEP) | 21 |

► Changing the settings of the player 22

| | |
|--------------------------------------|----|
| Changing the display pattern | 22 |
| Changing the backlight setting | 22 |
| Changing the display language | 23 |

► Additional information 24

| | |
|-----------------------|------------|
| Precautions | 24 |
| Cleaning | 24 |
| Troubleshooting | 25 |
| Specifications | 27 |
| Index | Back cover |

Before using this player, install the application software on your computer using the supplied CD-ROM, and send some music data to the player.

What you can do with your player

AZ-RS1/RS128/RS256 is a portable USB memory player with FM radio specially designed for use with a USB storage media called “pavit.” You can send MP3 files on your computer to the “pavit,” insert the “pavit” into the player, and carry your favorite songs anywhere. In addition to playing music data (MP3), you can listen to FM broadcasts with this player.

1 Send your favorite songs to the “pavit.”

Use the supplied “Music Transfer pavit Edition” software to send MP3 files from your computer to the “pavit.”



2 Enjoy music anywhere with your player!



What is “pavit”?

The “pavit” is a compact, lightweight, new-generation USB storage media* with a large storage capacity. Although the “pavit” is dedicated to “pavit”-compatible devices, it can also be used as an external storage media for your computer, since it connects directly to the USB port, a standard interface for personal computers.

* Storage media is a device that can store data, such as floppy disk, hard disk and magneto-optic disk (MO).

The “pavit” complies with USB2.0 (High-Speed USB).

Main features

- Compact size, lightweight, highly portable, with skip-proof operation
- The player is equipped with an FM radio tuner. You can listen to FM broadcasts in addition to playing music data (MP3).
- Up to 240 minutes of music can be stored in a 256-MB “pavit” and 120 minutes in a 128-MB “pavit.”*
- MP3 files on your computer are sent to the “pavit” by simple and easy operations using the supplied “Music Transfer pavit Edition” software.
- The “pavit” connects directly to the USB port on your computer for high-speed data transfer.
- You can also store a variety of data other than MP3 files in the new-generation USB storage media “pavit.”

* The time length varies according to the bit rate used when encoding MP3 files. The times indicated here are for 128-kbps MP3 files.

Notes

- Music you record is limited to private use only. Any other use requires the permission of the copyright holders.
- Sony is not liable for incomplete data transfer or damaged data due to problems of this product or your computer.

Getting started

Step 1: Check the package contents.

Check the accessories enclosed in the package.

- Portable USB memory player with FM radio (1)

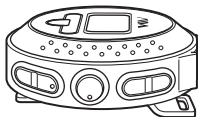

- USB storage media “pavit”* (1)



- Stereo headphones (1)

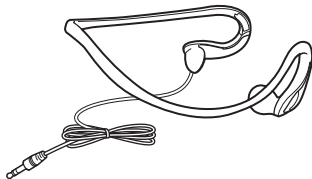

- CD-ROM (Music Transfer pavit Edition) (1)



- Headphone extension cord (1)



- Arm band (1)

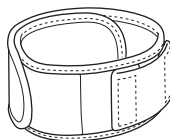

- Operating instructions for the Portable USB Memory Player with FM Radio (this manual)
- Operating instructions for the application software Music Transfer pavit Edition (1)
- Quick start guide (1)

* Supplied with AZ-RS128 and AZ-RS256 only. For AZ-RS1, see “Optional accessories” on page 27.

Step 2: Insert a battery.

Insert one LR03 (size AAA) alkaline battery into the battery compartment as illustrated below.

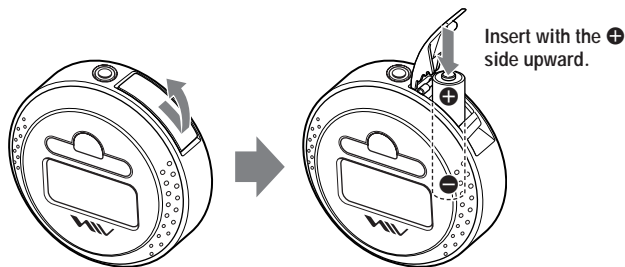

Battery duration

Approximately 10 hours (continuous music data playback, with Sony LR03 (size AAA) alkaline battery)

When the battery is drained, playback stops and the power is turned off automatically. Operations of the buttons and switches may also become disabled. Even if you try to turn on the power in this state, nothing will be displayed and you cannot start playback. Replace the battery with a new one.

When you turn on the power after replacing the battery, playback starts from the track whose playback was interrupted by battery drain.



When to change the battery

The battery level indication in the display changes as follows:



Change the battery when the battery level indication becomes “”

Notes

- The indicator sections of “” roughly show the remaining battery power. One section does not always indicate one-third of the battery power.
- Depending on the operating condition, the indicator sections of “” may increase or decrease.

(Continued)

To remove the battery

Turn the player upside down to draw out the battery.

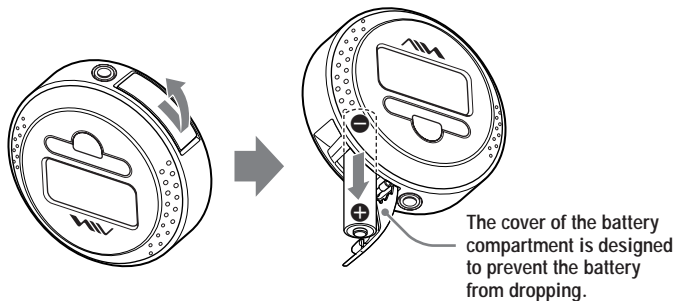

Notes on dry batteries

- Do not throw batteries into fire.
- Do not carry batteries with coins or other metallic objects. It can generate heat if the positive and negative terminals of the battery are accidentally contacted by a metallic object.
- When the player is not to be used for a long time, remove the battery.
- If battery leakage occurs, wipe off any deposit in the battery compartment, and insert a new battery. In case the deposit adheres to you, wash it off thoroughly.

Locating controls

Player (front/side)

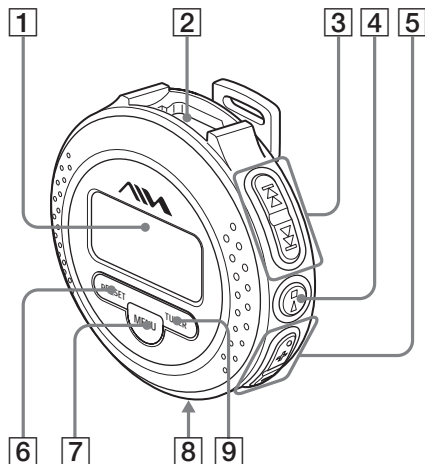

Player (rear)

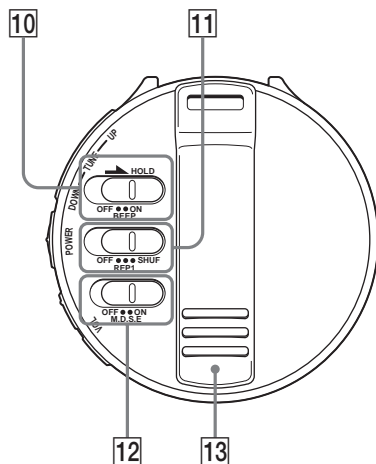

- 1** Display
- 2** "pavit" slot
- 3** ◀◀/▶▶ (SKIP/DOWN/UP) buttons
- 4** ▶■* (PLAY/STOP)/POWER button
- 5** VOL (volume) -/+* buttons
- 6** PRESET button
- 7** MENU button
- 8** 🎧 (headphones) jack
- 9** TUNER* button

- 10** HOLD/BEEP switch
- 11** REP1 (repeat 1)/SHUF (shuffle) switch
- 12** M.D.S.E (MP3 Digital Sound Enhancer) switch
- 13** Clip

* The button has a tactile dot.

(Continued)

Display

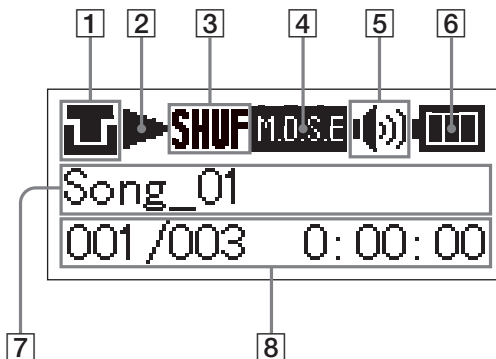

- 1** “pavit” insertion indicator
The “pavit” is inserted in the player correctly.
The “pavit” is not inserted in the player.
- 2** Operation status indication
Displays the icon for music data playback, radio, stopwatch or countdown timer.
- 3** Play mode indication
SHUF: Playing all tracks in random order
1: Playing a track repeatedly
“PRESET” is displayed in the radio preset mode.
- 4** M.D.S.E indication
Displayed only during music data playback.
“PRESET” is displayed in the radio preset mode.
- 5** Volume indication
Roughly shows the current volume level.
- 6** Battery level indication
Roughly shows the remaining power of the battery. If “ ” flashes, the battery is depleted.
- 7** Character information display
Displays the title, file name of music data, etc.
- 8** Track number/elapsed playing time indication
Displays the preset numbers in the radio preset mode.

Listening to music

First, send MP3 files to the “pavit” from your computer using the supplied “Music Transfer pavit Edition” software. Refer to the separate manual “Music Transfer pavit Edition” about how to send MP3 files to the “pavit.”

1. Connect the headphones.

Connect the headphones to the  (headphones) jack on the player.

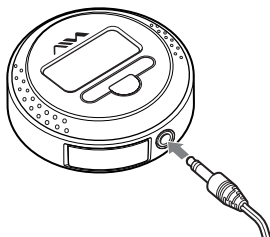

2. Insert the “pavit” into the player.

When the power is turned on, the “pavit” insertion indicator  will appear in the display.

If there are no music data in the “pavit,” the “pavit” insertion indicator becomes .

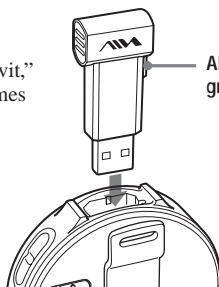

Align this projection with the groove inside the “pavit” slot.

(Continued)

3. Start playback.

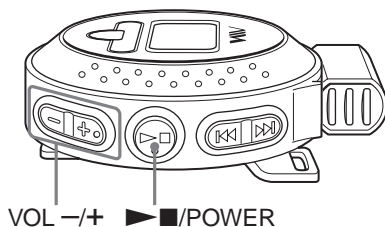

1 Press and hold ►■/POWER.

The power is turned on, a short beep is heard in the headphones (when the HOLD/BEEP switch is set to BEEP ON), and playback starts.

2 Press VOL -/+ to adjust the volume.

Music data (tracks) are played in the order of the Playlist you created using “Music Transfer pavit Edition.”

During play mode, the track information* and elapsed playing time are displayed. Playback stops after the last track has been played.

* Displayed when the track has ID3 TAG information. If the track does not have ID3 TAG information, the file name is displayed. (ID3 TAG is a format to include textual information, such as title, album name and artist name, in MP3 files.)

If playback does not start

If the HOLD function is set to on, release the HOLD function (page 21).

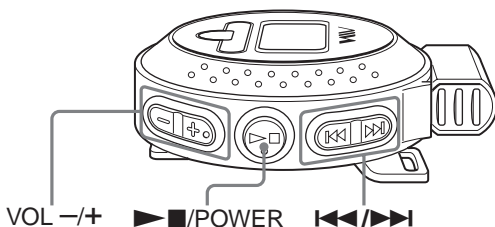

| To | Do this |
|--|---|
| Go to the beginning of the next track | Press ►►. *1 |
| Go to the beginning of the current track | Press ◀◀. |
| Go to the beginning of preceding tracks | Press ◀◀ repeatedly. *1 To quickly locate the desired track, press and hold ◀◀ until you find it. *2 |
| Go to the beginning of succeeding tracks | Press ►► repeatedly. *1 To quickly locate the desired track, press and hold ►► until you find it. *2 |
| Adjust the volume | Press VOL -/+. Press and hold VOL -/+ to quickly turn down or up the volume. |
| Stop playback | Press ►■/POWER. *3 |
| Turn off the power | Press and hold ►■/POWER. |

*1 A short beep sounds for each track. When the first track is reached, the player emits a different beep sound.

*2 While holding down the button, a short beep sounds for each track. When the first track is reached, the player emits a different beep sound and playback of the first track will start.

*3 The power will be turned off automatically if the player is not operated for about 10 seconds while playback is stopped.

To remove the “pavit”

Always turn off the power before you remove the “pavit.” The music data or the “pavit” itself might be destructed if you remove the “pavit” with the player’s power turned on.

(Continued)

To start playback from the first track

Playback starts from the position where it was last stopped.

To start playback from the first track, press and hold ◀◀ or ▶▶ to return to the first track (page 13).

Playback will also start from the first track when:

- you remove the “pavit” and insert a different “pavit.”
- you reset the player (page 25).

To wear the player on your arm

Wrap the supplied arm band around your arm, etc., and then attach the player to the arm band using the clip.

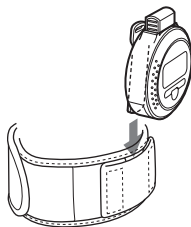

Using the headphone extension cord

The headphone extension cord makes it easy to use the player while carrying it in your pocket or bag.

- 1 Connect the plug of the headphone extension cord to the ◡ (headphones) jack on the player.
- 2 Connect the headphones to the headphone extension cord.

Note

To prevent the wire from breaking, do not pull on the headphone cord when you connect or disconnect the headphones.

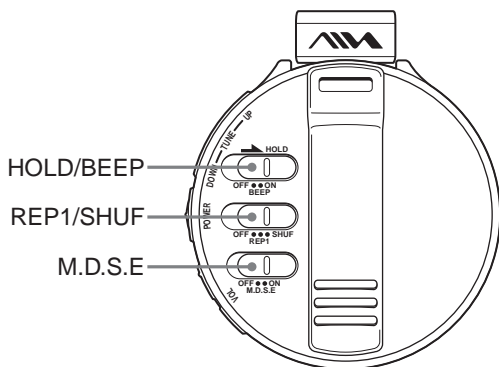

Changing the sound quality (M.D.S.E)

The M.D.S.E (MP3 Digital Sound Enhancer) allows you to enjoy clear digital sound and a resonant bass.

Set the M.D.S.E switch to ON.

“**M.D.S.E**” appears in the display.

To return to the normal sound

Set the M.D.S.E switch to OFF.

Playing a track repeatedly (REP1) / Playing all tracks in random order (SHUF)

| To | Set the REP1/SHUF switch to |
|-------------------------------------|---|
| Play the current track repeatedly*1 | REP1 (“ REP1 ” is displayed.) |
| Play all tracks in random order*2 | SHUF (“ SHUF ” is displayed.) |

*1 After the track has been played 10 times repeatedly, playback stops.

*2 Playback stops when all the tracks in the “pavit” have been played.

To return to normal play mode

Set the REP1/SHUF switch to OFF.

► Listening to the radio

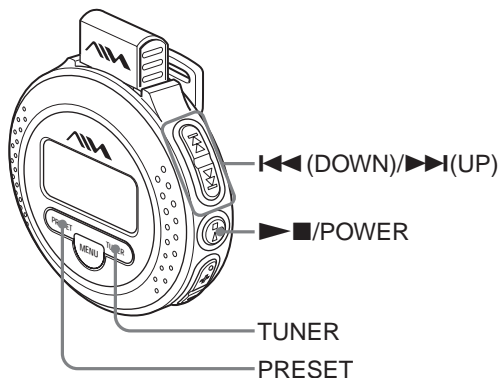

Listening to the radio

You can listen to FM broadcasts with and without inserting the “pavit” in the player.

1 Press and hold ▶■/POWER until the player is turned on.

If the radio was selected when you turned off the player last time, or if the “pavit” is not inserted in the player, the radio will be selected automatically when you turn on the player.

2 Press TUNER repeatedly to select “FM 1” or “FM 2.”

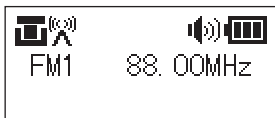

3 Press and hold ◀◀ (DOWN) or ▶▶ (UP) for about one second.

The player starts scanning the frequencies and stops when it finds a receivable station.

If you press ◀◀ (DOWN) or ▶▶ (UP) repeatedly, the frequency changes step by step.

To turn off the radio

Turn off the power by holding down ▶■/POWER until “SEE YOU” appears in the display.

If you press ▶■/POWER, music data will be played from the position where the playback was last stopped.

To enhance detection of receivable stations

If there are stations that you want preset but cannot do it automatically because their signals are not strong enough, change the setting of “AUTO STOP LEVEL” to “HIGH” in order to enhance detection of receivable stations.

- 1 Press MENU.
- 2 Press **◀◀** (DOWN) or **▶▶** (UP) repeatedly to select “AUTO STOP LEVEL.”
- 3 Press MENU.
- 4 Press **◀◀** (DOWN) or **▶▶** (UP) to select “HIGH*.”

In case the same station is preset on two or more preset numbers because its signal is too strong, set the “AUTO STOP LEVEL” to “LOW.”

- 5 Press MENU.

* The default setting at the time of purchase is “MID.”

Note

Changing the setting of “AUTO STOP LEVEL” does not change the reception sensitivity.

To improve the reception

The headphone cord functions as the FM antenna. Extend the cord to improve the reception.

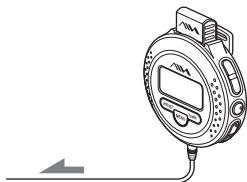

Presetting radio stations

You can preset up to 20 FM radio stations, 10 stations each for FM 1 and FM 2.

To preset stations automatically (Auto preset)

- 1 Perform steps 1 and 2 of “Listening to the radio” (page 16) to select the band.
- 2 Press PRESET.
“PRESET” and the preset numbers appear in the display.
- 3 Press and hold PRESET for more than 2 seconds.
“PRESET” starts flashing, and the player starts scanning for stations from the lower frequencies.



The first received station is preset on the preset number 1, and then the player starts scanning for the next receivable station.

If you press **▶■**/POWER or TUNER during auto presetting, the player stops scanning and exits the auto preset mode, and music data playback starts or the radio is switched to the other band.

(Continued)

To preset a station manually (Manual preset)

If there is a station that cannot be preset automatically, you can preset it manually by the following procedure.

Before starting, you must exit the auto preset mode (“PRESET” and the preset numbers should not be displayed).

- 1 Press TUNER repeatedly to select “FM 1” or “FM 2.”
- 2 Tune in the station you want to preset.
- 3 Press and hold PRESET for more than 2 seconds.
“PRESET” and the preset numbers flash in the display.
- 4 Within 10 seconds, press ◀◀ or ▶▶ repeatedly to select the preset number you want to store the station on.
The selected preset number starts flashing.
- 5 Within 10 seconds, press PRESET.

To tune in a preset station

- 1 Press TUNER repeatedly to select “FM 1” or “FM 2.”
 - 2 Press PRESET to display the preset numbers.
 - 3 Press ◀◀ or ▶▶ repeatedly to select the preset number of the station you want to tune in.
-

To clear all preset stations

Turn off the power, remove the “pavit” from the player, and press and hold ▶■/POWER for more than 10 seconds.

The preset stations return to those at the time of purchase.

Using the stopwatch

You can use the player as a stopwatch. The stopwatch has a lap time feature enabling you to calculate a gap from a previous stored time.

You can use the stopwatch both while playing music data and listening to the radio.

1 During music data playback or radio reception, press MENU.

2 Press **◀◀** or **▶▶** repeatedly to select “STOPWATCH,” and then press MENU.

3 Press MENU.

Time count starts.

To stop the stopwatch

Press MENU.

To resume the time count, press MENU again.

To reset the stopwatch

After stopping the stopwatch by pressing MENU, press PRESET.

To display the lap time

Press PRESET at the point you need to check the lap time.

The current time is stored in the memory and the lap time (the time length from the previous stored time) is displayed.

The time count continues while the lap time is displayed.

To update the lap time, press PRESET again.

To exit the stopwatch mode

Press and hold MENU for more than 2 seconds.

The icon for stopwatch “” changes to that for music data playback or radio.



Tip



The stopwatch can count up to 99 minutes 59 seconds 99 centiseconds. To continue the time count from then on, you need to reset the stopwatch.

Using the countdown timer

The alarm can be set to go off after the specified time period has passed. You can specify the time by the minute, from 1 to 99 minutes.

1 During music data playback or radio reception, press MENU.

2 Press  or  repeatedly to select "COUNTDOWN," and then press MENU.

3 Press  or  repeatedly to specify the time length (1 to 99 minutes) until the alarm goes off, and then press MENU.

Countdown starts and the display changes to that for music data playback or radio.

 is displayed during countdown.

When the time reaches zero, music data playback or radio reception is interrupted and the alarm sounds for one minute in the headphones.

Then, after the alarm stops,  disappears and music data playback or radio reception continues.

To turn off the alarm

Press any button on the player.

To cancel the countdown timer

Press and hold MENU for more than 2 seconds.

 disappears.

Tip

If you press MENU to select countdown during countdown, the remaining time will be approximately displayed in minutes.

To exit, press MENU again.

The display changes to that for music data playback or radio.

Locking the controls (HOLD)

When carrying the player in a bag, the HOLD function can be used to prevent accidental pressing of the buttons.

Slide the HOLD/BEEP switch in the direction of the arrow.

“” flashes for a while, and all operation buttons except for the switches on the rear side are disabled.

To release the HOLD function

Slide the HOLD/BEEP switch in the direction opposite to the arrow.

Turning off the beep sounds (BEEP)

Set the HOLD/BEEP switch to OFF.

To turn on the beep sounds

Set the HOLD/BEEP switch to ON.

It is recommended you set the HOLD/BEEP switch to ON, as many operations can be confirmed by beep sounds.

Changing the display pattern

You can select from the following three display patterns:

| Setting | Items to be displayed |
|--------------|-----------------------------------|
| Title | Title of the song |
| Title+Artist | Title of the song and artist name |
| Title+Album | Title of the song and album name |

Title, artist name and album name are displayed when the track has ID3 TAG information. If the track does not have ID3 TAG information, the file name is displayed.

- 1 During music data playback or radio reception, press MENU.**
- 2 Press I◀◀ or ▶▶I repeatedly to select “DISPLAY,” and then press MENU.**
- 3 Press I◀◀ or ▶▶I to select the display pattern you want, and then press MENU.**

To return to the menu screen

Select “BACK” in step 3.

Changing the backlight setting

You can change the lighting time of the backlight for the display.

- 1 During music data playback or radio reception, press MENU.**
- 2 Press I◀◀ or ▶▶I repeatedly to select “BACKLIGHT,” and then press MENU.**
- 3 Press I◀◀ or ▶▶I repeatedly to specify the lighting time (5, 10, 15 or 20 seconds) of the backlight, and then press MENU.**

To return to the menu screen

Select “BACK” in step 3.

If you do not want to turn on the backlight

Select “OFF” in step 3.

Depending on the surrounding light, the visibility of the display may improve if you turn off the backlight.

Note

Regardless of the BACKLIGHT setting, the backlight turns off when the battery level indication becomes “.”

Changing the display language

You can select the language to be used for displaying the menu from:

Japanese, English, German, French, Italian and Spanish.

- 1** During music data playback or radio reception, press **MENU**.
 - 2** Press **◀◀** or **▶▶** repeatedly to select “LANGUAGE,” and then press **MENU**.
 - 3** Press **◀◀** or **▶▶** repeatedly to select the language, and then press **MENU**.
-

To return to the menu screen

Select “BACK” in step 3.

Note

The ID3 TAG text will not change into a different language by this operation.

Precautions

General

Never place the player in a place:

- under direct sunlight or near heat sources
- in a car with its windows closed (especially in summer)
- where it will be subjected to excessive moisture such as in a bathroom
- where there is much dust
- near magnets or magnetized items such as speakers or a TV

Headphones

Road Safety

Do not use headphones while driving, cycling, or operating any motorized vehicle. It may create a traffic hazard and is illegal in many areas. It can also be potentially dangerous to play your player at a high volume while walking, especially at pedestrian crossings. You should exercise extreme caution or discontinue use in potentially hazardous situations.

Preventing hearing damage

Avoid using the headphones at a high volume. Hearing experts advise against continuous, loud and extended play. If you experience a ringing in your ears, reduce the volume or discontinue use.

Consideration for others

Keep the volume at a moderate level. This will allow you to hear outside sounds and to be considerate to the people around you.

Warning

If there is lightning when you are using your player, take off the headphones immediately.

Battery

- When the battery is drained, remove the battery from the player.
- When the player is not to be used for a long time, remove the battery.

In case of failure of this player, consult your Aiwa dealer without opening the casing. If failure occurs while the “pavit” is inserted in the player, it is recommended not to remove the “pavit” from the player to ensure an early solution to the problem.

Cleaning

Clean your player's casing with a soft cloth slightly moistened with water or a mild detergent solution.

Note

Do not use any type of abrasive pad, scouring powder or solvent such as alcohol or benzene as it may mar the finish of the casing.

Cleaning the headphone plug

If the headphone plug is dirty, it may cause noise or sound skipping. To ensure good sound quality, clean the headphone plug periodically with a soft, dry cloth.



If you have any questions or problems concerning your player, please consult your nearest Aiwa dealer.

Troubleshooting

If you experience any of the following difficulties while using your player, use this troubleshooting guide to help you to remedy the problem. Should any problem persist, consult your nearest Aiwa dealer.

For trouble concerning operations while connected to your computer, also refer to “Troubleshooting” in the separate manual “Music Transfer pavit Edition.”

Operation

| Symptom | Cause/Remedy |
|---|--|
| There is no sound. | <ul style="list-style-type: none">→ The volume level is set to the minimum level. Increase the volume (page 12).→ The “pavit” is not inserted in the player correctly. Reinsert the “pavit” and check if the “pavit” insertion indicator “/POWER for more than 10 seconds to reset the player.→ Send the music data to the “pavit” again, as the data stored in the “pavit” may have been destructed. |
| The “pavit” insertion indicator becomes “  <p>Additional information</p> | |

(Continued)

Battery

| Symptom | Cause/Remedy |
|------------------------|--|
| Battery life is short. | → The operating temperature is below 0°C (32°F). Battery life becomes shorter in cold temperatures due to battery characteristics. This is not a malfunction. |

Radio

| Symptom | Cause/Remedy |
|--|--|
| The audio is weak or contains noise. | → The battery is exhausted. Replace the battery with a new one (page 7). → Move the player away from electric products (TV, cellular phone, etc). → The headphone plug is not fully connected. Connect the headphone plug fully, since the headphone cord functions as the FM antenna. |
| The player tunes in to a station with much noise or where there is no station. | → Set the "AUTO STOP LEVEL" to "LOW" (page 17). |

Other

| Symptom | Cause/Remedy |
|--|--|
| The "pavit" cannot be inserted into the player. | → The "pavit" is being inserted backwards. Insert the "pavit" in the correct orientation. |
| The player gets warm. | → The player gets warm if it is used for an extended period of time. This is not a malfunction. |
| The "pavit" which has been used on another device does not work. | → The "pavit" has been formatted on a computer or other device. Make a backup copy of any important data in the "pavit," such as by copying it to the hard disk of your computer. Then reformat the "pavit," using the supplied Music Transfer pavit Edition software. As Music Transfer pavit Edition is not compatible with FAT32 file systems, reformat the "pavit" with FAT or FAT16 format. |

Specifications

USB memory player

Supported audio file format

MP3 Bit rate: 8 - 320 kbps*

Sampling frequencies: 24/22.05/16/12/
11.025/8/32/44.1/48 kHz

* 128 kbps or higher bit rate is recommended.

Frequency response

20 - 20,000 Hz (single signal measurement)

Radio

Frequency range

FM 1/FM 2: 87.5 - 108.0 MHz

General

Output

Headphones: Stereo mini-jack

Operating temperature

5°C - 35°C (41°F - 95°F)

Power source

One LR03 (size AAA) alkaline battery:

1.5 V DC × 1

Battery life*

Music data playback: Approx. 10 hours

Radio reception: Approx. 10 hours

* When using a Sony LR03 (size AAA) alkaline battery.

Dimensions

Approx. 67 × 67 × 21.7 mm

(2 ³/₄ × 2 ³/₄ × 7/8 in.)

(w/h/d, excluding projecting parts)

Approx. 68 × 77.5 × 30.7 mm

(2 ³/₄ × 3 ¹/₈ × 1 ¹/₄ in.)

(w/h/d, including projecting parts)

Mass

Approx. 79.9 g (2.8 oz) (including battery)

Accessories

See page 6.

Optional accessories

USB storage media "pavit"

AZ-RM128P: 128 MB

AZ-RM256P: 256 MB

Design and specifications are subject to change without notice.

Index

A, B

Backlight 22

Battery 7

Beep 21

C

Cleaning 24

Countdown timer 20

D, E

Display 10, 22

F, G

Format 26

H, I, J, K

Headphones

connect 11

extension cord 14

precautions 24

HOLD 21

L

Locking the controls (HOLD) 21

M, N, O

M.D.S.E (MP3 Digital Sound Enhancer) 15

MP3 4, 5

P, Q

“pavit” 4, 5

insert 11

remove 13

Playback 11

Preset 17, 18

R

Radio 16

Repeat 15

Reset 25

S

Shuffle 15

Sound 15

Stopwatch 19

T, U

Troubleshooting 25

V, W, X, Y, Z

Volume 12, 13

For the customers in the USA

For assistance and information

visit us on the internet at

www.us.aiwa.com

call toll free 1-800-BUY-AIWA
(United States only)

<http://www.aiwa.com/>

Sony Corporation Printed in Korea