



BODiBEAT

BODY. MUSIC. IN SYNC.

BF-1 Owner's Manual

The "Precautions" section is located on pages 6 – 7. Please read this carefully before using the BODiBEAT BF-1.

This manual may be revised and updated without prior notice. To download the latest manual, visit our website at:

<http://www.yamaha.co.jp/manual/>

Starting Up

Exercising

Computer

Music Player

Settings

Troubleshooting

Menu Tree

Index

Ver. 1.0.c

Congratulations!

Thank you for purchasing the Yamaha BODiBEAT BF-1 Interactive Music Player. If you're a music lover who enjoys exercising along with music, you'll find that the many functions and features of the BF-1 not only make exercising fun but also make it much more effective. We recommend that you read this manual carefully so that you can fully take advantage of the advanced and convenient functions of the BF-1 and safely enjoy your exercise sessions with it.

How to Use the Manual

Included with the BF-1 are three operating manuals: Quick Guide, BF-1 Owner's Manual, and BODiBEAT Station Owner's Manual. The BF-1 Owner's Manual and the BODiBEAT Station Owner's Manual are included in the CD-ROM. Both can also be viewed from the [Help] menu of the BODiBEAT Station.

Quick Guide

The Quick Guide is designed primarily for users who want to start exercising with the BF-1 as quickly and easily as possible. It provides simple instructions on setting up the BF-1 for first-time use as well as basic operations.

BF-1 Owner's Manual (this manual; PDF)

The Owner's Manual provides complete, detailed information and instructions for using the BF-1. Use the table of contents to locate features and functions you want to use, and use the Menu Tree to locate information about items that appear on the BF-1's display.

BODiBEAT Station Owner's Manual (PDF)

This is the manual for the included "BODiBEAT Station" software. Make sure to read this manual when using BODiBEAT Station.

Using the PDF manual

- Click on one of the color tabs at the right of each page to go to the desired section or chapter (including Troubleshooting, Menu Tree and Index).
- From the Contents box on the top page, click on the desired topic to automatically jump to the corresponding page.
- If you want to find information on a specific topic, function or feature, select "Find" or "Search" from the Adobe Reader "Edit" menu and enter a key word to locate the related information anywhere in the document.
- You can also click on desired items and topics you want to refer to in the "Bookmarks" index to the left of the main display window, and jump to the corresponding page. (Click the "Bookmarks" tab to open the index if it is not displayed.)

NOTE

The names and positions of menu items may vary according to the version of Adobe Reader being used.

Starting Up

Exercising

Computer

Music Player

Settings

Troubleshooting

Menu Tree

Index

About the indications

DANGER / WARNING / CAUTION

These indicate important information you need and precautions you must take to avoid problems and damage during use.

IMPORTANT

This indicates information and precautions that may be crucial regarding the relevant operation.

HINT

This indicates helpful information and tips for getting the most out of your use of the BF-1.

NOTE

This indicates supplemental information.

Continue to next page

This indicates that the instructions are continued on the next page.

SPECIAL NOTICES

- Copying of the commercially available musical data is strictly prohibited except for your personal use.
- This owner's manual is the exclusive copyrights of Yamaha Corporation.
- The illustrations and displays as shown in this owner's manual are for instructional purposes only, and may appear somewhat different from those on your device.
- Windows is a registered trademark of Microsoft® Corporation in the United States and other countries.
- The company names and product names in this owner's manual are the trademarks or registered trademarks of their respective companies.

Included Accessories

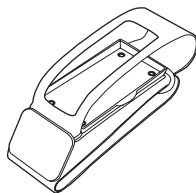

Armband



Earphones
(with pulse sensor)

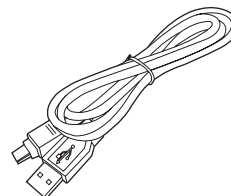

USB cable



Cable clip



Earphone
Pads



Quick Guide

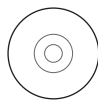

CD-ROM



User
Registration
Card



Safety
Information

Starting Up

Exercising

Computer

Music Player

Settings

Troubleshooting

Menu Tree

Index

Contents

Starting Up

Exercising

Computer

Music Player

Settings

Troubleshooting

Menu Tree

Index

How to Use the Manual 2
 Included Accessories 3
 PRECAUTIONS 6

Starting Up 8

Charging the Battery 9
 Panel Controls 10
 Turning the Power On / Making Initial Settings 12
 Control Hold 15
 Turning the Power Off 16
 Putting on the BF-1 17
 Attaching the armband 17
 Putting on the earphones and pulse sensor 19
 Basic Operations 22
 Moving the cursor highlight 22
 Selecting a menu item 22
 Changing a setting or parameter value 23
 About the Display Icons 23

Exercising with the BF-1 24

Walking/Jogging at Your Own Pace—Free Workout Mode 25
 Exercising with Free Workout 26
 Goal Setting and Music Selection 27
 After a Free Workout session 29
 Fitness Modes—Walk Fitness and Jog Fitness 30
 Exercising with the Fitness modes 31
 Exercising According to a Training Program—Training Mode 35
 Exercising with preset programs 35
 Creating a new program 37
 Editing the preset (or already created) Program 39
 Deleting a program 41
 Operation During Exercise 42
 Checking the Exercise Logs 45
 Using the BF-1 in Guest Mode 47

Connecting to a Computer 49

About the BODiBEAT Station Software 50
 System Requirements 51
 Installation 51
 How to Connect 52
 Removing the device from the computer 52
 Loading Music Data to the BF-1 53
 Updating the BF-1 53

Using the BF-1 as a Music Player—Music Playback Mode 54

- Selecting Songs 55
 - Playing the songs from an artist or album—Artist/Album 55
 - Playing a single song—Songs 56
 - Playing the songs from a Playlist—Playlists 57
- Basic Operations in Music Playback Mode 58**
 - Fast-forward and reverse 58
 - Adjusting the Volume 59
 - Exiting from the Play Info Display 59
 - Returning to the Play Info Display 59

Settings 60

- Music Settings 61**
 - Workout Music 61
 - Play Mode—Repeat and Shuffle 65
 - Bass Boost 65
- Hardware Settings 66**
 - Sensors 66
 - Display 68
 - Date/Time 70
- User Settings 71**
 - Heart Rate 71
 - Stride 73
 - Weight/Height 73
 - Birthday/Sex 74
 - Learning Function 74
- Information 76
- Initialize 76

Appendix 77

- Troubleshooting 77
- Menu Tree 80
- BF-1 Preset Training Programs 81
- Specifications 84
- Index 86

FYI	
What is 'Effective' Aerobic Exercise?	33
About heart rate reserve	38
About the BODiBEAT songs	62
About Maximum Heart Rate	72

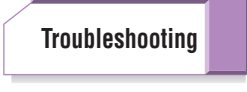
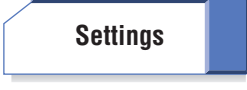
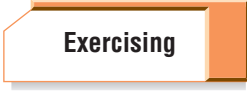

PRECAUTIONS

PLEASE READ CAREFULLY BEFORE PROCEEDING

* Please keep this manual in a safe place for future reference.

DANGER

Make sure to always observe the basic precautions listed below to prevent the likelihood of serious injury or even death from electrical shock, short-circuiting, damage, fire or other hazards. These precautions include, but are not limited to, the following:

Do not open

- Do not disassemble the device or modify it in any way. This can result in the device bursting, or even an explosion or fire. If the device should appear to be malfunctioning, discontinue use immediately and have it inspected by qualified Yamaha service personnel.

Water related

- Do not drop the device into the water.

Fire related

- Do not throw the device into a fire, or put burning items near the device.

Handling

- Do not use or expose the device to extreme heat (such as direct sunlight, near a heater or in a car during the day) to prevent the possibility of explosion, fire or bursting. Charge the device and use it in temperature conditions between 0° to 40°C (32° to 104°F) and keep in an environment of between -10° to 45°C (14° to 113°F).
- Do not operate the device or use earphones while driving a car or riding a motorcycle or a bicycle, since this could result in a serious accident.
- To avoid accidents while walking or jogging, keep the volume low enough to hear outside traffic sounds and avoid concentrating too closely on the display.

If you notice any abnormality

- If there is a sudden loss of sound during use of the device, or if any unusual smells or smoke should appear to be caused by it, immediately turn off the power switch and have the device inspected by qualified Yamaha service personnel.

WARNING

Always follow the basic precautions listed below to avoid the possibility of serious injury or even death from electrical shock, short-circuiting, damages, fire or other hazards. These precautions include, but are not limited to, the following:

When exercising

- If you are not in good physical condition (chronic illness, during pregnancy, or other abnormal conditions), consult your physician before beginning any exercise.
- If exercising causes you any pain or discomfort, immediately get rest and consult a physician if necessary.
- Make sure that any ear jewelry or accessories you wear do not interfere with the pulse sensor for accurate heart rate readings. Wearing earrings may cause inaccurate heart rate detection, which can result in your workout being too strenuous or not strenuous enough.

Starting Up

Exercising

Computer

Music Player

Settings

Troubleshooting

Menu Tree

Index

Handling

- Keep the device in a place out of the reach of small children.
- Never insert paper, metallic, or other objects into the device. If this happens, turn off the power immediately, and then have the device inspected by qualified Yamaha service personnel.

AC Power Adaptor (Optional)

- Only use the voltage specified as correct for the adaptor. The required voltage is printed on the adaptor.
- Use the specified adaptor (PA-U010 or an equivalent recommended by Yamaha) only. Using the wrong adaptor can result in damage to the device or overheating.
- Check the electric plug periodically and remove any dirt or dust which may have accumulated on it.

CAUTION

Always follow the basic precautions listed below to avoid the possibility of physical injury to you or others, or damage to the device or other property. These precautions include, but are not limited to, the following:

Handling

- Do not use or expose the device to excessive dust, or extreme cold. Doing so may cause the device to malfunction.
- Do not rest your weight on, or place heavy objects on the device, and do not use excessive force on the buttons, switches, connectors or earphone cable.
- Do not touch the connector with wet hands. If the device gets wet inside from the connector, it may cause the device to malfunction.
- Take care not to tangle the earphone cable around your body or neighboring objects, since this can cause injuries or accidents.
- Do not use the device or earphones for a long period of time at a high or uncomfortable volume level, since this can cause permanent hearing loss. If you experience any hearing loss or ringing in the ears, consult a physician.
- Some people may experience an abnormal sensation or discomfort on their skin. If this should occur, stop using the device and consult a physician.

AC Power Adaptor (Optional)

- Unplug the AC power adaptor from the wall AC outlet when you are not using the device for a long time, or during electrical storms.
- Do not try to exercise with the device while charging. Doing so may cause the device to malfunction. Moreover, the USB cable may get tangled up with your body and result in injury.

Maintenance

- When cleaning the device, use a soft, dry cloth. Do not use paint thinners, solvents, cleaning fluids, or chemical-impregnated wiping cloths.

• Yamaha cannot be held responsible for damage caused by improper use or modifications to the device.

• Yamaha cannot be held responsible for any health problems during exercise with the device. Take full responsibility for your own health.



Li-ion

This device contains a lithium-ion battery. After usage, you may recycle the battery, but never attempt to remove it by yourself. Have the device inspected by qualified Yamaha service personnel. If there is no Yamaha service personnel in your area, dispose of it properly according to relevant environmental laws and disposal rules in your area.

Starting Up

Exercising

Computer

Music Player

Settings

Troubleshooting

Menu Tree

Index



Starting Up

Exercising

Computer

Music Player

Settings

Starting Up

This section provides the basic information you'll need to set up the BF-1 and start using it. Make sure that you carefully read through all of the sections below before starting to use the device.

Contents

Charging the Battery	9
Panel Controls.....	10
Turning the Power On / Making Initial Settings.....	12
Control Hold	15
Turning the Power Off.....	16
Putting on the BF-1	17
Attaching the armband	17
Putting on the earphones and pulse sensor	19
Basic Operations	22
Moving the cursor highlight.....	22
Selecting a menu item	22
Changing a setting or parameter value.....	23
About the Display Icons	23

Troubleshooting

Menu Tree

Index



Charging the Battery

You will need to charge the BF-1 before you use it for the first time. To charge the battery of the BF-1, simply connect it to a computer with the included USB cable. Make sure the computer is on and running.

IMPORTANT

For further details on connecting with a computer, refer also to [page 52](#).

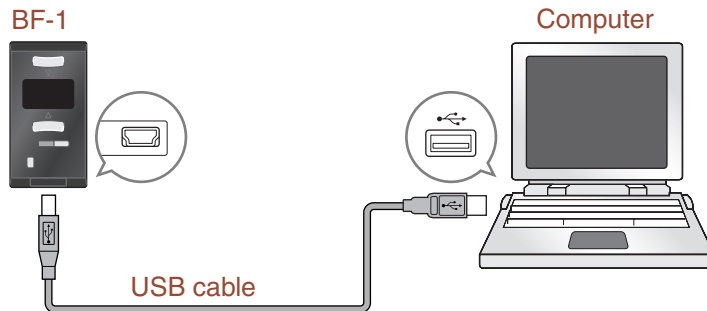

You can also charge the battery using the optional PA-U010 AC adaptor and the included USB cable.

NOTE

The optional AC adaptor may not be available depending on your particular area. Please check with your Yamaha dealer.

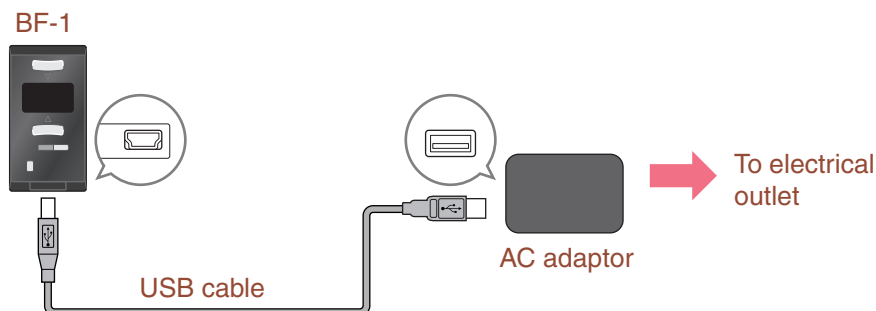





DANGER

Do not charge the battery in extremely cold or hot environments. You should charge it in a temperature conditions of between 0° to 40°C (32° to 104°F). Recharging the battery in high temperatures may result in fire or an explosion.

CAUTION

Make sure to only use the USB cable included with the device. Use of any other cable may damage the BF-1 or cause the unit to malfunction.

You can check the remaining battery power and charging status with the battery icon at the top right of the display.

-  Battery is being charged.
-  Battery power is full. The device is ready for use.
-  Battery power is a little low.
-  Battery power will soon run out. Charge the battery.
-  Battery is empty. Immediately charge the battery.

NOTE

Complete charging of the battery from no power to being fully charged takes about three hours.

Starting Up

Exercising

Computer

Music Player

Settings

Troubleshooting

Menu Tree

Index



Panel Controls

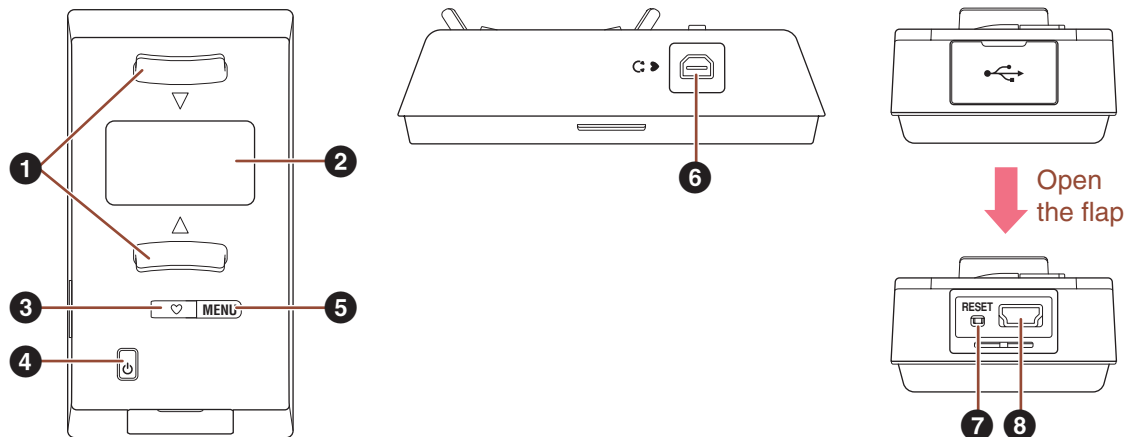

Starting Up

Exercising

Computer

Music Player

Settings

1 ▲/▼ (Up/Down) buttons

These are used for navigating through menu items and parameters in the display, and also for changing parameter values and settings. Pressing both at the same time allows you to select or call up a highlighted item.

2 Display

This shows all indications for operation and use of the BF-1. If you haven't used any of the panel controls for a while, the display automatically turns off in order to save battery power (page 69). When the display turns off, simply press any key to turn it on again.

3 LED

While one of the exercise modes is active and the pulse sensor is properly attached (page 20), this flashes in time with your heart rate. If your heart rate is fast (or the exercise intensity is too strenuous—i.e., the %HRR is more than 75%), the LED flashes in red. When your exercise pace is optimal (%HRR is between 55% and 75%), the LED flashes in green. If your heart rate is slow (the exercise intensity is low—i.e., the %HRR is lower than 55%, or you are not exercising), the LED flashes in blue. In all other situations, the LED is off.

NOTE

For details of %HRR, refer to page 38.

4 [⏻] (Standby/On) button

This is used to turn the power on and off. (Turning the power off is actually done with the Hold Wizard operation; see page 16.)

5 [MENU] button

Pressing this returns to the previous display menu. Holding it down for two seconds returns to the Top Menu (the highest level menu).

Troubleshooting

Menu Tree

Index



6 Earphone/ear clip connector

For connection to the special earphone/ear clip. (See [page 17](#).)

7 [RESET] switch

This small switch (behind the flap at the lower part of the device) lets you reboot the BF-1 in case of some kind of operational trouble—for example, if the device “freezes” or hangs up. Use a small, thin tool to press the switch, such as a miniature screwdriver or a ballpoint pen.

CAUTION

When the [RESET] switch is pressed, noise may be produced because of the sudden flow of electricity. Before pressing the [RESET] switch, remove the earphones from your ears.

8 USB connector

This is for connection to a computer (via USB) or to the optional AC adaptor. (See [page 9](#).)

[Starting Up](#)[Exercising](#)[Computer](#)[Music Player](#)[Settings](#)[Troubleshooting](#)[Menu Tree](#)[Index](#)



Turning the Power On / Making Initial Settings

The first time you turn on the power of your new BF-1, the device conveniently and automatically guides you through several important settings. These include the display language, correct time and date, as well as personal information such as your birthday, weight, height and resting heart rate. You'll need to make these settings before you can effectively use the BF-1. Once you've entered this data, the BF-1 becomes your own personal exercise device, customized with your unique settings.

NOTE

If the display turns off at any time while you're making the initial settings, simply press any key to turn it on again.

Operation

1 Press the [⏻] (Standby/On) button to turn on the power.

If you are turning on the power for the first time (or you have reset the device; see [page 76](#)), the Language display will appear. This determines the language for all messages and indications on the BF-1. Five languages are available: English, Japanese, German, Spanish and French.



NOTE

When you are turning on the power for the second time or after, the Top display ([page 14](#)) will appear.

2 Use the ▲/▼ (Up/Down) buttons to select the desired language.

3 Simultaneously press both ▲/▼ (Up/Down) buttons to enter the selection.

The following display appears.



NOTE

Throughout the rest of this manual, all operations and example displays are given in English.

4 Select "Set Up" then press both ▲/▼ (Up/Down) buttons simultaneously to start making the initial settings.

The following displays will appear in succession. Follow the instructions in each of the displays, making the necessary settings and entering the relevant information.

NOTE

If you want to use the device immediately without making any initial settings, select "Try" here. This calls up the Guest mode. Refer to the Guest mode instructions ([page 47](#)).

Starting Up

Exercising

Computer

Music Player

Settings

Troubleshooting

Menu Tree

Index



■ Date/Time

This lets you set the correct date and time for the BF-1, as well as the preferred format for each.



Use the ▲/▼ (Up/Down) buttons to change the setting then simultaneously press both ▲/▼ (Up/Down) buttons to enter the change.

The cursor automatically moves to the next parameter. After you finish all the settings, go on to the next display.

NOTE

The set Time is entered at the moment you press both ▲/▼ (Up/Down) buttons when the cursor is located at the AM/PM position.

■ Birthday/Sex

This lets you enter your birthday and gender. Your birthday in particular is important, since it determines the physical age the BF-1 uses in its calculations.



Use the ▲/▼ (Up/Down) buttons to change the setting then simultaneously press both ▲/▼ (Up/Down) buttons to enter the change.

The cursor automatically moves to the next parameter. After you finish all the settings, go on to the next display.

■ Weight/Height

This setting lets you enter your personal weight and height. Measure the two as accurately as possible, since these are used by the BF-1 in its calculations.

NOTE

The units of measurement used here when you make these settings are pounds and feet, but the corresponding values in kilograms and meters are shown at the bottom of the display.



Use the ▲/▼ (Up/Down) buttons to change the setting then simultaneously press both ▲/▼ (Up/Down) buttons to enter the change.

The cursor automatically moves to the next parameter. After you finish setting both parameters, go on to the next display.

Starting Up

Exercising

Computer

Music Player

Settings

Troubleshooting

Menu Tree

Index



■ Heart Rate

This lets you register your resting heart rate and maximum heart rate. The resting heart rate can be simply measured by placing your fingers on your wrist and counting the pulse during one minute, or by counting the pulse over 15 seconds and multiplying by four. (Make sure you're relaxed and have not been exercising before taking your pulse.) After taking your pulse, enter the resting heart rate value in this display. This setting can be changed afterward if necessary by measuring pulse with the included pulse sensor (page 71).

If you don't know your maximum heart rate, it is unnecessary to enter it here; it is automatically calculated from your age by default.

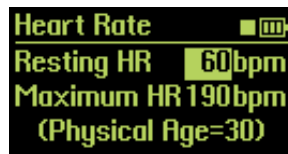

Use the ▲/▼ (Up/Down) buttons to change the setting then simultaneously press both ▲/▼ (Up/Down) buttons to enter the change.

The cursor automatically moves to the next parameter. After you finish setting both parameters, go on to the next display.

NOTE

For details about resting heart rate and maximum heart rate, refer to pages 71 and 72.

Congratulations!

You've now made all necessary initial settings, and can now go on to using your new BF-1.

The Top Menu of the BF-1 is automatically called up. Select one of the modes from the Top Menu (referring to the appropriate section of this manual), and start exercising!



Starting Up

Exercising

Computer

Music Player

Settings

Troubleshooting

Menu Tree

Index



Control Hold

This feature lets you “freeze” the panel controls of the BF-1 so that you don’t inadvertently change any settings while you’re exercising. While Control Hold is active, the [MENU] button and the ▲/▼ (Up/Down) buttons are inactive. Only the [⏻] (Standby/On) button can be used.

Operation

1 While the power is on, press the [⏻] (Standby/On) button.

The “Hold Wizard” appears. This menu contains two items: Power off and Hold.



NOTE

If you want to cancel the operation, press the [MENU] button.

2 Use the ▲/▼ (Up/Down) buttons to select “Hold” then press both buttons simultaneously to turn the Hold function on.

■ To turn Control Hold off:

1 While the power is on, press the [⏻] (Standby/On) button.

The “Hold Wizard” appears. This menu contains two items: Power off and Hold off.

2 Select “Hold off” then press both buttons simultaneously to turn Hold off.

Starting Up

Exercising

Computer

Music Player

Settings

Troubleshooting

Menu Tree

Index



Turning the Power Off

You can turn the power of the BF-1 off in two different ways:

Press and release the [] (Standby/On) button. When the menu shown below appears, Use the ▲/▼ (Up/Down) buttons to select “Power off.”



NOTE

If you want to cancel the operation, press the [MENU] button.

Press and hold down the [] (Standby/On) button for roughly two seconds until the display shown below appears.

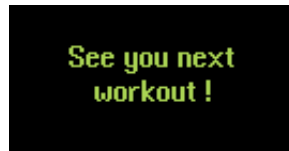

NOTE

If no song is played or no operation is performed within 30 minutes, the power is automatically turned off.

Starting Up

Exercising

Computer

Music Player

Settings

Troubleshooting

Menu Tree

Index



Putting on the BF-1

Starting Up

Exercising

Computer

Music Player

Settings

Attaching the armband

■ Attaching the BF-1 to the armband

1 Connect the earphone cable to the BF-1.

Be sure to push the earphone connector all the way in until it fits into place.

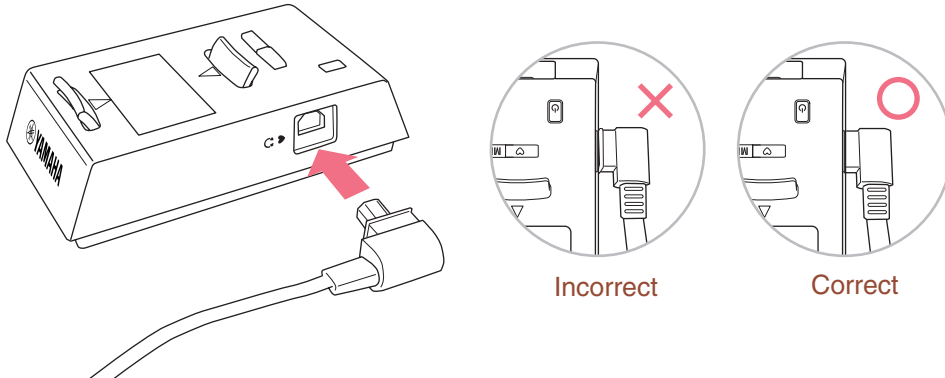

⚠ CAUTION

- Do not unplug the earphone cable from the BF-1 while using it. If rain, sweat or any other liquid gets inside the BF-1 through the earphone terminal, the device could be damaged.
- When disconnecting the earphone cable, hold the connector directly and pull it. Do not pull on the cable.

2 Attach the device to the armband.

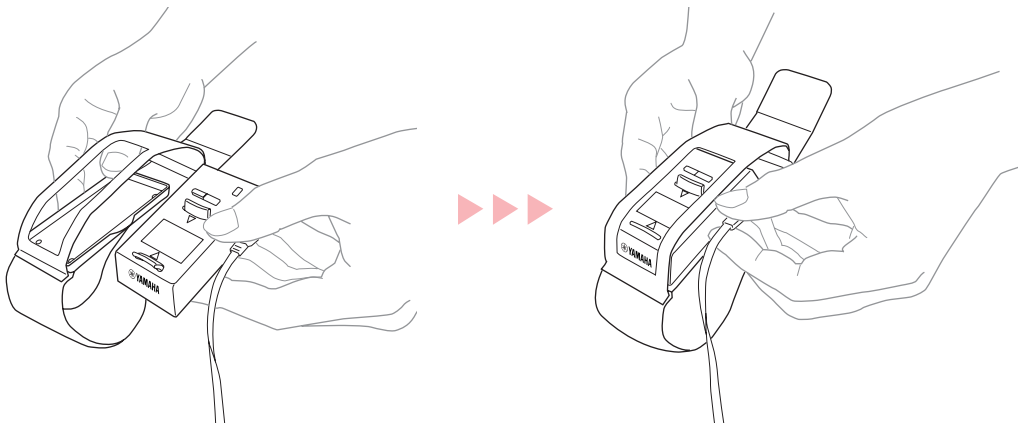

i IMPORTANT

- Make sure that the YAMAHA logo can be seen at the top of the arm band. This is the proper orientation for fitting to the armband.
- Insert the BF-1 fully until a click sound is heard.

Troubleshooting

Menu Tree

Index



■ Attaching the armband to your arm

i IMPORTANT

Make sure to wear the arm band only when the BF-1 is also inside. The band cannot be adjusted if the armband is empty.

1 Loosen the armband and put your left arm into the armband.

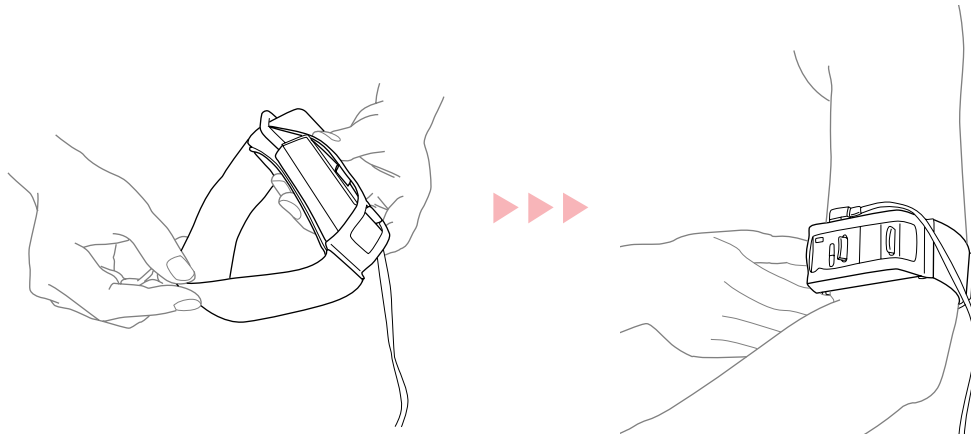

2 Fasten the armband to your upper arm, just above your elbow.

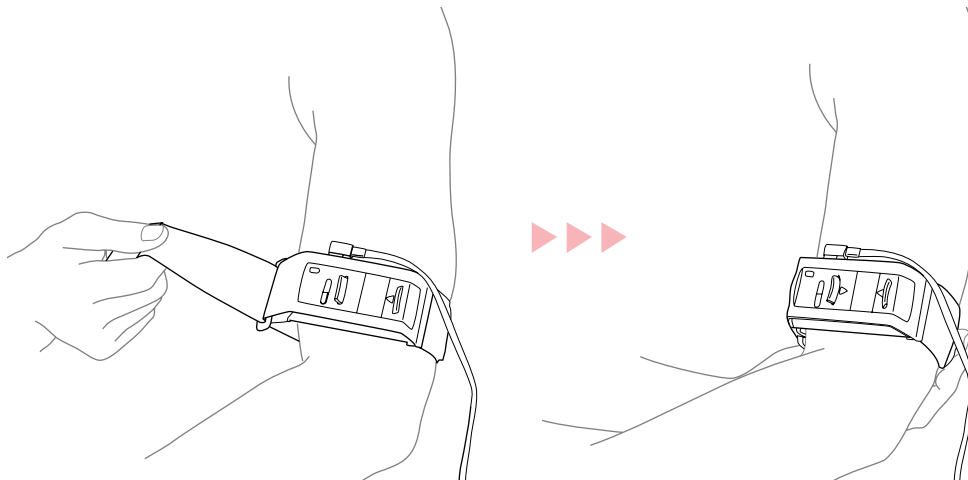

i IMPORTANT

- Adjust the armband into position so that you can easily see the display.
- Do not wear the armband anywhere on your body other than your upper arm (for example, your neck, wrist, ankle, etc.). Doing so may cause the motion sensor to not function properly.
- Make sure to wear the BF-1 above your elbow. The sensor in the unit that measures vibration during your exercise will not function properly if the device is worn below the elbow.
- Do not fasten the armband too tight or too loose. If it's too tight, it may cause discomfort and even harm you; too loose, and the motion sensor may not function properly, or the device may fall off your arm.



Starting Up

Exercising

Computer

Music Player

Settings

Troubleshooting

Menu Tree

Index



■ Removing the BF-1 from the armband

Push the tab down and pull the device up and out.

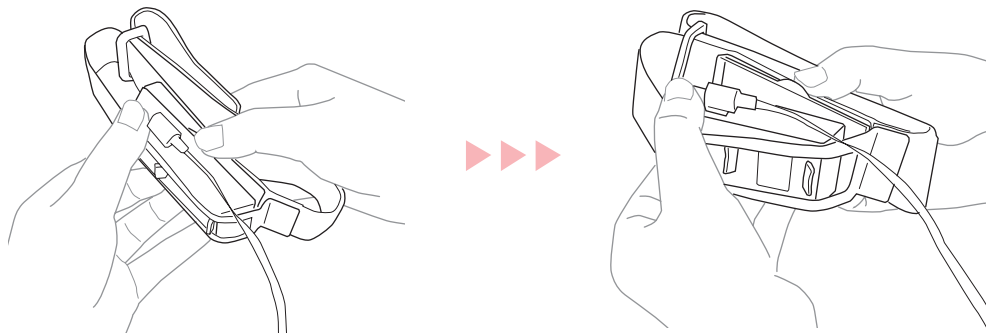

■ Proper care of the armband

The armband requires little care, but if it gets dirty, wash it gently by hand with water. Make sure to dry it completely before using again.

Starting Up

Exercising

Computer

Music Player

Settings

Putting on the earphones and pulse sensor

i IMPORTANT

Make sure not to confuse the right (R) and left (L) earphones. The set cannot be worn properly in reverse.

1 Hook the earphone cable over the top of your ear.

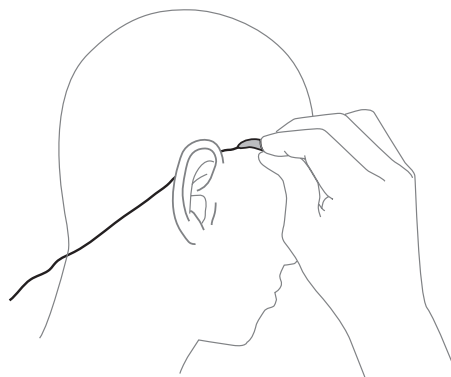

2 Insert the earphone into your ear.

NOTE

For comfort and better fit, you may want to apply the earphone pads to the earphones before wearing them.

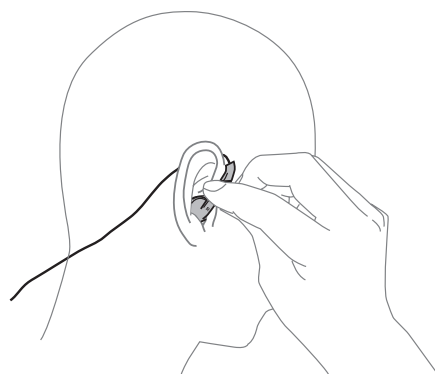

Troubleshooting

Menu Tree

Index

Continue to next page



3 Adjust the earphone angle as desired.

Do the same for both earphones and both ears.

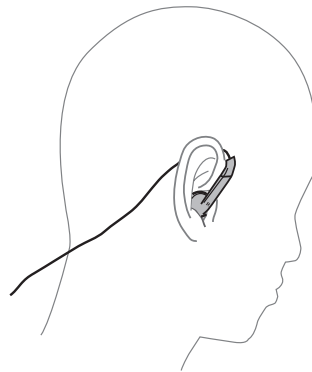

i IMPORTANT

The proper position is with the earphone tilted slightly against the ear. However, each individual's ears may differ somewhat, so you should adjust this for maximum comfort and optimum listening.

4 Clip the pulse sensor onto your left ear lobe.

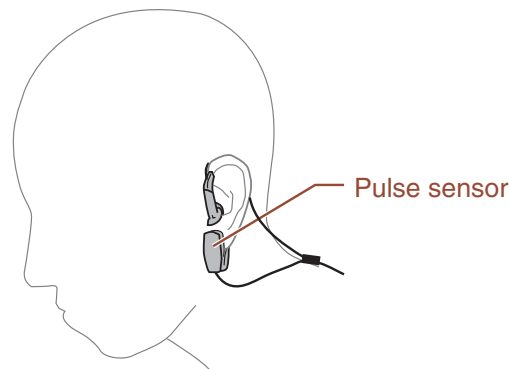

While one of the exercise modes is active, the lamp on the device will flash in time with your heart rate (page 10).

HINT

If your heart rate cannot be detected, try:

- Gently rubbing or massaging your ear to stimulate blood circulation.
- Changing the pulse sensor location.
- Adjusting the sensitivity of the pulse sensor (page 66).

5 Slide the cable tightener toward your head.

Doing this helps fit the earphone set more snugly to your neck and head. Adjust the tightener to the most comfortable position.

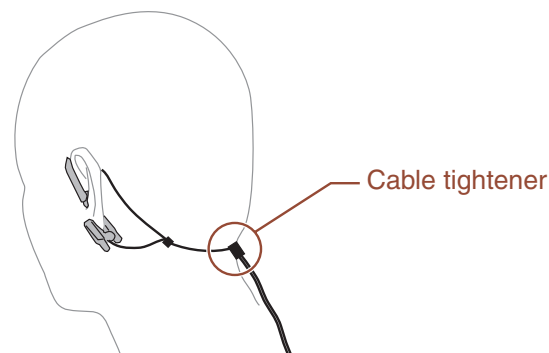

Starting Up

Exercising

Computer

Music Player

Settings

Troubleshooting

Menu Tree

Index



■ Using the cable clip

If the cable is too long and gets in your way while you are exercising, bind the excess cable with the convenient cable clip.

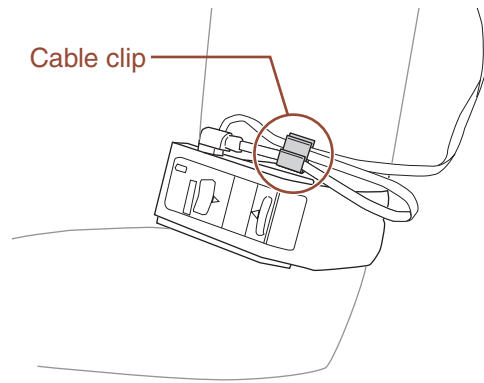

If desired, you can also attach the cable to your clothing using the cable clip.

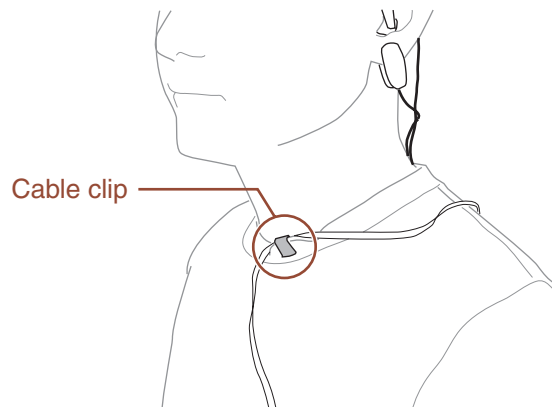

Starting Up

Exercising

Computer

Music Player

Settings

Troubleshooting

Menu Tree

Index



Basic Operations

In this section, you'll learn how to use the controls of the BF-1 for the basic operations of the device. These include moving the cursor highlight, selecting menu items, and changing settings and parameter values.

You should thoroughly read and understand this section, since the other instructions in the manual assume you are familiar with the basic operations.

Moving the cursor highlight

Press the ▲ (Up) button to move the cursor highlight up in the menu or press the ▼ (Down) button to move down.

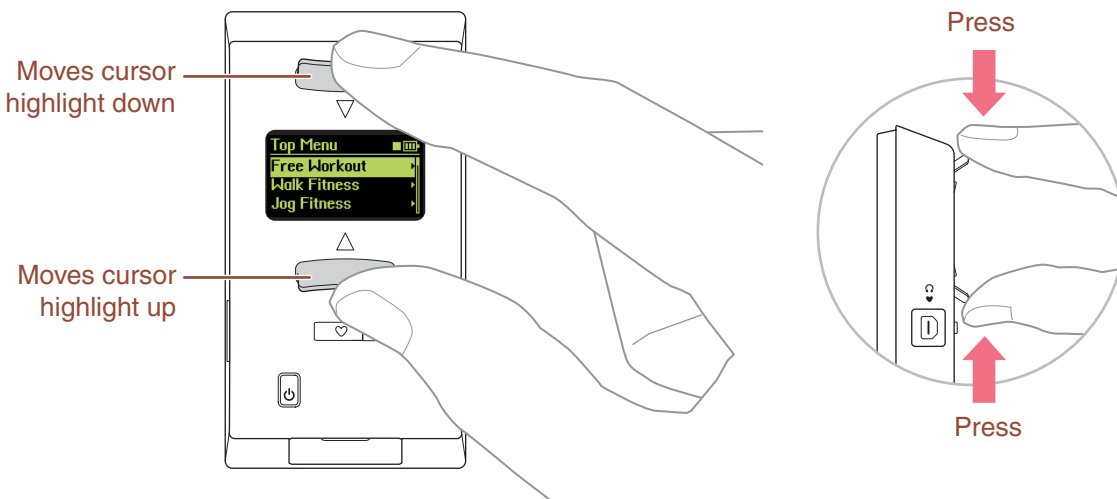

NOTE

If the menu contains 4 or more items, a scroll bar appears at the right of display.

Selecting a menu item

Use the ▲/▼ (Up/Down) buttons to move the cursor highlight to the desired item, then simultaneously press both ▲/▼ (Up/Down) buttons to actually select or call up the item.



The Free Workout menu is selected from the Top Menu.

Starting Up

Exercising

Computer

Music Player

Settings

Troubleshooting

Menu Tree

Index



Changing a setting or parameter value

- 1 When you call up a display that has settings or parameters you can change, the first available parameter will automatically be selected. (The cursor highlight flashes, indicating it can be changed.)

Weight value flashes, indicating it can be changed.



- 2 Use the ▲/▼ (Up/Down) buttons to change the selected setting or value.

Press the appropriate button once to change the setting. For numeric values, each press increments or decrements the value accordingly. To make large changes to a number, hold down either button.

- 3 Press both ▲/▼ (Up/Down) buttons together to actually enter the change and move to the next setting or parameter.

Continue in this way until all settings and parameters on the display have been set.

If you want to return to the previous parameter and change the setting you've made, press [MENU] button.

About the Display Icons

Shown at the top of the display are some icons which indicate the status of the BF-1.



①		Shuffle (page 65)
②		Repeat (page 65)
③		Play
		Pause
		Stop
④		Remaining battery power (page 9)

Starting Up

Exercising

Computer

Music Player

Settings

Troubleshooting

Menu Tree

Index



Starting Up

Exercising

Computer

Music Player

Settings

Exercising with the BF-1

The BF-1 is a unique music player designed specifically for listening while exercising. It features a variety of sophisticated functions that tailor the music to your exercising. The BF-1 monitors your heart beat and walking/jogging steps, and automatically selects music of exactly the right tempo for your exercise. It also gives you comprehensive, detailed training programs that use the music and tempo to fully guide you through an exercise session—like an expert coach or trainer.

The BF-1 has three basic Exercise modes: Free Workout, Walk/Jog Fitness, and Training.

Contents

Walking/Jogging at Your Own Pace—Free Workout Mode	25
Exercising with Free Workout	26
Goal Setting and Music Selection.....	27
After a Free Workout session.....	29
Fitness Modes—Walk Fitness and Jog Fitness	30
Exercising with the Fitness modes	31
FYI What is ‘Effective’ Aerobic Exercise?.....	33
Exercising According to a Training Program—Training Mode.....	35
Exercising with preset programs.....	35
Creating a new program	37
FYI About heart rate reserve	38
Editing the preset (or already created) Program.....	39
Deleting a program	41
Operation During Exercise	42
Checking the Exercise Logs.....	45
Using the BF-1 in Guest Mode.....	47

Troubleshooting

Menu Tree

Index



Walking/Jogging at Your Own Pace—Free Workout Mode

In the Free Workout mode, the BF-1 automatically matches the music to your exercise pace, selecting songs that have almost the same tempo as your jogging or walking speed. When you change pace, the music changes with you. This lets you jog freely and set your own pace—and enjoy music that perfectly fits your pace.

If you want to constrain the length of your exercise session, you can use the Goal Setting parameters to automatically stop music playback once you've reached the desired target. You can set the target to be a specific time, a specific distance, or the amount of calories you wish to burn off. (Only one of the targets can be set and be in effect for a session.)

To call up the Free Workout mode:

Select “Free Workout” from the Top Menu.

[Starting Up](#)[Exercising](#)[Computer](#)[Music Player](#)[Settings](#)[Troubleshooting](#)[Menu Tree](#)[Index](#)



Exercising with Free Workout

The Free Workout mode is an easy, convenient way to exercise using the versatile tempo changing features of the BF-1, since it automatically matches the music to your exercise pace.

NOTE

Keep in mind that it takes a few seconds to detect your pace and call up a song that matches your pace.

HINT

If you find that few songs matching your pace are called up, adjust the sensitivity of the step sensor (page 67).

Operation

1 From the Free Workout menu, select “Start,” then start jogging or walking.

You can set the goal setting (targets for your exercise) and/or select a specific music playlist for the session. If you want to do so, select “Setting” here and go to [page 27](#) (Goal Setting and Music Selection).

Once you set the goal setting, it will be shown in the “Start” menu the next time you use the device, enabling you to continue with the same exercise settings as before.

IMPORTANT

If the pulse sensor is not attached properly or accidentally slips off, a “Measurement Error!” message appears. Reattach the pulse sensor properly and select “Try again” in the menu to continue your exercise session. If you select “Don’t measure HR” here, the exercise session continues, but heart rate is not memorized in the exercise log ([page 29](#)).

NOTE

For playback of certain songs (and depending, of course, on the characteristics of those songs), you may find that the song tempo does not match your pace. If this is the case, you can manually correct the tempo information with the BODiBEAT Station software. For details, refer to the BODiBEAT Station Owner’s Manual.

2 While you’re jogging or walking, you can change the volume of the music, select different songs, or lock the pace.

See “Operation During Exercise” on [page 42](#).

3 Once the set target has been reached, music playback stops and your session is ended.

A log showing detailed information on your session automatically appears. (For more about the session log, see “After a Free Workout session” below.) If your exercise is an open-ended session or you want to stop the exercise before the specified target has been reached, you can also stop the session manually by simultaneously holding both the ▲/▼ (Up/Down) buttons. This ends the session and calls up the log display.

NOTE

When the Learning Function ([page 74](#)) is set to on, a confirmation message will appear before the log display appears and prompts you to update the maximum heart rate and tempo.

Starting Up

Exercising

Computer

Music Player

Settings

Troubleshooting

Menu Tree

Index



Goal Setting and Music Selection

The Goal Setting parameters let you set a certain time period for your session, the distance to be covered, or the number of calories to be expended. The BF-1 then automatically stops playback once the desired target has been reached.

The Goal Setting values feature several preset settings for convenience. A “Custom” setting is also available for each, allowing you to freely set the desired target.

After the Goal Setting is done, you can select the desired music (all songs or specific Playlists) from the Goal Setting display above when some playlists exist in the BF-1.

Operation

1 From the Free Workout menu, select “Setting.”

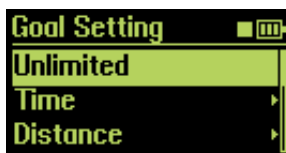

2 Select the desired setting: Time, Distance, Calories.

If you want a completely open-ended workout session, select “Unlimited” and skip to step 4.

3 Simultaneously press both ▲/▼ (Up/Down) buttons to call up the values for the selected setting, then set the target as desired.

Time

Available settings:

10, 20, 30, 45, 60, 90 (minutes), Custom

Distance

Available settings:

2, 5, 10 (miles), Half Marathon, Marathon, Custom

NOTE

When the units of measurement is set to “Meters” in the Measurement parameter (page 69), the available settings are:

3, 5, 10 (kilometers), Half Marathon, Marathon, Custom

Calories

Available settings:

100, 300, 500, 700, 1000 (K calories), Custom

NOTE

The amount of expended calories is calculated according to the following formula:
Calories for walking (kcal) = 0.0005 x Speed (meter/min) x Weight (kg) x Time (min)
Calories for jogging (kcal) = 0.001 x Speed (meter/min) x Weight (kg) x Time (min)
(The basal metabolic rate for the exercise period is not included in this formula.)

To enter a custom setting, first select “Custom” from the Time, Distance or Calories menu. Then change the value with the ▲/▼ (Up/Down) buttons and enter it by simultaneously pressing both ▲/▼ (Up/Down) buttons.



Continue to next page

Starting Up

Exercising

Computer

Music Player

Settings

Troubleshooting

Menu Tree

Index



4 From the appropriate Goal Setting menu, go to the Music Select menu.

If you've selected the Unlimited setting (in step 2 above):
Simultaneously press both ▲/▼ (Up/Down) buttons.

If you've selected the Time, Distance or Calories setting (in step 3 above):
Go to the setting display for the selected setting, and simultaneously press both ▲/▼ (Up/Down) buttons.

NOTE

When the Music Priority parameter (page 61) is set to "BODiBEAT Songs," the Music Select display is not displayed and operation returns to the previous display.

5 From the Music Select menu, select the desired setting.

Available settings:

All Songs, Playlist(s)

NOTE

Other Playlists will be shown here as you create them (using the included software) and load them to the BF-1. By default, the BF-1 has no custom music Playlists. However, it automatically creates two Playlists (Walk and Jog) when you first load your own songs to the device. The BF-1 automatically sorts the songs you've loaded according to tempo and assigns them to the appropriate Playlist.

NOTE

Even if you've selected a specific Playlist or "All Songs" in step 2 here, playback may be a mix of pre-loaded BODiBEAT songs and audio songs, or even only BODiBEAT songs. This would occur when:

- No songs of the appropriate tempo exist in the specified Playlist or among all songs on the device.
- The Music Priority parameter (page 61) has been set to "Mix," which means that audio songs and BODiBEAT songs are mixed in a 50/50 ratio. (The default setting of Music Priority is "User Songs," which means that only audio songs are played, unless no songs of the appropriate tempo exist.)

Starting Up

Exercising

Computer

Music Player

Settings

Troubleshooting

Menu Tree

Index



After a Free Workout session

Once your session is stopped (either automatically or manually), a log of the session automatically appears. This log shows important information about the session and your physical conditions. It also provides graphs showing the changes of your speed and heart rate during the session.

Keep in mind that you can use the convenient software included with the BF-1 to more easily manage, view and even print the logs and graphs of all your exercise sessions.

When the Free Workout session is stopped, the first log display appears:



Use the ▲/▼ (Up/Down) buttons to scroll through the display pages to view all log entries and graphs. The graph displays in pages 3/4 and 4/4 in particular give you easy-to-understand indication of how your pace and heart rate changed over the time of the session.



Indicates the Total Time and Total Distance for the session.

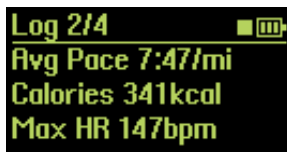

Indicates the Average Pace, Total Calories expended and Maximum Heart Rate for the session.



Shows in graph form the changes in your pace over the duration of the session.

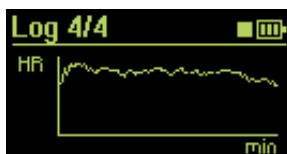

Shows in graph form the changes in your heart rate over the duration of the session.

NOTE

Since the distance, pace, calories or heart rate values in the logs are estimated based on the User Settings, they may differ from the actual values.

NOTE

These log displays are the same as those in the Data menu of the Top Menu, and can be viewed at any time from the Data menu (the logs of latest 99 workouts are saved in the device).

To exit from the Log display pages, press the [MENU] button to return to the Free Workout display or hold the [MENU] button to return to the Top Menu.

Starting Up

Exercising

Computer

Music Player

Settings

Troubleshooting

Menu Tree

Index



Fitness Modes—Walk Fitness and Jog Fitness

The Fitness modes provide the most appropriate music playback for optimal aerobic exercise. In that sense, they are similar to the Free Workout mode. However, they go much further, monitoring your heart rate and providing sophisticated ways of changing the music to give you a perfectly programmed, optimal aerobic workout—that matches your physical condition and the intensity of your exercise.

The built-in pulse sensor detects your heart rate as you exercise. Continuously and in real time, the BF-1 calculates the optimal exercise pace for you, given your physical condition—and then automatically changes the music to match your pace and heart rate. If your exercise is too strenuous and your heart rate is too high (higher than optimal), the BF-1 plays slower tempo music. Likewise, if your exercise is too easy and relaxed to provide adequate exercise benefits, the BF-1 plays faster music. This ensures that you get the best possible exercise—not too little, and not too much.

Each Fitness mode also features automatically programmed ‘warming up’ and ‘cooling down’ segments that effectively structure your exercise sessions and help you avoid unnatural stress and fatigue.

Since the Fitness modes monitor your heart rate, you will need to properly attach the pulse sensor. (For instructions, see [page 20](#).) You will also need to make sure other settings have been made, such as your actual age and resting heart rate ([page 71](#)).

There are two Fitness modes: Walk Fitness and Jog Fitness. Essentially, they function and operate exactly the same, except that Walk Fitness is specifically programmed for walking, while Jog Fitness is designed for the more strenuous and intense exercise you get while jogging. (However, slow tempo songs matched for walking may sometimes be played if your heart rate goes higher than optimal condition.)

To call up the Walk Fitness or Jog Fitness mode:

Select “Walk Fitness” or “Jog Fitness” from the Top Menu.

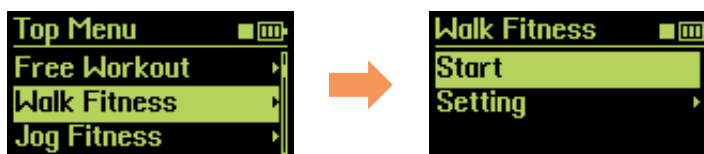

- Starting Up
- Exercising
- Computer
- Music Player
- Settings

- Troubleshooting
- Menu Tree
- Index



Exercising with the Fitness modes

The Fitness modes monitor your heart rate and take into account your maximum heart rate and resting heart rate to automatically program an optimal workout for you, changing the music to fit your condition and the intensity of the exercise. Before exercising, make sure that you've properly entered your birthday and resting heart rate (page 71).

Operation

1 From the Top Menu, select the mode depending on the type of exercise you'll be doing: Walk Fitness (walking) or Jog Fitness (jogging).

2 Make sure the pulse sensor is properly attached (page 20).

When it is properly attached, the LED will start flashing in time with your heart rate.

3 From the Walk Fitness or Jog Fitness menu, select "Start," then start your exercise with the tempo of the song that plays.

You can set the goal setting (targets for your exercise) and/or select a specific music playlist for the session. If you want to do so, select "Setting" here and go to page 27 (Goal Setting and Music Selection).

Once you set the goal setting, it will be shown in the "Start" menu the next time you use the device, enabling you to continue with the same exercise settings as before.

WARNING

In the Fitness modes, the device monitors your heart rate and provides a song at the optimum tempo. However, if you find it too strenuous to match your pace to the song, do not force yourself to keep pace. Lower the pace accordingly (page 44) or stop the exercise.

NOTE

If the pulse sensor is not attached properly or accidentally slips off, a "Measurement Error!" message appears. Reattach the pulse sensor properly and continue your exercise session.

NOTE

When starting the exercise, a Warming Up segment of two minutes (for Walk Fitness) or three minutes (Jog Fitness) is inserted. You can change the pace during Warming Up manually if it seems too slow or too fast (page 44).

NOTE

For audio song playback, the song tempo which is analyzed by the BODiBEAT Station software may differ from the actual tempo depending on the song characteristics. In this case, you can manually correct the tempo information with the BODiBEAT Station. For details, refer to the BODiBEAT Station Owner's Manual.

HINT

If you find it difficult to match your steps to the song tempo, turn the Tempo Guide function on (page 62).



Starting Up

Exercising

Computer

Music Player

Settings

Troubleshooting

Menu Tree

Index



- 4 While you're jogging or walking, you can change the volume of the music and select different songs. You can also lock the pace or change it to a different tempo. (See "Operation During Exercise" on page 42.)**

At the start of the 'warming up' and 'cooling down' segments, "Warm Up" and "Cool Down" appear respectively in the display and remain for about two seconds, followed by the normal exercise displays.

- 5 Before the set target has been reached, the 'cooling down' segment begins—a slower song plays back to help you slow down your pace. After about three minutes passes and the cooling down segment reaches its end, music playback stops and the session ends.**

A log showing detailed information on your session automatically appears.

You can also slow down and stop a session manually by simultaneously holding both the ▲/▼ (Up/Down) buttons. This starts the cooling down segment, ends the session and calls up the log display.

Holding the ▲/▼ (Up/Down) buttons again during the cooling down ends the session immediately and calls up the log display.

NOTE

When the Learning Function (page 74) is set to on, a confirmation message will appear before the log display appears and prompts you to update the maximum heart rate and tempo.

The indications and operations for the session log displays in the Fitness modes are the same as in the Free Workout mode. (See page 29.)

Starting Up

Exercising

Computer

Music Player

Settings

Troubleshooting

Menu Tree

Index

**FYI****What is ‘Effective’ Aerobic Exercise?**

Aerobic exercise, such as walking and jogging, builds up your cardiopulmonary functions and increases your stamina. Since stamina is a good measure of physical age, regular and continuous aerobic exercise can make your body more youthful.

Aerobic exercise is also very effective for losing weight. Oxygen brought into body breaks down and burns off fat. Moreover, as your exercising builds muscle mass and increases basal metabolism, your whole body and constitution loses more and more fat.

To achieve the maximum benefits of aerobic exercise, you should avoid merely jogging in any haphazard fashion, but be careful to set appropriate exercise intensity levels (i.e., the pace for walking/jogging) and exercise lengths.

Exercise intensity and heart rate

As you exercise, your heart rate rises. Since intense exercise increases your heart rate more significantly than light exercise, heart rate is a reliable indicator for exercise intensity. To achieve the desired effect of your exercise, it is important that you determine the target heart rate in advance and try to bring your heart rate up to this target during exercise.

How can you determine the proper target heart rate? There are various methods for calculating heart rate, but the BF-1 adopts a method using %HRR (percentage of heart rate reserve). The %HRR figure assumes your resting heart rate as 0% and your maximum heart rate (heart rate during your most intense exercise) as 100%. For walking, a %HRR figure of 55 – 75% is optimal for aerobic exercise. For jogging, 65 – 75% is optimal. For the specific formula used to calculate your optimum target heart rate, see [page 38](#).

NOTE

The BF-1 calculates your heart rate according to the blood flow at your ear lobe detected by the included pulse sensor.

Using the Fitness modes, you can maintain the optimal heart rate during exercise without the need to be continually conscious of your heart rate, simply by entering your resting heart rate and maximum heart rate figures in advance. When your heart rate dips below the optimal level, faster songs are played to naturally prompt you to increase your pace; likewise, when your heart rate exceeds the optimal level, slower songs are played to prompt you to decrease your pace. Thanks to this feature, you simply match your walking/jogging pace to the tempo of the music, and your optimal heart rate is maintained (refer to the graph below). You can also easily check whether your heart rate is optimal or not from the LED. When it is optimal (%HRR is 55 – 75%), it flashes in green. When lower than optimal, it flashes in blue. When higher than optimal, it flashes in red.



Starting Up

Exercising

Computer

Music Player

Settings

Troubleshooting

Menu Tree

Index

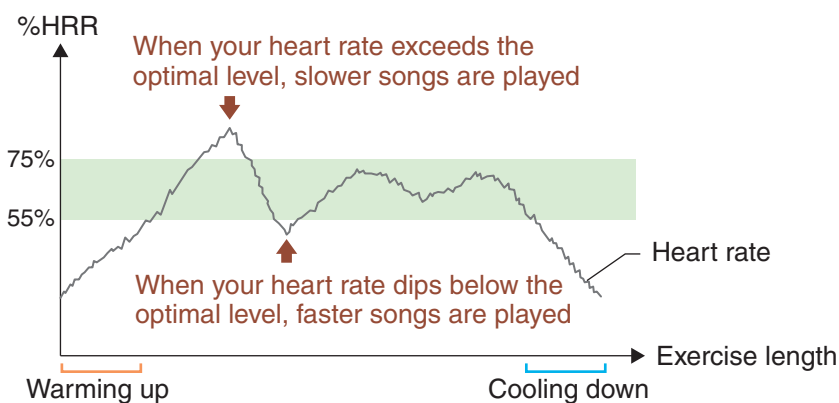

- Starting Up
- Exercising
- Computer
- Music Player
- Settings

Exercise length

For best results, one exercise session should be at least fifteen minutes. Twenty minutes or more is recommended, because as long as you exercise, the proportion of fat-burning increases and remains high. When you are walking, more time is required for this than when jogging—roughly 30 – 40 minutes—because your heart rate increases more slowly than when jogging.

Warming up and cooling down

Warming up and cooling down is necessary not only for effective exercise but also for protection from injury and proper recovery from fatigue. Generally, bending and stretching, as well as minimum-stress exercises are good for warming up and cooling down. The Fitness modes of the BF-1 actually include warming up and cooling down segments to guide you naturally into lighter exercising. At the beginning of the exercise and at the end of the exercise, slower songs are automatically played back. Simply match your pace to the music playing, and you can warm up and cool down appropriately.

For safe exercise

Pay careful attention to the environment around you to avoid accidents.

- Exercise in locations of light or minimal traffic, such as a park or a jogging path.
- Exercise in broad daylight if possible. Exercising at dusk or after the sun goes down—or worse yet, at night—you may not be able to properly see dangerous obstacles, and other people or drivers may not be able to see you.
- When jogging, pay more attention to your environment than when walking. The faster you are moving, the greater the danger.

Supervised by: Senshi Fukushima, Associate Professor, University of Tokyo
(Sport Sciences and Sport Biomechanics)

- Troubleshooting
- Menu Tree
- Index



Exercising According to a Training Program—Training Mode

In the Training mode, you can create more detailed structured exercise sessions and make custom programs to fit your individual exercise needs. Preset Training programs are also available for certain exercise situations or goals. You can use these as a starting point. (You may want to inspect these programs within the included software, to more easily view the contents and the targets over the programmed exercise).

Each program in the Training mode contains several segments, each lasting for a specific amount of time or for a specific distance. Each segment also has a different target. This can be a certain intensity of exercise (as measured by heart rate reserve), a specific music tempo, a specific heart rate, or a specific pace (as measured by minutes: seconds per mile). Simply put, a Training program divides an exercise session into multiple parts, each programmed exactly to suit your exercise needs or fit a specific athletic training application.

You can create your own Training programs, and the included software gives you the tools to most easily and intuitively do this. Creating your own custom Training programs gives you enormous flexibility and control over your exercise sessions. When used correctly, it's almost like having a professional athletic coach by your side, telling you not only when to speed up and when to slow down, but exactly how much you should speed up or slow down—all the while playing your favorite music to keep you on program.

To call up the Training mode:

Select “Training” from the Top Menu.

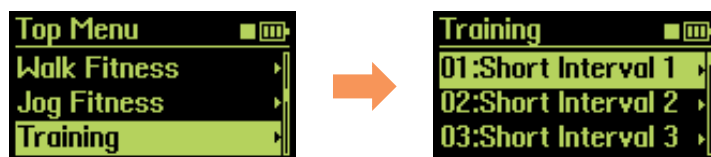

Exercising with preset programs

The BF-1 comes with specially programmed preset Training programs built into the unit. These are designed for a variety of specific exercise situations or goals.

HINT

The BF-1 also lets you create your own Training programs (see [page 37](#)), and you can use the preset programs here as starting points or templates in making your own (see [page 39](#)).

Starting Up

Exercising

Computer

Music Player

Settings

Troubleshooting

Menu Tree

Index



Operation

1 Select the desired program from the Training menu.

A list of programs is provided on [page 81](#). You can also view the programmed content of the presets within the included software, making it easier to see and understand the segments and the intervals/targets for the exercise.

2 Make sure the pulse sensor is properly attached ([page 20](#)).

When it is properly attached, the LED will start flashing in time with your heart rate.

3 From the menu, select “Start,” then start running or walking with the tempo of the song that plays.

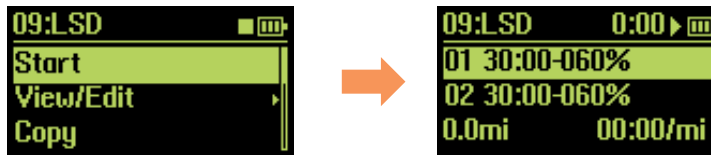

As you exercise, the program number and the segment number is shown at the top of the display. A song of the appropriate tempo is automatically selected from all songs currently on the BF-1.

HINT

If you want to specify a certain Playlist for song selection, select “View/Edit” here, and then select “OK” at the bottom. The Select Music display appears.

WARNING

In the Training mode, the device plays back songs that follow the pace of the program, and naturally you should try to match this pace. However, if you find the pace too strenuous, do not force yourself to keep pace. Lower the pace accordingly ([page 44](#)) or stop the exercise.

NOTE

If the pulse sensor is not attached properly or accidentally slips off, a “Measurement Error!” message appears. Reattach the ear sensor properly and continue your exercise session.

HINT

If you find it difficult to match your steps to the song tempo, turn the Tempo Guide function on ([page 62](#)).

NOTE

For audio song playback, the song tempo which is analyzed by the BODiBEAT Station software may differ from the actual tempo depending on the song characteristics. In this case, you can manually correct the tempo information with the BODiBEAT Station. For details, refer to the BODiBEAT Station Owner’s Manual.

4 While you’re running or walking, you can change the volume of the music and select different songs.

You can also lock the pace or change it to a different tempo. (See “Operation During Exercise” on [page 42](#).)



Starting Up

Exercising

Computer

Music Player

Settings

Troubleshooting

Menu Tree

Index



5 Once the program has reached the end, music playback stops and your session is ended.

A log showing detailed information on your session automatically appears. If you want to stop the exercise before the program reaches the end, you can also stop the session manually by simultaneously holding both the ▲/▼ (Up/Down) buttons. This ends the session and calls up the log display.

NOTE

When the Learning Function (page 74) is set to on, a confirmation message will appear before the log display appears and prompts you to update the maximum heart rate and tempo.

The indications and operations for the session log displays in the Training mode are the same as in the Free Workout mode. (See page 29.)

Starting Up

Exercising

Computer

Music Player

Settings

Creating a new program

You can create your own Training program from scratch, entering the desired Interval and Target for each segment in your custom exercise program.

NOTE

Up to 99 programs can be saved in the BF-1. One program can contain up to 99 intervals.

Operation

1 Select “New” from the Training menu.



2 Set the units you want to use for Interval and Target in the segment.

For example, if you want to jog for 3 minutes in a segment and you want to jog at a pace of one mile every 5-1/2 minutes, select “Time” in the Interval parameter and “Pace” in the Target parameter.

Available settings:

Interval

Time

Distance

Target

Pace (minutes: seconds per mile)

Tempo (bpm)

HR (Heart Rate; bpm)

%HRR (percentage of heart rate reserve; %)

This represents the intensity of your exercise.

NOTE

The pace is determined based on the jog stride setting (page 73). If the tempo of the song playing back while exercising is too fast or too slow, change the stride setting.

NOTE

If you set the measurement unit of length as “Meters,” the pace is represented by “minutes: seconds per kilometer.”

Troubleshooting

Menu Tree

Index





FYI About heart rate reserve

Heart rate reserve (HRR) is a term used to describe the difference between a person’s resting heart rate (HR_{rest}) and maximum heart rate (HR_{max}). The formula is:

$$HRR = HR_{max} - HR_{rest}$$

The BF-1 actually measures and calculates the percentage of heart rate reserve (%HRR) and uses this as a measurement of exercise intensity. By using %HRR as the exercise intensity, the optimal heart rate (HR) in exercising is calculated. The formula is:

$$HR = HRR \times \%HRR + HR_{rest}$$

For example, if your HR_{max} is 180 bpm, HR_{rest} is 60 bpm and target %HRR is 70%, the HR is calculated as:

$$HR = (180 - 60) \times 0.7 + 60 = 144$$

Starting Up

Exercising

Computer

Music Player

Settings

After the Interval and Target setting is finished, the following display appears.

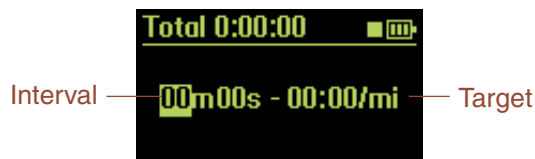

- 3 Set the desired values for Interval and Target, and then simultaneously press the ▲/▼ (Up/Down) buttons to actually enter them for the segment.**

The segment is entered and operation returns to the previous display.

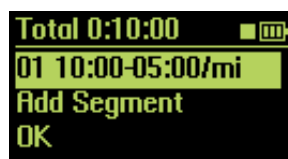

- 4 Select “Add Segment” to enter the next segment.**
- 5 Repeat steps 3 and 4 above as needed to create all the desired segments for your program.**
- 6 After you’ve created all the segments for the program, select “OK” in the display.**

The Select Music display appears (when some Playlists exist).

NOTE

When there are no Playlists or the Music Priority parameter (page 61) is set to “BODIBEAT Songs,” the Music Select display is not displayed. Skip to step 8.



Troubleshooting

Menu Tree

Index



7 Select the desired Playlist. (Refer to step 5 on page 28.)

Doing this automatically returns to the initial display.

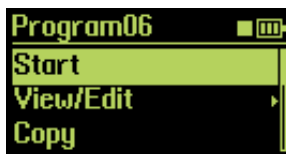

8 Select “Start” to start exercising with the newly created program.

For further details and important information when using in the Training mode, see page 36.

- Starting Up
- Exercising
- Computer
- Music Player
- Settings

Editing the preset (or already created) Program

This operation is convenient for using an existing program as a template for making a new program. Simply select a program that is similar to the one you wish to create, and then change the settings of the existing program as necessary to create the new program.

Operation

1 Select the desired program to be edited from the Training menu.

The following display appears.

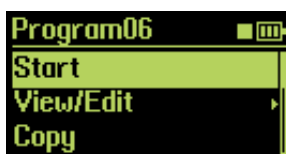

2 If you want to edit this program and overwrite it, select “View/Edit,” and then go on to step 3. If you want to save the original program and make a new one, select “Copy.”

When you select “Copy” here, a “Copied to Program XX” message briefly appears, followed by the display in step 1 above. Select “View/Edit” from this display and continue with the steps below to edit the copied program.

NOTE

The lowest unused program number will be automatically selected as the copy destination.

All segments in the program are shown in the display.

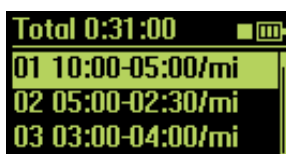

- Troubleshooting
- Menu Tree
- Index



3 Select the segment you wish to edit.

If you want to edit a segment, select the desired segment here and go on to the Edit/Insert instruction in step 5 below.

If you want to insert a new segment, select the location to which it will be inserted and go on to the Edit/Insert instruction in step 5 below. (For example, if you want to insert a new segment between segments 2 and 3, select segment 3.)

If you want to delete a segment, select the desired segment here and go on to the Delete instruction in step 5 below.

If you want to add a new segment after the last segment, select “Add segment” and go on to step 6.

4 From the following display, select the desired operation: Edit, Insert, or Delete.



Edit/Insert

When you select “Edit” or “Insert” here, the Edit segment display appears.

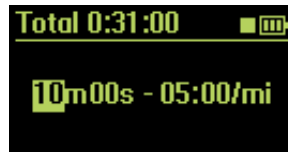

Delete

If you’ve selected “Delete” here, the display prompts you for confirmation. Select “Yes” to delete the selected segment, or select “No” to cancel. The Edit display (in step 3 above) appears. Continue editing as desired, or go on to step 8 to save the program.

5 Set the desired values for Interval and Target, and then simultaneously press the ▲/▼ (Up/Down) buttons to actually enter them for the segment.

The segment is entered and operation returns to the previous display.

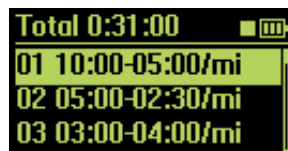

6 Repeat steps 3 – 5 above as needed to create all the desired segments for the program.



- Starting Up
- Exercising
- Computer
- Music Player
- Settings

- Troubleshooting
- Menu Tree
- Index



7 After you’ve created all the segments for the program, select “OK” in the display.

The Select Music display appears (when some Playlists exist).

NOTE

When there are no Playlists or the Music Priority parameter (page 61) is set to “BODIBEAT Songs,” the Music Select display is not displayed. Skip to step 8.

8 Select the desired Playlist. (Refer to step 5 on page 28.)

Doing this automatically returns to the initial display.

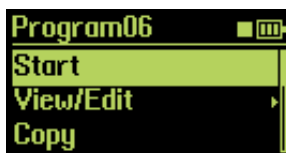

9 Select “Start” to start exercising with the newly created program.

For further details and important information when using in the Training mode, see page 36.

- Starting Up
- Exercising
- Computer
- Music Player
- Settings

Deleting a program

If you want to create a new program but the memory of the BF-1 is full and no more programs can be saved (an error message indicating this appears), you will need to delete one or more programs. This operation lets you delete an existing program to make room for the new program.

Operation

1 Select the desired program to be deleted from the Training menu.

The following display appears.

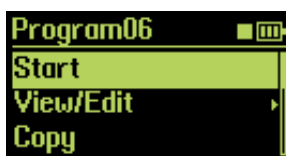

2 Select “Delete.”

The display prompts you for confirmation.

3 Select “Yes” to delete the selected program, or select “No” to cancel.

When you select “Yes,” a “Delete Program XX” message briefly appears, followed by the Training menu.

- Troubleshooting
- Menu Tree
- Index



Operation During Exercise

At any time during your exercise session (in Free Workout, Fitness Walk, Fitness Jog or Training modes), you can change various settings.

■ Pausing the exercise

This function lets you temporarily pause the operation of the BF-1 (for example, if you need to briefly stop your exercise session). Music playback is stopped and your heart rate and steps are not monitored while pause is active.

Operation

Press (but do not hold) the ▲/▼ (Up/Down) buttons simultaneously. This pauses the music and exercise session. Press them again to restart the music and exercise.

■ Changing music playback volume

Operation

Use the ▲/▼ (Up/Down) buttons to call up the Volume display and change the volume while the music is playing.



After two seconds, the Volume display automatically closes and returns to the previous display. You can also close the Volume display manually (before the two seconds are up) by pressing the [MENU] button.

■ Changing songs

This lets you select other songs having roughly the same tempo as the song currently playing or jump back to the beginning of the current song.

Operation

1 Press the [MENU] button once to call up the Select Song display.

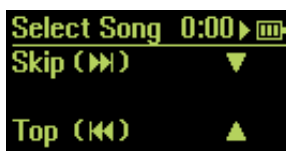

Starting Up

Exercising

Computer

Music Player

Settings

Troubleshooting

Menu Tree

Index



2 Press the ▼ (Down) button to select the next song as desired. Pressing the ▲ (Up) button returns to the top (beginning) of the current song.

Pressing the ▼ (Down) button skips to the next or previous song (in the current Playlist or among all songs) that has roughly the same tempo as the currently active exercise tempo. Songs that do not match the current tempo will be skipped over.

To better understand this, consider the example song Playlist below:

Song 1	140 bpm
Song 2	120 bpm
Song 3	142 bpm
Song 4	138 bpm
Song 5	150 bpm

If your exercise pace is about 140 bpm in this situation, a song having a tempo of about 140 bpm will be played back. When Song 1 is played back, for example, you can skip to Song 3 or Song 4 by using the ▼ (Down) button. Songs 2 and 5 cannot be selected in this way, since they differ too greatly from the current tempo.

After ten seconds, the Select Song display automatically closes and returns to the previous display. You can also close the Select Song display manually (before the ten seconds are up) by pressing the [MENU] button twice. (Pressing it once calls up the Pace display. Pressing it again calls up the normal display.)

NOTE

When the Learning Function (page 74) is on, the skip/top count is memorized. When you skip a song, the BF-1 memorizes this action, assuming that the song is one that you don't like, and accordingly lowers the playback priority of the song. If you rewind (go back to the top of) the song, the song is memorized as a favorite and accordingly raises the playback priority.

Locking the pace

This function lets you maintain the current tempo (or one of your selection) indefinitely. Your physical conditions in exercising (pace, heart rate, etc.) have no effect on the music tempo while the tempo is locked.

NOTE

While playback is paused, the pace lock function is not available.

Operation

1 Press the [MENU] button twice to call up the Pace display.



- Starting Up
- Exercising
- Computer
- Music Player
- Settings

- Troubleshooting
- Menu Tree
- Index



2 Simultaneously press both the ▲/▼ (Up/Down) buttons to lock the tempo.

To unlock the tempo and return to normal operation, repeat steps 1 and 2 above.

■ Changing the pace

In the Fitness and Training modes, this function lets you change the song to a faster or slower song as desired during your exercise. Keep in mind that this new pace is not locked. After a while, song playback changes automatically based on changes in your heart rate or the training program.

NOTE

While playback is paused, the pace change function is not available.

Operation

1 Press the [MENU] button twice to call up the Pace display.



2 Press the ▲ (Up) button to raise the tempo, or press the ▼ (Down) button to lower it.

NOTE

When the Learning Function (page 74) is on, if you change your pace manually, the memorized starting pace, maximum pace and maximum heart rate will be changed. If this occurs, a confirmation message will appear when the workout reaches its end, prompting you to memorize the changed pace/maximum heart rate. Select “Yes” to memorize.

Starting Up

Exercising

Computer

Music Player

Settings

Troubleshooting

Menu Tree

Index



Checking the Exercise Logs

Each time you exercise with the BF-1, a new exercise log is automatically generated, creating a record of important information about your exercise session and your physical conditions. This information includes the date and time of your session, the distance covered, the average pace of your walking/jogging, the amount of calories you expended, and your maximum heart rate (the highest recorded pulse during the session). The logs also provide two different graphs: one showing the changes in your pace during the session, the other showing changes in your heart rate during the same time.

Since your exercise logs are automatically stored to internal memory (up to 99 sessions), you can call up these logs and check your past exercise sessions. This feature also lets you view cumulative data—for example, how much total distance you walked or ran in a specific week, or how many calories you expended during a specific month.

For more information on the exercise logs, see [page 29](#).

NOTE

The BF-1 has memory space for up to 99 exercise session logs. When you exceed this number, the earliest ones will automatically be deleted to make room for the new logs. By using the included software to transfer your data to computer, you can store all your exercise logs and not need to worry about the 30-log limit.

Operation

1 From the Top Menu, select “Data.”

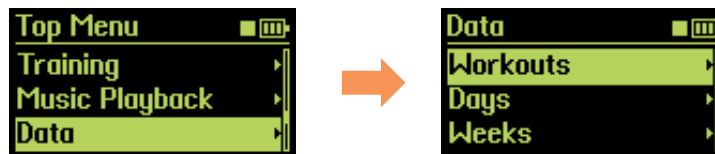

2 Select the desired category: Workouts, Days, Weeks or Months.

When selecting Workouts, you can view individual exercise session logs. When selecting Days, you can view the cumulative data for a day if you’ve exercised more than once on that day. When selecting Weeks or Months, you can view the cumulative data for a week or month, respectively.

3 From the Workouts display, select the desired session. From the other displays, select the desired time frame (day, week, month).

Starting Up

Exercising

Computer

Music Player

Settings

Troubleshooting

Menu Tree

Index



Log Displays

When you select a specific workout session, day, week or month above, the exercise log displays will be called up. The contents of the displays differ depending on the category/time frame. Use the ▲/▼ (Up/Down) buttons to scroll through the display pages.

For Workouts:

See [page 29](#).

For Days, Weeks or Months:

Total time of all exercise sessions during the period

Indicates the selected day, week or month

Total distance covered

Total calories expended

Average pace for all exercise sessions during the period

Maximum heart rate (highest recorded pulse during all sessions)

NOTE

Exercise log displays 3 and 4 are not available here.

NOTE

Since the distance, pace, calories or heart rate values in the logs are estimated based on the User Settings, they may differ from the actual values.

Starting Up

Exercising

Computer

Music Player

Settings

Troubleshooting

Menu Tree

Index



Using the BF-1 in Guest Mode

The BF-1 also features a convenient Guest mode that allows your friends and exercise partners to use your BF-1—without disturbing your special settings. This lets them take the unit on a “test run,” freely use the Free Workout and Fitness modes and even generate detailed logs of their exercise sessions—without saving the logs or changing any of your own personal settings.

IMPORTANT

Make sure to have the guest user to read the precautions (pages 6 – 7) before using the BF-1.

Operation

1 From the Top Menu, select “Guest.”

In the Guest mode, “●” is shown at the beginning of the display title.

Indicates the Guest mode is active.



NOTE

You can exit from the Guest mode (if you've entered it inadvertently) by pressing and holding the [MENU] button for about two seconds.

2 Select the desired exercise mode from: Free Workout, Walk Fitness or Jog Fitness.

The Free Workout mode automatically matches the music to your exercise pace, selecting songs having the same tempo as your jogging or walking speed. (For more details on Free Workout, see [page 25](#).)

The Walk Fitness and Jog Fitness are more sophisticated modes that monitor your heart rate using the pulse sensor and change the music automatically to give you the best possible aerobic workout. (For more details on the Fitness modes, see [page 30](#); for details on using the pulse sensor, see [page 20](#).)

3 If you want an open-ended session where you walk or jog as long as you want, skip to step 4. If you want to walk or jog for a specific length of time, distance or calories, select “Setting.”

You can set the exercise target according to Time, Distance or Calories. Refer to step 3 on [page 27](#).

NOTE

In the Guest mode, the distance, calories and exercise intensity (song tempo) are calculated based on the default values below.

- Birthday: January 1, 1970
- Resting Heart Rate: 60 bpm
- Weight: 120.0 lb (54.5 kg)
- Height: 5.5 ft (1.68 m)

[Starting Up](#)[Exercising](#)[Computer](#)[Music Player](#)[Settings](#)[Troubleshooting](#)[Menu Tree](#)[Index](#)



4 Select “Start” and then simultaneously press both ▲/▼ (Up/Down) buttons to start your exercise session.

During your exercise, you can change the volume of the music, select different songs, lock the pace or change it to a different tempo. See “Operation During Exercise” on [page 42](#).

WARNING

When using the Fitness Mode, depending on your physical condition you may feel the tempo is too slow or too fast. If so, you can change the tempo manually ([page 44](#)). Particularly, if you find it too strenuous to match your pace to the song, do not force yourself to keep pace. Lower the pace or stop the exercise.

5 The exercise session is ended after the specified time, and a log showing detailed information on your session is automatically called up.

If your exercise is an open-ended session or you want to stop the exercise before the specified time has been reached, you can also stop the session manually by simultaneously holding both the ▲/▼ (Up/Down) buttons.

For more information on the exercise logs, see [page 29](#).

NOTE

When using the Fitness mode, the cool down segment will be inserted before stop the session. Holding both the ▲/▼ (Up/Down) buttons during the cooling down ends the session immediately and calls up the log display.

[Starting Up](#)[Exercising](#)[Computer](#)[Music Player](#)[Settings](#)[Troubleshooting](#)[Menu Tree](#)[Index](#)



Starting Up

Exercising

Computer

Music Player

Settings

Connecting to a Computer

Connecting with a computer allows you to easily and intuitively manage the exercise logs, training programs, and music data, and lets you take full advantage of all the modes and functions on the BF-1 conveniently and efficiently from your computer. This is especially true in the Music mode, where the songs you want to listen to must be loaded from the computer beforehand. The loaded songs can also be listened to in other modes. Managing data and loading songs from computer requires the included software.

Contents

About the BODiBEAT Station Software	50
System Requirements	51
Installation.....	51
How to Connect.....	52
Removing the device from the computer	52
Loading Music Data to the BF-1	53
Updating the BF-1	53

Troubleshooting

Menu Tree

Index



About the BODiBEAT Station Software

The included BODiBEAT Station provides exceptionally convenient and easy tools for managing the songs you want to use on the BF-1, and provides easy-to-understand visual graphs of your exercise logs. It also provides convenient means for creating playlists of your favorite songs and for loading them to the device, so that you can enjoy walking or jogging while listening to your favorite music. In addition, creating training programs and registering your personal data by using the software is much easier and faster than doing it on the device itself.

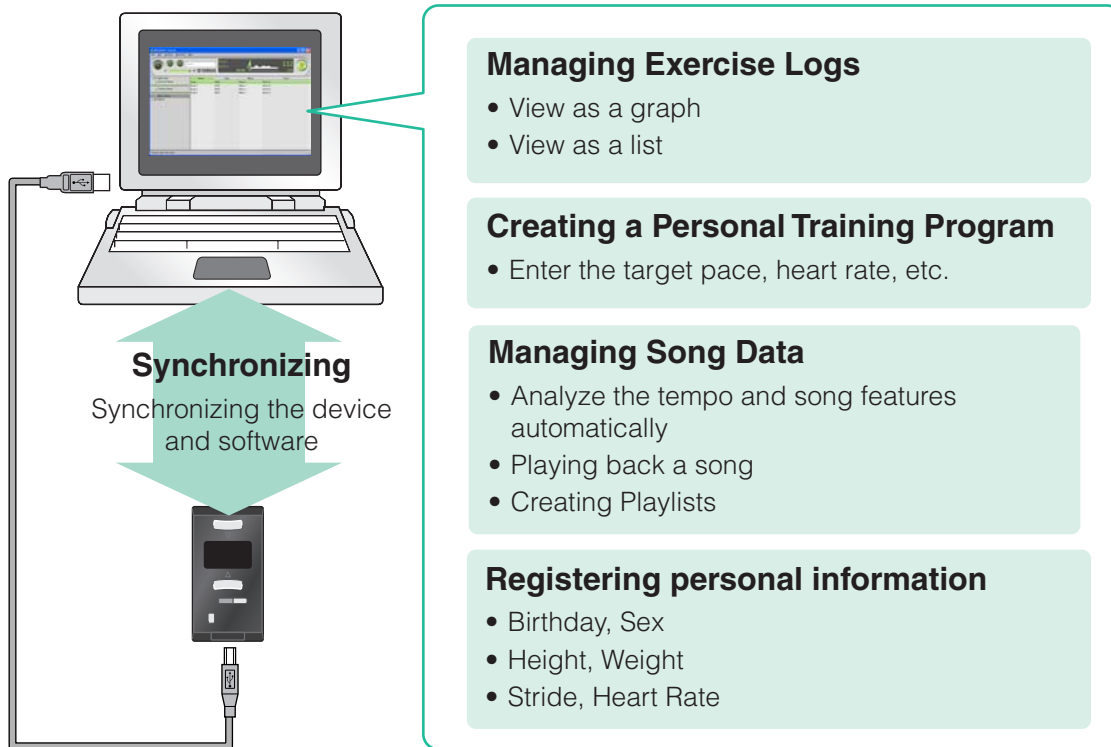

For instructions on how to use the software, refer to the BODiBEAT Station Owner’s Manual installed together with the program.

i IMPORTANT

Before installing the software, please read carefully the End User License Agreement included in the CD-ROM. By installing it, you are agreeing to be bound by the terms of the license agreement.

- Starting Up
- Exercising
- Computer**
- Music Player
- Settings

- Troubleshooting
- Menu Tree
- Index



System Requirements

OS	Windows® XP Professional SP2/XP Home Edition SP2 or Vista* (*Only compatible with 32-bit Ultimate/Business/Home Premium/Home Basic/Enterprise versions.)
Computer	1 GHz or higher; Intel® Pentium®/Celeron® processor
Available Memory	Windows XP: 128 MB or more (256 MB or more is recommended) Windows Vista: 512 MB or more (1 GB or more is recommended)
Hard Disk	200 MB or more
Display	1024 x 768 or more
Sound	Windows-compliant Audio Interface or Sound Card (Windows Media® Player must be installed to the computer.)

Starting Up

Exercising

Computer

Music Player

Settings

Installation

Operation

1 Insert the supplied CD-ROM into your computer's CD/DVD drive.

The initial menu appears on the screen.

NOTE

If the initial menu does not appear, select the CD/DVD drive from My Computer, then double-click "Setup.exe" and go on to step 3.

2 Click "Install BODiBEAT Station" from the initial menu.

The installation starts. After the message "Please plug in your BODiBEAT device" appears, connect the BF-1 to the computer with the supplied USB cable.

3 Execute the installation by following the onscreen instructions.

CAUTION

When you first connect the BF-1 to the computer in which the BODiBEAT Station is installed, the preset Training programs on the BF-1 will be overwritten by the programs on the BODiBEAT Station. If you have edited the preset programs on the BF-1, your changes will be lost. To avoid this, copy the program you have edited to another program ([page 39](#)).

Troubleshooting

Menu Tree

Index



How to Connect

Connect the device to a working computer with the included USB cable. (Recharging of the battery automatically starts.) When connected, the BF-1 automatically switches to PC mode and any key operations on the unit are disabled.

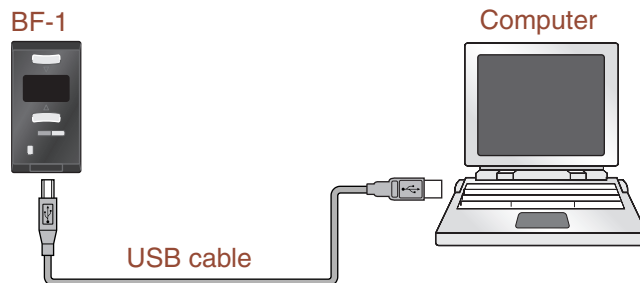

! DANGER

Do not connect to a computer in extremely hot environments. You should charge it in a temperature conditions of between 0° to 40°C (32° to 104°F). Recharging the battery in high temperatures may result in fire or an explosion.

! CAUTION

- Do not connect the BF-1 to the computer when the computer is in the power-saving mode (such as suspended, sleep, standby) and do not turn the computer to the power-saving mode when the BF-1 is connected. Doing so risks freezing the BF-1 and losing data, or depleting the power of the BF-1.
- Always use the included USB cable. Using an improper cable may cause damage to the USB terminal.
- Never disconnect the USB cable while data is being transferred. Doing so may cause loss of data or damage to the device.
- When connecting with a computer to which BODiBEAT Station is installed, a message “Do you want to associate with this computer?” may appear. If you select “Yes” here, data on the BF-1 (logs, training programs and songs) will be cleared.

Removing the device from the computer

You can remove the device from the computer safely with the following procedure.

Operation

1 Double-click “Safely Remove Hardware” icon on the Windows task bar.

The “Safely Remove Hardware” dialog appears.

2 Confirm that the “Display device component” is checkmarked, select “Yamaha BODiBEAT USB Device,” then click [Stop].

The “Stop a Hardware device” dialog appears.

3 Click [OK].

4 Disconnect the USB cable from the computer.

Starting Up

Exercising

Computer

Music Player

Settings

Troubleshooting

Menu Tree

Index



Loading Music Data to the BF-1

By loading your favorite songs to the BF-1, you can listen to them when you exercise or play them back in the Music Playback mode. First, to load songs, you will need to use the included software. Second, import the desired songs to the software from the computer's hard disk, then create playlists on the software if necessary. Finally, transfer the songs/playlists from the computer to the device.

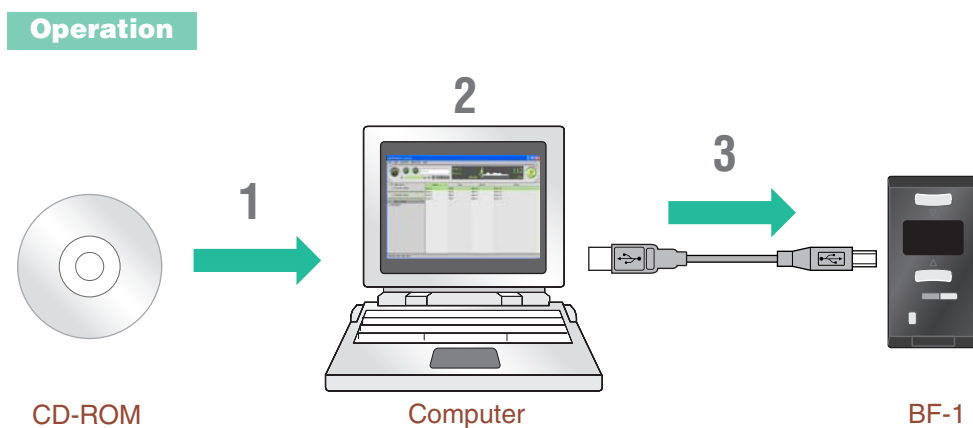

- 1 Install the included software to the computer**
- 2 Import the songs to the software**
- 3 Transfer the songs to the device**

For details about the procedure, refer to the owner's manual of the software.

NOTE

The BODiBEAT Station cannot directly import the song data from a music CD. You will need to import songs from the CD to your computer in advance, using a CD ripping software, such as Windows Media Player.

NOTE

The data transfer will take a long time (up to one-quarter of the song length) since the song's tempo characteristics are thoroughly checked and analyzed automatically in real time. The transfer time may differ depending on your particular computer.

Updating the BF-1

You can update the BF-1 to the latest version by downloading the appropriate updater file from our website and installing it. For up-to-date information or specific updating instructions, refer to the website below.

<http://www.bodibeat.com>

HINT

You can also easily access the website from the [Help] menu of the included software.

Starting Up

Exercising

Computer

Music Player

Settings

Troubleshooting

Menu Tree

Index



Using the BF-1 as a Music Player —Music Playback Mode

In this mode, the BF-1 performs as a simple music player. You can select one of the songs you’ve loaded from computer and play it back. The Music Playback mode features three basic operations that let you:

- Select a specific artist or album, and automatically play the songs of that artist or album. (See “Artist/Album” on [page 55](#).)
- Select and play back a single song. (See “Songs” on [page 56](#).)
- Select a custom Playlist, and automatically play the songs assigned to that Playlist. (See “Playlists” on [page 57](#).)

HINT

There are other playback options available. You can have all songs in a playlist automatically play back at random or have them repeat indefinitely (either a single song or all songs in a playlist). See Play Mode Settings on [page 65](#).

Contents

Selecting Songs	55
Playing the songs from an artist or album—Artist/Album	55
Playing a single song—Songs	56
Playing the songs from a Playlist—Playlists	57
Basic Operations in Music Playback Mode	58
Fast-forward and reverse	58
Adjusting the Volume	59
Exiting from the Play Info Display	59
Returning to the Play Info Display.....	59



Selecting Songs

- Starting Up
- Exercising
- Computer
- Music Player
- Settings

Playing the songs from an artist or album—Artist/Album

With this operation, you can select a specific artist or album, and automatically play the songs of that artist or album. Note that you must first have some songs downloaded to the BF-1 and organized according to artist or album before you can use this. The BODiBEAT Station software has convenient tools to help you download songs (even entire albums) and organize them as you wish. (Refer to page 53.)

NOTE

If the artist name and/or album name is not entered, the item appears blank in the display.

Operation

1 Select “Music Playback” from the Top Menu.



If you need to return to the Top Menu from any other mode/menu, press and hold down the [MENU] button.

2 From the Music Playback menu, call up the Artist/Album menu.

3 Select the desired item from the list that appears.

The first song of the selected artist or album starts playing automatically. During playback, the song title and artist are shown, along with the elapsed time of playback.

Play Info display

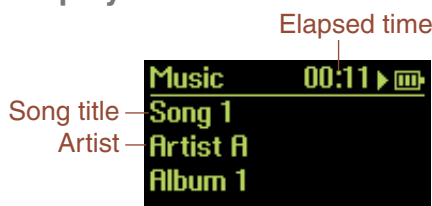

HINT

You can have all songs in an album automatically play back at random or have them repeat indefinitely (either a single song or all songs in an album). See Play Mode Settings on page 65.

After the last song of the album is played, playback is automatically stopped. If you want to stop playback manually before the album reaches the end, press and hold down both ▲/▼ (Up/Down) buttons.

To temporarily pause playback, simply press the ▲/▼ (Up/Down) buttons together (but do not hold them). Press them again to resume playback.

- Troubleshooting
- Menu Tree
- Index



Playing a single song—Songs

Here you can select and play any one song that is downloaded and stored to your BF-1.

Operation

1 Select “Music Playback” from the Top Menu.

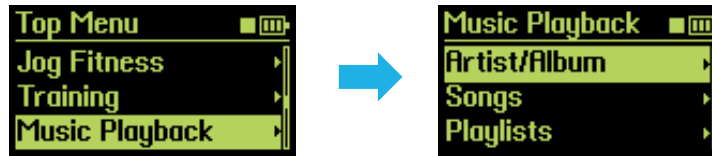

If you need to return to the Top Menu from any other mode/menu, press and hold down the [MENU] button.

2 From the Music Playback menu, call up the Songs menu.

3 Select the desired song from the list that appears.

The selected song starts playing.

During playback, the song title and artist are shown, along with the elapsed time of playback.

Play Info display

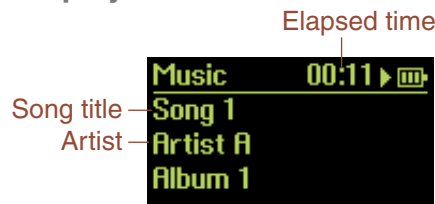

HINT

You can have all songs automatically play back at random or have them repeat indefinitely (either a single song or all songs). See Play Mode Settings on [page 65](#).

4 If you want to stop playback of the song, press and hold down both ▲/▼ (Up/Down) buttons.

To temporarily pause playback, simply press the ▲/▼ (Up/Down) buttons together (but do not hold them). Press them again to resume playback.

Starting Up

Exercising

Computer

Music Player

Settings

Troubleshooting

Menu Tree

Index



Playing the songs from a Playlist—Playlists

With this operation, you can select a specific Playlist, and automatically play the songs assigned to that Playlist. Note that you must first have some songs downloaded to the BF-1 and organized according to Playlists before you can use this. The BODiBEAT Station software has convenient tools to help you download songs and organize them into custom Playlists as desired. (Refer to page 53.)

Operation

1 Select “Music Playback” from the Top Menu.



If you need to return to the Top Menu from any other mode/menu, press and hold down the [MENU] button.

2 From the Music Playback menu, call up the Playlists menu.

3 Select the desired item from the list that appears.

The first song of the selected Playlist starts playing automatically. During playback, the song title and artist are shown, along with the elapsed time of playback.

Play Info display

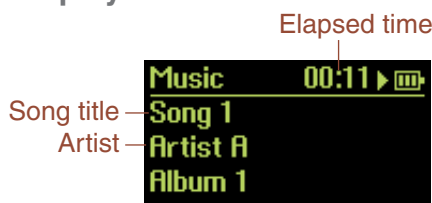

HINT

You can have all songs in a playlist automatically play back at random or have them repeat indefinitely (either a single song or all songs in a playlist). See Play Mode Settings on page 65.

After the last song of the playlist is played, playback is automatically stopped. If you want to stop playback manually before the playlist reaches the end, press and hold down both ▲/▼ (Up/Down) buttons. To temporarily pause playback, simply press the ▲/▼ (Up/Down) buttons together (but do not hold them). Press them again to resume playback.

Starting Up

Exercising

Computer

Music Player

Settings

Troubleshooting

Menu Tree

Index



Basic Operations in Music Playback Mode

Starting Up

Exercising

Computer

Music Player

Settings

Fast-forward and reverse

These controls can be used while the Play Info display is shown. You can also jump back to the beginning of the current song or skip to the next one.

Operation

- 1 From the Play Info display, press the [MENU] button while the song is playing.**

The SELECT SONG display appears.

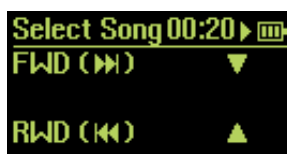

NOTE

If the Play Info display is not shown here and you want to call it up again, follow the instructions shown on [page 59](#).

- 2 To fast-forward, press and hold down the ▼ (Down) button.**

When the end of the song is reached, it goes to the next song and continues fast-forwarding. Song playback starts when you release the ▼ (Down) button.

To reverse, press and hold down the ▲ (Up) button.

When the top of the song is reached, the previous song is selected and rewinding continues. Song playback starts when you release the ▲ (Up) button.

To go to the beginning of the next song, press the ▼ (Down) button.

To go back to the beginning of the current song, press the ▲ (Up) button.

When you fast-forward, reverse or do nothing in the SELECT SONG display, after ten seconds, the Play Info display will automatically called up. You can also close the SELECT SONG display manually (before 10 seconds are up) by pressing the [MENU] button.

When you change the song or return to beginning of the song, the song title is displayed for five seconds, after which the Play Info display is called up. You can change the songs in order by pressing the ▲ (Up) or ▼ (Down) button during this five seconds.

NOTE

If you try to skip playback of the last song while it is playing, song playback will be stopped.

Troubleshooting

Menu Tree

Index



Adjusting the Volume

While the song is playing, you can change the volume.

Operation

- 1 From the Play Info display, press one of the ▲/▼ (Up/Down) buttons.

The Volume display appears.

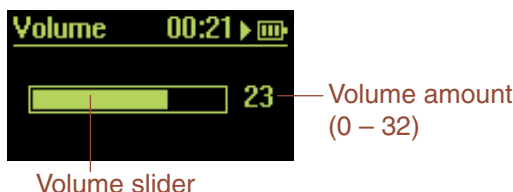

- 2 Use the ▲/▼ (Up/Down) buttons to set the volume as desired.

After two seconds, the Volume display automatically closes and returns to the previous display. You can also close the Volume display manually (before the two seconds are up) by pressing the [MENU] button.

Exiting from the Play Info Display

You can exit from the Play Info display and return to the Top Menu, without stopping song playback. If you want to change any music settings such as Repeat or Shuffle, or you want to reselect the song to be played, you can do it from the Top Menu.

Operation

While a song is playing, press and hold down the [MENU] button.

The Top Menu is called up.

NOTE

When you exit from the Play Info display, you can stop song playback or restart playback by simultaneously holding the ▲/▼ (Up/Down) buttons. You'll need to call up the Play Info display again if you want to change the playback volume, fast-forward, rewind or switch the song. Refer to "Returning to the Play Info Display" below.

Returning to the Play Info Display

After exiting from the Play Info display, if you haven't used any of panel controls for ten seconds, the Play Info display will automatically be called up again. You can also call it up manually by the following procedure.

Operation

- 1 Select "Music Playback" from the Top Menu.
- 2 Select "Now Playing."

The Play Info display appears.

Starting Up

Exercising

Computer

Music Player

Settings

Troubleshooting

Menu Tree

Index



Starting Up

Exercising

Computer

Music Player

Settings

Settings

This group of controls and parameters let you customize the BF-1 for your own preferences and physical condition. The Settings are divided into three main groups: Music, Hardware and User, with a separate Initialize function for instantly restoring the default settings of the device. Also included is an Information menu, which lets you check the version of your BF-1.

Contents

Music Settings.....	61
Workout Music.....	61
FYI About the BODiBEAT songs.....	62
Play Mode—Repeat and Shuffle.....	65
Bass Boost.....	65
Hardware Settings.....	66
Sensors.....	66
Display.....	68
Date/Time.....	70
User Settings.....	71
Heart Rate.....	71
FYI About Maximum Heart Rate.....	72
Stride.....	73
Weight/Height.....	73
Birthday/Sex.....	74
Learning Function.....	74
Information.....	76
Initialize.....	76

Troubleshooting

Menu Tree

Index



Music Settings

The Music Settings let you set:

- Various exercise and workout music controls, such as Tempo Guide, Song Connection, Playback Time for songs, and others. (See “Workout Music” below.)
- The playback mode for the BF-1 (Repeat and Shuffle). (See “Play Mode” on [page 65](#).)
- The tonal qualities of the sound. (See “Bass Boost” on [page 65](#).)

From the Top Menu, select Settings → Music Settings

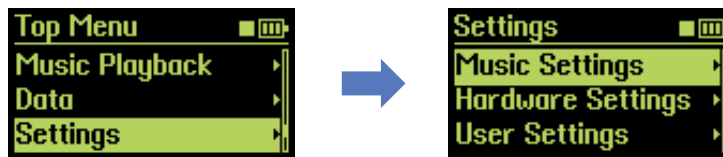

Starting Up

Exercising

Computer

Music Player

Settings

Workout Music

This mode provides a variety of settings related to how you want to use the BF-1 in your exercising and workouts.

Operation

From the Music Settings menu, select the Workout Music menu.

In the Workout Music menu, the following items are shown: Music Priority, Tempo Guide, Half Tempo, Song Transition, Playback Time and Normalize Volume.



- Music Priority (below)
- Tempo Guide ([page 62](#))
- Half Tempo ([page 63](#))
- Song Transition ([page 63](#))
- Playback Time ([page 64](#))
- Normalize Volume ([page 64](#))

■ Music Priority

This lets you set how the BF-1 selects between normal audio songs and the special “BODiBEAT” songs, which have been pre-loaded to the device. These BODiBEAT songs have been built into the BF-1 to make sure that songs of all tempos between 50 – 250 bpm are properly included, even if you haven’t loaded audio songs of all tempos to the device.

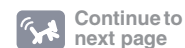

Troubleshooting

Menu Tree

Index

**Operation**

From the Workout Music menu, select the Music Priority parameter.

Available settings:**User Songs**

Only user-supplied songs are played, unless no songs of the appropriate tempo exist, in which case a BODiBEAT song of the tempo is played. This is the default setting.

Mix

Audio songs and BODiBEAT songs are mixed in a 50/50 ratio.

BODiBEAT Songs

Only the pre-loaded BODiBEAT songs are played. (Audio songs are not selected.)

FYI About the BODiBEAT songs

The BF-1 contains many short phrases of specific song parts—for example, rhythm parts, melody parts, bass parts, and so on. Some of these are randomly and automatically chosen and mixed, giving you literally hundreds of thousands of songs suitable for your exercise sessions.

Tempo Guide

This lets you turn on the sound of the Tempo Guide. (Tempo Guide is a metronome sound that clicks for each beat, to help you “feel” the tempo of the song.) When you turn the Tempo Guide function on, the sound will come on only when your pace deviates from the basic tempo of the song. A sub menu in this setting lets you select the type of sound used for the Tempo Guide.

NOTE

Tempo Guide is only available in the Fitness or Training modes.

Operation

1 From the Workout Music menu, select the Tempo Guide parameter.

Available settings:**Off**

Tempo Guide is off.

On

Tempo Guide is enabled, and sounds only when your walking/jogging pace deviates from the tempo of a song.

When you select “On” here, the Guide Sound menu will appear.

NOTE

If Tempo Guide is set to “Off,” pressing both the ▲/▼ (Up/Down) buttons returns to the Workout Music menu (Guide Sound menu will not appear).



Continue to
next page

Starting Up

Exercising

Computer

Music Player

Settings

Troubleshooting

Menu Tree

Index



2 Select the desired setting using the ▲/▼ (Up/Down) buttons.

Every time the cursor position is moved, the highlighted setting can be heard.

Available settings:

Guide Sound A, Guide Sound B, Guide Sound C

■ Half Tempo

This allows you to broaden the tempo criteria for songs to include songs that are at half the current tempo. For example, if the current pace is 160 bpm, you can set Half Tempo to On, and songs at 80 bpm will be included along with songs at 160 bpm. In other words, songs that are exactly twice as slow as the current pace will play back. Since the pace is mathematically half, you can continue jogging/walking at the current pace and still stay in time with the music. This lets you program relaxing, slow-paced music for your exercising, and yet maintain a fast-paced exercise.

When Half Tempo is set to Off, only music at the selected tempo will play back.

🎵 NOTE

Half Tempo is available only for the audio songs and only when using the Free Workout mode.

Operation

From the Workout Music menu, select the Half Tempo parameter.

Available settings:

Off, On

■ Song Transition

Song playback on the BF-1 is basically continuous. One song follows another virtually without pause in order that your exercise continues undisturbed. The Song Transition function lets you determine how the BF-1 connects consecutive songs with a special connective phrase.

🎵 NOTE

The Song Transition setting is in effect just before the audio song is played. (Before a BODiBEAT song is played, no connective phrase is added.)

Operation

From the Workout Music menu, select the Song Transition parameter.

Available settings:

Transition 1

A connective phrase is added between successive songs, to smoothly sequence between them.

Transition 2

A connective phrase is added between successive songs, with the previous song fading out (only when the previous song is an audio song), followed by the connective phrase and then playback of the next song.

Starting Up

Exercising

Computer

Music Player

Settings

Troubleshooting

Menu Tree

Index



■ Playback Time

This determines the maximum song playback time, or how long each song plays before the next song starts.

NOTE

Playback Time is not available when using Music Playback Mode.

Operation

From the Workout Music menu, select the Playback Time parameter.

Available settings:

Maximum, 1 min., 2 min., 3 min., 4 min., 5 min.

■ Normalize Volume

This evens out the volume of all songs in the BF-1, preventing extreme changes in volume from one song to the next and keeping the selected songs at relatively the same level.

NOTE

If you have already normalized the levels of the song or songs on the computer with some other audio application, make sure to set the Normalize Volume setting to off.

Operation

From the Workout Music menu, select the Normalize Volume parameter.

Available settings:

Off, On

Starting Up

Exercising

Computer

Music Player

Settings

Troubleshooting

Menu Tree

Index



Play Mode—Repeat and Shuffle

This mode lets you set how the BF-1 plays back songs—at random or in order, and whether a song or songs will be repeated. Repeat and Shuffle playback can be used together as well.



NOTE

If you select a song from the Artist/Album menu (page 55) or Playlists menu (page 57), the repeat and/or shuffle setting is in effect only for the selected album/playlist.

Operation

- 1 From the Music Settings menu, select the Play Mode menu.
- 2 Select the desired setting for Repeat and/or Shuffle using the ▲/▼ (Up/Down) buttons.

Repeat

When this is set to All, all of the songs will be played back in order and then repeated indefinitely. The Repeat All icon () is also shown at the top of the display. When this is set to Song, the selected song will be repeated indefinitely. The Repeat One icon () is also shown at the top of the display.

Available settings:

Off, All, Song

Shuffle

When this is set to On, all songs will be played back at random. The Shuffle icon () is also shown at the top of the display.

Available settings:

Off, On

When Repeat is set to All and Shuffle is set to On, all songs will be played back in random order and then repeated indefinitely.

Bass Boost

This is an additional equalizer control which produces rich, deep bass tones for a more powerful overall sound, and helps compensate for outside noises that may be interfering with the music.

NOTE

When you change the Bass Boost setting while a song is playing in the Music Playback mode, the highlighted setting will take effect for the currently played song and you can hear each Bass Boost setting as you select it.

Operation

From the Music Settings menu, select the Bass Boost parameter.

Available settings:

Off, Low, Mid, High

Starting Up

Exercising

Computer

Music Player

Settings

Troubleshooting

Menu Tree

Index



Hardware Settings

The Hardware Settings let you set:

- The sensitivity of the sensors of the BF-1. (See “Sensors” below.)
- Various display-related controls. (See “Display” on [page 68](#).)
- The correct date and time. (See “Date/Time” on [page 70](#).)

From the Top Menu, select Settings → Hardware Settings.

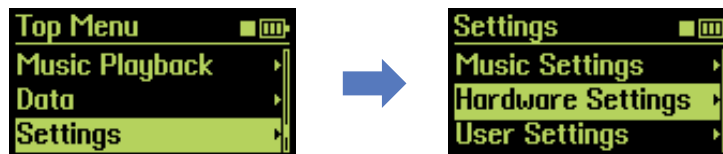
[Starting Up](#)[Exercising](#)[Computer](#)[Music Player](#)[Settings](#)

Sensors

The Sensors settings let you tailor the response and sensitivity of the sensors of the BF-1. It lets you adjust the device to the strength of your pulse, the speed of your jogging stride and changes in your jogging pace.

Operation

From the Hardware Settings menu, select the Sensors menu.

In the Sensors menu, the following items are shown: Pulse Sensor, Step Sensor and Pace Sensor.

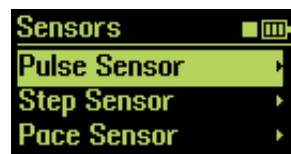

Pulse Sensor (below)
 Step Sensor ([page 67](#))
 Pace Sensor ([page 67](#))

Pulse Sensor

This lets you adjust how sensitive the BF-1 sensor is to your pulse. For example, if your pulse is weak or the BF-1 doesn't seem to respond properly to your pulse, adjusting the setting here can improve the response.

HINT

Also refer to Troubleshooting on [page 77](#) when you feel the BF-1 doesn't respond properly to your pulse.

Operation

From the Sensors menu, select the Pulse Sensor parameter.

Available settings:

High Sensitivity, Normal Sensitivity, Low Sensitivity

“Normal” is the default setting and should be fine for most people and situations. If the BF-1 doesn't seem to be responding properly, try changing the setting. Select “High” if your pulse is weak, or “Low” if your pulse is strong.

[Troubleshooting](#)[Menu Tree](#)[Index](#)



■ Step Sensor

This lets you adjust how sensitive the BF-1 sensor is to your pace. Normally, the BF-1 detects the exercise pace (tempo) when it recognizes your steps continuing at the same tempo within a certain range. If you find that the exercise pace of the BF-1 slips out of sync with your walking/jogging stride, adjusting the setting here can improve the pace recognition.

Operation

From the Sensors menu, select the Step Sensor parameter.

Available settings:

High Sensitivity, Normal Sensitivity, Low Sensitivity

“Normal” is the default setting and should be fine for most people and situations. If the BF-1 doesn’t seem to be responding properly, try changing the setting. Select “High” if your stride is reliably constant and it is easy for you to match the pace. Select “Low” if your stride varies too much within the pace. The “Low” setting allows you to deviate from the pace slightly, yet have the BF-1 ignore those deviations and stay at the same pace.

■ Pace Sensor

This allows you to tailor the response of the BF-1 to changes in your walking/jogging speed. In the Free Workout mode, the BF-1 recognizes that you intend to change the pace when you speed up or slow down the pace greater than a certain range. Changing this setting lets you adjust how sensitive the BF-1 is in responding to your pace changes.

NOTE

The setting here only applies to the Free Workout mode.

Operation

From the Sensors menu, select the Pace Sensor parameter.

Available settings:

High Sensitivity, Normal Sensitivity, Low Sensitivity

“Normal” is the default setting and should be fine for most people and situations. If the BF-1 doesn’t seem respond properly to changes in your walking/jogging speed, try changing the setting. Select “High” if the BF-1 doesn’t respond enough when you intend to increase or decrease the pace, or select “Low” if the BF-1 is responding too much when you don’t intend to change the pace.

Starting Up

Exercising

Computer

Music Player

Settings

Troubleshooting

Menu Tree

Index



Display

The Display settings let you make various overall display-related settings for the BF-1, including the system of measurements used, language, and contrast control.

Operation

From the Hardware Settings menu, select the Display menu.

In the Display menu, the following items are shown: Main Display, Measurement, Language, Display Time and Contrast.



- Main Display (below)
- Measurement (page 69)
- Language (page 69)
- Display Time (page 69)
- Contrast (page 70)

Starting Up

Exercising

Computer

Music Player

Settings

Main Display

This setting determines which parameter is indicated in the display during your exercise session in Free Workout mode or Fitness modes.

This lets you keep track of the indication most important to you—for example, the elapsed time of your exercise, the distance you’ve covered, the amount of calories expended, your current heart rate, or even the name of the song currently playing.

NOTE

The setting here does not apply to the Training mode.

Operation

From the Display menu, select the Main Disp_Workout menu.

Available settings:

Time, Distance, Calories, Heart Rate, Song

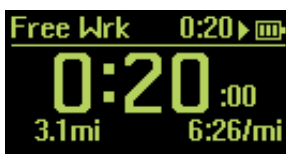

Time



Distance



Calories



Heart Rate



Song

Troubleshooting

Menu Tree

Index



■ Measurement

This lets you set the system of measurement for weight and length. Indications can be given in traditional units (pounds, miles/feet) or metric.

Operation

- 1 From the Display menu, select the Measurement menu.
- 2 Select the desired category (Weight or Length) using the ▲/▼ (Up/Down) buttons.

Weight

Available settings:

Pounds, Kilograms

Length

Available settings:

Miles/Feet, Meters

■ Language

This determines the language for all messages and indications on the BF-1. Five languages are available: English, Japanese, German, Spanish and French.

Operation

From the Display menu, select the Language menu.

Available settings:

English, 日本語 (Japanese), Deutsch (German), Español (Spanish), Français (French)

■ Display Time

This determines how long the display will remain on after the last operation or button press. The default time is 30 seconds, but you can shorten or lengthen it depending on how long you want messages and indications to show.

Operation

From the Display menu, select the Display Time menu.

Available settings:

5 seconds, 10 seconds, 30 seconds, 60 seconds, 180 seconds

Starting Up

Exercising

Computer

Music Player

Settings

Troubleshooting

Menu Tree

Index



■ Contrast

This lets you adjust the contrast of the display for optimum viewing. Please note that high Contrast settings will shorten the battery life.

Operation

- 1 From the Display menu, select the Contrast menu.
- 2 Adjust the Contrast value as desired. The higher the value, the greater the contrast.

Available range:
1 – 5

Starting Up

Exercising

Computer

Music Player

Settings

Date/Time

This lets you set the correct date and time for the BF-1, as well as the preferred format for each. To maintain the correct time, check the Date/Time setting frequently.

Operation

- 1 From the Hardware Settings menu, select the Date/Time menu.
- 2 From the Date/Time menu, set the correct date and time.



NOTE

The set Time is entered at the moment you press both ▲/▼ (Up/Down) buttons when the cursor is located at the AM/PM position.

- 3 Select the desired formats for Date and Time.

Date Format

Available settings:

Day/Month/Year (D/M/Y), Month/Day/Year (M/D/Y), Year/Month/Day (Y/M/D)

Time Format

Available settings:

12-hour, 24-hour

Troubleshooting

Menu Tree

Index



User Settings

The User Settings contain a variety of settings for use with the Training, Fitness and Free Workout features of the BF-1. These allow you to:

- Check your heart rate (pulse) and register your resting and maximum heart rates. (See “Heart Rate” below.)
- Specify the length of your walking and jogging stride. (See “Stride” on [page 73](#).)
- Specify your weight and height. (See “Weight/Height” on [page 73](#).)
- Specify your age and gender. (See “Birthday/Sex” on [page 74](#).)
- Enable the Learning function of the BF-1. (See “Learning Function” on [page 74](#).)

From the Top Menu, select Settings → User Settings.



Heart Rate

These parameters let you check your heart rate (pulse) and register your resting and maximum heart rates. Make sure the two readings are as accurate as possible. These maximum and resting heart rates are used in the Fitness and Training modes to tailor the music and pace to your true physical condition.

■ Checking your resting heart rate and registering it

It is important for exercise and training purposes that you accurately measure your resting heart rate. The best time to measure it is in the morning, after a good night's sleep, and before you get out of bed. The heart beats about 50 to 70 times a minute when we're at rest and it's generally lower in physically fit people. As you exercise and train with the BF-1, you may want to regularly check your resting heart rate and change it when necessary.

Operation

- 1 From the User Settings menu, select the Heart Rate settings.**
- 2 Make sure the pulse sensor is securely attached to your ear lobe (see [page 20](#)).**

Also, make sure you are truly resting, relaxed, and not following some strenuous activity.



Starting Up

Exercising

Computer

Music Player

Settings

Troubleshooting

Menu Tree

Index



3 Select “Check Heart Rate” in the Heart Rate settings menu.

Once your heart rate is measured, it is shown in the display.



The level indicator is shown at the bottom of the display. This indicates the detected level of your pulse over a range of 0 – 100. The higher value means your heart rate is correctly and strongly detected. If it seems that your pulse is not detected properly, try rubbing your ear robe to stimulate blood circulation or changing the pulse sensor location.

4 To register the value as your Resting Heart Rate, first call up the “Register as Resting HR” display by simultaneously pressing both ▲/▼ (Up/Down) buttons.



5 Select “Yes” to register the new value or “No” to cancel.

■ Changing the Heart Rate values

You can also change the Resting Heart Rate setting, by entering it manually instead of measuring it. The Maximum Heart Rate setting can be changed here as well.

FYI About Maximum Heart Rate

The Maximum Heart Rate is calculated from your age (220 – age) by default. However, as you exercise with the BF-1 in Fitness modes or Training mode, the BF-1 monitors your pace and heart rate during exercise and calculates your maximum heart rate. If the value differs from your Maximum Heart Rate setting, you can update the setting with the new value. For your information, your physical age based on the maximum heart rate will be displayed together with the maximum heart rate. When an exercise session is finished, a confirmation prompt appears asking whether you want to update the Maximum Heart Rate setting or not (only when the Learning Function is on; [page 74](#)).



Continue to next page

Starting Up

Exercising

Computer

Music Player

Settings

Troubleshooting

Menu Tree

Index



Operation

- 1 From the User Settings menu, select the Heart Rate settings.
- 2 Select “Change Heart Rate” in the Heart Rate settings menu.
- 3 Enter the desired values for Resting Heart Rate and Maximum Heart Rate.

NOTE

If you try to set a Resting Heart Rate value that is higher than the Maximum Heart Rate value, the two values will automatically be set to the same number.

Starting Up

Exercising

Computer

Music Player

Settings

Stride

This setting lets you enter your personal stride length. Measure your stride as accurately as you can for both walking and jogging and specify the two values here. These are used for calculating the distance and pace you walk or jog in a session (distance = steps x strides, pace = time / distance). When you specify your height, the stride length is automatically calculated (“height x 0.8” for jogging, “height x 0.5” for walking), so that you would normally not have to change this setting.

Operation

- 1 From the User Settings menu, select the Stride settings.
- 2 After measuring your actual walking and jogging strides, enter the appropriate value for each activity.

NOTE

The units of measurement used here depend on the settings made in the Measurement parameter (page 69).

Weight/Height

This setting lets you enter your personal weight and height. Measure the two as accurately as possible. The weight setting is used to calculate the number of calories you expend or burn during your exercise. The expended calorie value shown when your exercise is finished is calculated based on the weight input here. The height setting is used to calculate the distance you walked or jogged. The distance value shown when your exercise is finished is calculated based on the height input here.

Operation

- 1 From the User Settings menu, select the Weight/Height settings.
- 2 After measuring your actual weight and height, enter the appropriate value for each.

NOTE

The units of measurement used here depend on the settings made in the Measurement parameter (page 69).

Troubleshooting

Menu Tree

Index



Birthday/Sex

This setting lets you enter your age and sex. Your gender has no bearing on the functions of the BF-1, but your age is used for calculating the default maximum heart rate (according to the formula $220 - \text{your age}$) which is automatically displayed in the Heart Rate setting menu.

Operation

- 1 From the User Settings menu, select the Birthday/Sex settings.
- 2 Enter the appropriate information for each.

NOTE

The date format used for the Birthday setting depends on the setting made in the Date/Time settings (page 70).

Learning Function

The BF-1 memorizes the skip/top count and analyzes the playback priority for each song. It also memorizes your manual pace change and calculates your optimal pace and maximum heart rate in the Fitness modes and Training mode. These features are together called the Learning function.

When you change songs while exercising, the BF-1 memorizes the skip/top count—in other words, the number of times you skip over certain songs or go back to the top of certain songs—and determines the playback priority of the song. If a song has a high skip count (meaning you often skip it and go on to another song), it is given a lower playback priority. If a song has a high top count (meaning you often rewind back to the top of the song), it is given a higher playback priority.

When you change the pace manually while exercising, the BF-1 memorizes the pace changes and your heart rate and calculates your optimal starting pace, fastest pace and maximum heart rate. If the calculated maximum heart rate differs from the maximum heart rate setting you set before, you can manually register the new value to the BF-1.

If you change your pace manually or change songs while exercising, a confirmation message will appear when the workout reaches its end to prompt you to memorize the changed information. Select “Yes” to memorize.

NOTE

The playback priority is memorized for each exercise segment: warm up, during exercise, and cool down.

Starting Up

Exercising

Computer

Music Player

Settings

Troubleshooting

Menu Tree

Index



Operation

- 1 From the User Settings menu, select the Learning Function setting.**
- 2 Select the desired setting.**

Available settings:

Off: Changing pace and skip/top count are not reflected in the BF-1 settings.

On: Manual changes to your pace while exercising will be reflected in calculations of your pace (starting pace and fastest pace) and maximum heart rate setting. Skip/top count will also be reflected in the playback priority.

Reset: The memorized pace, maximum heart rate and playback priority are reset to default.

Starting Up

Exercising

Computer

Music Player

Settings

Troubleshooting

Menu Tree

Index



Information

You can check the version of your BF-1. If your version is not current, you can download the latest version from the website and update the device ([page 53](#)).

Operation

From the Top Menu, select Settings → Information.

The version information is displayed.

Initialize

This operation restores the factory default settings of the BF-1. Keep in mind that it automatically replaces any settings you've made yourself with the original settings that were on the device when you purchased it. It clears all data from the BF-1—including your exercise logs, user songs and any personal information—and performs a complete factory reset. Be careful not to use this function unless you are sure you want to erase your custom settings and data.

Do not confuse this operation with pressing the [RESET] switch ([page 11](#)). Pressing the [RESET] switch only reboots the BF-1 (for example, to turn the device on again if normal operation “freezes”) and leaves your exercise logs, songs and all other data intact.

CAUTION

Before initializing, transfer any important data (exercise log and/or training program) to the BODiBEAT Station software.

Operation

1 From the Top Menu, select Settings → Initialize.

A prompt message appears in the display.

2 Select “Yes” to execute the Initialize operation, or select “No” to cancel.

When the initialization is complete, the BF-1 will be restarted.

Starting Up

Exercising

Computer

Music Player

Settings

Troubleshooting

Menu Tree

Index

Appendix

Troubleshooting

■ **Something seems to be wrong; some malfunction seems to have occurred.**

When one of the following problems occur, immediately turn off the power and have the device inspected by Yamaha service personnel.

- The device is chipped, cracked or deformed.
- It produces a rattling sound when shaken.
- It gives off extreme heat.
- It emits unusual smells or smoke.
- The power cannot be turned on, even though the battery is fully charged.
- Battery power is depleted immediately, despite having just fully charged the device.

■ **Buttons do not respond./Display cannot be turned on or cannot be changed.**

- A system error has occurred. Press the [RESET] switch and turn on again ([page 11](#)).

■ **Power does not turn on.**

- A system error has occurred. Press the [RESET] switch and turn on again ([page 11](#)).
- Battery power is low. Charge the battery.

■ **When turning the power on, a “Memory full” message appears and the BF-1 cannot be started up.**

- There is no memory space in the device for booting up. Connect the BF-1 to the computer and delete unnecessary files.

■ **Display suddenly turns off.**

- Change the Display Time setting ([page 69](#)).

■ **The earphones easily drop off.**

- The earphones may not be put in your ears correctly. Make sure not to reverse the right and left earphones, and attach them correctly ([page 19](#)).
- The cable tightener may be loose. Slide the cable tightener toward your head ([page 20](#)).

Starting Up

Exercising

Computer

Music Player

Settings

Troubleshooting

Menu Tree

Index

- The sound is not heard from the earphones, or is only heard from one ear.**

 - Make sure that the earphone connector is firmly connected to the device (page 17).
 - Make sure that the volume is not set to minimum (pages 42 and 59).

- The LED doesn't flash even if I attach the pulse sensor.**

 - The LED flashes only during an exercise session in the Free Workout, Walk Fitness, Jog Fitness or Training modes, or when the Checking HR display is shown (page 72). In all other situations, the LED is off.

- My heart rate cannot be detected.**

 - Make sure to firmly connect the earphone cable to the device.
 - Gently rub or massage your ear to stimulate blood circulation.
 - Try changing the pulse sensor location.
 - Adjust the sensitivity or the pulse sensor (page 66).
 - Wipe the lens of the pulse sensor with a soft and dry cloth. If dirt, oil or sweat adheres to the lens of the pulse sensor, your pulse may not be detected properly.

- Song doesn't change even when I speed up or slow down the pace.**

 - Adjust the Pace Sensor and/or Step Sensor settings (page 66).

- The device becomes hot during charging.**

 - Some heat during charging is normal. However, if the device becomes extremely hot, some malfunction may have occurred. Have the device inspected by qualified Yamaha service personnel.

- Power cannot be turned off while charging the battery with the AC power adaptor.**

 - This is normal. The BF-1 is always on during battery charging, for power control purposes, when connected with the optional AC power adaptor.

- It takes a certain amount of time to start up and/or shut down.**

 - This is normal and indicates that the device is analyzing the music data and/or exercise log data. (Depending on the data size, this may take a few minutes.)

- One song (or a few songs) is repeatedly played while exercising.**

 - There are few songs which match in tempo to your exercise pace in the BF-1. Make sure to load more songs of the appropriate tempo from your computer or set the Music Priority setting to "Mix" or "BODiBEAT Songs" (page 61).

Starting Up

Exercising

Computer

Music Player

Settings

Troubleshooting

Menu Tree

Index

■ **After connecting with the computer, some information is changed (Training Programs, User Settings, etc.)**

- Depending on the synchronize setting of BODiBEAT Station, the data on the BODiBEAT Station will automatically transferred to the BF-1 and the information on the BF-1 will be replaced when you connect the BF-1 to the computer. For more information, refer to the BODiBEAT Station Owner's Manual.

■ **In the Training mode, I set the appropriate target as “Pace” but the played song’s tempo seems to be different from the set pace.**

- The pace is determined based on the jog stride setting. If the stride setting differs from your actual stride, the tempo of the song playing back while exercising may be too fast or too slow. Change the stride setting ([page 73](#)).

■ **The distance of the exercise logs seems to be wrong.**

- The distance you walk or jog is calculated based on your stride setting ([page 73](#)). Entering the exact value for your walking/jogging stride may bring the calculated distance closer to the actual value.

■ **The time of the exercise logs seem to be wrong.**

- The clock of the BF-1 may go wrong or stop if you don't use the BF-1 for a long period or you don't adjust the time for a long period. To avoid this situation, check the Date/Time setting frequently ([page 70](#)).

■ **A “Memory Full” message appears during creating/editing the training program and a new program/segment cannot be created.**

- The number of programs/segments that can be saved to the BF-1 is limited (refer to [page 37](#)). If a “Memory Full” message appears, save all programs within the BODiBEAT Station software to your computer and delete them from the BF-1. Then, load only the ones you need from the computer to the device just before exercising.

Starting Up

Exercising

Computer

Music Player

Settings

Troubleshooting

Menu Tree

Index

Menu Tree

Top Menu

- Free Workout ([page 25](#))
- Walk Fitness ([page 30](#))
- Jog Fitness ([page 30](#))
- Training ([page 35](#))
- Music Playback ([page 54](#))
 - Artist/Album ([page 55](#))
 - Songs ([page 56](#))
 - Playlists ([page 57](#))
 - Now Playing ([page 59](#))
- Data ([page 42](#))
 - Workouts ([page 29](#))
 - Days ([page 46](#))
 - Weeks ([page 46](#))
 - Months ([page 46](#))
- Settings ([page 60](#))
 - Music Settings ([page 61](#))
 - Workout Music ([page 61](#))
 - Music Priority ([page 61](#))
 - Tempo Guide ([page 62](#))
 - Half Tempo ([page 63](#))
 - Song Transition ([page 63](#))
 - Playback Time ([page 64](#))
 - Normalize Volume ([page 64](#))
 - Play Mode ([page 65](#))
 - Repeat ([page 65](#))
 - Shuffle ([page 65](#))
 - Bass Boost ([page 65](#))
 - Hardware Settings ([page 66](#))
 - Sensors ([page 66](#))
 - Pulse Sensor ([page 66](#))
 - Step Sensor ([page 67](#))
 - Pace Sensor ([page 67](#))
 - Display ([page 68](#))
 - Main Disp_Workout ([page 68](#))
 - Measurement ([page 69](#))
 - Language ([page 69](#))
 - Display Time ([page 69](#))
 - Contrast ([page 70](#))
 - Date/Time ([page 70](#))
 - User Settings ([page 71](#))
 - Heart Rate ([page 71](#))
 - Check Heart Rate ([page 71](#))
 - Change Heart Rate ([page 72](#))
 - Stride ([page 73](#))
 - Weight/Height ([page 73](#))
 - Birthday/Sex ([page 74](#))
 - Learning Function ([page 74](#))
 - Information ([page 76](#))
 - Initialize ([page 76](#))
- Guest ([page 47](#))
 - Free Workout
 - Walk Fitness
 - Jog Fitness

Starting Up

Exercising

Computer

Music Player

Settings

Troubleshooting

Menu Tree

Index

BF-1 Preset Training Programs

The warming up and cooling down segments are not included in each Preset Training Program. Before exercising or after exercising, make sure to properly do warming up and cooling down exercises by yourself.

NOTE

As for Preset Training Programs 01 – 06, the target pace is determined based on the jog stride setting (page 73). If the tempo of the song playing back while exercising is too fast or too slow, change the stride setting.

Starting Up

Exercising

Computer

Music Player

Settings

01: Short Interval 1

This program helps you build up speed. (For beginners)

Total: 3 km

	Interval (km)	Target (/km)
1	0.4	4:50
2	0.2	7:30
3	0.4	4:50
4	0.2	7:30
5	0.4	4:50
6	0.2	7:30
7	0.4	4:50
8	0.2	7:30
9	0.4	4:50
10	0.2	7:30

Pace (min : sec/km)

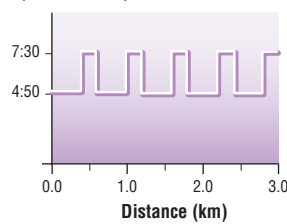

02: Short Interval 2

This program helps you build up speed. (For intermediate users)

Total: 6 km

	Interval (km)	Target (/km)
1	0.4	4:10
2	0.2	6:15
3	0.4	4:10
4	0.2	6:15
5	0.4	4:10
6	0.2	6:15
7	0.4	4:10
8	0.2	6:15
9	0.4	4:10
10	0.2	6:15
11	0.4	4:10
12	0.2	6:15
13	0.4	4:10
14	0.2	6:15
15	0.4	4:10

	Interval (km)	Target (/km)
16	0.2	6:15
17	0.4	4:10
18	0.2	6:15
19	0.4	4:10
20	0.2	6:15

Pace (min : sec/km)

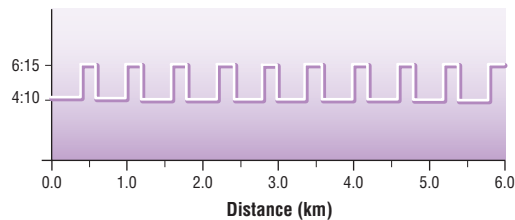

Troubleshooting

Menu Tree

Index

03: Short Interval 3

This program helps you build up speed. (For advanced users)
Total: 6 km

	Interval (km)	Target (/km)
1	0.4	3:20
2	0.2	5:40
3	0.4	3:20
4	0.2	5:40
5	0.4	3:20
6	0.2	5:40
7	0.4	3:20
8	0.2	5:40
9	0.4	3:20
10	0.2	5:40
11	0.4	3:20
12	0.2	5:40
13	0.4	3:20
14	0.2	5:40
15	0.4	3:20

	Interval (km)	Target (/km)
16	0.2	5:40
17	0.4	3:20
18	0.2	5:40
19	0.4	3:20
20	0.2	5:40

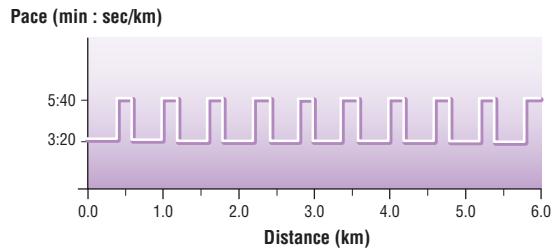

Starting Up

Exercising

Computer

Music Player

Settings

04: Long Interval 1

This program helps you build up stamina for high-speed running. (For beginners)
Total: 4.2 km

	Interval (km)	Target (/km)
1	1.0	5:40
2	0.4	7:30
3	1.0	5:40
4	0.4	7:30
5	1.0	5:40
6	0.4	7:30

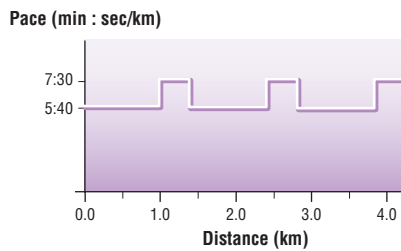

05: Long Interval 2

This program helps you build up stamina for high-speed running. (For intermediate users)
Total: 7 km

	Interval (km)	Target (/km)
1	0.4	4:50
2	0.2	7:30
3	0.4	4:50
4	0.2	7:30
5	0.4	4:50
6	0.2	7:30
7	0.4	4:50
8	0.2	7:30
9	0.4	4:50
10	0.2	7:30

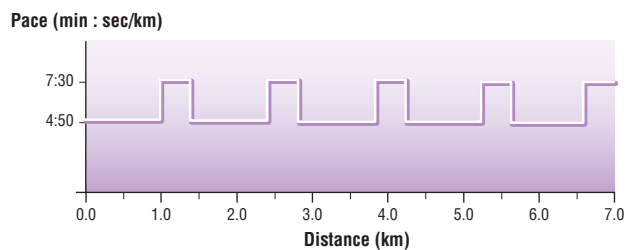

Troubleshooting

Menu Tree

Index

06: Long Interval 3

This program helps you build up stamina for high-speed running. (For advanced users)
Total: 7 km

	Interval (km)	Target (/km)
1	0.4	4:10
2	0.2	6:15
3	0.4	4:10
4	0.2	6:15
5	0.4	4:10
6	0.2	6:15
7	0.4	4:10
8	0.2	6:15
9	0.4	4:10
10	0.2	6:15

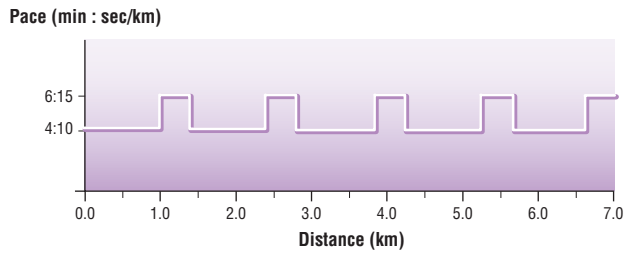

Starting Up

Exercising

Computer

Music Player

Settings

07: Tempo

This program helps you build up stamina for racing.
Total: 8 km

	Interval (km)	Target (%HRR)
1	8.0	80

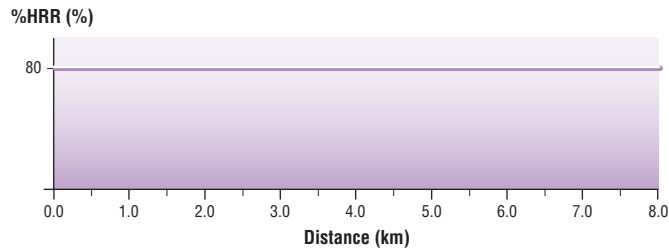

08: Buildup

This program helps you practice for racing.
Total: 6 km

	Interval (km)	Target (%HRR)
1	2.0	80
2	2.0	85
3	2.0	90

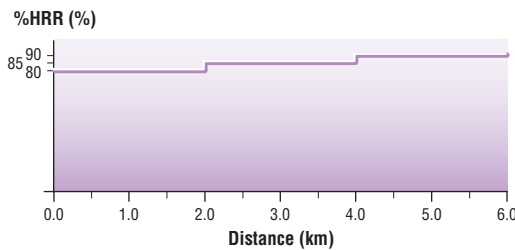

09: LSD (Long Slow Distance)

This program helps you build up basic stamina.
Total: 120 min.

	Interval (min : sec)	Target (%HRR)
1	30:00	60
2	30:00	60
2	30:00	60
4	30:00	60

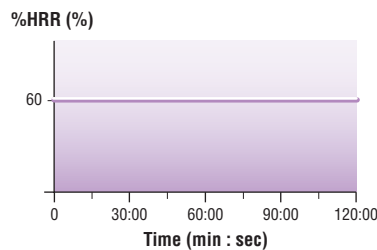

Troubleshooting

Menu Tree

Index

Specifications

Model		BF-1
Size		75.7 x 38.0 x 20.1 mm (2.98 x 1.50 x 0.79 inches)
Weight	Main body	65 g (2.29 oz)
	Earphones/ Pulse sensor	22 g (0.78 oz)
Output power		6.5 mW x 2 (33 Ω)
Frequency response		20 to 20,000 Hz
Playtime		Approximately 9 hours (typical use) * Depending on use preferences and surrounding environment.
Battery		Built-in rechargeable lithium-ion battery
Charging method (power source)		USB (computer or optional AC power adaptor)
Full-charge time		Approximately 3 hours
Operating temperature range		0° – 50°C (32° – 122°F) * Except when charging: 0° – 40°C (32° – 104°F)
Display		1.0 inch 128 x 64 OLED
LED		3-color LED (red, green, blue)
Case		Plastic
Pulse sensor	Measuring range	30 – 250 bpm
	Accuracy	±3%
Exercise modes		Free Workout, Walk Fitness, Jog Fitness, Training
Time range for Goal setting		1 – 599 minutes
Distance range for Goal setting		0.1 – 99.9 km (0 – 62.1 mi)
Calorie range for Goal setting		10 – 9999 kcal
Training programs		Maximum 99
Training intervals		Maximum 99 (for one program)
Interval range		Time: 0:10 – 59:59 Distance: 0.1 – 99.9 km (0.1 – 62.1 mi)
Exercise logs		Maximum 99
Storage media		Flash ROM
Capacity		512 MB
Supported audio formats		MP3 (32 to 320 kbps, variable bit rate) WMA (32 to 192 kbps, variable bit rate) AAC (8 to 320 kbps, variable bit rate) WAV
Auxiliary jacks		Earphones/Pulse sensor: proprietary 8-pin, USB 2.0 (Hi-speed)
Included software		BODiBEAT Station

Starting Up

Exercising

Computer

Music Player

Settings

Troubleshooting

Menu Tree

Index

Specifications

Included accessories	Armband, Earphones (with pulse sensor), USB cable, Cable clip, Earphone pads, CD-ROM, Quick Guide, User Registration card, Safety Information
Optional accessories	PA-U010 AC power adaptor (May not be available depending on your particular area. Please check with your Yamaha dealer.)

* Specifications and descriptions in this owner's manual are for information purposes only. Yamaha Corp. reserves the right to change or modify products or specifications at any time without prior notice. Since specifications, equipment or options may not be the same in every locale, please check with your Yamaha dealer.

Starting Up

Exercising

Computer

Music Player

Settings

Troubleshooting

Menu Tree

Index

Index

Symbols

%HRR	33, 37
[I/O] (Standby/On) button	10
▲/▼ (Up/Down) buttons	10

Numerics

12-hour	70
24-hour	70

A

Add Segment	38
Armband	17
Artist/Album	55

B

Bass Boost	65
Battery	9
Birthday/Sex	74
BODiBEAT Songs	62
BODiBEAT Station	50
Buildup	83

C

Cable clip	21
Cable tightener	20
Calories	27
CD-ROM	50
Computer	49
Contrast	70
Control Hold	15
Cooling down	32, 34
Copy	39
Cursor	22

D

Date Format	70
Date/Time	70
Days	45
Delete	40, 41
Display	10
Display Icons	23
Display settings	68
Display Time	69
Distance	27

E

Earphone connector	17
Earphones	19
Edit	40
Exercise intensity	33

Exercise Logs	29, 45
---------------------	--------

F

Fast-forward	58
Fitness Modes	30
Free Workout	25

G

Goal Setting	27
Guest Mode	47
Guide Sound	63

H

Half Marathon	27
Half Tempo	63
Hardware Settings	66
Heart Rate	71
Hold	15

I

Information	76
Initial Settings	12
Initialize	76
Insert	40
Installation	51
Interval	37

J

Jog Fitness	30
-------------------	----

K

Kilograms	69
-----------------	----

L

Language	12, 69
Learning Function	74
LED	10
Loading Music Data	53
Lock	43
Log	29
Log displays	46
Long Interval	82
LSD (Long Slow Distance)	83

M

Main Display	68
Marathon	27
Maximum Heart Rate	72
Measurement	69
Measurement Error	31

Starting Up

Exercising

Computer

Music Player

Settings

Troubleshooting

Menu Tree

Index

[MENU] button	10	Song Transition	63
Menu Tree	80	Songs	56
Meters	69	Specifications	84
Miles/Feet	69	[Standby/On] button	10
Mix	62	Step Sensor	67
Months	45	Stop	55
Music Playback Mode	54	Stride	73
Music Priority	61	System Requirements	51
Music Select	28		
Music Settings	61	T	
N		Target	37
New	37	Tempo	83
Normalize Volume	64	Tempo Guide	62
Now Playing	59	Time	27
O		Time Format	70
Optimal aerobic exercise	30	Top	43
P		Top Menu	14, 59
Pace display	43, 44	Training Mode	35
Pace Sensor	67	Training program	35
Pause	42, 55	Troubleshooting	77
PC mode	52	Try	12
Percentage of heart rate reserve	33, 37	U	
Play Info display	55, 59	Unlimited	27
Play Mode	65	Update	53
Playback Time	64	USB cable	52
Playlists	28, 57	USB connector	11
Pounds	69	User Settings	71
Power Off	16	User Songs	62
Power On	12	V	
Preset Training Programs	35, 81	Version	76
Pulse Sensor	19, 66	View/Edit	39
R		Volume	42, 59
Repeat	65	W	
Repeat All	65	Walk Fitness	30
Repeat One	65	Warming up	34
[RESET] switch	11	Website	53
Resting heart rate	71	Weeks	45
Reverse	58	Weight/Height	73
S		Workout Music	61
Segment	38	Workouts	45
Select Song display	42		
Sensors	66		
Set Up	12		
Settings	60		
Short Interval	81		
Shuffle	65		
Skip	43, 58		
Skip/top count	74		

Starting Up

Exercising

Computer

Music Player

Settings

Troubleshooting

Menu Tree

Index

For details of products, please contact your nearest Yamaha representative or the authorized distributor listed below.

Pour plus de détails sur les produits, veuillez-vous adresser à Yamaha ou au distributeur le plus proche de vous figurant dans la liste suivante.

Die Einzelheiten zu Produkten sind bei Ihrer unten aufgeführten Niederlassung und bei Yamaha Vertragshändlern in den jeweiligen Bestimmungsländern erhältlich.

Para detalles sobre productos, contacte su tienda Yamaha más cercana o el distribuidor autorizado que se lista debajo.

NORTH AMERICA

CANADA

Yamaha Canada Music Ltd.
135 Milner Avenue, Scarborough, Ontario,
M1S 3R1, Canada
Tel: 416-298-1311

U.S.A.

Yamaha Corporation of America
6600 Orangethorpe Ave., Buena Park, Calif. 90620,
U.S.A.
Tel: 714-522-9011

CENTRAL & SOUTH AMERICA

MEXICO

Yamaha de México S.A. de C.V.
Calz. Javier Rojo Gómez #1149,
Col. Guadalupe del Moral
C.P. 09300, México, D.F., México
Tel: 55-5804-0600

BRAZIL

Yamaha Musical do Brasil Ltda.
Rua Joaquim Floriano, 913 - 4º andar, Itaim Bibi,
CEP 04534-013 Sao Paulo, SP. BRAZIL
Tel: 011-3704-1377

ARGENTINA

Yamaha Music Latin America, S.A.
Sucursal de Argentina
Viamonte 1145 Piso 2-B 1053,
Buenos Aires, Argentina
Tel: 1-4371-7021

PANAMA AND OTHER LATIN AMERICAN COUNTRIES/ CARIBBEAN COUNTRIES

Yamaha Music Latin America, S.A.
Torre Banco General, Piso 7, Urbanización Marbella,
Calle 47 y Aquilino de la Guardia,
Ciudad de Panamá, Panamá
Tel: +507-269-5311

EUROPE

THE UNITED KINGDOM

Yamaha Music U.K. Ltd.
Sherbourne Drive, Tilbrook, Milton Keynes,
MK7 8BL, England
Tel: 01908-366700

IRELAND

Danfay Ltd.
61D, Sallynoggin Road, Dun Laoghaire, Co. Dublin
Tel: 01-2859177

GERMANY

Yamaha Music Central Europe GmbH
Siemensstraße 22-34, 25462 Rellingen, Germany
Tel: 04101-3030

SWITZERLAND/LIECHTENSTEIN

**Yamaha Music Central Europe GmbH,
Branch Switzerland**
Seefeldstrasse 94, 8008 Zürich, Switzerland
Tel: 01-383 3990

AUSTRIA

**Yamaha Music Central Europe GmbH,
Branch Austria**
Schleiergasse 20, A-1100 Wien, Austria
Tel: 01-60203900

CZECH REPUBLIC/SLOVAKIA/ HUNGARY/SLOVENIA

**Yamaha Music Central Europe GmbH,
Branch Austria, CEE Department**
Schleiergasse 20, A-1100 Wien, Austria
Tel: 01-602039025

POLAND

**Yamaha Music Central Europe GmbH
Sp.z o.o. Oddział w Polsce**
ul. 17 Stycznia 56, PL-02-146 Warszawa, Poland
Tel: 022-868-07-57

THE NETHERLANDS/ BELGIUM/LUXEMBOURG

**Yamaha Music Central Europe GmbH,
Branch Benelux**
Clarissenhof 5-b, 4133 AB Vianen, The Netherlands
Tel: 0347-358 040

FRANCE

Yamaha Musique France
BP 70-77312 Marne-la-Vallée Cedex 2, France
Tel: 01-64-61-4000

ITALY

Yamaha Musica Italia S.P.A.
Viale Italia 88, 20020 Lainate (Milano), Italy
Tel: 02-935-771

SPAIN/PORTUGAL

Yamaha Música Ibérica, S.A.
Ctra. de la Coruna km. 17, 200, 28230
Las Rozas (Madrid), Spain
Tel: 91-639-8888

GREECE

Philippos Nakas S.A. The Music House
147 Skiathou Street, 112-55 Athens, Greece
Tel: 01-228 2160

SWEDEN

Yamaha Scandinavia AB
J. A. Wettergrens Gata 1
Box 30053
S-400 43 Göteborg, Sweden
Tel: 031 89 34 00

DENMARK

YS Copenhagen Liaison Office
Generatorvej 6A
DK-2730 Herlev, Denmark
Tel: 44 92 49 00

FINLAND

F-Musiikki Oy
Kluuvikatu 6, P.O. Box 260,
SF-00101 Helsinki, Finland
Tel: 09 618511

NORWAY

Norsk filial av Yamaha Scandinavia AB
Grini Næringspark 1
N-1345 Østerås, Norway
Tel: 67 16 77 70

ICELAND

Skifan HF
Skeifan 17 P.O. Box 8120
IS-128 Reykjavik, Iceland
Tel: 525 5000

OTHER EUROPEAN COUNTRIES

Yamaha Music Central Europe GmbH
Siemensstraße 22-34, 25462 Rellingen, Germany
Tel: +49-4101-3030

AFRICA

**Yamaha Corporation,
Asia-Pacific Music Marketing Group**
Nakazawa-cho 10-1, Naka-ku, Hamamatsu,
Japan 430-8650
Tel: +81-53-460-2312

MIDDLE EAST

TURKEY/CYPRUS

Yamaha Music Central Europe GmbH
Siemensstraße 22-34, 25462 Rellingen, Germany
Tel: 04101-3030

OTHER COUNTRIES

Yamaha Music Gulf FZE
LOB 16-513, P.O.Box 17328, Jubel Ali,
Dubai, United Arab Emirates
Tel: +971-4-881-5868

ASIA

THE PEOPLE'S REPUBLIC OF CHINA

Yamaha Music & Electronics (China) Co.,Ltd.
25/F., United Plaza, 1468 Nanjing Road (West),
Jingan, Shanghai, China
Tel: 021-6247-2211

HONG KONG

Tom Lee Music Co., Ltd.
11/F., Silvercord Tower 1, 30 Canton Road,
Tsimshatsui, Kowloon, Hong Kong
Tel: 2737-7688

INDONESIA

**PT. Yamaha Music Indonesia (Distributor)
PT. Nusantik**
Gedung Yamaha Music Center, Jalan Jend. Gatot
Subroto Kav. 4, Jakarta 12930, Indonesia
Tel: 21-520-2577

KOREA

Yamaha Music Korea Ltd.
8F, 9F, Dongsung Bldg. 158-9 Samsung-Dong,
Kangnam-Gu, Seoul, Korea
Tel: 080-004-0022

MALAYSIA

Yamaha Music Malaysia, Sdn., Bhd.
Lot 8, Jalan Perbandaran, 47301 Kelana Jaya,
Petaling Jaya, Selangor, Malaysia
Tel: 3-78030900

PHILIPPINES

Yupangco Music Corporation
339 Gil J. Puyat Avenue, P.O. Box 885 MCPO,
Makati, Metro Manila, Philippines
Tel: 819-7551

SINGAPORE

Yamaha Music Asia Pte., Ltd.
#03-11 A-Z Building
140 Paya Lebar Road, Singapore 409015
Tel: 747-4374

TAIWAN

Yamaha KHS Music Co., Ltd.
3F, #6, Sec.2, Nan Jing E. Rd. Taipei.
Taiwan 104, R.O.C.
Tel: 02-2511-8688

THAILAND

Siam Music Yamaha Co., Ltd.
891/1 Siam Motors Building, 15-16 floor
Rama 1 road, Wangmai, Pathumwan
Bangkok 10330, Thailand
Tel: 02-215-2626

OTHER ASIAN COUNTRIES

**Yamaha Corporation,
Asia-Pacific Music Marketing Group**
Nakazawa-cho 10-1, Naka-ku, Hamamatsu,
Japan 430-8650
Tel: +81-53-460-2317

OCEANIA

AUSTRALIA

Yamaha Music Australia Pty. Ltd.
Level 1, 99 Queensbridge Street, Southbank,
Victoria 3006, Australia
Tel: 3-9693-5111

NEW ZEALAND

Music Houses of N.Z. Ltd.
146/148 Captain Springs Road, Te Papapa,
Auckland, New Zealand
Tel: 9-634-0099

COUNTRIES AND TRUST TERRITORIES IN PACIFIC OCEAN

**Yamaha Corporation,
Asia-Pacific Music Marketing Group**
Nakazawa-cho 10-1, Naka-ku, Hamamatsu,
Japan 430-8650
Tel: +81-53-460-2312

HEAD OFFICE Yamaha Corporation, Pro Audio & Digital Musical Instrument Division
Nakazawa-cho 10-1, Naka-ku, Hamamatsu, Japan 430-8650
Tel: +81-53-460-3273