

THOMSON

Thomson Lyra
Personal Jukebox
User's Guide

PDP2800

Important Information

WARNING

To reduce the risk of fire or electric shock, do not expose this product or AC charger to rain or moisture.

CAUTION

RISK OF ELECTRIC SHOCK DO NOT OPEN

To reduce the risk of electric shock, do not remove cover (or back). No user serviceable parts inside. Refer servicing to qualified service personnel.



This symbol indicates "dangerous voltage" inside the product that presents a risk of electric shock or personal injury.



This symbol indicates important instructions accompanying the product.

To reduce risk of injury, charge only rechargeable batteries recommended by the manufacturer for this product. Other types of batteries may burst causing damage and personal injury.

Sound Pressure Control



Les articles de loi L44.5 et 44.6 du code de la santé publique, modifiés par l'article 2 de la loi du 28 Mai 1996 imposent une puissance acoustique maximale de 100 décibels. Le casque livré (code 350 437 00) et votre appareil respectent la législation en vigueur.

A pleine puissance, l'écoute prolongée du baladeur peut endommager l'oreille de l'utilisateur.

SERVICE

This product should be serviced only by those specially trained in appropriate servicing techniques. For instructions on how to obtain service, refer to the warranty in this guide.

Product Registration

Please fill out the product registration card and return it immediately. Returning this card allows us to contact you if needed.

Product Information

Keep your sales receipt for proof of purchase to obtain warranty parts and service and attach it here. Record the serial number and model numbers — both numbers are located on the product.

Model No. _____ Serial No. _____

Purchase Date _____ Place of purchase _____

Table of Contents

Chapter 1: Getting Started

Things to consider before you get started...	4
Computer System Requirements	4
Warning	4
Caution	4
Caution While Driving	4
Back up your data	4
What you want to know & where to go	5
Unpack the box and check your parts	6
Overview of buttons and the display	7
Basic Operation	10
Playback operation	11
Operation: Step-by-Step Examples	12
Sort by Artist	13
Sort by Album	14
Sort by Title	15
Sort by Genre	16
Sort by User Playlists	18
Sort by Audio Files	19
Sort by All Files	20
LCD Screen During Playback	21
Setup Information – the details	22
Step 1: Install software in your computer	22
Step 2: Launch the MusicMatch software	25
Set up the Recorder Settings	26
Save CD tracks to play on your PC or in your Thomson Lyra Jukebox	28
Download music from the Internet	29
Organizing Your Music	29
Creating Personalized Playlists	30
Step 3: Transfer files to your Thomson Lyra Jukebox	31

Table of Contents

Chapter 2: Thomson Lyra Jukebox Menus and Features

Using the Play Modes	34
How to access the play modes	35
Repeat A-B	35
Adjusting DSP Settings	36
Personalizing DSP Output (GRAPHIC EQ menu item)	37
Setting LCD Preferences (SYSTEM SETTINGS menu)	38
Connecting your Thomson Lyra Jukebox to your car stereo	40
Connecting your Thomson Lyra Jukebox to your stereo system	41
Portable hard drive capability	42

Chapter 3: Additional Information

Tips and Troubleshooting	44
FAQ (Frequently Asked Questions)	45
Specifications & System Requirements	45
Index	49

Chapter 1

Getting Started

Chapter Overview:

- Things to consider before you get started
- What's where — what you want to know and where to go
- Parts checklist
- Overview of Thomson Lyra Jukebox buttons
- Basic operation (how to play music on your Thomson Lyra Jukebox)
- Setup details
- How to use MusicMatch to transfer files to your Thomson Lyra Jukebox

Getting Started

Things to consider before you get started...

Computer System Requirements

- Pentium 233MHz or higher (Pentium II 300 MHz or higher recommended)
- Windows® 98SE, Me, 2000, or XP
- Internet Explorer 4.0 or higher
- Internet access
- 4 MB free hard disk space for the software plus 1 MB for every minute of CD quality music you store on your hard drive.
- 32MB RAM (64 MB recommended)
- CD-ROM drive capable of digital audio extraction
- USB port
- Installed sound card
- 16-bit color video card

Warning

Use of this product is for your personal use only. Unauthorized recording or duplication of copyrighted material may infringe upon the rights of third parties and may be contrary to copyright laws.

Caution





Exposure to direct sunlight or extreme heat (such as inside a parked car) may cause damage or malfunction.

Caution While Driving

Use of headphones while operating an automobile or moving vehicle is not recommended and is unlawful in some states and areas. Be careful and attentive on the road. Stop operation of the unit if you find it disruptive or distracting while driving.

Back up your data

As with any device that has a hard drive, you must back up the drive. Thomson multimedia is not responsible for lost data.

What you want to know	Go to page ...
	<p>Parts checklist — everything that was in the Thomson Lyra box 6</p>
	<p>Buttons — where they are and what they do 7</p>
	<p>Operation — the details 10 If the information on the printed QuickStart guide wasn't enough, this section gives you a little more detail about the basics of sorting and playing music on your Thomson Lyra Jukebox.</p>
	<p>Setup information — Step-by-Step instructions 22 The Thomson Lyra QuickStart Guide (the printed foldout that came with your Thomson Lyra Jukebox) stepped you through the basics of installing software and downloading files. If you need more detail, you're in the right place — go to page 22 for step-by-step instructions.</p>
	<p>Answers... Chapter 3 (p. 43) to questions and solutions to problems — FAQ and Troubleshooting</p>

Getting Started

Unpack the box and check your parts

Your Thomson Lyra Jukebox came with everything you need to make music portable — all of the items shown below should have been packed in the box with your Thomson Lyra Jukebox.

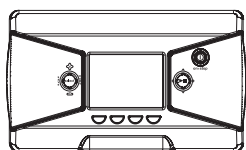

Thomson Lyra Jukebox
model number PDP 2800



AC/DC adapter charger
part number: 55198150



Music Management CD
contains the Thomson Lyra
Jukebox Applications &
MusicMatch Jukebox software



Headphones
part number: 55198230

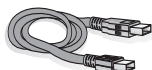

Mini USB cable
Part number: 55170840
Plug the small end into your
Thomson Lyra Jukebox (next to the
Headphones jack), and plug the
other end into your computer's USB
port. Go to page 24 for connection
details.



Car adapter kit
Part numbers
car cord adapter: 55205560
cassette adapter: 20965910
Go to page 40 for
instructions.

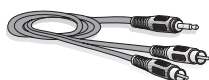

Line out cable — connects
Thomson Lyra Jukebox to your
audio system.
Part number: 55049770
For details, go to page 41.

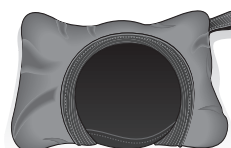

Carrying case
Part number: 55187610

Overview of buttons and the display

The following pages explain what each button does — some of the buttons have more than one function depending upon whether you're playing music or not.

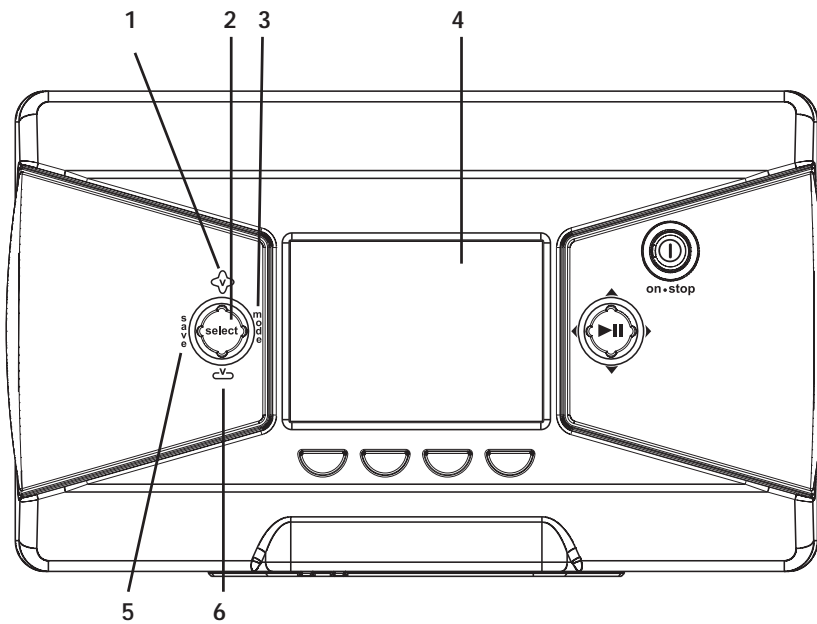

- 1 **Volume up** – Increases the volume level.
- 2 **SELECT**– When using the Thomson Lyra Jukebox menu, selects a highlighted item. When you're creating a User Playlist and you've highlighted a title, SELECT tags a song to be included in a User Playlist.
- 3 **MODE** – Accesses the mode menu where you can choose the following playback modes: *NORMAL*, *REPEAT*, *REPEAT 1*, *REPEAT ALL*, *SHUFFLE*, and *REPEAT ALL SHUFFLE*. For details about playback modes, go to page 34.
- 4 **LCD (Liquid Crystal Display)** – This is where the Thomson Lyra's user interface appears (go to page 21 for an explanation of the items that appear on the LCD during playback).
- 5 **SAVE** – Saves a User Playlist that consists of the songs you've tagged. You can create a new playlist or add songs to an existing User Playlist.
- 6 **Volume down** – Decreases the volume level.

continued on next page

Getting Started

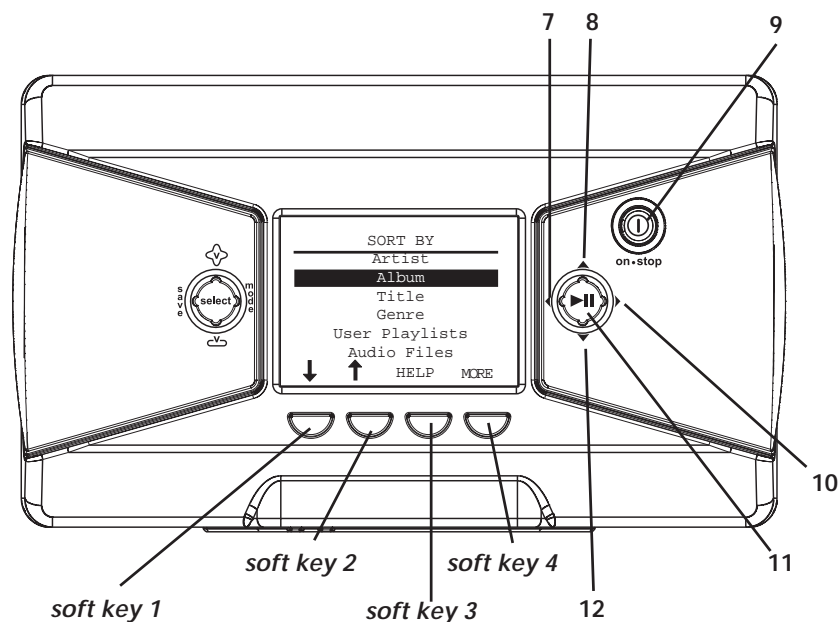

7 Left arrow button – When you’re playing music, press and release to skip back to the previous song (to scan backwards in the song that’s playing, press and hold). When you’re using the Thomson Lyra Jukebox menu, moves highlight left.

8 Up arrow button – When using the Thomson Lyra Jukebox menu, moves the highlight up.

9 STOP/power – Turns on your Thomson Lyra Jukebox. To turn off the Thomson Lyra Jukebox, press and hold the stop/power button. When you’re playing music, stops playback.

10 Right arrow button – When you’re playing music, press and release to skip forward to the next song (to scan forwards in the current song, press and hold). When you’re using the Thomson Lyra Jukebox menu, moves highlight right.

11 PLAY/PAUSE – Press to play. During playback, press to pause music.

12 Down arrow button – When using the Thomson Lyra Jukebox menu, moves the highlight down.

Soft keys 1, 2, 3, and 4 – These buttons provide quick access to the menu items that appear at the bottom of the screen (the LCD). You’ll notice the items on the screen change based on the features you’re using — these are called adaptive navigation keys.

In the illustration above, if you pressed soft key 1 the highlight would move down (*Title* would be highlighted); press soft key 2 to move up (*Artist* would be highlighted); soft key 3 (*HELP*) takes you to the Thomson Lyra Jukebox’s on-screen help information; soft key 4 (*MORE*) takes you to additional menu items.

Getting Started

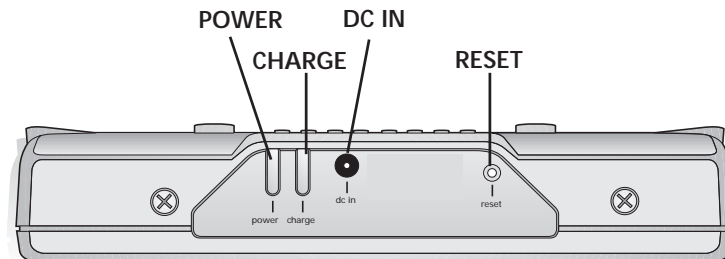

Back view

POWER indicator – Lights when the Thomson Lyra Jukebox is on (receiving power from the DC IN jack).

CHARGE indicator – Lights when the battery is charging, and when the Thomson Lyra Jukebox is powered on and receiving power from the DC IN jack. Flashes when there is an error.

DC IN jack – Plug in the AC power adapter here. When you plug in the AC adapter, the battery inside of the Thomson Lyra Jukebox automatically starts charging.

RESET button – If your Thomson Lyra Jukebox appears to be locked up, press the RESET button (the memory will be cleared and settings will return to the factory defaults).

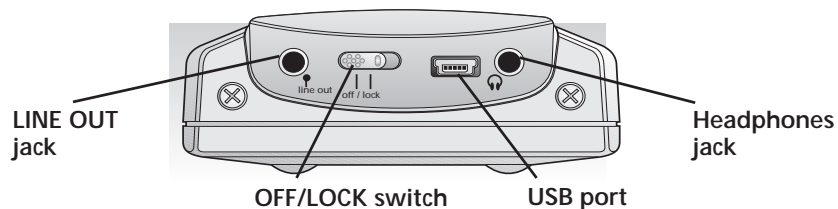

Right side view

LINE OUT – Attach the line out cable here when you're connecting the Thomson Lyra Jukebox to an audio system.

OFF/LOCK switch – To make the buttons inactive, slide the switch to the lock position (the  key icon appears in the display to remind you that you've locked the buttons). Slide the switch to the OFF position for normal operation (button lock off).

USB port – Attach the small end (Type mini-B) of the mini-USB cable here. Attach the large end (Type A) to your computer.

Headphones jack – Insert the headphones plug here.

Getting Started

Basic Operation

The information in this section presumes you've successfully transferred files to your Thomson Lyra Jukebox, and you're ready to play some music.

If you need specific set-up information (downloading music, transferring files, installing software), go to page 22.

If you want more detailed information about the Thomson Lyra Jukebox's features, go to page 34.

Understanding how to navigate through the Thomson Lyra Jukebox's menu system, combined with how the buttons operate, will give you the information you need for basic functionality.

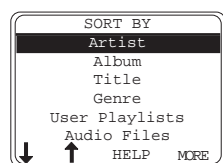

The *SORT BY* menu is the main menu. The navigation scheme is the same no matter how many menus you access:

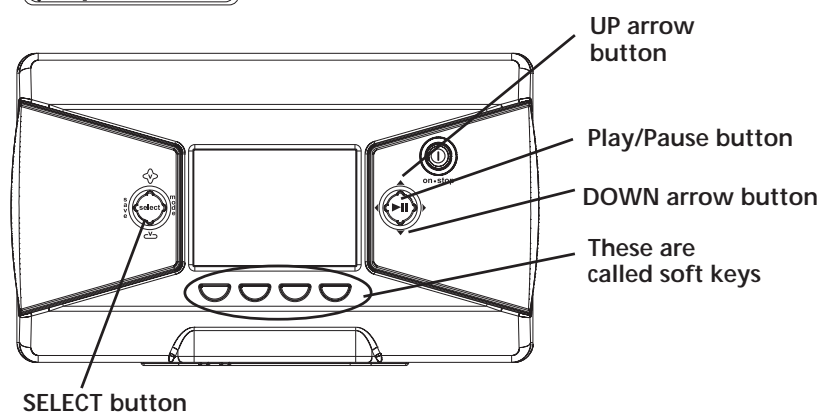

1. Press the arrow up or down buttons (▲ or ▼) to highlight different items on the screen.
2. To see the submenu, press the SELECT button.
3. Use the soft keys (if necessary) to highlight the song title you want to hear.

Note: If you need more explanation, go to page 11.

4. Once the song you want to play is on the screen, press ►|| (play/pause) to play the track. Press it again to pause playback.

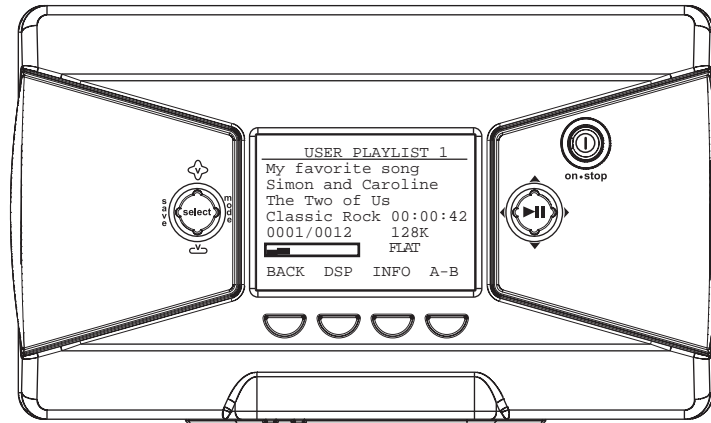

Playback operation

- To scan backwards in the track that's playing, press and hold ◀ (the left arrow button).
- To scan forwards in the track that's playing, press and hold ▶ (the right arrow button).
- To go to the next track, press and release ▶ (the right arrow button).
- To go to the previous track, press and release ◀ (the left arrow button).
- To stop playback, press ⏹ (the STOP button). The display returns to the previous menu location.
- To turn up the volume, press 🔊 (the volume up button), The volume display bar updates to show the increase in volume level.
- To turn down the volume, press 🔇 (the volume down button). The volume display bar updates to show the decrease in volume level.
- To change the play mode setting, press the MODE button (for details about the different play modes go to page 34)

Getting Started

Operation: Step-by-Step Examples

The following example illustrates (with more detail than the previous information) how you find the song you want to play.

1. These instructions presume you've already done the following:
 - Installed the MusicMatch Jukebox software and the Lyra MP3/Personal Jukebox profiler application (go to page 22 for detailed instructions).
 - Transferred music from your computer to the Thomson Lyra Jukebox (page 31 has detailed instructions) and profiled the contents of the Thomson Lyra Jukebox through MusicMatch Jukebox or the Profiler software.

Note: *The music you're transferring could be from a CD you put in your computer, the internet, or music you already had loaded onto your computer.*
2. If you haven't already unplugged the Thomson Lyra Jukebox from your computer, disconnect the USB cable from the Thomson Lyra Jukebox.

Note: *If you're running Windows 2000, XP, or Me, you must stop the device before unplugging it. Click the  icon (the Unplug or Eject hardware icon) from the system tray and select the USB Mass Storage device for the drive letter associated with the Thomson Lyra Jukebox, and click STOP. See the Windows Help for details about the Unplug or Eject Hardware topic.*
3. If you've fully charged the battery (the Thomson Lyra Jukebox needs to be plugged in for about 4 hours before the battery is fully charged), disconnect the AC adapter from the outlet and then from your Thomson Lyra Jukebox.

Note: *If the battery isn't fully charged, keep the Thomson Lyra Jukebox plugged in while you listen to the music you've transferred from your computer.*
4. Connect the headphones to your Thomson Lyra Jukebox (insert the end of the headphones connector into the phones jack on the side of the Lyra).
5. If your Thomson Lyra Jukebox isn't already on, turn it on (press and hold the  button for two seconds). The Thomson Lyra logo flashes on the screen, and then the main menu appears the *SORT BY* menu.

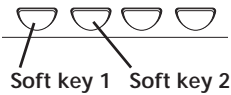
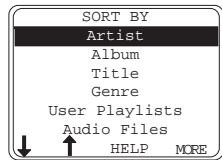

Sort by Artist

1. Highlight *Artist* (press the up or down arrow button).

Note: You can also highlight items on the screen by pressing the soft keys when they have arrows above them. In this example soft key 1 would move the highlight down and soft key 2 would move the highlight up.

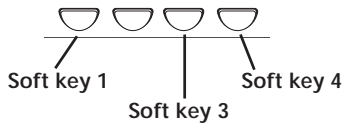
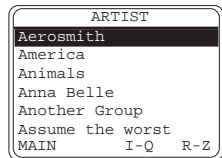

2. Press the SELECT button (the *ARTIST* menu appears with the artists stored on your Thomson Lyra Jukebox listed in alphabetical order).

- To see the list of artists whose names start with I - Q, press soft key 3.
- To see artists from R - Z, press soft key 4.
- To return to the *SORT BY* menu, press soft key 1 (labeled *MAIN*).

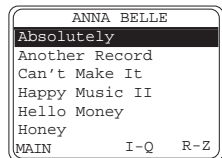

3. To see the albums for the artist highlighted, press SELECT (the album titles for that artist appear in alphabetical order).

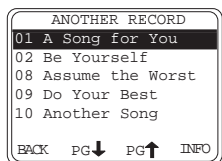

4. To see the songs on the album you've highlighted, press SELECT (the songs for that album appear).

The SELECT button may be used alternately to select and de-select titles that you want to save in the programmable playlist.

Getting Started

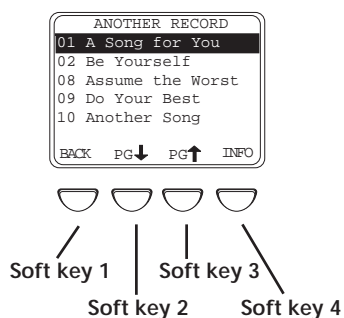

Highlight the desired song.

- To play the song, press (the play/pause button).
- To go to the previous menu, press soft key 1 (*BACK*).
- To scroll down the list 5 songs at a time, press soft key 2 (*PG down*).
- To scroll up the list 5 songs at a time, press soft key 3 (*PG up*).
- To get more info about the song, press soft key 4 (*INFO*).

Note: The information provided in the *INFO* screen depends upon the ID3 tags that have been set up for the song.

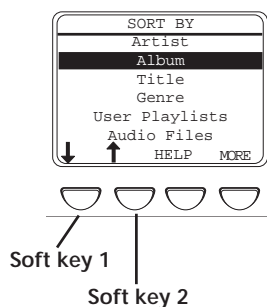

Sort by Album

1. Highlight *Album* (press the up or down arrow button, or the first or second soft key).

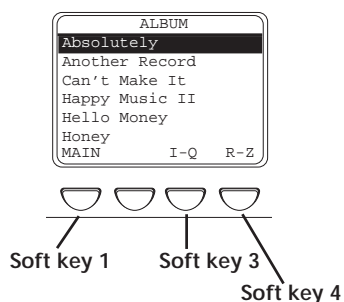

2. Press *SELECT* (the *ALBUM* menu appears with the titles of the albums stored on your Thomson Lyra Jukebox listed in alphabetical order).
 - To see the list of albums with names starting with I - Q, press soft key 3.
 - To see albums from R - Z, press soft key 4.
 - To return to the *SORT BY* menu, press soft key 1 (labeled *MAIN*).

Getting Started

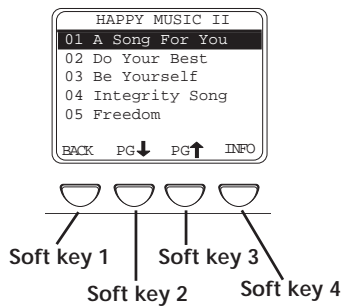

3. To see the songs for the album highlighted, press SELECT (the songs on that album appear).

The SELECT button may be used alternately to select and de-select titles that you want to save in the programmable playlist.

4. Highlight the song you want to play.
 - To play the song, press ►||| (the play/pause button).
 - To go to the previous menu, press soft key 1 (BACK).
 - To scroll down the list 5 songs at a time, press soft key 2 (PG down).
 - To scroll up the list 5 songs at a time, press soft key 3 (PG up).
 - To get more info about the song, press soft key 4 (INFO).

Note: *The information provided in the INFO screen depends upon the ID3 tags that have been set up for the song.*

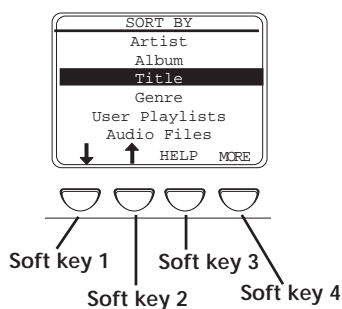

Sort by Title

1. Highlight *Title* (press the up or down arrow buttons, or the first or second soft key).
2. Press SELECT (the *TITLE* menu appears that lists all of the song titles in alphabetical order that are stored on your Thomson Lyra Jukebox).
 - To play the first song, press ►||| (the play/pause button).
 - To highlight a different song on the list, press the up or down arrow button.
 - To see the titles with names that start with I - Q, press soft key 3.

Getting Started

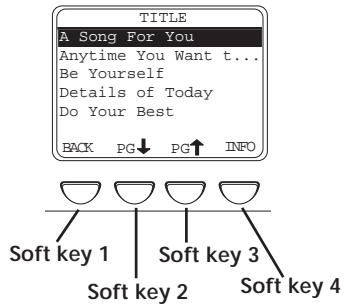

- To see the titles from R - Z, press soft key 4.
- To return to the *SORT BY* menu, press soft key 1 (labeled *MAIN*).
- To get more info about the song, press soft key 4 (*INFO*).

Note: The information provided in the *INFO* screen depends upon the ID tags that have been set up for the song.

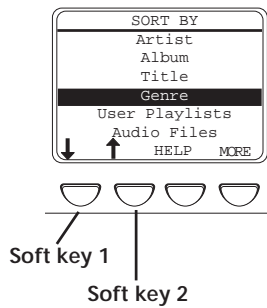

Sort by Genre

1. Highlight *Genre* (press the up or down arrow button, or the first or second soft key).

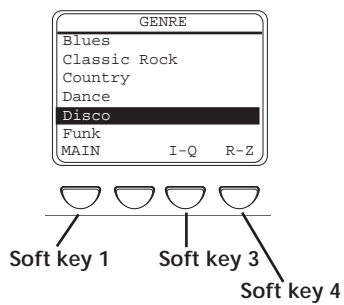

2. Press SELECT (the *GENRE* menu appears).
 - To highlight different genres, press the up or down arrow button.
 - To see the list of genres starting with I - Q, press soft key 3.
 - To see the list of genres starting with R - Z, press soft key 4.
 - To return to the *SORT BY* menu, press soft key 1 (labeled *MAIN*).

Getting Started

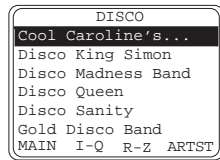

Soft key 4

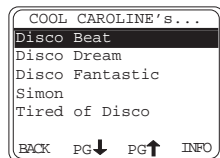

Soft key 1 Soft key 3
Soft key 2 Soft key 4

3. To see a list of artists for the genre you've highlighted, press SELECT (a list of artists for that genre appears). To jump to the complete Artist listing, press soft key 4 (*ARTST*).

4. To see the songs for the artist that you've highlighted within this genre, press SELECT (the songs appear in alphabetical order).

The SELECT button may be used alternately to select and de-select titles that you want to save in the programmable playlist.

5. Highlight the song you want to play.
 - To play the song, press  (the play/pause button).
 - To go to the previous menu, press soft key 1 (*BACK*).
 - To scroll down the list 5 songs at a time, press soft key 2 (*PG down*).
 - To scroll up the list 5 songs at a time, press soft key 3 (*PG up*).
 - To get more info about the song, press soft key 4 (*INFO*).

Note: The information provided in the *INFO* screen depends upon the ID3 tags that have been set up for the song.

Getting Started

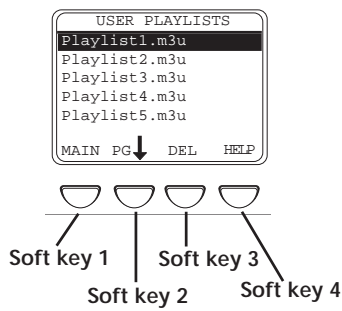
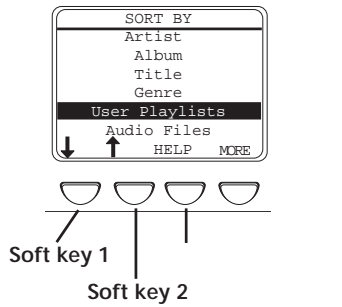

How to Create User Playlists

If you need information about Creating User Playlists, go to page 30.

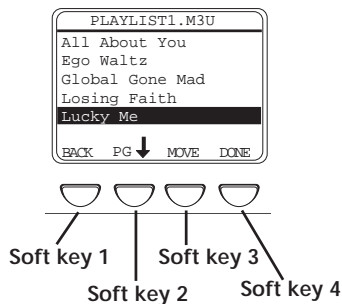

Sort by User Playlists

1. Highlight *User Playlists* (press the up or down arrow button, or soft key 1 or soft key 2).
2. Press SELECT (a list of User Playlists you've created and stored on your Thomson Lyra Jukebox appears on the screen).
 - To see contents of the playlist that's highlighted, press SELECT (skip to step 3 for more information).
 - To play the first song in the User Playlist that is highlighted, press ▷||| (the play/pause button).
 - To go back to the *SORT BY* menu, press soft key 1 (*MAIN*).
 - To scroll down to the next 5 User Playlists, press soft key 2 (*PG down*).
 - To delete the playlist that's highlighted, press soft key 3 (*DEL*). A screen appears asking you to confirm that you want to delete the playlist.
 - For on-screen help, press soft key 4 (*HELP*).

3. When the individual songs of the playlist are on the screen:
 - Play the song that you've highlighted, by pressing ▷||| (play/pause button).
 - Scroll through the songs in the playlist by pressing the up or down arrow button.To scroll a page at a time, press soft key 2 (*PG down*).

Getting Started

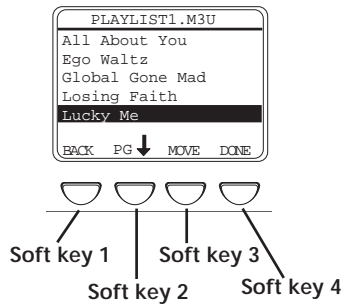

- Delete a song from the playlist by DEL (delete) — soft key 3 — (a screen appears asking you to confirm that you want to delete this item).
- Rearrange the order of the songs in the playlist by pressing soft key 4 (MOVE) — go to instructions below for more information.

How to rearrange the order of the songs

1. When the individual songs of the playlist are on the screen, press the up or down arrow button to highlight a song you want move and press soft key 4 (MOVE) — explained in previous section.
 - To move the song down one position, press soft key 2 (MOVE down).
 - To move the song up one position, press soft key 3 (MOVE up).

Note: If you want to keep the playlist order the same, just press soft key 4 (CANCEL) — the previous screen appears and the original order of this playlist is restored.

2. When you have the songs in the playlist arranged in the order you want, press soft key 1 (DONE).

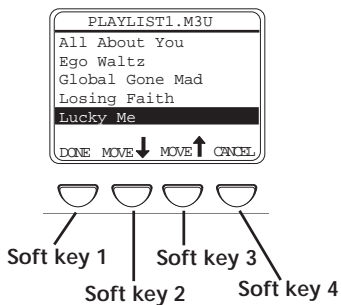

Sort by Audio Files

1. Highlight *Audio Files* (press the up or down arrow button, or the first or second soft key).
2. Press SELECT (the *AUDIO FILES* menu appears). It lists all supported audio files that are stored on your Thomson Lyra Jukebox by file name in alphabetical order.
 - To play the first song, press ▷|| (the play/pause button).
 - To highlight a different song on the list, press the up or down arrow button.
 - To see the audio files with file names that start with I - Q, press soft key 3.
 - To see the audio files from R - Z, press soft key 4.
 - To return to the *SORT BY* menu, press soft key 1 (labeled *MAIN*).

continued on next page

Getting Started

- To get more info about the song, press soft key 4 (*INFO*).

Note: The information provided in the *INFO* screen depends upon the *ID3* tags that have been set up for the song.

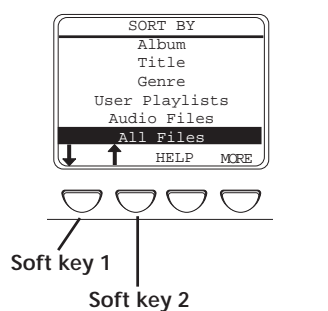

Sort by All Files

Since your Thomson Lyra Jukebox has a hard drive with 10 Gigabytes of storage space, it can be used to store and transport files. To see all of the files that are stored on your Thomson Lyra Jukebox:

1. Highlight *All Files* (press the up or down arrow buttons, or the first or second soft key).

Note: the *All Files* category doesn't appear on initial *Sort By* menu (it's below *Audio Files*).

2. Press *SELECT* (the *ALL FILES* menu appears). Folders are listed first and individual files are listed next.

Note: The folders and files are sorted in the order they were transferred to the Thomson Lyra Jukebox (the folder you transferred most recently appears last in the list of folders and the file you transferred most recently would be the last on the list since file names follow folder names).

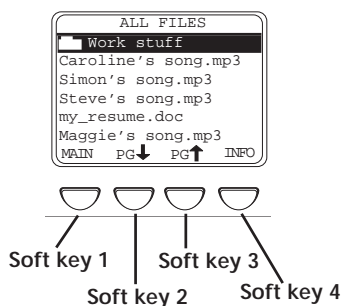

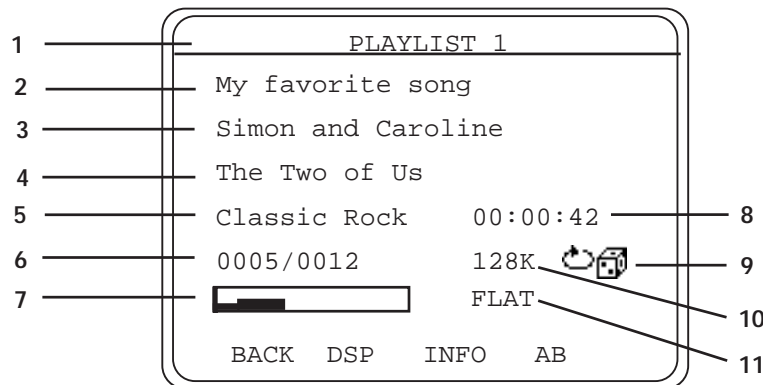

- To see the folders/files stored in a folder, highlight the folder and press *SELECT*.
- To scroll down 5 files/folders at a time, press soft key 2 (*PG down*).
- To scroll up 5 files/folders at a time, press soft key 3 (*PG up*).
- To see information about the file, press soft key 4 (*INFO*).
- To return to the main menu (*SORT BY* menu), press soft key 1 (*MAIN*).

LCD Screen During Playback



This picture illustrates what you'll see on your Thomson Lyra Jukebox LCD screen when you're playing music.

LCD Screen during Playback

- 1 **Playlist name, or path of file**
- 2 **Song title or file name** – Based on ID3 tag information, if it is available. If no ID3 tag information is available, it will be blank.
- 3 **Artist name** – Based on ID3 tag information, if it is available. If no ID3 tag information is available, it will be blank.
- 4 **Album title** – Based on ID3 tag information, if it is available. If no ID3 tag information is available, it will be blank.
- 5 **Genre** – Based on ID3 tag information, if it is available. If no ID3 tag information is available, it will be blank.
- 6 **Current item** – Current track being played/out of total files being played (varies depending on the playback mode setting).
- 7 **Volume level indicator** – There are 50 steps in the volume control. Press the volume up/down buttons to change the volume.
- 8 **Elapsed time of track or pause indicator**– When you're playing music, the amount of time that the track has played appears; when you pause playback, the pause icon appears.
- 9 **Playback mode indicator**  – Displays current playback mode (Normal, Repeat, Shuffle, etc.). The icon that appears in the picture above is the Repeat Shuffle icon .
- 10 **Bit-rate format (Recording Quality Level)** – The setting you chose in the *Recorder* menu (tab) that dictates the bit-rate value that's used when you convert (record) the song using the MusicMatch Jukebox software. Go to page 27 for more information.
- 11 **DSP setting (FLAT)** – The DSP (Digital Signal Processing) setting (Flat, Rock, Bass, etc.). For more information about DSP settings, go to page 36.

Getting Started

Setup Information – the details

Install software in your computer

The Music Management CD that came with your Thomson Lyra Jukebox contains all of the necessary software components you need to make your Thomson Lyra Jukebox work properly. These components do the following:

- enable you to transfer files from your computer to your Thomson Lyra Jukebox
- profile and sort the contents, update the system and help files
- use the MusicMatch Jukebox software to organize your music collection and transfer the music to your Thomson Lyra Jukebox
- install the User's Guide and documentation for the Thomson Lyra Jukebox

The MusicMatch Jukebox™ software compresses audio files (from music CDs) to the MP3 format so you can play them on your Thomson Lyra Jukebox. The MusicMatch software also enables you to download files from the internet that are already compressed and then transfer those files to your Thomson Lyra Jukebox (or play the music on your computer).

1. Turn on your computer and place the Music Management CD that came with your Thomson Lyra Jukebox into your computer.

IMPORTANT: Don't connect the USB cable to the PC or Thomson Lyra Jukebox before or during the driver installation.

If you're running Windows 2000, XP, or Me, no additional drivers are required. If you're running Windows 98SE, you **must** install the device drivers from the CD-ROM in order for the Thomson Lyra Jukebox to function properly.

2. If the setup screen does not appear, double click *My Computer*, double click your CD-ROM drive icon, and double click *Quickstart.exe*. You can also click, *Run*, then type D:\QuickStart.exe (where D is the letter of your CD-ROM drive).

The Thomson Lyra Jukebox and MusicMatch Jukebox quick start program runs.



3. Select the *Install Thomson Lyra Jukebox Applications* option to run the Thomson Lyra Jukebox System Applications setup program.
4. Click Yes to agree to the License Agreement.

Note: This book only discusses the MusicMatch features that directly apply to your Thomson Lyra Jukebox. For additional information about MusicMatch Jukebox features such as MusicMatch radio MX, creating Music CDs, Music Library features, go to:

MusicMatch tutorial on the Music Management CD

Getting Started tips

On-line help (www.musicmatch.com)

Help that's available within the software



5. Click the software components you're going to install (a list follows):
 - **The System Profiler Application** component must be installed in order for the Thomson Lyra Jukebox to function properly. This application allows you to sort and profile the music that you've transferred to your Thomson Lyra Jukebox, and update the system files and the help files that are stored on the Thomson Lyra Jukebox.
 - **Universal Serial Bus Drivers (Windows 98SE only)** must be installed in order for the Thomson Lyra Jukebox to be recognized by your computer's operating system and appear as a drive letter.
 - **User's Guide and Documentation** installs all necessary Thomson Lyra Jukebox documentation and help files.
6. Click *Next* to select the destination location of the installed files.
7. Click *Next* to install all necessary files.
8. Click *Finish* to complete installation and return to the Quickstart program.

Note: *If you're running Windows 98SE, rebooting your computer will be required.*

9. Click *Install MusicMatch Jukebox 6.1 Software* to run the MusicMatch setup program.

Note: *It is recommended to uninstall any previous installations of the MusicMatch Jukebox software before proceeding.*

After the uninstall process has been completed, delete the C:\Program Files\MusicMatch folder from Windows and where C:\Program Files is the path where the software was installed.

10. Click *Next* to dismiss the *Welcome Screen* (the License Agreement appears).
11. After you've read the license agreement, click *Yes* to accept (to continue, you must click *Yes*), or *No* to decline. If you click *Yes*, the *User Registration Information* screen appears.

Getting Started

12. Enter your name, e-mail address, postal code, country, year of birth, and sex (male or female).

Note: You must enter an e-mail address to proceed. If you don't have an e-mail address, enter `yourname@home.com`

13. Click *Next* (the *Personalize Music Recommendation* screen appears). Read the screen to determine if you want to use this feature or not — you can always change the setting later. Select *Yes* or *No*.
14. Click *Next* (the *Installation Options* dialog screen appears). Select *Express Setup* and click *Next* to continue (the installation starts).
15. After the installation is complete, click *Finish*.
16. If necessary, close the main setup screen.
17. Some computers might request that you reboot your computer (a dialog box will appear on the computer screen if this is necessary).

Note: As with any device that has a hard drive, you must back up the drive. Thomson multimedia is not responsible for lost data.

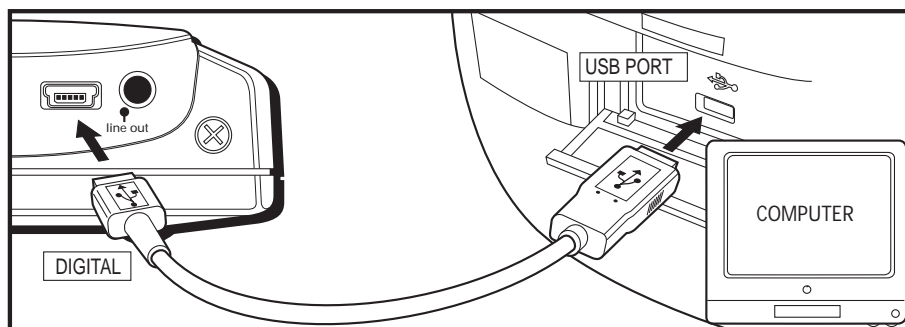

Transfer the files to your Thomson Lyra Jukebox via Windows Explorer (Drag and Drop)

1. Connect the Thomson Lyra Jukebox to your computer with the mini USB cable provided. The Thomson Lyra Jukebox will appear as a Removable Disk drive letter.

Note: It might take several seconds for the device (the Thomson Lyra Jukebox) to be detected, especially in Windows 2000. Click *Refresh* in *My Computer* or *Explorer* to make sure the device has been detected.

2. From *Explorer*, highlight all of the files/folders you want to transfer to your Thomson Lyra Jukebox and drag them to the drive letter that is associated with it.

Getting Started



Profiler application icon found in your computer's system tray.

Tip: Multiple Devices

If more than one Thomson Lyra Jukebox device is connected to the system, a submenu appears listing the drive letters of the Thomson Lyra Jukebox devices. Select the desired drive letter to Profile and Update.

Note: As with any device that has a hard drive, you must back up the drive. Thomson multimedia is not responsible for lost data.

3. Select the *Profile Lyra MP3/Personal Jukebox Device* menu from the Lyra icon (the Lyra Jukebox profiler application icon that's in your PC's system tray, at the bottom right of your computer screen). The Lyra MP3/Personal Jukebox Profiler Application appears.
4. The application will profile and sort all supported audio files so you can sort them and play them properly. Press *Done* to dismiss the application when profiling is finished.
5. Select the *Update Lyra MP3/Personal Jukebox System files* menu item to update all system files and help files.

Caution: Don't unplug the USB cable until all data are transferred to the Thomson Lyra Jukebox.

If you're running Windows 2000, XP, or Me, you must stop the device before unplugging it. Click the  icon (the Unplug or Eject hardware icon) from the system tray and select the USB Mass Storage device for the drive letter associated with the Thomson Lyra Jukebox, and click STOP. See the Windows Help for details about the Unplug or Eject Hardware topic.

Launch the MusicMatch software

The MusicMatch software converts audio files to the MP3 format so you can play them on your Thomson Lyra Jukebox. This section describes some basic MusicMatch features and explains how to convert music to the MP3 format. For more information about MusicMatch, see the tutorial or go to www.musicmatch.com.



The MusicMatch icon found in your computer's system tray.

1. Remove the Music Management CD from your computer.
2. Start the MusicMatch Jukebox software (click on the MusicMatch icon in your system tray or on your desktop).

continued on next page

Getting Started



3. The first time you launch MusicMatch, a *Getting Started* screen appears providing information about MusicMatch and the software.
4. Detailed information, Getting Started tips, and troubleshooting are available through the Help menu and the MusicMatch internet site (accessed from the Help and Site menus). We recommend you familiarize yourself with the MusicMatch Welcome Tips and view the On-line FAQs before using and recording files.

Note: Logging onto the internet while using MusicMatch Jukebox takes advantage of all its features.



5. Choose *Settings* under the *Options* menu to customize the MusicMatch Jukebox functionality.

Note: You can access the Options menu at almost any time by pressing the right mouse button.



Set up the Recorder Settings

Click the *Recorder* tab to display the *Recorder* settings.

Note: Recorder settings are used when you're using the MusicMatch software to convert (record) music files to the compressed format that your Thomson Lyra Jukebox can play.

Note: This book only discusses the MusicMatch features that directly apply to your Thomson Lyra Jukebox. For additional information about MusicMatch Jukebox features, go to www.musicmatch.com



Select the Recording Quality level – *CD Quality MP3 (128Kbps)* is recommended

- MP3 audio is MPEG Layer-3 Audio available at various encoding bit rates. The highest bit rate has the best quality sound, but uses the most disk space.
- WAV audio is unencoded music that is not compressed. This format has the best quality sound but requires the largest file size, as much as 650MB per CD. WAV audio files are much larger than MP3 audio files.
- Windows Media™ audio is a compression format created by Microsoft. This audio format incorporates digital rights management.

Notes:

Custom Quality settings are for advanced users only.

Thomson Lyra Jukebox currently only supports MP3 audio format.



Select a CD Recording Mode

1. Check *Digital and Error Correction* for the best results. Error checking and correction will be performed while you are recording (if your computer doesn't support this setting, you will get a message prompting you to change to *Analog*).

Note: *Choosing Digital and Error Correction will slow down your recording speed.*

2. Check *Analog* if your CD-ROM drive doesn't support digital audio extraction.
3. Select a default *Recording Source*. If you have more than one recording source, select the source you record from the most.
4. *Mute while Recording* (this is not recommended as it will decrease the recording speed). This feature allows you to mute the audio while it is being recorded. Uncheck this box to hear the audio as it is recorded.

Getting Started

Save CD tracks to play on your PC or in your Thomson Lyra Jukebox

1. Insert a CD into your CD-ROM drive. If you are connected to the internet, MusicMatch Jukebox will retrieve information about the CD in the CD-ROM drive.

Note: If you are on a LAN system and the titling feature does not work, contact your administrator.

2. If you're able to connect to the internet, make sure the *Enable CDDB CD* lookup service is selected on the *CDDB Preferences* page. Choose *CDDB Preferences* from *Settings* in the *Options* menu. (The information from the internet appears).





Notes: If the information cannot be retrieved from the Internet, enter it manually. You can enter information or edit existing information by clicking in the desired box and typing the information.

If the information is not entered before recording, default song names and information will be used.



RECORD icon (record button)

REFRESH

3. If the *RECORDER* window (shown above) isn't open, press the  icon (the record button). If the songs aren't listed, press *REFRESH*.
4. Select the tracks you want to record (recording the tracks enables the MusicMatch software to convert the songs to the selected audio format that the Thomson Lyra Jukebox plays).
 - To start recording, click  (record).
 - To stop recording the current track, click  (stop).
 - To cancel the entire recording session for all selected tracks, click  (cancel).
 - To eject the CD, click  (eject).
 - To select all songs, click *ALL*.
 - To deselect all songs, click *NONE*.
 - To refresh the track title information or to attempt detection again, click *REFRESH*.
5. After recording is completed, the songs will be stored in the Music Library.

Getting Started



Download music from the Internet

1. Make sure you're connected to the internet.
2. Click *MUSIC GUIDE* to connect to the MusicMatch download site.

Note: You can also select *Show MusicMatch Guide* from *View* in the *Options* menu to display this window. If you have not established an Internet connection, *MusicMatch Jukebox* will attempt but fail to connect.

Music you download from the *MUSIC GUIDE* window will automatically be placed in the Music Library.

You can download files using your regular browser. Be sure to import (and/or move) them into *MusicMatch Jukebox*.

You can also select *Show MusicMatch Radio* from *View* in the *Options* menu to display this window.

Organizing Your Music

The Music Library now displays your selections. To sort by categories click on the folder icon (sort/view button) in the Music Library window.

Adding Tracks

1. Click *ADD* button from the Music Library window (the *Add Tracks to Music Library* screen appears).
2. Select the folder location on your system that you would like to import music from and select *OK* (all supported music tracks will be imported into the Music Library).

Getting Started

Creating Personalized Playlists

To create a playlist, you can drag and drop files from your Music Library or you can open an existing playlist.

1. To manually add tracks to the playlist, double click on the track or drag and drop the track from the Music Library into the playlist display (the song automatically starts playing if no other song is playing). To preview a track before adding it to the playlist, click to the left of the desired track in the Music Library window.

Note: Click to select a song, Shift and click to select groups of songs, or Ctrl and click to select multiple songs.



2. Click *OPEN* to open an existing playlist, browse for tracks from a specific group, or play an audio CD.
 - To clear an entire playlist from the playlist window, click *CLEAR*.
 - To save your current playlist, click *SAVE*. When the window appears, enter a playlist name and click Save.
 - To remove a single track from the playlist, click on the track to highlight it, and then press *DELETE* on your computer's keyboard.
 - Click *PLAY* to play the songs from the playlist. You can also double click the song in the playlist to begin playing.

Transfer audio files to your Thomson Lyra Jukebox

Once you've created the current playlist that contains all of the songs you want to transfer to your Thomson Lyra Jukebox, follow the steps below:

1. If your Thomson Lyra Jukebox isn't already connected to your computer, use the mini-USB cable that came with your Thomson Lyra Jukebox to connect the Thomson Lyra Jukebox to the computer. Go to page 24 for instructions.

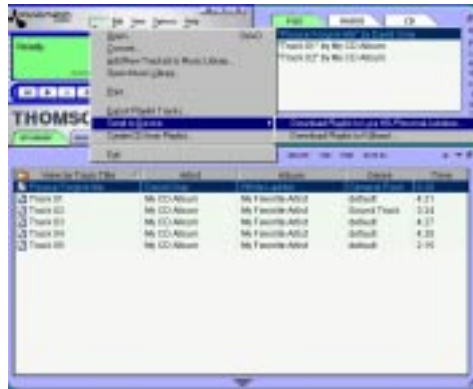

2. From the *File* menu, select the *Send to Device* option, and select *Download to Lyra MP3/Personal Jukebox* item (the Download dialog appears).

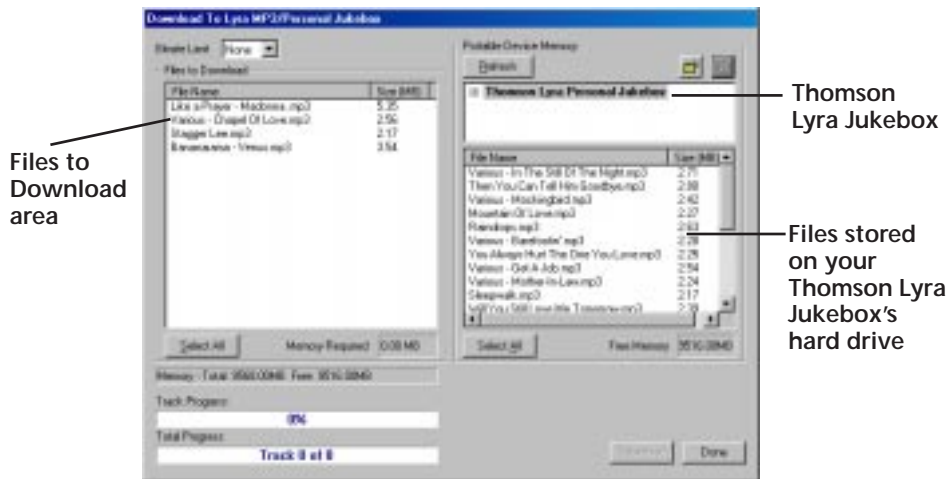

3. Highlight the tracks you want to download (transfer) to your Thomson Lyra Jukebox in the *Files To Download* area.

continued on next page

Getting Started

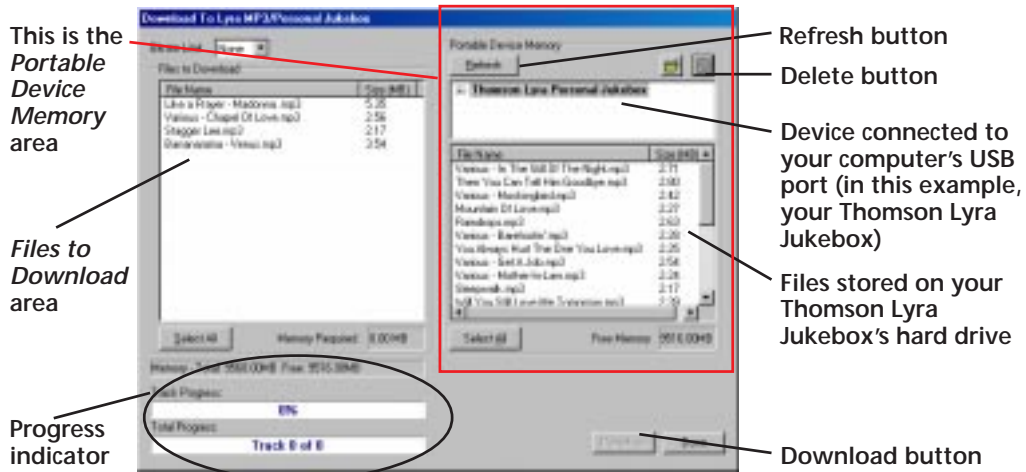

4. After you have selected all of the music you want to transfer to your Thomson Lyra Jukebox, click the *Download* button on the bottom of the screen.

IMPORTANT: If your Thomson Lyra Jukebox doesn't appear in the *Portable Device Memory* area, click the *REFRESH* button.

During transfer a progress indicator appears in the *Download to Lyra MP3/Personal Jukebox* screen (shown above), and *Transfer in progress* appears in the Thomson Lyra Personal Jukebox's LCD.

When the transfer is finished, the Lyra MP3/Personal Jukebox Profiler application automatically runs so it can sort/profile the newly transferred files.

Caution: Make sure all data are transferred to the Thomson Lyra Jukebox before unplugging the USB cable.

If you're running Windows 2000, XP, or Me, you must stop the device before unplugging it. Click the  icon (the *Unplug or Eject hardware* icon) from the system tray and select the USB Mass Storage device for the drive letter associated with the Thomson Lyra Jukebox, and click *STOP*. See the Windows Help for details about the *Unplug or Eject Hardware* topic.

Deleting Files

To delete files from the Thomson Lyra Jukebox:

1. Select the Jukebox device item from the *Portable Device Memory* area.
2. Select the files to be deleted.
3. Press the *DELETE* button on the screen.

Note: For information about the drag and drop method for transferring files, go to page 24.

Features & Menus

Chapter Overview:

- Play modes (Repeat, A-B Repeat, Shuffle, etc.)
- Adjusting DSP settings (flat, rock, jazz, etc.)
- Setting LCD preferences (contrast, backlight, etc)
- Connecting your Thomson Lyra Jukebox to your car stereo
- Connecting your Thomson Lyra Jukebox to your stereo system
- Portable hard drive capability

Features & Menus

Using the Play Modes

Once you have music transferred to your Thomson Lyra Jukebox you can use the MODE button to access different play modes that are used in other audio equipment: Shuffle, Repeat 1, Repeat, Repeat All, Repeat Shuffle.

Note: The REPEAT A-B play mode can only be accessed when you're playing music, go to page 35 for more information.

You can choose a play mode before you start playing a song (via the *MODE SETTINGS* menu appears) or you can cycle through the play modes during playback by pressing the MODE button (the play mode icons appear in the LCD).

No icon in LCD

Normal: Plays the songs in the order they appear (no icon appears in the LCD).



Repeat 1: Plays the current song repeatedly.



Repeat: Plays a series of songs repeatedly, based on option you selected in the *SORT BY* menu (main menu) when you started playback.



Repeat All: Plays all songs repeatedly, based on option you selected in the *SORT BY* menu (main menu) when you started playback.



Shuffle: Plays the songs in random order, based on option you selected in the *SORT BY* menu (main menu) when you started playback.



Repeat Shuffle: Plays selected songs in random order, repeatedly based on option you selected in the *SORT BY* menu (main menu) when you started playback.



Repeat All Shuffle: Continually plays all songs in random order based on option you selected in the *SORT BY* menu (main menu) when you started playback.

How to access the play modes

During navigation mode (you've turned on your Thomson Lyra Jukebox, but you are using the menu system and not playing music)

1. Press the MODE button (the *MODE SETTINGS* menu appears).
2. Press the arrow down button (or soft key 2) or the arrow up button (soft key 3) until the play mode you want to use is highlighted.
3. Press *BACK* (soft key 1) to return to the previous screen and the mode selection will be updated to reflect the choice you made in step 2.
4. To change the current play mode, just press the MODE button during playback.

During playback



1. Press the MODE button to cycle through the choices (the play mode icons are updated on the LCD).

Note: No icon appears in the LCD for the Normal playback mode.

Repeat A-B

Repeat A-B enables you to mark a starting point and an ending point during playback — the Repeat A-B playback mode will only play the segment that you marked. When the end of the segment (the B point) is reached during playback, the Thomson Lyra will start playback again from the beginning (the A point).

Note: Unlike other playback modes, Repeat A-B is only available during playback (you can't access it from the *MODE SETTINGS* menu).

1. To set up Repeat A-B, start playback – press  (play/pause).
2. When the song you're playing reaches the place that you want to be the starting point, press A -B (soft key 4). You'll notice that the  icon appears in the LCD where the other mode icons are displayed.
3. Continue to let the music play. When you reach the end of the segment you want to repeat, press A-B again (soft key 4). The  icon appears in the LCD.

Note: You can only mark A and B points within the same song or track.

4. The Thomson Lyra Jukebox will repeatedly play the segment of music you marked. To cancel A-B repeat and return to normal playback, just press the MODE button.

Features & Menus

Adjusting DSP Settings

DSP Settings (Digital Signal Processor settings) adjust the the various levels of the audio output for different types of songs. For example, the DSP setting for BASS makes the bass sounds more prominent. You can also personalize the levels via the *GRAPHIC EQ* menu item. The default DSP setting for your Thomson Lyra Jukebox is *FLAT*.

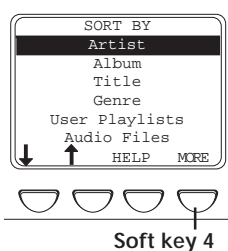

1. From the main menu, press *MORE* (soft key 4).

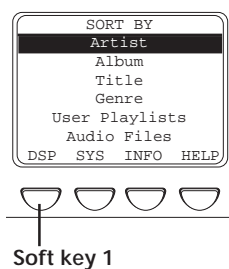

2. Select *DSP* (press soft key 1). The *DSP SETTINGS* menu appears.

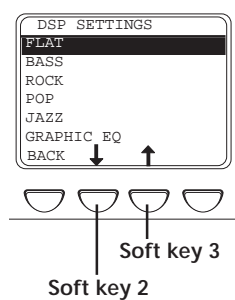

3. Press the arrow down (or soft key 2) or arrow up (soft key 3) to highlight the DSP setting you want to use.
 - FLAT
 - BASS
 - ROCK
 - POP
 - JAZZ
 - GRAPHIC EQ: enables you to personalize audio output settings. Go to the next section for instructions.

Note: When the Thomson Lyra Jukebox is playing, you can cycle through the DSP settings by pressing DSP (soft key 2). The new DSP setting will take effect immediately and the DSP display text will be updated.

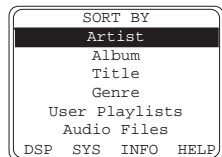

Soft key 1

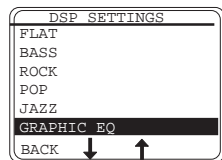

Soft key 2

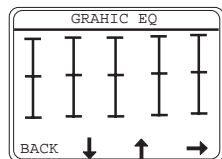

Soft key 1

Soft key 3

Soft key 2

Soft key 4

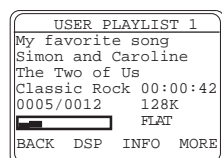

Personalizing DSP Output (GRAPHIC EQ menu item)

1. During navigation, press soft key 1 (DSP).
2. Press soft key 2 (arrow down) until *GRAPHIC EQ* is highlighted (the *GRAPHIC EQ* submenu appears automatically after *GRAPHIC EQ* has been highlighted for a second or two).
3. Press soft key 2 (down arrow) to decrease the level for the first equalizer band. Press soft key 3 (up arrow) to increase the level of the first equalizer band.
4. When you have the level for this first equalizer band where you want it, press soft key 4 (right arrow) to go to the next equalizer band.
5. Repeat steps 3 and 4 until you have all of the equalizer bands where you want them.
6. Press *BACK* (soft key 1) when all EQ settings are set, or let the display timeout and return to navigation.

Note: When you're playing music, you can access GRAPHIC EQ by pressing soft key 2 (DSP) until the EQ selection appears. After a few seconds, the GRAPHIC EQ submenu automatically appears.

Features & Menus

Setting LCD Preferences (SYSTEM SETTINGS menu)

You can personalize the setting of your LCD (Liquid Crystal Display).

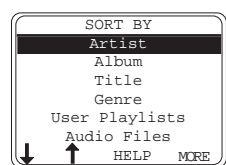

Soft key 4

1. From the *SORT BY* menu (the main menu), press soft key 4 (*MORE*). Four new menu items appear at the bottom of the LCD screen.

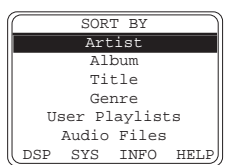

Soft key 2

3. Highlight *SYS* (press soft key 2). The *SYSTEM SETTINGS* menu appears.

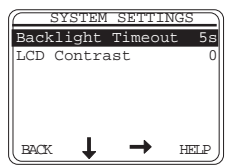

Soft key 2

4. Highlight the setting you want to adjust (to highlight *LCD Contrast* press soft key 2 – the down arrow). Instructions for adjusting *LCD Contrast* and *Backlight Timeout* follow:

Features & Menus

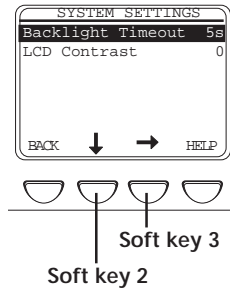

- **Backlight Timeout:** you can adjust the amount of time that the backlight stays on by highlighting *Backlight Timeout*. Press ► (the right arrow button on your Thomson Lyra Jukebox) to increase the amount of time. Press ◀ (the left arrow button) to decrease the amount of time.

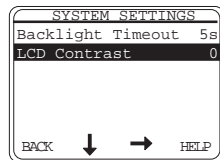

- **LCD Contrast:** to increase the contrast (make the letters darker and the background lighter), press ► (the right arrow button). To decrease the contrast, press ◀ the left arrow button.

Features & Menus

Playing Your Thomson Lyra Jukebox in your car stereo

The cassette adapter lets you listen to the Thomson Lyra Jukebox in an automobile or RV safely without having to wear headphones.

The car kit is included with your Thomson Lyra Jukebox. This accessory kit includes a car cord adapter (#54095) and a cassette adapter (#54097). The car cord adapter lets you power your Thomson Lyra from the cigarette lighter socket of a car, truck, or RV. It converts 12-volts to a 4.5-volt output.

1. Insert the plug on the cassette adapter into the headphone jack on the player. If the headphones are attached, remove them.
2. Set your cassette player to your normal listening level.
3. Insert the cassette (Side A up) into your cassette player making sure the cord is placed in the correct position for your type of player.
4. Attach the end of the car cord adapter to the DC IN jack on your Thomson Lyra Jukebox (the POWER light comes on).
5. Remove the cigarette lighter from the socket, and insert the car cord into the socket.
6. Turn on your Thomson Lyra Jukebox, and operate the Thomson Lyra Jukebox to play music as described in Chapter 1.
7. Control the volume with the cassette player.
8. When you're finished,
 - A. Remove the cassette adapter from the cassette player.
 - B. Turn off the Thomson Lyra Jukebox.
 - C. Remove the car cord's plug from the cigarette lighter socket.

Cautions: Make sure to place the wire securely into the slot on the cassette in the correct direction for the type of player you have. The car cord adapter is designed to be used only with vehicles having negative ground electrical systems. Use of any other car cord adapter may damage your Thomson Lyra Jukebox and void your warranty.

Playing Your Thomson Lyra Jukebox on your stereo system

Your Thomson Lyra Jukebox came with a Line Out Cable that you can use to connect your Thomson Lyra Jukebox to your audio system.

1. Make sure your Thomson Lyra Jukebox is off.
2. Connect the black end of the cable to the LINE OUT jack on your Thomson Lyra Jukebox player.
3. Connect the red (audio left) and white (audio right) cables to the corresponding left and right audio jacks on your stereo system.
4. Turn on the power to your audio system, and select the proper input setting on the audio system that corresponds with the way you've connected the Thomson Lyra Jukebox to the audio system.
5. Turn on your Thomson Lyra Jukebox – press and hold  for 2 seconds.
6. Operate the Thomson Lyra Jukebox to play music as described in Chapter 1.

Features & Menus

Portable Hard Drive Capability

Thus far, this User's Guide has discussed your PDP 2800 Thomson Lyra Jukebox player's music functions. However, this is the first Thomson Lyra model that has a hard drive (other models required a compact flash card). Since it has a 10-gigabyte hard drive, you can use it to transport files — any files, not just music files. Some possible uses for this feature follow:

- Create back-ups/archive files
- Connect to other computers — at work, for example.
- Transport digital photo albums.
- Transport files from one computer to another computer. For example, instead of putting files at work on a zip or accessing them on your home computer via e-mail or remote access, you can put the files on your Thomson Lyra Jukebox.
- Capture internet downloads.
- Share information.

Connecting your Thomson Lyra Jukebox to your Computer

You connect the Thomson Lyra Jukebox to your computer via the USB mini-cable (provided).

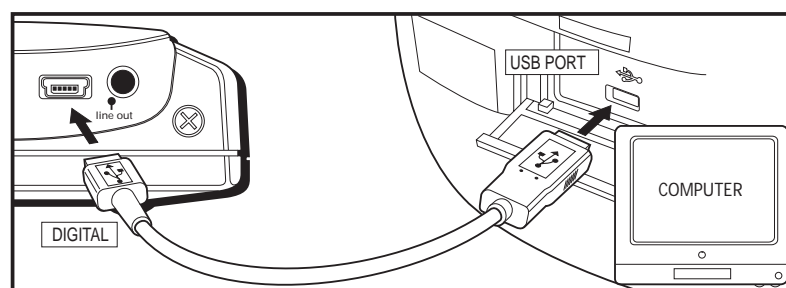

1. Connect the Thomson Lyra Jukebox to your computer with the mini USB cable provided. The Thomson Lyra Jukebox will appear as a Removable Disk drive letter.

Note: It might take several seconds for the device (the Thomson Lyra Jukebox) to be detected, especially in Windows 2000. Click Refresh in My Computer or Explorer to make sure the device has been detected.

2. From Windows Explorer, highlight all of the files/folders you want to transfer to your Thomson Lyra Jukebox and drag them to the drive letter that is associated with it
3. Go to page 31 for more information about transferring files.

Chapter 3

Additional Information

Chapter Overview:

- Tips & Troubleshooting
- FAQ (Frequently Asked Questions)
- Specifications & System Requirements
- Index

Additional Information

Tips and Troubleshooting

Problem: Player repeats same tracks or all tracks.

- Repeat play is turned on. Press the MODE button to change the play mode.

Problem: Audio distorted at high volume.

- In DSP mode, reduce the *BASS* gain.
- Select another DSP setting.
- Turn down the volume.

Problem: The audio tracks on my Thomson Lyra keep skipping or popping.

- You'll need to re-record the audio track – make sure you close all other applications on your PC when you record.

Problem: Player turns itself off.

- Your Thomson Lyra Jukebox turns itself off if you leave it in pause mode for an inordinate amount of time.

Problem: Songs aren't listed in any of the sort modes (Album, Genre, Title, Audio Files).

- The contents of the Thomson Lyra Jukebox haven't been profiled (sorted) since the last file transfer. Select the *Profile Lyra MP3/Personal Jukebox Device* menu item from the Thomson Lyra Jukebox profiler system tray application on your PC to profile (sort) the contents of the device. The icon in the system tray looks like this .

Problem: Bad or missing file error message displayed on the Thomson Lyra Jukebox.

- The Thomson Lyra Jukebox system files are corrupted or missing. Select the *Update Thomson Lyra Jukebox System Files* menu item from the Thomson Lyra Jukebox profiler system tray application on your PC to update the necessary system files.

Problem: Lyra Jukebox Profiler application icon –  – doesn't appear in the system tray.

- You can restart Windows to auto-launch the application, or you can double-click or run the Thomson Lyra Jukebox Profiler executable file that's in the Profiler sub-folder of the installation directory that was specified during the setup process – (Example Directory: C:\Program Files\Thomson multimedia\Thomson Lyra Personal Jukebox\Profiler\LYRAHDDProfilerTrayApp.exe)

If the problem persists, you might need to reinstall the Thomson Lyra Jukebox software.

FAQ (Frequently Asked Questions)

Question: What is MP3?

MP3 is an abbreviation for MPEG-1, Layer 3 Audio (MPEG = Motion Picture Experts Group). This is a digital sound encoding and compression process that was developed by the Fraunhofer Institut für Integrierte Schaltungen and Thomson multimedia. MP3 is an international standard and is well suited for the transfer of high quality audio files over telephone or ISDN lines, and over the internet.

Specifications & System Requirements

Hardware

- Dimensions: 2.79cm D, 12.95cm W, 7.62cm H
- Unit Weight: 311.85 gr
- 10 Giga Byte Storage
- Stereo Headphone Jack
- Adaptive Navigation Softkeys
- Mini USB Connection Jack
- Stereo Line Out Jack
- External 5V DC Jack
- Battery Operated: Up to 12 hours of playback with internal rechargeable Lithium ion battery.

Additional Information

Hard Disc

- External Hard Disc Drive: When connected to a computer via USB, the Thomson Lyra Hard Disc player is capable of storing any file type allowing the user a fast, convenient method of storing, retrieving, and transferring files. Including word processing files, presentations, spreadsheets and any other computer files.
- Capacity: 10GB
- Rotational Speed: 4200 RPM
- Average Access Time: 12 MS
- Connection: USB 1.1

Software

- Includes Music Management software with the Thomson Lyra Jukebox applications and the MusicMatch Jukebox software.

MusicMatch Jukebox software lets the user organize all tracks in a digital music library, create custom playlists through drag and drop interface.

- Encodes MP3 files.
- Auto DJ creates automatic Playlists based on the user's sorting preferences. Scans the entire Music Library for specific search results.
- Integrated CD Player.
- Export to WAV
- MP3 Equalizer

Additional Information

PC Hardware Requirements

- 233MHz or higher (Pentium II 300 MHz or higher recommended)
- Windows® 98SE, Me, XP or 2000
- Internet Explorer 4.0 or better with Internet access
- 32 MB RAM (64 MB recommended)
- Free hard disk space (4 MB for the software plus 1 MB for every minute of CD quality audio that will be stored on the PC).
- CD-ROM drive capable of digital audio extraction
- USB port
- Installed sound card
- 16-bit color video card

Accessories

- CD-ROM Music Management Software
- USB Connection Cable
- AC/DC Adapter
- X-Phone™ Stereo Headphones
- Audio Line-Out Cable
- Car DC Adapter: Supplies power to Thomson Lyra Jukebox player from car battery via cigarette lighter plug.
- Car Cassette Audio Output Adapter

Miscellaneous Specifications

- Signal to Noise Ratio (>85dB)
- THD (<0.1%)

¹ MusicMatch and MusicMatch Jukebox are registered trademarks of MusicMatch Corp.

² Warning – This product is not intended for the unauthorized recording or duplication of copyrighted material.

Additional Information

Thomson Lyra Helpline

More help is available on www.thomson-lyra.com and phone numbers of the Thomson Lyra helpline per countries are listed below.

 **HELPLINE THOMSON**

Votre Contact THOMSON: 0 810 810 891, de le 16.10.2000
(pour la France, prix d'un appel local)

Ihr Kontakt zu THOMSON: 0180 1000 390, ab 16.10.2000.
(für Deutschland, Kosten zum Ortstarif)

You can contact THOMSON by dialling: 0845 601 3093, from 16 October 2000
(For Great Britain, all calls will be charged at local rate)

Para contactar con THOMSON marque: 901 900 410, a partir del 16.10.2000
(las llamadas serán cargadas al precio de la tarifa local)

Il vostro contatto THOMSON: 8488 10 168, dal 16.10.2000
(tariffa chiamata urbana)

www.thomson-europe.com

Wyrób importowany
Przez Thomson Consumer
Electronics Poland

Index

A

A-B Repeat 35
AC/DC adapter charger 6
Adapter
AC/DC 6
car 6, 40
ADD button 29
Album menu 14
All Files menu 20
Analog setting 27
Arrow button 8
Arrow buttons
left 11
right 11
Artist menu 13
Assistance 4, 26, 34, 44, 48
Audio Files menu 19
Audio problems 44

B

Backlight Timeout, changing 39
Backup data 4
Bad file message 44
Basic operation 10
Bass 36
Battery, charging 12
Box, what's in the 6
Buttons
down arrow 8
explanation 7
left arrow 8, 11
MODE 7, 11
play/pause 8
RESET 9
right arrow 8, 11
SAVE 7
SELECT 7
Soft 8
STOP 11
STOP/power 8

up arrow 8
volume down 7, 11
volume up 7, 11

C

Cables
line out 6, 9
USB 6
Car
adapter 6, 40
play the Thomson Lyra in 40
Case 6
CD 6, 22
contents 23
CD quality setting 27
CD recording mode 27
CDDB Preferences 28
Changing play modes 35
Changing the order of songs 19
CHARGE light 9
Charger 6
Computer requirements 4
Connecting
car adapter 40
to stereo system 41
to your computer 24
Creating a playlist 30
Customer service 48

D

Data 4
DC IN jack 9
Digital and Error Correction setting 27
Display 7
Down arrow button 8
Download music from the internet 29
Drivers 22, 23
DSP Output 37
DSP Settings menu 36

Additional Information

E

Eject hardware icon 12
Error messages 44

F

Flat 36

G

Genre menu 16
Graphic EQ 36
GRAPHIC EQ menu 37

H

Headphones 4, 6
Headphones jack 9
Help 26, 48

I

Icon
 MusicMatch 25
Icons
 eject hardware 12
 key 9
 lock 9
 play mode 34
 playback 21
 Thomson Lyra Jukebox profiler
 application 25
 unplug 12
ID3 tags 15
Important information 2
Installing software 22
Instruction book 23
Instructions
 setup 22
 step-by-step 12
Internet 29

J

Jack
 DC IN 9
 Headphones 9
 LINE OUT 9
Jazz 36

K

Key icon 9

L

L.E.D.
 CHARGE 9
 POWER 9
LAN system 28
LCD 7
 adjusting contrast 39
 Backlight Timeout: 39
 changing appearance 38
LCD Contrast 39
LCD Screen 21
Left arrow button 8, 11
Light
 CHARGE 9
 POWER 9
Line Out cable 6
Line out cable 41
LINE OUT jack 9
LOCK switch 9
Logo, RCA 12
Loss of data 4
Lyra Jukebox profiler application icon 25

M

Menus

Additional Information

- Album 14
 - All Files 20
 - Artist 13
 - Audio Files 19
 - DSP Settings 36
 - Genre 16
 - Graphic EQ 37
 - Profile Thomson Lyra MP3/Personal Jukebox Device 25
 - Sort By 10
 - System Settings 38
 - Title 15
 - Update Thomson Lyra MP3/Personal Jukebox System 25
 - User Playlists 18
 - Mini USB cable 6, 24
 - Missing file message 44
 - MODE button 7, 11
 - MP3 27
 - Music Guide 29
 - Music Library 29
 - Music Management CD 6
 - MusicMatch icon 25
 - MusicMatch Radio 29
 - Mute while Recording setting 27
- O**
- OFF/LOCK switch 9
 - Operation, playback 11
 - Options menu 26
- P**
- Parts checklist 6, 44, 45
 - PC Requirements 4
 - Play modes 34
 - Play/pause button 8
 - Playback operation 11
 - Playback problems 44
 - Playing music 11
 - Playlists 18, 30
 - Pop 36
 - POWER light 9
 - Power adapter 9
 - Power button 8
 - Problems, solving 44
 - Product registration 2
 - Profile Thomson Lyra MP3/Personal Jukebox Device menu 25
- R**
- Rearranging the order of the songs 19
 - Recorder settings 26
 - Recording quality level 27
 - Repeat A-B 35
 - Requirements
 - computer 4, 47
 - RESET button 9
 - Right arrow button 8, 11
 - Rock 36
- S**
- SAVE button 7
 - SELECT button 7
 - Settings menu 26
 - Setup instructions 22
 - Soft keys 8
 - Software 22
 - SORT BY menu 10
 - Sorting
 - by Album 14
 - by All Files 20
 - by Artist 13
 - by Audio Files 19
 - by Genre 16

Additional Information

- by Title 15
- by User Playlists 18
- Sorting problems 44
- Specifications
 - accessories 47
 - hard disc 46
 - hardware 45
 - software 46
- Step-by-step instructions 12
- STOP button 8, 11
- Storage space 20
- Stuff packed with the player 6
- System Profiler Application 23
- System Settings menu 38
- System tray 25

T

- Thomson helpline 48
- Thomson Lyra logo 12
- Title menu 15
- Troubleshooting 44

U

- Unplug icon 12
- Up arrow button 8
- Update Lyra MP3/Personal Jukebox
 - System menu 25
- USB 23
- USB cable 6, 24
- USB port 9
- User Playlists 30
- User Playlists menu 18
- User's Guide 23

V

- Volume down button 7, 11
- Volume level indicator 27
- Volume up button 7, 11

W

- WAV audio 27
- Windows Media 27

visit us at www.thomson-europe.com or www.thomson-lyra.com

Please do not send any products to the address listed in this manual or on the carton. This will only add delays in service for your product.

Thomson multimedia
46/47 quai A.Le Gallo
92648 Boulogne Cedex
FRANCE
RCS nanterre
B322 019 464
www.thomson-multimedia.com

