

SANYO

INSTRUCTION MANUAL

M-1060C
M-1110C

Compact Cassette Recorder

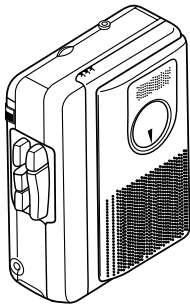

M-1060C

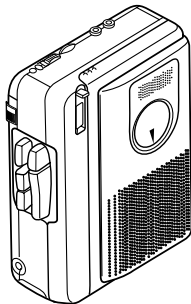

M-1110C

SANYO'S HELP-LINE

Call the toll-free number below if you have any difficulties operating this product.

1-877-999-1840 (Weekdays: 8:00 AM - 5:00 PM, Pacific Time)

CONTROLS (Fig. 1)

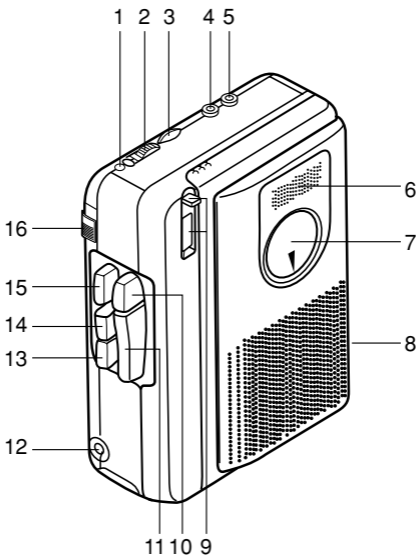

Fig. 1

1. Battery/Operation indicator (BATT/OPR) (M-1110C only)
2. Voice activated system switch (VAS) (M-1110C only)
3. Volume control (VOLUME)
4. Microphone jack (MIC) (M-1110C only)
5. Earphone jack (EAR)
6. Built-in microphone

7. Cassette compartment
8. Battery compartment (back panel)
9. Tape counter and reset button (M-1110C only)
10. Record button (REC)
11. Play button (PLAY)
12. External DC 3V jack (EXT DC 3V)
13. Fast forward/Cue button (FFWD/CUE)
14. Rewind/Review button (REW/REV)
15. Stop button (STOP)
16. Pause switch (PAUSE)

POWER

AC adaptor

Connect the included AC adaptor (Part No. 645 016 1018) to the EXT DC 3V jack (Fig. 2). (The batteries are automatically disconnected.)

- The centre pin of the EXT DC 3V jack is positive (+).

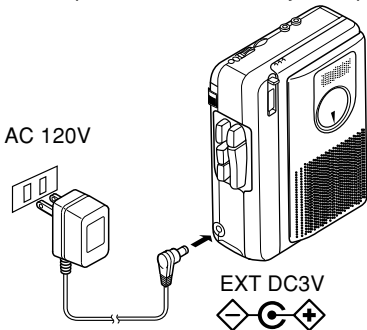

Fig. 2

Battery

Install two "AA" batteries (not supplied) as shown in Fig. 3. Observe proper polarity.

- If you are not going to use the unit with batteries for one month or more, remove the batteries.

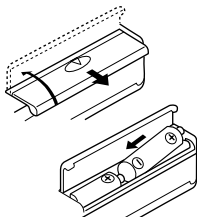

Fig. 3

Battery replacement

When the BATT/OPR indicator (M-1110C only) does not light during operation or is lit dimly, replace the batteries.

- When replacing the batteries, use two new batteries of the same type. Do not mix a used battery with a new one or mix different types of batteries.

IMPORTANT NOTE:

SPENT OR DISCHARGED BATTERIES MUST BE RECYCLED OR DISPOSED OF PROPERLY IN COMPLIANCE WITH ALL APPLICABLE LAWS. FOR DETAILED INFORMATION, CONTACT YOUR LOCAL COUNTY SOLID WASTE AUTHORITY.

Rechargeable battery

Install the rechargeable battery (SANYO NBP-30B, not supplied) as shown in Fig. 4. Connect the AC adaptor. The battery fully charged approximately 8 hours after the AC adaptor is connected.

- Do not charged continuously for 24 hours or more.

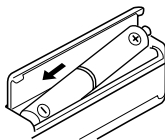

Fig. 4



Ni-Cd



IMPORTANT NOTE:
SPENT NICKEL-CADMIUM RECHARGEABLE BATTERY MUST BE RECYCLED OR DISPOSED OF PROPERLY IN COMPLIANCE WITH ALL APPLICABLE LAWS. FOR DETAILED BATTERY RECYCLING INFORMATION, CONTACT THE RECHARGEABLE BATTERY RECYCLING CORPORATION AT 1-800-822-8837.

CONNECTIONS

External microphone (M-1110C only)

Connect an external microphone (not supplied) to the MIC jack. (The built-in microphone is automatically disconnected.)

Earphone

Connect an earphone (not supplied) to the EAR jack for private listening. (The speaker is automatically disconnected.)

RECORDING (Fig. 5)

NOTE: Do not use C-120 or endless cassettes.

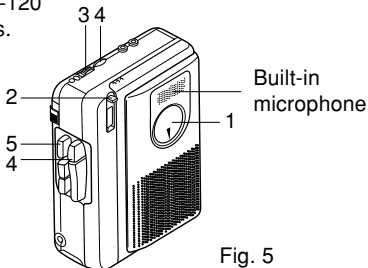

Fig. 5

1. Load a cassette as shown in Fig. 6.
2. Press the reset button to set the counter to "000". The counter shows relative tape position. (M-1110C only)
3. Set the VAS switch to ON or OFF. (M-1110C only)
4. Press the REC button. (The PLAY button is engaged simultaneously.)

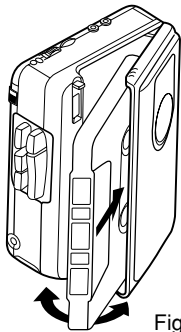

Fig. 6

VAS ON: Voice activated recording (M-1110C only)

When you talk, the unit will start recording. When you stop talking for as long as 4 to 8 seconds, the unit will stop recording (variations in voice level do not stop recording).

Use the VOLUME control to adjust the microphone sensitivity to your voice. If voices are not activating recording, increase the volume. If recording does not stop when talking stops, decrease volume.

NOTE: If the first few words you speak activate recording but are not recorded, say an extra word to start recording before you dictate. (For important recordings, set the VAS switch to OFF.)

VAS OFF: Standard recording (M-1110C only)

Recording will continue until the STOP button is pressed.

5. Press the STOP button to stop recording.

Fast forwarding or rewinding

In the stop mode, press the FFWD/CUE or REW/REV button. Press the STOP button when the desired point or end of the tape is reached.

Temporarily stopping operation (all modes)

Slide the PAUSE switch right. Slide it left to resume operation.

Quick reviewing and recording

While recording, press and hold the REW/REV button (the REC button is released) until the tape has rewound to the desired point. Release the REW/REV button to play back your recording. Press the REC button to resume recording.

Safeguards against accidental erasure (Fig. 7)

To protect side A, break out tab (1). To protect side B, break out tab (2).

- To erase or record a protected cassette, cover the tab openings with adhesive tape (3).

NOTE: The REC button cannot be depressed when using a protected cassette.

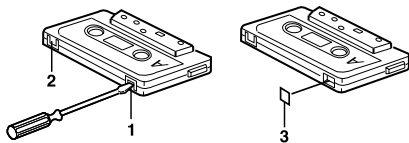

Fig. 7

PLAYBACK (Fig. 8)

1. Load the cassette as shown in Fig. 6.
2. Press the PLAY button and adjust the VOLUME control.
3. Press the STOP button to stop playback.

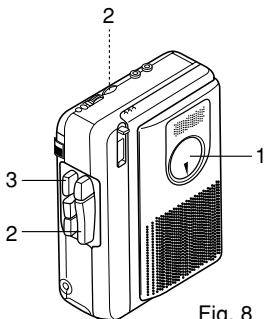

Fig. 8

Cue and reviewing

While playback, press and hold the FFWD/CUE or REW/REV button. Release the button when the desired point is reached. Playback continues.

MAINTENANCE

To ensure continued high performance, use cotton swab (1) moistened with head cleaner to clean the heads (4, 5), pinch roller (3) and capstan (2) after about every 10 hours of use (Fig. 9).

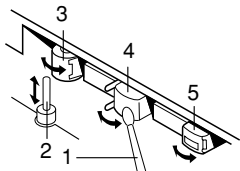

Fig. 9

**SANYO SERVICE PLUS LIMITED
WARRANTY
DICTATION PRODUCTS ONLY**

OBLIGATIONS

In order to obtain factory warranty service for Sanyo Dictation Products, call the toll-free number below. The unit must be packed in the original carton or a well-padded sturdy carton in order to avoid shipping damage.

Note: Do not return this unit to the retail store for service.

To obtain Service Plus Warranty service, product operation information or for problem resolution, call

Toll Free 1-877-999-1840

Weekdays 8:00 AM - 5:00 PM Pacific Time

THIS WARRANTY IS VALID ONLY ON SANYO DICTATION PRODUCTS PURCHASED AND USED IN THE UNITED STATES OF AMERICA, EXCLUDING ALL U.S. TERRITORIES AND PROTECTORATES. THIS WARRANTY APPLIES ONLY TO THE ORIGINAL RETAIL USER, AND DOES NOT APPLY TO PRODUCTS USED FOR ANY INDUSTRIAL, PROFESSIONAL, OR COMMERCIAL PURPOSE. THE ORIGINAL DATED BILL OF SALE OR SALES SLIP MUST BE SUBMITTED AT THE TIME WARRANTY SERVICE IS REQUESTED.

Subject to the OBLIGATIONS above and EXCLUSIONS below, SANYO FISHER COMPANY (SFC) warrants this SANYO Dictation product against defects in materials and workmanship for the periods of LABOR and PARTS specified below. SFC will, at its option, within two business days after its receipt of any dictation product that fails to conform to this warranty at SFC's designated facility, either (a) repair such product or any of its parts which fail to conform to this warranty or (b) ship a replacement product. The warranty period commences on the date the product was first purchased at retail.

LABOR	PARTS
1 YEAR	1 YEAR

EXCLUSIONS

This warranty does not cover (A) the adjustment of customer-operated controls as explained in the appropriate model's instruction manual, or (B) the repair of any product, whose serial number has been altered, defaced or removed. This warranty shall not apply to the cabinet or cosmetic parts, antenna, knobs, batteries or routine maintenance.

This warranty does not apply to repairs or replacements necessitated by any cause beyond the control of SFC including, but not limited to, any malfunction, defect, or failure caused by or resulting from unauthorized service or parts, improper maintenance, operation contrary to furnished instructions, shipping or transit accidents, modification or repair by the user, abuse, misuse, neglect, accident, incorrect line voltage, fire, flood, or other Acts of God, or normal wear and tear.

The foregoing is in lieu of all other expressed warranties and SFC does not assume or authorize any party to assume for it any other obligation or liability.

THE DURATION OF ANY WARRANTIES WHICH MAY BE IMPLIED BY LAW (INCLUDING THE WARRANTIES OF MERCHANTABILITY AND FITNESS) IS LIMITED TO THE TERM OF THIS WARRANTY. IN NO EVENT SHALL SFC BE LIABLE FOR SPECIAL, INCIDENTAL OR CONSEQUENTIAL DAMAGES ARISING FROM OWNERSHIP OR USE OF THIS PRODUCT, OR FOR ANY DELAY IN THE PERFORMANCE OF ITS OBLIGATIONS UNDER THIS WARRANTY DUE TO CAUSES BEYOND ITS CONTROL. SOME STATES DO NOT ALLOW LIMITATIONS ON HOW LONG AN IMPLIED WARRANTY LASTS AND/OR DO NOT ALLOW THE EXCLUSION OR LIMITATION OF CONSEQUENTIAL DAMAGES, SO THE ABOVE LIMITATIONS AND EXCLUSIONS MAY NOT APPLY TO YOU. THIS WARRANTY GIVES YOU SPECIFIC LEGAL RIGHTS. YOU MAY HAVE OTHER RIGHTS, WHICH VARY FROM STATE TO STATE. S/D R2

For your protection in the event of theft or loss of this product, please fill in the information below for your own personal records.

Model No. _____ Serial No. _____

(Located on back or bottom side of unit)

Date of Purchase _____ Purchase Price _____

Where Purchased _____

SANYO

**21605 Plummer Street
Chatsworth, CA 91311**