

Portable MP3/WMA/SMV Player User Guide

SANYO DMC 1180/2020 series

[Introduction](#)

[Installing the MP3 Player](#)

[Transferring data to and from the MP3 Player](#)

[Listening to your WMA/MP3 music](#)

[Player Controls](#)

[LCD Display](#)

[Video](#)

[Voice Recorder](#)

[FM Tuner](#)

[Navigation](#)

[Advanced Settings](#)

[Removing the MP3 Player from your computer](#)

[Troubleshooting](#)

[Specifications](#)

[Safety](#)

[Warranty](#)

Introduction

Thank-you for choosing the Sanyo DMC-1180/2020 MP3 player. Please take a moment to read this instruction booklet so you will become familiar with the many features of this unit. This device incorporates a portable **WMA/MP3/SMV** Player, FM Radio, Voice Recorder and 1 GB (DMC1180 series) or 2GB (DMC2020 series) Mass Storage Device.

MP3 Player Features:

- WMA/MP3/SMV player
- Synchronous lyric display with WMA/MP3 music
- Voice recorder

- FM Radio with 20 presets
- FM Recording
- 1GB or 2GB mass storage device
- Integrated USB connector
- Backlit display
- Superb audio quality

System support:

- Supports Windows Me/2000/XP.

*Note for Windows 2000 users: **Windows Service Pack 3** must be installed before installing MP3 Player drivers.*

- Supports Windows 98 SE after installation of drivers (see below).
- Supports Mac OS X (version 10.2.6 or above) without driver.

Note:

- *To minimize damage from static electricity, avoid operating the player in an extremely dry household environment. The product may malfunction and require the user to reset the product.*

Battery management

Battery: Built-in 530mAh Rechargeable Lithium ion battery

Charge: Connect the MP3 Player to the computer. Press and hold "Power on/off " button for few seconds until a battery icon appears on the top of the MP3 Player's screen. The battery is charging.

Note: Please recharge the battery when the screen displays **Low Battery**. For longest battery life, it is best to let the battery discharge until the **Low Battery** icon appears, before recharging.

After many cycles of charging and discharging, the battery will need to be replaced. Please contact our Help line at **1-800-263-2244**. DO NOT ATTEMPT TO CHANGE THE BATTERY YOURSELF.



Installing the MP3 Player

Installation of drivers for computers using **Windows Me/2000/XP** is not necessary.

*Note for Windows 2000 users: **Windows Service Pack 3** must be installed before installing MP3 Player drivers.*

Windows 98 SE users will need to install the MP3 Player on their system:

1. Click on the link below to open the folder containing the MP3 Player installation program.
2. Click on the **Setup**  icon to begin the installation.
3. Follow the on-screen instructions to complete the installation.

[Click here to install the MP3 Player driver](#)

Transfer data to and from the MP3 Player.

1. Make sure that the MP3 Player is turned off.
2. Remove the USB port cover of the player. Disconnect the earphone.
3. Plug the MP3 Player into the USB port of your computer. The built-in LCD displays "USB Connected", indicating that the player is in USB mode. The player is then automatically recognized (in 'My Computer') as removable media devices .
4. Transfer files to or from the internal Flash RAM using Windows explorer.
5. Unplug the MP3 Player from your computer ([click here to see how to do this safely](#)); **WMA/MP3** files can now be listened to and all data stored can be transferred to another computer.



Note: Other types of data such as Word, Excel, PowerPoint, JPEG, etc. can be stored and transferred.

Listen to WMA/MP3 music files with the MP3 Player

1. Follow the instructions for the transfer of data to and from the MP3 Player to copy WMA/MP3/SMV music files to the MP3 Player.
2. Connect the supplied headphones to the headphone socket.
3. Press the Play button.
4. Use the MP3 Player [controls](#) to adjust playback and volume level to listen to your WMA/MP3/SMV music.

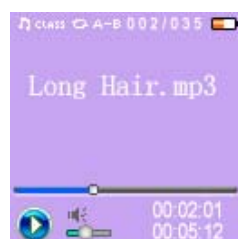

Lyric display function

The MP3 Player supports lyric files in LRC format.

1. Prepare an MP3, WMA or SMV music file; for example, happymusic.mp3;
2. Download a lyric file from the internet. The lyric file must have the extension file name LRC; for example, happymusic-2004.lrc.
3. Rename the lyric file; for example, happymusic.lrc. This is to ensure that the lyric filename is the same as the corresponding music filename.
4. Copy the lyric file & music file to the MP3 player.
5. Disconnect the MP3 player.
6. Use Skip buttons to select the music file; for example, abc.mp3. Press Play.
7. The LRC icon appears, and the lyrics are displayed synchronously on the LCD while the music is playing.

Note: The MP3 player supports LRC format only.

Note: If the lyrics do not synchronize with the music, download another lyric file from the internet and try again.

Note: Make sure the MP3 music and the LRC files are located in the same directory and the filename is the same. If not,

the MP3 player cannot recognize the lyric file.

MP3 Player Controls

- A. Power On/Off
- B. Earphone jack
- C. A-B/Menu button
- D. Play/Pause
- E. Skip Next / Fast Forward
- F. Skip Previous / Fast Rewind
- G. Hold Switch
- H. Stop
- I. Microphone
- J. Volume Up
- K. Volume Down
- L. USB Port
- M. Enter button

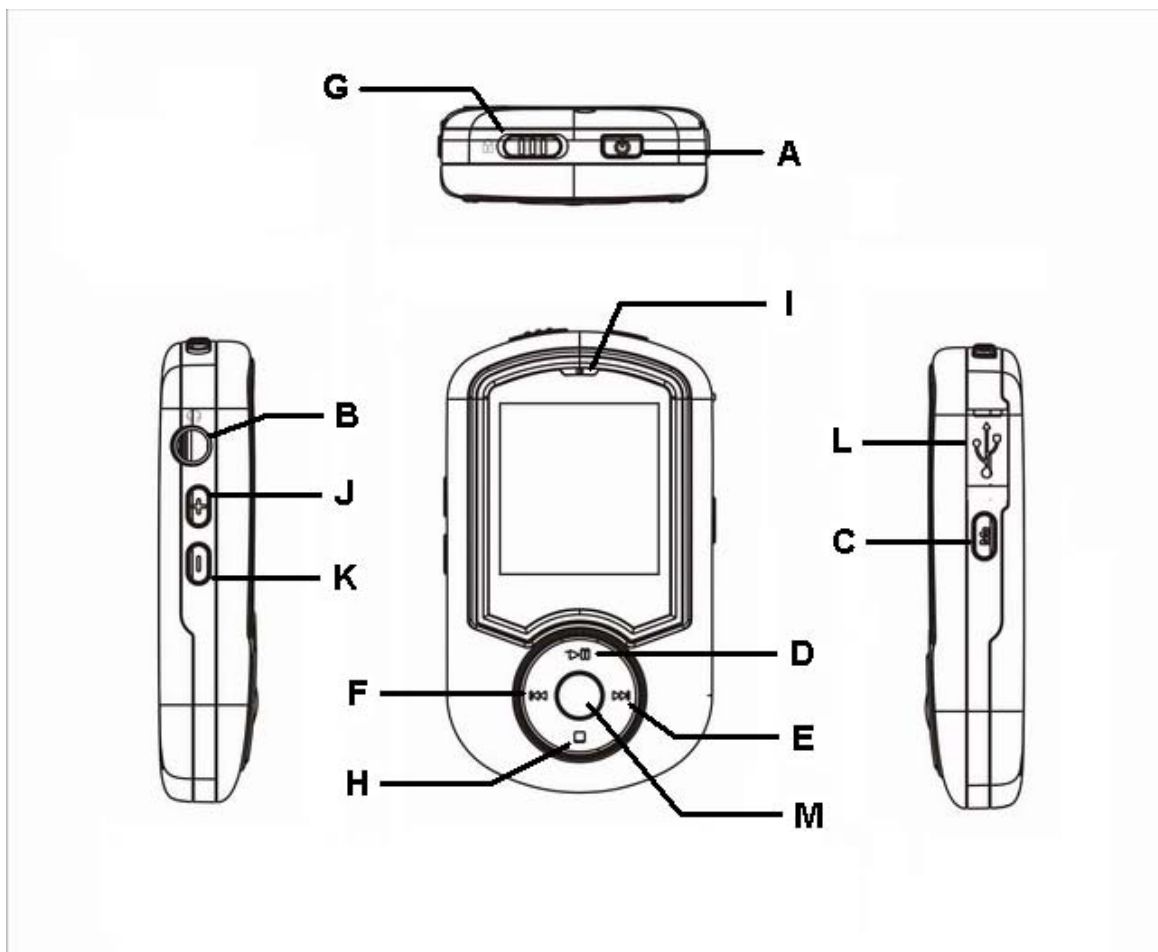

LCD Display

- A. Track Number / Total Tracks
- B. Random all
- C. Play/Pause/Stop/Rec.
- D. Music Mode/ Voice Mode
- E. Elapsed Time/ Track Time
- F. Equalizer
- G. Battery Indicator
- H. ID3 Tag (track name) display
- I. Process bar
- J. Volume
- K. A-B function

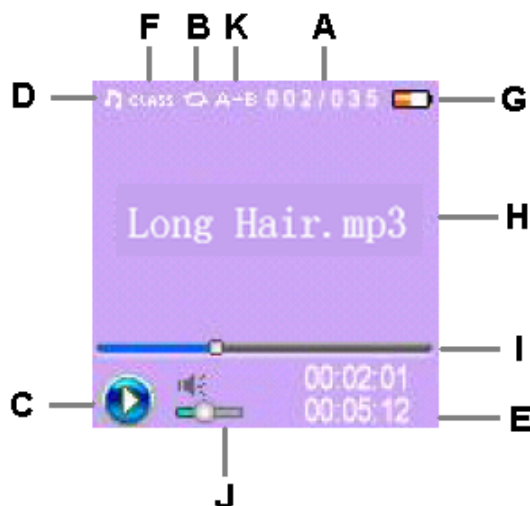

Video

The MP3 Player allows you to play video files. You can "transcode" AVI, WMV and MPG video files to the SMV video format using the software on the product CD. (Note: Only SMV video files can be played on this MP3 player.)

1. Insert the product CD into the computer.
2. Click "transcoder" button on the CD autorun background to open transcoder.

(Note: You may also copy the folder "transcoder" bundle on the CD to your computer and click the file "**video2smv.exe**" which is in the folder, "transcoder" to open the transcoder.)

3. Select the video quality and click Convert.
4. After transcoding, copy the SMV file to the MVIDEO folder of the MP3 Player.

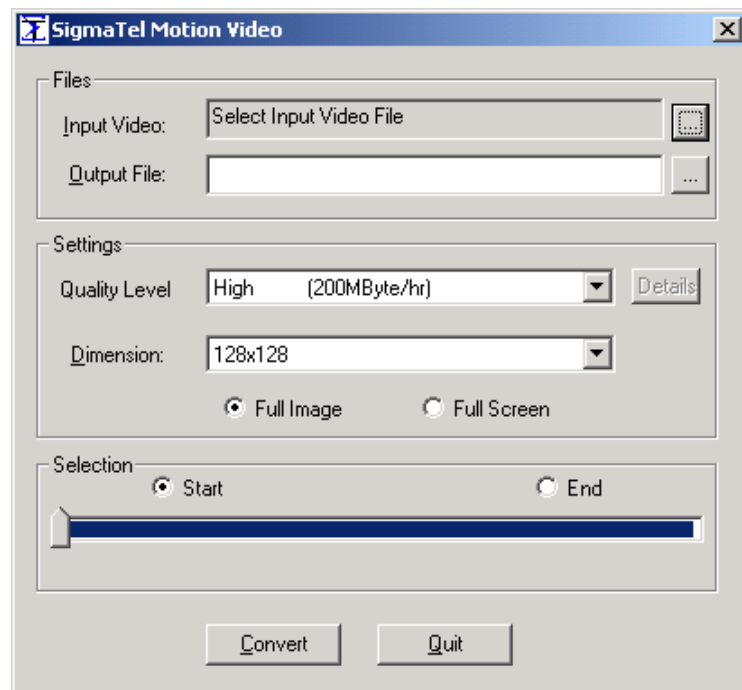

5. Press the Menu button.

6. Select **Video** to play.



Voice Recorder

Record voice

1. Select Record in the Main Menu list and press the Enter or A-B/Menu button to enter Record menu, select Start Record and press the Play or A-B/Menu button to begin recording.
2. Press the Stop or A-B/Menu button to stop the recording and enter Voice mode.

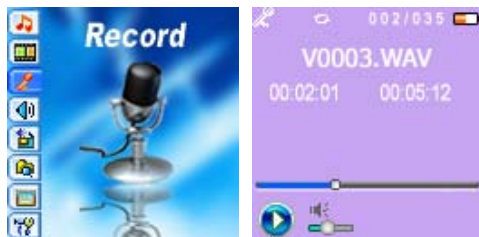

The voice recording will be saved as a file named Vxxx.WAV in the Voice folder.
Note that the LCD display will read MEMORY FULL when all available memory has been used.

Playback voice

This operation is similar to the playback of music.

1. Select Voice in the Main Menu to enter Voice mode.
2. Select a recording to listen to by pressing the Skip buttons.
3. Press the Play button to play back the recording.

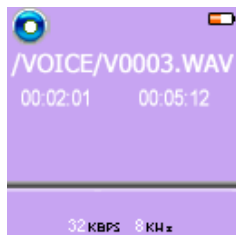

FM Tuner

The MP3 Player allows you to listen to FM radio with the built-in digital FM tuner.

Note: The earphone must be connected to the MP3 Player; otherwise, the FM tuner cannot find any FM stations.

Start the FM Tuner

To switch to FM radio mode, please select FM from the Menu list and press the A-B/Menu button.

Note: When using the MP3 Player Tuner for the first time, the MP3 Player will automatically start to seek all available FM radio stations and save them into preset list. Please wait until the scan icon disappears from the display.



To exit FM radio mode, press and hold the A-B/Menu button.

Exit to Main Menu from FM mode

Press and hold the A-B/Menu button for a while and release it. The MP3 Player will exit FM tuner mode and go back to Main Menu.

Listen to FM radio

After the FM tuner finishes automatic seeking, the MP3 Player tuner will stop at the first FM station of preset 01 .

To listen to another FM radio station which the player seeked and saved automatically, press the Play or Stop button

repeatedly. Every press on the buttons will cause the MP3 Player to change to another FM radio in the preset list.



Using the FM Settings menu

The FM Settings menu offers several convenient functions.

To navigate the FM Settings menu,

1. In FM Radio mode, press the A-B/Menu button to enter the FM Settings menu.
2. Press the Skip buttons to select one menu item.
3. Press the A-B/Menu button to apply.
4. To exit the FM Settings menu, press & hold the A-B/Menu button for a while and release it to exit to FM tuner.

Add to Preset

The MP3 Player tuner allows user to save a FM radio station to preset. After you have tuned to an FM radio station,

1. Select "Add to Preset" in the FM Settings menu and press the A-B/Menu button.
2. Press the Skip buttons to decide on a preset to be used for the current FM radio.
3. Press the A-B/Menu button to save.

Note: The unit can save 20 preset stations.



Load Preset

To select a FM radio station from the preset list to listen,

1. Select "Load Preset" in the FM Settings menu and press the A-B/Menu button.
2. Press the Skip buttons to select one FM radio station in the preset list.
3. Press the A-B/Menu button to listen.

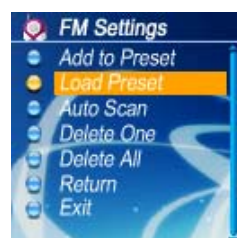

Auto Scan

To re-scan all FM radio stations and save them to the preset list automatically,

1. Select "Auto Scan" in the FM Settings menu and press the A-B/Menu button.
2. The MP3 Player tuner starts to seek and save the FM stations automatically. Please then wait a moment.



How to delete an FM radio station in the preset list.

1. In the FM Radio mode, press the A-B/Menu button to enter the FM Settings menu.
2. Press the Skip buttons to select Delete One and press the A-B/Menu button to enter the preset list.
3. Press the Skip buttons to select a FM radio station and press the A-B/Menu to confirm.
4. Press the Skip buttons to select Delete All and press the A-B/Menu button to enter the preset list.
5. Press the A-B/Menu button again, use the Skip buttons to select Yes or No, and press the A-B/Menu to confirm.



How to tune to one FM radio station manually

In FM Tuner, press and hold the Skip buttons.

The player searches for the nearest station. When it finds one, it stops and plays the station.

To tune manually, press the Skip buttons. Each time the Skip buttons is pressed, the player changes the frequency by 0.1MHz.

FM Recorder

FM Radio Recording

1. When listening to an FM radio, press and hold the Play button for a while and release it.
2. The MP3 Player starts to record the FM radio.
3. Press the Stop or A-B/Menu button to stop the recording and continue to listen the FM radio.

The FM recording will have been saved as a file named Fxxx.WAV in the FM folder.

The LCD display will read MEMORY FULL when all available memory has been used.

Play back an FM Radio recording

This operation is similar to the playback of music.

1. Select Music in the LCD menu to enter Music mode.
2. Use the Skip buttons to find the Fxxx.WAV files.

3. Press the Play button to playback the recording.

Hold Function

Use the Hold (LOCK) function to deactivate the MP3 Player controls (to avoid accidental activation).

1. To activate the Hold function, slide the Hold switch.
2. Slide the Hold switch back to turn off the Hold function.

Note: The MP3 Player will turn off automatically if the key is held when turning on the power.



Navigation

Use A-B/Menu button to enter Menu.

1. Select Navigation and press A-B/Menu button to enter navigation mode.
2. Press Skip buttons to select Flash Disk and press A-B/Menu button, choose Enter and press A-B/Menu button to get to submenu.
3. Press Skip buttons to select a file or folder and use the Play button to play the music or enter the folder.
4. Select the Back icon in the first row of the Navigation Menu, and press the A-B/Menu button to move back to the upper level.



Note: When a folder is selected in navigation mode, press on A-B/Menu button, a sub-menu window will pop-up. To enter the folder, select *Enter*. To play music located in the folder, select *Play*.

When a file is selected in navigation mode, press the A-B/Menu button; a sub-menu window will pop-up. To play this file, select *Play*. To erase, select *Delete*.

- **Note:** The player supports 500 music files totally, files after 500 will be ignored.
- **Note:** Supports 49 directories; directories after 49 will be ignored. The music files in these directories will be ignored also.
- **Note:**
Supports 254 files in one directory when in Navigation. If one directory has over 254 files, files after 254 will be ignored. However, they can still be found in music mode by pressing skip buttons.
- **Note:** Supports Long file name scrolling display.
- **Note:** The player supports folders up to 19 levels.

Photo

To browse the pictures, press the menu button and select **Photo**.



- Note: Support picture with JPG format.
- Note: Pictures must be stored in the folder "Photo" of the MP3 player, otherwise you cannot view them.

Advanced Settings

To navigate the Settings menu:

1. Press & hold the A-B/Menu button for a while and release it to enter the settings menu.
2. Press the Skip buttons to choose a setting.
3. Press the A-B/Menu button to select that setting.
4. After you have finished with the settings menu, press & hold the A-B/Menu button for a while and release it to exit the Menu.

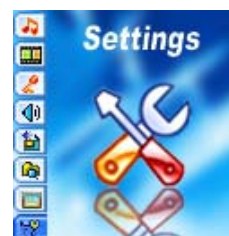

Equalizer Setting

The Equalizer (EQ) setting is to adjust the music sound effects. There are six EQ presets available: Normal, X-Bass, Rock, Jazz, Classical and Pop.

1. Select Equalizer in the settings menu.
2. Press the Skip buttons to select a preset EQ.
3. Press the A-B/Menu button to activate.



Repeat

The available Play Modes are:

- Normal
- Repeat One
- Repeat All
- Random
- Random All

1. In the settings menu, select Repeat.
2. Press the Skip buttons to select a play mode.



Adjust LCD Contrast

To adjust the LCD contrast,

1. In the settings menu, select Contrast.
2. Press the Skip buttons to adjust the contrast level.
3. Press the A-B/Menu button to go back to the settings menu.

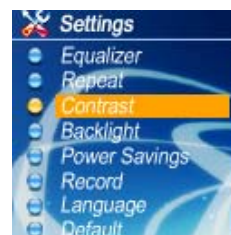

Backlight

To adjust the backlight

1. In the settings menu, select Back Light.
2. Press the Skip buttons to adjust the delay before the backlight is switched off.

Note: Selecting "Off" will turn off the backlight. Selecting "Always On" will keep the backlight always turned on. Battery life is considerably shorter if (Always On) is selected.

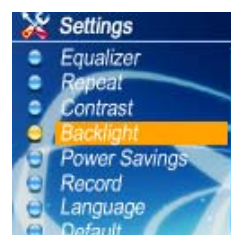

Power Savings

Use the Power Saving function to automatically turn the MP3 Player off after a predetermined length of inactivity.

1. In the settings menu, select Power Savings.
2. Press Skip buttons to select time.

Note: Selecting "Off" will never turn off the MP3 Player automatically.

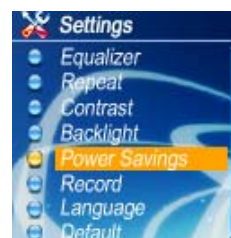

Recording Settings

A high record sampling frequency brings an increase in sound quality but also a corresponding increase in memory usage.

1. Press the Skip buttons to select **Record** in the Settings menu.
2. Press the Play button or A-B/Menu button to enter the the Record Settings menu.
3. Press the Skip buttons to choose Microphone or FM for record source, press the Play button or A-B/Menu button to enter the submenu.

4. Press the Skip buttons to set up the record format and sampling rate.
5. Press the Play button or A-B/Menu button to exit.



Note: A higher recording sampling frequency brings better recording quantity, but takes more memory space.

Sampling Rate	Maximum Recording Time per 128MB
8000 Hz	8 hours
11025 Hz	5.8 hours
16000 Hz	4 hours
22050 Hz	2.9 hours
32000 Hz	2 hours



Language select

The MP3 Player menu can be displayed in either English or French.

1. Press & hold the **A-B/Menu** button for a while and release the button to enter the LCD menu.
2. Press the **Skip** buttons to highlight *Settings* and press the **A-B/Menu** button.
3. In the *Settings* menu press the **Skip** buttons to highlight *Language* and press the **A-B/Menu** button.
4. In the *Language* menu press the **Skip** buttons to choose between *English* or *French* and press the **A-B/Menu** button.

All menu items will thereafter appear in the chosen language.

Default

To reset all settings to factory default setting,

1. In the settings menu, select "Default".
2. Press the A-B/Menu button. The default settings are loaded to the MP3 Player.



Delete

1. Stop playback or recording before attempting to Delete.
2. Press and hold the A-B/Menu button and release it to enter the menu and select Delete .
3. Press the Skip buttons to select Delete All or Delete One, and press the Play button or A-B/Menu button to enter the submenu.
4. In the Delete One menu, if you want to delete the music file, select Delete Music and press the Play button or A-B/Menu button to enter; if you want to delete the voice file, select Delete Voice and press the Play button or A-B/Menu button to enter.
5. Here you can press the Skip buttons to select if you are certain about deleting the current file; if you select Yes, the Player will show the File deleted!
6. When a file is deleted, the Player will remind you if you want to delete the next file until all files have been erased.
7. After finished erasing files, press the Skip buttons to select Exit to go back to the previous menu; you can also press and hold the A-B/Menu button to go back to the Main Menu.

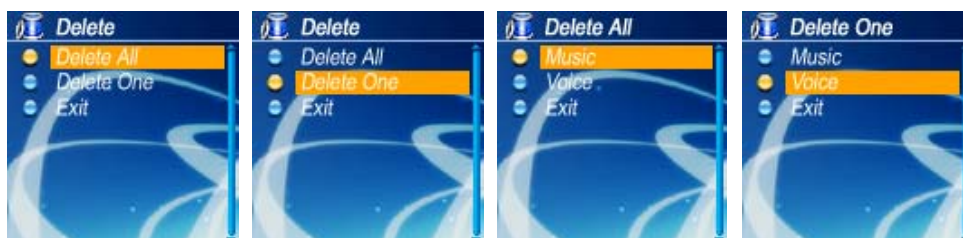
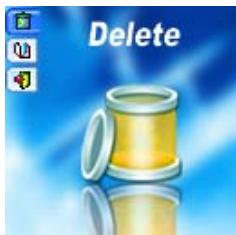

Warning: *Delete All* operation will erase all files store in the Player. Erased files cannot be recovered.

About

Information is available regarding the firmware version, built-in memory size and free memory size.

1. Select About in Main Menu list.
2. The firmware version and Internal Media info appears.
3. Press the Play button or A-B/Menu button to exit to Main Menu list screen.



Removing the MP3 Player from your computer

Windows Me, 2000 & XP user:

1. Click on the **Safely Remove Hardware** icon  in the taskbar (next to the clock).
2. Click on **Safely remove USB Mass Storage Device**.
3. Wait until a *Safe to Remove Hardware* message is displayed.
4. Remove the MP3 Player.

Windows 98SE users:

1. Wait until the player LCD displays "IDLE" for a moment.
2. Remove the MP3 Player.

Troubleshooting

Q Why can't I play DRM protected files?

A *DRM-protected files will only play if you copy them to the player through Windows Media Player or through the music management software provided by the online music store where you purchased the files.*

Q The LCD displays nothing after turning on the MP3 player.

1. *Check to see if battery is properly charged.*
2. *If battery has been charged, call our help line at 1-800-263-2244 (9-5 eastern, M-F).*

MP3 Player Specifications

- Internal Memory
 - Built-in 1 or 2GB (6 MB reserved for firmware and system management)
- Interface
 - USB 2.0 Compatible
- Power
 - Built-in 530mAh Rechargeable Li-ion battery
 - Battery continuous playing time: Up to 15 hours
- Equalizer
 - Normal, XBass, Rock, Jazz, Classical, Pop

- Display
 - 128 x 128 Dot-Matrix 65K Color STN display
 - ID3 Tag display
- Controls
 - Power On / OFF
 - Play / Pause
 - Stop
 - Skip Next
 - Skip Previous
 - A-B/Menu button
 - Volume +
 - Volume -
 - Hold Switch
 - Enter
- Processor
 - 75 MIPS DSP
- Audio Playback
 - Windows Media Audio (WMA)
 - MPEG Audio Layer 3 (MP3)
- Voice Recording
 - 8 KHz to 16 KHz sampling rate
 - Each 128 MB memory provides about 8 hours recording (at default setting, 8 KHz)
 - Recording via on-board microphone or FM radio
- FM Tuner
 - 88 ~ 108 MHz
 - 20 presets
- Signal to Noise Ratio
 - > 90 dB
- Frequency Response
 - 20 Hz ~ 20 kHz
- Output
 - < 4.4 mW (each output)
- Total Harmonic Distortion Output
 - 0.01% ~ 0.5%
- Ports
 - USB Port
 - Phone Out
- Firmware
 - Flash based. User upgradeable.

Safety

Listening to loud sounds for prolonged periods may permanently damage your hearing. Before putting on the headphones, place them around your neck and turn the volume down. Then put the headphones on and slowly increase the volume until you find a comfortable listening level.

THE SANYO COMFORT WARRANTY AUDIO PRODUCTS

WARRANTY APPLICATION

New, unused Sanyo Audio products purchased through a Sanyo authorized dealer in Canada are warranted against manufacturing defects in materials and workmanship for **ONE YEAR** from the date of purchase by the original retail purchaser. This warranty only applies in favour of the original retail purchaser of the warranted product.

SANYO CANADA INC.'S RESPONSIBILITY

During the warranty period, SANYO Canada Inc. will repair, or at our option, replace an Audio product which shows evidence of a manufacturing defect in materials or workmanship.

Replacement PARTS are warranted for the remaining portion of the warranty period.

WHAT IS NOT COVERED

- (a) Audio products purchased outside Canada.
- (b) Audio products purchased in a used condition.
- (c) Problems due to product set-up and installation.
- (d) Adjustments that are outlined in the Operating Manual.
- (e) Accessory items including antenna, batteries and cassette tapes.
- (f) Damage in or due to transportation.
- (g) Damage due to improper maintenance, improper wiring, accident, abuse, misuse or negligence.
- (h) Damage caused by lightning and power surges.
- (i) The cost of removal and re-installation of an Audio product designed for automobile use.

ORIGINAL RETAIL PURCHASER'S RESPONSIBILITY

You, the original retail purchaser, must present your original, dated bill-of-sale together with this warranty to SANYO Canada Inc. or to an authorized Sanyo Service Depot when you make a claim under this Warranty.

You, the original retail purchaser, are responsible for any costs of TRANSPORTING the product to and from SANYO Canada Inc. or an authorized Sanyo Service Depot. You also are responsible for the cost of any MAINTENANCE necessary in respect of the product.

WARRANTY BECOMES VOID

This warranty becomes void if the product's serial numbers are altered or removed or if any repair to the product is made other than by SANYO Canada Inc. or by an authorized Sanyo Service Depot.

LIMITATIONS

- (a) SANYO Canada Inc. reserves the right to change or improve the design of the model of the product warranted hereunder without incurring any obligation to make any modifications to or to install any improvement in or on the product.
- (b) In no event shall SANYO Canada Inc. or any of its Authorized Dealers be liable for special or consequential damage arising from the use of this product.

STATUTORY WARRANTIES

The above provisions do not preclude the operation of any applicable provincial statute which in certain circumstances may not allow some of the limitations and exclusions described in this Warranty. Where any terms of this Warranty are

prohibited by such a statute, they shall be deemed null and void but the remainder of this warranty shall remain in effect.

HOW TO OBTAIN WARRANTY SERVICE

Please contact the Sanyo Authorized Dealer from whom the product was purchased, or contact us directly at:

SANYO Canada Inc.

1-300 Applewood Cres.
Concord, Ont. L4K 5C7
(905) 760-9944
1-800-263-2244