

# RCA

u s e r  
m a n u a l

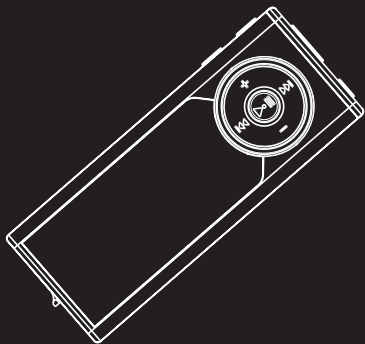

**TC1500**  
**TC1501**  
**TC1502**  
**TC1500FM**  
**TC1501FM**  
**TC1502FM**  
**TH1500**  
**TH1501**  
**TH1502**

It is important to read this instruction book prior to using your new product for the first time.  
Es importante leer este manual antes de usar por vez primera su equipo.

# FCC Information

EN

## FCC Information

This device complies with Part 15 of the FCC Rules. Operation is subject to the following two conditions: (1) This device may not cause harmful interference, and (2) this device must accept any interference received, including interference that may cause undesired operation.



In accordance with FCC requirements, changes or modifications not expressly approved by Thomson Inc. could void the user's authority to operate this product. This equipment has been tested and found to comply with the limits for a Class B digital device, pursuant to Part 15 of FCC Rules. These limits are designed to provide reasonable protection against harmful interference in a residential installation. This equipment generates, uses, and can radiate radio frequency energy and, if not installed and used in accordance with the instructions, may cause harmful interference to radio communications. However, there is no guarantee that interference will not occur in a particular installation. If this equipment does cause harmful interference to radio or television reception, which can be determined by turning the equipment off and on, the user is encouraged to try to correct the interference by one or more of the following measures

- Reorient or relocate the receiving antenna.
- Increase the separation between the equipment and receiver.
- Connect the equipment into an outlet on a circuit different from that to which the receiver is connected.
- Consult the dealer or an experienced radio/TV technician for help.

Also, the Federal Communications Commission has prepared a helpful booklet, "How To Identify and Resolve Radio TV Interference Problems." This booklet is available from the U.S. Government Printing Office, Washington, DC 20402. Please specify stock number 004-000-00345-4 when ordering copies. This product complies with DHHS Rules 21 CFR Subchapter J. Applicable at the date of manufacture.

This Class B digital apparatus complies with Canadian ICES-003.

Cet appareil numérique de la class B est conforme à la norme du NMB-003 du Canada

	<b>CAUTION</b> RISK OF ELECTRIC SHOCK DO NOT OPEN	
THE LIGHTNING FLASH AND ARROW-HEAD WITHIN THE TRIANGLE IS A WARNING SIGN ALERTING YOU OF "DANGER OF VOLTAGE" INSIDE THE PRODUCT.	CAUTION: TO REDUCE THE RISK OF ELECTRIC SHOCK, DO NOT REMOVE COVER (OR BACK). NO USER-SERVICEABLE PARTS INSIDE. REFER SERVICING TO QUALIFIED SERVICE PERSONNEL.	THE EXCLAMATION POINT WITHIN THE TRIANGLE IS A WARNING SIGN ALERTING YOU OF IMPORTANT INSTRUCTIONS ACCOMPANYING THE PRODUCT.
SEE MARKING ON BOTTOM / BACK OF PRODUCT		

**WARNING: TO PREVENT FIRE OR ELECTRICAL SHOCK HAZARD, DO NOT EXPOSE THIS PRODUCT TO RAIN OR MOISTURE.**

The descriptions and characteristics given in this document are given as a general indication and not as a guarantee. In order to provide the highest quality product possible, we reserve the right to make any improvement or modification without prior notice. The English version serves as the final reference on all products and operational details should any discrepancies arise in other languages.

# Safety Information

EN



RCA  
TC1500A

Equipment tested for compliance as a complete unit



RCA  
TC1501A

Equipment tested for compliance as a complete unit



RCA  
TC1501B

Equipment tested for compliance as a complete unit



RCA  
TC1502A

Equipment tested for compliance as a complete unit



RCA  
TC1502B

Equipment tested for compliance as a complete unit



RCA  
TC1500FMA

Equipment tested for compliance as a complete unit



RCA  
TC1501FMA

Equipment tested for compliance as a complete unit



RCA  
TC1501FMB

Equipment tested for compliance as a complete unit



RCA  
TC1502FMA

Equipment tested for compliance as a complete unit



RCA  
TC1502FMB

Equipment tested for compliance as a complete unit



RCA  
TH1500A

Equipment tested for compliance as a complete unit



RCA  
TH1501A

Equipment tested for compliance as a complete unit



RCA  
TH1501B

Equipment tested for compliance as a complete unit



RCA  
TH1502A

Equipment tested for compliance as a complete unit



RCA  
TH1502B

Equipment tested for compliance as a complete unit

## Product Registration

Please fill out the product registration card and return it immediately. Returning this card allows us to contact you if needed.

### For Your Records

Keep your sales receipt for proof of purchase to obtain warranty parts and service.

In the event that service should be required, you may need both the model number and the serial number. In the space below, record the date and place of purchase, and the serial number:

Date of Purchase

Place of Purchase

Serial No.

### Service Information

This product should be serviced only by those specially trained in appropriate servicing techniques. For instructions on how to obtain

service, refer to the warranty included in this Guide.

### Technical Specification

Product: Digital Audio Player

Brand: RCA

Model: TC1500, TC1501, TC1502, TC1500FM, TC1501FM, TC1502FM, TH1500, TH1501, TH1502

### Electrical Consumption

Lithium polymer battery (internal)

IMPORTER

Comercializadora Thomson de México, S.A. de C.V.

Álvaro Obregón No. 151. Piso 13.

Col. Roma. Delegación Cuauhtémoc

C.P. 06700. México, D.F.

Teléfono: 52-55-11-020360

RFC: CTM-980723-K55

# IMPORTANT SAFETY INSTRUCTIONS

EN

## PLEASE READ AND SAVE FOR FUTURE REFERENCE

Some of the following information may not apply to your particular product; however, as with any electronic product, precautions should be observed during handling and use.

- Read these instructions.
  - Keep these instructions.
  - Heed all warnings.
  - Follow all instructions.
  - Do not use this apparatus near water.
  - Clean only with dry cloth.
  - Do not block any ventilation openings. Install in accordance with the manufacturer's instructions.
  - Do not install near any heat sources such as radiators, heat registers, stoves, or other apparatus (including amplifiers) that produce heat.
  - Do not defeat the safety purpose of the polarized or grounding-type plug. A polarized plug has two blades with one wider than the other. A grounding type plug has two blades and a third grounding prong. The wide blade or the third prong is provided for your safety. If the provided plug does not fit into your outlet, consult an electrician for replacement of the obsolete outlet.
  - Protect the power cord from being walked on or pinched particularly at plugs, convenience receptacles, and the point where they exit from the apparatus.
- Only use attachments/accessories specified by the manufacturer.
  - Use only with the cart, stand, tripod, bracket, or table specified by the manufacturer, or sold with the apparatus. When a cart is used, use caution when moving the cart/apparatus combination to avoid injury from tip-over.



**Portable Cart Warning**

- Unplug this apparatus during lightning storms or when unused for long periods of time.
- Refer all servicing to qualified service personnel. Servicing is required when the apparatus has been damaged in any way, such as power-supply cord or plug is damaged, liquid has been spilled or objects have fallen into the apparatus, the apparatus has been exposed to rain or moisture, does not operate normally, or has been dropped.

# IMPORTANT SAFETY INSTRUCTIONS

EN

- **ADDITIONAL SAFETY INFORMATION**

- Apparatus shall not be exposed to dripping or splashing and no objects filled with liquids, such as vases, shall be placed on the apparatus.
- Always leave sufficient space around the product for ventilation. Do not place product in or on a bed, rug, in a bookcase or cabinet that may prevent air flow through vent openings.
- Do not place lighted candles, cigarettes, cigars, etc. on the product.
- Connect power cord only to AC power source as marked on the product.
- Care should be taken so that objects do not fall into the product.
- Do not attempt to disassemble the cabinet. This product does not contain customer serviceable components.

- **IF YOUR PRODUCT OPERATES ON BATTERIES, adhere to the following precautions:**

- A. Any battery may leak electrolyte if mixed with a different battery type, if inserted incorrectly, or if all batteries are not replaced at the same time.
- B. Any battery may leak electrolyte or explode if disposed of in fire or an attempt is made to charge a battery not intended to be recharged.
- C. Discard leaky batteries immediately. Leaking batteries can cause skin burns or other personal injury. When discarding batteries, be sure to dispose of them in the proper manner, according to your state/provincial and local regulations.

# End User License Agreement

EN

**IMPORTANT-READ CAREFULLY: This End User License Agreement ("Agreement") is a legal agreement between you and Thomson Inc. ("Thomson") for the RCA Audio Device application/driver software program and associated documentation, if any ("Program").**

## ACKNOWLEDGMENT

BY INSTALLING THE SOFTWARE OR CLICKING ON THE ACCEPTANCE BUTTON OF THE SOFTWARE, COPYING OR OTHERWISE USING THE PROGRAM, YOU ACKNOWLEDGE AND AGREE THAT YOU HAVE READ THIS AGREEMENT, UNDERSTAND IT, AND AGREE TO BE BOUND BY ITS TERMS AND CONDITIONS. IF YOU DO NOT AGREE TO THE TERMS OF THIS LICENSE AGREEMENT, CLICK ON THE REJECTION BUTTON AND/OR DO NOT INSTALL THE SOFTWARE AND/OR DO NOT USE THE PROGRAM.

## LICENSE

a) You are granted the license (i) to use the Program on a single workstation and (ii) to make one (1) copy of the Program into any machine-readable form for backup of the Program, provided the copy contains all of the original Program's proprietary notices.

b) You may transfer the Program and license, only as part of the Audio Device, to another party if the other party agrees to accept the terms and conditions of this Agreement. If you transfer the Program, you must at the same time either transfer all copies to the same party or destroy any copies not transferred.

## LICENSE RESTRICTIONS

a) Except for the licenses expressly granted to you in this Agreement, no other licenses are implied.

b) You may not (i) modify, translate, reverse engineer, decompile, disassemble (except to the extent that this restriction is expressly prohibited

by law) or create derivative works based upon the Program or (ii) copy the Program, except as expressly permitted herein. You agree that you shall only use the Program in a manner that complies with all applicable laws in the jurisdictions in which you use the Program, including, but not limited to, applicable restrictions concerning copyright and other intellectual property rights.

c) The Program may contain pre-release code that does not perform at the level of a final code release. In this case, the Program may not operate properly. Updated versions of the Program can be downloaded from [www.rca.com](http://www.rca.com).

d) Thomson is not obligated to provide support services for the Program.

e) The Program is provided with "RESTRICTED RIGHTS". Use, duplication, or disclosure by the U.S. Government is subject to restrictions as set forth in subparagraph (c)(1)(ii) of DFARS 252.227-7013, or FAR 52.227-19, or in FAR 52.227-14 Alt. III, as applicable.

## TERM AND TERMINATION

a) The license is effective on the date you accept this Agreement, and remains in effect until terminated by either party.

b) You may terminate this license without any notice or delay, by destroying or permanently erasing the Program and all copies thereof.

c) If you use, copy, modify, or transfer the Program, or any copy, in whole or part, except as expressly provided for in this license, your license is automatically terminated.

d) When the license is terminated, you must destroy or permanently erase the Program and all copies thereof.

# End User License Agreement

EN

## WARRANTY DISCLAIMER

THE PROGRAM IS PROVIDED "AS IS" WITHOUT WARRANTY OF ANY KIND, EITHER EXPRESSED OR IMPLIED, INCLUDING, BUT NOT LIMITED TO THE IMPLIED WARRANTIES OF MERCHANTABILITY, FITNESS FOR A PARTICULAR PURPOSE, TITLE OR NON-INFRINGEMENT. THE ENTIRE RISK AS TO THE QUALITY AND PERFORMANCE OF THE PROGRAM IS WITH YOU. SHOULD THE PROGRAM PROVE DEFECTIVE, YOU (AND NOT THOMSON, ITS SUPPLIERS, ITS AFFILIATES OR ITS DEALERS) ASSUME THE ENTIRE COST FOR ALL NECESSARY REPAIR OR CORRECTION.

This exclusion of warranty may not be allowed under some applicable laws. As a result, the above exclusion may not apply to you, and you may have other rights depending on the law that applies to you.

## OWNERSHIP RIGHTS

All title and intellectual property rights in and to the Program and any copies thereof are owned by Thomson or its suppliers. All title and intellectual property rights in and to the content which may be accessed through use of the Program is the property of the respective content owner and may be protected by applicable copyright or other intellectual property laws and treaties. This license grants you no rights to use such content.

## LIMITATION OF LIABILITY

a) TO THE MAXIMUM EXTENT PERMITTED BY APPLICABLE LAW, IN NO EVENT SHALL THOMSON, ITS AFFILIATES, OR ITS DEALERS BE LIABLE FOR ANY SPECIAL, INCIDENTAL, INDIRECT OR CONSEQUENTIAL DAMAGES WHATSOEVER (INCLUDING, WITHOUT LIMITATION, DAMAGES FOR LOSS OF PROFITS, BUSINESS INTERRUPTION, CORRUPTION OF FILES, LOSS OF BUSINESS INFORMATION OR ANY OTHER PECUNIARY LOSS) REGARDLESS OF CAUSE OR FORM OF

ACTION, INCLUDING CONTRACT, TORT OR NEGLIGENCE, ARISING OUT OF THE USE OF OR INABILITY TO USE THE PROGRAM, EVEN IF THOMSON HAS BEEN ADVISED OF THE POSSIBILITY OF SUCH DAMAGES. BECAUSE SOME STATES AND JURISDICTIONS DO NOT ALLOW THE EXCLUSION OR LIMITATION OF LIABILITY OF CONSEQUENTIAL OR INCIDENTAL DAMAGES, THE ABOVE LIMITATION MAY NOT APPLY TO YOU.  
b) YOU ASSUME RESPONSIBILITY FOR THE SELECTION OF THE APPROPRIATE PROGRAM TO ACHIEVE YOUR INTENDED RESULTS, AND FOR THE INSTALLATION, USE, AND RESULTS OBTAINED.

# End User License Agreement

EN

## WINDOWS MEDIA

This version of the Audio Device Player ("The Player") contains software licensed from Microsoft that enables you to play Windows Media Audio (WMA) files ("WMA Software"). The WMA Software is licensed to you for use with the RCA/THOMSON Portable Audio Device digital music player under the following conditions. By installing and using this version of the Player, you are agreeing to these conditions. IF YOU DO NOT AGREE TO THE CONDITIONS OF THIS END USER LICENSE AGREEMENT, DO NOT INSTALL OR USE THIS VERSION OF THE Player.

The WMA Software is protected by copyright and other intellectual property laws. This protection also extends to documentation for the WMA Software, whether in written or electronic form.

**GRANT OF LICENSE.** The WMA Software is only licensed to you as follows:  
You may use this version of the Player containing the WMA Software only with the Portable Audio Device player.

You may not reverse engineer, decompile, or disassemble the WMA Software, except and only to the extent that such activity is expressly permitted by applicable law in spite of this limitation.

You may transfer your right to use this version of the Player only as part of a sale or transfer of your Portable Audio Device player, on the condition that the recipient agrees to the conditions in this End User License Agreement. If the version of the Player that you are transferring is an upgrade, you must also transfer all prior versions of the Player that you have which include the WMA Software.

**MICROSOFT IS NOT PROVIDING ANY WARRANTY OF ANY KIND TO YOU FOR THE WMA**

**SOFTWARE, AND MICROSOFT MAKES NO REPRESENTATION CONCERNING THE OPERABILITY OF THE WMA SOFTWARE.**

The WMA Software is of U.S. origin. Any export of this version of the Player must comply with all applicable international and national laws, including the U.S. Export Administration Regulations, that apply to the WMA Software incorporated in the Player.



# End User License Agreement

EN

## **THIRD PARTY SOFTWARE**

ANY THIRD PARTY SOFTWARE THAT MAY BE PROVIDED WITH THE PROGRAM IS INCLUDED FOR USE AT YOUR OPTION. IF YOU CHOOSE TO USE SUCH THIRD PARTY SOFTWARE, THEN SUCH USE SHALL BE GOVERNED BY SUCH THIRD PARTY'S LICENSE AGREEMENT, AN ELECTRONIC COPY OF WHICH WILL BE INSTALLED IN THE APPROPRIATE FOLDER ON YOUR COMPUTER UPON INSTALLATION OF THE SOFTWARE. THOMSON IS NOT RESPONSIBLE FOR ANY THIRD PARTY'S SOFTWARE AND SHALL HAVE NO LIABILITY FOR YOUR USE OF THIRD PARTY SOFTWARE.

## **GOVERNING LAW**

This Agreement is governed by the laws of the State of Indiana, U.S.A. without regard to its conflict of laws.

## **GENERAL TERMS**

This Agreement can only be modified by a written agreement signed by you and Thomson, and changes from the terms and conditions of this Agreement made in any other manner will be of no effect. If any portion of this Agreement shall be held invalid, illegal, or unenforceable, the validity, legality, and enforceability of the remainder of the Agreement shall not in any way be affected or impaired thereby. This Agreement is the complete and exclusive statement of the agreement between you and Thomson, which supersedes all proposals or prior agreements, oral or written, and all other communications between you and Thomson, relating to the subject matter of this Agreement.

# Table of Contents

EN

## FCC Information

### Safety Information

### End User License Agreement

### Table of Contents . . . . .1

### Before You Begin . . . . .2

Unpacking your unit . . . . .2

What's so special about this

mp3 player? . . . . .2

Computer system requirements . . .2

Precautions for the unit . . . . .3

Caution . . . . .3

Caution while driving . . . . .3

Headset safety . . . . .3

Important Battery Information . . .4

Caution . . . . .4

### Connecting to Computer . . . . .5

Charging the Battery . . . . .5

Transferring Files to the Player . . .5

### General Controls . . . . .6

### Quick Start . . . . .7

How Files are Organized . . . . .7

Menu Navigation . . . . .7

Switching On and Off Player . . . . .7

Playing/Pausing . . . . .8

Skipping Files . . . . .8

Scanning Files . . . . .8

Listening to Radio . . . . .8

### mp3 and WMA Playback . . . . .9

Basic Playback . . . . .9

Random Playback . . . . .9

Repeat Playback . . . . .9

My Selections . . . . .9

### Radio . . . . .10

Basic Operations . . . . .10

Manual and Preset Modes . . . . .10

Manual Tuning . . . . .10

Saving Preset Stations . . . . .10

Selecting Preset Stations . . . . .10

Clearing Presets . . . . .10

Suppressing Stereo Signal . . . . .10

Stop Listening to the Radio . . . . .10

### Radio Recording . . . . .11

Recording Radio . . . . .11

Selecting Recording Duration . . .11

Listening to Radio Recordings . . .11

Deleting Radio Recordings . . . . .11

### Voice Recording . . . . .12

Voice Recording . . . . .12

Listening to Voice Recordings . . .12

Deleting Voice Recordings . . . . .12

### Line-in Recording . . . . .13

Line-in Recording . . . . .13

Listening to Line-in Recordings . . .13

Deleting Line-in Recordings . . . . .13

### Setting the Player . . . . .14

DSP . . . . .14

Settings . . . . .14

System Info . . . . .14

### More Information . . . . .15

### US Limited Warranty . . . . .17

### Canadian Limited Warranty . . .18

# Before You Begin

EN

"Dear RCA Customer,

Thank you for purchasing the RCA Digital Audio Player. This product will play open mp3 and Windows Media™ audio (WMA) content as well as content purchased from most online music download services.

After purchasing and downloading music to your PC, you are now ready to move content to your player. To transfer the music, you should use Windows Media Player or the application recommended by the online music download service.

(Note: Services and applications must be Windows Media audio-compliant and support Digital Rights Management.)"

## Unpacking your unit

When you unpack your new player, be sure you have removed all the accessories and documentation. The items below should have been packed in the box with your player.

- Digital Audio Player
- Music Management CD
- Earphones
- USB extension cable
- Line-in cable (TC1500FM, TC1501FM, TC1502FM, TH1500, TH1501, TH1502 only)
- Neck strap

## What's so special about this mp3 player?

This player is meant to play mp3 and Windows Media™ audio files.

To do so, you need the use of a Windows computer with a USB port, USB extension cable (optional) and music management software.

## Computer system requirements

- Pentium III 500MHz or higher recommended  
Macintosh iMac G3 or higher
- Windows @98SE, Me, 2000 (SP3 or higher), or XP  
Mac OS X Version 10.2 or higher
- Internet Explorer 4.0 or higher
- Internet access
- 200MB free hard disk space for the software
- 64MB RAM (128 MB recommended)
- CD-ROM drive capable of digital audio extraction
- USB port (2.0 recommended)
- Sound card

# Before You Begin

EN



## Warning:

Use of this product is for your personal use only. Unauthorized recording or duplication of copyrighted material may infringe upon the rights of third parties and may be contrary to copyright laws.

## Precautions for the Unit

- Do not use the unit immediately after transportation from a cold place to a warm place; condensation problem may result.
- Avoid shock to the unit.
- Do not store the unit near fire, places with high temperature or in direct sunlight.
- Do not operate or store unit in places with frequent static electricity or electrical noise (e.g. speaker, TV set).
- Clean the unit with a soft cloth or a damp chamois leather. Never use solvents.
- The unit must only be opened by qualified personnel.

## Caution

- Keep product out of direct sunlight. Exposure to direct sunlight or extreme heat (such as inside a parked car) may cause damage or malfunction.
- Do not expose to rain or moisture.

## Caution while Driving

Use of headphones while operating an automobile or moving vehicle is not recommended and is unlawful in some states and areas. Be careful and attentive on the road. Stop operation of the unit if you find it disruptive or distracting while driving.

## Headset Safety



Have a Blast- Just Not in Your Eardrums

Make sure you turn down the volume on the unit before you put on

headphones. Increase the volume to the desired level only after headphones are in place.

- Do not play your headset at a high volume. Hearing experts warn against extended high-volume play.
- If you experience a ringing in your ears, reduce volume or discontinue use.
- You should use extreme caution or temporarily discontinue use in potentially hazardous situations. Even if your headset is an open-air type designed to let you hear outside sounds, don't turn up the volume so high that you are unable to hear what is around you.

# Before You Begin

EN

## Important Battery Information

- Charge the unit for at least 2 hours before first use.
- Charge the unit for at least 2 hours after putting away the unit for a long time.
- The battery used in this device may present a risk of fire or chemical burn if mistreated. Do not separately recharge, disassemble, heat above 100°C (212°F), or incinerate.
- **Battery replacement should only be made by a trained technician. Refer to Limited Warranty for details.**
- Do not attempt to open the unit. No user serviceable parts inside.
- To reduce risk of injury, use only rechargeable batteries recommended by the manufacturer for this product. Other types of batteries may burst causing damage and personal injury.
- Keep the unit away from children. Do not disassemble or incinerate.
- Use USB port of PC or the specified charger (not included). Use of another charger may present a risk of fire or explosion.

## Caution

- The battery used in this device may present a risk of fire, explosion, or chemical burn if mistreated. Do not separately recharge, disassemble, heat above 100°C (212°F), or incinerate.

- Do not place the battery under direct sunlight or in excessively hot places over 45°C (113°F) such as the dashboard of car.
- Dispose of used battery promptly. Keep away from children. Do not disassemble and do not dispose of in fire.



# Connecting to Computer

EN

## Charging the Battery

The player's battery can only be charged through the USB port of a computer.

1. Slide the USB connector upward as shown below.

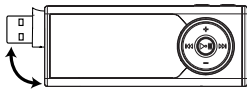

2. Insert the USB connector of the player into the USB port on the computer tightly (use an optional USB extension cable if necessary). Once connected, the display shows as below:

USB Connected  
Hold ▶|| to charge batt.

3. Press and hold ▶|| to enter battery charging mode. The display shows as below with the battery icon  animating.

USB Connected

- Charge the unit for at least 2 hours before first use.
- You can still transfer files to the player in the battery charging mode.
- When the battery is full, the display shows "Battery full".

## Transferring Files to the Player

You should refer to the software manual for details in software installation, connecting your player with the computer and transferring files to the player.



### Note

The player will automatically go to battery charging mode if the battery level is low.



### Attention

Do not disconnect the USB connection during music download. Doing so may corrupt system files or the files being downloaded.





### Note

Refer to the software instruction manual for procedures in installing music management software and transferring files to the player.

# General Controls

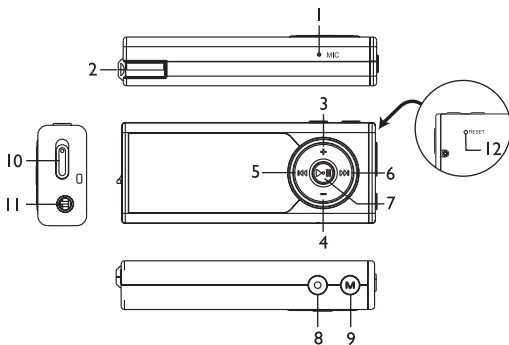
EN



1. **MIC** - Microphone.
2. USB connector.
3. **+** - Increases volume; moves upward in menu navigation.
4. **-** - Decreases volume; moves downward in menu navigation.
5. **⏮** - Skip and search backward a file; goes back a menu level in menu navigation; selects radio frequency and preset stations.
6. **⏭** - Skip and search forward a file; goes up a menu level in menu navigation; selects radio frequency and preset stations..
7. **⏸** - Press and hold to switch on or off the player; starts and pauses playback.
8. **●** - Starts and ends recording; press to select music files as My Selections; for sectioned audible files, press repeatedly during playback to select skipping by section or by file.
9. **M** - Accesses the player's menu.
10. Lock switch - slide to the locked icon to prevent accidental key activation. The lock icon  shows on the display when keys are locked.
11. Headphone jack, input jack for line-in recording (TC1500FM, TC1501FM, TC1502FM, TH1500, TH1501, TH1502 only).
12. Reset button.

# Quick Start

EN

## How Files are Organized?

The files transferred to the player will be sorted automatically so that you can easily find and play them. They are sorted as below:

- Music
- Audiobooks
- Radio Recs
- Voice / Line-in Recs (Voice Recs for TC1500, TC1501, TC1502)
- My Selections

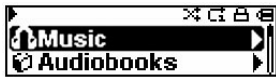

Note: Radio Recs files are recorded files from the radio (see “Radio Recording”); Voice / Line-in Recs are recorded files from the microphone and line-in audio cable respectively (see “Voice Recording” and “Line-in Recording”). My Selections files are your preferred files (see “My Selections”).

Music files are further sorted as below:

- Artists
- Albums
- Titles
- Genres
- Years

The navigation menu is displayed when playback is stopped or when **M** is pressed during playback.

## Menu Navigation

To navigate through the menu, press **▶▶** to go up a menu level, press **+** or **-** to move along menu items at the same level. Press **◀◀** to go back a menu level.

If the selected item is a music, audible or recorded file, press **▶▶** or **▶||** will start playback.

## Switching On and Off Player

- Press and hold **▶||** to turn on the unit.
- To turn off the player completely, press and hold **▶||**.



# Quick Start

EN

## Playing / Pausing

- Press **▶||** to begin playback.
- Press **▶||** once to pause playback, press again to resume playback.

During playback, file duration, elapsed playback time, file information show on the display.



## Skipping Files

- To skip to the next file, press and release **▶▶**.
- To go to the previous file, press and release **◀◀** within the beginning 4 seconds of the current file. Otherwise, press and release **◀◀** twice. (This operation does not apply to audible file. Press **◀◀** at any time during playback to go to the previous file.)

**Note:** for sectioned audible files, press **●** and then perform the steps above to go to the previous or next audible section. Press **●** repeatedly to select skipping by file or by section.

## Scanning Files

- To scan backward, press and hold **◀◀** during playback.
- To scan forward, press and hold **▶▶** during playback.

## Listening to Radio

**(TC1500FM, TC1501FM, TC1502FM, TH1500, TH1501, TH1502 only)**

1. While the display shows the navigation screen for file selection, press **M** to access the player's menu. (If the display shows the playback screen, press **M** twice to access the player's menu.)
2. While "Go to" is highlighted in the menu, press **▶▶** to enter into the submenu.



3. While "Radio" is highlighted, press **▶▶** to switch to radio.



4. Press **▶||** so that "P01" does not show on the display and you have switched off preset mode. "01" can also be any preset station number.
5. Press **◀◀** or **▶▶** once to tune down or up frequency. or  
Press and hold **◀◀** or **▶▶** and release the button when you see "Searching..." to start automatic search for the next available station. or  
Press and hold **◀◀** or **▶▶** continuously to tune down or up frequency at a faster rate until you release the button.

# mp3 and WMA Playback

EN



## Basic Playback

Refer to “Quick Start”.

## Random Playback

While the display shows the navigation screen for file selection, press **M** to access the player’s menu. (If the display shows the playback screen, press **M** twice to access the player’s menu.) Press **–** to select “Shuffle”. Press **▶||** repeatedly to select the shuffle mode on or off. The shuffle icon  lights on the display.

## Repeat Playback

While the display shows the navigation screen for file selection, press **M** to access the player’s menu. (If the display shows the playback screen, press **M** twice to access the player’s menu.) Press **–** to select “Repeat”. Press **▶||** repeatedly to select a repeat mode (Repeat One , Repeat All  and Repeat Off).

The corresponding icon lights on the display.



### Tips:

Shuffle on + Repeat one = a file is selected randomly and played repeatedly.

Shuffle on + Repeat All = Files are played in random order repeatedly.

## My Selections

My Selections is a playlist of your preferred music files (audible and recorded files are not selectable).

1. Select your preferred files in one of the following ways:
  - Press **●** once while you are listening to a preferred music file with “Added to MySel” shows on the display briefly.
  - Press **●** once while you are browsing music files in the navigation menu with “Added to MySel” shows on the display briefly. (see “Quick Start - How Files are Organized and Menu Navigation” for details).
2. Select “My Selections” folder from the navigation menu (see “Quick Start - How Files are Organized and Menu Navigation” for details).
3. Press **▶||** to begin playback.
  - To clear My Selections, while the display shows the navigation screen for file selection, press **M** to access the player’s menu. (If the display shows the playback screen, press **M** twice to access the player’s menu.) Press **–** to select “Clear MySel”. Press **▶||** to confirm clearing.

## Basic Operations

Refer to "Quick Start" for basic operations.

## Manual and Preset Modes

Press **▶||** repeatedly to select between the two modes while listening to the radio.

**Manual mode** – tuning to stations manually,

**Preset mode** – selecting stations saved in preset memory.

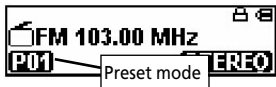

## Manual Tuning

Prefer to step 5 of "Listening to Radio" on p.8 for more information.

## Saving Preset Stations

1. Tune to a station to be saved as a preset station (refer to manual tuning).
2. Press **M**.
3. Press **-** to select "Save to Preset" and press **▶||**.
4. Press **◀◀** or **▶▶** to select a preset number.
5. Press **▶||** to save station as selected preset number.

## Selecting Preset Stations

1. Make sure you are in preset mode
2. Press **◀◀** or **▶▶** to select a preset number.

## Clearing Presets

1. In preset mode, select the preset station to be cleared, press **M** to view the radio sub-menu.
2. Press **-** to select "Clear Preset".
3. Press **▶||** to confirm clearing.

## Suppressing Stereo Signal

If FM stereo reception is weak, select mono sound to reduce the noise.

1. While listening to the radio, press **M** to view the radio sub-menu.
2. Press **-** to select "Mode".
3. Press **▶||** repeatedly to select between stereo or mono sound.

## Stop Listening to the Radio

- Press and hold **▶||** to switch off the player. OR
- Press **M** while listening to the radio. Select "Go to" and then "Library" by pressing **▶||** twice. The player will return to file navigation you were last at. If you were looking at an artist, then you will return to that list of artists.

# Radio Recording

EN

TC1500FM, TC1501FM, TC1502FM,  
TH1500, TH1501, TH1502 only

## Recording Radio

Radio programs can be recorded as wav files.

1. Tune to the station to be recorded.
2. Press ● to start recording. Press ▶|| to pause recording and again to resume.
3. Press ● to stop recording.



## Selecting Recording Duration

1. While listening to the radio, press **M** to view the radio sub-menu.
2. Press – to select "RecDur" (recording duration).
3. Press ▶|| repeatedly to select among max, 1 hour, 30 min and 5 min.

## Listening to Radio Recordings

1. In the file navigation menu, press – to select "Radio Recs".
2. Press ▶|| to view radio recordings and then press – to select a desired recording.
3. Press ▶|| or ▶|| to play the selected recording.

## Deleting Radio Recordings

1. In the file navigation menu, press – to select "Radio Recs".
2. Press ▶|| to view radio recordings and then press – to select an unwanted recording.
3. Press **M** and then – to select "Delete File".
4. Press ▶|| to confirm deletion.

# Voice Recording

EN

## Voice Recording

Voice can be recorded through the microphone as wav files.

1. While playback is stopped, press **M** to access the player's menu.
2. Press **▶||** while "Go to" is highlighted.
3. Press **-** to select "Voice / Line-in Recs" ("Voice Recs" for TC1500, TC1501 and TC1502).
4. Press **▶||**, "Ready" shows on the display.
5. Press **●** to start recording. Press **▶||** to pause recording. Press again to resume.
6. Press **●** to stop recording.



## Listening to Voice Recordings

1. In the navigation menu, press **-** to select "Voice / Line-in Recs" ("Voice Recs" for TC1500, TC1501 and TC1502).
2. Press **▶||** to view recordings and press **-** to select a desired recording. Voice recordings are indicated by "Voice" at the beginning of the file names.
3. Press **▶||** or **▶||▶||** to play the selected recording.

## Deleting Voice Recordings

1. In the navigation menu, press **-** to select "Voice / Line-in Recs" ("Voice Recs" for TC1500, TC1501 and TC1502).
2. Press **▶||** to view recordings and press **-** to select an unwanted recording. Voice recordings are indicated by "Voice" at the beginning of the file names.
3. Press **M** and then **-** to select "Delete File".
4. Press **▶||** to confirm deletion.

# Line-in Recording

EN

**TC1500FM, TC1501FM, TC1502FM  
TH1500, TH1501, TH1502 only**

## Line-in Recording

Recording as wav files can be made through a line-in cable connected to the headphone jack.

1. While playback is stopped, press **M** to access the player's menu.
2. Press **▶||** while "Go to" is highlighted.
3. Press **-** to select "Line-in Recording".
4. Press **▶||**, "Ready" shows on the display.
5. Start playback of the line-in source.
6. Press **●** to start recording. Press **▶||** to pause recording. Press again to resume.
7. Press **●** to stop recording.



## Listening to Line-in Recordings

1. In the navigation menu, press **-** to select "Voice / Line-in Recs".
2. Press **▶▶** to view recordings and then press **-** to select a desired recording. Line-in recordings are indicated by "Line" at the beginning of the file names.
3. Press **▶||** or **▶▶** to play the selected recording.

## Deleting Line-in Recordings

1. In the navigation menu, press **-** to select "Voice / Line-in Recs".
2. Press **▶▶** to view recordings and then press **-** to select an unwanted recording. Line-in recordings are indicated by "Line" at the beginning of the file names.
3. Press **M** and then **-** to select "Delete File".
4. Press **▶||** to confirm deletion.



### Tips:

Adjust the volume level of the source audio device in order to achieve the optimum recording quality. The source output varies from model to model. You might want to experiment with a few recordings to determine the proper volume output of the source to get optimum recording quality from the player. Recommend starting the source at a volume level that adequate at room volume level.

# Setting the Player

## DSP

DSP feature consists a number of sound effects.

While the display shows the navigation screen for file selection, press **M** to access the player's menu and then press **-** to select "DSP". (If the display shows the playback screen, press **M** twice to access the player's menu.) Press **▶||** repeatedly to select an effect mode (Flat, Bass, Pop, Rock and Jazz).

## Settings

While the display shows the navigation screen for file selection, press **M** to access the player's menu and then press **-** to select "Settings". (If the display shows the playback screen, press **M** twice to access the player's menu.) Press **▶||** to enter the setting menu. The following items are available:

- **Brightness** (adjusts the display brightness, 8 levels available),
- **Screensaver** (adjusts the duration before screensaver activation, 5 options available),
- **Power Save** (adjusts the duration before automatic switch off, 5 options available),
- **FreqStep** (Frequency Step) (selects between US and Europe frequency mode),

- **Language** (selects the display language)
- **Restore Defaults** (restore all settings to default values by pressing **▶||** )

Unless otherwise indicated, select available options within each item by pressing **▶||** repeatedly. To exit the setting menu, press **M**.

## System Info

While the display shows the navigation screen for file selection, press **M** to access the player's menu and then press **-** to select "System Info". (If the display shows the playback screen, press **M** twice to access the player's menu.) Press **▶||** to check memory usage and firmware version.

# More Information

EN

## Troubleshooting Tips

### The player does not turn on when the PLAY button is pressed?

- Battery may be empty.
- Press the reset button to reset the player.

### Skipping tracks or bad sound quality?

- Repeat, random or program function may be activated.
- There may be strong magnetic fields (e.g. too close to TV) near the unit.
- Low Battery level.

### Cannot perform playback?

- LOCK function may be activated.
- There may be no mp3/WMA tracks in the internal memory.

### USB display does not appear when connected to computer?

- Check connection between your unit and the computer. (Refer to the software instruction manual)
- Check if the USB drivers are properly installed if you are using Windows 98SE.
- You may have to re-associate the drive letter that was assigned to the device. Please check your help on Windows for details on assigning a different drive letter.

### Cannot playback tracks on the player.

- Make sure audio tracks are encoded in the mp3 or Windows Media formats at supported bitrates. Bitrates supported by the player:  
mp3 – 32 to 320 kbps  
wma – 48 to 192 kbps
- WMA or audiobooks files may be DRM protected and you don't have the proper rights (license) to play the files.
- Check the website and/or application help system of the music download service provider from where the content was purchased for license acquisition details. For more information on how license acquisition works, go to [www.microsoft.com/windowsmedia/drm](http://www.microsoft.com/windowsmedia/drm).
- Play the original or downloaded song on your computer to ensure that there was nothing wrong with the encoding of the mp3 or WMA.

### The player does not work after reformat.

- In case you need to reformat the player, it must be in FAT or FAT32 format. The player does not work in NTFS format.



# More Information

EN

## What does the PlaysForSure logo mean?

- PlaysForSure is a new logo program from Microsoft®. Consumers can match the PlaysForSure logo on a large selection of devices and online music stores. If you see the logo, you'll know your digital media will play for sure. For more information on the Microsoft PlaysForSure program, visit [www.PlaysForSure.com](http://www.PlaysForSure.com).

## Check for Updates

Visit <http://www.rca.com/digitalaudidownloads> for the latest news and firmware upgrades for our Digital Audio Player. You must update your system after new downloads have been made in order for the new applications to be executed.

## Frequently Asked Questions

You can get FAQ information at [www.rca.com/digitalaudiofaq](http://www.rca.com/digitalaudiofaq).

## Specifications

Weight: 30g

Dimensions: 78mm (Length) x 31mm (Width) x 15mm (Thickness).



### Note:

For better result, we recommend a constant encoded bit rate from 32 to 320kbps for mp3 and 48kbps to 192kbps for Windows Media Audio. Nevertheless, your unit can play tracks encoded in variable bit rate (VBR).



### Note:

This unit may temporarily cease to function if subjected to electrostatic disturbance. To resume to normal functioning, you may use a pin to activate the reset button.

# US Limited Warranty

EN

## What your warranty covers:

- Defects in materials or workmanship.

## For how long after your purchase:

- One year from date of purchase.

The warranty period for rental units begins with the first rental or 45 days from date of shipment to the rental firm, whichever comes first.

## What we will do:

- Provide you with a new, or at our option, a refurbished unit. The exchange unit is under warranty for the remainder of the original product's warranty period.
- Proof of purchase in the form of a bill of sale or receipted invoice which is evidence that the product is within the warranty period must be presented to obtain warranty service. For rental firms, proof of first rental is also required.

## How to make a warranty claim:

- Properly pack your unit. Include any cables, etc., which were originally provided with the product. We recommend using the original carton and packing materials.
- Include evidence of purchase date such as the bill of sale. Also print your name and address and a description of the defect. Send via standard UPS or its equivalent to:

Thomson Inc., Product Exchange Center  
11721 B Alameda Avenue, Socorro, Texas 79927

- Insure your shipment for loss or damage. Thomson accepts no liability in case of damage or loss en route to Thomson.
- Pay any charges billed to you by the Exchange Center for service not covered by the warranty.
- A new or refurbished unit will be shipped to you freight prepaid.

## What your warranty does not cover:

- Customer instruction. (Your Owner's Manual provides information regarding operating Instructions and user controls. For additional information, ask your dealer.)
- Installation and set-up service adjustments.
- Batteries.
- Damage from misuse or neglect.
- Products which have been modified or incorporated into other products.
- Products purchased or serviced outside the USA.
- Acts of nature, such as but not limited to lightning damage.

## Product Registration:

- Please complete and mail the Product registration Card packed with your unit. It will make it easier to contact you should it ever be necessary. The return of the card is not required for warranty coverage.

## Limitation of Warranty:

- **THE WARRANTY STATED ABOVE IS THE ONLY WARRANTY APPLICABLE TO THIS PRODUCT. ALL OTHER WARRANTIES, EXPRESS OR IMPLIED (INCLUDING ALL IMPLIED WARRANTIES OF MERCHANTABILITY OR FITNESS FOR A PARTICULAR PURPOSE) ARE HEREBY DISCLAIMED. NO VERBAL OR WRITTEN INFORMATION GIVEN BY THOMSON INC., ITS AGENTS OR EMPLOYEES SHALL CREATE A WARRANTY OR IN ANY WAY INCREASE THE SCOPE OF THIS WARRANTY.**
- **REPAIR OR REPLACEMENT AS PROVIDED UNDER THIS WARRANTY IS THE EXCLUSIVE REMEDY OF THE CONSUMER. THOMSON INC. SHALL NOT BE LIABLE FOR INCIDENTAL OR CONSEQUENTIAL DAMAGES RESULTING FROM THE USE OF THIS PRODUCT OR ARISING OUT OF ANY BREACH OF ANY EXPRESS OR IMPLIED WARRANTY ON THIS PRODUCT. THIS DISCLAIMER OF WARRANTIES AND LIMITED WARRANTY ARE GOVERNED BY THE LAWS OF THE STATE OF INDIANA. EXCEPT TO THE EXTENT PROHIBITED BY APPLICABLE LAW, ANY IMPLIED WARRANTY OF MERCHANTABILITY OR FITNESS FOR A PARTICULAR PURPOSE ON THIS PRODUCT IS LIMITED TO THE APPLICABLE WARRANTY PERIOD SET FORTH ABOVE.**

## How state law relates to this warranty:

- Some states do not allow the exclusion nor limitation of incidental or consequential damages, or limitations on how long an implied warranty lasts, so the above limitations or exclusions may not apply to you.
- This warranty gives you specific legal rights, and you also may have other rights that vary from state to state.

## If you purchased your product outside the USA:

- This warranty does not apply. Contact your dealer for warranty information.

# Canadian Limited Warranty

EN

Thomson multimedia Ltd. warrants to the purchaser or gift recipient that if any manufacturing defect becomes apparent in this product within 1 year from the original date of purchase, it will be replaced free of charge, including return transportation.

This warranty does not include damage to the product resulting from accidents, misuse or leaking batteries.

Should your product not perform properly during the warranty period, either:

1. Return it to the selling dealer with proof of purchase for replacement,

OR

2. Remove the batteries (where applicable), and pack product complete with accessories in the original carton (or equivalent).

— Mail prepaid (with proof of purchase) and insured to:

**Thomson multimedia Ltd.**

**6200 Edwards Blvd.,**

**Mississauga, Ontario L5T 2V7**

**Canada**

The provisions of this written warranty are in addition to and not a modification of or subtraction from the statutory warranties and other rights and remedies contained in any applicable legislation, and to the extent that any such provisions purport to disclaim, exclude or limit any such statutory warranties and other rights and remedies, such provisions shall be deemed to be amended to the extent necessary to comply therewith.

If you are unable to find a qualified servicer for out of warranty service, you may write to:

Thomson Inc.

P.O. Box 0944

Indianapolis, Indiana, U.S.A., 46206-0944

Attach your sales receipt to this booklet for future reference. This information is required if service is needed during the warranty period.

PURCHASE DATE

NAME OF STORE

---

**IMPORTADOR**

Comercializadora Thomson de México, S.A. de C.V.

Álvaro Obregón No. 151. Piso 13.

Col. Roma. Delegación Cuauhtémoc

C.P. 06700. México, D.F.

Telefono: 52-55-11-020360

RFC: CTM-980723-KS5

---

Thomson Inc.

P.O. Box 1976

Indianapolis, IN 46206-1976

© 2006 Thomson Inc.

Trademark(s) ® Registered

Marca(s) ® Registrada(s)

Marque(s) ® Déposé(e)

[www.rca.com](http://www.rca.com)

Printed In China / Impreso en China

Tocom (v4.0)

# RCA

u s e r  
m a n u a l

Software  
Installation  
File Transfer

Installation des  
software  
Transfert de  
musique

Instalación de  
logiciel  
Trasferencia de  
Música

It is important to read this instruction book prior to using your new product for the first time.  
Es importante leer este manual antes de usar por vez primera su equipo.

# End User License Agreement

EN

**IMPORTANT-READ CAREFULLY: This End User License Agreement ("Agreement") is a legal agreement between you and Thomson Inc. ("Thomson") for the RCA Audio Device application/driver software program and associated documentation, if any ("Program").**

## ACKNOWLEDGMENT

BY INSTALLING THE SOFTWARE OR CLICKING ON THE ACCEPTANCE BUTTON OF THE SOFTWARE, COPYING OR OTHERWISE USING THE PROGRAM, YOU ACKNOWLEDGE AND AGREE THAT YOU HAVE READ THIS AGREEMENT, UNDERSTAND IT, AND AGREE TO BE BOUND BY ITS TERMS AND CONDITIONS. IF YOU DO NOT AGREE TO THE TERMS OF THIS LICENSE AGREEMENT, CLICK ON THE REJECTION BUTTON AND/OR DO NOT INSTALL THE SOFTWARE AND/OR DO NOT USE THE PROGRAM.

## LICENSE

- a) You are granted the license (i) to use the Program on a single workstation and (ii) to make one (1) copy of the Program into any machine-readable form for backup of the Program, provided the copy contains all of the original Program's proprietary notices.
- b) You may transfer the Program and license, only as part of the Audio Device, to another party if the other party agrees to accept the terms and conditions of this Agreement. If you transfer the Program, you must at the same time either transfer all copies to the same party or destroy any copies not transferred.

# End User License Agreement

EN

## LICENSE RESTRICTIONS

- a) Except for the licenses expressly granted to you in this Agreement, no other licenses are implied.
- b) You may not (i) modify, translate, reverse engineer, decompile, disassemble (except to the extent that this restriction is expressly prohibited by law) or create derivative works based upon the Program or (ii) copy the Program, except as expressly permitted herein. You agree that you shall only use the Program in a manner that complies with all applicable laws in the jurisdictions in which you use the Program, including, but not limited to, applicable restrictions concerning copyright and other intellectual property rights.
- c) The Program may contain pre-release code that does not perform at the level of a final code release. In this case, the Program may not operate properly. Updated versions of the Program can be downloaded from [www.rca.com](http://www.rca.com).
- d) Thomson is not obligated to provide support services for the Program.

e) The Program is provided with "RESTRICTED RIGHTS". Use, duplication, or disclosure by the U.S. Government is subject to restrictions as set forth in subparagraph (c)(1)(ii) of DFARS 252.227-7013, or FAR 52.227-19, or in FAR 52.227-14 Alt. III, as applicable.

## TERM AND TERMINATION

- a) The license is effective on the date you accept this Agreement, and remains in effect until terminated by either party.
- b) You may terminate this license without any notice or delay, by destroying or permanently erasing the Program and all copies thereof.
- c) If you use, copy, modify, or transfer the Program, or any copy, in whole or part, except as expressly provided for in this license, your license is automatically terminated.
- d) When the license is terminated, you must destroy or permanently erase the Program and all copies thereof.

# End User License Agreement

EN

## WARRANTY DISCLAIMER

THE PROGRAM IS PROVIDED "AS IS" WITHOUT WARRANTY OF ANY KIND, EITHER EXPRESSED OR IMPLIED, INCLUDING, BUT NOT LIMITED TO THE IMPLIED WARRANTIES OF MERCHANTABILITY, FITNESS FOR A PARTICULAR PURPOSE, TITLE OR NON-INFRINGEMENT. THE ENTIRE RISK AS TO THE QUALITY AND PERFORMANCE OF THE PROGRAM IS WITH YOU. SHOULD THE PROGRAM PROVE DEFECTIVE, YOU (AND NOT THOMSON, ITS SUPPLIERS, ITS AFFILIATES OR ITS DEALERS) ASSUME THE ENTIRE COST FOR ALL NECESSARY REPAIR OR CORRECTION.

This exclusion of warranty may not be allowed under some applicable laws. As a result, the above exclusion may not apply to you, and you may have other rights depending on the law that applies to you.

## OWNERSHIP RIGHTS

All title and intellectual property rights in and to the Program and any copies thereof are owned by Thomson or its suppliers. All title and intellectual property rights in and to the content which may be accessed through use of the Program is the property of the respective content owner and may be protected by applicable copyright or other intellectual property laws and treaties. This license grants you no rights to use such content.



# End User License Agreement

EN

## LIMITATION OF LIABILITY

a) TO THE MAXIMUM EXTENT PERMITTED BY APPLICABLE LAW, IN NO EVENT SHALL THOMSON, ITS AFFILIATES, OR ITS DEALERS BE LIABLE FOR ANY SPECIAL, INCIDENTAL, INDIRECT OR CONSEQUENTIAL DAMAGES WHATSOEVER (INCLUDING, WITHOUT LIMITATION, DAMAGES FOR LOSS OF PROFITS, BUSINESS INTERRUPTION, CORRUPTION OF FILES, LOSS OF BUSINESS INFORMATION OR ANY OTHER PECUNIARY LOSS) REGARDLESS OF CAUSE OR FORM OF ACTION, INCLUDING CONTRACT, TORT OR NEGLIGENCE, ARISING OUT OF THE USE OF OR INABILITY TO USE THE PROGRAM, EVEN IF THOMSON HAS BEEN ADVISED OF THE POSSIBILITY OF SUCH DAMAGES.

BECAUSE SOME STATES AND JURISDICTIONS DO NOT ALLOW THE EXCLUSION OR LIMITATION OF LIABILITY OF CONSEQUENTIAL OR INCIDENTAL DAMAGES, THE ABOVE LIMITATION MAY NOT APPLY TO YOU.

b) YOU ASSUME RESPONSIBILITY FOR THE SELECTION OF THE APPROPRIATE PROGRAM TO ACHIEVE YOUR INTENDED RESULTS, AND FOR THE INSTALLATION, USE, AND RESULTS OBTAINED.

## WINDOWS MEDIA

This version of the Audio Device Player ("The Player") contains software licensed from Microsoft that enables you to play Windows Media Audio (WMA) files ("WMA Software"). The WMA Software is licensed to you for use with the RCA/THOMSON Portable Audio Device digital music player under the following conditions. By installing and using this version of the Player, you are agreeing to these conditions. IF YOU DO NOT AGREE TO THE CONDITIONS OF THIS END USER LICENSE AGREEMENT, DO NOT INSTALL OR USE THIS VERSION OF THE Player.

# End User License Agreement

EN

The WMA Software is protected by copyright and other intellectual property laws. This protection also extends to documentation for the WMA Software, whether in written or electronic form.

**GRANT OF LICENSE.** The WMA Software is only licensed to you as follows: You may use this version of the Player containing the WMA Software only with the Portable Audio Device player.

You may not reverse engineer, decompile, or disassemble the WMA Software, except and only to the extent that such activity is expressly permitted by applicable law in spite of this limitation.

You may transfer your right to use this version of the Player only as part of a sale or transfer of your Portable Audio Device player, on the condition that the recipient agrees to the conditions in this End User License Agreement. If the version of the Player that you are transferring is an upgrade, you must also transfer all prior versions of the Player that you have which include the WMA Software.

MICROSOFT IS NOT PROVIDING ANY WARRANTY OF ANY KIND TO YOU FOR THE WMA SOFTWARE, AND MICROSOFT MAKES NO REPRESENTATION CONCERNING THE OPERABILITY OF THE WMA SOFTWARE.

The WMA Software is of U.S. origin. Any export of this version of the Player must comply with all applicable international and national laws, including the U.S. Export Administration Regulations, that apply to the WMA Software incorporated in the Player.

# End User License Agreement

EN

## THIRD PARTY SOFTWARE

ANY THIRD PARTY SOFTWARE THAT MAY BE PROVIDED WITH THE PROGRAM IS INCLUDED FOR USE AT YOUR OPTION. IF YOU CHOOSE TO USE SUCH THIRD PARTY SOFTWARE, THEN SUCH USE SHALL BE GOVERNED BY SUCH THIRD PARTY'S LICENSE AGREEMENT, AN ELECTRONIC COPY OF WHICH WILL BE INSTALLED IN THE APPROPRIATE FOLDER ON YOUR COMPUTER UPON INSTALLATION OF THE SOFTWARE. THOMSON IS NOT RESPONSIBLE FOR ANY THIRD PARTY'S SOFTWARE AND SHALL HAVE NO LIABILITY FOR YOUR USE OF THIRD PARTY SOFTWARE.

## GOVERNING LAW

This Agreement is governed by the laws of the State of Indiana, U.S.A. without regard to its conflict of laws.

## GENERAL TERMS

This Agreement can only be modified by a written agreement signed by you and Thomson, and changes from the terms and conditions of this Agreement made in any other manner will be of no effect. If any portion of this Agreement shall be held invalid, illegal, or unenforceable, the validity, legality, and enforceability of the remainder of the Agreement shall not in any way be affected or impaired thereby. This Agreement is the complete and exclusive statement of the agreement between you and Thomson, which supersedes all proposals or prior agreements, oral or written, and all other communications between you and Thomson, relating to the subject matter of this Agreement.

# Table of Contents

EN

## End User License Agreement

### Table of Contents

#### Before You Begin . . . . .1

Computer System Requirements . . . 1

What's so special about this mp3 player? . . . . .2

#### Getting Started . . . . .3

Insert the Included CD-ROM into

CD-ROM Drive . . . . .3

#### Connecting to the Computer . .4

Connecting the Player to the

Computer . . . . .4

#### Transferring Music . . . . .5

Transferring Files to the Digital  
Audio Player . . . . .5

Transferring Files via Yahoo! Music  
Engine . . . . .6

Yahoo! Music Unlimited: Supercharge  
the Engine . . . . .7

Transferring Files via Windows Media  
Player . . . . .8

Transferring Files via Windows Explorer  
(Drag and Drop) . . . . .9

## Profiling (Model Dependent) .9

### Disconnecting the Player . . . .10

Disconnecting Your Player from  
the Computer . . . . .10

### Troubleshooting Tips . . . . .11

The descriptions and characteristics given in this document are given as a general indication and not as a guarantee. In order to provide the highest quality product possible, we reserve the right to make any improvement or modification without prior notice. The English version serves as the final reference on all products and operational details should any discrepancies arise in other languages.

# Before You Begin

EN

**Dear RCA Customer,**  
Thank you for purchasing the RCA Digital Audio Player. Our products will play open mp3 and Windows Media™ audio (WMA) content and for certain models, content purchased from most online music download services.

**After purchasing and downloading music to your PC, you are now ready to move content to your player. To transfer the music, you may use the applications recommended by the online music download service.**

## Computer System Requirements

- Pentium III 500MHz or higher recommended
- Windows® 98SE, Me, 2000, or XP
- Internet Explorer 4.0 or higher
- Internet access
- 100MB free hard disk space for the software
- 64MB RAM (128 MB recommended)
- CD-ROM drive capable of digital audio extraction
- USB port (2.0 recommended)
- Sound card



### Warning:

Use of this product is for your personal use only. Unauthorized recording or duplication of copyrighted material may infringe upon the rights of third parties and may be contrary to copyright laws.

# Before You Begin

EN

## What's so special about this mp3 player?

This player is meant to play mp3 and Windows Media™ audio files transferred in the built-in flash memory. To do so, you need the use of a Windows computer with USB port and a music management software (Yahoo! Music Engine or Window Media Player recommended).

The Music Management CD that comes with your Digital Audio Player contains all of the necessary software components you need to make your Digital Audio Player work properly.

These components do the following:

- to install USB driver (for Windows 98SE users only),
- to use a music management software to organize your music collection,
- to enable you to transfer files from your computer to your Digital Audio Player.

# Getting Started

## Inserting the Included CD-ROM into CD-ROM Drive

1. Turn on your computer and place the Music Management CD that comes with your digital audio player into your computer.

**Note:**

Don't connect the USB device to the PC or digital audio player before or during the CD-ROM installation.

If you're running Windows ME/ 2000/ XP, no additional drivers are required. If you're running Windows 98SE, you must install the USB drivers from the CD-ROM in order for the digital audio player to function properly.

2. If the setup screen does not appear, double click My Computer, double click your CD-ROM drive icon, and double click "Install" to run the installer.

**Note:** The Music

Management CD may contain one or more music management software that can help transfer music content to your digital audio player. Please refer to the section on your installed software for basic transfer operations.

# Connecting to the Computer

EN

## Connecting the Player to the Computer

Connect the Digital Audio Player to your computer. If a USB connection cable is provided, connect it to the player first before the computer. The larger end of the cable should be connected to the computer while the smaller end to the player.

The player

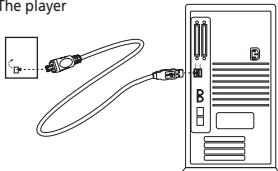

Some models can be directly connected to the USB port of the computer. If necessary, an optional USB extension cable can be used.

The digital audio player will appear as a removable disk drive.



### Note

It might take several seconds for the device (the Digital Audio Player) to be detected, especially in Windows 2000/XP. Click Refresh in My Computer or Explorer to make sure the device has been detected.



### Note

The Digital Audio Player is capable of transferring files at full-speed when a USB 2.0 connection is used. USB 2.0 is up to 40 times faster than USB 1.1. If a USB 2.0 port is available on your computer, use it to connect to your Digital Audio Player. The player is still backward compatible with the older USB 1.1 ports. However, you will not be able to take full advantage of the potential speed increase.



# Transferring Music

EN

## Transferring Files to a Digital Audio Player

Depending on the availability of software on your Music Management CD specific to your digital audio player, you can transfer files to your Digital Audio Player via 1) Yahoo! Music Engine (Windows XP only), 2) Windows Media Player or 3) Windows Explorer (requires no software installation).

If your Digital Audio Player isn't already connected to your computer, connect it to the computer using the provided USB cable as illustrated on the previous page.

- Transferring files via Yahoo! Music Engine (Windows XP only) - refer to page 6,
- Transferring files via Windows Media Player - refer to page 8,
- Transferring files via Windows Explorer (drag-and-drop) - refer to page 9.



### Attention

Do not disconnect the USB connection during music download. Doing so may corrupt system files or the files being downloaded.



### Note

- Secure music download files can be transferred to your player through Windows Media Player or Yahoo! Music Engine. (Note: Services and applications must be Windows Media audio-compliant and support Digital Rights Management. Windows XP with Service Pack 1 required.) (Apple iTunes™ music content is not supported).

For more information on Yahoo! Music Engine, visit <http://music.yahoo.com/musicengine>

For more information on Windows Media Player, visit <http://www.microsoft.com/windows/windowsmedia>.

- Some wma files may be DRM protected. You must acquire licenses for DRM protected wma files before they can be played on the player. For more information, go to [www.microsoft.com/windows/windowsmedia/drm](http://www.microsoft.com/windows/windowsmedia/drm)

# Transferring Music

EN

## Transferring Files via Yahoo! Music Engine (Windows XP only)

Yahoo! Music Engine lets you manage your music easily and organize like a pro. Create your own playlists: music for work, the gym, or even dinner. You can also buy music and transfer to your digital audio player in seconds. Just drag and drop and you're done. For more information on the installation and operations, please visit: <http://music.yahoo.com/musicengine/>



1. Launch the Yahoo! Music Engine.
2. Attach the digital audio player to your computer. You should see the Jukebox name appear in the left navigation pane.
3. In the Yahoo! Music Engine, click My Music or click on a playlist on the left navigation pane.

4. From a playlist (*My Playlists* in the left navigation pane): at the bottom of the Yahoo! Music Engine window, click the **Transfer to Device** button and select the drive letter to where the playlist is to be transferred. OR
5. From My Music: drag and drop files from My Music to the digital audio player. (You may also drag artists and albums from My Music).
6. The Yahoo! Music Engine will check to see if there is sufficient storage space on the device to copy the songs. If not, you will have to reduce the number of songs you are transferring.



**Note:** Yahoo! Music Engine only works on Windows XP with Service Pack 1 or higher.



**Attention**  
Make sure all data are transferred to the Digital Audio Player before unplugging the USB connection.

# Transferring Music

## **Yahoo! Music Unlimited: Supercharge the Engine**

Yahoo! Music Unlimited is a subscription service with access to over 1 million songs, plus much more. For a low monthly price, you can:

- add any of those million songs to your personal music library to listen,
- transfer to your digital audio player,
- share with others\*,
- buy burnable downloads,
- listen to LAUNCHcast Plus, the commercial-free radio service.

To subscribe, click Y! Unlimited in the left navigation pane then click on the graphic offering you a 7-day free trial.

If you have a Yahoo! ID, you will be taken through the account setup process. If you do not have a Yahoo! ID, you will be prompted to sign up for a free Yahoo! account, then you will be taken through the Y! Music Unlimited setup process.

For more information, please visit:  
<http://music.yahoo.com>

\* Yahoo! Music does not permit copying or transferring music files to other users.

# Transferring Music

## EN Transferring Files via Windows Media Player

If you want to take your music collection with you, you can easily synchronize items in your library to your digital audio player. The Sync feature in the latest version of Windows Media Player and allows you to synchronize files in categories and playlists in your library to your digital audio player. For complete details, see the “Synchronizing media to your device” topic in the Windows Media Player help documentation.

1. Connect your player to the computer and open Windows Media Player, select Library from the menu bar, a screen will appear as below:

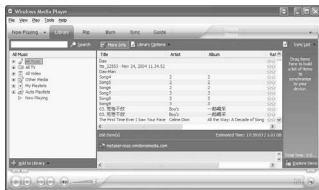

2. From the left column, select the songs, categories and/or playlist items you want to copy to the player.
3. Drag the selected items to the right column.

4. Select Sync from the menu bar, a screen will appear as below:



5. Select Start Sync, the selected items will now be automatically transferred to your player.



### Attention

Make sure all data are transferred to the Digital Audio Player before unplugging the USB connection.

# Transferring Music

## Transferring Files via Windows Explorer (Drag and Drop)

From Windows Explorer, highlight all the files/folders you want to transfer to your Digital Audio Player and drag them to the drive letter that is associated with it.



### Attention

Make sure all data are transferred to the Digital Audio Player before unplugging the USB connection.



### Attention

Some wma files may be DRM protected and they must be transferred to your player via music management software that supports Windows Media DRM such as Yahoo! Music Engine and Windows Media Player. You cannot listen to these protected files if transferred via Windows Explorer. For more information, go to [www.microsoft.com/windows/windowsmedia/drm](http://www.microsoft.com/windows/windowsmedia/drm)

## Profiling (Model Dependent)

Some models need to be profiled after file transfer. Profiling helps sort audio files on your player so that you can view in the navigation menus and play them properly.

Please check the player's user manual if this step is necessary on your player. Follow the instruction to profile your newly transferred files.

# Disconnecting the Player

## EN Disconnecting Your Player from the Computer

For Windows XP, from the System Tray, double click the left mouse button on the icon  and select *Safely Remove Hardware*. Select the drive corresponding to your player and click **STOP**.



The *Stop a Hardware device* screen appears. Select the device to be stopped again for confirmation and click **OK**.



You can also stop your player by left clicking on the  icon from the system tray and selecting the drive corresponding to your player.

Before disconnecting the USB connection from the computer or the Digital Audio Player, be sure the "Safe to Remove Hardware" message is displayed.



### Attention

If you want to go back to USB mode for file transfer at this stage, you need to unplug and connect the player to the PC again.



### Attention

Make sure all data are transferred to the Digital Audio Player before unplugging the USB connection.

The description on this page is based on Windows XP. If you are running other operating systems, there may be some differences. See the Windows Help for details about safely removing hardware.

# Troubleshooting Tips

EN

## Problem

After connecting the player to computer, "USB connected" does not appear on the display.

## Checkpoints / Action

- Make sure the device is powered on. Some players do not automatically come on when plugged into the computer.
- Make sure that the USB connections to the computer and device are securely in.

Cannot access the player via Windows 2000 computer.

- Install the Service Pack 3 for Windows 2000. Visit [www.windowsupdate.microsoft.com](http://www.windowsupdate.microsoft.com) to check for the latest updates.

Cannot playback tracks on the player.

- Make sure audio tracks are encoded in the mp3 or Windows Media formats at supported bitrates. Please check the player's user manual for bitrates supported.
- WMA files may be DRM protected and you don't have the proper rights (license) to play the files.

Check the website and/or application help system of the music download service provider from where the content was purchased from for license acquisition details.

For more information on how license acquisition works, go to [www.microsoft.com/windowsmedia/drm](http://www.microsoft.com/windowsmedia/drm)

What does the PlaysForSure logo mean? (available on certain models)

PlaysForSure is a new logo program from Microsoft®. Consumers can match the PlaysForSure logo on a large selection of devices and online music stores. If you see the logo, you'll know your digital media will play for sure.

For more information on the Microsoft PlaysForSure program, visit [www.PlaysForSure.com](http://www.PlaysForSure.com).

For more information on RCA PlaysForSure devices, visit [www.rca.com](http://www.rca.com).

---

**IMPORTADOR**

Comercializadora Thomson de México, S.A. de C.V.

Álvaro Obregón No. 151. Piso 13.

Col. Roma. Delegación Cuauhtémoc

C.P. 06700. México, D.F.

Telefono: 52-55-11-020360

RFC: CTM-980723-KS5

Thomson Inc.

P.O. Box 1976

Indianapolis, IN 46206-1976

© 2006 Thomson Inc.

Trademark(s) ® Registered

Marca(s) ® Registrada(s)

Marque(s) ® Déposé(e)

[www.rca.com](http://www.rca.com)

Printed In China / Impreso en China

TOCOM (v1.0)