

Philips GoGear audio video player

SA6125
SA6145
SA6185

Quick start guide



- 1 Install
- 2 Connect and Charge
- 3 Transfer
- 4 Enjoy

PHILIPS

Need help?

Please visit

www.philips.com/welcome

where you can access to a full set of supporting materials such as user manual, flash tutorial, the latest software upgrades and answers to frequently asked questions.

- 2 Is there a manual?
- 2 Register your product
- 2 Don't forget about upgrades
- 3 What's in the box
- 4 Overview of controls and connections
- 5 Install
- 5 Connect and charge
 - 5 Connect to PC
- 6 Transfer
 - 6 Transfer music and pictures with Windows Media Player 11
 - 7 Transfer videos
- 8 Enjoy
 - 8 Power on and play
 - 8 Main menu
 - 8 Navigate the menu
- 9 Music mode
- 9 Radio
 - 9 Auto tune
 - 10 Play a preset radio station and tune the station
- 10 Recordings
 - 10 Make recordings
 - 10 Play back recordings
- 11 Delete media
- 11 Troubleshooting
 - 11 How do I reset my player?
- 11 Need help?
- 11 Disposal of your old product

Is there a manual?

You have a detailed user manual and FAQ on the CD by-packed with your player. You can also download the same file from this website: www.philips.com/support

Register your product

Since it is possible for you to upgrade your product, we recommend that you register your product on www.philips.com/welcome so we can inform you as soon as new free upgrades become available.

Don't forget about upgrades

We know you will enjoy your product for a long time. For best performance, we recommend that you regularly check in to www.philips.com/support for free upgrades of the latest software and Firmware Manager for your product. These downloads will help you to optimize your product's performance and to take advantage of our future support of new audio formats.

Enjoy your new music experience.

What's in the box



Headphones



USB cable



CD-ROM



Quick start guide

What else you'll need?







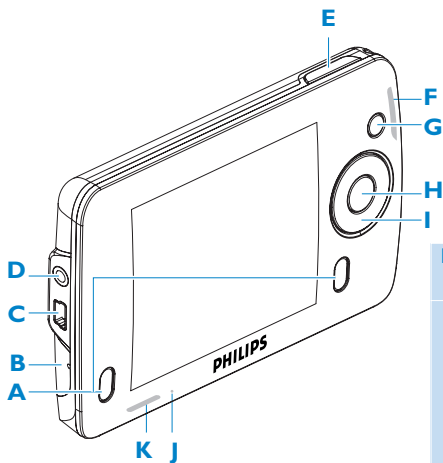

Computer

A computer with:
Windows XP (SP2 or above) or Vista
Pentium III 800MHz processor or higher
256MB RAM
200MB Hard Disk space
Internet connection (preferable)
Microsoft Internet Explorer 6.0 or later
CD-ROM drive
USB Port

Overview of controls and connections



A	Loud speaker	Active when no headphones connected
B	Microphone	For voice recordings
C		USB connector
D		Headphones jack
E	- Vol +	Control volume
F	PLAYLIST	Press to add songs to Playlist on the go
G	MENU	Press to access the menu / return to previous menu

H	 	Short press to play / pause songs / videos, long press to power on / off
I		Navigate back one menu level or exit a function During songs / videos / recordings playback, press to go to previous songs / videos / recordings, or press and hold to rewind
		Navigate forward one menu level or select a function During songs / videos / recordings playback, press to go to next songs / recordings, or press and hold to fast forward
		Scroll up in the list
		Scroll down in the list
J		Reset
K	Lock slider	Lock all keys except volume keys

1 Install

Important You need Windows XP Service Pack 2 to install and run this software. In case you do not have this on your PC, you will be asked to install the Service Pack. Please do install this, complete the rest of your software installation and only then connect your device.

This is critical to ensure the proper working of your player when connected to the PC.

- 1 Insert the CD supplied with your product into the CD ROM drive of your PC.
- 2 Follow the onscreen instructions to complete the installation of **Windows Media Player, Media Converter for Philips** and **Philips Device Manager**.
- 3 If the installation program does not start automatically, browse the CD contents via **Windows Explorer** and run the program by double clicking on the file ending with .exe.



2 Connect and charge

A Connect to PC

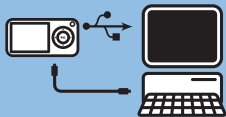

- 1 Turn on the player.
- 2 Connect the player to PC as shown.
 - > The screen of the player indicates the connection with PC.

3 Transfer

A Transfer music and pictures with Windows Media Player 11

Download Windows Media Player11:

<http://www.microsoft.com/windows/windowsmedia/player/11/default.aspx>



1 Start **Windows Media Player 11**.

2 Connect the player to your computer using the supplied USB cable.

3 Once the player is connected, the sync tab changes as shown (**Sync**) and the device and its contents become visible in **Windows Media Player 11**(see figure above).

4 **Windows Media Player 11** will automatically start synchronizing the contents of your music library to your player.

For details on how to set synchronization options in **Windows Media Player 11**, pls refer to the user manual.

B Transfer videos

- 1 Connect your player to the PC using the supplied USB cable.
- 2 Start **Media Converter for Philips**.

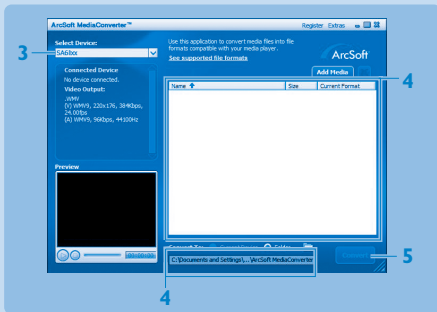

- 3 In the **Convert to:** option at the bottom of the screen, select **Current Device**, the content will be stored directly on the connected player.
- 4 Press **Add Media** to select the Video files to be transferred
OR
Drag and drop your video files from **Windows Explorer** into the white box shown.
- 5 Press **Convert**.

If needed, the files will first be converted to a format that the player can playback.
The conversion takes time and please be patient.







> All the converted files will be transferred to the player.

4 Enjoy

A Power on and play

To power on, press ►|| until the **PHILIPS** welcome screen appears.
To power off, press and hold ►|| until there is no display on the screen.

B Main menu

 Video	Watch your videos
 Picture	View your pictures
 Music	Play your digital music tracks
 Radio	Listen to FM radio
 Recording	Create or listen to recordings
 Settings	Customize the settings of your player
 Now playing	Go to the play screen
Last played	Resume play

C Navigate the menu

Your player has an intuitive menu navigation system to guide you through various settings and operations.

To	Do this
Return to previous menu	Press ◀ or MENU
Return to main menu	Press and hold MENU
Browse through menus	Press ◀ or ▶
Scroll through a list	Press ▲ or ▼
Selection an option	Press ▶

Music mode (also applicable to playback of recordings)

You can do the following actions during music playback:

To	Do this
Play / Pause music	Press
Skip to next song	Press
Return to previous song	Press
Fast forward	Press and hold

To	Do this
Fast rewind	Press and hold
Return to browsing	Press MENU key
Increase volume	Press Vol +
Decrease volume	Press Vol -

Radio

From the main menu, select to enter radio mode.

Connect the headphones

The supplied pair of headphones serves as a radio antenna. Make sure that it is properly connected to ensure optimal reception.

Select your FM region

From the main menu, select > **Radio settings**.

Region	Frequency range	Tuning steps
Europe	87.5 - 108 MHz	0.05 MHz
USA	87.5 - 108 MHz	0.1 MHz
Asia	87.5 - 108 MHz	0.05 MHz

Auto tune

1 Select **Auto tune** under Radio menu .

> *The player will search for the stations with the strongest signals and automatically save them up to 20 maximum of presets channel.*



Play a preset radio station and tune the station

- 1 From the Radio menu , select **Presets**.
- 2 Press ▲ or ▼ to browse and select the preset stations.
- 3 After you select a preset station, short press ◀ / ▶ can change to another preset stations.
- 4 You can also tune the frequency of selected preset station by long pressing ▲ / ▼.
- 5 Short press ▲ or ▼ to move one tuning step, long press ▲ or ▼ to search next nearest strongest signal.

Recordings

You can make voice recordings using your player.

Make recordings

- 1 From the main menu, select .
- 2 Select **Start recording** to start recording a voice.
> *Your player will display the voice recording screen and voice recording starts automatically.*
- 3 Press ▶|| to pause.
- 4 Press ◀ to stop and save the voice recording.
> *Your voice recording will be saved on your player. (Filename format: VOICEXXX.WAV where XXX is the recording number which will be automatically generated.)*
- 5 You can find this file under  > **Recordings Library**.

TIP You can pause and restart a recording anytime with ▶||.

Play back recordings

From the main menu, select  > **Recordings Library**.

- 1 Select the recording you want to hear.
- 2 Press ▶|| to confirm.

Delete media

You can delete music, videos and pictures via **Windows Explorer** on your computer.

Troubleshooting

How do I reset my player?

Insert a pin or a sharp object into the reset hole located at the bottom of the player to reset it. You will need to power on the player after resetting it.

Please refer to the user manual for more troubleshooting advice.

Need help?

User Manual

See the user manual that came with your player.

Online

Go to www.philips.com/welcome

Disposal of your old product



Your product is designed and manufactured with high quality materials and components, which can be recycled and reused.

When this crossed-out wheeled bin symbol is attached to a product it means the product is covered by the European Directive 2002/96/EC

Please inform yourself about the local separate collection system for electrical and electronic products.

Please act according to your local rules and do not dispose of your old products with your normal household waste. The correct disposal of your old product will help prevent potential negative consequences for the environment and human health.



Be responsible
Respect copyrights

Specifications are subject to change without notice.

Trademarks are the property of Koninklijke Philips Electronics N.V. or their respective owners

© 2007 Koninklijke Philips Electronics N.V.

All rights reserved.

www.philips.com



Printed in China

wk7332