



CPLM 9KE-B-410 12KE-B-410 15KE-B-410



PORTABLE AIR CONDITIONER

GB Portable air conditioner

www.amcorgroup.com

THANK YOU

Thank you for choosing this innovative Amcor air conditioner. We suggest that you keep this manual in a safe place for future reference. It describes the many benefits and advanced features this unique product has to offer. Before you use your new air conditioner you should carefully read these instructions to maximise this product's performance.

For over 50 years Amcor has specialised in complete indoor environmental control, manufacturing and marketing; dehumidifiers, portable air conditioners, coolers, air purifiers, ionisers and aroma therapy scent diffusers. These world class products incorporate the latest technological developments.

SAFETY INSTRUCTIONS

IMPORTANT!

- The unit is designed for indoor operation.
- Rating: This unit must be connected to a 220-240 V / 50 Hz earthed outlet.
- The installation must be in accordance with regulations of the country where the unit is used.

If you are in any doubt about the electrical installation, have it checked and if necessary modified by a qualified electrician.

- The air conditioner is safe. However, as with other electrical appliances, use it with care.
- Keep out of the reach of children.
- Do not clean the air conditioner by spraying it or immersing it in water.
- Do not insert any object into openings of the air conditioner.
- Disconnect it from the mains before cleaning the unit or any of its components.
- Never connect the unit to an electrical outlet using an extension cord. If an outlet is not available, one should be installed by a licensed electrician.
- Don't lift or move by pushing the air conditioner at the rear, but always at the front side.

WARNING

- Never operate this appliance if it has a damaged cord or plug. Do not lead the cord over sharp edges.
- A damaged supply cord should be replaced by the manufacturer, its service agent or a qualified person in order to avoid a hazard.
- Any service other than regular cleaning or filter replacement should be performed by an authorized service representative. Failure to do so could result in a loss of warranty.

Do not use your air conditioner under the following conditions:



If the power cable wires are frayed or cut



When small children may be left unattended

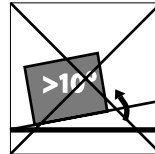

On a slope or uneven surface



Close to a naked flame



This product is not made for DIY repair



If there is a risk of liquid falling on the unit

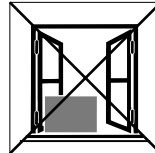

Inside unit exposed to the weather outdoors



Near water

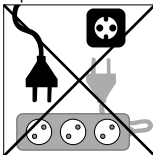

If an extension lead may become overloaded

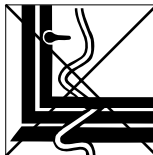

Where the power cable may be damaged



Where it may be damaged by chemicals

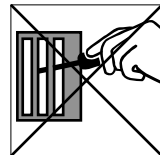

Where there is a risk of interference by foreign objects

PARTS

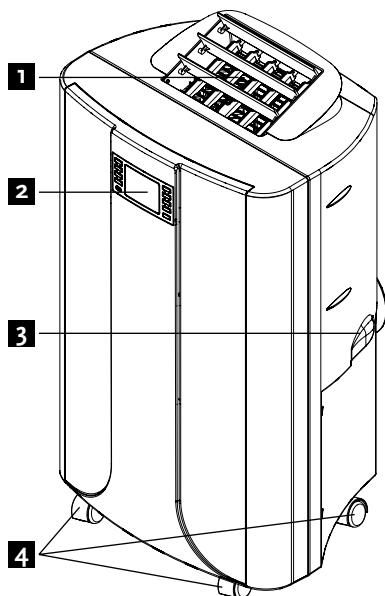

1. Air outlet
2. Control panel
3. Carrying handle
4. Caster wheels

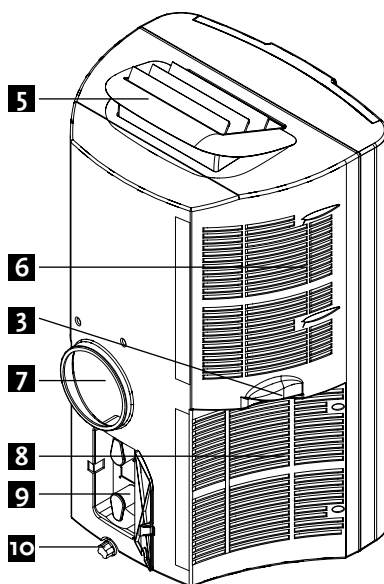

5. Grill housing
6. Upper air inlet
7. Exhaust air outlet
8. Lower air inlet
9. Cable storage
10. Drainage point with water stopper

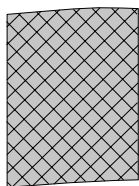

Active carbon filter

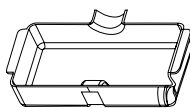
Remote control
with LCD

Water container

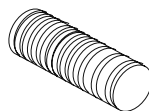

Exhaust hose



Slide bar connector

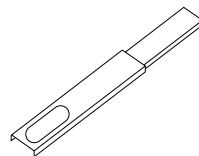

Telescopic slide bar

CONTROL PANEL

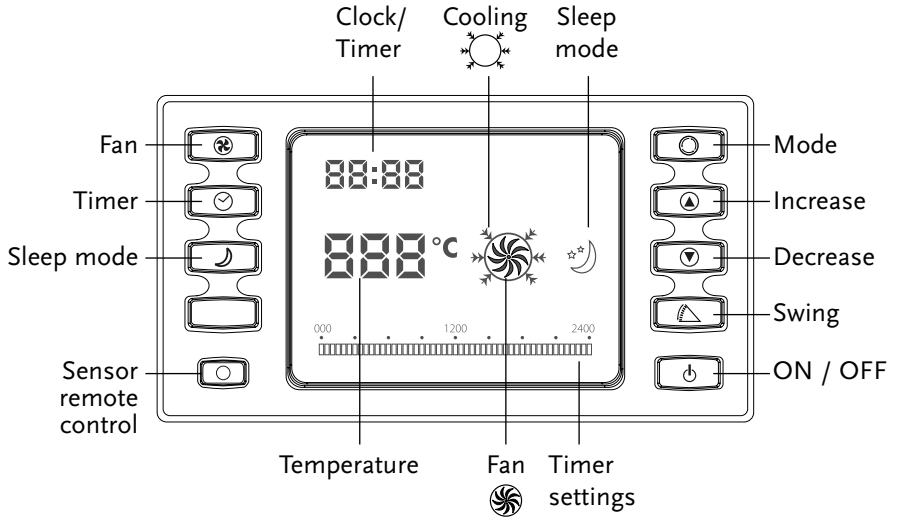

INSTALLATION

WARNING!

Before using the air conditioner it should be left in an upright position for at least 2 hours. This unit can easily be moved from one room to another.

In doing so keep this in mind:

- Ensure that the unit is positioned upright, on a level surface and 50 cm away from any obstacles.
- To place the loose filters in the filter holder.
 - Take the filter holder out of the air conditioner.
 - Open the filter holder and place the active carbon filter (black) in the filter holder.
 - Place the filter fixing component back in the holder.
 - Place the filter holder back in the air conditioner.
- Do not operate the unit inside the bathroom, shower, or in any other very humid environment.
- Connect the hose to the unit by turning it clockwise (at least 5 turns).
- Similarly, connect the hose to the slide bar connector as far as possible.
- Place the telescopic slide bar in the open window or door and adjust the length to fill as much open space as possible.
- Put the slide bar connector in the opening in the telescopic slide bar.
- Close the window or door as much as possible to prevent outside air entering the room.
- Ensure that the slide bar connector has a free flow outside.

IMPORTANT!







The flexible exhaust hose can be extended from 500 to 1500 mm for mounting. This length has been designed especially according to the specifications of the air conditioner. **Do not use an extension or exchange for a different hose as that may lead to malfunctioning.** The exhaust air must flow freely, any blockage can lead to overheating of the air conditioner. Take care to prevent any sharp bow or bend in the exhaust.

OPERATION



ON/OFF

Press  to switch the unit on or to switch off. A buzzer will beep, and the LCD will display 12:00 o'clock as default.

Setting the clock

Press the -button for 3 seconds to set the clock. The 2 left digits of the 4 digits on the LCD-display will flash. Press  or  to adjust the hour. Press  momentarily, the 2 right digits of the 4 digits will flash. Press  or  to adjust the minutes of the clock. Press the -button for 3 seconds again to activate the clock.

Setting the temperature



If you want to change the set temperature press the  or -button. The 2 digit display will indicate the set temperature.

Note: Reaching the set temperature depends on the room and outdoor climatic conditions.

Mode

Pressing the -button to switch the operating mode between 'cooling' and 'fan only'.







Fan speed

If you prefer a constant fan speed instead of the auto fan speed, press the -button successively; the fan speed icon  on the LCD-display will rotate accordingly.

- Fast - for the turbo speed
- Normal - for the medium speed
- Slow - for the slow speed
- Auto - alternating fast and slow speed

Timer

For all of the following TIMER programming, proceed firstly with these standard steps:

- Press the -button briefly; the 2 left digits of the 4 digits on the LCD display are flashing.
- Press  or  to adjust the hour.
- Press the -button briefly again, the 2 right digits of the 4 digits are flashing.
- Press  or  to adjust the minutes of the clock in intervals of 5 minutes. The timer is set. After 10 seconds the time display returns.

The timer settings are visualised along the bottom of the display.



Timer setting example

Programming the timer for ON - when the unit is OFF.

- Perform the standard steps as described above.

The linear time scale will be on between the ON programmed times until 24:00.

The flashing bar on the time scale indicates the real time and moves a segment ahead every 30 minutes until it reaches the ON timer time, then the black segments in the linear time scale will disappear.

Programming the timer for OFF - when the unit is RUNNING.

- Perform the standard steps as described above.

The linear time scale will be on between the present time to the OFF programmed time.

The flashing bar on the time scale indicates the real time and moves a segment ahead every 30 minutes until it reaches the OFF timer time, then the black segments in the linear time scale will disappear.

Repeated OFF and ON**Programming the timer for repeat OFF and ON - when the unit is RUNNING.**

- Perform the standard steps as described above.
- Repeat the above procedure while the digits are still flashing for setting the ON.

The linear time scale will be ON between 00:00 to the time set with the timer to OFF and from the ON time until 24:00. The flashing bar on the time scale indicates the real time and moves a segment ahead every 30 minutes. The unit will operate daily according to the timer setting.

Repeated ON and OFF**Programming the timer for repeat ON and OFF - when the unit is NOT RUNNING.**

- Perform the standard steps as described above.
- Repeat the above procedure while the digits are still flashing for setting the OFF.

The linear time scale will be OFF between 00:00 to the time set with the timer to ON and from the OFF time until 24:00. The flashing bar on the time scale indicates the real time and moves a segment ahead every 30 minutes. The unit will operate daily according to the timer setting.

After a power failure, or after the unit has been unplugged, you will have to program the timer settings again.

Cancelling the timer function

In order to cancel the timer programming press the ☺-button momentarily, then it will return to the time display. The daily mode will be cancelled as well. The black segments in the linear time scale will disappear.



LCD blue back light

In order to switch off the blue back light, press the ▲- and ▼-buttons at the same time. The blue back light will blink twice and goes off after three seconds.

By pushing any of the buttons the blue back light will come on again.

Air flow

On the moment the air conditioner is connected to the mains, the louvres open and close and stay closed.

- When the ON-button is pressed, the louvres open to maximum and return to an angle of 75° above the upper plane of the louvres housing.
- Press the -button, the louvres will swing continuously up and down between 30° and 80° above the upper plane of the louvres housing.
- By pressing the -button again the movement will stop and the louvres remain in that position. The direction of the air flow is then constant.
- When the OFF-button is pressed, the louvres close.

This way of directing the air flow is particularly convenient when using the remote control: a user friendly approach to your comfort.

In order to direct the air flow to a lower angle, raise the louvres housing by pulling it up only by the centre of its back rim.

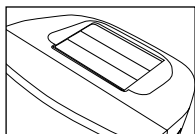

Air outlet down,
louvres closed

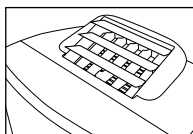

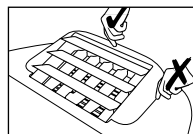

Air outlet up,
louvres opened



Raising the
louvres housing.

Sleep mode

The sleep mode function adjusts the set temperature of the unit to the thermal needs of the body falling asleep as follow:

- Default fan speed: LOW
- Press the -button to operate the sleep mode. Press the -button again in order to cancel the sleep mode.
The set temperature will increase 1°C after 1 hour and a further 1°C after 2 hours.
- No FAN mode under SLEEP mode operation.

Dehumidification

If the unit will be used mainly as a dehumidifier just let the warm air return in the room. Continuous drainage (see separate chapter) is then necessary and more efficient.

REMOTE CONTROL

The unit responds to all signals that are sent by the remote control. There will be a beep sound from the unit after receiving the signal. The operation of the unit by remote control, is almost identical to the operation by the control panel. The only exception is the clock function.

Instead of the ☺-button for setting the actual time and for programming the timer, there are 3 push buttons on the remote control as follows:

- ☺ - for setting the actual time.
- TIMER ON - for programming the time when the unit is ON.
- TIMER OFF - for programming the time when the unit is OFF.

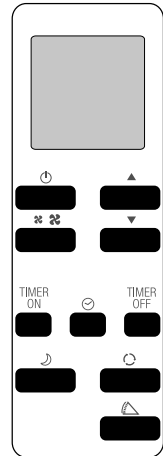

AIR FILTERS

This air conditioner is equipped with two filter sets:

1. A multi layer filter in the upper air inlet, to clean the circulated room air, which includes
 - a. A screen filter, to remove dust particles.
 - b. An active carbon filter, to remove odours.
2. A screen filter in the lower air inlet, to remove dust particles.

NOTE! The active carbon filter is delivered in a plastic packaging. Don't forget to install it.

Cleaning the air filters

- a. The screen filters in the upper and lower air inlet should be cleaned regularly by rinsing them under running water.
- b. The active carbon filter can be cleaned with a vacuum cleaner when dusty, but has to be changed every 3 months.

Filter installation

- Slide out the filter frame from the unit.
- Separate the filter fixer from the filter frame (see fig. 1).
- Remove the active carbon filter (black) from its plastic bag.
- Insert the active carbon filter into the filter frame (see fig. 2).
- Fix the filter by reassembling the fixer into the filter frame (see fig. 3)

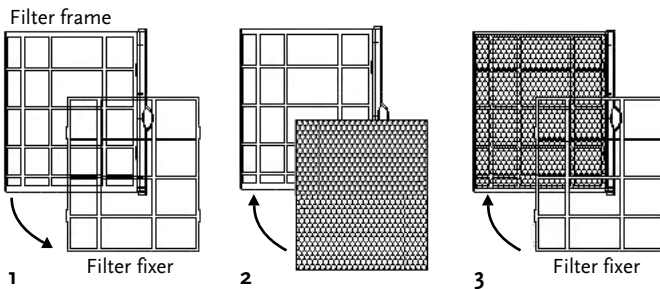

NOTE!

- Remove the active carbon filter before seasonal storage and install new filters at the beginning of the new season. The old filters can be disposed in the 'Non-biological garbage container'.
- Replacement filter packages are available directly from Amcor.
- To run the unit without active carbon filter does not do any harm to the air conditioner. In this case odours are not removed from the circulated air.
- **The screen filter must always be used.**

EMPTYING THE INTERNAL WATER CONTAINER

Under high humidity conditions it may be necessary to empty the internal water container. When the internal water container is full the backlight on the LCD-display flashes. The unit will switch off automatically.

To empty the water container do the following:

- Switch off the unit and remove the plug from the wall socket.

Do not move the unit. Doing this can result in water leakage, damaging your floor or carpet.

- Place the water container on the floor underneath the permanent drainage point.
- Remove the water stopper and rubber plug from the drain and let the water run out. The water container has to be emptied several times before all water will be drained (ca. 1.5 litres).
- Replace the rubber plug and water stopper, put the plug into the wall socket, and switch the unit on. The warning signal should be off.

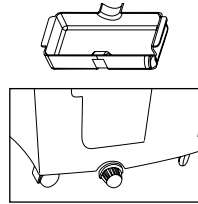
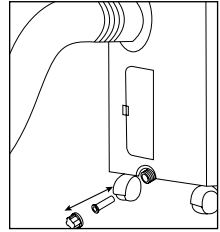

NOTE! When the air conditioner is in use, under normal circumstances the condensed water will evaporate and then be discharged through the hot air outlet hose.

CONTINUOUS DRAINAGE

- Switch off the unit and remove the plug from the mains.
- Remove the water stopper and rubber plug.
- Connect a drain tube (\varnothing 20 mm inner dimension) onto the water outlet and extend with extra water tube if needed.
- Place the other end in a normal drain. Make sure that the tube is free from twists and bends. The tube must decline over its entire length.

CLEANING

WARNING! First of all switch off the unit and remove the plug from the wall socket.

Clean the housing with a soft, damp cloth. Never use aggressive chemicals, petrol, detergents or other cleansing solutions.

Clean the screen filter regularly with a vacuum cleaner. See also “air filter” section.

NOTE! Never use the air conditioner without the screen filter.

STORAGE

- Empty the internal water container.
- Clean the screen filter.
- Remove the active carbon filter before end of season storage and install new filters at the beginning of the new season.
- The old filters can be disposed of in the 'Non-biological rubbish container'.
Replacement filter packages are available from Amcor.
- Put the unit in Fan Only mode for a few hours to ensure that the inside becomes completely dry.
- Store the cable as shown.

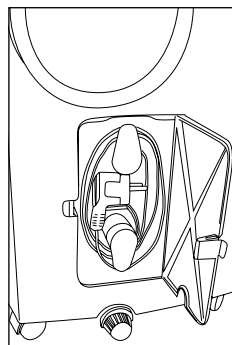

Protect the unit against dust and store in a dry place, not accessible to children.

TROUBLE SHOOTING

Never try to repair or dismantle the air condition yourself. Incompetent repairs result in loss of warranty and can endanger the user and the property.		
Problem	Cause	Solution
The air conditioner does not function.	No power supply.	Connect to a functioning outlet and switch on.
	Is the LCD light flashing.	Empty the internal water container.
	Timer function is active.	Deactivate TIMER function.
The air conditioner does not seem to perform.	In direct sunlight.	Close curtains.
	Windows or doors open, many people or a heat source in the room.	Close doors and windows, place an extra air conditioner.
	Dirty filter.	Clean or replace the filter(s).
	Air inlet or air outlet blocked.	Remove the blockage.
	Room temperature lower than the selected value.	Change temperature selection.
The unit is noisy.	Unit stands uneven.	Place on an even, solid surface (less vibrations).
The compressor does not work.	The overheat protection is probably activated.	Wait 3 minutes until the temperature has decreased, then turn on the unit again.
The remote control does not function.	Distance too great.	Make sure the remote control is correctly aimed at the control panel.
	Remote control signal not detected by the control panel.	
	The batteries are drained.	Replace the batteries.
To correct problems that have not been described in the table and/or if the recommended solutions fail to solve the problem, contact an authorized service centre.		

TECHNICAL DATA

Model		CPLM 9KE-B-410	CPLM 12KE-B-410	CPLM 15KE-B-410
Cooling capacity measured conform EN 14511	BTU/h	7500	9900	11300
	kW	2.2	2.9	3.3
Power consumption	kW	0.77	0.99	1.36
Current	A	3.4	4.3	5.9
Mains	V / Hz / Ph	220 – 240 / 50 / 1		
Fan speeds		3		
Thermostatic range	°C	18 – 32		
Protection class		IP 21		
Refrigerant	type	R410A		
Refrigerant load	g	420	500	630
Dimensions (w x h x d)	mm	500 x 840 x 415		
Net weight	kg	33.1	34.3	39.3
<p>CPLM 9KE-B-410 series can be connected only to a supply with system impedance no more than 0.383 Ohm. CPLM12KE-B-410 series can be connected only to a supply with system impedance no more than 0.247 Ohm. CPLM15KE-B-410 series can be connected only to a supply with system impedance no more than 0.110 Ohm. If necessary, please consult your supply authority for system impedance information. Subject to modifications without prior notice. For greater precision, please refer to the rating label placed on the product.</p>				



Reminder:

Waste electrical products must not be disposed of with household waste.
 This product should be taken to your local recycling centre for safe treatment.

Hong Kong

Amcors Ltd
Suite 2007, Tower 6, The Gateway,
Harbour City, 9 Canton Road,
Tsim Sha Tsui, Kowloon,
Hong Kong
Tel: +852 2997 6865
Fax: +852 2997 6091
Email: amcorhk@amcorgroup.com

United Kingdom

Amcors Ltd
9 Ryan Drive, West Cross Centre,
Great West Road, Brentford,
Middlesex, TW8 9ER,
United Kingdom
Tel: +44 20 8560 4141
Fax: +44 20 8232 8814
Email: amcoruk@amcorgroup.com

USA

Amcors Inc.
685A Gotham Parkway, Carlstadt,
New Jersey 07072,
United States of America
Tel: +1 201 460 8100
Fax: +1 201 460 9481
Email: amcorusa@amcorgroup.com

The Netherlands

Amcors B.V.
Anton Philipsweg 9-11,
1422 AL Uithoorn,
The Netherlands
Tel: +31 297 560 079
Fax: +31 297 523 062
Email: amcorex@amcorgroup.com

Israel

Amcors International Ltd
1 Sapir St.,
P.O. Box 12001
Hertzeliya Pituach,
Israel
Tel: +972 9951 5351
Fax: +972 9958 5650
Email: amcoril@amcorgroup.com

Singapore

Amcors Investments (Singapore) Pte Ltd
545 Orchard Road,
#13-02, Far East Shopping Centre,
Singapore 238882
Tel: +65 6297 9881
Fax: +65 6297 8891
Email: amcorsg@amcorgroup.com

China

Shan Xia Industrial Development Zone,
Heng Li Town, Dongguan City,
Guangdong Province, China

Plant One - Amcor (China) Ltd

Tel: +86 769 8372 1090
Fax: +86 769 8372 1790
Email: amcorcn@amcorgroup.com

Plant Two - Amcor Appliances Ltd

Tel: +86 769 8372 1970
Fax: +86 769 8372 1790
Email: amcorappl@amcorgroup.com

