

Register your product and get support at  
[www.philips.com/welcome](http://www.philips.com/welcome)

**GoGear**

SA2MUS08

SA2MUS16

SA2MUS32



---

EN User manual

---

**PHILIPS**

# Contents

<b>1 Important safety information</b>	<b>3</b>		
General maintenance	3		
Recycling the product and the built-in battery	6		
<b>2 Your new MUSE</b>	<b>8</b>		
What's in the box	8		
<b>3 Getting started</b>	<b>9</b>		
Overview of the controls and connections	9		
Lock the touch controls	9		
Limit the volume	9		
Overview of the home menu	10		
Organize the home menu	10		
Connect and charge	11		
Connect MUSE to a computer	11		
Install Philips Songbird for the first time	11		
Install the Philips Songbird software again (after the first installation)	12		
Battery level indication	12		
Software loaded on the MUSE	12		
Files loaded on the MUSE	12		
<b>4 Update MUSE</b>	<b>13</b>		
Manually verify / update the firmware	13		
<b>5 Turn MUSE on and off</b>	<b>14</b>		
Automatic shut-down	14		
<b>6 Philips Songbird</b>	<b>15</b>		
Build a media library	15		
Rip a CD	15		
Set up the CD rip options	15		
Import media files from a directory	15		
Import media from iTunes	15		
Export media to iTunes	16		
Get content from online sources	16		
Import recordings from MUSE	16		
Browse your media library	16		
Organize and manage your Songbird library	16		
Let Songbird manage your media library	16		
Remove media files from the Songbird media library	17		
Delete media	17		
Let Songbird watch a folder	17		
Fetch album artwork	17		
Playlists	17		
Create a playlist	18		
Add titles to a playlist	18		
Remove titles from a playlist	18		
Change the look of the Songbird library	18		
Format MUSE (erase all music and data)	18		
Repair MUSE (restore factory settings)	19		
<b>7 Music</b>	<b>20</b>		
Add music to MUSE	20		
Overview of the music controls	20		
Browse music albums	20		
Listen to music	20		
Customize the music library view	21		
Delete the currently playing music track	21		
Delete one or more music tracks	21		
<b>8 Audiobooks</b>	<b>22</b>		
Add audiobooks to MUSE	22		
Overview of the audiobook controls	22		
Browse audiobooks	22		
Listen to audiobooks	23		
Customize the audiobook library view	23		
<b>9 Video</b>	<b>24</b>		
Add videos to MUSE	24		
Overview of the video controls	24		
Browse video albums	24		
Play videos	24		
Play videos on your HD TV	25		
Customize the video library view	25		
Delete the currently playing video	26		
Delete one or more videos	26		

---

<b>10 Pictures</b>	27
Add pictures to MUSE	27
Overview of the picture controls	27
Browse picture albums	27
View pictures	27
Advanced picture display	28
View pictures on your TV	28
Delete the currently displayed picture	28
Delete one or more pictures	28

---

<b>11 Radio</b>	29
Listen to FM radio	29
Auto-tune radio station presets	29
Manually tune a radio station	29

---

<b>12 Recordings</b>	30
Record audio/voices	30
Listen to recordings	30
Upload your recordings to a computer	30
Delete the currently playing recording	30
Delete one or more recordings	31

---

<b>13 SD Card</b>	32
Insert an SD card	32
Import files from a Micro SD card	32
Access files on a Micro SD card	32

---

<b>14 Text reader</b>	33
Read text files	33

---

<b>15 Use the MUSE to carry data files</b>	34
--	----

---

<b>16 Settings</b>	35
--------------------	----

---

<b>17 Technical data</b>	37
System requirements	37

---

<b>18 Glossary</b>	38
--------------------	----

### **Need help?**

Please visit

**[www.philips.com/welcome](http://www.philips.com/welcome)**

where you can access a full set of supporting materials such as the user manual, the latest software updates, and answers to frequently asked questions.

# 1 Important safety information

## General maintenance

The translation of this document is for reference only.

In the event of any inconsistency between the English version and the translated version, the English version shall prevail.

### Caution

- To avoid damage or malfunction:
- Do not expose the product to excessive heat caused by heating equipment or direct sunlight.
- Do not drop the product or allow objects to fall on your player.
- Do not allow the product to be submerged in water: Do not expose headphone socket or battery compartment to water, as water entering the set may cause major damage.
- Active mobile phones in the vicinity may cause interference.
- Back up your files. Ensure that you retain the original files you have downloaded to your device. Philips is not responsible for any loss of data if the product becomes damaged or not readable / legible.
- Manage (transfer, delete, etc.) your music files only with the supplied music software to avoid problems.
- Do not use any cleaning agents containing alcohol, ammonia, benzene, or abrasives as these may harm the product.

### About operating and storage temperatures

- Operate in a place where temperature is always between 0 and 35°C (32 to 95°F)
- Store in a place where temperature is always between -20 and 45°C (-4 to 113°F).
- Battery life may be shortened in low temperature conditions.

### Replacement parts/accessories:

Visit [www.philips.com/support](http://www.philips.com/support) to order replacement parts/accessories.

## Hearing Safety



### Listen at a moderate volume:

Using headphones at a high volume can impair your hearing. This product can produce sounds in decibel ranges that may cause hearing loss for a normal person, even for exposure less than a minute. The higher decibel ranges are offered for those that may have already experienced some hearing loss.

Sound can be deceiving. Over time your hearing 'comfort level' adapts to higher volumes of sound. So after prolonged listening, what sounds 'normal' can actually be loud and harmful to your hearing. To guard against this, set your volume to a safe level before your hearing adapts and leave it there.

To establish a safe volume level:

Set your volume control at a low setting. Slowly increase the sound until you can hear it comfortably and clearly, without distortion. Listen for reasonable periods of time: Prolonged exposure to sound, even at normally 'safe' levels, can also cause hearing loss. Be sure to use your equipment reasonably and take appropriate breaks.

Be sure to observe the following guidelines when using your headphones.

Listen at reasonable volumes for reasonable periods of time.

Be careful not to adjust the volume as your hearing adapts.

Do not turn up the volume so high that you can't hear what's around you.

You should use caution or temporarily discontinue use in potentially hazardous situations.

Do not use headphones while operating a motorized vehicle, cycling, skateboarding, etc.; it may create a traffic hazard and is illegal in many areas.

## Modifications

Modifications not authorized by the manufacturer may void user's authority to operate the product.

## Copyright information

All other brands and product names are trademarks of their respective companies or organizations.

Unauthorized duplication of any recordings whether downloaded from the Internet or made from audio CDs is a violation of copyright laws and international treaties.

The making of unauthorized copies of copy-protected material, including computer programs, files, broadcasts and sound recordings, may be an infringement of copyrights and constitute a criminal offense. This equipment should not be used for such purposes.

The Windows Media and the Windows logo are registered trademarks of Microsoft Corporation in the United States and/or other countries.

## Be responsible! Respect copyrights.



Philips respects the intellectual property of others, and we ask our users to do the same. Multimedia content on the internet may have been created and/or distributed without the original copyright owner's authorization.

Copying or distributing unauthorized content may violate copyright laws in various countries including yours.

Compliance with copyright laws remains your responsibility.

The recording and transfer to the portable player of video streams downloaded to your computer is intended only for use with public domain or properly licensed content. You may only use such content for your private, non-commercial use and shall respect eventual copyright instructions provided by the copyright

owner of the work. Such instruction may state that no further copies shall be made. Video streams may include copy protection technology that prohibits further copying. For such situations the recording function will not work and you will be notified with a message.

## Data logging

Philips is committed to improving the quality of your product and enhancing the Philips user experience. To understand the usage profile of this device, this device logs some info / data to the non-volatile memory region of the device. These data are used to identify and detect any failures or problems you as a user may experience while using the device. The data stored, for example, will be the duration of playback in music mode, duration of playback in turner mode, how many times battery low was encountered, etc. The data stored do not reveal the content or media used on the device or the source of downloads. The data stored on the device are retrieved and used ONLY if the user returns the device to the Philips service center and ONLY to simplify error detection and prevention. The data stored shall be made available to user on user's first request.

## Monkey's Audio decoder

- ① The Monkey's Audio SDK and source code can be freely used to add APE format playback, encoding, or tagging support to any product, free or commercial. Use of the code for proprietary efforts that don't support the official APE format require written consent of the author.
- ② Monkey's Audio source can be included in GPL and open-source software, although Monkey's Audio itself will not be subjected to external licensing requirements or other viral source restrictions.
- ③ Code changes and improvements must be contributed back to the Monkey's

Audio project free from restrictions or royalties, unless exempted by express written consent of the author.

- ④ Any source code, ideas, or libraries used must be plainly acknowledged in the software using the code.
- ⑤ Although the software has been tested thoroughly, the author is in no way responsible for damages due to bugs or misuse.

If you do not completely agree with all of the previous stipulations, you must cease using this source code and remove it from your storage device.

### FLAC decoder

Copyright (C) 2000,2001,2002,2003,2004,2005,2006,2007,2008,2009 Josh Coalson

Redistribution and use in source and binary forms, with or without modification, are permitted provided that the following conditions are met:

- Redistributions of source code must retain the above copyright notice, this list of conditions and the following disclaimer.
- Redistributions in binary form must reproduce the above copyright notice, this list of conditions and the following disclaimer in the documentation and/or other materials provided with the distribution.
- Neither the name of the Xiph.org Foundation nor the names of its contributors may be used to endorse or promote products derived from this software without specific prior written permission.

THIS SOFTWARE IS PROVIDED BY THE COPYRIGHT HOLDERS AND CONTRIBUTORS "AS IS" AND ANY EXPRESS OR IMPLIED WARRANTIES, INCLUDING, BUT NOT LIMITED TO, THE IMPLIED WARRANTIES OF MERCHANTABILITY AND FITNESS FOR A PARTICULAR PURPOSE

ARE DISCLAIMED. IN NO EVENT SHALL THE FOUNDATION OR CONTRIBUTORS BE LIABLE FOR ANY DIRECT, INDIRECT, INCIDENTAL, SPECIAL, EXEMPLARY, OR CONSEQUENTIAL DAMAGES (INCLUDING, BUT NOT LIMITED TO, PROCUREMENT OF SUBSTITUTE GOODS OR SERVICES; LOSS OF USE, DATA, OR PROFITS; OR BUSINESS INTERRUPTION) HOWEVER CAUSED AND ON ANY THEORY OF LIABILITY, WHETHER IN CONTRACT, STRICT LIABILITY, OR TORT (INCLUDING NEGLIGENCE OR OTHERWISE) ARISING IN ANY WAY OUT OF THE USE OF THIS SOFTWARE, EVEN IF ADVISED OF THE POSSIBILITY OF SUCH DAMAGE.

### © 2009, Xiph.Org Foundation

Redistribution and use in source and binary forms, with or without modification, are permitted provided that the following conditions are met:

- Redistributions of source code must retain the above copyright notice, this list of conditions and the following disclaimer.
- Redistributions in binary form must reproduce the above copyright notice, this list of conditions and the following disclaimer in the documentation and/or other materials provided with the distribution.
- Neither the name of the Xiph.org Foundation nor the names of its contributors may be used to endorse or promote products derived from this software without specific prior written permission.

This software is provided by the copyright holders and contributors "as is" and any express or implied warranties, including, but not limited to, the implied warranties of merchantability and fitness for a particular purpose are disclaimed. In no event shall the foundation or contributors be liable for any direct, indirect, incidental, special, exemplary, or consequential damages (including, but not limited to, procurement of substitute goods or services; loss of use, data,

or profits; or business interruption) however caused and on any theory of liability, whether in contract, strict liability, or tort (including negligence or otherwise) arising in any way out of the use of this software, even if advised of the possibility of such damage

### XPAT XML Parser

Copyright (c) 1998, 1999, 2000 Thai Open Source Software Center Ltd

Permission is hereby granted, free of charge, to any person obtaining a copy of this software and associated documentation files (the "Software"), to deal in the Software without restriction, including without limitation the rights to use, copy, modify, merge, publish, distribute, sub-license, and/or sell copies of the Software, and to permit persons to whom the Software is furnished to do so, subject to the following conditions:

The above copyright notice and this permission notice shall be included in all copies or substantial portions of the Software.  
THE SOFTWARE IS PROVIDED "AS IS", WITHOUT WARRANTY OF ANY KIND, EXPRESS OR IMPLIED, INCLUDING BUT NOT LIMITED TO THE WARRANTIES OF MERCHANTABILITY, FITNESS FOR A PARTICULAR PURPOSE AND NON-INFRINGEMENT. IN NO EVENT SHALL THE AUTHORS OR COPYRIGHT HOLDERS BE LIABLE FOR ANY CLAIM, DAMAGES OR OTHER LIABILITY, WHETHER IN AN ACTION OF CONTRACT, TORT OR OTHERWISE, ARISING FROM, OUT OF OR IN CONNECTION WITH THE SOFTWARE OR THE USE OR OTHER DEALINGS IN THE SOFTWARE.

## Recycling the product and the built-in battery

Your product is designed and manufactured with high quality materials and components, which can be recycled and reused.

Never dispose of your product with other household waste. Please inform yourself about the local rules on the separate collection of electrical and electronic products and batteries. The correct disposal of these products helps prevent potentially negative consequences on the environment and human health. Please visit [www.recycle.philips.com](http://www.recycle.philips.com) for additional information on a recycling center in your area.



### Caution

- Removal of the built-in battery invalidates the warranty and can destroy the product.



### Notice for the USA

This equipment has been tested and found to comply with the limits for a Class B digital device, pursuant to part 15 of the FCC Rules. These limits are designed to provide reasonable protection against harmful interference in a residential installation. This equipment generates, uses, and can radiate radio frequency energy and, if not installed and used in accordance with the instruction manual, may cause harmful interference to radio communications. However, there is no guarantee that interference will not occur in a particular installation. If this equipment does cause harmful interference to radio or television reception, which can be determined by turning the equipment off and on, the user is encouraged to try to correct the interference by one or more of the following measures:

- Relocate the receiving antenna.
- Increase the separation between equipment and receiver.

- Connect the equipment into an outlet on a circuit different from that to which the receiver is connected.
- Consult the dealer or an experienced radio/TV technician for help.

**Notice for Canada**

This Class B digital apparatus complies with Canadian ICES-003.

The set complies with the FCC-Rules, Part-15 and with 21 CFR 1040.10. Operation is subject to the following two conditions:

- This device may not cause harmful interference, and
- This device must accept any interference received, including interference that may cause undesired operation.



## 2 Your new MUSE

Use MUSE to

- play music
- view pictures
- watch videos
- listen to FM radio
- make recordings
- read texts

---

### What's in the box

Check that you have received the following items:

Player



Earphones

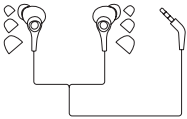

USB cable



Quick start guide



#### Note

- The images serve as reference only. Philips reserves the right to change color/design without notice.

## 3 Getting started

### Overview of the controls and connections

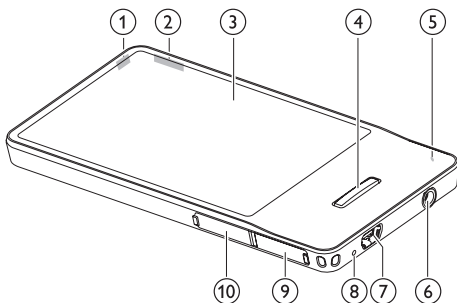

①		press and hold: turn MUSE on/off
②	+ / -	press: increase/decrease the volume press and hold: increase/decrease the volume quickly
③		display
④		return to home menu
⑤	MIC	microphone
⑥		headphone jack
⑦		USB jack
⑧	RESET	reset the MUSE
⑨	HDMI	HDMI jack
⑩	MICRO SD	Micro SD slot

#### Tip

- For more detailed information on mode-specific controls, please refer to the overviews at the beginning of the mode chapters in this user manual (Music, Video, etc.)

### Lock the touch controls

You can lock the touch controls of MUSE:

- 1 Press to lock the touch controls.
  - ↳ The screen turns off.
  - ↳ All touch controls are locked (the volume controls still function).
- 2 To turn the screen back on, press one of these buttons:
  - 
  -
- 3 Use your finger to swipe the vertical locking bar on the screen to unlock the touch controls.
  - ↳ All touch controls are unlocked.

### Limit the volume



#### Caution

- Listening to loud sounds for longer than a moment can be harmful to the listener.





You can set the volume level of MUSE to limit the maximum volume output.

- 1 While you listen to music, tap and then select **[Volume limit]**.
- 2 Use your finger to slide the volume control marker along the bar on the screen to adjust the level.
  - ↳ When you set a volume limit, MUSE can no longer exceed the set volume, even if you press the button to increase the volume **+**.







To enable maximum volume again:

- 1 While you listen to music, tap and then select **[Volume limit]**.
- 2 Use your finger to slide the volume control marker along the bar on the screen to maximum.

## Overview of the home menu

Main features	Mode	To
	Music	play digital audio tracks
	Video	play videos
	Pictures	view pictures
	FM radio	listen to FM radio

Extra features	Mode	To
	Recordings	create or listen to recordings
	Audible	listen to audiobooks
	Text	read text files
	Folder	view files in folders
	Settings	customize the settings of MUSE
	Rhapsody <sup>1</sup>	listen to your Rhapsody channels
	Micro SD card <sup>1</sup>	view Micro SD card contents

### Note

- <sup>1</sup> Rhapsody becomes part of the menu after you connect MUSE to a computer that has the Rhapsody software installed. Rhapsody channels services require an active Rhapsody account and are available in some regions only.
- <sup>2</sup> Micro SD card becomes part of the menu after you insert a Micro SD card into the Micro SD card slot.

## Organize the home menu

On the home menu, the four main features are at the top and extra features are at the bottom. By swapping the locations of corresponding icons, you can re-organize the home menu for ease of use.

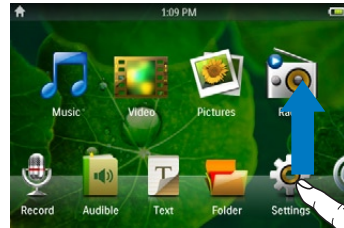

### To swap the locations of two icons,

- 1 Check the locations of the icon:
  - one icon at the bottom, and the other at the top;
  - or, both icons at the bottom.
- 2 Tap and hold one of the icons to unlock.
  - **If necessary, tap and hold the icon at the bottom.**
    - ↳ The screen dims.
- 3 Drag the icon over the other.
- 4 Release the icon.
  - ↳ The locations of the two icons are swapped.
  - ↳ The screen returns to normal brightness.

## Connect and charge

MUSE has a built-in battery that can be charged through the USB port of a computer (USB cable included).

### Note

- When you connect MUSE to a computer, you are briefly prompted to select:
- **[Charge & transfer]** or **[Charge & play]**.
- MUSE automatically applies **[Charge & transfer]**, if no new selection is made.

## Connect MUSE to a computer

- 1 Connect the USB plug of the supplied USB cable to a spare USB port on your computer.
- 2 Connect the small USB plug of the USB cable to the small USB jack on MUSE.
- 3 Turn on your computer.  
↳ MUSE charges.

## Install Philips Songbird for the first time

When you connect MUSE to the PC for the first time, a pop-up window appears:

- 1 Select **Install Philips Songbird**.
- 2 Follow the on-screen instructions to complete the installation.

### Note

- The installation requires you to agree to the license terms.

If the pop-up window is not displayed automatically:

- 1 Select **My Computer** (Windows XP / Windows 2000) / **Computer** (Windows Vista / Windows 7).
- 2 Right click on the **Philips GoGear MUSE** icon.
- 3 Select **Install Philips Songbird (Setup.exe)**.
- 4 Follow the on-screen instructions to complete the installation.

### Note

- The installation requires you to agree to the license terms.

---

## Install the Philips Songbird software again (after the first installation)

### Important!

The Philips Songbird software installer is preloaded to MUSE.

To free memory capacity for your media content on MUSE, the installer file is automatically deleted during the first installation process.





If you want to install the software any time after the first installation, follow these instructions:

- 1 Connect MUSE to the computer.
- 2 Ensure that the computer is connected to the Internet, and then open Windows Explorer.
- 3 In Windows Explorer, right click on MUSE, and then select the option to install **Philips Songbird**.
  - ↳ The computer downloads the installer file from the Internet.
- 4 Follow the on-screen instructions to complete the installation.

---

## Battery level indication

The display indicates the approximate levels of the battery status as follows:

				
100%	75%	50%	25%	0%

- ↳ A flashing battery screen indicates that the battery is low. The player saves all settings and switches off within 60 seconds.

### Note

- Rechargeable batteries have a limited number of charge cycles. Battery life and number of charge cycles vary by use and settings.
- The charging animation stops and the  icon is displayed when the charging process is completed.

### Tip

- You can conserve battery power and increase the play time of MUSE if you go to  > [Display Settings] > [Screen off timer] and ensure that the shortest timer setting is selected.

---

## Software loaded on the MUSE

MUSE comes with the following software:

- **Philips Songbird** (helps you update the firmware of MUSE and transfer your media files).

---

## Files loaded on the MUSE

The following files are loaded on MUSE:

- User manual
- Frequently asked questions

## 4 Update MUSE

MUSE is controlled by an internal program called firmware. Newer versions of the firmware may have been released after you have purchased MUSE.

The software program called **Philips Songbird** can use your computer to check for firmware updates that are available on the Internet. Install **Philips Songbird** on your computer (see chapter **Install software**) and follow the instructions to update (see chapter **Manually verify / update the firmware**).



### Note

- Your music files are not affected by a firmware update.

---

### Manually verify / update the firmware

- 1 Ensure that your computer is connected to the Internet.
- 2 Connect MUSE to the computer (see section **Connect and charge** for instructions).
- 3 On your computer, click **Start > Programs > Philips > Philips Songbird** to launch the Philips Songbird application.
- 4 Click MUSE in the Player pane. Then, select **Tools > Check for updated firmware** in the pop-up window.
  - ↳ **Philips Songbird** checks for updates and installs new firmware from the Internet, if available.
- 5 Follow the on-screen instructions to update the firmware of MUSE.
- 6 Wait until the update is completed, then disconnect MUSE from the computer.
  - ↳ MUSE restarts after the firmware is updated and is ready for use again.

# 5 Turn MUSE on and off

- 1 Press and hold the  button for longer than 2 seconds to toggle between on and off.

---

## Automatic shut-down

MUSE has an automatic shut-down feature that can save battery power.

After 10 minutes in idle mode (no music plays, no button is pressed), MUSE turns off.

- 1 Press and hold  for longer than 2 seconds to turn MUSE on again.



- The default setting is 10 minutes as this is the maximum possible power-saving mode. You can change this mode in the settings.

## 6 Philips Songbird

MUSE comes with the Philips Songbird software.

The Philips Songbird software helps you to:

- purchase new media (music and videos) online
- create a media library
- manage your media library
- play music and videos
- sync your media with the MUSE

When Philips Songbird is launched for the first time, choose from the following options to import media files into the Songbird media library:

- Import an existing iTunes library.
- Scan for media files in specific directories. (You can select to watch a folder, so that the files that are added or deleted there are automatically added or deleted in the Songbird media library.)

---

### Build a media library

Use one or more of the following options to build a media library with Songbird:

---

#### Rip a CD

By default, the Philips Songbird software installs the following add-ons that are needed to rip a CD:

- CD Rip Support
- Gracenote Metadata Lookup Provider

---

#### Set up the CD rip options

- 1 On the computer, launch the Songbird program.
- 2 Select **Tools > Options...**
- 3 Select the **CD Rip** tab, and then choose your CD rip options.
- 4 Click on **OK** to confirm.

---

#### Import media files from a directory

The following steps show how you can import media (music and video) files that are stored elsewhere on your computer or computer network:

- 1 On the computer, launch the Songbird program.
- 2 On the Songbird toolbar, click **File**, then select **Import Media...**
- 3 Select your media (music and video) files, then click **OK**.
  - ↳ The media files that you added are listed in the media library.



#### Tip

- If you select a folder that contains music or video files, the software scans the folder and adds all the music or video files it contains to the media library (duplicate titles are ignored).

---

#### Import media from iTunes

- 1 On the computer, launch the Songbird program.
- 2 Select **Tools > Options...**
- 3 On the Songbird toolbar, select the **Media Importer** tab, then **iTunes Import/Export**.
- 4 Verify your library location and options.
- 5 Select **Import Library**.
  - ↳ The software imports the iTunes library into Songbird.



---

## Export media to iTunes

- 1 On the computer, launch the Songbird program.
- 2 Select **Tools > Options...**
- 3 On the Songbird toolbar, select the **Media Importer** tab, then **iTunes Import/Export**.
- 4 Verify your library location and options.
- 5 Select **Export Library**.
  - ↳ The software exports the library from Songbird to iTunes.

---

## Get content from online sources

You can purchase content from online sources such as the following:

- 7-digital

Check the specifications of your MUSE to see what services are available to you.

---

## Import recordings from MUSE

- 1 On the computer, launch the Songbird program.
- 2 On the Songbird toolbar, click **File**, then select **Import Media...**
- 3 Select your recordings on MUSE, then click **OK**.
  - ↳ The selected recordings are listed in the media library.



### Tip

- If you select a folder that contains recordings, the software scans the folder and adds all the recordings it contains to the library (duplicate titles are ignored).

---

## Browse your media library

The Songbird media library is structured as follows:

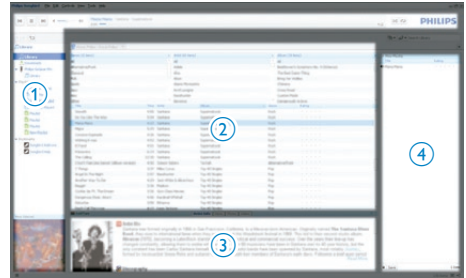

- ① Player Pane (this is where the MUSE is displayed)
- ② Library Pane (this is where you find the contents of your library)
- ③ Service Pane (this is where you find additional information about contents, such as playlists)
- ④ Information Pane (this is where you find information about the selected options)

---

## Organize and manage your Songbird library

---

### Let Songbird manage your media

- 1 On the computer, launch the Songbird program.
- 2 Select **Tools > Options...**
- 3 On the Songbird toolbar, select the **Manage Files** tab.
- 4 Check **Allow Songbird to manage my files**.
- 5 Set the options on how you want to organize your media.

## Remove media files from the Songbird media library

- 1 In the Songbird library, right click on a media file, then select **Remove**.
- 2 In the prompt window, click **Remove** to confirm that you want to remove the file.
  - ↳ The selected file is removed from the library and from all playlists. (By default, the file is only "removed", not "deleted". The media file still exists in its original location on the computer or computer network.)



### Tip

- To select multiple files on the computer (PC), press and hold **Ctrl**.
- To select multiple consecutive files, press and hold **Shift**.

## Delete media

This is how to delete media files in Windows Explorer:

- 1 With MUSE connected to the computer, open Windows explorer.
- 2 Locate the media folder in MUSE.
- 3 Delete the media file in the same way as you would from any other location on the computer.

## Let Songbird watch a folder

You can let Songbird

- monitor the contents of a folder, and
  - add or remove the media from your library to match the folder contents.
- 1 On the computer, launch the Songbird program.
  - 2 Select **Tools > Options...**
  - 3 On the Songbird toolbar, select the **Media Importer** tab, and then **Watch Folders**.
  - 4 Select the folder that you want Songbird to watch for changes.
    - ↳ The selected folder is watched and Songbird matches the library content to the content of the folder.

## Fetch album artwork

Choose from these options to fetch the artwork for your albums:

- 1 On the computer, launch the Songbird program.
  - On the Songbird toolbar, select **Tools > Get Album Artwork**.
    - ↳ If no titles are selected, Songbird fetches the artwork for all titles in the library.
  - Right-Click on selected titles.
    - ↳ Songbird fetches the artwork for all selected titles.

## Playlists

By default, the Philips Songbird software installs the following add-ons that are needed to rip a CD:

- CD Rip Support
- Gracenote Metadata Lookup Provider

---

## Create a playlist

- 1 On the computer, launch the Songbird program.
- 2 Choose from these options to create a new playlist:
  - On the Songbird toolbar, select **File > New Playlist**.
  - Right-click on the left hand sidebar, and then choose **New Playlist**.
  - Click the + symbol at the bottom of the left hand side Service Pane.↳ A new playlist appears in the Service Pane.
- 3 Enter a name for the new playlist.

---

## Add titles to a playlist

- 1 On the computer, launch the Songbird program.
- 2 Select one or more titles.
- 3 Choose from these options to add the selected titles to a playlist:
  - Drag and drop the selected titles to the playlist in the Service Pane.
  - Right-click on the selection, and then select **Add to Playlist > The\_name\_of\_your\_playlist**.↳ All selected titles are added to the playlist.

---

## Remove titles from a playlist

- 1 On the computer, launch the Songbird program.
- 2 Select a playlist.
- 3 Right-click on the title that you want to remove, and then **Remove**.  
↳ The selected title is removed from the playlist.

---

## Change the look of the Songbird library

You can change the design and color scheme of the Songbird library. We call this "changing feathers". New feathers are installed and managed like add-ons.

Find new feathers

- 1 On the computer, launch the Songbird program.
- 2 On the Songbird toolbar, select **View > Feathers > Get More Feathers...**
  - ↳ The software searches for new feathers.
  - ↳ Follow the on-line instructions to install the new feathers.

---

## Format MUSE (erase all music and data)

**Philips Songbird** has a Format feature that you can use to format MUSE and erase all your files from the internal memory.

### Caution

- The following procedure erases all your files that are stored on MUSE.

- 1 Install **Philips Songbird** on your computer (see chapter **Install software**), and then launch the program.
- 2 In the **Philips Songbird** player pane, click on MUSE.
- 3 In the library pane, click on the tab called **Tools**.
- 4 In the tools pane, click on **Format device**.
- 5 Follow the on-screen instructions to complete the repair procedure.

## Repair MUSE (restore factory settings)

**Philips Songbird** has a repair feature that you can use to restore MUSE to the factory settings. Before you proceed, back up your files that are stored on MUSE if possible.

### Caution

- The following procedure erases all your files that are stored on MUSE, and restores the factory settings.

- 1** Install **Philips Songbird** on your computer (see chapter **Install software**), and then launch the program.
- 2** In the **Philips Songbird** menu bar (at the top), click on the **Tools** pull-down menu and then select **Repair My MUSE**.
- 3** Follow the on-screen instructions to complete the repair procedure.

# 7 Music

## Add music to MUSE

- 1 Refer to the Songbird chapter in this user manual to find out how to add (transfer) media files such as music to MUSE.

## Overview of the music controls

These are the controls of the music mode:



Goal	Action
play	tap ▶
pause	tap
skip to the beginning of the next music title	tap ⏮
skip to the beginning of the current music title	tap ⏪
skip forwards inside music title	tap and hold ⏭
skip backwards inside music title	tap and hold ⏩
view options menu	tap ☰
increase / decrease volume	press volume - / + button
go to active play screen	tap ⏵

## Browse music albums

This is how you browse the music library by album cover:

- 1 Tap 🎵 to display the browser view.
- 2 Use your finger to swipe from left to right or from right to left on the screen to browse the album covers.



## Listen to music

- 1 In the home menu, tap 🎵 to enter the music mode.
  - ↳ The music library is displayed in columns that you can customize:



- ↳ Tap ☰ to see the library view options, and then tap to select a view option.
- 2 With your finger, swipe up or down on the screen to scroll through lists of music.
- 3 When you have located the music title, tap it to start play.
  - Tap || to pause play.
  - Tap ▶ to restart play.
  - Press 🏠 to return to the home menu.

During music play, you can choose from the following advanced play features:

- Tap the rating bar once or more to select the rating option
  - · · · · · (not rated)
  - ★ · · · · · (rating 1)
  - ★★ · · · · · (rating 2)
  - ★★★ · · · · · (rating 3)
  - ★★★★ · · · · · (rating 4)
  - ★★★★★ (rating 5)
- Tap  once or more to select from the following repeat options:
  - repeat 1 (the current music track is repeated)
  - repeat all (all music tracks of the current selection are repeated)
  - repeat off (nothing is repeated)
- Tap  to play the music tracks of the current library selection in random order.
- Tap  to see more music options such as equalizer and FullSound settings.

## Customize the music library view

In music mode, you can change the way you view your music in the library:

- 1 Tap  to see the library view options:
  - Artists and albums (displays a three column list with artists, albums, and titles in alphanumerical order)
  - Artists (displays a two column list with artists and titles in alphanumerical order)
  - Albums (displays a two column list with albums and titles in alphanumerical order)
  - All songs (displays a single column list of all titles in alphanumerical order)
  - Playlists (displays a two column list with playlists and titles in alphanumerical order)
- 2 Tap the view that you want to apply.
  - ↳ The library is displayed according to the applied view.

## Delete the currently playing music track

- 1 While you listen to the music track, tap .
- 2 Tap the option to delete the music track.
- 3 Tap to confirm the deletion.

## Delete one or more music tracks

- 1 Use the **Philips Songbird** software to add or delete, and then sync your media files such as music.



### Note

- Alternatively, you can select  from the main menu and find your files in folder view.

# 8 Audiobooks

MUSE supports books in audio format. The use of this feature requires that you download the **AudibleManager** from audible.com. With the **AudibleManager** you can manage the digital contents of your audiobooks. Visit audible.com and register. The onscreen instructions guide you through the **AudibleManager** software download process.

## Add audiobooks to MUSE

**Important:** MUSE supports audiobook format 4 or format e.

- 1 On your computer, launch **AudibleManager**.
- 2 Follow the online instructions to download your audiobooks in format 4 or format e.
- 3 Follow the **AudibleManager** on-screen instructions to activate MUSE for your audiobooks.
- 4 Follow the **AudibleManager** on-screen instructions to transfer your audiobooks to MUSE.

### Note

- MUSE can only play audiobooks for which it is activated.

## Overview of the audiobook controls

These are the controls of the audiobook mode:



Goal	Action
play	tap ▶
pause	tap
go to beginning of new section / chapter	tap ⏮
go to beginning of current section / chapter	tap ⏪
skip forwards inside audiobook	tap and hold ⏩
skip backwards inside audiobook	tap and hold ⏮
view options menu	tap ☰
increase / decrease volume	press volume - / + button
increase / decrease play speed	tap 🗨 / 🗨
go to active play screen	tap ⌂

## Browse audiobooks



This is how you browse the audiobook library by book cover:

- 1 Tap 📖 to display the browser view.
- 2 Use your finger to swipe from left to right or from right to left on the screen to browse the book covers.









## Listen to audiobooks

- 1 In the home menu, tap  to enter audiobook mode.  
The audiobook play screen consists of three panels:
  - top panel: options
  - center panel: current audiobook selection
  - bottom panel: controls



- 2 With your finger, swipe up or down on the screen to scroll through lists of audiobooks.
- 3 When you have located the audiobook title, tap it to start play.
  - Tap  to pause play.
  - Tap  to restart play.
  - Press  to return to the home menu.

During audiobook play, you can choose from the following advanced play features:

- Tap the rating bar once or more to select the rating option
  -  (not rated)
  -  (rating 1)
  -  (rating 2)
  -  (rating 3)
  -  (rating 4)
  -  (rating 5)
- Tap  to add a bookmark at the current location in the audiobook.
- Tap  to see more audiobook options.

## Customize the audiobook library view

In audiobooks mode, you can change the way you view your audiobooks in the library:

- 1 Tap  to see the library view options:
  - Authors (displays a single column list of all authors in alphanumerical order)
  - Books (displays a single column list of all titles in alphanumerical order)
- 2 Tap the view that you want to apply.
  - ↳ The library is displayed according to the applied view.



# 9 Video

## Add videos to MUSE

- 1 Refer to the Songbird chapter in this user manual to find out how to add (transfer) media files such as videos to MUSE.

## Overview of the video controls

These are the controls of the video mode:



Goal	Action
play	tap ▶
pause	tap
skip to the beginning of the next video title	tap ▶▶
skip to the beginning of the current video title	tap ◀◀
skip forwards / backwards inside video title	tap ◀▶ and then tap on a position on the progress bar
view options menu	tap ☰
increase / decrease volume	press volume - / + button
go to active play screen	tap ⏪

## Browse video albums

This is how you browse the video library by album cover:

- 1 Tap 📺 to display the browser view.
- 2 Use your finger to swipe from left to right or from right to left on the screen to browse the album covers.

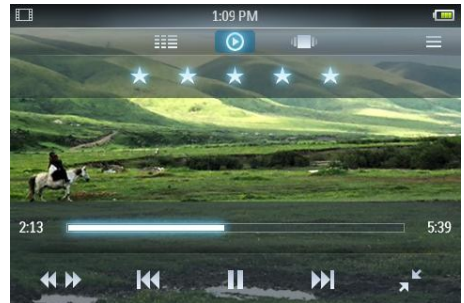

## Play videos

- 1 In the home menu, tap 📺 to enter the video mode.
- 2 With your finger, swipe up or down on the screen to scroll through lists of videos.
- 3 When you have located the video title, tap it to start play.  
The video play screen consists of three panels:
  - top panel: options
  - center panel: current video selection
  - bottom panel: controls



- Tap || to pause play.
- Tap ▶ to restart play.
- Tap ⏪ to return to the root menu.
- Press 🏠 to return to the home menu.

During video play, you can choose from the following advanced play features:

- Tap the rating bar once or more to select the rating option
  - · · · · · (not rated)
  - ★ · · · · · (rating 1)
  - ★★ · · · · · (rating 2)
  - ★★★ · · · · · (rating 3)
  - ★★★★ · · · · · (rating 4)
  - ★★★★★ (rating 5)
- Tap  to change the from normal view to full-screen view.
  - Tap the screen to display the options and controls.
  - Tap  to change from full-screen view back to normal view.
- Tap  to change from normal play to the video search mode, and then
  - tap the progress bar ① (see image) in the control panel to skip to a specific location inside the currently playing video;
  - tap the speed control bar ② (see image) in the control panel to increase/decrease the forward/backward play speed by up to 5 times the normal speed:

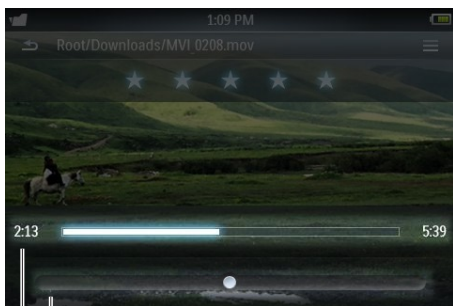

① ②

- Tap  to see more video options such as Brightness and **Surround for movies**.

## Play videos on your HD TV

This is how you play video clips from the player on your HD TV:

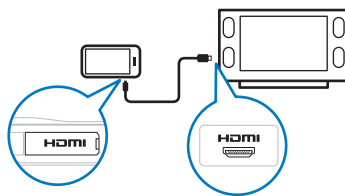

- 1 Follow the steps in chapter “Play videos” to play a video.
- 2 Connect the small plug of the HDMI cable (sold separately) with the player.
- 3 Turn on your HD TV.
- 4 Connect the large plug of the HDMI cable (sold separately) with the HDMI outlet jack of your HD TV.
  - ↳ The video plays on your HD TV.
    - Tap the screen on MUSE for play options and navigation.

### Tip

- If you disconnect the HDMI cable, the video play on your HD TV resumes a few seconds after you reconnect the HDMI cable.

## Customize the video library view

In video mode, you can change the way you view your videos in the library:

- 1 Tap  to see the library view options:
  - All videos (displays a single column list of all titles in alphanumerical order)
  - Playlists (displays further playlist view options)
- 2 Tap the view that you want to apply.
  - ↳ The library is displayed according to the applied view.

---

## Delete the currently playing video

- 1 While you watch the video, tap .
- 2 Tap the option to delete the video.
- 3 Tap to confirm the deletion.

---

## Delete one or more videos

Use the **Philips Songbird** software to add or delete, and then sync your media files such as videos.

### Note

- Alternatively, you can select  from the main menu and find your files in folder view.

# 10 Pictures

## Add pictures to MUSE

- 1 Refer to the Songbird chapter in this user manual to find out how to add (transfer) media files such as pictures to MUSE.

## Overview of the picture controls

These are the controls of the picture mode:

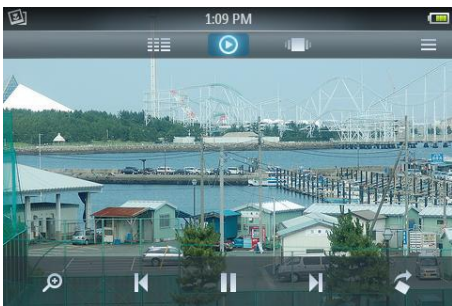

Goal	Action
play slideshow	tap ▶
pause slideshow	tap
skip to the next picture	tap ►
skip to the previous picture	tap ◀
view options menu	tap ≡
enlarge picture (zoom in)	tap 🔍, then tap the zoom control bar
rotate picture clockwise by 90 degrees	tap ↻
go to active display screen	tap ⏪

## Browse picture albums

This is how you browse the picture library in album view:

- 1 Tap 📷 to display the browser view.
- 2 Use your finger to swipe from left to right or from right to left on the screen to browse the album covers.

## View pictures

- 1 In the home menu, tap 📷 to enter the picture mode.
  - ↳ The picture display screen consists of two sections: the list of albums and the thumbnail view of the photos in the selected album.
- 2 Swipe your finger up and down on the album list to locate an album, then tap to select the album.
- 3 In the thumbnail view area, tap on a picture to see it in full-screen mode.
  - Tap ▶ to view the pictures in the selected album as a slideshow, starting with the currently displayed picture.
  - Tap ≡ to see more picture and slideshow options.
  - Tap ⬆️ to return to the home menu.

---

## Advanced picture display

During picture display, you can choose from the following advanced display features:

- Tap  to enter the zoom mode, then tap the zoom control bar in the control panel:



- Tap\* the right hand side of the zoom control bar to increase the enlargement factor by up to 4 times the normal size.
- Tap\* the left hand side of the zoom control bar to decrease the enlargement factor (minimum size: normal size).
- Double tap the picture to return to normal size view.
- Tap  to see more picture options such as slideshow time settings.

### Tip

- When an enlarged picture exceeds the size of the screen, you can use your finger to drag the picture inside the screen.
- \* You can also drag the marker of the zoom control bar to the left / right hand side to increase/decrease the enlargement factor.

---

## View pictures on your TV

This is how you view pictures from the player on your TV:

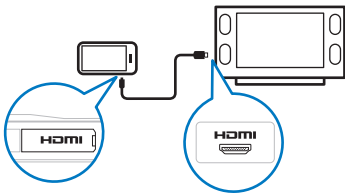

- 1 Follow the steps in chapter "View pictures" to view a picture.

- 2 Connect the small plug of the supplied HDMI cable (sold separately) with the player.
- 3 Turn on your TV.
- 4 Connect the large plug of the supplied HDMI cable (sold separately) with the HDMI outlet jack of your TV.
  - ↳ The picture displays on your TV.
  - Tap the screen on MUSE for display, navigation and slideshow options.

### Tip

- If you disconnect the HDMI cable, the picture display on your TV resumes a few seconds after you reconnect the HDMI cable.

---

## Delete the currently displayed picture

- 1 While you view the picture in full-screen mode, tap .
- 2 Tap the option to delete the picture.
- 3 Tap to confirm the deletion.

---

## Delete one or more pictures

- 1 Use **Philips Songbird** software to add or delete, and then sync your media files such as pictures.

### Note

- Alternatively, you can select  from the main menu and find your files in folder view.

# 11 Radio

## Listen to FM radio





MUSE can store up to 20 different radio stations under preset numbers.

Follow the instructions in chapter **Auto-tune radio stations** to automatically tune to radio stations.

The auto-tune feature automatically saves the first 20 stronger signals to preset numbers.

### Note

- You can also manually tune to radio stations. (See chapter **Manually tune a radio station** for more information.)

- 1 In the home menu, tap  to enter the radio mode.
  - ↳ The earphones cable acts as FM antenna.
- 2 Tap  to display the presets.
- 3 Tap a preset number to listen to the radio station that is saved under that number.
  - Press  to stop the radio sound.
  - Press  to return to the home menu.

## Auto-tune radio station presets

The auto-tune feature of MUSE helps you find radio stations and save them under the preset numbers.

- 1 While in radio mode with the earphones connected, tap  to see the options menu.
- 2 Tap the option to auto-tune.
  - If prompted, tap to confirm.
  - ↳ The radio automatically tunes radio stations and saves the first 20 stronger frequencies to the preset numbers.
  - ↳ For radio stations with RDS (Radio Data System) support, additional radio station information is displayed.

## Manually tune a radio station

While in radio mode, you can manually tune to a radio station:

- 1 Swipe your finger from left to right or from right to left on the tuning band at the bottom of the screen to manually increase/decrease the frequency.
  - Tap  to see more radio options.





### Tip

- A vertical line on the tuning band indicates the frequency of a radio station that is saved to a preset number.

# 12 Recordings

## Record audio/voices

This is how you record audio/voices with the built-in microphone (see section **Overview** for location of built-in microphone):

- 1 From the home menu, select 
  - Tap  to start recording.
  - Tap  /  to toggle between pause and recording.
  - Tap  to stop.







↳ Recordings are automatically saved on the player. (Filename format: REC YYYY-MM-DD XXX.MP3, where YYYY-MM-DD is the year, month and day of the recording, and XXX is the recording number that is generated automatically.)



Tip

- You can find your recordings in  under the recordings folder.

## Listen to recordings

- 1 In the home menu tap  to enter the folder view mode.
- 2 Tap to open the recordings folder.
- 3 With your finger, swipe up or down on the screen to scroll through list of recordings.
- 4 When you have located the recording, tap it to start play.
  - Tap  to pause play.
  - Tap  to restart play.
  - Tap  to change to record mode.
  - Tap  to see more recordings options.
  - Press  to return to the home menu.

## Upload your recordings to a computer

Use the **Philips Songbird** software to sync your media files.

Alternatively, you can transfer recordings in Windows Explorer:

- 1 Connect MUSE to the computer.
- 2 In Windows Explorer, open MUSE.
- 3 Select the folder **Recordings** > **Voice** or **FM radio\***.
- 4 Copy and paste the recordings to any location on the computer.



Note

- \* FM radio recording feature is available with some versions only. Refer to the on-screen menu of MUSE to find out which features are available to you.

## Delete the currently playing recording

This is how to delete the currently playing recording:

- 1 While you listen to a recording, tap .
- 2 Tap the option to delete the recording.
- 3 Tap to confirm the deletion.

---

## Delete one or more recordings

This is how to delete recordings in Windows Explorer:

- 1 Connect MUSE to the computer.
- 2 In Windows Explorer, locate the folder **Recordings > Voice** or **FM radio\***.
- 3 Delete the recordings as you normally would on the computer.



### Note

- \* FM radio recording feature is available with some versions only. Refer to the on-screen menu of MUSE to find out which features are available to you.



# 13 SD Card

## Insert an SD card

- 1 Turn on MUSE.
- 2 Open the dust cover of the Micro SD card slot.
- 3 Insert the Micro SD card with the contacts facing up:

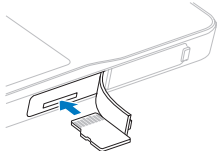





↳ The Micro SD card icon  is added to the home menu.



### Note

- MUSE supports Micro SD cards of up to 32GB.

## Import files from a Micro SD card

- 1 Insert a Micro SD card.
- 2 In the home menu, tap  to enter the Micro SD card mode.
- 3 Tap  to see the Micro SD card options.
- 4 Tap the option to import the files from the Micro SD card to the library of the MUSE.
  - ↳ The imported files are accessible through the internal library of the MUSE (example: in the home menu, tap  to access imported music files).
  - Press  to return to the home menu.



## Access files on a Micro SD card

- 1 Insert the Micro SD card.
- 2 In the home menu, tap  to enter the Micro SD card mode.
- 3 With your finger, swipe up or down on the screen to scroll through lists of folders or files.
- 4 Tap to open folders or files.
  - Tap  to see more Micro SD card options.
  - Press  to return to the home menu.

# 14 Text reader

---

## Read text files

- 1 In the home menu, tap  to enter the text reader mode.
  - ↳ The text files are displayed as a list.
- 2 Swipe your finger up and down on the list to locate a text file, then tap to select it.
- 3 Swipe your finger from right to left or from left to right on the text to flick to the next or previous page.
  - Tap  to see more text reader options.
  - Tap  to return to the home menu.

# 15 Use the MUSE to carry data files

This is how you use MUSE to store and carry data files:

- 1 Connect MUSE to the computer (for instructions see section **Connect and charge**).
- 2 On the computer in Windows Explorer, copy the data files and paste them to MUSE.







## Tip

- Use the computer to transfer your data files back to the computer, or delete your data files from MUSE.

# 16 Settings

This is how you customize MUSE:

- 1 In the home menu, tap  to enter settings mode.
- 2 In the settings menu,
  - swipe your finger up or down on the screen to scroll through lists of options.
  - tap to select options.
  - tap  to confirm options (required for some settings).
  - tap  to return to the previous level.
  - Press  to return to the home menu.

In the settings menu, the following options are available:

Settings	Options menu	• Sub-options menu
Power-saving* settings	Protect the environment! Choose shortest idle time until auto shut-down. <ul style="list-style-type: none"><li>• 10 minutes (default)</li><li>• 20 minutes</li><li>• 30 minutes</li><li>• Always on</li></ul>	
Sleep timer	<ul style="list-style-type: none"><li>• Off (default)</li><li>• 15 minutes</li><li>• 30 minutes</li><li>• 60 minutes</li></ul>	
Display settings	Brightness	• {slide adjuster}
	Screen off timer	<ul style="list-style-type: none"><li>• 30 seconds</li><li>• 1 minute (default)</li><li>• 2 minutes</li><li>• 5 minutes</li><li>• Always on</li></ul>
	Wallpaper	<ul style="list-style-type: none"><li>• Theme 1 (default)</li><li>• Theme 2</li><li>• Theme 3</li><li>• Custom (from picture library)</li></ul>

Settings	Options menu	• Sub-options menu	
Date and time	Set date		
	Set date format	<ul style="list-style-type: none"> <li>• DD MM YYYY (default)</li> <li>• MM DD YYYY</li> <li>• YYYY MM DD</li> </ul>	
	Set time		
	Set time format	<ul style="list-style-type: none"> <li>• 12 hours</li> <li>• 24 hours (default)</li> </ul>	
	Show time in header	<ul style="list-style-type: none"> <li>• On (default)</li> <li>• Off</li> </ul>	
Language	<ul style="list-style-type: none"> <li>• Czech</li> <li>• Greek</li> <li>• English (default)</li> <li>• Danish</li> <li>• German</li> <li>• Spanish</li> <li>• French</li> <li>• Italian</li> <li>• Hungarian</li> <li>• Dutch</li> </ul>	<ul style="list-style-type: none"> <li>• Norwegian</li> <li>• Polish</li> <li>• Portuguese</li> <li>• Portuguese (Brazilian)</li> <li>• Russian</li> <li>• Slovak</li> <li>• Finnish</li> <li>• Swedish</li> <li>• Turkish</li> </ul>	<ul style="list-style-type: none"> <li>• Chinese (simplified)</li> <li>• Chinese (traditional)</li> <li>• Japanese</li> <li>• Korean</li> <li>• Thai</li> <li>• Hebrew (some versions only)</li> <li>• Arabic (some versions only)</li> </ul>
	PC connection preference	<ul style="list-style-type: none"> <li>• MSC - mass storage (default)</li> <li>• MTP - media transfer</li> </ul>	
Information	Capacity: Free space: Firmware version: Model: CTN: Support site:		
Format device	All data will be deleted. Continue?	<ul style="list-style-type: none"> <li>• Yes</li> <li>• No</li> </ul>	
Reset settings	Restore factory settings Files transferred to player will not be affected.	<ul style="list-style-type: none"> <li>• Restore</li> <li>• Cancel</li> </ul>	

\* The default setting of 10 minutes is the maximum power-saving mode. Keeping the device setting in this mode helps protect the environment through conservation of battery power.

# 17 Technical data

## Power

Power supply: 1,100 mAh Li-ion polymer internal rechargeable battery

Play time<sup>1</sup>

- audio: 24 hours

- video: 5 hours

## Software

Philips Songbird: to update firmware and transfer music

## Connectivity

Headphone 3.5 mm

USB 2.0 High speed

HDMI

## Sound

Channel separation: 50 dB

Frequency Response: 20 - 18,000 Hz

Output power: 2 x 2.7 mW (for EU version);

2 x 10.5 mW (for Non-EU version)

Signal to noise ratio: > 85 dB

## Audio playback

Supported formats:

Bit rates	Sampling rates
-----------	----------------

MP3:

8 - 320 kbps and VBR	8, 11,025, 16, 22,050, 32, 44.1, 48 kHz
----------------------	---

WMA:

5 - 320 kbps	8, 11,025, 16, 22,050, 32, 44.1, 48 kHz
--------------	---

FLAC:

up to 1.5 Mbps	48 kHz
----------------	--------

APE:

up to 1.5 Mbps	48 kHz
----------------	--------

OGG:

up to 320 kbps	8 - 48 kHz
----------------	------------

AAC:

up to 320 kbps	8 - 48 kHz
----------------	------------

## Video playback

Supported formats:

MPEG4 (in .avi and .mp4)

RMVB

WMV

## Picture display

Supported formats:

JPEG

BMP

PNG

GIF

## Storage media

Built-in memory capacity<sup>2</sup>:

SA2MUS08 8GB NAND Flash

SA2MUS16 16GB NAND Flash

SA2MUS32 32GB NAND Flash

## Display

Touch-sensitive color LCD 480 x 320 pixels (HVGA)



### Note

- <sup>1</sup> Rechargeable batteries have a limited number of charge cycles. Battery life and number of charge cycles vary by use and settings.
- <sup>2</sup> 1GB = 1 billion bytes; available storage capacity is less. Full memory capacity may not be available as some memory is reserved for the player. Storage capacity is based on 4 minutes per song and 128 kbps MP3 encoding.

## System requirements

- Windows® XP (SP3 or above) / Vista / 7
- Pentium III 800 MHz processor or higher
- 512 MB RAM
- 500 MB hard disk space
- Internet connection
- Windows® Internet Explorer 6.0 or later
- CD-ROM drive
- USB port

# 18 Glossary

---

## B

### Bit rate

Bit rate is the number of bits that are conveyed or processed per unit of time. The bit rate is usually measured in some multiple of bits per second (kilobits per second: kbps). The term bit rate is a synonym for data transfer rate (or simply data rate).

---

## C

### Compression

In audio terms, this is a process of temporarily or permanently reducing audio data for more efficient storage or transmission. A temporary reduction in file size is called 'non-lossy' compression, and no information is lost. A permanent reduction in file size (such as with MP3 files) is called 'lossy' compression, and involves discarding unnecessary information which is irretrievably lost.

---

## D

### Decibel (dB)

A unit of measure used to express relative difference in power or intensity of sound.

---

## F

### FLAC [Free Lossless Audio Codec]

An audio format similar to MP3, but lossless, meaning that audio is compressed in FLAC without loss in quality.

### FM (Frequency Modulation)

In radio broadcasting: a method of modulation in which the frequency of the carrier voltage is varied with the frequency of the modulation voltage.

### Frequency Response

Is the range of frequencies that a speaker reproduces, lowest frequency to the highest. While the optimal normal is 20-20,000 Hz (Hertz), the range of human hearing for individuals is often much more restricted. A good full-range speaker system however, reproduces as much of this range as possible to cover all variations. Individual drivers are limited to reproduce only that part of the spectrum for which they were made, so their response is limited, but still a necessary point to consider when designing a complete sound system.

### FullSound

FullSound™ is an innovative technology designed by Philips. FullSound™ faithfully restores sonic details to compressed music, enhancing it to provide a full sound experience without any distortion.

---

## L

### LCD (Liquid Crystal Display)

Probably the most common way to show visual information on non-computer electronic equipment.

### Lossless compression

A system for reducing the number of data bits (density) in a musical signal without corrupting the original.

---

## M

### MP3

A file format with a sound data compression system. MP3 is the abbreviation of Motion Picture Experts Group 1 (or MPEG-1) Audio Layer 3. With the MP3 format, one CD-R or CD-RW can contain about 10 times more data than a regular CD.

### MSC [Mass Storage Class]

The USB mass storage device class (or USB MSC or UMS) is a set of computing communications protocols that provide an interface to storage devices. Devices that support this standard are referred to as MSC (Mass Storage Class) devices.

### MTP [Media Transfer Protocol]

Media Transfer Protocol supports the transfer of music and video files to portable audio and video players.

## N

### Napster

Napster is an online music service offering unlimited music you can easily transfer to your MUSE player.

## O

### Ogg Vorbis

Album art is a feature that displays the artwork (cover picture) of a music album. This display enables the user to quickly identify a music album. The artwork files for music albums can be downloaded from the Internet.

## R

### RDS (Radio Data System)

RDS tuners can automatically tune in stations according to the types of music (or talk) they broadcast. RDS also enables a receiver to display text messages and even graphics (usually call letters and format information) that many FM stations include on a sub-carrier signal within their normal broadcast signal. Some RDS equipped tuners can even override with traffic alerts or emergency broadcasts, during playback of other media - CD MD, or cassette. There are other useful features too, many of which are offered by the growing number of RDS stations.

### Rhapsody®

Rhapsody® is an on-line music service that offers streaming on-demand access to its library of digital music.

### Rip (ripping)

Using a software program that "grabs" digital audio from a compact disc and transfers it to a computer hard drive. The integrity of the data is preserved, because the signal does not pass through the computer sound card, and need not be converted to an analog format. The digital-to-digital transfer creates a WAV file that can then be converted into an MP3 file.

## S

### SuperScroll

SuperScroll™ is a navigation feature of the double-action search keys of the product. SuperScroll™ allows easy speed control when scrolling through large libraries to swiftly find items within large libraries. Longer press of the button results in faster scroll speed.

### Surround Sound for movies

Surround Sound encompasses a range of techniques for enriching the sound reproduction quality of an audio source. The three-dimensional (3D) sphere of human hearing can be virtually achieved through Surround Sound.



