

TEAC[®]

COLOUR TELEVISION

EU2845ST



OWNER'S MANUAL

IMPORTANT!

WARRANTY INFORMATION INSIDE. PLEASE READ

FOR INQUIRIES CALL

1800 656 700

OR

WWW.TEAC.COM.AU

TEAC® WARRANTY REGISTRATION

Please read this warranty card.

Keep your purchase receipt to enable you to proceed quickly in the event of a Warranty Service.

Warranty Terms & Conditions

1. TEAC warrants to the original retail purchaser only, that this product is free from defects in material and workmanship under normal domestic use and authorises free service during the warranty period at any TEAC Authorised Centre only. TEAC warranty only applies to products purchased, used and serviced in Australia.
2. Subject to the terms herein, this warranty effectively covers the equipment as specified in the Warranty Periods Table from the date of purchase.
3. All parts, except the external cabinet, are warranted as specified in Warranty Periods Table, and will be repaired or replaced at the sole judgement of TEAC.
4. Normal customer maintenance as described in the owner's manual is not covered by this warranty (such as cleaning VCR heads etc.)
5. This warranty does not apply to equipment showing abuse, damage or that it may have been tampered with, altered or repaired outside any TEAC Authorised Service Centre. If so, the warranty will be void.

***Your nearest Authorised TEAC Service Centre is listed in your Owners Manual**

6. In the event that this unit or any defective parts must be returned to TEAC Service Centres, a copy of this warranty certificate and of your purchase receipt must be enclosed to be a valid warranty. Such equipment or parts must be sent to the nearest authorised TEAC Service Centre. After the repair, the unit will be available for collection by the owner or it will be returned to the owner. The warranty does not cover freight or insurance. In all cases of in-transit damages or loss, a claim must be filed against the carrier by the purchaser.
7. In home service will only be provided as part of this warranty if all the following conditions are met;
 - a) The product is a Colour Television of 59cm screen size or over.
 - b) The product is within the warranty period.
 - c) The product is located within the normal service area of the local TEAC Service Provider.In any other situation or circumstance, where an in home service call is made, a service fee will be charged by the Service Provider. TEAC Total Care in home service and installation is available at competitive rates.
8. No one is authorised to assume any liability on behalf of TEAC or impose any obligation on it, in connection with the sale of any equipment other than as stated in this warranty and outlined above.
9. In no event will TEAC be responsible or liable for indirect or consequential damages from interrupted operations or other causes.
10. Warranty is not transferable to any subsequent purchaser if the product is sold during the warranty period,

TEAC PRODUCT	WARRANTY PERIOD
Televisions	1 Year
Televisions - Widescreen 16 x 9	3 Years (In-Home Service Included)
Televisions - 59cm and above	1 Year (In-Home Service Included)
Digital Set Top Boxes	1 Year
VCR	1 Year
DVD	1 Year
Audio Systems	1 Year

Keep this warranty information and your purchase receipt

Your proof of purchase (receipts) will enable fast and efficient service in the event of repair.

TEAC® WARRANTY PROCEDURES

Please keep this information for your own records.

Please refer to the owner's manual to ensure that you have followed the correct installation and operating procedures.

1. Read owner's manual carefully
2. If you require Warranty Service, please contact the TEAC Service Centre
3. Please have your purchase receipt as your proof of purchase and the following details completed for a valid Warranty.

Owner's Name

Owner's Address

Postcode

Model Name/No.

Serial No.

Dealer's Name

Dealer's Address

Postcode

4. Please ensure that your product is packed appropriately upon return to the service centre.

If you have any other queries regarding service or warranty please contact the TEAC Service below:

TEAC®

TEAC Total Care Ph: 1800 656 700

info@teac.com.au

Contents

Remote Control	5	Teletext	18
Control Panel Buttons and Rear Panel	6	1) To operate Teletext	18
Safety and Precautions	7	2) To select a page of Teletext	18
Attention:	7	3) To Select Index Page	18
Preparation	8	4) To Select Teletext with a TV Programme	18
Features	8	5) Searching for a page while watching TV	18
Before Switching on your TV	8	6) To Select Double Height Text	18
Power connection	8	7) To Reveal "concealed" Information	18
Connections to the RF input socket	8	8) To Stop Automatic Page Change	18
How to connect other devices	8	9) To Select a Subcode Page	18
Inserting batteries in the remote control handset ...	8	10) To exit Teletext	19
Switching the TV ON/OFF	9	11) To Display the Time	19
To switch the TV on	9	12) Fastext	19
To switch the TV off	9	Connect Peripheral Equipment	19
Operating the TV	9	1) Via the Euroconnector	19
A.P.S. (Automatic Programming System)	9	2) YCbCr Mode	19
Operating with the buttons on the TV set	9	3) Via Ant Input	19
Operating with Remote Control	9	4) Decoder	19
Menu System	10	5) TV and Video Recorder	19
Sound Menu	10	6) Playback NTSC	20
Picture Menu	12	7) Copy Facility	20
Feature Menu	14	8) Search for and store the test signal of the video recorder	20
Installation Menu	14	9) Camera and Camcorder	20
Program Menu	15	10) Connect the decoder to the video recorder	20
Other Features	16	11) Connecting Headphones	20
1) TV Status	16	Antenna Connections	21
2) Programme Swap (P<P)	16	Tips	22
3) Double-digit (- -)	17	Care of the Screen	22
4) Personal Preferences (PP)	17	Poor Picture	22
5) Sound Indicator	17	No Picture	22
6) Picture Mode	17	Sound	22
7) Blue Background During No-Signal	17	Remote Control	22
8) Mute Indicator	17	No solution	22
9) Volume Bar	17	Specifications	22
10) AV Modes	17		

Remote Control

- ① = Stand By
- ② = Cursor Up
- ③ = Cursor Right
- ④ **OK** = No function
- ⑤ = Info (Program Menu)
- ⑥ **0 - 9** = Direct Program
- ⑦ **-/--** = Double Digit
- ⑧ **P<P** = Previous Programme
- ⑨ **P/CH +** = Programme Up
- ⑩ = Volume +
- ⑪ = TV / Quit Menu
- ⑫ = External Source
(EXT-1, RGB, YCbCr and F-AV)
- ⑬ **Yellow (FEATURE)** = Feature Menu
- ⑭ **Blue (INSTALL)** = Installation Menu
- ⑮ = Hold
- ⑯ = Update / Picture Mode Change ***
- ⑰ = Index Page
- ⑱ = Reveal
- ⑲ = Expand
- ⑳ = Mix
- ㉑ = Teletext
- ㉒ = Time
- ㉓ **Red (SOUND)** = Sound Menu
- ㉔ **Green (PICTURE)** = Picture Menu
- ㉕ = Mute
- ㉖ **I-II** = Mono/Stereo - Dual I-II
- ㉗ = Volume -
- ㉘ **- P/CH** = Programme Down
- ㉙ **PP** = Personal Preference
- ㉚ **M** = Menu
- ㉛ = Cursor Down
- ㉜ = Cursor Left

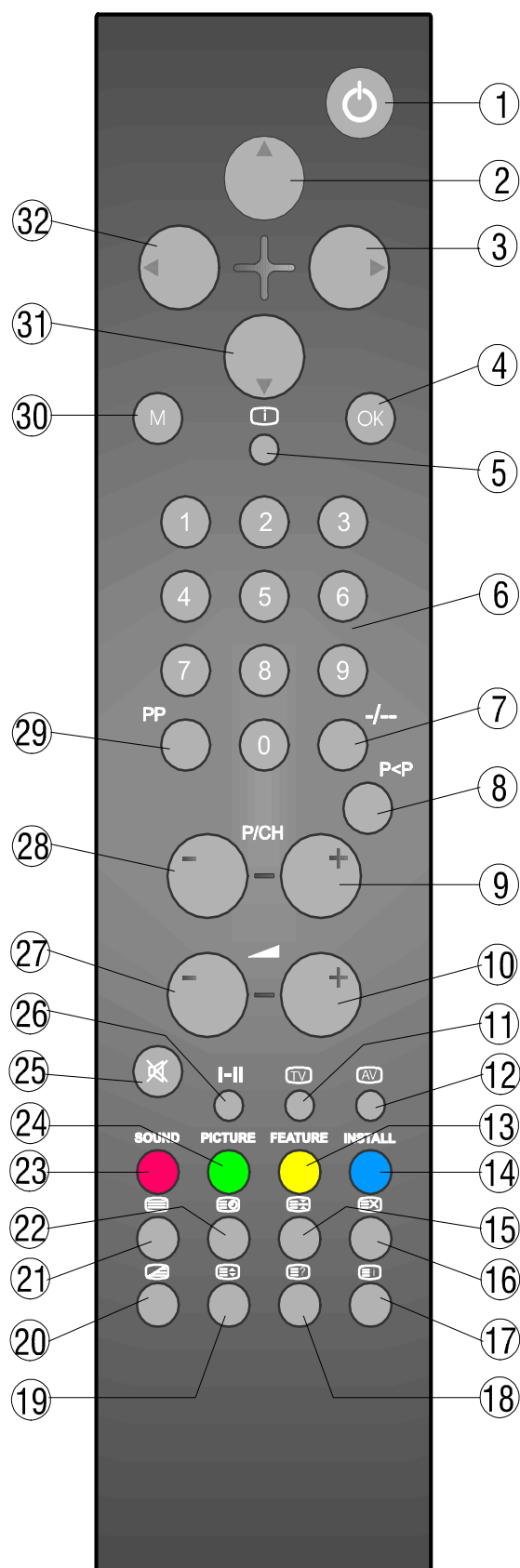

- ⑭ = Picture Mode Change *** (AUTO, 4:3, 16:9, CINEMA, SUBTITLE, ZOOM)

Control Panel Buttons and Rear Panel

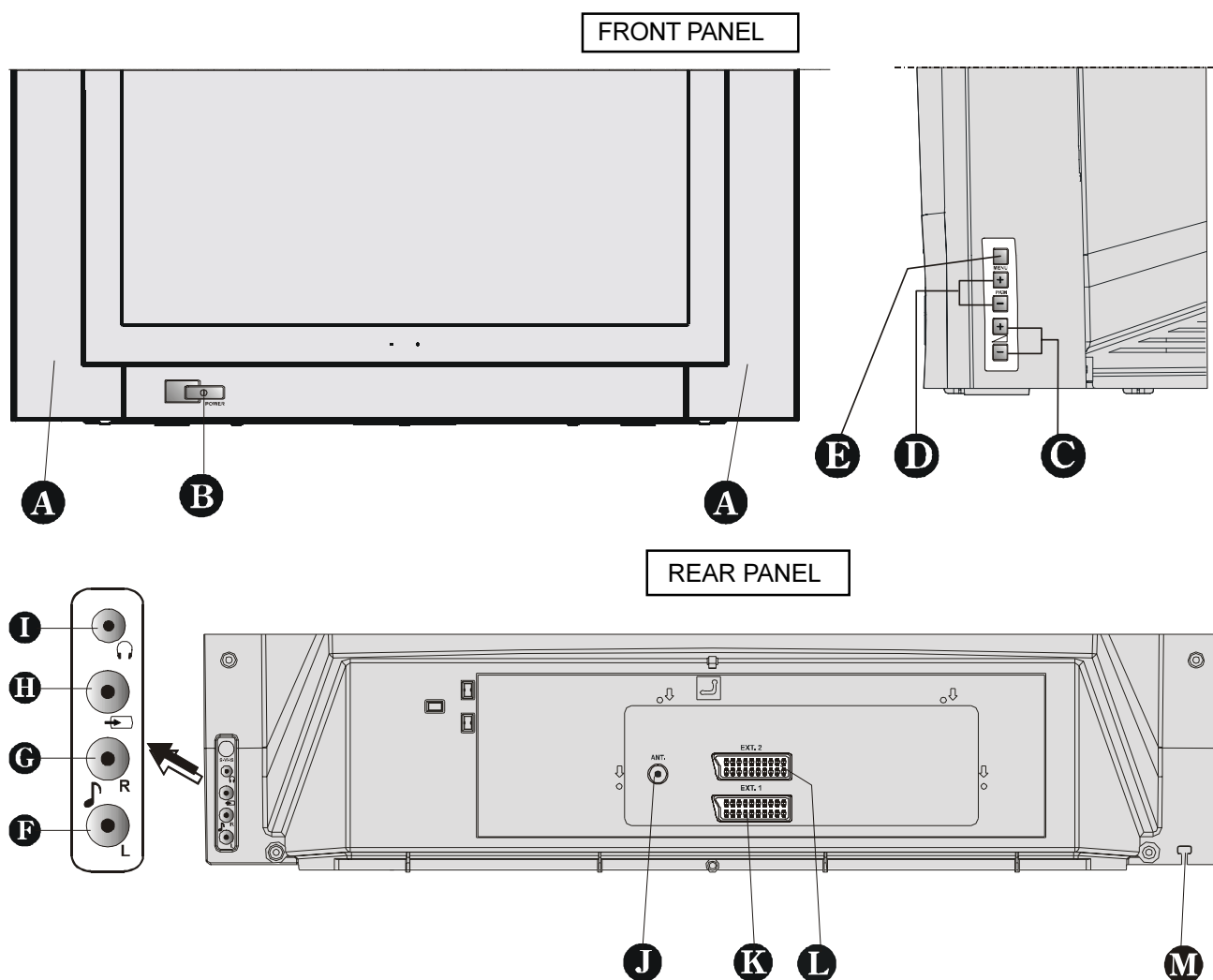

- A** Speakers (left + right)
- B** Ⓞ = Power On / Off
- C** - \blacktriangle + = Volume -/+
- D** - P/CH + = Program -/+
- E** MENU = Menu
- F** AUDIO L (🎵) = Audio left
- G** AUDIO R (🎵) = Audio right

- H** VIDEO (➡) = VCR
- I** H-PHONE (🎧) = Headphone 3,6 mm Ø
- J** ANT = Antenna (75 Ω)
- K** EXT.1 = Scart Socket 1 (RGB)
- L** EXT.2 = Scart Socket 2 (YCbCr)
- M** Power Cable

Safety and Precautions

To ensure safe and reliable operation of the TV set, please observe the following precautions in installation, operation and maintenance.

Attention:

1. Pay attention to the power supply cord before installing the TV set. Do not hang anything on the cord, and avoid treading on the cord.
2. The slots on the housing back are designed for ventilation to ensure reliable operation of the TV set and prevent overheating. They must never be covered or blocked. The TV set must not be placed near a heat source or it might be damaged.
3. The outdoor antenna must not be erected close to HV lines or other power supply lines. Use extreme care when erecting the antenna and not to touch living wires or injury may occur.
4. This TV set can only use the supply voltage and frequency indicated on the back of the housing. If your power supply does not comply with them, please consult with the service personnel.
5. Do not let any object fall into the ventilation openings of the TV set housing, nor let any liquid flow into the machine via the openings.
6. Do not subject the TV set to rain, or use it in a damp environment. When cleaning dust, be sure to remove the power supply plug from its socket first. Do not clean the housing directly with liquid detergent, use a damp cloth. Be sure to remove the power supply plug from its socket and remove the antenna plug during a thunderstorm or when it will not be used for long time, to avoid components being damaged by lightning.
7. If you use an indoor antenna, do not let it touch any electrical appliance, or normal reception of TV programs may be affected.

Safety:

1. Do not remove the back of housing by yourself, as high voltages inside the unit are dangerous. If it is necessary to open the back, ask a technician with specialized service experience.
2. Remove the power supply plug from its socket in case of the following conditions, and consult with service personnel.
 - (1) The power cord or plug are damaged or shows cracking.
 - (2) Any object has fallen into or liquid flown into the TV set.
 - (3) The performance of TV set has deteriorated significantly or there is damage on the housing.
 - (4) The TV set will not operate normally according to the instructions.
3. Please remove the power supply plug from its socket when the TV set will not be used for a long period of time.

Instructions for waste disposal:

- Packaging and packaging aids are recyclable and should principally be recycled. Packaging materials, such as foil bag, must be kept away from children.
- Batteries, including those which are heavy metal-free, should not be disposed of with household waste. Please dispose of used batteries in an environmentally sound manner. Find out about the legal regulations which apply in your area.

“DO NOT LEAVE YOUR TV AT STAND-BY OR OPERATING WHEN YOU LEAVE YOUR HOUSE”

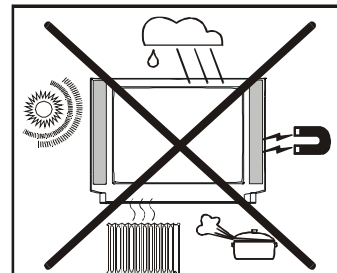

CAUTION:

Use of controls, adjustments or procedures other than those specified herein may result in hazardous radiation exposure.



CAUTION
RISK OF ELECTRIC SHOCK DO NOT OPEN.



CAUTION: TO REDUCE THE RISK OF ELECTRIC SHOCK, DO NOT REMOVE COVER (OR BACK). NO USER SERVICEABLE PARTS INSIDE. REFER SERVICING TO QUALIFIED SERVICE PERSONNEL.



The lightning flash with arrowhead symbol, with an equilateral triangle is intended to alert the user to the presence of Uninsulated "dangerous voltage" Within the product's enclosure that may be of sufficient magnitude to constitute a risk of electric shock to the person.



The exclamation mark within an equilateral triangle is intended to alert the user to the presence of important operating and maintenance (servicing) instructions in the literature accompanying the appliance.

This appliance has a serial number on the rear panel. Please record the serial number and retain it for your records.

Serial Number: _____

WARNING: TO REDUCE THE RISK OF FIRE OR ELECTRIC SHOCK, DO NOT EXPOSE THIS APPLIANCE TO RAIN OR MOISTURE.

Dear Customer:

Thank you for purchasing our latest TV set.

Please read this instruction manual carefully first before operation so that you can use it in a safe and reliable manner and bring all its functions into full play. Please also keep it properly for future reference.

Preparation

For ventilation, leave a space of at least 10 cm free all around the set. To prevent any fault and unsafe situations, please do not place any objects on top of the set.

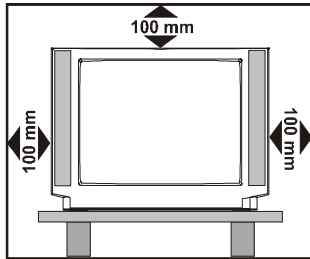

Use this apparatus in tropical and/or moderate climates.

Features

- It is a remote controlled colour television.
- 100 programmes from VHF, UHF bands or cable channels can be preset.
- It can tune cable channels.
- Controlling the TV is very easy by its menu driven system.
- It has three Euroconnector socket for external devices (such as computer, video, video games, audio set, etc.)
- Optional mono or stereo sound systems (German + Nicam) are available.
- Full function Teletext (Fastext).
- It is possible to connect headphone.
- Direct channel access.
- A.P.S. (Automatic Programming System).
- All programmes can be named.
- Programme swapping between last watched two programmes.
- Forward or backward automatic tuning.
- Sleep timer.
- Child Lock.
- Automatic sound mute when no transmission.
- When no valid signal is detected, after 5 minutes the TV switches itself automatically to stand-by mode.
- WSS (Wide Screen Signaling).
- NTSC Playback.
- **YCbCr Mode.**
- Front AV in.
- Headphone.

Before Switching on your TV

Power connection

IMPORTANT: The TV set is designed to operate on **240V AC, 50 Hz.**

- After unpacking, allow the TV set to reach the ambient room temperature before you connect the set to the mains.

Connections to the RF input socket

- Connect the aerial or cable TV plug to the RF input socket located at the back of the TV and connect the cable plug coming out from the TV out socket located at the devices (VCR, DVB etc.) to this socket as well.

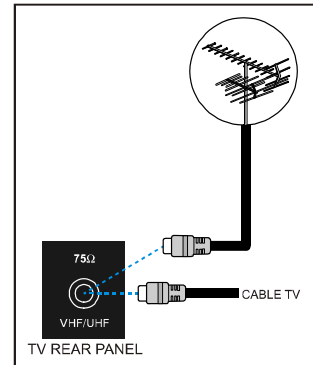

How to connect other devices

IMPORTANT: Switch off the TV before connecting any external device.

Sockets for external connections are at the back and front of the TV. For connection of other devices via Euroconnector refer to the manuals of the related devices.

Inserting batteries in the remote control handset

- Place the batteries in the right directions as seen below.
- Remove the battery cover located on the back of the handset by gently pulling upwards from the indicated part.
- Insert two **AAA (R03)** or equivalent type batteries inside.
- Replace the battery cover.

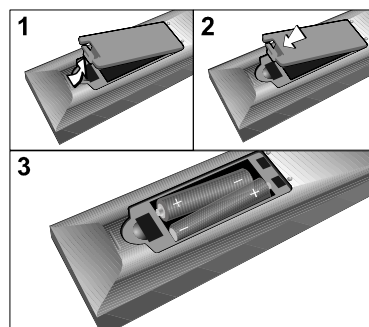

NOTE: Remove batteries from remote control handset when it is not to be used for a long period. Otherwise it can be damaged due to any leakage of batteries.

Switching the TV ON/OFF

To switch the TV on

Your TV will switch on in two steps:

1- Press the power button located on the front of the TV. Then the TV switches itself to standby mode and the **RED LED** located below the TV turns on.

2- To switch on the TV from stand-by mode either:

Press a digit button on the remote control so that a programme number is selected,

or,

Press Programme Up or Down buttons on the front of the TV or on the remote control, so that last switched off programme is selected.

By either ways the TV will switch on and the **RED LED** will turn **GREEN**.

To switch the TV off

• Press the stand-by button on the remote control, so the TV will switch to stand-by mode and the **GREEN LED** will become **RED**,

or,

Press the power button located on the front of the TV, so the TV will switch off and the **GREEN LED** will turn off.

Operating the TV

You can operate your TV both using the remote control handset and onset buttons.

A.P.S. (Automatic Programming System)

The **A.P.S.** menu will appear when you first switch on your TV for the first time.

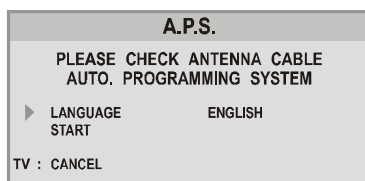

A.P.S. automatically programmes your TV, according to the transmission of programme systems in your area.

- By pressing the “▽” or “△” buttons, come to the Language item and select the language in which the menus of the TV will appear. You can see the available languages by pressing “◀” or “▶” button. As soon as you change the language, the menu items will be displayed in the selected language.
- If you want to start **A.P.S.**, by pressing the “▽” or “△” buttons, come to the **Start** item and by pressing “◀” or “▶” button start the **A.P.S.**.

- If you do not want to start **A.P.S.**, you can cancel it by pressing the “TV” button on your remote control.
- When you start **A.P.S.** the below menu will appear on the screen.

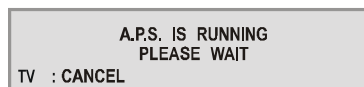

Operating with the buttons on the TV set

Volume setting and programme selection can be made using the buttons on the front of the TV.

Volume Setting

- Press “-▲” button to decrease volume or “▲+” button to increase volume, so a volume level scale (slider) will be displayed in the lower middle side of the screen.

Programme Selecting

- Press “P/CH+” button to select the next programme or “-P/CH” button to select the previous programme.

Entering MENU

- Press “MENU” button to enter the **MENU**. In the **MENU** select sub-menu using “-P/CH” or “P/CH+” button and enter the sub-menu using “-▲” or “▲+” button. To learn the usage of the menus, refer to the Menu System section.

Operating with Remote Control

The remote control handset of your TV is designed to control all the functions of the model you selected. The functions will be described in accordance with the menu system of your TV.

Functions of the menu system are described in Menu System section.

Volume Setting

Press “▲+” button to increase volume. Press “-▲” button to decrease volume. A volume level scale (slider) will be displayed at the middle of the bottom on the screen.



Programme Selecting (Previous or next programme)

- Press “-P/CH” button to select the previous programme.
- Press “P/CH+” button to select the next programme.

Programme Selecting (direct access)

Press digit buttons on the remote control handset to select programmes between 0 and 9. TV will switch to the selected programme. To select programmes between 10 - 99, you must use the double digit button "-/-".



P-- this OSD is displayed at the left hand upper on the screen.

After then, press the digit buttons consecutively which programme you want to select (eg. for programme 27, first press 2 and then 7). When it is late to press any digit button this function will be ignored and the display will be erased. In the same way it must not be late to press any digit button after entering the first digit. The limit of the delay time is 3 seconds.

Press directly the programme number to reselect single digit programmes.

Programme Swapping

- Press "P<P" (programme swap) button to select the last selected programme. This button provides swapping between last two selected programmes. For example, select programme 8, then select programme 2. Now, if you press "P<P" button, programme 8 will be selected. If you press the same button again, programme 2 will be selected and so on.

Menu System

Your TV has been designed with a menu system, to provide an easy manipulation of a multi-function system. The TV is controlled by choosing the commands, which are displayed on the screen.

Press the "M" button. The **MENU** will be displayed in the middle on the screen.

All the selected items in this menu system is indicated with **HIGHLIGHTED** characters and with an arrow on the leftside of items.

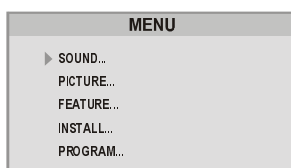

To select a sub-menu use " \uparrow " or " \downarrow " button, and press " \leftarrow " or " \rightarrow " button. Each option can also be selected with the coloured button and "i" button on the remote control.

MENU

The menu system is described below.

The short way in order to enter the menus, press :

"M" Button,	Menu.
Red Button,	Sound Menu.
Green Button,	Picture Menu.
Yellow Button,	Feature Menu.
Blue Button,	Install Menu.
"Info" Button,	Program Menu.

Menu button has two functions; first is opening or closing the "M", and the second is closing the sub-menu and then opening its parent menu.

Sound Menu

To change sound settings

- Enter the Sound Menu directly, pressing the Red button or,
- As you enter the **MENU**, sound will be the first selected option. In the **MENU**, select **SOUND** using " ∇ " or " Δ " button, then enter the sound menu pressing " \leftarrow " or " \rightarrow " button.

Setting Volume

As you enter the sound menu, Volume will be the first selected option.

- Press " \rightarrow " button to increase volume.
- Press " \leftarrow " button to decrease volume.

Or you can directly change the volume settings using " $\blacktriangle+$ " (to increase) or " $-\blacktriangle$ " (to decrease) button.

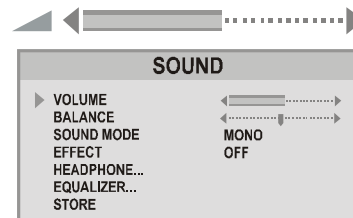

Setting Balance

It allows adjusting the distribution between the left and right speakers.

- Using " ∇ " or " Δ " button select Balance.
- Press " \rightarrow " button to change balance rightward.
- Press " \leftarrow " button to change balance leftward.

When balance control is in mid position, the cursor is displayed with the two reciprocal arrows.

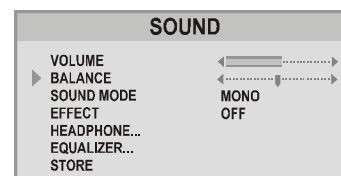

Selecting Sound Mode

- Using “▽” or “△” button select Mode.
- Press “◀” or “▶” button to change Mode.

You can select **MONO**, **STEREO**, **DUAL-I** or **DUAL-II** mode, only if the selected channel supports that mode.

You can also change sound mode directly pressing “I-II” button on your remote control.

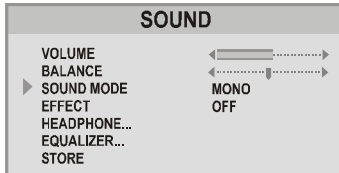

Setting Effect

You can use this feature to switch **ON** and **OFF** sound effect. Pressing “◀” or “▶” button will turn on or off this feature. If the current sound system is Mono and the sound effect is set ON, then the sound will be heard as if it is Stereo. If the current sound system is Stereo, switching this effect on will make the sound deeper. Switching it off will make no change in Mono and Stereo.

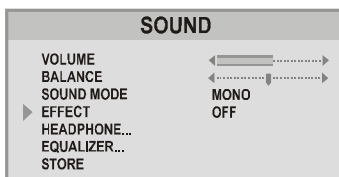

In case of bilingual broadcast (Dual Sound), you can select original or dubbed language using mode option.

To Change Headphone Sound Settings

Pressing “▽” or “△” button on **Headphone**, enter the Headphone menu. This is a sub-menu of Sound menu, and all options in this menu are working as the same in the Sound menu.

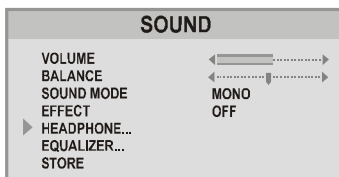

Setting Headphone Volume

- As you enter the Headphone sound menu, Volume will be the first selected option.
- Press “▶” button to increase volume.
- Press “◀” button to decrease volume.



Setting Headphone Sound Mode

- Using “▽” or “△” button select **Mode**.

Pressing “◀” or “▶” button will change the current sound mode. (e.g.: If the current sound mode is stereo, it will be stereo or visa versa).

In case of bilingual broadcast, you can select original or dubbed language again using mode menu. So when somebody listens to the original language from the loudspeakers, somebody else can listen to the dubbed language from headphone.

To Store the Headphone Settings

- Using “▽” or “△” button select Store. Press “◀” or “▶” button to store current headphone volume and balance. The stored values will be valid for all the programmes.

Equalizer

To enter Equalizer sub-menu, select Equalizer using “▽” or “△” button, then enter Equalizer menu pressing “◀” or “▶” button.

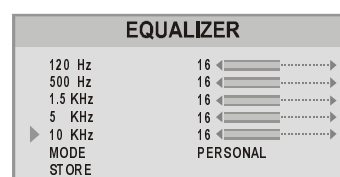
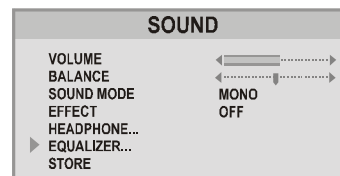

In **Mode** item there are four predefined and one user defined options. These are **PERSONAL**, **MUSIC**, **SPEECH**, **JAZZ** and **FLAT**. The predefined options can not be changed by the user. The **Personal** option may be adjusted by the user.

The 5 items below the **Mode** are available to adjust the sound settings in 5 frequency values: 120 Hz, 500 Hz, 1.5 kHz, 5 kHz and 10 kHz. To change the values of 5 frequency options, select one of the options by “▽” or “△” button, and then press “▶” to increase the value, or “◀” to decrease the value.

To store the Equalizer settings, press “◀” or “▶” button on “**Store**” option.

Setting Avl

Automatic Volume Limiting (AVL) function normalizes sound to obtain fixed output level between programs, having different sound levels. Pressing “◀” or “▶” button will turn **ON** and **OFF** this feature.

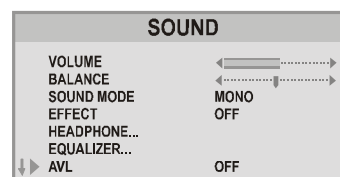

To Store the Settings

- Press “◀” or “▶” button on “**STORE**” option to store Sound menu settings.

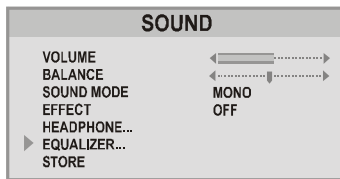

Picture Menu

- To enter the Picture menu directly, press the “**GREEN**” button, or
- Press “**M**” button, now you are in **MENU**. In the **MENU**, select “**PICTURE**” using “◀” or “▶” button, then enter the Picture menu pressing “◀” or “▶” button.

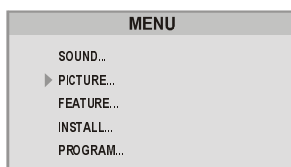

Note: When Picture Mode is not “**MANUAL**”, BRIGHTNESS, CONTRAST and COLOUR options can not be reached by “◀” or “▶” buttons.

Setting Brightness

You can change **Brightness** only when Picture Mode is selected **MANUAL**.

- As you enter the picture menu, Brightness will be the first selected option.
- Press “▶” button to increase brightness.
- Press “◀” button to decrease brightness.

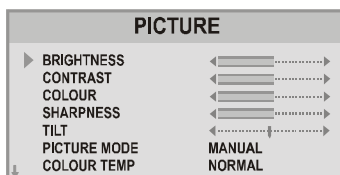

Setting Contrast

You can change **Contrast** only when Picture Mode is selected **MANUAL**.

- Using “◀” or “▶” button select Contrast.
- Press “▶” button to increase contrast level.
- Press “◀” button to decrease contrast level.

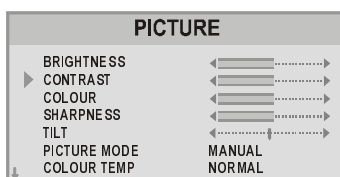

Setting Colour

You can change **Colour** only when Picture Mode is selected **MANUAL**.

- Using “◀” or “▶” button select Colour.
- Press “▶” button to increase colour level.
- Press “◀” button to decrease colour level.

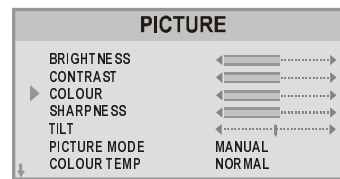

Setting Sharpness

- Using “◀” or “▶” button select Sharpness.
- Press “▶” button to increase peaking level.
- Press “◀” button to decrease peaking level.

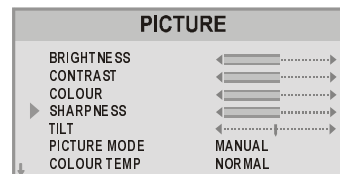

Setting Tilt

- Using “◀” or “▶” button select Tilt.
- Press “▶” button to increase tilt level.
- Press “◀” button to decrease tilt level.

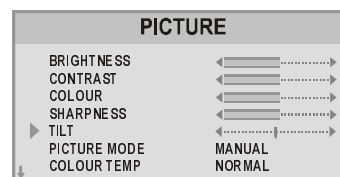

Setting Hue

(During Playback NTSC system, this will appear in AV mode only when NTSC video source is applied. Otherwise, HUE option is invisible in Picture menu.):

- Using “◀” or “▶” button select Hue.
- Press “▶” button to increase hue level.
- Press “◀” button to decrease hue level.

Center value is indicated with the two reciprocal arrows.

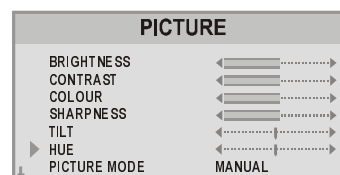

Setting VCR Mode

- Using “◀” or “▶” button select VCR Mode.
- When you watch a picture from your VCR and the picture is unstable, you may improve it by changing the “**VCR MODE**” setting from “**ON**” to “**OFF**”.

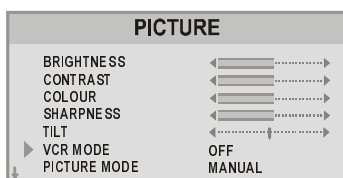

Setting Picture Mode

This item is used to change the picture mode. By pressing “◀” or “▶” button you may select one of these options: **BRIGHT**, **STANDARD**, **SOFT**, **MANUAL**.

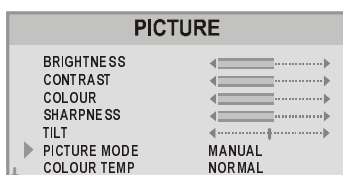

Setting Colour Temp

This item is used to change the Colour Temperature. By pressing “◀” or “▶” button you may select one of these options: **COOL**, **WARM**, **NORMAL**.

Note: Colour Temperatures transitions are become slowly.

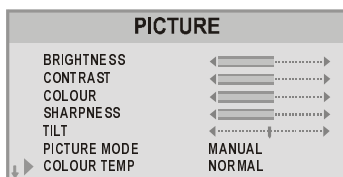

Setting Zoom

You can change the screen size according to the picture aspect ratio. Select the optimum one from the following **ZOOM** modes.

AUTO:

When a **WSS (Wide Screen Signalling)** signal, which shows the aspect ratio of the picture, is included in the broadcast signal or the signal from an external device, the TV automatically changes the **ZOOM** mode to **16:9** mode or **4:3** mode according to the **WSS** signal.

- When the **AUTO** mode does not function correctly due to poor **WSS** signal quality or when you want to change the **ZOOM** mode, change to another **ZOOM** mode manually.

Using the different screen formats

Press the “◀” or “▶” button to select the different modes: **4:3**, **16:9**, **CINEMA**, **SUBTITLE** and **ZOOM**.

You can also access these settings with “⊞” button.

4:3

The picture is reproduced in 4:3 format and a black band is displayed on either side of the picture. The picture may be progressively enlarged using the “▽” or “△” buttons.



16:9

This mode restores the correct proportions of pictures transmitted in 16:9 using full screen display.

Note: If you display a 4:3 picture in this mode, it will be enlarged horizontally.

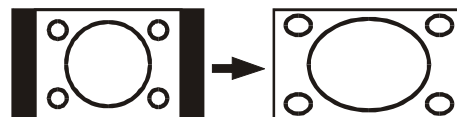

CINEMA

The picture is enlarged to CINEMA format, a thin black band remains on both sides of the picture. The “▽” or “△” buttons allow you to compress and move the image vertically to view the top or bottom of the picture (subtitles).

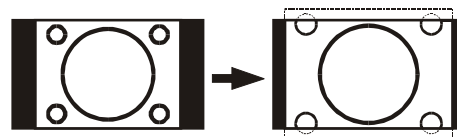

SUBTITLE

This mode is used to display 4:3 pictures using the full surface of the screen leaving the sub-titles visible. Use the “▽” or “△” buttons to increase or decrease the compression at the bottom of the screen.

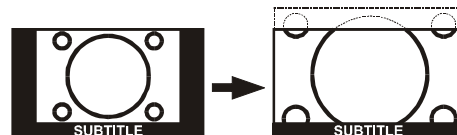

ZOOM

The picture is enlarged to 16:9 format. This mode is recommended when displaying pictures which have black bands at the top and bottom (letterbox format).

Use the “▽” or “△” buttons if you wish to compress and move the image vertically to view the top or bottom of the picture.

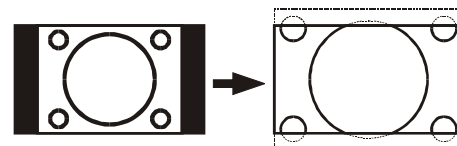

Select the ZOOM mode:

Press the “◀” or “▶” button to select a **ZOOM** mode.

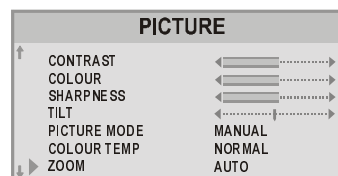

Adjusting the visible area of the picture:

If subtitles or the top (or bottom) of the picture are cut off, you can adjust the visible area of the picture manually.

1. Press "**EX**" button once.

The **ZOOM** mode indicator appears. The **ZOOM** mode will not be changed.

2. While it is displayed, press "▽" or "△" buttons to change the position of the picture.
- You can not adjust the visible area in **4:3** or **16:9** mode.

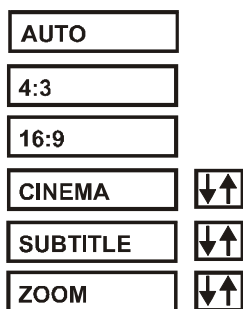

To Store the Settings

- Press "◀" or "▶" button on **STORE** option to store Picture menu settings.

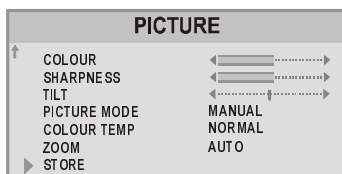

Feature Menu

- To enter the **Feature** menu directly, press the "**YELLOW**" button, or
- Press "**M**" button, now you are in **MENU**. In the **MENU**, select **Feature** using "▽" or "△" button. Then enter the **Feature** menu pressing "◀" or "▶" button.

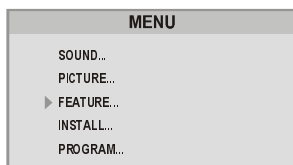

Sleep Timer

As you enter the **Feature** menu, **Sleep Timer** will be the first selected option. Use "◀" or "▶" button to change the Sleep Timer values between **OFF, 10, 20, 30,, 110** and **120**.

If sleep timer is activated, at the end of the selected the time, the TV goes automatically to stand-by mode.

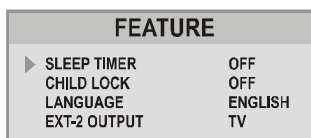

Child Lock

You can use this feature to prevent children turning on TV or changing programs or adjustments etc. without remote control.

The **Child Lock** feature can be set by "◀" or "▶" button to either **ON** or **OFF**. When **OFF** is selected, there will be no difference in the operation of your TV. When **ON** is selected, the TV can only be controlled by the remote control handset. In this case, the front panel buttons (except the Power On/Off button) will not work.

If Child Lock is ON, when one of the front panel buttons (except power button) is pressed, "**CHILD LOCK**" OSD is seen on the screen.

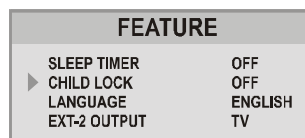

Selecting Menu Language

Menu language can be selected by pressing "◀" or "▶" button on **Language** item.

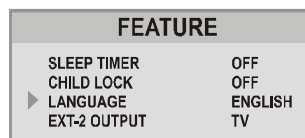

EXT-2 Output

From EXT-2 Output, either **TV, EXT-1** or **F-AV** can be given. **TV, EXT-1** or **F-AV** can be selected by pressing "◀" or "▶" button on "**EXT-2 OUTPUT**".

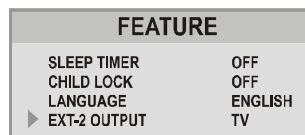

To Store Settings

In **Feature** menu all settings are stored automatically.

Installation Menu

- To enter the **Install** menu directly, press the **BLUE** button, or
- Press "**M**" button, now you are in **MENU**. In the **MENU**, select "**Install**" using "▽" or "△" button. Then enter the Install menu pressing "◀" or "▶" button.

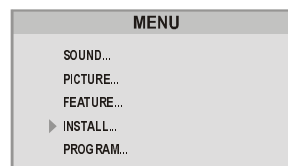

1. Selecting Programme

To select programme number, you can use “◀” or “▶” button, Digit Buttons or The Double Digit button with digit buttons.

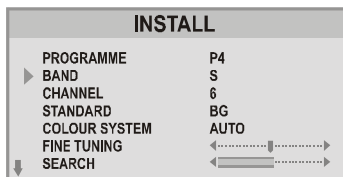

2. Selecting Band

BAND, can be selected either,

- “C” or “S” by “◀” or “▶” button.

For band C,

01 - 83, WEST EUROPE.

01 - 12, 21 - 69, EAST EUROPE .

01 - 17, 21 - 73, UK.

01 - 76, FRANCE.

04 - 09, FRANCE 2.

For band S,

01 - 41, for all channel tables.

3. Standard

The “STANDARD” setting is fixed to “**BIG**”. You cannot change this item’s setting.

4. Selecting Colour System

This item is used to change the colour system. If the picture is not clear or no colour appears, select the correct colour system to display the picture normally. When the TV is in TV mode; by pressing “◀” or “▶” button you may select one of these options: **PAL**, **SECAM**. When the TV is in AV mode; you may select one of these options: **AUTO**, **PAL**, **SECAM**, **NTSC 3.58**, **NTSC 4.43**.

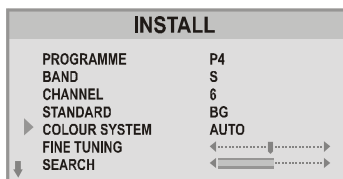

5. Selecting Fine Tuning

You can use the Fine Tuning process for fine adjustment (after coarse adjustment), if you are not happy about the image on the screen.

Use “◀” or “▶” button on **FINE TUNING** item, until getting the best image on the screen.

In Channel option, normally the Fine Tuning cursor is placed at the middle on the slider, and this is indicated with the two reciprocal arrows.

6. Selecting Search

To start the search process, press “▶” button for forward search or “◀” button for backward search. **Search** item bar blinks during search process, up to the process is stopped or signal is found. To stop the search process “◀” or “▶” button must be pressed again.

7. To Store Settings

Press “◀” or “▶” button on **STORE** option to store Install menu settings.

Program Menu

- To enter Program menu directly, press the “**i**” button, or
- Press “**M**” button, now you are in **MENU**. In the **MENU**, select “**Program**” using “◀” or “▶” button. Then enter the Program menu pressing “◀” or “▶” button.

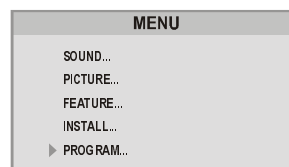

Moving cursor to four direction you can reach 30 programmes in the same page. By scrolling the pages up or down by pressing the navigation buttons you can select all the programmes in TV mode (except the AV mode).

In menus, “◀” or “▶” buttons are working like "Direction Up" and "Direction Down".

By cursor action, programme selection is done automatically. Selected programme is displayed with “**HIGHLIGHTED**” characters.

Programme Number is between 00 and 99. Programme Name has a name string with 4 characters. After autostore process the Programme Names are set to:

- Channel search “**C01**” or “**S01**” (band and channel number), as default.

At the bottom of the menu there is a programme sort functions section. Each function is activated by color button. **NAME** allows changing the programme name. By **DELETE** you can delete programmes that you decided. **INSERT** section is for inserting programmes into another programme spaces. By selecting **AUTO-STORE** section, Autostore menu will be available.

To change the name of a decided programme, that programme is selected and pressed to the **RED** button (**NAME**). First letter of the selected **NAME** is displayed with **HIGHLIGHTED** character. To change that letter “◀” or “▶” button can be used, and to select the other letters, “◀” or “▶” button can be used. If the cursor is at the last letter of the Programme Name, pressing “▶” button moves the cursor at the beginning. On the

contrary, if the cursor is at the beginning of the Programme Name, pressing “<” button moves the cursor at the end.

PROGRAM		
01 C 12	11 ----	21 ----
02 C 23	12 ----	22 ----
03 C 45	13 ----	23 ----
04 C 47	14 ----	24 ----
05 C 50	15 ----	25 ----
06 C 55	16 ----	26 ----
07 ----	17 ----	27 ----
08 ----	18 ----	28 ----
09 ----	19 ----	29 ----
10 ----	20 ----	30 ----
NAME	INSERT	
DELETE	AUTOSTORE	

After changing the name by pressing the **RED** button (**STORE**) it is stored. After activating the name process the “**INSERT**”, “**DELETE**” and “**AUTOSTORE**” processes will be inactive and “**CANCEL**” and “**STORE**” options are invalid. “**CANCEL**” option cancels the name process, if the new name do not want to be stored.

When it is pressed to **GREEN** button (**INSERT**), “**NAME**”, “**AUTOSTORE**” and “**DELETE**” functions are erased, the selected programme (A) is displayed with green characters. From now on, the automatic selection is canceled. Cursors moves are indicated with “**HIGHLIGHTED**” characters. With navigation buttons, the decided program space (B) can be selected and by pressing the green button again inserting is occurred to that space (B).

It should be thought that Prog-00 is the lowest programme (like Prog-100). If any programme is inserted to Prog-00, the programmes under that programme space shift one up, and Prog-99 is adjusted to the first frequency value of VHF1 (40 MHz).

If Prog-00 is inserted to any programme space, all the programmes under that space shift one down and Prog-99 is erased, and Prog-00 is adjusted to the first frequency value of VHF1 (40 MHz).

“**CANCEL**” function cancels the activated “**INSERT**” process.

For “**DELETE**” process it is pressed to yellow button, (“**NAME**”, “**INSERT**” and “**AUTOSTORE**” functions are inactive). The selected programme is displayed with yellow characters. Pressing yellow button again erases the selected programme from the programme list, and the programmes below shift one up. Prog-00 is adjusted to the first frequency value of VHF1 (40 MHz). Pressing blue button cancels the activated “**DELETE**” process.

To enter Autostore menu, press to the blue button. To learn the features of this function see “**AUTOSTORE**” below.

Autostore

(A.P.S. (Automatic Programming System))

A.P.S. automatically programmes your TV, according to the transmission of programme systems in your area.

If you want to make **A.P.S.** any other time:

- Press “**M**” button, now you are in **MENU**.
- Select “**Program**” menu using “**▽**” or “**△**” button.
- Press “**<**” or “**>**” button to enter the “**Program**” menu.
- In the “**Program**” menu enter **AUTOSTORE** menu by pressing **BLUE** button. Here you can run **A.P.S.** (Automatic Programming System). **A.P.S.** automatically programmes your TV, according to the transmission of programme systems in your area.

A warning message will appear on the screen as below :

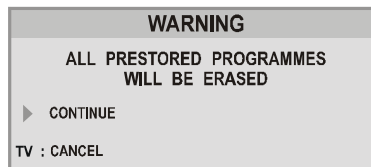

- If you want to **Continue**, by pressing “**<**” or “**>**” button start the **A.P.S.**.
- When you start **A.P.S.** the below menu will appear on the screen.

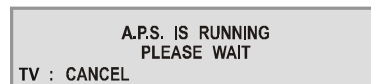

After **A.P.S.** is finalized, a rank list will appear on the screen. In the rank list you will see the programme numbers and names, assigned to the programmes. First the programme with programme number 1 will be displayed with “**HIGHLIGHTED**” characters. Using “**▽**” or “**△**” or “**<**” or “**>**” buttons you can move the highlighted number and then display the programme corresponding to the highlighted number.

If you do not accept the correspondence between programme numbers and names and want to change them, press “**M**” button and then **BLUE** button, so that you enter the Installation menu.

Other Features

1) TV Status

Programme Number, **Programme Name** (or **AV**) and **Sound Indicator** are displayed on the upper left of the screen. They are displayed after programme change during 3 seconds.

P01 Programme Number

PR01 Programme Name (4 characters)

These OSD's are displayed when a new programme is entered by digit button, by pressing “**P<P**” button, or by “**▽**” or “**△**” button, or by “**TV**” button.

2) Programme Swap (P<P)

This button is used to reenter to the preceding entered programme again. Pressing “**P<P**” consecutively allows to swap into two last entered programmes.

3) Double-digit (- -)

This OSD is displayed when the "Double-Digit" button pressed in place of the programme number indicator.

P - -

After then, in order to enter a programme it must be pressed to two digit consecutively. When it is late to press any digit button this function will be ignored and the display will be erased. In the same way it must not be late to press any digit button after entering the first digit. The limit of the delay time is 3 seconds.



4) Personal Preferences (PP)

All the preset values will be restored, when pressing "PP".

PP

5) Sound Indicator

This is a stereo option. The alternatives of the indicator are Mono, Stereo, Dual-I and Dual-II. This indicator is displayed under the programme number indicator on the screen. "I-II" button is used to select Mono, Stereo, Dual-I or Dual-II.

In Mono broadcast or in forced-mono (for stereo broadcast).

MONO

In Stereo broadcast.

STEREO

If dual broadcast detected. Dual-I is selected in default and also can be selected after Dual-II by Remote Control.

DUAL-I

If Dual-II selected by Remote Control.

DUAL-II

6) Picture Mode

The picture mode OSD is displayed below the sound indicator, by TV Status OSD's. According to the WSS data, inside of the OSD box "4:3", "16:9", "CINEMA", "SUBTITLE", "ZOOM" or "AUTO" is written.

By pressing "EX" (TXT_UPDATE) button (if Teletext is not active) the picture mode can be switched into 4:3, 16:9, CINEMA, SUBTITLE, ZOOM or AUTO Mode.

4:3

7) Blue Background During No-Signal

In case, no valid signal is detected (in TV or AV mode) Blue Background is activated. During search process Blue Background is not active. But instead of it there is another feature given; the semi-transparent menu background is made blue.

8) Mute Indicator

It is placed in the upper middle of the screen when enabled, and it stays there until it is disabled.



To cancel mute, there is two alternative; the first one is pressing to "X" button, thus volume is set to the preceding value, and the second one is increasing the volume level, thus it starts at the minimum level to increase. By decreasing the volume level in mute state, mute will not be ignored, only the volume level will decrease. If mute canceled after decreasing the volume level, the volume will valid with the decreased level.

9) Volume Bar

It is displayed in the lower middle of the screen. When a volume command is received (pressing "-▲" or "▲+" by Remote Control or Front panel) and no menu is active, it stays on the screen for 3 seconds, after the last volume command or until another command is received in between.



10) AV Modes

By pressing the "AV" button you can switch your TV to AV modes (except being in Teletext). Pressing this button will switch the TV in one of the optional AV modes: EXT-1, RGB, YCbCr and F-AV (Front AV). EXT-1 supports the RGB mode.

In order to quit the AV mode press the "TV", digit buttons or "-P/CH" or "P/CH+".

Teletext

Teletext is an information system that displays text on your TV screen. Using the Teletext information system you can view a page of information on a subject that is available in the list of contents (index).

On screen display is not available in text mode.

Contrast, brightness or colour control is not available, but volume control is available in text mode.

1) To operate Teletext

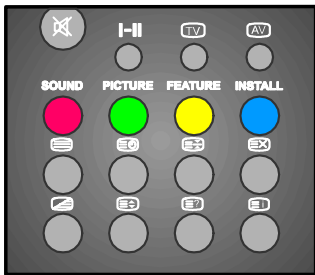

- Select a TV station on which Teletext is being transmitted.
- Press (TELETEXT) “” button. Usually the list of contents (index) is displayed on the screen.



2) To select a page of Teletext

- Press the appropriate digit buttons for the required Teletext page number.

The selected page number is displayed at the top left corner of the screen. The Teletext page counter searches until the selected page number is located, so that the desired page is displayed on the screen.

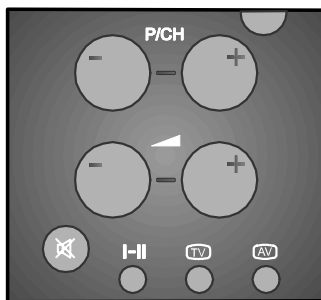

- Press “” button to move the Teletext screen forward one page at a time.
- Press “” button to move the Teletext screen backward one page at a time.





3) To Select Index Page

- To select the page number of the index (generally page 100), press “” button.



4) To Select Teletext with a TV Programme

- Press “” button. The text is now superimposed over the programme on the screen.
- Press “” button again to return to the Teletext page.



5) Searching for a page while watching TV

- While Teletext Mode is on, pressing “” will change the mode to TV, one more press to “” will change the mode from TV to the latest Teletext page we left. In the TV mode enter a page number using digit keys. As you enter digits first line of teletext page will appear on top screen and will remain there until the requested page is found. Then teletext line will be replaced by page number to indicate that page has been found. Now you can display this teletext page pressing “” button.

6) To Select Double Height Text



- Press “” button for the upper half of the information page to be displayed in double height text.
- Press “” button again for the lower half of the information page to be displayed in double height text.
- Press “” button once more for the full page of normal height text.

7) To Reveal “concealed” Information

- Pressing “” button once will reveal answers on a quiz or games page.
- Pressing “” button again will conceal the revealed answers.

8) To Stop Automatic Page Change

The teletext page you have selected may contain more information than what is on the screen; the rest of the information will be displayed after a period of time.

- Press “” button to stop the automatic page change.
- Press “” button again to allow the next page to be displayed.

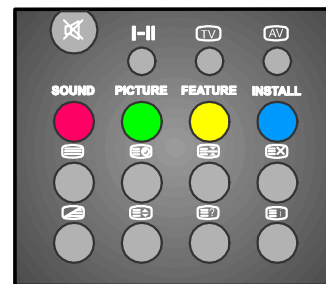

9) To Select a Subcode Page

Subcode pages are subsections of long Teletext pages that can only be displayed on the screen one section at a time.

- Select the required Teletext page.
- Press “” button.
- Select the required subcode page number by pressing four digit buttons (e.g. 0001).

- If the selected subcode page is not displayed in a short time, press “**EXIT**” button. TV programme will be displayed on the screen.
- Teletext page number will be displayed on the upper left corner of the screen when the selected page is found.
- Press “**EXIT**” button to display the selected Teletext page.

10 To exit Teletext

- Press “**TV**” button. The screen will switch to TV mode.

11) To Display the Time

- While watching a TV programme with Teletext transmission press “**TIME**” button. The current time information, captured from Teletext will be displayed at the upper right of the screen.
- If the programme being watched does not have Teletext transmission, no information will be displayed.

12) Fastext

Your CTV supports the 7 page Teletext system. When the page number of any of the 7 pages in memory is entered, the system will not search for the requested page; instead it will display the page automatically.

- Press “**Δ**” button to move the Teletext screen forward one page at a time.
- Press “**▽**” button to move the Teletext screen backward one page at a time.

For Fastext

The subject-heading for the information may have a particular colour.

- Press an appropriate **RED, GREEN, YELLOW** or **BLUE** button in order to reach the relevant page quickly.

Connect Peripheral Equipment

There is a wide range of audio and video equipment that can be connected to your TV.

The following connection diagrams show you where the different equipment should be connected at the back or the front side of the TV.

1) Via the Euroconnector

Your TV set has two Euroconnector sockets. If you want to connect peripherals (e.g. video, decoder, etc.) which have Euroconnectors to your TV, use optional **EXT.1** or **EXT.2** inputs.

If an external device is connected via **EXT.1** Euroconnector socket TV is switched to AV mode automatically. If the signal is RGB then the RGB OSD indicator is displayed on the screen.

2) YCbCr Mode

This mode is only used for the equipment which have **YCbCr** signal at their output. You can watch only **YCbCr** signal at this mode. RGB, Y/C or CVBS signals can not be watched.

3) Via Ant Input

If you want to connect to your TV, peripherals like video recorders or decoders, but the device you want to connect does not have Euroconnector, you should connect it to the ANT input of your TV set.

If the VCR is connected via antenna input it is suggested to use the Programme 0.

4) Decoder

Cable TV offers you a wide choice of programs. Most of them are free, others are to be paid for by the viewer. This means that you will need to subscribe to the broadcasting organisation whose programmes you wish to receive. This organisation will supply you a corresponding decoder unit to allow the programmes to be unscrambled.

For further information ask your dealer. See also the booklet supplied with your decoder.

a) Connect a decoder with an aerial socket to the TV

- Connect the aerial cable.

b) Connect a decoder without an aerial socket to the TV

- Connect the decoder to your TV with a eurocable to **EXT.1**. When your decoder has a Euroconnector you can obtain better picture quality if you connect a eurocable to **EXTERNAL**.

5) TV and Video Recorder

- Connect the aerial cables.

Better picture quality can be obtained if you also connect a eurocable to **EXTERNAL** sockets.

6) Playback NTSC

Connect NTSC VCR player to Euroconnector at the back of the TV.

Connect NTSC VCR player to RCA Jack at the front of the TV.

Then, press "**AV**" button to select (**EXT-1, RGB, YCb-Cr** and **F-AV**).

7) Copy Facility

Source selection for **VCR** recording.

- Select Features Menu in the **MENU**.
- Select **EXT-2 OUTPUT** source pressing "**<**" or "**>**" button.

8) Search for and store the test signal of the video recorder

- Unplug the aerial cable from the aerial socket "**ANT**" of your video recorder.
- Switch on your TV and put the video recorder on the test signal. (See the handbook for your video recorder.)
- Enter the Tuning menu via the Install menu.
- Search for the test signal of your video recorder in the same way as you searched for and stored the TV signals. See Tuning, Search and Store TV channels. Store the test signal under programme number 0.
- Replace the aerial cable in the aerial socket "**ANT**" of your video recorder once you have stored the test signal.

9) Camera and Camcorder

To connect to Front-AV input (F-AV):

Connect your camera or camcorder at the front side of your TV.

- Connect your equipment to the TV via **VIDEO** (yellow), **AUDIO R** (red) and **AUDIO L** (white) inputs. You should connect the jacks to the input in the same colour.

10) Connect the decoder to the video recorder

Some video recorders have a special euroconnector for decoder.

- Connect a eurocable to the euroconnector of your decoder and to the special euroconnector of your video recorder. See also the handbook of your video recorder.
- To connect your video recorder to the TV, see TV and Video Recorder section.

If you want to connect more equipment to your TV, consult your dealer.

11) Connecting Headphones

Use the stereo headphone socket on the lower right side of your TV, to connect headphones.

Connect Peripheral Equipment

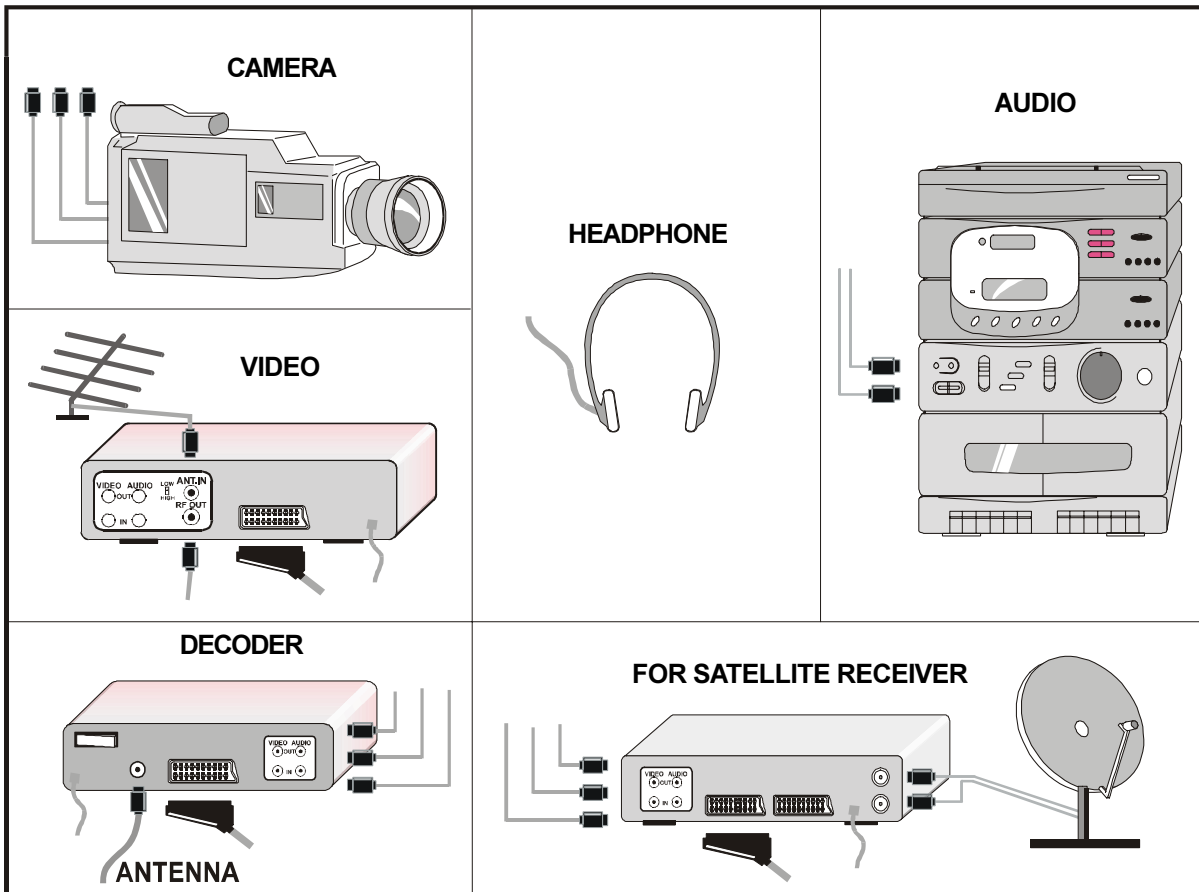

Antenna Connections

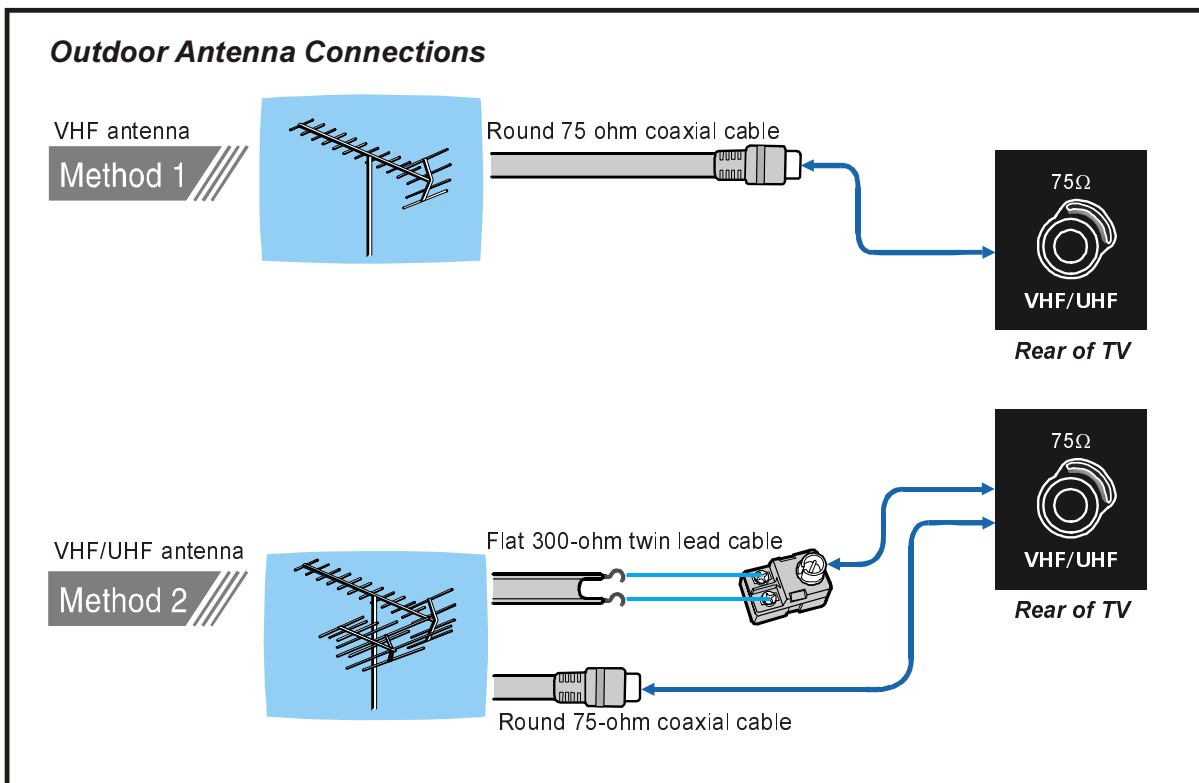

Tips

Care of the Screen

Clean the screen with a slightly damp, soft cloth. Do not use abrasive solvents as they may damage the TV screen coating layer.

Poor Picture

Have you selected the correct TV system? Is your TV set or house aerial located too close to the loudspeakers, non-earthed audio equipment or neon lights, etc.?

Mountains or high buildings can cause double pictures or ghost images. Sometimes you can improve the picture quality by changing the direction of the aerial.

Is the picture or Teletext unrecognizable? Check if you have entered the correct frequency.

The picture quality may degrade when two peripherals are connected to the TV at the same time. In such a case, disconnect one of the peripherals.

No Picture

Is the aerial connected properly? Are the plugs connected tightly to the aerial socket? Is the aerial cable damaged? Are suitable plugs used to connect the aerial? If you are in doubt, consult your dealer.

No Picture means that your TV is not receiving any transmission. Have you pressed the correct buttons on the remote control? Try once more.

Sound

You can not hear any sound. Did you perhaps interrupt the sound, pressing "M" button? Are external speakers connected to the TV?

Sound is coming from only one of the speakers. Is the balance set to one direction extreme? See SOUND menu.

Remote Control

Your TV no longer responds to the remote control. Press the "TV" button on the remote control once more. Perhaps the batteries are exhausted. If so you can still use the local buttons at the front of your TV.

Have you selected the wrong menu? Press "TV" button to return to TV mode or press "M" button to return to the previous menu.

No solution

Switch your TV set off and on. If this does not work, call the service personnel; never attempt to repair it yourself.

Specifications

TV BROADCASTING

PAL B/G

RECEIVING CHANNELS

VHF (BAND I/III)

UHF (BAND U)

Hyperband

CABLE-TV (S1-S20 / S21-41)

NUMBER OF PRESET CHANNELS

100

CHANNEL INDICATOR

OSD (ON SCREEN DISPLAY)

RF AERIAL INPUT

75 Ohm Unbalanced

OPERATING VOLTAGE

240V AC, 50 Hz.

POWER CONSUMPTION (W) (max)

140 Watt

AUDIO OUTPUT

German + Nicam Stereo

PICTURE TUBE

28" 16:9

DIMENSIONS (DxLxH) (mm)

DIMENSIONS			
D	L	H	Weight (kg)
500	812	485	36

TEAC TOTAL CARE

info@teac.com.au

or visit our website at <http://www.teac.com.au>

Freecall telephone 1800-656700 between Monday to Friday - EST 9am to 5pm
[New Zealand: TOLL FREE 0508 347328, 8am to 4:30pm]

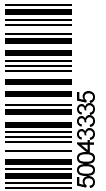

TEAC CORPORATION	3-7-3, Nakacho, Musashino-shi, Tokyo 180-8550, Japan.	Phone: (0422) 52-5081
TEAC AUSTRALIA PTY., LTD. A.B.N. 80 005 408 462		
HEAD OFFICE	280 William Street, Melbourne VIC 3000.	Phone: (03) 9672 2400
NSW OFFICE	Unit 8, 20-22 Foundry Rd., Seven Hills, NSW 2147.	Phone: (02) 8811 4000
QLD OFFICE	335 Montague Road, West End, QLD 4101.	Phone: (07) 3010 0100
WA OFFICE	273 Great Eastern Highway, Belmont, WA 6104	Phone: (08) 9479 6522
SA OFFICE	Cnr. Sir D. Bradman & Marion Roads, Cowandilla, SA 5033.	Phone: (08) 8234 1044