



AUDIOVOX®
ELECTRONICS CORP.

VE-560

Low Profile Television

5.6" LCD Drop Down Under Counter TV

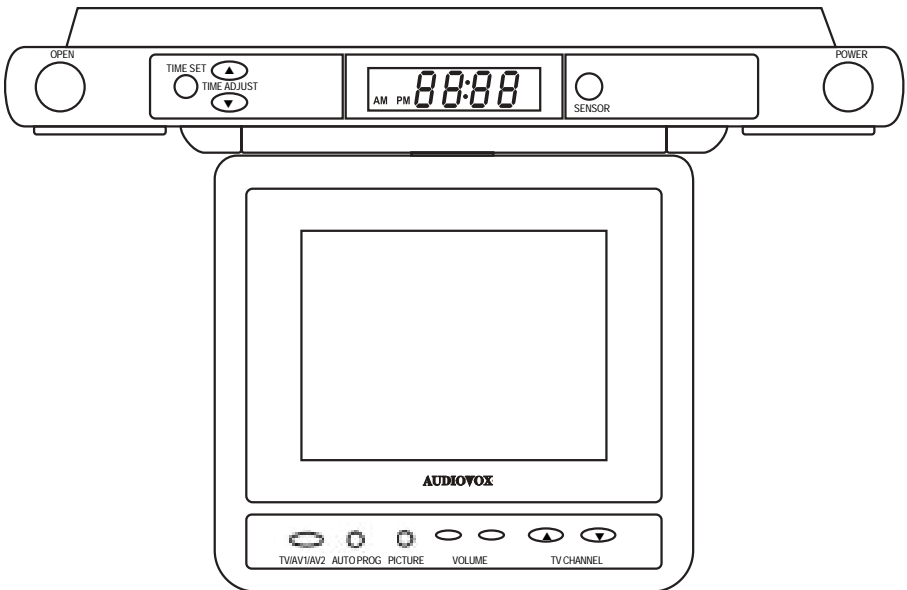

Installation and Operation Manual

FEATURES

- Multi-function Remote Control
- Automatic Channel Programming
- Cable Ready 125 Channel Tuner
- Internal Stereo Speakers
- Wall or Under Cabinet Mounting



For Customer Service
Visit Our Website At
www.audiovox.com
Product Information, Photos,
FAQ's Owner's Manuals

128-6317

NOTE: This Page Left Blank Intentionally

IMPORTANT SAFETY INFORMATION

A. Precautions

- 1) Unplug the unit before cleaning. Do not use liquid cleaners or aerosol cleaners. Use a damp cloth for cleaning.
- 2) Use only Audiovox approved accessories.
- 3) Do not install this video product where it is likely to be exposed to water.
- 4) Do not obstruct the slots and openings in the cabinet. They are provided for ventilation and are necessary to ensure reliable operation of the TV and to protect it from overheating. This TV should never be placed near or over a radiator or heat register. This TV should not be placed in a built-in installation such as a bookcase or rack unless proper ventilation is provided.
- 5) This TV should be operated only with the AC / DC adapter provided.
- 6) Do not overload electrical outlets or use extension cords as this can result in a risk of fire or electric shock.
- 7) Never push objects of any kind into this TV through openings as they may touch dangerous voltage points or short-circuit parts that could result in a fire or electric shock. Never spill liquid of any kind on the TV.
- 8) **Do not attempt to service this TV yourself as opening or removing covers may expose you to dangerous voltage or other hazards. Refer all servicing to qualified service personnel.**
- 9) Unplug this TV from the outlet and refer servicing to qualified service personnel under the following conditions:
 - a) When the power-supply cord or Adapter is damaged.
 - b) If liquid has been spilled, or an object has fallen into the TV.
 - c) If the TV has been exposed to water.
 - d) If the TV does not operate normally when following the operating instructions.
 - e) If the TV has been dropped or the cabinet has been damaged.

B. Kit Components

INCLUDED IN THIS KIT

- 1 VE-560 Television
- 2 Audiovox Remote Control (PN 1361613)
- 3 AC Power Adapter (PN 1541096)
- 4 Mounting template
- 5 Hardware Bag
 - A 10 - 32 x 2 1/2 Mounting screws (4)
 - B 10 - 32 x 3/4 Mounting screws (4)
 - C 10 - 32 x 1 3/4 Mounting screws (4)
 - D 3/4" Spacer (4)
 - E 1/2" Spacer (4)
 - F 1/4" Spacer (4)
 - G Countersunk washer (4)
 - H Self Adhesive Wire mounting clip (2)
- 6 Dipole Antenna

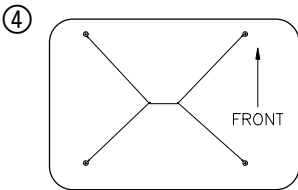
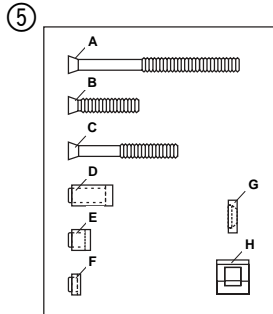
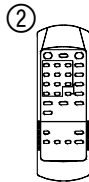
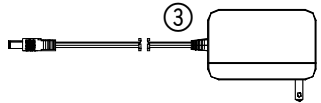
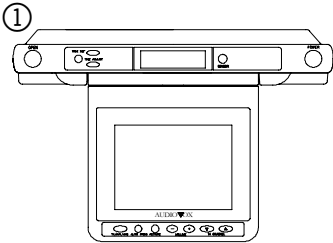

TOOLS REQUIRED

- Philips head screwdriver
- Centerpunch
- 1/4" Drill bit
- Electric Drill
- Adhesive Tape

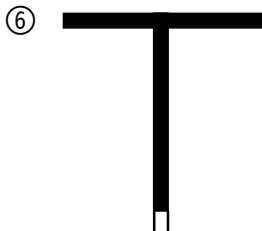

C. Installation

UNDER CABINET INSTALLATION

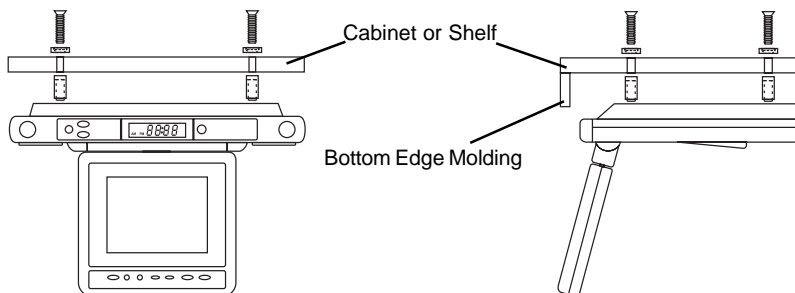

- 1) Choose an appropriate mounting location underneath a cabinet or shelf. Close proximity to an electrical outlet and a TV antenna or cable connection will facilitate a neat, easy installation. Do not mount the VE-560 above a range or oven. Be sure that the location chosen will provide adequate access to the electrical connectors on the rear of the unit before continuing.
- 2) If the location chosen has bottom edge molding it may be necessary to use the mounting spacers provided to effectively lower the VE-560's front panel below the molding. Measure the distance between the bottom of the molding and the bottom of the cabinet. A maximum measurement of 1.5" can be accommodated without using spacers. For larger moldings choose a combination of spacers which will reduce the mounting depth to 1.5" or less.
- 3) Measure the thickness of the bottom of the cabinet or shelf and the spacers chosen. Select the shortest screw length which will pass through the countersunk washer, kitchen cabinet and spacers with between 1/4" and 1 1/2" inches to spare
- 4) Cut out the template supplied and tape it in place onto the cabinet surface to be drilled. Center punch the four holes indicated on the template and remove the template.
- 5) Carefully drill four 1/4" holes at the locations marked above. Place the screws chosen through the countersunk washers and then through the holes from the top down.
- 6) Screw the appropriate spacers on to the screws first, then position the VE-560 and screw it in place using its threaded holes.
- 7) Plug the AC Power adapter into a nearby electrical outlet and into the receptacle marked DC 12V input at the rear of the VE-560
- 8) Connect your TV antenna or cable system to the antenna connector on the rear of the VE-560.
- 9) Route the wires safely away from heat and moisture sources and secure them in place using the self adhesive wire mounting clip provided.

WALL MOUNT INSTALLATION

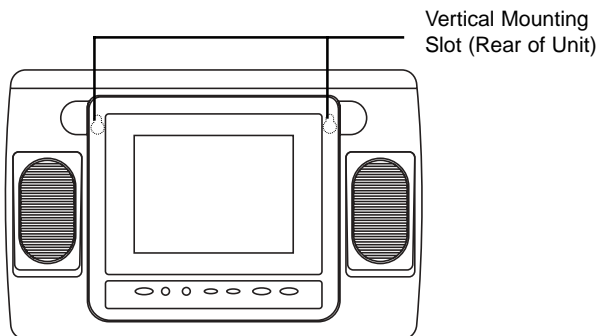

IMPORTANT!! Do not attempt to install the VE-560 vertically, unless you are sure that the electric circuits in the chosen area have been turned off at the fuse or circuit panel. Failure to do this could result in electric shock.

- 1) For vertical installations, choose a mounting location that is close to eye level and is in close proximity to an electrical outlet and a TV antenna or cable connection.
- 2) Cut out the template provided and temporarily tape it to the wall at the desired location. Mark the center of the vertical mounting slot and remove the template.
- 3) Determine if a wall stud is present at the chosen location by drilling a 1/16" hole at the marked location. **CAUTION!!** If this unit is to be installed near an electrical outlet, there is likely to be electrical wiring present.
- 4) If a structural stud is present, a suitable length drywall screw can be screwed directly into it. Leave approximately 1/4" of the screw protruding from the wall.

If there is no structural stud present, a drywall anchor from your local hardware store will be necessary. Remember to leave 1/4" of its screw head protruding from the wall.

- 5) Hang the VE-560 onto the screw head using the vertical mounting slot at the rear of the unit.
- 6) Plug the male end of the adapter into the receptacle marked DC 12V input on the bottom of the VE-560 and AC Power adapter plug into a nearby electrical outlet.
- 8) Connect your TV antenna or cable system to the antenna connector on the bottom of the VE-560
- 9) Route the wires safely away from heat and moisture sources and secure them in place using the self adhesive wire mounting clip provided.

C. Positioning Screen

To release the screen from its locked position, press the OPEN button located on the front panel this will unlock the screen and it will swing downward. Pivot the screen forward until a comfortable viewing angle is reached. The screen may also be rotated from side to side. **NOTE:** Do not force the screen beyond its rotational limit of fifteen degrees. In vertical mount applications it is not necessary to release and position the screen.

D. Controls/Indicators on the Unit

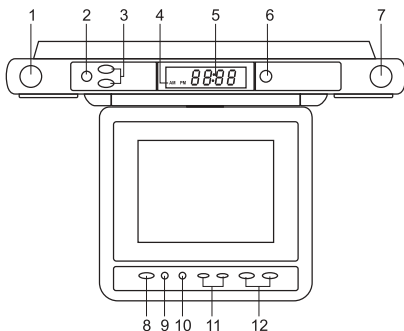

- | | |
|-----------------------------------|--------------------------------|
| 1. OPEN BUTTON | 7. POWER BUTTON |
| 2. TIME SET BUTTON | 8. TV/AV1/AV2 SELECT BUTTON |
| 3. TIME ADJUST UP/DOWN
BUTTONS | 9. AUTO PROGRAM BUTTON |
| 4. TIME AM/PM DISPLAY | 10. PICTURE SELECT BUTTON |
| 5. TIME DISPLAY | 11. VOLUME UP/DOWN BUTTONS |
| 6. REMOTE CONTROL SENSOR | 12. TV CHANNEL UP/DOWN BUTTONS |

E. Rear Panel Connections

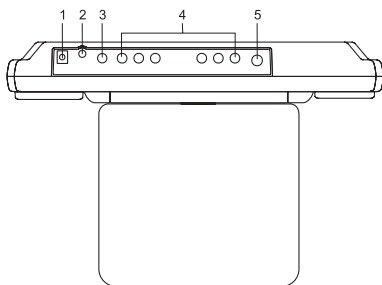

1. DC 12V INPUT
Plug the male end of the supplied adapter into this jack, then plug the other end into your AC power outlet. **NOTE:** Never disconnect the cord from the unit before the plug is removed from the wall outlet.

2. LINE OUT

This is a standard 1/8 stereo jack that provides a fixed low level output.

3. DC 12V OUTPUT

You can connect this jack to an Audiovox VC-6000 Wireless Camera Receiver.

4. AUDIO R INPUT 1, AUDIO L INPUT 1, VIDEO INPUT 1 AUDIO R INPUT 2, AUDIO L INPUT 2, VIDEO INPUT 2

For input of an external A/V source such as video game, camcorder, digital camera etc. Always match the color-coded cable to the appropriate jacks: Yellow (video) to Yellow, White (left audio) to White, and Red (right audio) to Red. You can press TV/AV1/AV2 to select the audio and video source.

5. EXTERNAL TV ANTENNA JACK

You can input your CATV into this jack for receiving CATV stations.

F. TV Operation

1. Press TV/AV1/AV2 to select the TV mode or AV1/AV2.
2. Press TV/CATV to select the type of signal you receive, When using an antenna, adjust it to its best extension, angulation and direction to optimize the image and sound. When using cable, connect the cable to the external antenna jack, and press TV/CATV on the remote control to select STD, HRC or IRC (see Remote Control section). STD is used by most cable systems, however, if the STD setting does not work with your TV, try the other settings and/or check with your cable service provider.
3. Pressing AUTO PROG, the TV's tuner will scan the entire range of the selected band and memorize all the active channels in your area.
4. Press TV CHANNEL UP/DOWN or use the number buttons for TV to select any active channel.
5. Press VOLUME UP/DOWN to raise or lower the sound level.
6. If the picture needs to be adjusted, press PICTURE to illuminate the on-screen display for contrast, brightness, color and tint in sequence, and press +/- to adjust each function up/down.
7. Press MUTE to cut off the sound, and the screen will display the volume adjustment bar for six seconds to indicate that the sound has been turned off. Press MUTE again to restore sound to the sound level set previously. You can also release the mute feature by pressing VOLUME UP/DOWN.

G. Clock Operation

1. Connect the power to the unit, the LCD in the front panel will display the time.
2. Press the TIME SET button once (the hour will start to blink) press TIME ADJUST up/down direction buttons to adjust the hour, press TIME SET again (the minute will start to blink) press TIME ADJUST up/down direction buttons to adjust the minute. When the correct time is entered, press TIME SET again to set time.

H. Remote Control

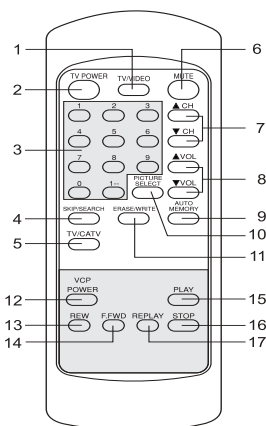

The remote control will operate Audiovox Televisions and Video Cassette Players. It is not a universal remote control and will not control equipment from other manufacturers.

If a universal remote control is to be used with the VE-560, choose the remote encoding scheme for Audiovox Televisions when programming the remote.

1. TV/VIDEO

Press this button to select the TV mode or AV1/AV2.

2. POWER ON/OFF

Press this button to turn on the TV. The channel number or current video source will be displayed on screen, and the picture will appear in a few seconds. Press the button again to turn the TV off.

3. NUMERICAL BUTTONS

Use these buttons to make a direct channel selection. The channel number chosen will be displayed on the screen for 4 seconds. Channel selection is carried out with 0-9 keys (0-99ch) and "1—" key when in cable mode (100-125ch).

4. SKIP/SEARCH BUTTON

This button selects between SKIP and SEARCH mode. In “SKIP mode” the TV only stops on channels that are programmed into memory when the CHANNEL UP/DOWN buttons are used. When SKIP mode is off, the TV is in search mode and will stop on all active channels.

- a. Press this button until SKIP MODE ON is displayed on the screen. Then when the channel up and down keys are used, the TV will stop only on the TV channels stored in memory.
- b. Press this button until SKIP MODE OFF is displayed on the screen. Then all the TV channels will be shown using the channel up and down keys.

5. TV/CATV

Press this button to select the regular 69 channel broadcast TV and the 125 Channel Cable TV (Standard Cable, HRC Cable, and IRC Cable) with the on screen display.

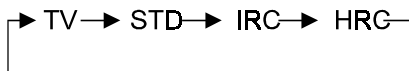

6. MUTE

Press this button to cut off the sound, and the screen will display the volume adjustment bar for six seconds to indicate that the sound has been turned off. Press this button again to restore sound to the sound level set previously. You can also release the mute feature by pressing VOLUME UP/DOWN.

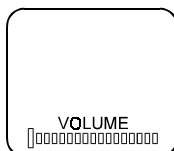

7. CHANNEL UP/DOWN

Use these buttons to advance to the next higher or lower channel.

8. VOLUME UP/DOWN

Use these buttons to raise or lower the sound level. They are also used to make picture adjustments in picture select mode.

9. AUTO MEMORY

Pressing AUTO PROG, the TV’s tuner will scan the entire range of the selected band and memorize all the active channels in your area.

10. PICTURE SELECT

Each time this button is pressed, the on screen picture adjustment display cycles through “adjustment bars” for CONTRAST, BRIGHTNESS, COLOR and TINT. Once the desired adjustment bar is displayed, use

the VOLUME UP/DOWN buttons to adjust the setting. The display will automatically turn off if no adjustments are made within 6 seconds, or if any other button is depressed.

11. ERASE/WRITE

When tuned to a channel, press this button to store or erase the channel from memory. The stored channel numbers are displayed in "GREEN" on the screen, and the non-stored channel numbers are in "RED". When using the CHANNEL UP/DOWN buttons, with the skip mode on, the VE-560 will tune only to the stored channels .

The following buttons are used for the connected Video Cassette Player (VCP) that can be supplied by Audiovox's detailers.

**I. REMOTE CONTROLLED VIDEO CASSETTE PLAYER
FUNCTIONS**

The VE-560's remote control incorporates functions for operating an optional Audiovox VCP. Due to the directional nature of infrared remote controls, be certain to point the remote control at the sensor on the VCP, when attempting to control it. These features can only be used with Audiovox Video Cassette Players. When using another brand VCP, its own remote control must be used. For more information regarding the use of VCPs, refer to the associated Owner's Manual.

12. POWER BUTTON

This button is used to turn the VCP on and off.

13. "REW" REWIND BUTTON

If this button is pushed while the tape is stopped, the tape will rewind. If this button is pushed while the tape is playing, the VCP will go into rewind search mode.

14. PLAY BUTTON

Press this button to activate play mode while a tape is loaded into the VCP. This button may also be used to disengage search and pause modes.

15. "F.FWD." FAST FORWARD BUTTON

If this button is pushed while the tape is stopped, tape will fast forward. If this button is pushed while the tape is playing, the VCP will go into fast forward search mode.

16. REPLAY BUTTON

Pressing this button will rewind tape and immediately begin playback when the tape is fully rewound.

17. STOP BUTTON

Press this button to stop the tape.

J. Battery Installation

- Turn the Remote Control face down. Press the ridged area of the battery cover and slide it off in the same direction as the arrow.
- Install two AAA batteries. Make sure that proper polarity (+/-) is observed.
- Slide back the cover in the contrary direction as the arrow until it clicks.

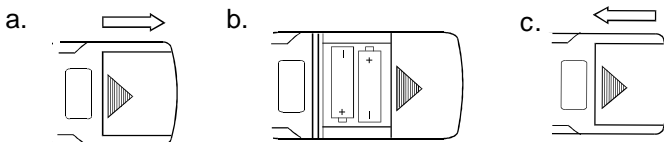

K. CHANNEL TUNING SET UP

In addition to normal broadcast reception of VHF and UHF channels, if you are a Cable TV subscriber, your new TV is capable of receiving many unscrambled Cable channels without the use of a converter box. When set to Broadcast TV it receives CH2-CH69. When set to one of the CATV modes (STD, HRC, or IRC) it receives CH1-CH125. Follow this simple procedure to make channel tuning more convenient.

- Use the TV/CATV button on the Remote Control to select the broadcast or cable system appropriate for your home. The system selected will be displayed on the screen. If you have an external roof mounted or rabbit ear antenna, select "TV," if you have CABLE TV, select either "STD," "HRC" or IRC ("STD" is used by the majority of Cable Systems. Check with your cable system operator).
- Press the AUTO MEMORY button on the Remote Control Unit or the TV. You will see the TV cycle through all channels. The built-in Microprocessor will automatically store each channel that is actively broadcasting in your area.
- To view only strong clear channels, press the SKIP/SEARCH button on the Remote Control Unit until "SKIP MODE ON" is displayed on the bottom of the screen. The TV will now tune only to strong, active channels, when the UP or DOWN buttons are used on the monitor or remote control.
To view a weak or marginal channel, press the SKIP/SEARCH button on the Remote Control Unit until "SKIP MODE OFF" is displayed on the bottom of the screen. Tune to the desired channel using the CHANNEL UP/DOWN button or go directly to the channel by direct access using the 0-9 buttons on the Remote Control.
- To ERASE a channel, press the ERASE/WRITE button on the Remote Control Unit until "MANUAL MEMORY XX ERASE" is displayed on screen. To STORE a channel, press the button until "MANUAL MEMORY XX ADD" is displayed on screen.

L. Specification

System:	NTSC
Screen Size:	5.6 Inches
Illumination:	Edge Light Tube
Bachlighting Life Expectancy:	10,000 Hrs.
Resolution:	
Pixel Configuration:	RGB Stripe
Remote Control:	Infrared Rays
Antenna:	Telescopic Antenna, External Antenna Jack
TV Channel:	2-6 (VLF Band), 7-13 (VHF Band), 21-69 (VHF Band), (CATV) 1-125
Audio Output:	2 x 1.5W/80ohm(MAX)
Power Supply:	13.5V/1.5A
Power Consumption:	14W
Operating Humidity:	10-75%
Operating Temperature:	41-140 Degrees Fahrenheit (5-40) Centigrade
Storage Temperature:	4-140 Degrees Fahrenheit (-20-60) Centigrade

TROUBLESHOOTING

Problem	Solution
Poor Reception	Verify Tuner setting matches Antenna / Cable broadcast system. Try other system types with the TV/CATV BUTTON of the remote control.
Remote control will not function	Verify that the sensor on the VE-560 is not obstructed. Verify that the infrared LED on the transmitter is not obstructed. Check the condition of the remote control batteries.
Black and White Reception	Verify Tuner setting matches Antenna / Cable broadcast system. Try other system

NOTE: This Page Left Blank Intentionally



90 DAY LIMITED WARRANTY

Applies to Audiovox Video Products

AUDIOVOX ELECTRONICS CORP. (the Company) warrants to the original retail purchaser of this product that should this product or any part thereof, under normal use and conditions, be proven defective in material or workmanship within 90 days from the date of original purchase, such defect(s) will be repaired or replaced with reconditioned product (at the Company's option) without charge for parts and repair labor.

To obtain repair or replacement within the terms of this Warranty, the product is to be delivered with proof of warranty coverage (e.g. dated bill of sale), specification of defect(s), transportation prepaid, to the Company at the address shown below.

This Warranty does not extend to the elimination of externally generated static or noise, to correction of antenna problems, to costs incurred for installation, removal or reinstallation of the product, or to damage to tapes, discs, speakers, accessories, or electrical systems.

This Warranty does not apply to any product or part thereof which, in the opinion of the Company, has suffered or been damaged through alteration, improper installation, mishandling, misuse, neglect, accident, or by removal or defacement of the factory serial number/bar code label(s). THE EXTENT OF THE COMPANY'S LIABILITY UNDER THIS WARRANTY IS LIMITED TO THE REPAIR OR REPLACEMENT PROVIDED ABOVE AND, IN NO EVENT, SHALL THE COMPANY'S LIABILITY EXCEED THE PURCHASE PRICE PAID BY PURCHASER FOR THE PRODUCT.

This Warranty is in lieu of all other express warranties or liabilities. ANY IMPLIED WARRANTIES, INCLUDING ANY IMPLIED WARRANTY OF MERCHANTABILITY, SHALL BE LIMITED TO THE DURATION OF THIS WRITTEN WARRANTY. ANY ACTION FOR BREACH OF ANY WARRANTY HEREUNDER INCLUDING ANY IMPLIED WARRANTY OF MERCHANTABILITY MUST BE BROUGHT WITHIN A PERIOD OF 30 MONTHS FROM DATE OF ORIGINAL PURCHASE. IN NO CASE SHALL THE COMPANY BE LIABLE FOR ANY CONSEQUENTIAL OR INCIDENTAL DAMAGES FOR BREACH OF THIS OR ANY OTHER WARRANTY, EXPRESS OR IMPLIED, WHATSOEVER. No person or representative is authorized to assume for the Company any liability other than expressed herein in connection with the sale of this product.

Some states do not allow limitations on how long an implied warranty lasts or the exclusion or limitation of incidental or consequential damage so the above limitations or exclusions may not apply to you. This Warranty gives you specific legal rights and you may also have other rights which vary from state to state. |

U.S.A.: AUDIOVOX ELECTRONICS CORPORATION, 150 MARCUS BLVD.,
HAUPPAUGE, NEW YORK 11788 1-800-645-4994

CANADA: CALL 1-800-645-4994 FOR LOCATION OF WARRANTY STATION SERVING
YOUR AREA

128-5556C