

Register your product and get support at
www.philips.com/welcome

GoGear

SA1ARA02

SA1ARA04

SA1ARA08

SA1ARA16



EN User manual

PHILIPS

Contents

1 Important safety information	3
General maintenance	3
Recycling the product	4

2 Your new GoGear Ariaz	6
What's in the box	6

3 Getting started	7
Overview of the controls and connections	7
Overview of the main menu	7
Install software	8
Connect and charge	8
Connect GoGear Ariaz to a computer	8
Battery level indication	8
Disconnect GoGear Ariaz safely	9
Turn GoGear Ariaz on and off	9
Automatic standby and shut-down	9

4 Use GoGear Ariaz to carry files	10
--	-----------

5 Windows Media Player 11 (WMP11)	11
Install Windows Media Player 11 (WMP11)	11
Transfer music and picture files to WMP11 library	11
Switch between music and pictures library in WMP and GoGear Ariaz	11
Rip songs from a CD	12
Buy music online	13
Sync your Windows Media content to GoGear Ariaz	13
Set up GoGear Ariaz for WMP11	13
Switch between automatic and manual sync	14
Select and prioritize what syncs automatically	14
Select files and playlists for manual sync	15

Copy files from GoGear Ariaz to your computer	15
WMP11 playlists	16
Create a regular playlist	16
Create an auto playlist	16
Edit playlist	16
Transfer playlists to GoGear Ariaz	17
Search for music or pictures with WMP11	17
Delete files and playlists from WMP11 library	17
Delete files and playlists from GoGear Ariaz	17
Edit song information with WMP11	18
Format GoGear Ariaz with WMP11	18

6 Napster	19
Activate / Deactivate a PC for Napster	19
Transfer Napster music to GoGear Ariaz	19

7 Music	21
Listen to music	21
Find your music	21
Delete music tracks	21

8 Audiobooks	22
Add audiobooks to GoGear Ariaz	22
Audiobook controls	22
Select audiobook by book title	22
Adjust audiobook play speed	23
Add a bookmark in an audiobook	23
Find a bookmark in an audiobook	23
Delete a bookmark in an audiobook	23

9 Video	24
Download, convert and transfer videos	24
Play videos	24
Delete videos	24

10 Pictures	25
View pictures	25
View slideshow	25
Add pictures to GoGear Ariaz	25
Delete pictures	25

11 Radio	26
Listen to FM radio	26
Manually tune a radio station	26
Auto-tune preset radio station	26
Play a preset radio station	26

12 Recordings	27
Record from FM radio	27
Record audio/voices	27
Listen to FM recordings	27
Listen to voice/audio recordings	27
Upload your recordings to a computer	27
Delete recordings	28

13 Settings	29
--------------------	----

14 Update GoGear Ariaz	31
Manually verify / update firmware	31

15 Troubleshooting	32
---------------------------	----

16 Technical data	33
System requirements	33
Supported music file formats	33
Supported video file formats	33
Supported picture file formats	34

Need help?

Please visit

www.philips.com/welcome

where you can access a full set of supporting materials such as the user manual, the latest software updates, and answers to frequently asked questions.

1 Important safety information

General maintenance

! Caution

- To avoid damage or malfunction:
- Do not expose the product to excessive heat caused by heating equipment or direct sunlight.
- Do not drop the product or allow objects to fall on your player.
- Do not allow the product to be submerged in water. Do not expose headphone socket or battery compartment to water, as water entering the set may cause major damage.
- Active mobile phones in the vicinity may cause interference.
- Back up your files. Ensure that you retain the original files you have downloaded to your device. Philips is not responsible for any loss of data if the product becomes damaged or not readable / legible.
- Manage (transfer, delete, etc.) your music files only with the supplied music software to avoid problems.
- Do not use any cleaning agents containing alcohol, ammonia, benzene, or abrasives as these may harm the product.

About operating and storage temperatures

- Operate in a place where temperature is always between 0 and 35°C (32 to 95°F)
- Store in a place where temperature is always between -20 and 45°C (-4 to 113°F).
- Battery life may be shortened in low temperature conditions.

Replacement parts/accessories:

Visit www.philips.com/support to order replacement parts/accessories.

Hearing Safety



Listen at a moderate volume:

Using headphones at a high volume can impair your hearing. This product can produce sounds in decibel ranges that may cause hearing loss for a normal person, even for exposure less than a minute. The higher decibel ranges are offered for those that may have already experienced some hearing loss.

Sound can be deceiving. Over time your hearing 'comfort level' adapts to higher volumes of sound. So after prolonged listening, what sounds 'normal' can actually be loud and harmful to your hearing. To guard against this, set your volume to a safe level before your hearing adapts and leave it there.

To establish a safe volume level:

Set your volume control at a low setting.

Slowly increase the sound until you can hear it comfortably and clearly, without distortion.

Listen for reasonable periods of time:

Prolonged exposure to sound, even at normally 'safe' levels, can also cause hearing loss.

Be sure to use your equipment reasonably and take appropriate breaks.

Be sure to observe the following guidelines when using your headphones.

Listen at reasonable volumes for reasonable periods of time.

Be careful not to adjust the volume as your hearing adapts.

Do not turn up the volume so high that you can't hear what's around you.

You should use caution or temporarily discontinue use in potentially hazardous situations.

Do not use headphones while operating a motorized vehicle, cycling, skateboarding, etc.; it may create a traffic hazard and is illegal in many areas.

Modifications

Modifications not authorized by the manufacturer may void user's authority to operate the product.

Copyright information

All other brands and product names are trademarks of their respective companies or organizations.

Unauthorized duplication of any recordings whether downloaded from the Internet or made from audio CDs is a violation of copyright laws and international treaties.

The making of unauthorized copies of copy-protected material, including computer programs, files, broadcasts and sound recordings, may be an infringement of copyrights and constitute a criminal offense. This equipment should not be used for such purposes.

The Windows Media and the Windows logo are registered trademarks of Microsoft Corporation in the United States and/or other countries.

Be responsible! Respect copyrights.



**Be responsible
Respect copyrights**

Philips respects the intellectual property of others, and we ask our users to do the same. Multimedia content on the internet may have been created and/or distributed without the original copyright owner's authorization. Copying or distributing unauthorized content may violate copyright laws in various countries including yours.

Compliance with copyright laws remains your responsibility.

The recording and transfer to the portable player of video streams downloaded to your computer is intended only for use with public domain or properly licensed content. You may only use such content for your private, non-commercial use and shall respect eventual copyright instructions provided by the copyright owner of the work. Such instruction may state that no further copies shall be made.

Video streams may include copy protection technology that prohibits further copying. For such situations the recording function will not work and you will be notified with a message.

Data logging

Philips is committed to improving the quality of your product and enhancing the Philips user experience. To understand the usage profile of this device, this device logs some info / data to the non-volatile memory region of the device. These data are used to identify and detect any failures or problems you as a user may experience while using the device. The data stored, for example, will be the duration of playback in music mode, duration of playback in tuner mode, how many times battery low was encountered, etc. The data stored do not reveal the content or media used on the device or the source of downloads. The data stored on the device are retrieved and used ONLY if the user returns the device to the Philips service center and ONLY to simplify error detection and prevention. The data stored shall be made available to user on user's first request.

Recycling the product

Your product is designed and manufactured with high quality materials and components, which can be recycled and reused. When you see the crossed-out wheel bin symbol attached to a product, it means the product is covered by the European Directive 2002/96/EC:



Never dispose of your product with other household waste. Please inform yourself about

the local rules on the separate collection of electrical and electronic products. The correct disposal of your old product helps prevent potentially negative consequences on the environment and human health.

! Caution

- Removal of the built-in battery invalidate the warranty and may destroy the product. The following instructions are disposal instructions at the end of the product's life.

Your product contains a built-in rechargeable battery covered by the European Directive 2006/66/EC, which cannot be disposed of with normal household waste. To safeguard the functionality and safety of your product, take your product to an official collection point or service centre where a professional can remove or replace the battery as shown:

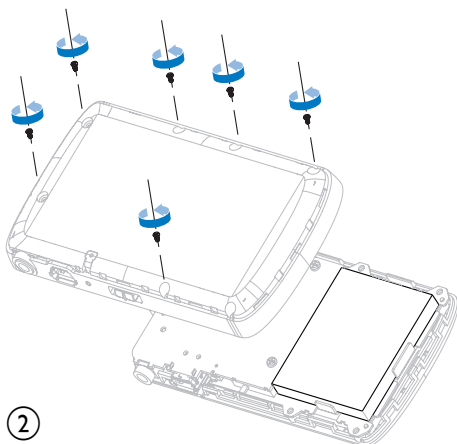
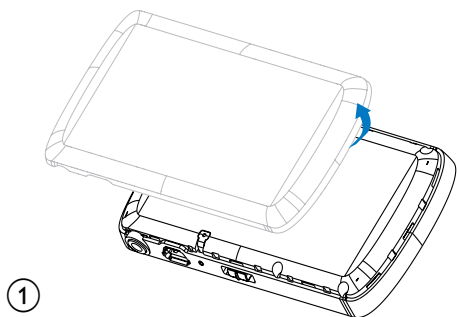

Please inform yourself about the local rules on separate collection of batteries. The correct disposal of batteries helps prevent potentially negative consequences on the environment and human health.

Notice for the European Union

This product complies with the radio interference requirements of the European Union.

2 Your new GoGear Ariaz

Note

- The images serve as reference only. Philips reserves the right to change color/design without notice.

GoGear Ariaz allows you to

- play MP3 and WMA files
- view video files
- listen to FM radio
- make recordings

What's in the box

Check that you have received the following items:

Player



Earphones



USB cable



Quick start guide



3 Getting started

Overview of the controls and connections

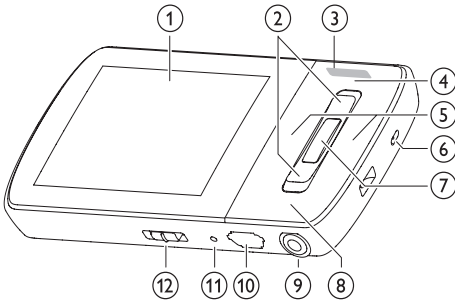

①	display
② ▲ / ▼	press: scroll up/down press and hold: scroll up/down at high speed
③ - VOL +	press: increase/decrease the volume press and hold: increase/decrease fast
④ OPTIONS	view available options
⑤ ◀ / ▶	press: skip to next/previous press and hold: scroll back/forward at high speed
⑤ MIC	microphone
⑥ ▶	press: play/pause/confirm
⑦ ↶	press: back one level press and hold: return to main menu
⑨ 🎧	headphone jack
⑩ 🔄	USB connection jack
⑪ RESET	press: reset GoGear Ariaz
⑫ Ⓜ	slide and hold: turn GoGear Ariaz on/off
🔒	slide: lock/unlock all buttons except - VOL +

! Caution

- Listening to loud sounds for longer than a moment can be harmful to the listener.

You can set the volume level of GoGear Ariaz to limit the maximum volume output.

- 1 From the main menu, select **[Settings] > [Sound settings] > [Volume limit]**.
- 2 Press the **- / +** volume controls to adjust the level.
- 3 Press **▶||** to confirm.
 - ↳ When you set a volume limit, GoGear Ariaz can no longer exceed the set volume, even if you press the volume **+** button.

To enable maximum volume again:

- 1 Select **[Settings] > [Sound settings] > [Volume limit]**.
- 2 Set the volume limit to maximum.
- 3 Press **▶||** to confirm.

Overview of the main menu

Menu	Mode	To
🎵	Music	play music tracks
📺	Video	play videos
📷	Pictures	view pictures
📻	FM radio	listen to FM radio
🎧	Recording	create or listen to recordings
📁	Folder view	view files in folders
📄	Text reader	read text files
⚙️	Settings	customize the settings of GoGear Ariaz
⏪	Now playing	show the current play screen

Install software

GoGear Ariaz comes with the following software:

- Philips Device Manager (helps you get firmware updates for GoGear Ariaz)
- Media Converter for Philips (helps you convert and transfer video files for GoGear Ariaz)
- Windows Media Player (helps you convert and transfer WMP media files for GoGear Ariaz)
- Napster (helps you convert and transfer Napster media files for GoGear Ariaz)

Note

- Napster is available in Germany and in the UK only.

Important:

Remember to install the software provided in the supplied CD-ROM for music and/or video transfer.

Important: Before installing the software, check that your computer meets the requirements (see section **System requirements** in this user manual).

- 1 Connect GoGear Ariaz to your computer.
- 2 Insert the CD that comes with the GoGear Ariaz into the CD-ROM drive of your computer.
- 3 Follow the on-screen instructions to complete the installation of the software.

If the installation programm fails to start automatically:

- 1 Browse the CD contents with Internet Explorer.
- 2 Double click on the file ending with '.exe'.

Connect and charge

GoGear Ariaz has a built-in battery that can be charged through the USB port of a computer (USB cable included).

Note





- For first-time use, allow GoGear Ariaz to charge for 3 hours.
- The charging animation stops and the  icon is displayed when the charging process is completed.

Connect GoGear Ariaz to a computer

- 1 Connect the USB plug of the supplied USB cable to a spare USB port on your computer.
- 2 Connect the small USB plug of the USB cable to the small USB jack on GoGear Ariaz.
- 3 Turn on your computer.
↳ GoGear Ariaz charges.

Battery level indication

The display indicates the approximate levels of the battery status as follows:

				
100%	75%	50%	25%	0%

- ↳ A flashing battery screen indicates that the battery is low. The player saves all settings and switches off within 60 seconds.

Note

- Rechargeable batteries have a limited number of charge cycles. Battery life and number of charge cycles vary by use and settings.
- The charging animation stops and the  icon is displayed when the charging process is completed.



Tip

- You can conserve battery power and increase the play time of the GoGear Ariaz if you go to *** > [Display settings] > [Screen off timer]** and ensure that the shortest timer setting is selected.

- To unlock the buttons again, move the slider to the center position.

Disconnect GoGear Ariaz safely

To avoid data loss, disconnect GoGear Ariaz from your computer as follows:

- On your computer, exit all applications that are working with GoGear Ariaz.
- Click  in the task tray of your computer.
- Wait for the confirmation that GoGear Ariaz can be safely removed, then disconnect GoGear Ariaz from the USB port.

Turn GoGear Ariaz on and off

- To toggle between modes on and off, slide and hold  for approximately 2 seconds.

Automatic standby and shut-down

GoGear Ariaz has an automatic standby and shut-down feature that can save battery power.

After 10 minutes in idle mode (no music plays, no button is pressed), GoGear Ariaz turns off.

- Slide and hold  for approximately 2 seconds to turn GoGear Ariaz on again.

GoGear Ariaz has a lock switch to prevent accidental operation.

- To lock the buttons when you play, move the slider to position .
 - ↳ All buttons except the volume keys are locked and the display shows a lock icon.

4 Use GoGear Ariaz to carry files

GoGear Ariaz allows you to carry files in **Windows Explorer**.

- 1** With GoGear Ariaz connected to the USB port of the computer, open **Windows Explorer**.
- 2** Create folders in GoGear Ariaz.
- 3** Use drag and drop actions to sort your files into the folders.

5 Windows Media Player 11 (WMP11)

Install Windows Media Player 11 (WMP11)

- 1 Insert the supplied CD into the CD-ROM drive of your computer.
- 2 Follow the on-screen instructions to complete the installation of **WMP11**.

Transfer music and picture files to WMP11 library

By default, **WMP11** automatically loads all the music and picture files that are stored in your computer. The new files are also automatically added to the **WMP11** library. The following steps show how you can add music and picture files that are stored elsewhere on your computer or computer network:

- 1 Select **Start > All Programs > Windows Media Player** to launch the **WMP11** program.
- 2 Click the down arrow beneath the **Library** tab, then select **Add to Library...**



↳ Add to Library dialog box appears.



- 3 Click **<< Advanced Options** to expand the dialog box.
- 4 Click **Add...**
↳ Add folder dialog box appears.
- 5 Select a folder that contains your music or picture files, then click **OK**.
- 6 **WMP11** starts scanning the folder and adds available music or picture files to the library.
- 7 Click **Close** when done.

* Tip

- **WMP11** is configured to skip audio files that are smaller than 100 KB. To include files smaller than 100 KB, you can change the default settings within the Add to library dialog box.

Switch between music and pictures library in WMP and GoGear Ariaz

- 1 Click the arrow on the top left of **WMP11**, then select the category.



5 Insert the audio CD into the CD drive of the computer.

Rip songs from a CD

You can transfer music from a CD to GoGear Ariaz. The transfer requires that you create a digital copy of the music on your computer first. This is called ripping.

- 1 Ensure that the computer is connected to the Internet.
- 2 Start WMP11.
- 3 Click the down arrow beneath the Rip tab and select the **Format**.



↳ All the tracks from the CD are listed. By default, WMP11 starts to rip all the songs from the CD.

↳ To modify this option, click the down arrow beneath the Rip tab and select **Rip CD Automatically When Inserted > Never**.

6 Click on the check boxes to select the songs that you want to rip.



4 Click on the down arrow beneath the Rip tab and select the **Bit Rate**.

Sync your Windows Media content to GoGear Ariaz

You can sync your music and pictures to GoGear Ariaz using **WMP11**. When you connect GoGear Ariaz to the computer for the first time, **WMP11** automatically selects the sync method (automatic or manual) that works best for GoGear Ariaz.

Automatic: If GoGear Ariaz has sufficient storage space (at least 4GB of free space) and your entire media library can fit on GoGear Ariaz, your entire media library is automatically copied to GoGear Ariaz when connected to the computer.

Manual: If your entire media library cannot fit on GoGear Ariaz, you are prompted to manually select files or playlists for transfer to GoGear Ariaz.



- 7 Click **Start Rip**.
 - ↳ The selected tracks are converted and added to the **WMP11** library.

Buy music online

You can select a music store and buy music online.

- 1 Start **WMP11**.
- 2 Click the down arrow beneath the **Media Guide** tab and select **Browse all Online Stores**.
- 3 Choose a store and follow the on-screen instructions.



- ↳ You can find the albums or songs you purchase in the **WMP11** library.

Set up GoGear Ariaz for WMP11

! Caution

- Do not disconnect GoGear Ariaz while transfer is in progress. If you disconnect GoGear Ariaz, the transfer is incomplete and Windows may not be able to recognize GoGear Ariaz afterwards.

- 1 Start **WMP11**.
- 2 Turn on GoGear Ariaz.
- 3 Connect GoGear Ariaz to the computer.
- 4 Set up sync:
 - If you are prompted: select the option to sync GoGear Ariaz using **WMP11**.
 - If **WMP11** selects to sync GoGear Ariaz automatically: click **Finish**.
 - Your entire library syncs to GoGear Ariaz. Thereafter, GoGear Ariaz syncs automatically when connected to the computer.
 - You can also choose what syncs automatically (see section **Select and prioritize what syncs automatically**).

- If **WMP11** selects to sync GoGear Ariaz manually, click **Finish**.
- You are required to click the **Sync** tab and manually select the files and playlists for sync (see section **Select files and playlists for manual sync**).

Switch between automatic and manual sync

After the first sync setup, you can switch between automatic and manual sync:

- 1 Click the down arrow beneath the **Sync** tab, then select **PhilipsGoGear Ariaz > Set Up Sync**.
- 2 Select or deselect the **Sync this device automatically** check box.

Select and prioritize what syncs automatically

If **WMP11** selects to sync GoGear Ariaz automatically, you can choose not to sync your entire media library. You can choose what to sync from existing playlists or create new playlists. The playlists you select sync to GoGear Ariaz every time you connect GoGear Ariaz to the computer.

- 1 Click the down arrow beneath the **Sync** tab and select **Philips GoGear Ariaz > Set Up Sync**.
 - ↳ The Device Setup dialog box appears.



- 2 In the Available playlists pane, select the existing playlists you want to sync, then click **Add**.



- 3 To create a playlist, click **New Auto Playlist**, then follow the steps on the screen to specify criteria. (See also section **Create an Auto Playlist**).
- 4 To remove a playlist, click the playlist in the list of **Playlists to sync**, then click **Remove**.
- 5 In the **Playlist to sync** pane, select the **Priority** arrows to arrange them in the order that you want them to sync.

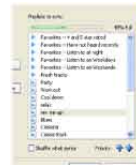

- ↳ If GoGear Ariaz is full before sync is complete, the files and playlists that are lower in priority on the list are omitted from sync.

Tip

- If your media library is too large to fit on GoGear Ariaz, you can select the **Shuffle what syncs** check box, to shuffle the files that are in the playlists to sync. Thereafter, the files on GoGear Ariaz are replaced with a new set of files (from the Playlists to sync pane) whenever GoGear Ariaz is connected to the computer.

Select files and playlists for manual sync

If you want to sync manually, you are required to a list of files and playlists you want to sync. You can also shuffle which files from your playlists to sync to GoGear Ariaz.

- 1 Start **WMP11**.
- 2 Turn on GoGear Ariaz.
- 3 Connect GoGear Ariaz to the computer.
- 4 Click the **Sync** tab.
- 5 Drag the files and playlists that you want to sync from the Contents pane to the **Sync List** pane.
 - You can also click on the file or playlist and select **Add to 'Sync List'**.



- 6 In the Sync List pane, verify that the items you have selected to sync can all fit on GoGear Ariaz.
 - If necessary, remove items from the list.



- 7 To remove items, right click on the item in the Sync List pane, then select **Remove from List**.
- 8 Click **Start Sync** button to transfer the Sync List items to GoGear Ariaz.

- ↳ The progress is displayed on the bottom right of **WMP11**.
- ↳ Click **Stop Sync** to stop the transfer.



Tip

- If the tracks to sync are protected, you are prompted to upgrade the security components on your computer. When this happens, you can play the track in **WMP11** and when prompted, follow the steps on the screen to upgrade the security components. After you have upgraded your security components, you can sync the file to GoGear Ariaz.

Copy files from GoGear Ariaz to your computer

GoGear Ariaz supports reverse sync, which lets you copy files from GoGear Ariaz to your computer with **WMP11**.

- 1 Start **WMP11**.
- 2 Turn on GoGear Ariaz.
- 3 Connect GoGear Ariaz to the computer.
- 4 Click on **Philips GoGear Ariaz** in the left Navigation pane.
 - ↳ The content on GoGear Ariaz is listed in the Contents pane.
- 5 Navigate to the file or playlist you want to copy from GoGear Ariaz to the computer.
- 6 Right click on the file or playlist, then select **Copy from Device**.

WMP11 playlists

Playlists allow you to mix any combination of songs or pictures you want. You can create regular or auto playlists in WMP11. These playlists can contain songs, pictures, or both.

Create a regular playlist

- 1 Click the down arrow beneath the **Library** tab and select **Create Playlist**.
↳ Untitled Playlist appears on the List pane.
- 2 Click on **Untitled Playlist** and enter a new name for the playlist.
- 3 To add items to your playlist, drag them from the Contents pane to the List pane. (Your playlist can contain both songs and pictures.)



- 4 When you have finished adding items to the playlist, click **Save Playlist**.

Create an auto playlist

WMP11 can automatically generate playlists based on various criteria.

- 1 Click the down arrow beneath the **Library** tab, then select **Create Auto Playlist**.
↳ A New Auto Playlist dialog box appears.
- 2 Enter a name for the auto playlist.



- 3 Click the first green plus sign and select your first criteria from the pull-down list.
- 4 Click on the underlined words to refine your criteria.
- 5 Click the second and third green plus signs to select and define more criteria for your auto playlist.
- 6 Click **OK** button when done.

Edit playlist

You can edit your existing playlists at any time.

- 1 In the left Navigation pane, click on **Playlists**.



- ↳ All your playlists are displayed in the Contents pane.
Right click on the playlist you want to edit, then select **Edit in List Pane** from the pop-up menu.

- ↳ The content in the playlist appears in the List pane.

To remove an item from the playlist, right click on the item, then select **Remove from List**.



To change the order of the items in the playlist, click and drag any item to a new position within the List pane.

To add a new item to the playlist, select it from the library and drag it to the List pane.

When you have finished editing the playlist, click the **Save Playlist** button.

Transfer playlists to GoGear Ariaz

The section **Select files and playlists for manual sync** in this user manual shows how to transfer of playlists to GoGear Ariaz.

Search for music or pictures with WMP11

- 1 Click the **Library** tab.
- 2 Click the arrow on the top left of **WMP11**, then select **Music** or **Pictures** to search.
- 3 Type a few keywords of the file, such as song title or artist in the search box.
 - ↳ The search results appear in the Contents pane as you type. Results are updated as you enter each new letter

- 4 To refine your search results, enter more keywords.

Delete files and playlists from WMP11 library

- 1 Click the **Library** tab.
- 2 Click the arrow on the top left of WMP11, then select **Music** or **Pictures** for deletion.
- 3 Navigate to the file or playlist you want to delete.
- 4 Right click on the file or playlist, then select **Delete**.
- 5 Select **Delete from library only** or **Delete from library and my computer**, then click **OK**.

Delete files and playlists from GoGear Ariaz

You can use **WMP11** to manage the files stored on GoGear Ariaz. When you connect GoGear Ariaz to the computer, the contents on GoGear Ariaz is displayed in **WMP11**. You can delete files or playlists, just like any other files displayed in **WMP11**.

- 1 In the left Navigation pane, click on **Philips GoGear Ariaz**.
- 2 You can browse the contents of GoGear Ariaz in a variety of views, such as Recently Added or Artists.
- 3 The contents on GoGear Ariaz is listed in the Contents pane.
- 4 To delete music or picture files, click the arrow on the top left of **WMP11**, then select **Music** or **Pictures**.
- 5 Navigate to the file or playlist you want to delete.
- 6 Right click on the file or playlist, then select **Delete**.

7 Click OK.

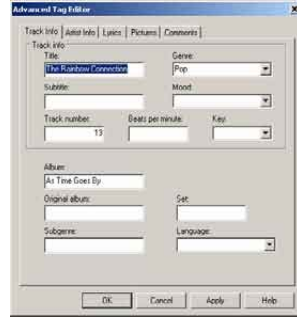

5 Click OK to save your changes.

Edit song information with WMP11

- 1 Click the **Library** tab.
- 2 Navigate to the song you want to edit.
- 3 Right click on the song, then select **Advanced Tag Editor** from the pop-up menu.
↳ The advanced Tag Editor dialog box appears.



4 Select the appropriate tab, then enter or edit the information.

Format GoGear Ariaz with WMP11

! Caution

- This procedure reformats the storage on GoGear Ariaz and erases all data.

- 1 Start **WMP11**.
- 2 Turn on GoGear Ariaz.
- 3 Connect GoGear Ariaz to the computer.
- 4 Click the down arrow beneath the **Sync** tab, then select **Philips GoGear Ariaz > Format**.

6 Napster

The Napster To Go online music service offers a variety of purchase and subscription models. The Napster Software supplied with GoGear Ariaz helps you

- search Napster for music by name
- purchase Napster music
- play unlimited Napster music on your computer
- transfer your Napster music to your GoGear Ariaz
- browse the Napster catalogue

Here's how you can search for music by name:

- 1 Ensure that your computer is connected to the Internet.
- 2 Launch the Napster Software on your computer.
- 3 From the **Search** drop-down menu, select the type of search.
- 4 In the search field, enter the search criteria (for example name of artist or title of song).
- 5 Click **Search** to start the search.

Here's how you can browse the Napster catalogue:

- 1 Ensure that your computer is connected to the Internet.
- 2 Launch the Napster Software on your computer.
- 3 In the Navigation pane, click on the tab **Explore Napster**.
- 4 Follow the on-screen instructions.

Activate / Deactivate a PC for Napster

Activate a PC:

When you download Napster subscription tracks to a PC, the PC is automatically activated.

You can activate only a limited number of PCs, so activation of another PC may require deactivation of a previously activated PC.

Deactivate a PC:

- 1 From the pull-down menu at the top of the screen, select **My Accounts**, then click on **Manage PCs/Devices**.
- 2 Follow the menu instructions to complete the deactivation.



Tip

- For more in-depth instructions select Help from the pull-down menu and click on Tutorial or User Guide.

Transfer Napster music to GoGear Ariaz

The Napster software installation must be completed, before you can transfer music from To Go Napster to GoGear Ariaz.

Here's how to transfer Napster music:

- 1 Connect GoGear Ariaz to the computer.
- 2 The **Transfer to Device** window is displayed in the Napster player.
- 3 Select music, then drag and drop music into **Transfer to Device** dialog box.
- 4 In the **My Library** menu, select the device and see **Transfer Status** folder to check the progress.



Note

- For more in-depth instructions select Help from the pull-down menu and click on Tutorial or User Guide.

© 2003-2009 Napster LLC, Napster, Napster To Go and the Napster logos are trademarks of Napster LLC, that may be registered in the UK and/or other countries.

Portions utilize Microsoft Windows Media Technologies. Copyright © 1999-2002 Microsoft Corporation. All Rights Reserved.

Music recognition technology and related data are provided by Gracenote®. Gracenote is the industry standard in music recognition technology and related content delivery. For more information, please visit www.gracenote.com.

CD and music-related data from Gracenote, Inc., copyright © 2000-2007 Gracenote. Gracenote Software, copyright © 2000-2007 Gracenote. This product and service may practice one or more of the following U.S. Patents: #5,987,525; #6,061,680; #6,154,773, #6,161,132, #6,230,192, #6,230,207, #6,240,459, #6,304,523, #6,330,593, #7,167,857, and other patents issued or pending. Gracenote and CDDDB are registered trademarks of Gracenote. The Gracenote logo and logotype, and the "Powered by Gracenote" logo are trademarks of Gracenote.

POWERED BY





gracenote.

Gracenote® is a registered trademark of Gracenote, Inc. The Gracenote logo and logotype, and the "Powered by Gracenote" logo are trademarks of Gracenote.

7 Music

Listen to music

- 1 From the main menu, select  to enter music mode.
- 2 Navigate the sub-menus to select your music.
- 3 Press  to play.
 - Press  to toggle between pause and play.

Find your music

From the main menu, select  to enter music mode.

GoGear Ariaz offers the following menu options:

[All songs]

- Alphabetically listed tracks

[Artists]

- Alphabetically listed artists
- Alphabetically listed albums
- Tracks listed in album order

[Albums]

- Alphanumerically listed albums
- Tracks listed in album order

[Playlists]



- [Playlist-on-the-go]
- Tracks listed in playlist order



Note

- Alternatively, you can select  from the main menu and find your files in folder view.

Delete music tracks

- 1 From the main menu, select .
- 2 Press  /  to locate a track.
- 3 Press **OPTIONS** to view options menu.
- 4 Select the delete option to delete the track.

8 Audiobooks

GoGear Ariaz supports books in audio format. The use of this feature requires that you download the **AudibleManager** from audible.com. With the **AudibleManager** you can manage the digital contents of your audiobooks. Visit audible.com and register. The onscreen instructions guide you through the **AudibleManager** software download process. You can search audiobooks by book name or by author. While you listen to an audiobook, you can navigate the same way as you would in any other audio file.

Add audiobooks to GoGear Ariaz

- **Important:** GoGear Ariaz supports audiobook format 4.
- 1 On your computer, launch **AudibleManager**.
 - 2 Follow the online instructions to download your audiobooks in format 4.
 - 3 Follow the **AudibleManager** on-screen instructions to activate GoGear Ariaz for your audiobooks.
 - 4 Follow the **AudibleManager** on-screen instructions to transfer your audiobooks to GoGear Ariaz.

Note

- GoGear Ariaz can only play audiobooks in format 4.
- GoGear Ariaz can only play audiobooks for which it is **activated**.

Audiobook controls

GoGear Ariaz offers the following audiobook mode controls:

Goal	Action
Play / pause	Press ►
Skip forward to beginning of new section / chapter	Press ►
Skip back to beginning of current section / chapter	Press ◀
Fast skip forwards through audiobook	Press and hold ►
Fast skip backwards through audiobook	Press and hold ◀
Access options menu	Press OPTIONS
Return to browsing menu	Press ↶
Increase / decrease volume	Press - VOL +

Tip

- You can resume play after navigating away from audiobooks (see section **Resume play** in this user manual).

Select audiobook by book title

- 1 From the main menu, select **🎵** to enter music mode.
- 2 Press **▲** or **▼**, then **►||** to select **Audiobooks**.
- 3 Press **▲** or **▼**, then **►||** to select option **Book titles** or **Authors**.
- 4 Press **▲** or **▼**, then **►||** to make further selections.
- 5 Press **▲** or **▼** to select title, then to play. ↶ To exit, press ↶.

Adjust audiobook play speed

- 1 In audiobook play mode, press **OPTIONS**.
- 2 Press ▲ or ▼, then ►|| to select **Playback speed**.
- 3 Press ▲ or ▼, then ►|| to select **Slower**, **Normal**, or **Faster**.
 - To exit, press ↵.

Add a bookmark in an audiobook

- 1 In audiobook play mode, press **OPTIONS**.
- 2 Press ▲ or ▼, then ►|| to select **Bookmarks**.
- 3 Press ▲ or ▼, then ►|| to select **Add bookmark**.
 - ↳ The display shows a confirmation screen.
 - ↳ To exit, press ↵.

Find a bookmark in an audiobook

In audiobook play mode, press
Press ▲ or ▼, then ►|| to select **Bookmarks**.
Press ▲ or ▼, then ►|| to select **Go to bookmarks**.
Press ▲ or ▼ to select the bookmark in the list.
Press ►|| to go to the selected bookmark.
To exit, press ↵.

Delete a bookmark in an audiobook

In audiobook play mode, press **OPTIONS**.
Press ▲ or ▼, then ►|| to select **Bookmarks**.
Press ▲ or ▼, then ►|| to select **Delete bookmark**.
Press ▲ or ▼ to select the bookmark in the list.
Press ►|| to delete the selected bookmark.

- To exit, press ↵.

9 Video

Download, convert and transfer videos

MediaConverter™ for Philips enables you to

- download videos from the Internet to your PC at the click of a button.
- convert video files on your PC to the correct screen size of GoGear Ariaz.
- transfer converted videos from your PC to GoGear Ariaz.



Note

- Video conversion and transfer can take a long time, depending on your PC configuration.



- 3 Press **OPTIONS** to view options menu.
- 4 Select the delete option to delete the video.







Note

- Alternatively, you can select  from the main menu and find your files in folder view.



Play videos

- 1 From the main menu, select  to enter video mode.
- 2 Navigate the sub-menus to select your video.
- 3 Press  to play.
 - Press  to toggle between pause and play.

In video mode, you can adjust the brightness of the display:

- 1 During video play, press and  /  to increase / decrease the brightness of the display.
- 1 During video play, press and hold  /  to scan fast forward / backward.
 - Press  to resume play.



Delete videos

- 1 From the main menu, select .
- 2 Press  /  to locate a video.

10 Pictures

View pictures

GoGear Ariaz supports pictures in JPEG format.

- 1 From the main menu, select  to enter picture mode.
- 2 Press  /  to move to next / previous picture.

View slideshow

While in  mode, you can view your pictures as a slideshow:

- 1 Press  to start the slideshow.





Tip

- The menu **Settings** offers various slideshow settings.

Add pictures to GoGear Ariaz

- 1 With GoGear Ariaz connected to the USB port of the computer, open **Windows® Explorer**.
- 2 Create folders in GoGear Ariaz.
- 3 Use drag and drop actions to sort your pictures into the folders.

Delete pictures

- 1 From the main menu, select  to enter picture mode.
- 2 Press  /  to locate a picture.
- 3 Press **OPTIONS** to view options menu.
- 4 Select the delete option to delete the picture.



Note

- Alternatively, you can select  from the main menu and find your files in folder view.





11 Radio

Listen to FM radio

- 1 From the main menu, select  to enter radio mode.
 - The earphones cable acts as FM antenna.



Manually tune a radio station

While in  mode, you can manually tune to a radio station:







- 1 To search for the next stronger signal, press and hold  / .
- 2 To fine tune the frequency, briefly press  / .

Auto-tune preset radio station

The auto-tune feature of GoGear Ariaz helps you find radio stations and save them under the preset numbers.

- 1 While in  mode, select **[Auto tune]** > **[Yes]**.
 - ↳ The radio automatically tunes radio stations and saves the frequencies to presets.
 - ↳ There are 20 presets available.
 - ↳ To stop auto tuning, press .
 - ↳ To exit radio, press and hold  for 2 seconds.

Play a preset radio station

- 1 In  mode, you can play previously set radio stations (presets).
- 2 Press **OPTIONS** to view options menu.
- 3 Select preset.
- 4 Press  /  to change to another preset.
- 5 To search for the next stronger signal, press and hold  /  for 2 seconds.
 - To exit radio, press and hold  for 2 seconds.









Note

- You can play presets only after you have stored radio stations under presets. (See **Auto-tune preset radio stations** or **Manually tune a radio station** in this user manual.)

12 Recordings

Record from FM radio

- 1 From the main menu, select  to enter radio mode.
- 2 Select radio station (preset).
- 3 Press **OPTIONS** to view options menu.
- 4 Select **[Start FM radio recording]**.
 - Press  to toggle between pause and record.
- 5 Press  to stop.
 - ↳ The screen prompts you to save the recording.
- 6 Press  /  to select **[Yes]** / **[No]**.
- 7 Press  to confirm.
 - ↳ Recordings are saved on the player. (Filename format: FMRECXXX.MP3, where XXX is the recording number that is generated automatically.)









Tip

- You can find your recordings under **[Recordings library] > [FM radio]**.

Record audio/voices

This is how you can record audio/voices with the built-in microphone (see section **Overview** for location of built-in microphone):

- 1 From the main menu, select  to enter recordings mode.
- 2 Select **[Start voice recording]**.
 - Press  to toggle between pause and record.
- 3 Press  to stop.
 - ↳ The screen prompts you to save the recording.
- 4 Press  /  to select **[Yes]** / **[No]**.



- 5 Press  to save the recording.
 - ↳ Recordings are saved on the player. (Filename format: VOICEXXX.MP3, where XXX is the recording number that is generated automatically.)





Tip

- You can find your recordings under **[Recordings library] > [Voice]**.

Listen to FM recordings

- 1 From the main menu, select  to enter recordings mode.
- 2 Select **[Recordings library] > [FM radio]**.
- 3 Select a recording.
- 4 Press  to play.

Listen to voice/audio recordings

- 1 From the  menu select **[Recordings library] > [Voice]**.
- 2 Select a recording.
- 3 Press  to play your recording.

Upload your recordings to a computer

- 1 Connect GoGear Ariaz to the computer (see section **Connect and charge** in this user manual).
- 2 On the computer, in **Windows® Explorer** select GoGear Ariaz.
- 3 Select **Recordings > Voice** or **FM radio**.
- 4 Copy and paste the recordings to any location on the computer.

Delete recordings

Use a computer to delete recordings from GoGear Ariaz:

- 1** Connect GoGear Ariaz to the computer (for instructions see section **Connect**).
- 2** On the computer, in **Windows® Explorer** select GoGear Ariaz.
- 3** Select **Recordings > Voice** or **FM radio**.
- 4** Select the recordings you want to delete.
- 5** On the computer, press **Delete**.
↳ The selected recordings are deleted.

13 Settings

This is how you customize GoGear Ariaz:

From the main menu, select ***** to enter settings mode.

In the ***** menu, navigate as follows:

- 1 Press **▲** / **▼** to select an option.
- 2 Press **▶||** to confirm a selection and go to the next level (when available).
- 3 Press **↶** to return to the previous level.
- 4 Press and hold **↶** to exit the ***** menu.

In the ***** menu, the following options are available:

Settings	Options menu	Sub-options menu
[Play mode]	[Repeat]	<ul style="list-style-type: none">• [Repeat off] (default)• [Repeat 1]• [Repeat all]
	[Shuffle]	<ul style="list-style-type: none">• [Shuffle off] (default)• [Shuffle all]
[Sound settings]	[FullSound]	<ul style="list-style-type: none">• [Off] (default)• [On]
	[Equalizer]	<ul style="list-style-type: none">• [Off] (default)• [Rock]• [Funk]• [Hip hop]• [Jazz]• [Classical]• [Techno]• [Custom]
	[Volume limit]	Vertical bar indicator. Press -VOL + to adjust volume limit, then press ▶ to confirm.
[Sleep timer]	<ul style="list-style-type: none">• [Off] (default)• xx [mins]	

[Display settings]	[Brightness]	Vertical bar indicator. Press ▲ or ▼ to adjust brightness, then press ►► to confirm	
	[Theme]	<ul style="list-style-type: none"> • [Dark] (default) • [Light] • [Red] 	
	[Backlight timer]	• [[x] seconds]	
	[Screen off timer]	<ul style="list-style-type: none"> • [[x] seconds] • [Always on] 	
	[Screensaver]	<ul style="list-style-type: none"> • [Off] (default) • [Song title] • [Album art] • [Analog clock] • [Digital clock] • [Demo mode] 	
[Date and time]	[Time settings]	<ul style="list-style-type: none"> • [Set time format] • Set time 	
	[Date settings]	<ul style="list-style-type: none"> • [Set date format] • Set date 	
[Slideshow settings]	[Time per slide]	• [[x] seconds]	
	[Repeat]	<ul style="list-style-type: none"> • [Off] (default) • [On] 	
	[Shuffle]	<ul style="list-style-type: none"> • [Off] (default) • [On] 	
[Language]	<ul style="list-style-type: none"> • [English] (default) • Czech • Greek • German • Spanish • French • Italian • Hungarian 	<ul style="list-style-type: none"> • Dutch • Norwegian • Polish • Portuguese • Portuguese (Brazilian) • Russian • Slovak • Finnish 	<ul style="list-style-type: none"> • Swedish • Turkish • Simplified Chinese • Traditional Chinese • Japanese • Korean • Thai (/97 version only)
[Connect PC preference]	<ul style="list-style-type: none"> • [MSC] • [MTP] (default) 		
[Information]	<ul style="list-style-type: none"> • [Capacity:] • [Free space:] • [Firmware version:] • [Model:] • [Support site:] 		
[Factory settings]	[Restore factory settings? (Files transferred to player will not be affected.)]	<ul style="list-style-type: none"> • [Yes] • [No] 	

14 Update GoGear Ariaz

- ↳ GoGear Ariaz restarts after the firmware is updated and is ready for use again.

GoGear Ariaz is controlled by an internal program called firmware. Newer versions of the firmware may have been released after you have purchased GoGear Ariaz.

The software program called **Philips Device Manager** can use your computer to check for firmware updates that are available on the Internet.

Install **Philips Device Manager** on your computer from GoGear Ariaz or download the latest version from www.philips.com/support.



Note

- Your music files are not affected by a firmware update.

Manually verify / update firmware

- 1 Ensure that your computer is connected to the Internet.
- 2 Connect GoGear Ariaz to the computer (see section **Connect and charge** for instructions).
- 3 On your computer, click **Start > Programs > Philips Digital Audio Player > Ariaz Device Manager** to launch **Philips Device Manager**.
- 4 Click **Update**
↳ **Philips GoGear Ariaz Device Manager** checks for updates and installs new firmware from the Internet, if available.
- 5 When the display shows **Update completed**, click **OK**.
- 6 Disconnect GoGear Ariaz from the computer.

15 Troubleshooting

If GoGear Ariaz is not working properly or the display freezes, you can reset it without losing data:

How do I reset GoGear Ariaz?

- Insert a pen tip or other object into the reset hole located at the bottom of GoGear Ariaz. Hold until the player shuts down.
- If the reset option is unsuccessful, follow the steps how to recover GoGear Ariaz with the **Philips Device Manager**:
 - 1 On your computer, select **Start > Programs > Philips Digital Audio Player > Ariaz Device Manager > Philips Device Manager** to launch the **Philips Device Manager**.
 - 2 Turn off GoGear Ariaz before you continue.
 - 3 Press and hold the volume button **+** while you connect GoGear Ariaz to your computer.
 - 4 Keep holding the key until the **Philips Device Manager** acknowledges GoGear Ariaz and enters the recovery mode.
 - 5 On the computer, click the **Repair** button and follow the instructions of the **Philips Device Manager** to complete the recovery process.
 - 6 When the recovery is completed, disconnect GoGear Ariaz from your computer.
 - 7 Restart GoGear Ariaz.

16 Technical data

Power

Power supply: 310 mAh Li-ion polymer
internal rechargeable battery
Play time¹ (music): 25 hours

Software on CD-ROM

Windows Media Player
Philips Device Manager
Media Converter for Philips
Napster (available in Germany and in the UK
only)

Connectivity

Headphone 3.5 mm
USB 2.0 High speed

Sound

Channel separation: 45 dB
Frequency Response: 80 Hz - 18 kHz
Output power: 2 x 3 mW
Signal to noise ratio: > 84 dB

Audio playback

Compression format:
MP3 bit rates: 8 - 320 kps and VBR
MP3 sample rates: 8, 11.025, 16, 22.050, 24,
32, 44.1, 48 kHz
WMA bit rates: 5 - 192 kbps VBR
WMA sample rates: 8, 11.025, 16, 22.050, 24,
32, 44.1, 48 kHz
ID3-tag support
Audible format support

Video playback

SMV format support

Storage media

Built-in memory capacity²:
SA1ARA02 2GB NAND Flash
SA1ARA04 4GB NAND Flash
SA1ARA08 8GB NAND Flash
SA1ARA16 16GB NAND Flash

Music transfer³

Drag and drop in Windows® Explorer

Display

Color LCD 220 x 176 pixels

Note

- ¹ Rechargeable batteries have a limited number of charge cycles. Battery life and number of charge cycles vary by use and settings.
- ² 1GB = 1 billion bytes; available storage capacity is less. Full memory capacity may not be available as some memory is reserved for the player. Storage capacity is based on 4 minutes per song and 128 kbps MP3 encoding.
- ³ Transfer speed depends on operating system and software configuration.

System requirements

- Windows® XP (SP2 or above) / Vista
- Pentium III 800 MHz processor or higher
- 512 MB RAM
- 500 MB hard disk space
- Internet connection
- Windows® Internet Explorer 6.0 or later
- CD-ROM drive
- USB port

Supported music file formats

GoGear Ariaz supports the following music formats:

- MP3
- PCM
- ADPCM
- Audible
- WMA

Supported video file formats

GoGear Ariaz supports the following video formats:

- SMV

Supported picture file formats

GoGear Ariaz supports the following picture formats:

- JPEG

17 Glossary

A

Album art

Album art is a feature that displays the artwork (cover picture) of a music album. This display enables the user to quickly identify a music album. The artwork files for music albums can be downloaded from the Internet.

C

Compression

In audio terms, this is a process of temporarily or permanently reducing audio data for more efficient storage or transmission. A temporary reduction in file size is called 'non-lossy' compression, and no information is lost. A permanent reduction in file size (such as with MP3 files) is called 'lossy' compression, and involves discarding unnecessary information which is irretrievably lost.

D

Decibel (dB)

A unit of measure used to express relative difference in power or intensity of sound.

Digital Audio

Digital Audio is a sound signal that has been converted into numerical values. Digital sound can be transmitted through multiple channels. Analog sound can only be transmitted through two channels.

F

FM (Frequency Modulation)

In radio broadcasting: a method of modulation in which the frequency of the carrier voltage is varied with the frequency of the modulation voltage.

FullSound

FullSound™ is an innovative technology designed by Philips. FullSound™ faithfully restores sonic details to compressed music, enhancing it to provide a full sound experience without any distortion.

J

JPEG

A very common digital still picture format. A still-picture data compression system proposed by the Joint Photographic Expert Group, which features small decrease in image quality in spite of its high compression ratio. Files are recognized by their file extension '.jpg' or '.jpeg.'

K

Kbps

Kilobits per second. A digital-data-rate measurement system which is often used with highly compressed formats such as AAC, DAB, MP3 etc. The higher the amount, the better the quality generally is.

L

LCD (Liquid Crystal Display)

Probably the most common way to show visual information on non-computer electronic equipment.

M

MHz (Mega Hertz)

One million cycles per second.

MP3

A file format with a sound data compression system. MP3 is the abbreviation of Motion Picture Experts Group 1 (or MPEG-1) Audio Layer 3. With the MP3 format, one CD-R or CD-RW can contain about 10 times more data than a regular CD.

N

Napster

Napster, Inc. (NASDAQ: NAPS, formerly Roxio, Inc.) is an online music service offering a variety of purchase and subscription models.

P

PCM (Pulse Code Modulation)

Pioneering form of digital recording.

PlaysForSure*

PlaysForSure* is a Philips GoGear feature that ensures compatibility with Windows Media Player 10 and Windows XP. The PlaysForSure* logo assures the consumer that the music purchased at an online shop with this logo is compatible with the Philips GoGear player.

S

Shuffle

A feature that plays audio files (tracks) in random order.

SMV [SigmaTel Motion Video Format]

A partially compressed video format by SigmaTel that allows conversion of common PC motion video files for play on a portable multimedia player.

Stereo

Literally means solid. Usually taken to refer to two channel stereo, though developments in digital audio facilitate multichannel stereo.

SuperPlay

SuperPlay™ is a special feature of the product, which enables the listener to play all the music under a top-level library category, such as artists or albums, without having to select playlist items.

SuperScroll

SuperScroll™ is a navigation feature of the double-action search keys of the product. SuperScroll™ allows easy speed control when

scrolling through large libraries to swiftly find items within large libraries. Longer press of the button results in faster scroll speed.

T

Thumbnail

A thumbnail is reduced-size versions of a picture that is used to make it easier to recognize an them. Thumbnails serve the same role for images as a normal text index does for words.

V

Volume

Volume is the most common word used to specify the control of relative loudness of sounds. It also pertains to the function on many electronic devices that is used to control the loudness.

W

WAV

A format for sound files developed jointly by Microsoft and IBM. Built into Windows 95 to XP, which made it the de facto standard for sound on PCs. WAV sound files end with a '.wav' extension and works with nearly all Windows applications that support sound.

WMA (Windows Media Audio)

An audio format owned by Microsoft, is a part of Microsoft Windows Media technology. Includes Microsoft Digital Rights Management tools, Windows Media Video encoding technology, and Windows Media Audio encoding technology.

WMV [Windows Media Video]

Refers to a video compression technology developed by Microsoft Corporation. WMV content can be encoded by using Windows Media® Encoder 9 series. Files are recognised by their file extension '.wmv'.

