

CDR Mini Hi-Fi system

FW-R8



Let's make things better.



PHILIPS

Important notes for users in the U.K.

Mains plug

This apparatus is fitted with an approved 13 Amp plug. To change a fuse in this type of plug proceed as follows:

- 1 Remove fuse cover and fuse.
- 2 Fix new fuse which should be a BS1362 5 Amp, A.S.T.A. or BSI approved type.
- 3 Refit the fuse cover.

If the fitted plug is not suitable for your socket outlets, it should be cut off and an appropriate plug fitted in its place. If the mains plug contains a fuse, this should have a value of 5 Amp. If a plug without a fuse is used, the fuse at the distribution board should not be greater than 5 Amp.

Note: The severed plug must be disposed of to avoid a possible shock hazard should it be inserted into a 13 Amp socket elsewhere.

How to connect a plug

The wires in the mains lead are coloured with the following code: blue = neutral (N), brown = live (L).

As these colours may not correspond with the colour markings identifying the terminals in your plug, proceed as follows:

- Connect the blue wire to the terminal marked N or coloured black.
- Connect the brown wire to the terminal marked L or coloured red.
- Do not connect either wire to the earth terminal in the plug, marked E (or \perp) or coloured green (or green and yellow).

Before replacing the plug cover, make certain that the cord grip is clamped over the sheath of the lead - not simply over the two wires.

Copyright in the U.K.

Recording and playback of material may require consent. See Copyright Act 1956 and The Performer's Protection Acts 1958 to 1972.

Italia

DICHIARAZIONE DI CONFORMITA'

Si dichiara che l'apparecchio FW-R8 Philips risponde alle prescrizioni dell'art. 2 comma 1 del D. M. 28 Agosto 1995 n. 548.

Fatto a Eindhoven

Philips Consumer Electronics
Philips, Glaslaan 2
5616 JB Eindhoven, The Netherlands

Norge

Typeskilt finnes på apparatens bakside.

Observer: Nettbryteren er sekundert innkopleet. Den innebygde nettdelen er derfor ikke frakopleet nettet så lenge apparatet er tilsluttet nettkontakten.

For å redusere faren for brann eller elektrisk støt, skal apparatet ikke utsettes for regn eller fuktighet.

English4

English

Français.....32

Français

Español60

Español

Deutsch.....88

Deutsch

General information	
Accessories supplied	4
Setup information	4
Maintenance	4
Environmental information	4
Discs for recording	5
Discs for playback	5
CD(RW) handling	5
Controls and connections	6-7
Installation	
Mains	8
Speaker connections	8
Antenna connections	8
Analogue audio connections	9
Digital audio connections	9
Connecting a subwoofer	9
Remote control	
Remote control buttons	10
Remote control batteries	10
Display	11
Basic functions	
Switching on, switching to standby	12
Loading the CD changer, CD recorder	12
Playing a CD(RW)	12
Sound control	13
Demo mode	13
Selecting a disc on the CD changer	14
Selecting a track and searching	14
SHUFFLE and REPEAT	14
CD text	14
Microphone mixing	14
Program	
Programming track numbers	15
Erasing a track from the program	15
Clearing the program	15
Making a program for recording	15
About recording	
Basic information	16
Direct Line Recording (DLR)	16
Auto Level Control (ALC)	16
REC LEVEL key	16
Internal recording	
Recording modes	17
High speed recording and automatic finalizing	17
High speed recording	18
Normal recording and listening	18
Manual recording	19
External recording	
Analogue or digital recording?	20
Recording with automatic start	20
Manual recording	21
Automatic track increment	22
(Un)finalizing, erasing	
Finalizing CDR(W) discs	22
Unfinalizing CDRW discs	23
Erasing from a CDRW disc	23
Features	
EDIT TEXT (on CD recorder only)	24-25
Track editing (on CD changer only)	25
Tuner	
Tuning to radio stations	26
Storing radio stations	26
Tuning to preset stations	26
RDS	27
NEWS/TA – News and traffic announcement	27
EON	27
Clock/Timer	
Clock setting	28
Alarm timer	29
Record timer	29
Switching the alarm and record timer on/off	29
Sleep timer	29
Technical data	30
Troubleshooting	31

Accessories supplied

- 2 loudspeakers including 2 speaker cables
- Remote control
- 2 batteries for the remote control, size AA
- AM (MW) loop antenna
- FM wire antenna
- Mains cable

Setup information

Place the set on a flat, hard and stable surface. Make sure there is sufficient space around the set to prevent overheating.

Active mobile phones close to the CDR Mini Hi-Fi system may cause malfunctions.

Maintenance

Clean the set with a soft, slightly dampened, lint-free cloth. Do not use any cleaning agents as they may have a corrosive effect.



Do not expose the set, batteries or discs to humidity, rain, sand or excessive heat (caused by heating equipment or direct sunlight).

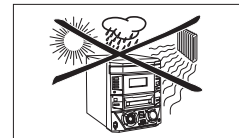

Environmental information

All redundant packing material has been omitted. We have done our utmost to make the packaging easily separable into three mono materials: cardboard (box), polystyrene foam (buffer) and polyethylene (bags, protective foam sheet).

Your set consists of materials which can be recycled if disassembled by a specialized company. Please observe the local regulations regarding the disposal of packing materials, exhausted batteries and old equipment.

As an ENERGY STAR® partner, Philips has determined that this product meets the ENERGY STAR® guidelines for energy efficiency.



This set complies with the radio interference requirements of the European Community.

Discs for recording

For recording, make sure to use special audio discs only. These discs are marked "Digital Audio" and the logos shown below.

There are two different types of audio discs for the use on this CD recorder:

– CD-Audio Recordable (CDR) discs

These discs can be recorded on once and play on all standard CD players and CD recorders, when finalized.



– CD-Audio ReWritable (CDRW) discs

These discs can be recorded on, erased and re-recorded many times and play on CDRW compatible CD players and CD recorders, when finalized.



All Philips CD players and CD recorders with this sticker are CDRW compatible.



To ensure proper working of the set we recommend the use of Philips audio CDR and audio CDRW discs only.

Note: Do not use a computer CDR or CDRW as recording will not work properly!

Recording is permissible insofar as copyright or other rights of third parties are not infringed upon.

In some countries the use of the Philips CDR Mini Hi-Fi system as shown or suggested in this user manual may require the authorization of copyright holders.

Discs for playback

For playback on this CD changer and CD recorder you can use following audio discs:

– All pre-recorded audio CDs

– All audio CDR and audio CDRW discs

Notes: – Do not try to play a CD-ROM, CD-I or CDV!
– CDR(W) discs, which are recorded on a computer can only be used when they are correctly treated according to the audio standard (IEC958: Consumer part). Single session only!

CD(RW) handling

If the CDR Mini Hi-Fi system fails to read discs correctly use a commonly available cleaning-CD to clean the lenses before submitting the set to repair. Other cleaning methods may destroy the lenses. Always keep the trays closed to avoid dust on the lenses.

The lenses may cloud over when the set is suddenly moved from cold to warm surroundings. Playing a CD(RW) is not possible then. Leave the set in a warm environment until the moisture evaporates.

To take a CD(RW) out of its box easily, press the centre spindle while lifting the CD(RW). Always pick up a CD(RW) by the edge and put it back in its box after use. Never write on a CD or attach a sticker to it. Write only on the printed side of a CDR or CDRW, and only with a soft felt-tipped pen.

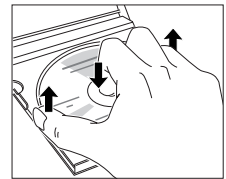

To clean a CD(RW), wipe it in a straight line from the centre toward the edge using a soft, lint-free cloth. A cleaning agent may damage the disc!

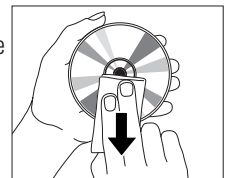

CAUTION

Use of controls or adjustments or performance of procedures other than herein may result in hazardous radiation exposure or other unsafe operation.

CAUTION

INVISIBLE LASER RADIATION WHEN OPEN.
AVOID EXPOSURE TO BEAM.

Note: This warning is located inside the enclosure.

CONTROLS AND CONNECTIONS

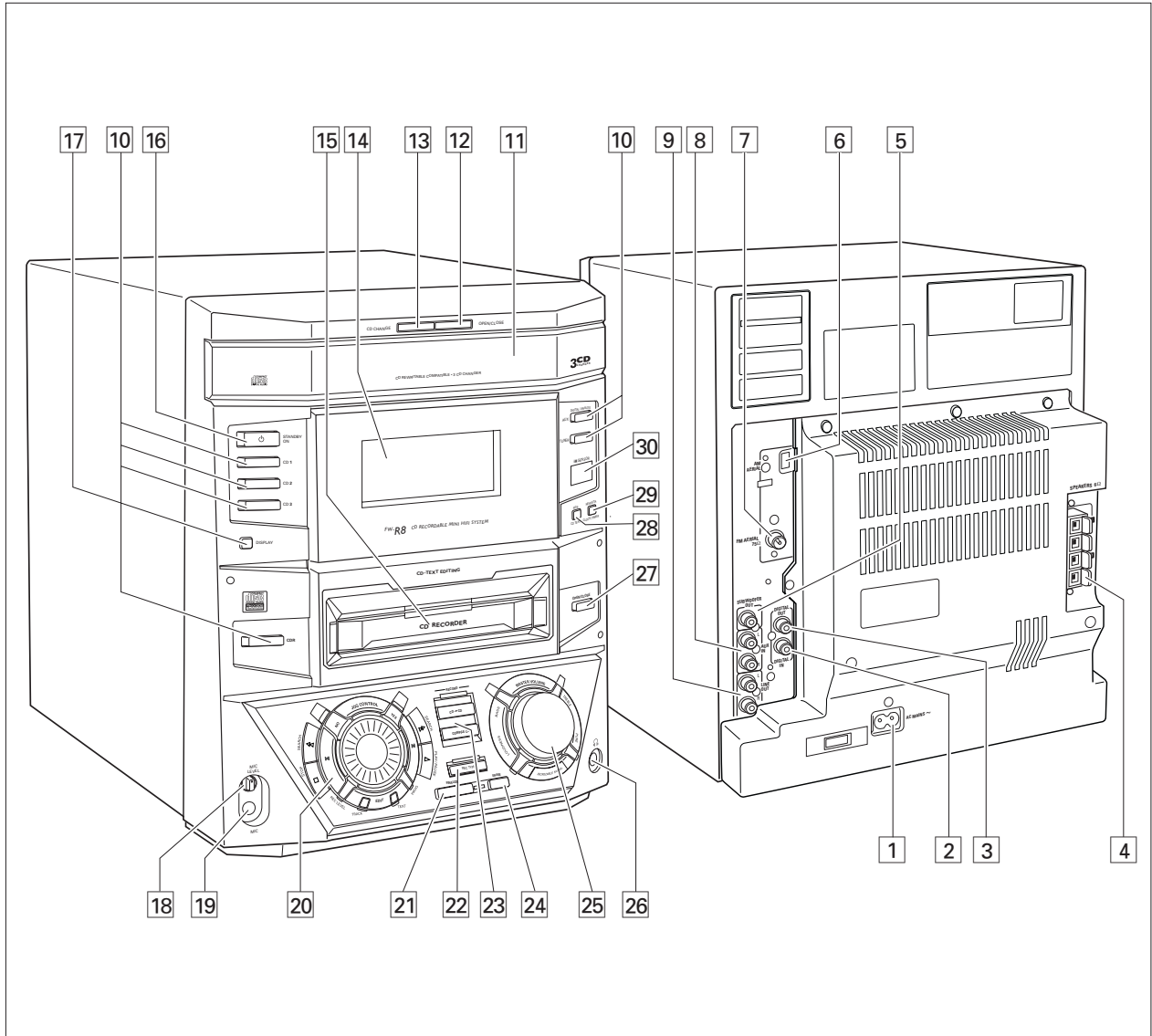

On the back

- 1 **AC MAINS ~** *After all other connections have been made*, connect the mains lead to the wall socket.
For optimal performance use only the original mains cable.
- 2 **DIGITAL IN** connect to the coaxial output of a digital appliance
- 3 **DIGITAL OUT** connect to the coaxial input of a digital appliance
- 4 **SPEAKERS 6 Ω L/R** connect to the supplied speakers
- 5 **SUBWOOFER OUT** connect to the input of a subwoofer
- 6 **AM AERIAL** connect the supplied frame antenna here
- 7 **FM AERIAL 75 Ω** connect the supplied wire antenna here
- 8 **AUX IN L/R** connect to the analogue audio output of an additional appliance
- 9 **LINE OUT L/R** connect to the analogue audio input of an additional appliance

On the front

- 10 Source selection**
CD 1, CD 2, CD 3selects the CD changer, switches to CD 1, CD 2 or CD 3
- CDR**selects the CD recorder
TUNERselects the tuner
DIGITAL / ANALOG AUXselects the input for an additional appliance
- 11**CD changer tray
- 12 OPEN/CLOSE**opens and closes the CD changer tray
- 13 CD CHANGE**selects the next disc tray
- 14**display
- 15 CD RECORDER**CD recorder tray
- 16** **STANDBY ON**switches the set on and to standby
- 17 DISPLAY**selects display information/text
- 18 MIC LEVEL**adjusts the microphone volume
- 19 MIC**microphone socket
- 20 Multiple function control**
Rotary control:
◀ JOG CONTROL ▶CDC, CDR: selects the previous/next track
TUNER: selects the previous/next preset tuner station
- Keys to press:*
YESconfirms a selection
▶▶ SEARCHCDC, CDR: searches forward, reviews the tracks in a program, controls the cursor in different menus
TUNER: tunes to a higher radio frequency
- ▶ PLAY/PAUSE**starts and interrupts playback/recording
- PROG**opens/closes the program menu
- EDIT TEXT**enters/exits the text edit menu
- EDIT TRACK**enters/exits the track edit menu
- REC LEVEL**enables the rotary control to adjust the level for recordings
- STOP**stops CD play/record, closes program memory
- ◀◀ SEARCH**CDC, CDR: searches backward, reviews the tracks in a program, controls the cursor in different menus
TUNER: tunes to a lower radio frequency
- NO**cancels a selection

- 21 FINALIZE**finalizes and unfinalizes recordings
- 22 REC TYPE**enters/exits the recording menu
- 23 RECORD**
CD→CDselects high speed recording and automatic finalizing of current CD
- COMPILE CD**selects high speed recording and automatic finalizing of current program
- 24 ERASE**erases recordings
- 25 Sound control**
MASTER VOLUMEadjusts the volume
TREBLEsets the treble level
PUREswitches bass and treble settings on/off
- INCREDIBLE SURR.**creates an incredibly wide stereo effect
- LOUDNESS**boosts up treble and bass
- BASS**sets the bass level
- 26**3.5 mm headphone socket
Note: Connecting the headphones will switch off the speakers.
- 27 OPEN/CLOSE**opens and closes the CD recorder tray
- 28 RDS**switches through RDS information
- CD TEXT**switches through CD text information
- 29 NEWS/TA**TUNER: switches the RDS news and the RDS traffic announcement on and off
- CLOCK/TIMER**selects the clock function, activates and deactivates the timer
- 30 iR SENSOR**sensor for the infrared remote control

Note: You will recognize that various keys will be illuminated on the set depending on the different modes or programs you are in. This is for your guidance in order to facilitate the finding of the relevant keys for selection.

INSTALLATION

Mains

The type plate is located on the rear of the set.

- 1 Check whether the mains voltage as shown on the type plate corresponds to your local mains voltage. If it does not, consult your dealer or service organisation.
- 2 **Make sure all connections have been made before switching on the mains supply.**
- 3 Connect the mains cable supplied to AC MAINS ~ and to the wall socket. This switches on the mains supply.

For optimal performance use only the original mains cable.

When the set is switched to standby, it is still consuming some power. To disconnect the set from the mains completely, remove the mains plug from the wall socket.

For users in the U.K.: please follow the instructions on page 2.

To avoid overheating of the set a safety circuit has been built in. Therefore your set may disconnect under extreme conditions. If this happens, switch the set off and let it cool down before reusing it.

Speaker connections

The speaker connections are click-fit connectors. Use them as shown below.

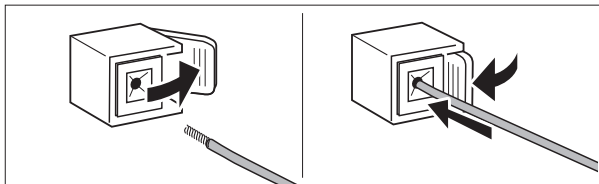

- 1 Connect the coloured (or marked) wire to the red terminal and the black (or unmarked) wire to the black terminal.
- 2 Connect:
 - Left speaker to L (red and black)
 - Right speaker to R (red and black)

Antenna connections

AM antenna

The loop antenna supplied is for indoor use only.

- 1 Fit the plug of the loop antenna to AM AERIAL as shown below.
- 2 Position the antenna as far away as possible from the TV, a VCR and other radiation sources.
- 3 Turn the antenna for optimum reception.

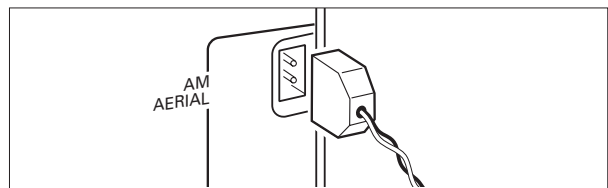

FM antenna

The wire antenna supplied can only be used to receive nearby stations. For better reception we recommend using a cable antenna system or an outdoor antenna.

- 1 Fit the supplied wire antenna to FM AERIAL 75 Ω as shown below.
 - 2 Move the antenna in different positions for optimum reception.
- If you are using a cable antenna system or an outdoor antenna, fit the antenna plug to FM AERIAL 75 Ω instead of the wire antenna.

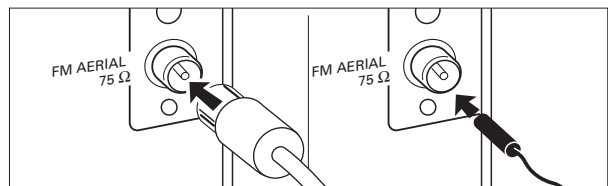

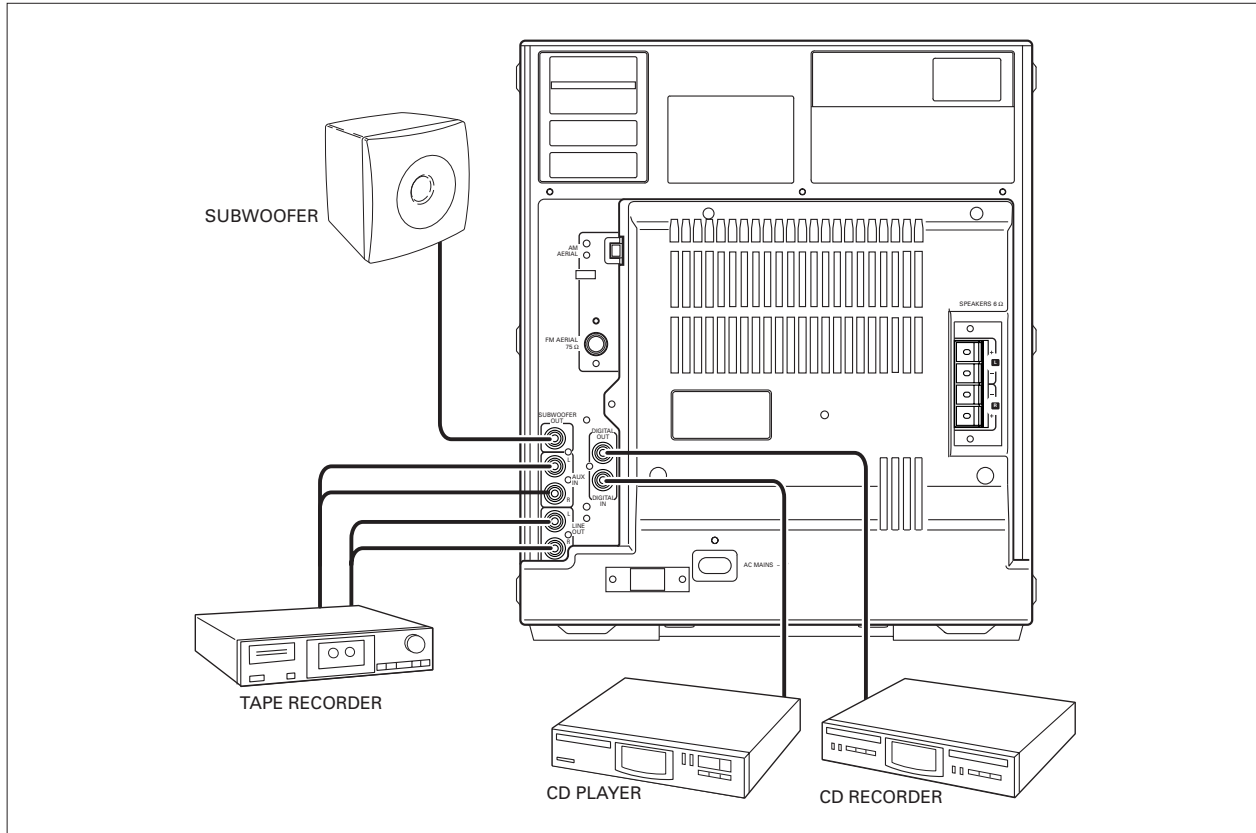

Analogue audio connections

AUX IN L/R

It is possible to use an additional appliance, e.g. tape recorder, TV or VCR with the set.

- 1 Insert the red plug of a cinch cable to the red socket AUX IN R and the white plug to the white socket AUX IN L.
- 2 Connect the other end of the cinch cable to the audio outputs of the additional appliance.
- 3 Press DIGITAL / ANALOG AUX repeatedly to select the analogue input for the appliance.
→AUX Analog is displayed.
- 4 Operate your appliance as usual and adjust volume and sound with the set.

Note: It is not possible to connect a turntable directly to AUX IN L/R. If you wish to use a turntable with the set, you have to connect an amplifier to AUX IN L/R on the set. Then connect the turntable to the amplifier.

LINE OUT L/R

You can use these outputs for playback or recording on any analogue audio equipment e.g. amplifier or tape recorder.

- Use a cinch cable to connect the analogue audio inputs of the additional appliance with LINE OUT L/R on the set and operate your appliance as usual.

Digital audio connections

DIGITAL IN

You can use this coaxial input for recordings from any digital audio equipment with a digital coaxial output e.g. CD player or DVD player.

- 1 Use a coaxial cable to connect the coaxial output of the additional appliance with DIGITAL IN on the set.
- 2 Press DIGITAL / ANALOG AUX repeatedly to select the digital input for the appliance.
→AUX Digital is displayed.
- 3 Operate your appliance as usual.

DIGITAL OUT

You can use this coaxial output for recordings on any digital audio equipment with a digital coaxial input e.g. CD recorder.

- Use a coaxial cable to connect the coaxial input of the additional appliance with DIGITAL OUT on the set and operate your appliance as usual.

Connecting a subwoofer

A subwoofer can be used to enhance the bass performance of your set dramatically.

- 1 Use a cinch cable to connect the input of the subwoofer with SUBWOOFER OUT at the set.
- 2 Follow the instructions supplied with the subwoofer.

REMOTE CONTROL

Remote control buttons

- ⏻switches the set to standby
- CDR, TUNER, CD1, CD2, CD3, AUX.....selects the sources
- Number/alphabet keys
 - 1–0keys in numbers for tracks or stations
 - ABC – XYZkeys in letters for text
 - SPACEkeys in a space within the text
- EDIT TEXTenters the text edit menu
- VOLUME.....decreases the volume
- + VOLUME.....increases the volume
- ▶starts playback/recording
- ◀CDC, CDR: selects the previous track
TUNER: selects the previous preset tuner station
- ▶ |CDC, CDR: selects the next track
TUNER: selects the next preset tuner station
-stops CD play/recording, closes program memory
- ▶▶CDC, CDR: searches forward, reviews the tracks in a program, controls the cursor in different menus
TUNER: tunes to a higher radio frequency
- ◀◀CDC, CDR: searches backward, reviews the tracks in a program, controls the cursor in different menus
TUNER: tunes to a lower radio frequency
- ⏸interrupts playback/recording
- YESselects a selection
- NOcancels a selection
- PROGRAMopens/closes the program menu
- SHUFFLEplays tracks in random order
- REPEATrepeats a track, the entire CD(RW) or the program
- TRACK INCR.selects automatic or manual increment of a track
- TIMER ON/OFFactivates and deactivates the timer
- SLEEPactivates the sleep timer
- MUTE.....mutes the sound
- BRIGHTNESScontrols the brightness of the display
- L BALANCEadjusts the volume balance to the left speaker
- R BALANCEadjusts the volume balance to the right speaker
- LOUDNESSboosts up treble and bass
- INCREDIBLE
- SURROUNDcreates an incredibly wide stereo effect
- PUREswitches bass and treble settings on/off

Note: Always press the source key of the source you wish to control (e.g. CD1) before selecting the desired function key (e.g. SHUFFLE).

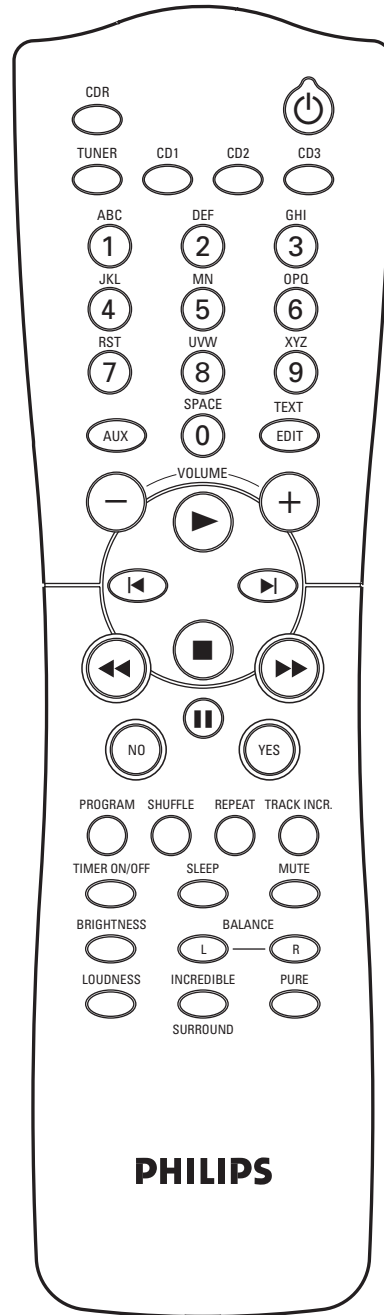

Remote control batteries

Open the battery compartment of the remote control and insert 2 alkaline batteries, type **AA** (R06, UM-3).

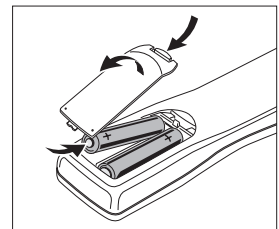

Do not use old and new or different types of batteries in combination.

Remove batteries if they are empty or if the remote control is not to be used for a long time.

Batteries contain chemical substances, so they should be disposed of properly.

Display

The display of the set is divided into 3 sections, which show you the following:

Information area

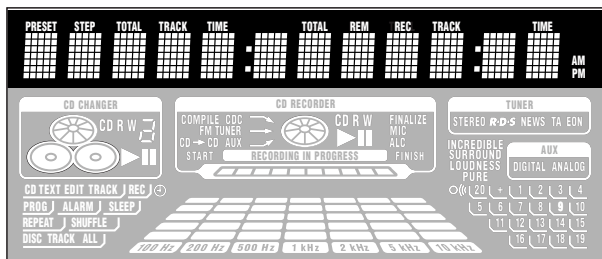

This area is used for feedback of the CD changer, CD recorder, tuner frequencies, menu options, values and scrolling text messages.

Status lights and flags

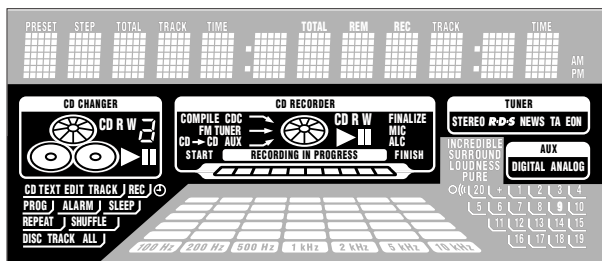

Flags

- CD TEXT** CD text is available
- CD TEXT EDIT** text edit menu is active
- EDIT TRACK** track edit menu is active
- REC** ⌚ record timer is selected
- PROG** program menu is active
- ⌚ clock is selected
- ALARM** ⌚ alarm timer is selected
- SLEEP** sleep timer is selected
- REPEAT DISC** selected disc is played repeatedly
- REPEAT TRACK** current track is played repeatedly
- REPEAT ALL** all discs in the CD changer (or the program) are (is) played repeatedly
- SHUFFLE** either all tracks of the program or of the loaded disc(s) in the CD changer or CD recorder are played in random order

CD Changer

- number of disc trays loaded
- playback is activated
- playback is interrupted
- CD 1, 2, 3** disc tray 1, 2 or 3 is selected and loaded with a pre-recorded CD, finalized CDR or CDRW
- CD R 1, 2, 3** disc tray 1, 2 or 3 is selected and loaded with an unfinalized CDR
- CD RW 1, 2, 3** disc tray 1, 2 or 3 is selected and loaded with an unfinalized CDRW

CD Recorder

- COMPILE CDC** current program is being recorded with high speed dubbing and auto finalize
- FM TUNER** FM station is being recorded
- CD → CD** current disc is being recorded with high speed dubbing and auto finalize
- AUX** material from an external source is being recorded
- playback is activated
- playback is interrupted
- RECORDING IN PROGRESS** recording in progress
- status of recording progress is shown
- CD** pre-recorded CD, finalized CDR or CDRW inserted
- CD R** unfinalized CDR inserted
- CD RW** unfinalized CDRW inserted
- FINALIZE** (un)finalizing will start
- MIC** microphone input is being used
- ALC** auto level control is active

Tuner

- STEREO** FM station is being received in stereo
- R-D-S** RDS station is being received
- NEWS** RDS news announcement is on
- TA** RDS traffic announcement is on
- EON** EON is active
- AUX** digital input in use for external source
- DIGITAL** digital input in use for external source
- ANALOG** analogue input in use for external source

Music calendar, sound lights and remote control

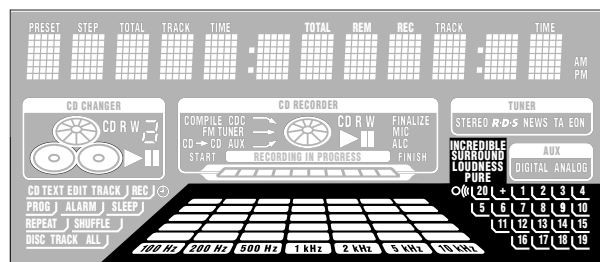

- INCREDIBLE SURROUND** Incredible Surround is active
- LOUDNESS** Loudness is active
- PURE** bass and treble settings are switched off
- command from remote control is being received

Music calendar

- 1-20** CDC, CDR: actual track number played, number of tracks on a disc/program
TUNER: preset number of tuned station
- +** CDC, CDR: disc or program contains more than 20 tracks
TUNER: more than 20 radio stations are stored
- spectrum analyzer

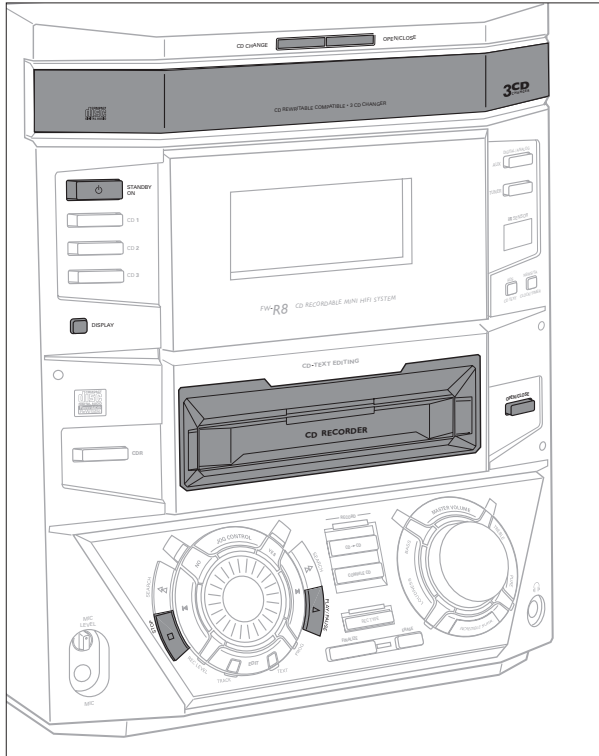

Switching on, switching to standby

- To switch the set on press **⏻** STANDBY ON on the set.
- To switch the set to standby press **⏻** STANDBY ON again on the set (**⏻** on the remote control).

Loading the CD changer, CD recorder

Important!

- 1) **This system is designed for regular CD(RW)s. Therefore, do not use any accessories such as disc stabilizer rings or CD treatment sheets, etc. as offered on the market, because they may cause jamming of the changer mechanism.**
- 2) **Do not load more than one disc into one disc tray.**

1 CD changer:

Press OPEN/CLOSE on the set to open the CD changer tray.
→Open CDC is displayed and the tray is opened.

CD recorder:

Press OPEN/CLOSE on the set to open the CD recorder tray.
→Open CDR is displayed and the tray is opened.

2 CD changer:

You can load up to three discs in the CD changer for continuous playback without interruption. Insert an audio disc (printed side up) in the right disc tray.

- You can load another disc in the left disc tray.
- To insert a third audio disc press CD CHANGE on the set.
→The CD carousel will rotate until the empty disc tray is at the right hand side.

CD recorder:

Insert an audio disc (printed side up) in the tray.

3 CD changer:

Press OPEN/CLOSE on the set again to close the tray.

- The tray is closed and Reading is displayed.
- If an unfinalized disc is inserted Initializing will be displayed.
- CD, the disc tray number, the total number of tracks and the total playing time of the disc in the last selected disc tray are displayed. The track numbers light up in the music calendar.

CD recorder:

Press OPEN/CLOSE on the set again to close the tray.

- The tray is closed and Reading is displayed.
- If an unfinalized disc is inserted Initializing will be displayed.
- CDR, the total number of tracks and the total playing time of the disc are displayed. The track numbers light up in the music calendar.

Playing a CD(RW)

- 1 Press **▶** PLAY/PAUSE (**▶** on the remote control) to start playback.

CD changer:

- CD, the disc tray number, the current track number and elapsed playing time are displayed. The current track number is also blinking in the music calendar.

CD recorder:

- CDR, the current track number and elapsed playing time are displayed. The current track number is also blinking in the music calendar.

- To switch through the following information, press repeatedly DISPLAY on the set:
 - Track number, remaining playing time of current track
 - Track number, remaining playing time of disc
 - Track number, actual playing time of current track

- 2 Press **■** STOP (**■** on the remote control) to stop playback.

CD changer:

- CD, the disc tray number, the total number of tracks and the total playing time of the disc are displayed.

CD recorder:

- CDR, the total number of tracks and the total playing time of the disc are displayed.

- To switch through following information press repeatedly DISPLAY on the set:
 - Total number of tracks, total playing time of disc
 - CD text is displayed.
- You can interrupt playback by pressing **▶** PLAY/PAUSE (**||** on the remote control).
→The time where playback was interrupted is blinking.
- To resume playback press **▶** PLAY/PAUSE (**▶** on the remote control) again.

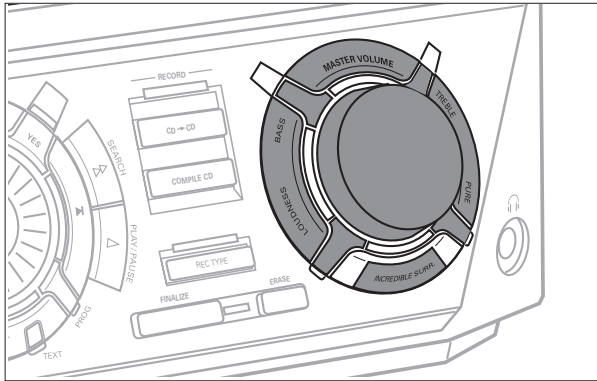

Sound control

Volume adjustment

- Adjust the volume by using MASTER VOLUME (– VOLUME/ + on the remote control).
 - The volume level in dB (decibel) is displayed.

Incredible Surround

Stereo sound is determined by the distance between the front speakers. Incredible Surround enables you to enjoy an incredibly wide stereo effect, regardless of the speakers' distance.

- Press INCREDIBLE SURR. (INCREDIBLE SURROUND on the remote control) to switch the surround sound effect either on or off.
 - INCREDIBLE SURROUND is shown and Incredible Surround is displayed if the surround sound effect is on.

Note: The effect of Incredible Surround may vary with different types of music.

Treble and Bass level adjustment

- Press TREBLE or BASS on the set.
 - The volume rotary is activated to select the treble/bass settings.
- Turn the volume rotary to adjust the treble or bass.
 - Treble or Bass and the actual value (between –5 and +5) is displayed briefly.

Note: If the volume rotary is not turned for 5 seconds, it will switch back to volume.

PURE

- Press PURE repeatedly to switch bass and treble settings either on or off.
 - PURE is shown and Pure is displayed if bass and treble settings are switched off.
 - Optimal is displayed if preset bass and treble settings are switched on.
 - Personal is displayed if personal preset bass and treble settings are switched on.

LOUDNESS

- Press LOUDNESS to switch loudness either on or off.
 - LOUDNESS is shown and Loudness is displayed if loudness is on.

MUTE

This feature allows you to temporarily switch off the sound without switching off the set.

- Press MUTE on the remote control to switch off the sound.
 - Mute is displayed and playback/recording will be continued without sound.
- Press MUTE on the remote control again to switch on the sound again.

Speaker balance

It is possible to adjust the relative volume balance between the connected front speakers.

- Press L BALANCE or R BALANCE on the remote control to adjust the relative volume of the left or right front speaker.
 - Balance L (or R) and the actual volume of the left (or right) front speaker are displayed.
 - When the volume of both speakers is balanced, Balance L=R is displayed.

Demo mode

The demo mode displays various features of the set and will start automatically.

- If any source key is pressed:
 - The set switches to the selected source.
- If \odot STANDBY ON is pressed:
 - The set switches to standby. After a few seconds, the demonstration will start again.

Cancelling the demo mode

- Keep ■ STOP on the set pressed for at least 3 seconds to cancel the demo mode.
 - The demo mode is cancelled permanently. The set switches to standby. A few seconds later the set switches to an economy power save mode.

Selecting a disc on the CD changer

- Press either CD 1, CD 2 or CD 3 to select a particular disc.

Selecting a track and searching

Selecting a track during playback

- Rotate ◀ JOG CONTROL ▶ (press ◀ or ▶ on the remote control) to skip to the beginning of the previous or next track on the selected disc.
 - Playback continues with the selected track.

Selecting a track when playback is stopped

- 1 Rotate ◀ JOG CONTROL ▶ (press ◀ or ▶ on the remote control) to skip to the required track number.
 - Playback starts with the selected track.
- 2 Press ▶ PLAY/PAUSE (▶ on the remote control) to start playback.
 - Playback starts with the selected track.

Note: Instead of using ◀ or ▶ on the remote control you can also directly key in the required track number by using the numerical keys. For 2-digit numbers, press the keys in rapid succession.

Searching for a passage during playback

- 1 Keep ◀◀ SEARCH or ▶▶ SEARCH (◀◀ or ▶▶ on the remote control) pressed to find a particular passage in backward or forward direction.
 - Searching is started and playback continues at a low volume. After 3 seconds the search speeds up with volume muted.
- 2 Release the key at the desired passage.
 - Normal playback continues.

Note: During SHUFFLE, while repeating a track or playing a program, searching is only possible within the current track.

SHUFFLE and REPEAT

Repeating a track, the disc or the program

- 1 Press repeatedly REPEAT on the remote control during playback to select either:
 - **REPEAT TRACK:** The current track is played repeatedly.
 - **REPEAT DISC:** The entire selected disc is played repeatedly.
 - **REPEAT ALL:** All discs in the CD changer (or the program) are (is) played repeatedly.
- 2 Playback starts in the chosen mode.
- 3 To return to normal playback, press REPEAT on the remote control until the display indication disappears.

Note: REPEAT DISC is not possible during SHUFFLE or while playing a program.

Playing tracks in random order

- 1 Press SHUFFLE on the remote control during playback.
 - **SHUFFLE** is shown and either all tracks of the program or of the loaded disc(s) in the CD changer or CD recorder are played in random order.
- 2 To return to normal playback, press SHUFFLE again.

CD text



This feature allows the display of information such as album title or track title contained on a specially encoded CD.

- Make sure to insert a CD with CD text.
 - **CD TEXT** is shown and the album title is scrolled once.

CD text when playback is stopped

- Press CD TEXT on the set to see the following information, which will be scrolled once (if available):
 - **Album title**
 - **Artist's name on album**

CD text during playback

- Press CD TEXT on the set to see the following information, which will be scrolled once (if available):
 - **Artist's name on track** (on CD recorder only)
 - **Track title**

Microphone mixing

- 1 Set MIC LEVEL to the minimum level to prevent acoustic feedback (e.g. a loud howling sound) before you connect the microphone.
- 2 Connect a microphone to MIC.
- 3 Press CD 1, CD 2, CD 3, CDR, TUNER or DIGITAL / ANALOG AUX to select the source you wish to mix the microphone with.
- 4 Play the selected source.
- 5 Adjust the volume by using MASTER VOLUME.
- 6 Adjust the desired mixing level between source and microphone by turning MIC LEVEL.
- 7 Start singing or talking through the microphone.

Note: Keep the microphone away from the speakers to prevent a howling sound.

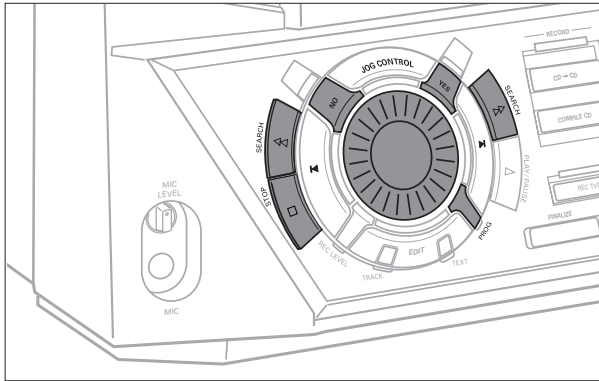

Programming track numbers

You can select tracks and store them either in the CD changer or CD recorder memory. If you use the program for playback you can choose one of the two memories, else if you like to specify tracks for recording, use the CD changer memory only! You can store any track more than once.

- 1 Load the desired disc(s) in the disc tray(s).
- 2 Press either CD 1, CD 2, CD 3, or CDR to select the disc.
- 3 Press PROG on the set (PROGRAM on the remote control).
→ **PROG** starts blinking and Program is displayed.
- 4 **If either CD 1, CD 2 or CD 3 is selected:**
Rotate ◀ JOG CONTROL ▶ to select either:
→ CD1 (or 2, 3) ALL: All tracks of CD 1 (or 2, 3) will be programmed.
→ CD1 (or 2, 3) and track number: The track number of CD 1 (or 2, 3) will be programmed.
- If CDR is selected:**
Rotate ◀ JOG CONTROL ▶ (press the numerical keys on the remote control; for 2-digit numbers, press the keys in rapid succession) to select a track number.
- 5 Press YES to store your selection in the memory.
→ The number of programmed tracks (**STEP**), Prog and the total program time are displayed. The track number blinks in the music calendar.
- 6 Select and store all desired tracks in this way.
- 7 Press PROG on the set (PROGRAM on the remote control) to end programming.
→ **PROG** stays shown and the program is currently available.

Note: If the maximum number of programmable tracks is reached, the display shows Program full.

Erasing a track from the program

- 1 If necessary press ■ STOP on the set (■ on the remote control) to stop playback.
- 2 Press either CD 1, CD 2, CD 3, or CDR to select the desired memory.
- 3 Press PROG (PROGRAM on the remote control), followed by ◀◀ SEARCH or ▶▶ SEARCH (◀◀ or ▶▶ on the remote control) to move through the program steps.
→ The track number at the selected step and the total program time are displayed.
- 4 Press NO to remove the track from the program.
→ Cleared is displayed briefly.
→ The next programmed track number will move up to this position and is displayed together with the step number and the remaining total program time.

Clearing the program

- 1 If necessary press ■ STOP on the set (■ on the remote control) to stop playback.
- 2 Press NO.
→ Clear Prog? is displayed.
- 3 Press YES to clear the program.
→ Prog Cleared will be displayed and **PROG** goes off.

Note: When you open the CD recorder tray or the CD changer tray the respective program will be cleared.

Making a program for recording

- 1 Select and store all desired tracks in the CD changer memory (see "Programming track numbers").
- 2 Enter the recording menu (see "Internal recording").
- If the total time of the program is of bigger size than the remaining recording time of the CDR(W):
→ Not fitting! will be displayed briefly, followed by the remaining recording time and Record Prog?
If you nevertheless start recording, only those tracks of the program that fit onto the CDR(W) will be recorded in entirety.
- To change the program press NO.
→ Edit Program will be displayed briefly, **PROG** and the time of the program start blinking. Now you can change the program (see "Programming track numbers", "Erasing a track from the program" and "Clearing the program").

Basic information

The CD recorder deck offers you 3 main functions:

- **Recording** from the internal CD changer and tuner or from a selected external source
- **Finalizing** your CDR(W) discs and **unfinalizing** your CDRW discs
- **Erasing** a CDRW disc

The recording procedure is the same for CDR and CDRW discs. **Make sure the CDR(W) is absolutely free of scratches and dust particles.**

For recordings, the minimum track length is 4 seconds. You can record up to a maximum of 99 tracks on a disc. The minimum of recording time left on the disc is 7 seconds. Otherwise **Does not fit** is displayed and you cannot enter the record standby mode.

DO NOT FORGET TO FINALIZE!

Finalizing a CDR(W) disc is a simple procedure, necessary to:

- play a recorded CDR on a standard CD player or
- play a recorded CDRW on a CDRW compatible CD player and CD recorder.

Copyright protection

The **Serial Copy Management System (SCMS)** prevents the making of a digital copy from a digital copy. The system allows making a digital recording from the original, however in some countries this may require the authorization of copyright holders.

When you try to record a copy protected material from an external source, **Copy Protect** will be displayed. No further digital recording is possible then.

When you try to record a copy protected material from the internal CD changer no digital recording is possible, however the CD recorder will automatically switch to analogue recording.

Recording CD text

If the original CD has CD Text, this text will be recorded automatically, provided that the CD text is not copy protected. In that case, recording of CD text will not be possible and **Text Protect** will be displayed.

Direct Line Recording (DLR)

The CD recorder is equipped with the high-performance **Direct Line Recording** technique. It ensures a perfect recording of the source material, meaning a true "bit for bit" recording. DLR will always become active, when you make normal recordings in listen mode.

Auto Level Control (ALC)

Auto Level Control ensures that the tracks on the recorded disc have a similar volume level. At all times the already recorded tracks of the CDR(W) disc will be taken as reference for the volume level of the following recordings. ALC is active, when **ALC** is shown.

Auto level control becomes active, when:

- COMPILER CD is being used,
- a disc, a track or a track edit is being high speed recorded and the CDR(W) has recordings on it,
- a program (consisting from more than one disc) from the CD changer is being high speed recorded, or
- CD→CD is being used and the CDR(W) has recordings on it.

Auto level control will not become active, when:

- CD→CD is being used and the CDR(W) has no recordings on it,
- making recordings from the FM tuner,
- making recordings from an external source, or
- making normal recordings in listen mode.

REC LEVEL key

You can adjust the reference record level. This is also possible when ALC is active. This feature can be used for fading your recordings in or out.

1 Keep REC LEVEL on the set pressed to enable the rotary control to adjust the record level.

2 Turn the rotary control to the left to adjust the desired record level.

→ The actual record level (in dB) will be displayed.

- The record level is reset after the set has been switched to standby.

Recording modes

For internal recordings you can record from the internal CD changer or tuner. You can choose from the following recording modes:

- **High speed recording and automatic finalizing:**
Fast and easy! Record and finalize your CDR(W) in one quick step while the sound is muted. You can record the current CD or a program from the CD changer.
- **High speed recording:**
 Record your CDR(W) fast while the sound is muted. You can record an entire CD, a track, a program or a track edit from the CD changer.
- **Normal recording and listening:**
 Listen to the recording while you are making it. You can record an entire CD, a track, a program or a track edit from the CD changer.
- **Manual recording:**
 Start and stop your recording manually whilst listening to it. You can do either microphone recordings or radio recordings from the FM tuner.

High speed recording and automatic finalizing

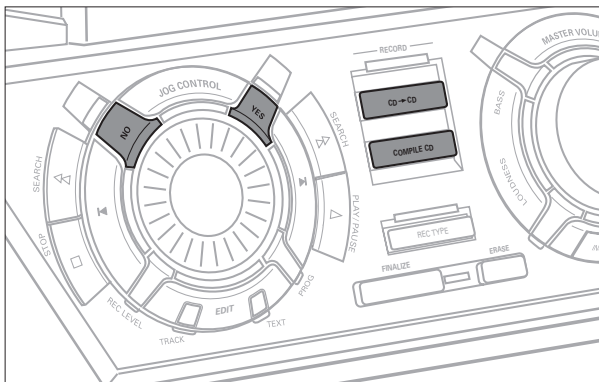

High speed recording and automatic finalizing of the current disc

- 1** Make sure the CDR(W) is absolutely free of scratches and dust particles.
- 2** Press CD→CD on the set to enter the recording mode.
 → Both decks will be selected in the display, the arrow starts blinking. The remaining recording time of the CDR(W), the total playing time of the source CD and Record CD1 (or 2, 3)? are displayed.
- 3** Press YES to start recording and finalizing.
 → The arrow lights, **RECORDING IN PROGRESS** is shown, high speed recording and finalizing start and the actual recording time left starts to count down.

Note: If a program was already available before pressing CD→CD, this will be ignored. PROG goes off and the current disc will be recorded. After finishing the recording, PROG is shown and the program is available again.

High speed recording and automatic finalizing (optional) of the current program

- 1** Make sure the CDR(W) is absolutely free of scratches and dust particles.
- 2** Press COMPILE CD on the set to enter the record mode.
 → Both decks will be selected in the display, the arrow starts blinking. The remaining recording time of the CDR(W), the total playing time of the source CD and Record Prog? are displayed.
- 3** Press either:
 YES to confirm,
 or
 NO to change the program.
 → **PROG** starts blinking. Now you can change the program (see "Program") and return to the record mode by pressing COMPILE CD.
- 4** Auto Fin? is displayed.
 Press either:
 YES, if the CDR(W) is to be finalized after recording,
 or
 NO, if the CDR(W) is not to be finalized after recording.
 → The arrow lights, **RECORDING IN PROGRESS** is shown, high speed recording and finalizing (if selected) start and the actual recording time left starts to count down.

Note: If no program is available and you press COMPILE CD, you enter immediately into the program menu. Start your programming and return to the record mode by pressing PROGRAM or COMPILE CD.

DO NOT FORGET TO FINALIZE!

Finalizing a CDR(W) disc is a simple procedure, necessary to:

- play a recorded CDR on a standard CD player or
- play a recorded CDRW on a CDRW compatible CD player and CD recorder.

INTERNAL RECORDING

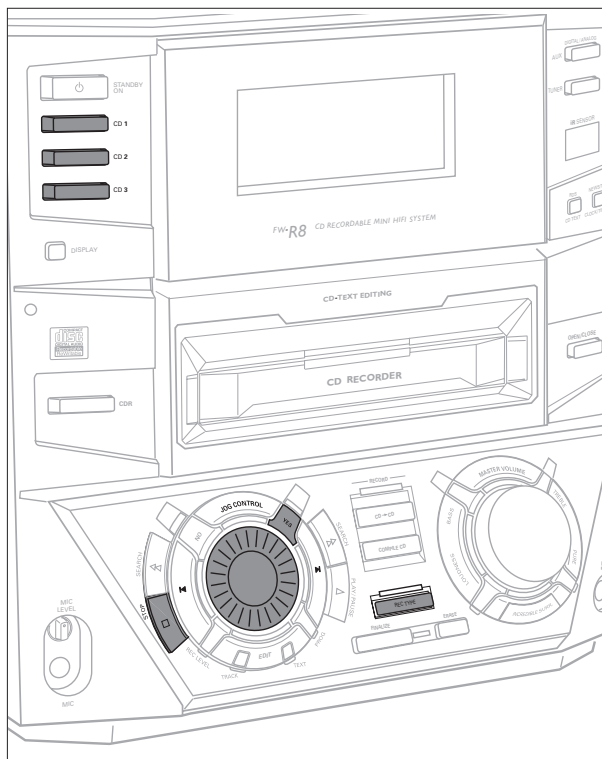

High speed recording

High speed recording of an entire disc, a track, a program or a track edit

- 1 Make sure the CDR(W) is absolutely free of scratches and dust particles.
- 2 Press either CD 1, CD 2 or CD 3 to select the disc you wish to record from.
- 3 Press REC TYPE on the set to enter into the recording menu.

- 4 Rotate **◀ JOG CONTROL ▶** to select one of the following high speed recording modes:

If a disc from the CD changer is selected:

- **CD Fast?**: for high speed recording of an entire disc
 - Continue with step 5.
- **Track Fast?**: for high speed recording of a track
 - Press YES to confirm.
 - Rotate **◀ JOG CONTROL ▶** to select the track.
 - **Rec Tr** and the track number is displayed.
 - Continue with step 6.

If CD changer program mode is available:

- **Prog Fast?**: for high speed recording of the selected disc or of the program

If CD changer track edit mode is available:

- **A-B Fast?**: for high speed recording of the A-B track

- 5 Press YES to confirm your selection.

- Both decks will be selected in the display, the arrow starts blinking. The remaining recording time of the CDR(W), the total recording time of the CDR(W) and either **Record CD1 (or 2, 3)?**, **Record Prog?** or **Record A-B?** is displayed.

*Note: When the CDR(W) already contains a recording, ALC will also become active and **ALC** will be shown.*

- 6 Press YES to start high speed recording.

- The arrow lights, **RECORDING IN PROGRESS** is shown, high speed recording starts and the actual recording time left starts to count down.

- To stop recording press **■ STOP** on the set.

Normal recording and listening

Normal recording and listening of an entire disc, a track, a program or a track edit

- 1 Make sure the CDR(W) is absolutely free of scratches and dust particles.

- 2 Follow steps 2 and 3 of "High speed recording".

- 3 Rotate **◀ JOG CONTROL ▶** to select one of the following normal record options:

If CD changer is selected:

- **CD Listen?**: for listening to the entire disc during normal recording
- **Track Listen?**: for listening to the track during normal recording
 - Press YES to confirm.
 - Rotate **◀ JOG CONTROL ▶** to select the desired track.
 - **Rec Tr** and the track number is displayed.
 - Continue with step 6 of "High speed recording".

If CD changer program mode is available:

- **Prog Listen?**: for listening to the program during normal recording

If CD changer track edit mode is available:

- **A-B Listen?**: for listening to the A-B track during normal recording

- 4 Follow steps 5 and 6 of "High speed recording".

- To stop recording press **■ STOP** on the set.

DO NOT FORGET TO FINALIZE!

Finalizing a CDR(W) disc is a simple procedure, necessary to:

- play a recorded CDR on a standard CD player or
- play a recorded CDRW on a CDRW compatible CD player and CD recorder.

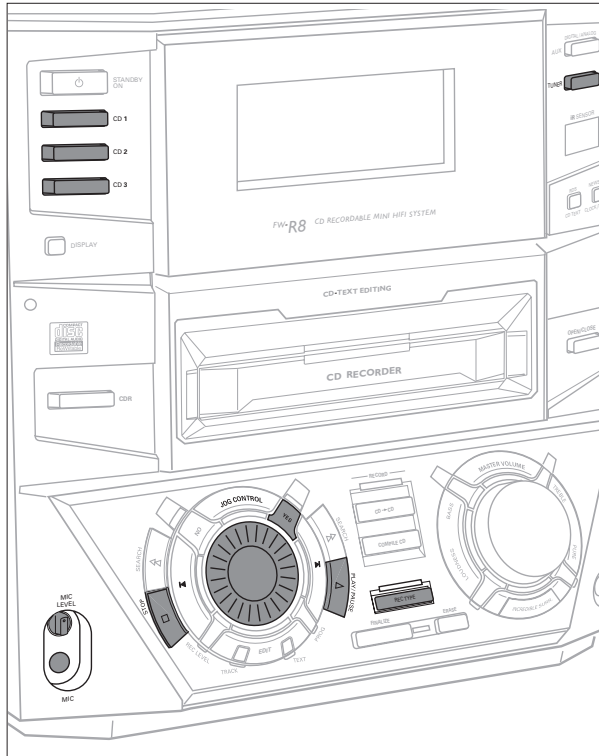

Manual recording

Manual recording from the FM tuner

- 1 Make sure the CDR(W) is absolutely free of scratches and dust particles.
- 2 Press TUNER repeatedly to select the FM tuner. Then select the desired radio station (see "Tuning to radio stations").
- 3 Press REC TYPE on the set to enter the recording menu.
→FM Tuner? is displayed.
- 4 Press YES to confirm.
→Wait and Record? are displayed.
- 5 Press YES to start recording.
→The arrow lights, **RECORDING IN PROGRESS** is shown, manual recording starts and the actual recording time left starts to count down.
- 6 Press ■ STOP to stop recording.

Manual microphone recording

- 1 Make sure the CDR(W) is absolutely free of scratches and dust particles.
- 2 Set MIC LEVEL to the minimum level to prevent acoustic feedback (e.g. a loud howling sound) before you connect the microphone.
- 3 Connect a microphone to MIC.

- 4 Press CD 1, CD 2 or CD 3 to select the disc you wish to mix the microphone with.
- 5 Press REC TYPE on the set to enter the recording menu.
- 6 Rotate ◀ JOG CONTROL ▶ to select the manual recording mode for the microphone:
→CD Mix Mic is displayed.
- 7 Press YES to confirm.
→Wait and Record? are displayed.
- 8 Press YES to start recording.
- 9 Rotate ◀ JOG CONTROL ▶ to select the desired track.
→The disc tray number, the current track number and playing time of the track are displayed.
- 10 Press ▶ PLAY/PAUSE to start playback.
→The selected source is mixed to the microphone.
- 11 Press ■ STOP to stop recording.

- To perform microphone recording only see "Manual recording" in chapter "External recording".

DO NOT FORGET TO FINALIZE!

Finalizing a CDR(W) disc is a simple procedure, necessary to:

- play a recorded CDR on a standard CD player or
- play a recorded CDRW on a CDRW compatible CD player and CD recorder.

EXTERNAL RECORDING

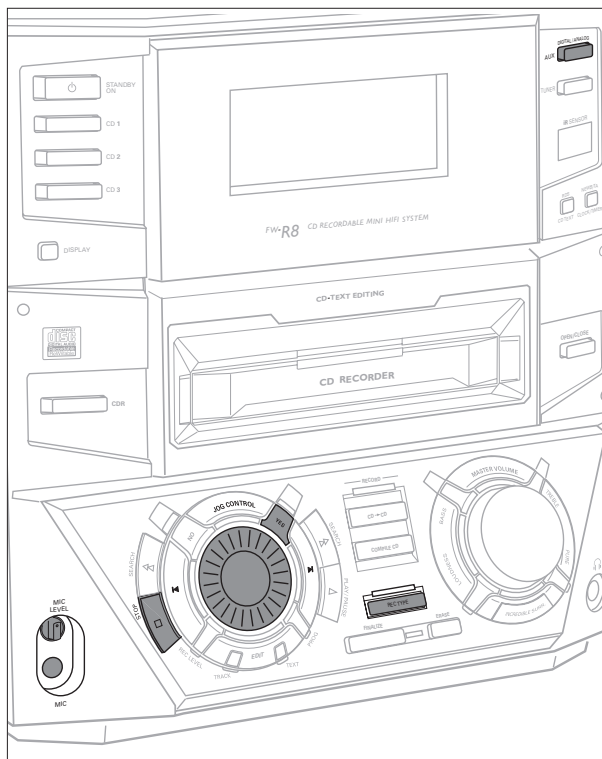

Analogue or digital recording?

When making recordings from an external source, we recommend to do analogue recording only if digital recording is not possible. Digital recording will usually result in better sound quality.

Recording with automatic start

Recording of an entire disc or a track with automatic start

- 1 Make sure the CDR(W) is absolutely free of scratches and dust particles.
- 2 Press repeatedly DIGITAL / ANALOG AUX to select the input for the external source you want to record from.
 - AUX Digital is displayed if the digital input is selected.
 - AUX Analog is displayed if the analogue input is selected.
- 3 Press REC TYPE on the set to enter the recording menu.
- 4 Rotate ◀ JOG CONTROL ▶ to select either:
 - AUX CD?: for recording with synchronised start of an entire disc
 - AUX Track?: for recording with synchronised start of a track
- 5 Press YES to confirm your selection.
 - Start Source, AUX and the remaining recording time of the CDR(W) are displayed.

- 6 Start playback on the selected source.
 - The CD recorder starts to record simultaneously and **RECORDING IN PROGRESS** is shown. The remaining recording time on the CDR(W) is displayed.

Note: If you start playback on the selected source within a track, recording starts at the beginning of the next track or after 2.7 seconds of silence in analogue recordings.

7 If a digital source is selected:

After the recording process, the CD recorder stops automatically.

Note: Recordings from DAT or DCC will automatically stop after 20 seconds silence.

If an analogue source is selected:

At the end of the recording process, the CD recorder stops after a silence of 20 seconds on the source material.

- To stop recording manually, press ■ STOP on the set.
 - RECORDING IN PROGRESS** goes off.

DO NOT FORGET TO FINALIZE!

Finalizing a CDR(W) disc is a simple procedure, necessary to:

- play a recorded CDR on a standard CD player or
- play a recorded CDRW on a CDRW compatible CD player and CD recorder.

Manual recording**Manual recording from an external source**

- 1 Make sure the CDR(W) is absolutely free of scratches and dust particles.
- 2 Press repeatedly DIGITAL / ANALOG AUX to select the input for the external source you want to record from.
 - AUX Digital is displayed if the digital input is selected.
 - AUX Analog is displayed if the analogue input is selected.
- 3 Press REC TYPE on the set to enter the recording menu.
- 4 Rotate ◀ JOG CONTROL ▶ to select the type of recording.
 - AUX Manual?: for manual start of recording
- 5 Press YES to confirm your selection.
 - Wait is displayed.
 - Record?, AUX and the remaining recording time of the CDR(W) are displayed.
- 6 Start playback on the external source in order to set the optimal recording level on the CD recorder (see "REC LEVEL key").
- 7 Stop playback on the external source.
- 8 Go to the beginning of the desired track.
- 9 Press YES on the set and simultaneously start playback on the external source.
 - The CD recorder starts to record and **RECORDING IN PROGRESS** is shown. The remaining recording time of the CDR(W) is displayed.

Note: If Check Input is flashing, check the digital connection.

- 10 Press ■ STOP on the set to stop recording.
 - Update is displayed and **RECORDING IN PROGRESS** goes off.

Manual microphone recording

- 1 Make sure the CDR(W) is absolutely free of scratches and dust particles.
- 2 Set MIC LEVEL to the minimum level to prevent acoustic feedback (e.g. a loud howling sound) before you connect the microphone.
- 3 Connect a microphone to MIC.

- 4 Press repeatedly DIGITAL / ANALOG AUX to select the input for the external source you wish to mix the microphone with.
 - AUX Digital is displayed if the digital input is selected.
 - AUX Analog is displayed if the analogue input is selected.
- 5 Press REC TYPE on the set to enter the recording menu.
- 6 Rotate ◀ JOG CONTROL ▶ to select the type of recording:
 - AUX Mix Mic: the microphone is mixed to the external source.
 - AUX Mic Only: only the microphone is recorded.
- 7 Press YES to confirm your selection.
 - Wait is displayed.
 - Record?, AUX and the remaining recording time of the CDR(W) are displayed.
- 8 Set the optimal recording level on the CD recorder (see "REC LEVEL key").
 - In addition you can also set the optimal recording level of the microphone by turning MIC LEVEL.
- 9 **If AUX Mix Mic is selected:**
Press YES on the set and simultaneously start playback on the external source.
 - The CD recorder starts to record and **RECORDING IN PROGRESS** is shown. The remaining recording time of the CDR(W) is displayed.

If Mic Only is selected:
Press YES on the set to start recording.

 - The CD recorder starts to record and **RECORDING IN PROGRESS** is shown. The remaining recording time of the CDR(W) is displayed.
- 10 Press ■ STOP on the set to stop recording.
 - Update is displayed and **RECORDING IN PROGRESS** goes off.

DO NOT FORGET TO FINALIZE!

Finalizing a CDR(W) disc is a simple procedure, necessary to:

- play a recorded CDR on a standard CD player or
- play a recorded CDRW on a CDRW compatible CD player and CD recorder.

Automatic track increment

In recording mode tracks will be incremented automatically such that the track numbers are positioned on the same position as the original.

- To **switch** the automatic track increment function **on**, press as often as necessary TRACK INCR. on the remote control during stop when CDR is selected.
 - Auto Tr ON is displayed and the function is switched on. Track increments are now automatically detected from digital source material. In analogue source material a silence of 2.7 seconds or more is detected as a track increment.
- To **switch** the automatic track increment function **off**, press as often as necessary TRACK INCR. on the remote control during stop when CDR is selected.
 - Auto Tr OFF is displayed and the function is switched off. Track numbers can now be incremented manually by pressing TRACK INCR. on the remote control during recording. The minimum track length is 4 seconds.

Notes: – Track numbers cannot be changed after recording.
 – The automatic track increment only works with consumer sources with a digital output signal according to the IEC 958 (consumer part) audio standard. DAT, DVD and DCC do not deliver this signal.

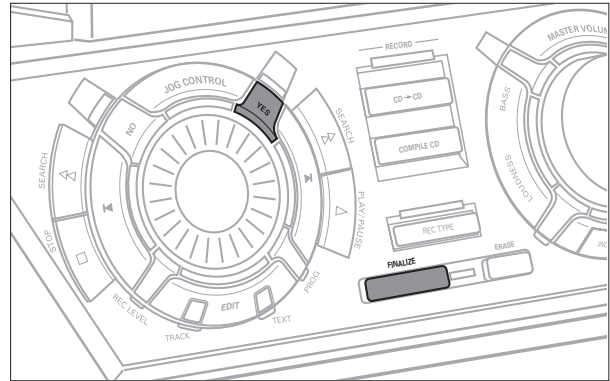
**Finalizing CDR(W) discs**

Finalizing a CDR(W) disc is a simple procedure, necessary to:

- play a recorded CDR on a standard CD player,
- play a recorded CDRW on a CDRW compatible CD player and CD recorder,
- avoid further unwanted recordings on a disc, or
- avoid erasure of tracks on a CDRW.

Notes: – Finalizing will take about 2–4 minutes.
 – After finalization of the CDR(W), **CDR(W)** changes to **CD** on the display.
 – During finalization no other operating commands can be executed.

Auto finalizing

When using either CD→CD or COMPILE CD, your recordings will be finalized automatically (see "High speed recording and automatic finalizing").

Manual finalizing when recording is in progress

- 1 Press FINALIZE on the set during recording.
 - Auto Final? is displayed.
- 2 Press YES to confirm.
 - FINALIZE is shown. The finalization will start after recording and the actual finalizing time remaining will start to count down.

Manual finalizing when recording is stopped

- 1 Insert the CDR(W) you want to finalize in the CD recorder tray.
- 2 Press CDR to select the CD recorder.
- 3 Press FINALIZE on the set.
 - Finalize? is displayed.
- 4 Press YES to start finalizing.
 - FINALIZE is shown, Final is displayed and the actual finalizing time remaining starts to count down.

Unfinalizing CDRW discs

If you want to record (or erase) on (from) a finalized CDRW, you have to unfinalize it first.

Notes: – Unfinalizing will take approximately 2 minutes.
– After unfinalizing of the CDRW, **CD** changes to **CDRW** on the display.
– When unfinalizing a CDRW with CD text on it available, this text will be transferred to the CD recorder memory. In case the memory is full, you have to erase text (see "Erasing from the memory") or to finalize another disc first in order to obtain memory space.

- 1 Insert the CDRW you want to unfinalize in the CD recorder tray.
- 2 Press CDR to select the CD recorder.
- 3 Press FINALIZE on the set.
→Unfinalize? is displayed.
- 4 Press YES to start unfinalizing.
→Unfinal is displayed and the operation time remaining starts to count down.

Erasing from a CDRW disc

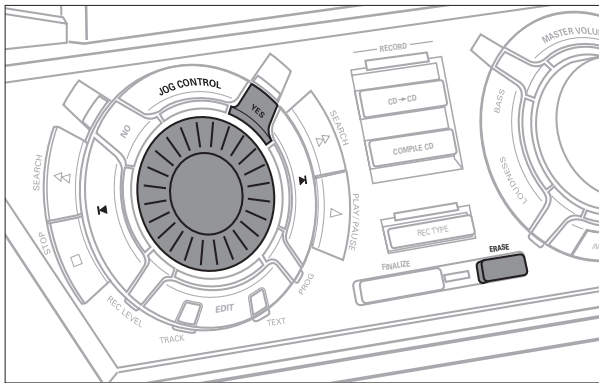

It is possible to erase one or more tracks (starting from the end of the last track) or the entire CDRW.

Erasing an entire CDRW

- 1 Insert the CDRW you want to erase in the CD recorder tray.
- 2 Press CDR to select the CD recorder.
- 3 Press ERASE to enter the erasing menu.
- 4 Rotate ◀ JOG CONTROL ▶ to select:
→Erase Disc?: for erasing the entire disc

- 5 Press YES to confirm your selection.
→Erase?, the total playing time and the total number of tracks to be erased are displayed. All track numbers will blink in the music calendar.
- 6 Press YES to start erasing.
→Erase is displayed and the operation time left starts to count down. The track number of the actual erased track will go off in the music calendar.

Erasing one or more tracks

- 1 Insert the CDRW you want to erase from in the CD recorder tray.
- 2 Press CDR to select the CD recorder.
- 3 Press ERASE to enter the erasing menu.
- 4 Rotate ◀ JOG CONTROL ▶ to select the track number(s) you wish to erase.
→Erase and the track number (e.g. 10+) are displayed.
 - To select more tracks to be erased repeat step 4.

Note: When erasing more tracks, the tracks to be erased must be selected in sequence, starting from the last recorded track. Example: The CDRW has 5 tracks recorded on it. Now, you can erase tracks 5 and 4. You can also erase tracks 5, 4 and 3, but you cannot erase tracks 5 and 3!

- All track numbers selected for erasing will blink in the music calendar. The remaining track numbers light up.
- 5 Press YES to confirm your selection.
→Erase? is displayed.
- 6 Press YES to start erasing.
→Erase is displayed and the operation time left starts to count down. The track number of the currently erased track will go off in the music calendar.

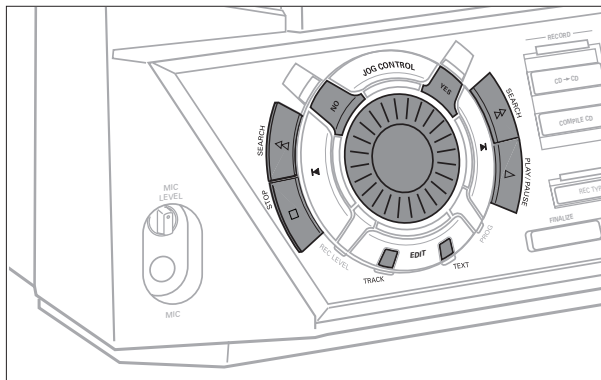

EDIT TEXT (on CD recorder only)

Storing text during stop mode

After you have recorded your CDR(W) you can enter a text e.g. names to discs and tracks. The text will be displayed during playback. You can enter up to 60 characters per text field. Only use an unfinalized CDR or CDRW (finalized CDRW must be unfinalized first).

- 1 If necessary press ■ STOP on the set (■ on the remote control) to stop playback.
- 2 Press CDR to select the CD recorder.
- 3 Press EDIT TEXT on the set to enter the text edit menu.
→ CD TEXT EDIT is blinking, Text Edit is displayed.
- 4 Press YES to confirm.
- 5 Rotate ◀ JOG CONTROL ▶ to select either:
→ Album Artist: for editing the CD artist.
→ Album Title: for editing the CD title.
→ Artist Tr 1 or (2, 3,...): for editing the artist of track 1 or (2, 3,...).
→ Title Tr 1 or (2, 3,...): for editing the title of track 1 or (2, 3,...).
- 6 Press YES to confirm the selection.
- 7 Rotate ◀ JOG CONTROL ▶ (press the alphabet keys on the remote control) to select a character.
- 8 Press YES to confirm the selection.
→ The cursor moves to the next character space.
- 9 Repeat steps 7 and 8 for adding further characters.
- 10 Press EDIT TEXT to save the characters that have been selected and to exit to the last position in the text editing menu.
→ Update is displayed.

Storing text during recording

You can store and edit text even while recording a single track or single CD, or when recording from an external source or tuner. Editing text during finalizing is not possible. Make sure, when using high speed recording and automatic finalizing, to enter the text before finalizing starts, otherwise automatic finalizing will be cancelled.

- Follow steps 3–10 of “Storing text during stop mode”.

Note: Editing text is not possible when a copy protected track is analogue recorded. Editing is stopped, CDText Saved is displayed and your text is saved for later editing.

Auto copied text

When an artist's name has been stored for a track, it will be copied automatically into the next track.

- Press either:
EDIT TEXT to confirm the copied text,
or
NO to delete the copied text and to enter a new one.

Inserting a space

- 1 Press ◀◀ SEARCH or ▶▶ SEARCH (◀◀ or ▶▶ on the remote control) to move to the position where the space is to be inserted.
→ The position starts blinking.
- 2 Press YES to confirm the position of the insert character.
→ A space will be inserted, text will move to the right.

Deleting and substituting a character

- 1 Press ◀◀ SEARCH or ▶▶ SEARCH (◀◀ or ▶▶ on the remote control) to move to the character's position to be deleted or substituted.
→ The character starts blinking.
- 2 **If you want to delete the character:**
Press NO.
→ The character is deleted and the text is shifted one position to the left.

If you want to substitute the character:

Rotate ◀ JOG CONTROL ▶ (press the alphabet keys on the remote control) to select a new character.

Press YES to confirm the selection.

- To change another character press ◀◀ SEARCH or ▶▶ SEARCH (◀◀ or ▶▶ on the remote control).

Erasing text

- 1 Press EDIT TEXT to enter the text edit menu.
→ **CD TEXT EDIT** is blinking, `Text Edit` is displayed.
- 2 Rotate ◀ JOG CONTROL ▶ to select the text erase menu.
→ `Text Erase` is displayed.
- 3 Press YES to confirm.
- 4 Rotate ◀ JOG CONTROL ▶ to select one of the following:
 - `All Text`: All text of the selected disc is chosen to be erased in one step.
 - `Album Artist`: CD artist's name is chosen to be erased.
 - `Album Title`: CD title is chosen to be erased.
 - `Artist Tr 1` or (2, 3,...): artist's name of track 1 or (2, 3,...) is chosen to be erased.
 - `Title Tr 1` or (2, 3,...): title of track 1 or (2, 3,...) is chosen to be erased.
- 5 Press YES to confirm your selection.
→ `Erase?` or `Erase All?` is displayed.
- 6 Press YES to start erasing.
→ `Update` is displayed and the chosen text is erased.

Erasing from the memory

When the text memory of your CD recorder is full, the messages `Memory Full` and `Finalize Disc` will be displayed. If you still want to add a new disc to the text memory, you have either to erase another disc from the memory or you have to finalize another disc.

- 1 Press EDIT TEXT to enter the text edit menu.
→ **CD TEXT EDIT** is blinking, `Text Edit` is displayed.
- 2 Rotate ◀ JOG CONTROL ▶ to select the memory view menu.
→ `Text Memory` is displayed.
- 3 Press YES to confirm.
- 4 Rotate ◀ JOG CONTROL ▶ to select the disc you wish to erase from the text memory.
- 5 Press YES to confirm.
→ `Erase Memory` is displayed.
- 6 Press YES to confirm the text erasure of that particular disc.

Note: If there are no discs in the text memory stored `Memory Empty` will be displayed.

Track editing (on CD changer only)

You can create a "track" by marking a passage of music within one track on the current disc. This new "track" can be used for recording or playing. The minimum track length is 4 seconds.

- 1 Press EDIT TRACK on the set.
→ **EDIT TRACK** starts blinking, `Track` and the current track number `?` are displayed. The current track number also blinks in the music calendar.
- 2 Rotate ◀ JOG CONTROL ▶ until the desired track number is displayed.
- 3 Press YES to confirm the selected track.
→ The marker position `A` and the track time will be displayed. The first 4 seconds of the track will be played continuously.
- 4 Press ▶ PLAY/PAUSE on the set to play to the desired start position of your new "track". (The initial position of marker `A` is always the start of the chosen track.)
 - To fast forward to the desired start position press ◀◀ SEARCH or ▶▶ SEARCH on the set.
 - To fine tune the position press first ▶ PLAY/PAUSE on the set, then rotate ◀ JOG CONTROL ▶.
- 5 Press YES to confirm the position of marker `A`.
→ The marker position `B` and the new "track" time will be displayed. The first 4 seconds before marker position `B` **until marker position B** will be played continuously.
- 6 Press ▶ PLAY/PAUSE on the set to play to the stop position of your new "track" (the initial position of marker `B` is always the position of marker `A` plus 4 seconds).
- 7 Press YES to confirm the marked passage.
→ **EDIT TRACK** is shown, `A-B` and the track edit time are displayed.

Note: If you open the CD changer tray the edit is deleted.

Clearing the track edit

- 1 Press NO during stop.
→ `Clear A-B?` is displayed.
- 2 Press YES to clear the markers.
→ The markers `A-B` are cleared.

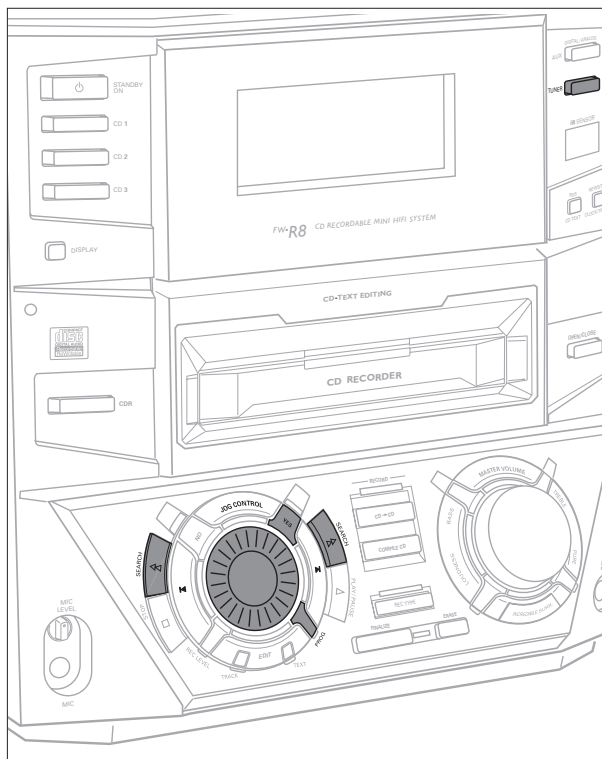

Tuning to radio stations

- 1 Press TUNER to select the tuner.
→ Tuner is scrolled.
- 2 Press TUNER again to select the desired waveband.
→ The selected waveband is displayed.
- 3 Keep ◀◀ SEARCH or ▶▶ SEARCH (◀◀ or ▶▶ on the remote control) pressed for more than a half second.
→ The selected waveband and Searching are displayed.
The radio tunes to a station with sufficient signal strength.
- 4 Repeat searching until you find the desired station.
 - To tune to a weak station briefly press ◀◀ SEARCH or ▶▶ SEARCH (◀◀ or ▶▶ on the remote control) as often as necessary for optimum reception.

Storing radio stations

It is possible to store up to 40 radio stations. Stations can be selected and programmed automatically or you can do that yourself. Programming will overwrite your former presets starting from the last active preset station. After programming the last preset stored will be tuned.

Automatic programming

If no preset is tuned, automatic programming starts at preset number one.

- 1 Follow steps 1 and 2 of "Tuning to radio stations".

- 2 Keep PROG (PROGRAM on the remote control) pressed for more than 2 seconds.
 - Autoprogram is displayed, **PROG** and the current preset number in the music calendar start blinking.
 - All available radio stations for the selected waveband are stored automatically. **PROG** goes off, the preset number, the waveband and the frequency of the last preset station are displayed briefly.

- To store radio stations for another waveband, repeat steps 1–2. Make sure to select the next available preset number first before proceeding, otherwise already programmed radio stations may be erased.
- To exit the automatic programming, press PROG (PROGRAM on the remote control).

Notes: – If there are RDS stations available, they will be programmed first.
– Strong stations will always automatically be first to be programmed followed by the weak stations.

Manual programming

- 1 Follow steps 1 and 2 of "Tuning to radio stations".
- 2 Keep PROG (PROGRAM on the remote control) pressed for less than 2 seconds.
→ **PROG** and the current preset number in the music calendar start flashing.
- 3 Press ◀◀ SEARCH or ▶▶ SEARCH (◀◀ or ▶▶ on the remote control) to tune to the desired radio station.
 - To allocate the radio station to another preset number rotate ◀◀ JOG CONTROL ▶▶ (press ◀◀ or ▶▶ on the remote control).
- 4 Press YES to confirm the setting.
→ **PROG** goes off, the preset number, the waveband and the frequency of the preset station are displayed.
- To exit the manual programming press PROG (PROGRAM on the remote control).

Tuning to preset stations

- Use ◀◀ JOG CONTROL ▶▶ (◀◀ or ▶▶ on the remote control) until the preset number of the desired station is displayed.

RDS

This feature **R**adio **D**ata **S**ystem is a service that allows FM stations to send additional information along with the regular FM radio signal. When you are receiving an RDS station, **RDS** and the station name are displayed.

Switching through different RDS information

- Press RDS on the set repeatedly to switch through the following information (if available):
 - **Station name**
 - **Radio text** messages
 - **RDS clock**
- Press DISPLAY on the set to view the frequency of an RDS station.

NEWS/TA – News and traffic announcement

With this function activated, listening to a CD(RW) or an external source will be interrupted temporarily by the news or traffic announcement of an RDS station.

- 1 Tune to the desired RDS station.
- 2 Play your CD(RW) or your external source.
- 3 Press NEWS/TA on the set repeatedly to select one of the following:
 - **TA** is shown and listening will be only interrupted when the station is broadcasting traffic announcements.
 - **NEWS** is shown and listening will be only interrupted when the station is broadcasting news.
 - **NEWS** and **TA** is shown and listening will be interrupted when the station is broadcasting either news or traffic announcements.
 - **NEWS** and **TA** disappear and the function is deactivated.

Note: In order to avoid unwanted recordings, this function does not work whilst recording a CD(RW) or whilst in menus.

EON

The feature **E**nanced **O**ther **N**etworks contains information on the RDS content of certain other RDS radio stations. When EON is active, **EON** is shown. Then listening to a CD(RW) will not only be interrupted temporarily by the news or traffic announcement of the selected station, but of other RDS stations as well.

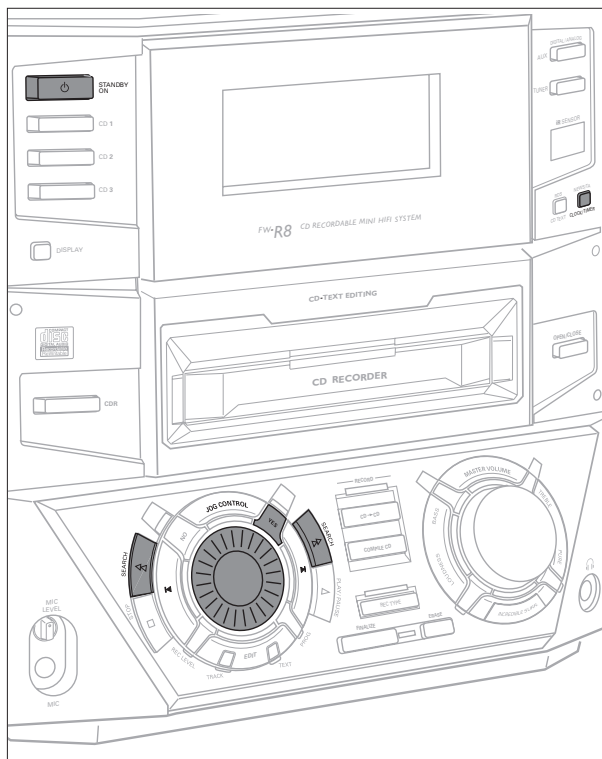

- 4 Press YES to confirm the selection.
→ The day of the week digit blinks.
- 5 Rotate ◀ JOG CONTROL ▶ to set the day.
- 6 Use ◀◀ SEARCH or ▶▶ SEARCH on the set to move from day of the week to hour.
- 7 Rotate ◀ JOG CONTROL ▶ to set the hour.
- 8 Repeat steps 6 and 7 to set the minutes.
- 9 Press YES to confirm the settings.

Clock setting

It is possible to set the clock by using a time signal which is broadcast together with the RDS signal. This only works if the RDS station is sending this time signal.

Automatic clock setting

- 1 Tune to an RDS station (see "Tuner").
- 2 Press CLOCK/TIMER on the set for more than 3 seconds.
→ RDS Clock blinks for a maximum of 90 seconds.
Then the time is displayed.

If No RDS Clock is displayed, there is no time signal transmitted. In that case you have to tune to another RDS station or set the clock manually.

Note: The time signal broadcasted from certain RDS stations may not always be accurate. If you find there a discrepancy in clock time, set your clock manually and the time will then run accurately.

Manual clock setting

- 1 Press as often as necessary ⏻ STANDBY ON on the set to switch the set to standby.
- 2 Press CLOCK/TIMER on the set.
- 3 Rotate ◀ JOG CONTROL ▶ to select the clock.
→ Clock is displayed and ⌚ starts blinking.

You can select different timer functions which will be activated at a chosen time. Make sure the clock is set before using one of these features.

Alarm timer

Alarm timer setting

The set can be used as an alarm clock, whereby the tuner, CD recorder or CD changer starts playback automatically at a preset time.

- 1 Press as often as necessary \odot STANDBY ON on the set to switch the set to standby.
 - 2 Press CLOCK/TIMER on the set.
 - 3 Rotate \blacktriangleleft JOG CONTROL \blacktriangleright to select the alarm timer.
→ **Alarm** is displayed, **ALARM** is blinking.
 - 4 Press YES to confirm the selection.
→ The hour digit is blinking.
 - 5 Rotate \blacktriangleleft JOG CONTROL \blacktriangleright to set the hour.
 - 6 Use \blacktriangleleft SEARCH or \blacktriangleright SEARCH on the set to move from hour to minutes.
 - 7 Rotate \blacktriangleleft JOG CONTROL \blacktriangleright to set the minutes.
 - 8 Press YES to confirm the time settings.
 - 9 Rotate \blacktriangleleft JOG CONTROL \blacktriangleright to select the source you want to be woken up with.
 - 10 Press YES on the set to confirm the source selection.
- To stop the alarm press \odot STANDBY ON on the set.

Record timer

Record timer setting

The set can do recordings automatically from an external source or from a preset radio station at a preset time.

- 1 Follow steps 1 and 2 of "Alarm timer setting".
- 2 Rotate \blacktriangleleft JOG CONTROL \blacktriangleright to select the record timer.
→ **Rec Timer** is displayed, **REC** is shown and \odot starts blinking.
- 3 Press YES on the set to confirm the selection.
→ The hour digit for start of recording blinks.
- 4 Rotate \blacktriangleleft JOG CONTROL \blacktriangleright to set the hour of start of recording.

- 5 Use \blacktriangleleft SEARCH or \blacktriangleright SEARCH on the set to move from hour to minutes of start of recording.

- 6 Rotate \blacktriangleleft JOG CONTROL \blacktriangleright to set the minutes of start of recording.

- 7 Continue this procedure by using \blacktriangleleft SEARCH or \blacktriangleright SEARCH to move on to hour and minutes of end of recording and to the day of the week. After each move, always rotate \blacktriangleleft JOG CONTROL \blacktriangleright to do the settings.

- 8 Press YES to confirm the settings.

- 9 Rotate \blacktriangleleft JOG CONTROL \blacktriangleright to select the source you want to record from.

If you have chosen the tuner as source:

Rotate \blacktriangleleft JOG CONTROL \blacktriangleright again to select a preset radio station and confirm this selected station by pressing YES.

- 10 Press YES on the set to confirm the source selection.

- To stop the recording press \blacksquare STOP on the set.

Switching the alarm and record timer on/off

- Press TIMER ON/OFF on the remote control repeatedly to switch the alarm and/or record timer on or off:
 - **ALARM** is shown and **Alarm ON** is displayed when the alarm timer is switched on.
 - **REC** is shown and **REC Timer ON** is displayed when the record timer is switched on.
 - **ALARM** and **REC** are shown, **REC+Alarm ON** is displayed when the alarm and record timer are switched on.
 - **ALARM** and **REC** go off, **REC+AlarmOFF** is displayed when the alarm and record timer are switched off.

Sleep timer

You can set a certain period of time before the set switches off.

- 1 Press SLEEP on the remote control until the desired sleeper time is displayed.
→ **SLEEP** is shown and **Sleep 60 min, 45 min, 30 min, 15 min** is displayed or **Sleep OFF** is displayed.
 - 2 As soon as the desired time is displayed, do not press SLEEP again.
→ After the chosen time has elapsed, the set switches to standby.
- To deactivate the sleep timer press SLEEP on the remote control until **Sleep OFF** is displayed.

TECHNICAL DATA

Subject to modification without notice.

General

AC Power	220–240 V / 50 Hz
Power consumption	
Active	157 W
Standby	< 30 W
Economy power save mode	< 2 W
Dimensions, w × h × d	265 × 310 × 395 mm
Weight (without speakers)	11 kg

Amplifier

Output power	2 × 200 W MPO, 2 × 100 W RMS, 6 Ω, 1 kHz, THD 10%
Frequency response	20–20,000 Hz, ±3 dB
S/N ratio	≥ 80 dBA (IEC)
Input sensitivity	
AUX IN L/R	800 mV
MIC	1 mV
DIGITAL IN	500 mV _{pp} (75 Ω)/12–56 kHz
Output	
Impedance speakers	≥ 6 Ω
Impedance headphones	32 Ω–600 Ω
LINE OUT L/R	500 mV
DIGITAL OUT	500 mV _{pp} (75 Ω)/44.1 kHz
SUBWOOFER OUT	1 V

CD changer

Number of programmable tracks	40
Frequency range	20–20,000 Hz
S/N ratio	≥ 92 dBA
Cross talk	≤ -65 dB (1 kHz)
Total harmonic distortion	≤ -94 dB (1 kHz)

CD recorder

Number of programmable tracks	99
CD playback	
Frequency range	20–20,000 Hz
S/N ratio playback	≥ 92 dBA
Cross talk	≤ -65 dB (1 kHz)
Total harmonic distortion	≤ -84 dB (1 kHz)
Analogue recording, digital playback	
Frequency range	20–20,000 Hz
S/N ratio playback	≥ 86 dBA
Cross talk	≤ -65 dB (1 kHz)
Total harmonic distortion	≤ -81 dB (1 kHz)

Laser (CD recorder)

Type	Semiconductor laser GaAlAs
Wave length	775–795 nm (at 25° C)
Output power	2,5 mW (Read), 35 mW (Write)
Beam divergence	60 degree

Tuner

Wave range	
FM	87.5–108.0 MHz
MW	531–1,602 kHz
LW	153–279 kHz

Speakers

System	3 way bass reflex
Impedance	6 Ω
Woofer	1 × 6.5"
Tweeter	1 × 2.5", Ferro fluid cooled
Tweeter	1 × 1", Polydome
Dimensions, h × w × d	310 × 240 × 323 mm
Weight	4.6 kg/each

WARNING

Under no circumstances should you try to repair the set yourself as this will invalidate the guarantee. Do not open the set as there is a risk of electric shock.

If a fault occurs, first check the points listed, before taking the set for repair.

If you are unable to solve a problem by following these hints, consult your dealer or service centre.

LASER SAFETY

This unit employs a laser. Only a qualified service person should remove the cover or attempt to service this device, due to possible eye injury.

PROBLEM	POSSIBLE CAUSE	SOLUTION
No sound, no power	Volume is not correctly adjusted.	Adjust the volume.
	Headphones are connected.	Disconnect headphones.
	Speakers are wrongly or not connected.	Make sure speakers are properly connected.
	Mains cable is not securely connected.	Connect mains cable properly.
No reaction to controls	Electrostatic discharge	Disconnect the set from power supply, reconnect after a few seconds.
Poor radio reception	Weak radio signal	Direct the antenna for optimum reception.
	Antenna is positioned near a radiation source such as a TV, VCR, computer, etc.	Change the position of the interfering unit or try to switch it off.
Poor bass sound	Speakers are not in phase.	Connect the coloured (or marked) wires to the coloured terminals and the black (or unmarked) wires to the black terminals.
Bad sound	Badly matched setting for the given type of music or sound.	Correct the sound settings on the set.
Remote control does not function properly	Batteries are inserted incorrectly.	Insert batteries correctly.
	Batteries are flat.	Insert new batteries.
	Distance to the set is too large.	Reduce distance.
Insert Disc indication	The CD(RW) is scratched badly or dirty.	Replace or clean the disc.
	No CD(RW) inserted or inserted upside down.	Insert a CD(RW), label upwards.
	The laser lens is steamed up.	Wait until the lens has cleared.
Wrong Disc indication, Use Audio CD indication	No digital audio disc is inserted.	Insert a digital audio disc marked with "Digital Audio" and the special logo.
Disc Recover indication	Power loss	Wait a few minutes. The disc is being repaired.
Disc Error indication	Disc Recover was not able to repair the disc.	The disc can still be played, but not recorded or finalized further.
Check Input indication	Wrong input is chosen.	Select the correct input.
	No correct digital source is detected after starting recording.	Make sure the connection cable is properly connected.
Does not record	CDR(W) is scratched or dirty.	Make sure the CDR(W) is absolutely free of scratches and dust particles.
	The inserted disc is not recordable.	Insert a digital CDR(W) and make sure it is unfinalized.
	Recording process is interrupted (power loss, mechanical shock).	Start recording again.
Recorded disc does not play in another standard CD player	The inserted CDR(W) is not finalized.	Finalize the CDR(W).
	The CDRW is inserted in a non-CDRW compatible CD player.	Insert the CDRW in a CDRW compatible CD player.

English

Français

Español

Deutsch

Meet Philips at the Internet
<http://www.philips.com>

