



Dear customer

Thank you for purchasing this product.
For optimum performance and safety, please read these instructions carefully.
These operating instructions fundamentally explain the operation of RX-D19.

Supplied accessories

Please check and identify the supplied accessories.
Use numbers indicated in parentheses when asking for replacement parts.

AC mains lead 1pc.
For United Kingdom: (RJA0053-2X)
For Australia and New Zealand: (RJA0035-X)
For others: (RJA0019-2K)
Remote control transmitter **RX-D19 only** 1pc.
(EUR648258)

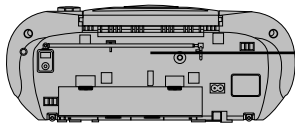

(Back of product)



LUOKAN 1 LASERLAITE
KLASS 1 LASER APPARAT

DANGER	INVISIBLE LASER RADIATION WHEN OPEN AND INTERLOCK DEFEATED. AVOID DIRECT EXPOSURE TO BEAM.
ADVARSEL	USYNLIG LASERSTRÅLING VED ÅBNING, NÅR SIKKERHEDSAFBRYDERE ER UDE AF FUNKTION. UNDGÅ UDSÆTTELSE FOR STRÅLING.
VARO!	AVATTAESSA JA SUJALUKITUS OHITETTAESSA OLET ALTTIINA NÄKYMÄTÖNÄ LASERSÄTEILYLLE. ÄLÄ KATSO SÄTEESEEN.
VARNING	OSYNLIG LASERSTRÅLNING NÅR DENNA DEL ÄR ÖPPNAD OCH SPÄRREN ÄR URKOPPLAD. BETRÄKTA EJ STRÅLEN.
ADVARSEL	USYNLIG LASERSTRÅLING NÅR DEKSEL ÅPNES OG SIKKERHEDSLÅS BRYTES. UNNGÅ EKSPONERING FOR STRÅLEN.
VORSICHT	UNSIHTBARE LASERSTRÄHLUNG, WENN ABDECKUNG GEOFFNET UND SICHERHEITSVERRIEGELUNG ÜBERBRÜCKT. NICHT DEM STRAHL AUSSETZEN.

Inside of the product
Tuotteen sisällä
Produktets innsida

Panasonic®

Portable Stereo CD System

Operating Instructions

Model No. **RX-D19**
RX-D17



The illustrations show RX-D19.

Note:
"EB" on the packaging indicates the United Kingdom.
Before connecting, operating or adjusting this product, please read these instructions completely.
Please keep this manual for future reference.

E EB GN



Power sources

Using a household AC outlet

FOR UNITED KINGDOM ONLY
READ THE CAUTION FOR THE AC MAINS LEAD ON PAGE 7 BEFORE CONNECTION.

Connect the AC mains lead firmly to the unit and the outlet.

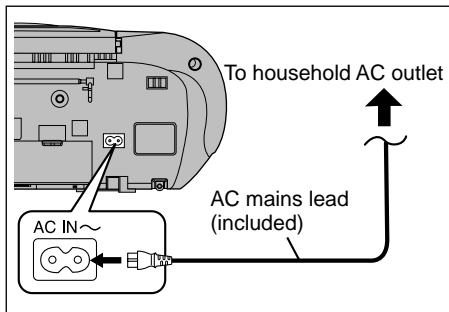

Note

- The included AC mains lead is for use with this unit only. Do not use it with other equipment.
- The function selector switch does not separate entire unit from mains even if in "TAPE/OFF" position.

Using batteries (not included)

The unit cannot be powered by batteries if the AC mains lead is connected.

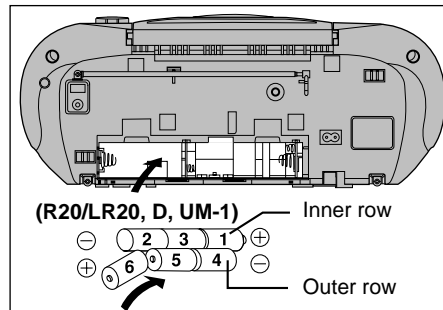

When to change the batteries

Sound quality and operations are affected when the batteries are running low. Replace all six batteries. It is also a good idea to replace all the batteries before recording.

Removing the batteries

Open the battery cover and insert your finger in the hole on the bottom of the unit and push out.

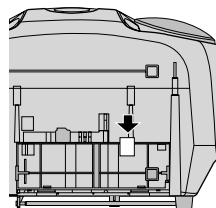

Memory back-up

During power supply interruption, memory back-up batteries (not included) save CD programs and radio stations you have set.

These batteries do not power the unit.

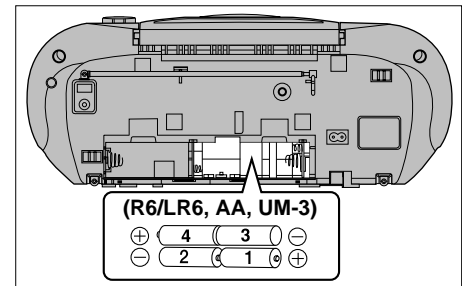

When to change the batteries

The batteries last about a year. Connect the unit to AC power before replacing the batteries.

- Before connecting or disconnecting the AC mains lead, stop the tape and switch [SELECTOR] to "TAPE/OFF" to turn the unit off. The memory batteries are worn out faster if the cord is disconnected with the power still on.

Removing the batteries

Press the negative end of the number 4 battery and remove the batteries. (Remove the power batteries first.)

RQT6341-B



Controls

Main unit:

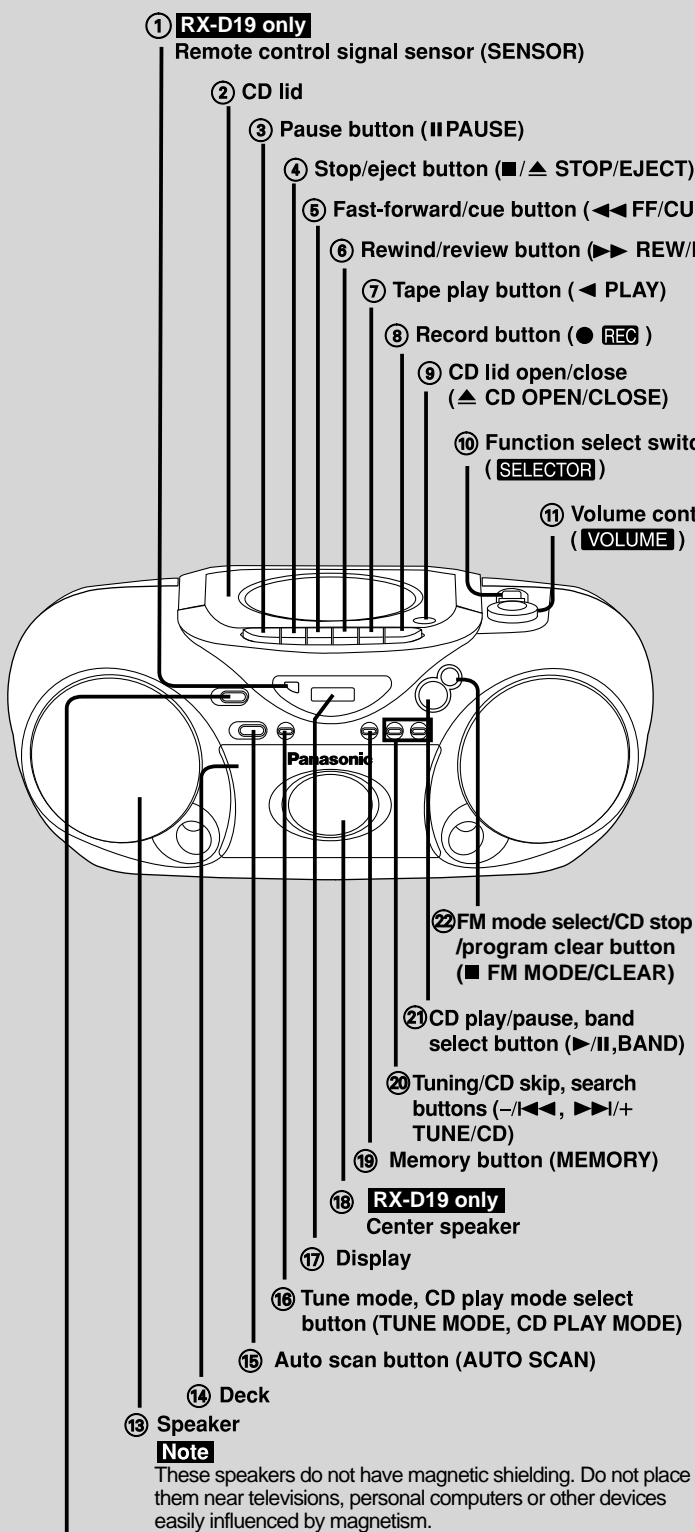

Remote control **RX-D19 only**:

The functions of the buttons without descriptions are the same as on the main unit.

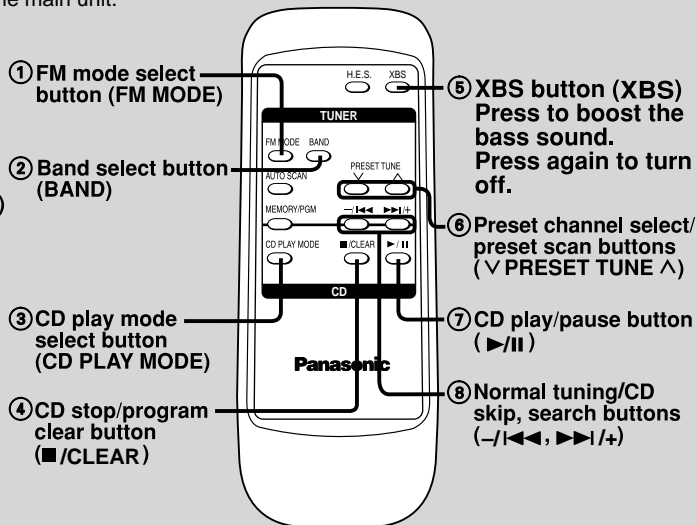

Concerning the remote control

RX-D19 only

Battery installation

Insert the batteries (not included) observing the correct polarities (⊕, ⊖).

R6, AA, UM-3

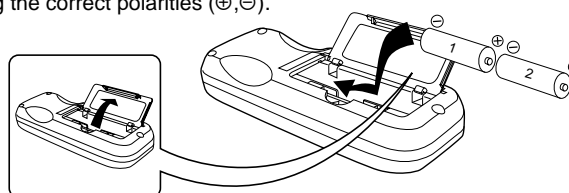

Correct method of use

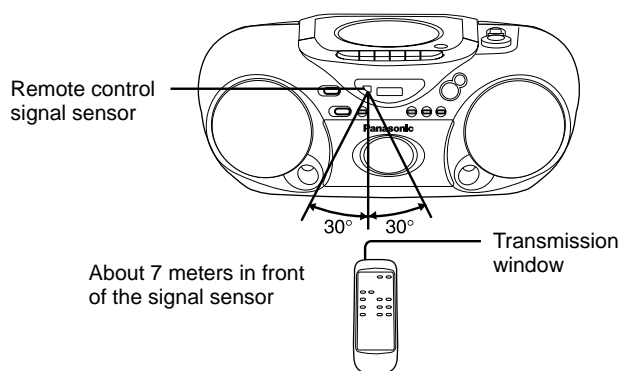

Operation notes

- Do not place obstacles between the remote control signal sensor and the remote control unit.
- Do not expose the remote control signal sensor to direct sunlight or to the bright light of fluorescent light.
- Take care to keep the remote control signal sensor and end of the remote control unit free from dust.

To prevent damage

- Never place heavy items on it.
- Do not disassemble or reconstruct it.
- Do not spill water or other liquids into it.



The Radio

Normal tuning

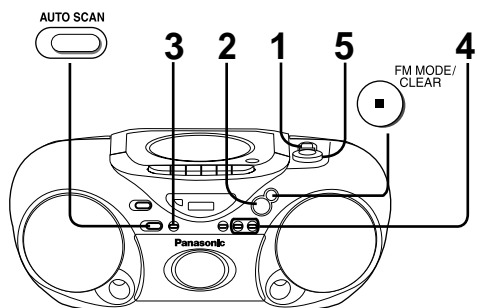

- 1 Switch [SELECTOR] to "TUNER".
(Unit comes on.)

- 2 Press [BAND] to select "FM" or "AM".

- 3 (Omit this step if using the remote control)
If "PGM" is on the display, press [TUNE MODE] to clear it off.

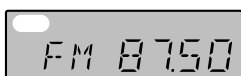

- 4 Press [-/◀◀] or [▶▶/+] to tune to the desired station.

The frequency changes one step each time a button is pressed.

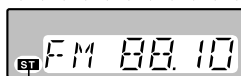

"ST" lights when an FM stereo broadcast is being received.

Automatic tuning

Keep [-/◀◀] or [▶▶/+] depressed and release when the frequency display starts to change. A station with good reception is automatically selected and the process stops.

To stop automatic tuning, press [-/◀◀] or [▶▶/+] again.

Note

Automatic tuning may stop on a frequency where there is no station if there is interference. Press [-/◀◀] and [▶▶/+] to tune if this occurs.

- 5 Adjust the volume.

To use auto scan

You can search for a station by listening to all tuned-in stations for 8 seconds each.

Preparation: Switch [SELECTOR] to "TUNER".

1. Press [BAND] to select "FM" or "AM".
2. Press [AUTO SCAN].
Auto scan starts.

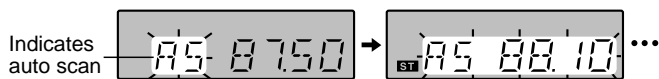

3. Press [AUTO SCAN] when you find the desired station.

Auto scan ends when it reaches the original frequency again.
To stop during the process, press [AUTO SCAN].

To improve reception

FM: Extend the whip antenna and adjust its direction.

AM: Adjust facing of the unit.

If noise is excessive in the FM stereo mode
Press [FM MODE]. ("MONO" lights up.)

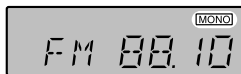

Sound will be produced in monaural, but this also reduces noise.
Press the button again to cancel. ("MONO" goes out.)

Preset tuning

Preset the stations (twelve FM and twelve AM) to make tuning simpler.

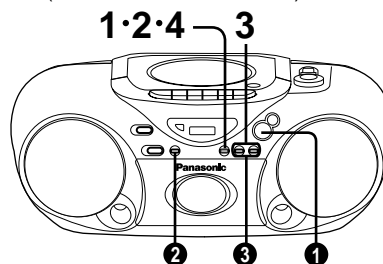

How to preset

Preparation: Tune to the desired station.
(Do steps 1-4 on the left.)

- 1 Press [MEMORY].

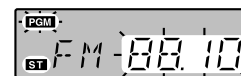

- 2 While "PGM" and the frequency are flashing
Press [MEMORY].

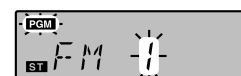

Preset channel

- 3 While "PGM" and the preset channel are flashing
Press [-/◀◀] or [▶▶/+] to select the desired channel.
(Remote control: [V] or [A])



- 4 Press [MEMORY].
(This completes presetting.)



Repeat the above to preset other stations.

Note

If "PGM" goes off during presetting, return to step 1.

To listen to preset channels

- 1 Press [BAND] to select "FM" or "AM".

- 2 (Omit this step if using the remote control)
Press [TUNE MODE] to display "PGM".



- 3 Press [-/◀◀] or [▶▶/+] to select the desired channel (1-12).
(Remote control: [V] or [A])



Preset channel

To use preset scan

You can search for a station by listening to all preset channels for 8 seconds each.

1. Do steps 1 to 2 above.

For remote control, replace [-/◀◀] or [▶▶/+] described below with [V] or [A].

2. Press and hold [-/◀◀] or [▶▶/+] until "PS" appears on the display.



3. Press [-/◀◀] or [▶▶/+] when you find the desired channel.

Preset scan ends after searching through each preset channel once.
To stop during the process, press [-/◀◀] or [▶▶/+] again.



CDs

Normal play

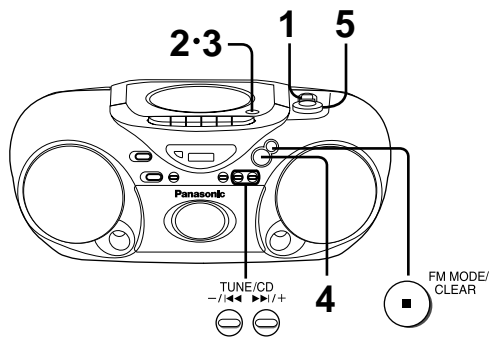

1 Switch [SELECTOR] to "CD".
(Unit comes on.)

2 Push [▲ CD OPEN/CLOSE] to open the CD lid and insert the CD.

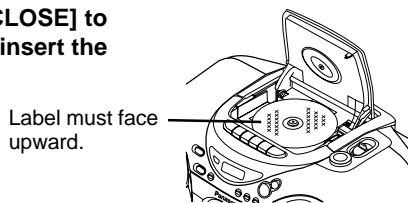

Label must face upward.

3 Push [▲ CD OPEN/CLOSE] to close the CD lid.

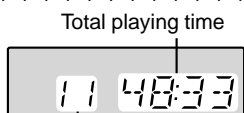

Total playing time

Total number of tracks

4 Press [▶/||] to start play.
Play starts from the first track and continues to the last track.



Elapsed play time

Track number in play

5 Adjust the volume.

To stop play
Press [■].

To pause	Press [▶/] during playback. To resume, press [▶/].
To search forward/backward	Hold down [←/⏮] (backward) or [→/⏭] (forward) during playback or when paused.
To skip forward/backward	Press [←/⏮] (backward) or [→/⏭] (forward) during playback or when paused.

"NO DISC" is displayed if there is no disc in the unit.

Note

- If interference occurs to radios or televisions, place the unit as far as possible from this equipment.
- Do not press [▲ CD OPEN/CLOSE] during play, pause or immediately after you inserted the CD and closed the CD lid. CD may be scratched.

This unit can play CD-DA (digital audio) format audio CD-R that has been finalized (a process that enables CD-R players to play audio CD-R) upon completion of recording. It may not be able to play some CD-R due to the condition of the recording. It cannot play CD-RW.

Program play

You can program up to 24 tracks.

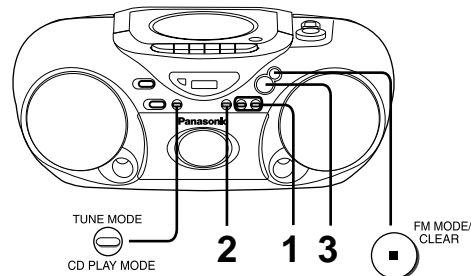

Ensure CD is stopped before programming.

1 Press [←/⏮] or [→/⏭] to select the desired track.

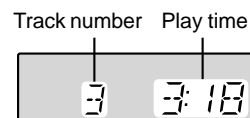

Track number Play time

2 Press [MEMORY].
The track is programmed.

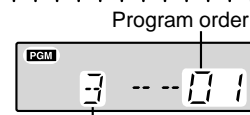

Program order

Specified track number

Repeat steps 1 and 2 until you have programmed all the tracks you want.

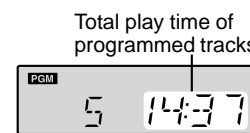

Total play time of programmed tracks

3 Press [▶/||].
Play starts in the programmed order.



To stop play

Press [■].

"P" is displayed indicating that the program is still active.

Press [■] again and "CLR" is displayed; the program is cleared, and the normal play mode is restored.

To check program contents

Press [←/⏮] or [→/⏭] when "P" is displayed.

Display

"— : — : —": Program equals, or exceeds, 100 minutes but programming and play are still possible.

"FULL": 24 tracks have already been programmed. The program is full.

CD play modes

You can repeat one track (1-🔁), all tracks (🔁) or play the tracks in random order (RANDOM).

Press [CD PLAY MODE] before or during playback to select the desired mode.



These modes remain active until cancelled. You can use repeat mode with program play.

Note

Random and program play cannot be done at the same time.



Cassettes

This unit is suitable for playing normal tapes, but high and metal position tapes will not be played to their full potential.

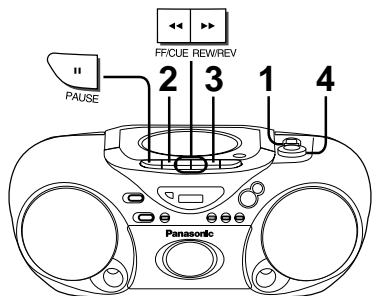

1 Switch [SELECTOR] to "TAPE/OFF".

2 Press [STOP/EJECT] to open the deck and load a cassette.
Close deck by hand.

Exposed tape facing upward

Side to be played facing you

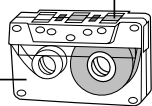

3 Press [PLAY] to start play.
Unit comes on and play starts.



4 Adjust the volume.

To stop play

Press [STOP/EJECT]. (Unit is switched off.)

To pause

Press [PAUSE] during playback.
To resume, press [PAUSE].

**To rewind/
fast-forward**

Press [REW/REV] (to rewind) or [FF/CUE] (to fast-forward) in the stop mode.

To find a particular spot

Press [REW/REV] (to search backward) or [FF/CUE] (to search forward) during playback.
Play is resumed when the button is released.

Note

- The unit is on in the pause mode. Stop tape to turn the unit off by pressing [STOP/EJECT] when leaving the unit.
- Do not press [PLAY] when rewinding or fast-forwarding, as this may jam the tape.
Be sure to press [STOP/EJECT] before the next operation.

Full auto-stop

The automatic stop system will release the buttons when the tape reaches the end during play, recording, fast forwarding or rewinding.

Recording

You can record radio broadcasts or CDs.

Before recording

- This unit is suitable for recording normal tapes, but it cannot record onto high and metal position tapes to their full potential and prior recordings will not be erased correctly.
- The recording level is set automatically.
- Take up the leader tape before proceeding.



Leader tape (Recording cannot be made.)

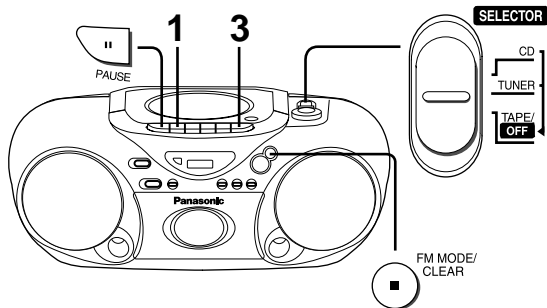

1 Press [STOP/EJECT] to open the deck and load a cassette.
Close deck by hand.

Exposed tape facing upward

Side to be recorded facing you

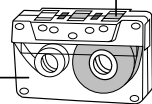

2 Select the source to be recorded.

When recording radio broadcasts

Tune in the station.
(Do steps 1-4 of "Normal tuning" on page 3.)

When recording CDs

Insert the CD to be recorded.
(Do steps 1-3 of "Normal play" on page 4.)

If you want to record programmed tracks, program desired tracks before proceeding to step 3.

3 Press [REC] to start recording.

[PLAY] is also depressed with [REC].
Recording starts (one side only).
The CD also starts playing if in CD mode.

To stop recording

Press [STOP/EJECT]. (The CD does not stop.)

To stop recording temporarily

Press [PAUSE]. (The CD does not stop.)
Press once again to resume recording.

To record on the other side of the cassette

Turn the cassette over and press [REC].

If the CD finishes before the cassette

Recording continues. Press [STOP/EJECT] to stop it.

If the cassette finishes before the CD

The CD continues playing. Press [STOP] to stop it.

Note

Noise may be recorded if this unit is near a TV. Keep the units at least 1.5 meters apart.

Erasure prevention

Use a screwdriver or similar object to break out the tab.

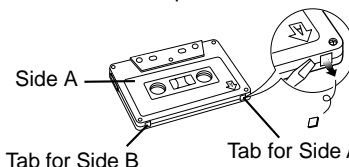

To re-record on a protected cassette

Cover the hole with adhesive tape.

To erase a tape

1. Set [SELECTOR] to "TAPE/OFF".

2. Insert the cassette with the side to be erased facing towards you and the exposed tape facing up.

3. Press [REC].

[PLAY] is depressed at the same time.

Reference

Changes to volume and sound quality do not affect recording.

To prevent interruptions to recording, supply AC power to the unit or replace the batteries.

Your attention is drawn to the fact that recording pre-recorded tapes or discs or other published or broadcast material may infringe copyright laws.



CAUTION!

THIS PRODUCT UTILIZES A LASER. USE OF CONTROLS OR ADJUSTMENTS OR PERFORMANCE OF PROCEDURES OTHER THAN THOSE SPECIFIED HEREIN MAY RESULT IN HAZARDOUS RADIATION EXPOSURE. DO NOT OPEN COVERS AND DO NOT REPAIR YOURSELF. REFER SERVICING TO QUALIFIED PERSONNEL.

CAUTION!

- DO NOT INSTALL, OR PLACE THIS UNIT, IN A BOOKCASE, BUILT-IN CABINET OR IN ANOTHER CONFINED SPACE. ENSURE THE UNIT IS WELL VENTILATED. TO PREVENT RISK OF ELECTRIC SHOCK OR FIRE HAZARD DUE TO OVERHEATING, ENSURE THAT CURTAINS AND ANY OTHER MATERIALS DO NOT OBSTRUCT THE VENTILATION VENTS.
- DO NOT OBSTRUCT THE UNIT'S VENTILATION OPENINGS WITH NEWSPAPERS, TABLECLOTHS, CURTAINS, AND SIMILAR ITEMS.
- DO NOT PLACE SOURCES OF NAKED FLAMES, SUCH AS LIGHTED CANDLES, ON THE UNIT.
- DISPOSE OF BATTERIES IN AN ENVIRONMENTALLY FRIENDLY MANNER.

WARNING:

TO REDUCE THE RISK OF FIRE, ELECTRIC SHOCK OR PRODUCT DAMAGE, DO NOT EXPOSE THIS APPARATUS TO RAIN, MOISTURE, DRIPPING OR SPLASHING AND THAT NO OBJECTS FILLED WITH LIQUIDS, SUCH AS VASES, SHALL BE PLACED ON THE APPARATUS.

THIS UNIT IS INTENDED FOR USE IN MODERATE CLIMATES.

SUOMI

VAROITUS!

LAITTEEN KÄYTTÄMINEN MUULLA KUIN TÄSSÄ KÄYTTÖOHJEESSA MAINITULLA TAVALLA SAATTAÄ ALTISTAA KÄYTTÄJÄN TURVALLISUUSLUOKAN 1 YLITTÄVÄLLE NÄKYMÄTTÖMÄLLE LASERSÄTEILYLLE.

VAROITUS!

- ÄLÄ ASENNATA TAI LAITETA TÄTÄ LAITETTA KABINETTITYYPPISEEN KIRJAKAAPPIIN TAI MUUHUN SULJETTUUN TILAAN, JOTTA TUULETUS ONNISTUISI. VARMISTA, ETTÄ VERHO TAI MIKÄÄN MUU MATERIAALI EI HUONONNA TUULETUSTA, JOTTA VÄLTETTÄISIIN YLIKUUMENEMISESTÄ JOHTUVA SÄHKÖISKU- TAI TULIPALOVAARA.
- ÄLÄ PEITÄ LAITTEEN TUULETUSAUKKOJA SANOMALEHDELLÄ, PÖYTÄLIINALLA, VERHOLLA TAI MUULLA VASTAAVALLA ESINEELLÄ.
- ÄLÄ ASETA PALAVAA KYNTTILÄÄ TAI MUUTA AVOTULEN LÄHDETTÄ LAITTEEN PÄÄLLE.
- HÄVITÄ PARISTOT LUONTOA VAHINGOITTAMATTOMALLA TAVALLA.

VAROITUS:

TULIPALO-, SÄHKÖISKUVAARAN TAI TUOTETTA KOHTAAVAN MUUN VAHINGON VÄHENTÄMISEKSI EI LAITETTA SAA ALTISTAA SATEELLE, KOSTEUDELLE, VESIPISAROILLE TAI ROISKEELLE, EIKÄ NESTETTÄ SISÄLTÄVIÄ ESINEITÄ, KUTEN ESIMERKIKSI MALJAKOITA, SAA ASETTAA LAITTEEN PÄÄLLE.

TÄMÄ LAITE ON TARKOITETTU KÄYTETTÄVÄKSI LEUDOSSA ILMASTOSSA.

NORSK

ADVARSEL!

DETTE PRODUKTET ANVENDER EN LASER. BETJENING AV KONTROLLER, JUSTERINGER ELLER ANDRE INNGREP ENN DE SOM ER BESKREVENT I DENNE BRUKSANVISNING, KAN FØRE TIL FARLIG BESTRÅLING. DEKSLER MÅ IKKE ÅPNES, OG FORSØK ALDRI Å REPARERE APPARATET PÅ EGENHÅND. ALT SERVICE OG REPARASJONSARBEID MÅ UTFØRES AV KVALIFISERT PERSONELL.

ADVARSEL!

- APPARATET MÅ IKKE PLOSSERES I EN BOKHYLLE, ET INNEBYGGET KABINETT ELLER ET ANNET LUKKET STED HVOR VENTILASJONSFORHOLDENE ER UTILSTREKKELEGE. SØRG FOR AT GARDINER ELLER LIGNENDE IKKE FORVERRER VENTILASJONSFORHOLDENE, SÅ RISIKO FOR ELEKTRISK SJOKK ELLER BRANN FORÅRSAKET AV OVERHETING UNNGÅS.
- APPARATETS VENTILASJONSÅPNINGER MÅ IKKE DEKKES TIL MED AVISER, BORDDUKER, GARDINER OG LIGNENDE.
- PLOSSER IKKE ÅPEN ILD, SLIK SOM LEVENDE LYS, OPPÅ APPARATET.
- BRUKTE BATTERIER MÅ KASSERES UTEN FARE FOR MILJØET.

ADVARSEL:

FOR Å REDUSERE FAREN FOR BRANN, ELEKTRISK STØT ELLER SKADER PÅ PRODUKTET, MÅ DETTE APPARATET IKKE UTSETTES FOR REGN, FUKTIGHET, VANNDRÅPER ELLER VANNSPRUT. DET MÅ HELLER IKKE PLOSSERES GJENSTANDER FYLT MED VANN, SLIK SOM BLOMSTERVASER, OPPÅ APPARATET.

DETTE APPARATET ER BEREGNET TIL BRUK UNDER MODERATE KLIMAFORHOLD.

Precautions

- Avoid using or placing this unit near sources of heat. Do not leave it in an automobile exposed to direct sunlight for a long time with the doors and windows closed as this may deform the cabinet.
- Avoid cuts, scratches, or poor connections in the AC mains lead, as they may result in possible fire or electric shock hazard. Also, excessive bending, pulling or splicing of the lead should be avoided.
- Do not unplug the AC mains lead by pulling on the lead. To do so may cause premature failure or shock hazard.
- Do not operate this unit on AC mains in a bathroom, as a potential shock hazard may result.
- When not in use, disconnect the AC mains lead from the household AC outlet.

Use of Batteries

- If this unit is not used for a long period of time or is used only from an AC power source, remove all the batteries to prevent potential damage due to possible battery leakage.
- Align the poles (+ and -) properly when inserting the batteries.
- Do not mix old and new batteries or different types of batteries.
- Do not recharge ordinary dry cell batteries.
- Do not heat or disassemble the batteries. Do not allow them to contact flame or water.
- Do not keep together with metallic objects such as necklaces.
- Do not use rechargeable type batteries.
- Do not use batteries if the covering has been peeled off.

Mishandling of batteries can damage other items, cause damage to the unit, and may cause a fire through short-circuiting or electrolyte leakage. If electrolyte leaks from the batteries, consult your dealer. Wash thoroughly with water if electrolyte comes in contact with any part of your body.

This product may receive radio interference caused by mobile telephones during use. If such interference is apparent, please increase separation between the product and the mobile telephone.



Maintenance

If the surfaces are dirty

To clean this unit, wipe with a soft, dry cloth.

If the surfaces are extremely dirty, use a soft cloth dipped in a soap-and-water solution or a weak detergent solution.

- Never use alcohol, paint thinner or benzine to clean this unit.
- Before using chemically treated cloth, read the instructions that came with the cloth carefully.

Tape head care

Clean the heads regularly to assure good quality playback and recording.

Use a cleaning tape (not included).

Lens care

Clean the lens regularly to prevent malfunctions. Use a blower to remove dust and a cotton swab if it is extremely dirty.

Recommended product:
Lens cleaner kit (SZZP1038C).

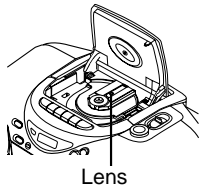

Using headphones (not included)

Turn down the volume and connect the headphones to the [PHONES] jack.

Plug type: 3.5mm stereo

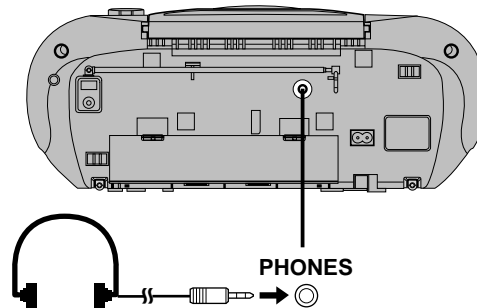

Note

Avoid listening for prolonged periods of time to prevent hearing damage.

Caution for AC Mains Lead

(For United Kingdom)



("EB" area code model only)

For your safety, please read the following text carefully.

This appliance is supplied with a moulded three pin mains plug for your safety and convenience.

A 5-ampere fuse is fitted in this plug.

Should the fuse need to be replaced please ensure that the replacement fuse has a rating of 5-ampere and that it is approved by ASTA or BSI to BS1362.

Check for the ASTA mark  or the BSI mark  on the body of the fuse.

If the plug contains a removable fuse cover you must ensure that it is refitted when the fuse is replaced.

If you lose the fuse cover the plug must not be used until a replacement cover is obtained.

A replacement fuse cover can be purchased from your local dealer.

CAUTION!

IF THE FITTED MOULDED PLUG IS UNSUITABLE FOR THE SOCKET OUTLET IN YOUR HOME THEN THE FUSE SHOULD BE REMOVED AND THE PLUG CUT OFF AND DISPOSED OF SAFELY. THERE IS A DANGER OF SEVERE ELECTRICAL SHOCK IF THE CUT OFF PLUG IS INSERTED INTO ANY 13-AMPERE SOCKET.

If a new plug is to be fitted please observe the wiring code as stated below.

If in any doubt please consult a qualified electrician.

IMPORTANT

The wires in this mains lead are coloured in accordance with the following code:

Blue: Neutral, Brown: Live.

As these colours may not correspond with the coloured markings identifying the terminals in your plug, proceed as follows:

The wire which is coloured Blue must be connected to the terminal which is marked with the letter N or coloured Black or Blue.

The wire which is coloured Brown must be connected to the terminal which is marked with the letter L or coloured Brown or Red.

WARNING: DO NOT CONNECT EITHER WIRE TO THE EARTH TERMINAL WHICH IS MARKED WITH THE LETTER E, BY THE EARTH SYMBOL \perp OR COLOURED GREEN OR GREEN/YELLOW.

THIS PLUG IS NOT WATERPROOF—KEEP DRY.

Before use

Remove the connector cover.

How to replace the fuse

The location of the fuse differ according to the type of AC mains plug (figures A and B). Confirm the AC mains plug fitted and follow the instructions below.

Illustrations may differ from actual AC mains plug.

1. Open the fuse cover with a screwdriver.

Figure A

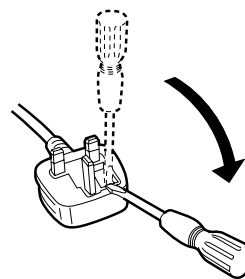
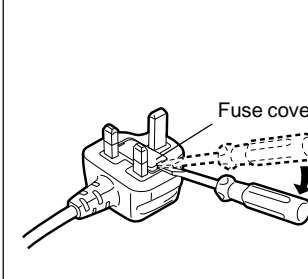

Figure B



2. Replace the fuse and close or attach the fuse cover.

Figure A

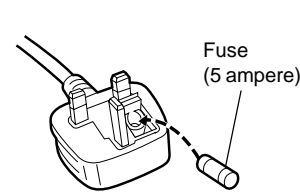
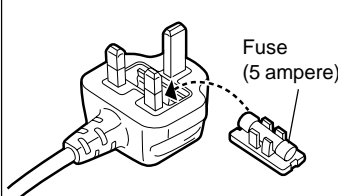

Figure B





Audio software

Take note of the following points to extend the life of your equipment. Always read the instructions provided with the software.

Discs

Choose discs with this mark:



Continued use of irregular shaped CDs can damage the unit.

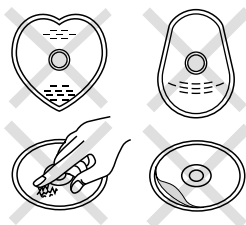

Do not

- use CDs with labels and stickers that are coming off or with adhesive exuding from under labels and stickers.
- attach scratch-proof covers or any other kind of accessory.
- write anything on the CD.
- clean CDs with liquids. (Wipe with a soft, dry cloth.)
- use CDs printed with label printers available on the market.
- load a blank CD-R as it will cause abnormal malfunction and may damage the CD-R.

Cassette tapes

- Tapes exceeding 100 minutes are thin and can break or get caught in the mechanism.
- Tape slack can get caught up in the mechanism and should be taken up before the tape is played.
- Endless tapes can get caught up in the deck's moving parts if used incorrectly.

Specifications

Frequency range	87.50–108.00 MHz (50 kHz steps)
FM	87.50–108.00 MHz (50 kHz steps)
AM	522–1629 kHz (9 kHz steps)
Sampling frequency	44.1 kHz
Decoding	16 bit linear
Beam source	Semiconductor laser (wavelength 780 nm)
Bølgelengde	780 nm
Laser-styrke	Ingen farlig stråling sendes ut (med sikkerhets-beskyttelse)
No. of channels	2 channel, stereo
Wow and flutter	Less than possible measurement data
D/A converter	1 bit DAC
Track system	4 track, 2 channel, stereo
Monitor system	Variable sound monitor
Recording system	AC bias
Erasing system	Multi Pole magnet
Frequency range	50–12000 Hz
Normal position	50–12000 Hz
Speakers	
Full range	10 cm 4Ω x 2
Center speaker (RX-D19 only)	1.5 cm
Jacks	
Output	PHONES: 3.5 mm stereo (32Ω)
Power requirement	
AC	230-240 V, 50 Hz
Battery	Power consumption: 11 W 9 V (Six R20/LR20, D, UM-1 batteries)
Memory back-up	<ul style="list-style-type: none"> • Do not use rechargeable type batteries. 6 V (Four R6/LR6, AA, UM-3 batteries) • Do not use rechargeable type batteries.
Dimensions (WxHxD)	420 x 167 x 275 mm
Mass	(RX-D19) 3.6 kg without batteries (RX-D17) 3.4 kg without batteries

Note

Specifications are subject to change without notice. Mass and dimensions are approximate.

Troubleshooting guide

If you are in doubt about some of the check points, or if the remedies indicated in the chart do not solve the problem, refer to the directory of Authorized Service Centers (enclosed with this unit) to locate a convenient service center, or consult your dealer for instructions.

Common Problem

The unit doesn't work on batteries.	Is the AC mains lead connected to the unit? Disconnect when using batteries. Have the batteries been inserted correctly? Check that the poles (+ and -) are correctly aligned.
"UO1" is displayed.	Replace the batteries or use household AC power.

CD

"E" is displayed. Play doesn't start or display is incorrect.	Indicates an incorrect operation. Read the instructions. Clean the CD. Wait for an hour for condensation to dry, then try again. Make sure the label is facing up. Replace the CD if it is scratched, warped, or irregularly shaped.
--	--

Cassette

Recording not possible.	Has the cassette's tab been removed? Cover the hole with adhesive tape.
Poor sound quality.	Clean the heads.
The cassette cannot be ejected or the lid can't be closed when loading a cassette.	The batteries are flat. Replace the batteries or connect to household AC power. Press [◀ PLAY] then [■/▲ STOP/EJECT].

Radio

A lot of noise.	Is another remote control being used? Use it further away from this unit. Is a TV on? Move the unit away from the TV or turn it off.
------------------------	---

Remote control **RX-D19 only**

The remote control doesn't work.	Check the batteries are inserted correctly. Replace the batteries if they are worn.
---	--

Matsushita Electric Industrial Co., Ltd.
Web Site: <http://www.panasonic.co.jp/global/>



RQT6341-B
L1101TC0