

# Panasonic®

English

WMA MP3 CD Player/Receiver

Model: **CQ-C1335U/CQ-C1305U**  
**CQ-C1335L/CQ-C1305L**  
**Operating Instructions**



(CQ-C1335U)



**WMA**

**MP3**

- Please read these instructions (including “Limited Warranty” and “Customer Services Directory”) carefully before using this product and keep this manual for future reference.

# Safety Information

- Read the operating instructions for the unit and all other components of your car audio system carefully before using the system. They contain instructions about how to use the system in a safe and effective manner. Panasonic assumes no responsibility for any problems resulting from failure to observe the instructions given in this manual.



**Warning**

This pictograph intends to alert you to the presence of important operating instructions and installation instructions. Failure to heed the instructions may result in severe injury or death.



**Caution**

This pictograph intends to alert you to the presence of important operating instructions and installation instructions. Failure to heed the instructions may result in injury or material damage.

## **Warning**

**Observe the following warnings when using this unit.**

- ❑ **The driver should neither watch the display nor operate the system while driving.**  
Watching the display or operating the system will distract the driver from looking ahead of the vehicle and can cause accidents. Always stop the vehicle in a safe location and use the parking brake before watching the display or operating the system.
- ❑ **Use the proper power supply.**  
This product is designed for operation with a negative grounded 12 V DC battery system. Never operate this product with other battery systems, especially a 24 V DC battery system.
- ❑ **Keep batteries and insulation film out of reach of infants.**  
Batteries and insulation film can be ingested, so keep them out of the reach of infants. If an infant ingests a battery or insulation film, please seek immediate medical attention.
- ❑ **Protect the Deck Mechanism.**  
Do not insert any foreign objects into the slot of this unit.
- ❑ **Do not disassemble or modify the unit.**  
Do not disassemble, modify the unit or attempt to repair the product yourself. If the product needs to be repaired, consult your dealer or an authorized Panasonic Servicenter.
- ❑ **Do not use the unit when it is out of order.**  
If the unit is out of order (no power, no sound) or in an abnormal state (has foreign objects in it, is exposed to water, is smoking, or smells), turn it off immediately and consult your dealer.
- ❑ **The remote control unit should not lie about in the car.**  
If the remote control unit lies about, it could fall on the floor while driving, get wedged under the brake pedal, and lead to a traffic accident.
- ❑ **Refer fuse replacement to qualified service personnel.**  
When the fuse blows out, eliminate the cause and have it replaced with the fuse prescribed for this unit by a qualified service engineer. Incorrect replacement of the fuse may lead to smoke, fire, and damage to the product.

**Observe the following warnings when installing.**

- ❑ **Disconnect the lead from the negative (–) battery terminal before installation.**  
Wiring and installation with the negative (–) battery terminal connected may cause electrical shock and injury due to a short circuit. Some cars equipped with the electrical safety system have specific procedures of battery terminal disconnection.  
**FAILURE TO FOLLOW THE PROCEDURE MAY LEAD TO THE UNINTENDED ACTIVATION OF THE ELECTRICAL SAFETY SYSTEM RESULTING IN DAMAGE TO THE VEHICLE AND PERSONAL INJURY OR DEATH.**
- ❑ **Never use safety-related components for installation, grounding, and other such functions.**  
Do not use safety-related vehicle components (fuel tank, brake, suspension, steering wheel, pedals, airbag, etc.) for wiring or fixing the product or its accessories.
- ❑ **Installing the product on the air bag cover or in a location where it interferes with airbag operation is prohibited.**
- ❑ **Check for piping, gasoline tank, electric wiring, and other items before installing the product.**  
If you need to open a hole in the vehicle chassis to attach or wire the product, first check where the wire harness, gasoline tank, and electric wiring are located. Then open the hole from outside if possible.
- ❑ **Never install the product in a location where it interferes with your field of vision.**
- ❑ **Never have the power cord branched to supply other equipment with power.**
- ❑ **After installation and wiring, you should check the normal operation of other electrical equipment.**  
The continuation of their using in abnormal conditions may cause fire, electrical shock or a traffic accident.
- ❑ **In the case of installation to an airbag-equipping car, confirm warnings and cautions of the vehicle manufacturer before installation.**
- ❑ **Make sure the leads do not interfere with driving or getting in and out of the vehicle.**
- ❑ **Insulate all exposed wires to prevent short circuiting.**

## Caution

### Observe the following cautions when using this unit.

**Keep the sound volume at an appropriate level.**

Keep the volume level low enough to be aware of road and traffic conditions while driving.

**This unit is designed for use exclusively in automobiles.**

**Do not operate the unit for a prolonged period with the engine turned off.**

Operating the audio system for a long period of time with the engine turned off will drain the battery.

**Do not expose the unit to direct sunlight or excessive heat.**

Otherwise these will raise the interior temperature of the unit, and it may lead to smoke, fire, or other damage to the unit.

**Do not use the product where it is exposed to water, moisture, or dust.**

Exposure of the unit to water, moisture, or dust may lead to smoke, fire, or other damage to the unit. Make especially sure that the unit does not get wet in car washes or on rainy days.

**Set the volume level to low enough before the AUX connection is completed.**

Failure to observe this, the loud noise may come out and damage your speakers and your hearing. Direct connection of the speaker/headphone output of an external device without any attenuator may distort sound or damage the connected external device.

### Observe the following cautions when installing.

**Refer wiring and installation to qualified service personnel.**

Installation of this unit requires special skills and experience. For maximum safety, have it installed by your dealer. Panasonic is not liable for any problems resulting from your own installation of the unit.

**Follow the instructions to install and wire the product.**

Not following the instructions to properly install and wire the product could cause an accident or fire.

**Take care not to damage the leads.**

When wiring, take care not to damage the leads. Prevent them from getting caught in the vehicle chassis, screws, and moving parts such as seat rails. Do not scratch, pull, bend or twist the leads. Do not run them near heat sources or place heavy objects on them. If leads must be run over sharp metal edges, protect the leads by winding them with vinyl tape or similar protection.

**Use the designated parts and tools for installation.**

Use the supplied or designated parts and appropriate tools to install the product. The use of parts other than those supplied or designated may result in internal damage to the unit. Faulty installation may lead to an accident, a malfunction or fire.

**Do not block the air vent or the cooling plate of the unit.**

Blocking these parts will cause the interior of the unit to overheat and will result in fire or other damage.

**Do not install the product where it is exposed to strong vibrations or is unstable.**

Avoid slanted or strongly curved surfaces for installation. If the installation is not stable, the unit may fall down while driving and this can lead to an accident or injury.

**Installation Angle**

The product should be installed in a horizontal position with the front end up at a convenient angle, but not more than 30°. The user should bear in mind that in some areas there may be restrictions on how and where this unit must be installed. Consult your dealer for further details.

**Wear gloves for safety. Make sure that wiring is completed before installation.**

**To prevent damage to the unit, do not connect the power connector until the whole wiring is completed.**

**Do not connect more than one speaker to one set of speaker leads. (except for connecting to a tweeter)**

### Observe the following cautions when handling the battery for the remote control unit. **CQ-C1335U CQ-C1335L**

- Use only specified battery (CR2025).
- Match the polarity of the battery with the (+) and (–) marks in the battery case.
- Replace a dead battery as soon as possible.
- Remove the battery from the remote control unit when not using it for an extended period of time.
- Insulate the battery (by placing them in a plastic bag or covering them with vinyl tape) before disposal or storage.
- Dispose of the battery according to the local regulations.
- Do not disassemble, recharge, heat or short the battery. Do not throw a battery into a fire or water.

### In case of battery leakage

- Thoroughly wipe the battery liquid off the battery case and insert new battery.
- If any part of your body or clothing comes into contact with battery liquid, wash it with plenty of water.
- If battery liquid comes into contact with your eyes, wash them with plenty of water and get immediate medical attention.

## Caution

**THIS PRODUCT IS A CLASS I LASER PRODUCT.  
USE OF CONTROLS OR ADJUSTMENTS OR PERFORMANCE OF  
PROCEDURES OTHER THAN THOSE SPECIFIED HEREIN MAY  
RESULT IN HAZARDOUS RADIATION EXPOSURE.  
DO NOT OPEN COVERS AND DO NOT REPAIR BY YOURSELF.  
REFER SERVICING TO QUALIFIED PERSONNEL.**

### The following applies only in the U.S.A.

#### Part 15 of the FCC Rules

##### FCC Warning:

Any unauthorized changes or modifications to this equipment would void the user's authority to operate this device.

##### Notice

This product contains a CR Coin Cell Lithium Battery which contains Perchlorate Material - special handling may apply. See [www.dtsc.ca.gov/hazardouswaste/perchlorate](http://www.dtsc.ca.gov/hazardouswaste/perchlorate).

# Before Reading These Instructions

Panasonic welcomes you to our constantly growing family of electronic products owners. We endeavor to give you the advantages of precise electronic and mechanical engineering, manufactured with carefully selected components, and assembled by people who are proud of the reputation their work has built for our company. We know this product will bring you many hours of enjoyment, and after you discover the quality, value and reliability we have built into it, you too will be proud to be a member of our family.

Differences among 4 models

This operating instruction manual is for 4 models CQ-C1335U, CQ-C1305U, CQ-C1335L and CQ-C1305L. All illustrations throughout this manual represent model CQ-C1335U unless otherwise specified. The following table describes the differences among 4 models.

Features \ Models	CQ-C1335U	CQ-C1305U	CQ-C1335L	CQ-C1305L
Pre-Out Connector	2 (Front/Rear)	1 (Rear)	2 (Front/Rear)	1 (Rear)
Remote Control Unit	Supported (Included)	Not Supported	Supported (Included)	Not Supported
Removable Face Plate Case	Not Supported	Not Supported	Supported (Included)	Supported (Included)

Customer Services Directory

## U.S.A.

Obtain Product Information and Operating Assistance; locate your nearest Dealer or Servicenter; purchase Parts and Accessories; or make Customer Service and Literature requests by visiting our Web Site at:

<http://www.panasonic.com/support>

or, contact us via the web at:

<http://www.panasonic.com/contactinfo>

You may also contact us directly at:

1-800-211-PANA (7262),

Monday-Friday 9 am-9 pm; Saturday-Sunday 10 am-7 pm, EST.

For hearing or speech impaired TTY users, TTY : 1-877-833-8855

### Accessory Purchases:

Purchase Parts, Accessories and Instruction Books online for all Panasonic Products by visiting our Web Site at:

<http://www.pasc.panasonic.com>

or, send your request by E-mail to:

[npparts@panasonic.com](mailto:npparts@panasonic.com)

You may also contact us directly at:

1-800-332-5368 (Phone) 1-800-237-9080 (Fax Only)

(Monday-Friday 9 am to 8 pm, EST.)

Panasonic Services Company

20421 84th Avenue South, Kent, WA 98032

(We accept Visa, MasterCard, Discover Card, American

Express, and Personal Checks)

For hearing or speech impaired TTY users, TTY : 1-866-605-1277

### Service in Puerto Rico

Panasonic Puerto Rico, Inc.

Panasonic Sales Company

Factory Servicenter:

Ave. 65 de Infantería, Km. 9.5, San Gabriel Industrial Park,

Carolina, Puerto Rico 00985

Phone (787) 750-4300, Fax (787) 768-2910

## CANADA

### WARRANTY SERVICE

FOR PRODUCT OPERATION ASSISTANCE, please contact:

Our Customer Care Centre:

Telephone #: (905) 624-5505

1-800 #: 1-800-561-5505

Fax #: (905) 238-2360

Email link: "Contact Us" on [www.panasonic.ca](http://www.panasonic.ca)

FOR PRODUCT REPAIRS, please locate your nearest Authorized Servicentre at [www.panasonic.ca](http://www.panasonic.ca):

Link : "Servicentres™ locator" under "Customer support"

### IF YOU SHIP THE PRODUCT TO A SERVICENTRE

Carefully pack and send prepaid, adequately insured and preferably in the original carton.

Include details of the defect claimed, and proof of date of original purchase.

## U.S.A.

PANASONIC CONSUMER ELECTRONICS COMPANY,  
DIVISION OF PANASONIC CORPORATION OF NORTH AMERICA  
One Panasonic Way, Secaucus, New Jersey 07094

PANASONIC SALES COMPANY,  
DIVISION OF PANASONIC PUERTO RICO, INC.  
Ave. 65 de infantería, Km. 9.5, San Gabriel Industrial Park  
Carolina, Puerto Rico 00985

### PANASONIC AUTO PRODUCTS LIMITED WARRANTY

#### LIMITED WARRANTY COVERAGE

If your product does not work properly because of defects in materials and workmanship.

Panasonic Consumer Electronics Company or Panasonic Sales Company (collectively referred to as "the warrantor") will, for the length of the period indicated in the chart below, which starts with the date of original purchase ("warranty period"), at its option either (a) repair your product with new or refurbished parts, or (b) replace it with a new or refurbished product. The decision to repair or replace will be made by the warrantor.

Categories	Parts	Labor
Audio Components (except items listed below)	One (1) Year	One (1) Year
<b>MXE</b> Series Audio Components (except items listed below)	Two (2) Years	Two (2) Years
Speakers Defective Car Audio Speakers under warranty must be exchanged at the place of purchase. Contact your Dealer for details.	One (1) Year	Not Applicable
Accessories (in exchange for defective items)	Ninety (90) Days	Not Applicable

During the "Labor" warranty period, there will be no charge for labor. During the "Parts" warranty period, there will be no charge for parts. You must carry-in or mail-in your product prepaid during the warranty period. If nonrechargeable batteries are included, they are not warranted. This warranty only applies to products purchased and serviced in the United States or Puerto Rico. This warranty is extended only to the original purchaser of a new product which was not sold "as is". A purchase receipt or other proof of the original purchase date is required for warranty service.

#### CARRY-IN OR MAIL-IN SERVICE

For Carry-In or Mail-In Service in the United States, call 1-800-211-PANA (7262) or visit

Panasonic Web Site: <http://www.panasonic.com>

For assistance in Puerto Rico, call Panasonic Sales Company (787)-750-4300 or fax (787)-768-2910.

#### LIMITED WARRANTY LIMITS AND EXCLUSIONS

This warranty ONLY COVERS failures due to defects in materials and workmanship, and DOES NOT COVER normal wear and tear or cosmetic damage. The warranty ALSO DOES NOT COVER damages which occurred during shipment, failures which are caused by products not supplied by the warrantor, failures which result from accident, misuse, abuse, neglect, bug infestation, mishandling, misapplication, alteration, faulty installation, set-up adjustment, maladjustment of consumer control, improper maintenance, improper antenna, inadequate signal reception or pickup, power line surge, improper voltage supply, lightning, modification, commercial use (such as use in hotels, offices, restaurants, or other business uses) or rental use of the product, or service by anyone other than the technician from Factory Servicenter or other authorized service centers, or damage that is attributable to acts of God.

**THERE ARE NO EXPRESS WARRANTIES EXCEPT AS LISTED UNDER "LIMITED WARRANTY COVERAGE". THE WARRANTOR IS NOT LIABLE FOR INCIDENTAL OR CONSEQUENTIAL DAMAGES RESULTING FROM THE USE OF THIS PRODUCT, OR ARISING OUT OF ANY BREACH OF THIS WARRANTY.** (As examples, this excludes damages for lost time, cost of having someone remove or re-install an installed unit if applicable, travel to and from the sevicer, and loss of media, data or other memory contents. The items listed are not exclusive, but are for illustration only.) **ALL EXPRESS AND IMPLIED WARRANTIES, INCLUDING THE WARRANTY OF MERCHANTABILITY, ARE LIMITED TO THE PERIOD OF THE LIMITED WARRANTY.**

Some states do not allow the exclusion or limitation of incidental or consequential damages, or limitations on how long an implied warranty lasts, so the exclusions may not apply to you.

This warranty gives you specific legal rights and you may also have other rights which vary from state to state. If a problem with this product develops during or after the warranty period, you may contact your dealer or Servicenter. If the problem is not handled to your satisfaction, then write to warrantor's Consumer Affairs Department at the addresses of the warrantor.

#### PARTS AND SERVICE WHICH ARE NOT COVERED BY THIS LIMITED WARRANTY ARE YOUR RESPONSIBILITY.

Customer's Record

Model

No. \_\_\_\_\_

Serial

No. \_\_\_\_\_

Dealer's

No. \_\_\_\_\_

Code

No. \_\_\_\_\_

Dealer's

Address \_\_\_\_\_

Date of

Purchase \_\_\_\_\_

## CANADA

Panasonic Canada Inc.  
5770 Ambler Drive, Mississauga Ontario L4W 2T3

### PANASONIC PRODUCT LIMITED WARRANTY

Panasonic Canada Inc. warrants this product to be free from defects in materials and workmanship and agrees to remedy any such defect for a period as stated below from the date of original purchase.

#### CAR AUDIO PRODUCT – ONE (1) YEAR, PARTS AND LABOUR

(The labour to install or remove the product is not warranted)

ACCESSORIES - NINETY (90) DAYS, (IN EXCHANGE FOR DEFECTIVE ITEMS)

#### LIMITATIONS AND EXCLUSIONS

This warranty does not apply to products purchased outside Canada or to any product which has been improperly installed, subjected to usage for which the product was not designed, misused or abused, damaged during shipping, or which has been altered or repaired in any way that affects the reliability or detracts from the performance, nor does it cover any product which is used commercially. Dry cell batteries are also excluded from coverage under this warranty.

This warranty is extended to the original end user purchaser only. A purchase receipt or other proof of the original purchase date is required before warranty service is performed.

**THIS EXPRESS, LIMITED WARRANTY IS IN LIEU OF ALL OTHER WARRANTIES, EXPRESS OR IMPLIED, INCLUDING ANY IMPLIED WARRANTIES OF MERCHANTABILITY AND FITNESS FOR A PARTICULAR PURPOSE.**



**IN NO EVENT WILL PANASONIC CANADA INC. BE LIABLE FOR ANY SPECIAL, INDIRECT OR CONSEQUENTIAL DAMAGES.**

In certain instances, some jurisdictions do not allow the exclusion or limitation of incidental or consequential damages, or the exclusion of implied warranties, so the above limitations and exclusions may not be applicable.











# Accessories

Instruction kit **CQ-C1335U** **CQ-C1305U**



	<b>Operating Instructions</b> (English: YEFM285905) (Français: YEFM285906) (Español: YEFM285907) <b>Q'ty: 1 set</b>
	<b>Installation Instructions</b> (YEFM294287) <b>Q'ty: 1</b>
	<b>Owners Information Card</b> <b>Q'ty: 1</b>

Installation kit (YEP0FZ5698) **Q'ty: 1**

	<b>Lock Cancel Plate</b>
	<b>Mounting Bolt (5 mm φ)</b>
	<b>Rubber Bushing</b>

	<b>Mounting Collar</b> (YEFX0217263A) <b>Q'ty: 1</b>
	<b>Trim Plate</b> (YEFM051020) <b>Q'ty: 1</b>
	<b>Power Connector</b> (YG AJ021012) <b>Q'ty: 1</b>
	<b>CQ-C1335U</b> <b>CQ-C1335L</b> <b>Remote Control Unit</b> (includes a battery) (EUR7641010) <b>Q'ty: 1</b>
	<b>CQ-C1335L</b> <b>CQ-C1305L</b> <b>Removable Face Plate Case</b> (YEFA131839A) <b>Q'ty: 1</b>

Instruction kit **CQ-C1335L** **CQ-C1305L**

	<b>Operating Instructions</b> (English: YEFM285905) (Español: YEFM285907) <b>Q'ty: 1 set</b>
	<b>Installation Instructions</b> (YEFM294287) <b>Q'ty: 1</b>

## Notes:

- The number in parentheses underneath each accessory part name is the part number for maintenance and service.
- Accessories and their part numbers are subject to modification without prior notice due to improvements.
- Mounting Collar and Trim Plate are mounted on the main unit at shipment.

**CQ-C1335U** **CQ-C1305U**

## Request for use of the Removable Face Plate Case:

- To avoid trouble and ensure safety, use the optional Removable Face Plate Case (YEFA131839A).

**Panasonic Consumer Electronics Company,**  
Division of Panasonic Corporation of North America  
One Panasonic Way, Secaucus,  
New Jersey 07094  
<http://www.panasonic.com>

**Panasonic Sales Company,**  
Division of Panasonic Puerto Rico, Inc. ("PSC")  
Ave. 65 de Infantería, Km. 9.5  
San Gabriel Industrial Park,  
Carolina, Puerto Rico 00985  
<http://www.panasonic.com>

**Panasonic Canada Inc.**  
5770 Ambler Drive,  
Mississauga, Ontario  
L4W 2T3  
<http://www.panasonic.ca>

**Matsushita Electric Industrial Co., Ltd.**

Web Site: <http://panasonic.net>

# Preparation

## First Time Power On

- 1 Set your car's ignition switch to the ACC or ON position.



- 2 Press [SOURCE] (PWR: Power).

## Battery Installation

**CQ-C1335U CQ-C1335L**

Pull the insulation film out from the backside of the remote control gently.

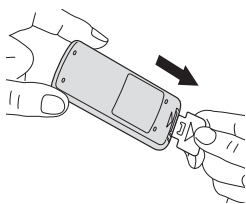

**Note:** Battery Information:

Battery Type: Panasonic lithium battery (CR2025) (Included in the remote control)

Battery Life: Approximately 6 months under normal use (at room temperature)

## Clock Setting

The 12-hour system is used for the clock.

- 1 Press [DISP].  
 (clock display)
- 2 Hold down [DISP] for more than 2 seconds.

 Hour blinks

- 3 Adjust the hour.  
 Hour entered

[▶▶]: sets the hour ahead.  
[◀◀]: sets the hour back.

- 4 Press [DISP].  
 Minute blinks

- 5 Adjust the minute.  
 Minute entered

[▶▶]: sets the minute ahead.  
[◀◀]: sets the minute back.

- 6 Press [DISP].  
 Completed

**Notes:**

- "ADJUST" is displayed before adjusting the clock.
- Hold down [◀◀] or [▶▶] to change numbers rapidly.

### Clock Display at Power Off

Press [DISP] to change the display.

Display off



Clock display

# Maintenance/Fuse

## Cleaning the Unit

Your product is designed and manufactured to ensure the minimum of maintenance. Use a dry, soft cloth for routine exterior cleaning. Never use benzine, thinner, or other solvents.

## Fuse

If the fuse blows out, consult your dealer, or your nearest authorized Panasonic Servicenter.

### ⚠ Warning

- Use fuses of the same specified rating (**15 A**). Using substitutes or fuses with higher ratings, or connecting the unit directly without a fuse could cause fire or damage to the unit. **If the replaced fuse fails, contact your nearest authorized Panasonic Servicenter.**

# Anti-Theft System

This unit is equipped with a removable face plate. Removing this face plate makes the unit totally inoperable.

## Face Plate Removing/Mounting (Anti-Theft System)

### ⚠ Caution

- This face plate is not waterproof. Do not expose it to water or excessive moisture.
- Do not remove the face plate while driving your car.
- Do not place the face plate on the dashboard or nearby areas where the temperature rises high.
- Do not touch the contacts on the face plate and the main unit, since this may result in poor electrical contact.
- If dirt or other foreign substances get on the contacts, wipe them off with a clean and dry cloth.

### Removing

- 1 Turn off the power.
- 2 Press [**▲**]. The face plate will open.
- 3 Pull it out toward you.

### Mounting

- 1 Slide the left side of the face plate in place.
- 2 Press the right end of face plate until a “click” is heard.

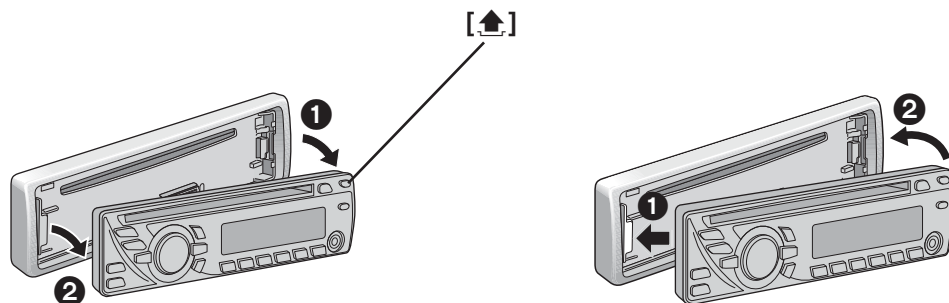



# Notes on Discs

## Notes on CD/CD Media (CD-ROM, CD-R, CD-RW)

If you use commercial CDs, they must have either of these labels shown at right. Some copy-protected music CDs are not playable.



### How to hold the disc

- Do not touch the underside of the disc.
- Do not scratch on the disc.
- Do not bend the disc.
- When not in use, keep disc in the case.

### Do not leave discs in the following places:

- In direct sunlight
- Near car heaters
- Dirty, dusty and damp areas
- On seats and dashboards

### Disc cleaning

Use a dry, soft cloth to wipe from the center outward.



Do not write on the disc label with a ballpoint pen or other hard-point pens.

Printed side



Labels created by a printer, Protective films or sheets



Irregularly shaped discs

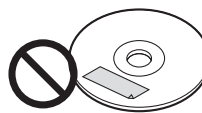

Disc with adhered stickers or tape



Discs with cracks, scratches or parts missing

## Notes on CD-Rs/RWs

- You may have trouble playing back some CD-R/RW discs recorded using CD recorders (CD-R/RW drives), either due to their recording characteristics or dirt, fingerprints, scratches, etc. on the disc surface.
- CD-R/RW discs are less resistant to high temperatures and high humidity than ordinary music CDs. Leaving them inside a car for extended periods may damage and make playback impossible.
- Some CD-R/RWs cannot be played back successfully due to incompatibility among writing software, a CD recorder (CD-R/RW drive) and the discs.
- This player cannot play the CD-R/RW discs if the session is not closed.
- This player cannot play the CD-R/RW discs which contain other than CD-DA or MP3/WMA data (Video CD, etc.).
- Be sure to observe the instructions of the CD-R/RW disc for handling it.

### Recording MP3/WMA files on a CD-media

- You are recommended to minimize the chances of making a disc that contains both CD-DA files and MP3/WMA files.
- If CD-DA files are on the same disc as MP3 or WMA files, the songs may not play in the intended order, or some songs may not play at all.
- When storing MP3 data and WMA data on the same disc, use different folders for each data.
- Do not record files other than MP3/WMA files and unnecessary folder on a disc.
- The name of MP3/WMA file should be added by rules as shown in the following descriptions and also comply with the rules of each file system.

- You may encounter trouble in playing MP3/WMA files or displaying the information of MP3/WMA files recorded with certain writing software or CD recorders.
- The file extension “.mp3” or “.wma” should be assigned to each file depending on the file format.
- This unit does not have the play list function.
- Although Multi-session recording is supported, the use of Disc-at-Once is recommended.

### Supported file systems

ISO 9660 Level 1/Level 2, Apple Extension to ISO 9660, Joliet, Romeo

**Note:** Apple HFS, UDF 1.50, MIX mode CD, CD Extra is not supported.

### Compression formats

(**Recommendation:** “Points to remember when making MP3/WMA files” on the right.)

- |  |   |
|--|---|
| <ul style="list-style-type: none"> <li>• <b>MPEG 1 audio layer 3</b><br/>Bit rate: 32 k–320 kbps<br/>VBR: Yes<br/>Sampling frequency: 32, 44.1, 48 kHz</li> </ul>              | <ul style="list-style-type: none"> <li>• <b>MPEG 2 audio layer 3</b><br/>Bit rate: 8 k–160 kbps<br/>VBR: Yes<br/>Sampling frequency: 16, 22.05, 24 kHz</li> </ul> |
| <ul style="list-style-type: none"> <li>• <b>Windows Media Audio Ver. 7, 8, 9*</b><br/>Bit rate: 32 k–192 kbps<br/>VBR: Yes<br/>Sampling frequency: 32, 44.1, 48 kHz</li> </ul> |   |

\* WMA 9 Professional/LossLess/Voice are not supported.

# Notes on MP3/WMA

**Note:** MP3/WMA encoding and writing software is not supplied with this unit.

## Points to remember when making MP3/WMA files

### Common

- High bit rate and high sampling frequency are recommended for high quality sounds.
- Selecting VBR (Variable Bit Rate) is not recommended because playing time is not displayed properly and sound may be skipped.
- The playback sound quality differs depending on the encoding circumstances. For details, refer to the user manual of your own encoding software and writing software.

### MP3\*

- It is recommended to set the bit rate to “128 kbps or more” and “fixed”.
- \* MPEG Layer-3 audio coding technology licensed from Fraunhofer IIS and Thomson.

### WMA

- It is recommended to set the bit rate to “64 kbps or more” and “fixed”.
- Do not set the copy protect attribute on the WMA file to enable this unit to play back.

### ⚠ Caution

- **Never assign the “.mp3”, or “.wma” file name extension to a file that is not in the MP3/WMA format. This may not only produce noise from the speaker damage, but also damage your hearing.**

## Display Information

### Displayed items

- |   |  |
|---|--|
| • <b>CD-TEXT</b><br>Disc title<br>Track title | • <b>MP3 (ID3 tag)</b><br>Album name<br>Title name/Artist name |
| • <b>MP3/WMA</b><br>Folder name<br>File name  | • <b>WMA (WMA tag)</b><br>Album name<br>Title name/Artist name |

### Displayable characters

- Displayable length of file name/folder name: within 32 characters. (Unicode file and folder names are reduced by half in the number of displayable characters.)
- Name files and folders in accordance with the standard of each file system. Refer to the instructions of writing software for details.
- ASCII character set and special characters in each language can be displayed.

### Copyright

It is prohibited by copyright laws to copy, distribute and deliver copyrighted materials such as music without the approval of copyright holder except enjoying yourself personally.

### Notes:

- With some software in which MP3/WMA format files have been encoded, the character information may not be displayed properly.
- Undisplayable characters and symbols will be converted into an asterisk (\*).

## Folder selection order/file playback order

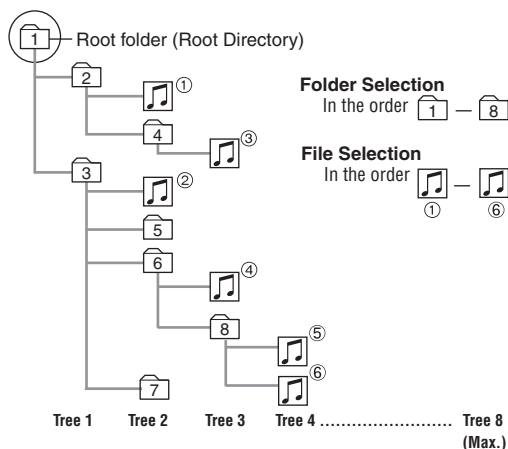

### Maximum number of files/folders

- Maximum number of files: 999
- Maximum number of files in one folder: 255
- Maximum depth of trees: 8
- Maximum number of folders: 255 (Root folder is included.)

### Notes:

- This unit counts the number of folders irrespective of the presence or absence of MP3/WMA file.
- If the selected folder does not contain any MP3/WMA files, the nearest MP3/WMA files in the order of playback will be played.
- Playback order may be different from other MP3/WMA players even if the same disc is used.
- “ROOT” appears when displaying the root folder name.

Windows Media, and the Windows logo are trademarks, or registered trademarks of Microsoft Corporation in the United States and/or other countries/regions.



### No warranty

Above description complies with our investigations as of September 2006. It has no warranty for reproducibility and displayability of MP3/WMA.

# Remote Control Unit

CQ-C1335U CQ-C1335L

## Notes:

- This instruction manual explains operations for use with the buttons on the main unit. (Different operations excluded)
- Aim the remote control at the remote sensor and operate it.

### [0] to [9]

selects a preset station (1 to 6),  
presets the current station (Hold it down for more than 2 seconds.),  
inputs the number in direct selection.

### [#] (NUMBER)

executes the direct selection.

### [RANDOM] [SCAN] [REPEAT]

toggles on/off each play mode.

### [<] [>]

down/up the frequency (Hold it down for more than 0.5 seconds and release it for seek tuning).

### [∨] [∧]

skip to the previous/next folder in player mode.

### [◀◀] [▶▶]

skip to the previous/next track/file in player mode. Hold it down for fast reverse/fast forward.

### [BAND]

selects a band in the tuner source, toggles pause/play in player source, executes the APM (Auto Preset Memory) in tuner source (Hold it down for more than 2 seconds).

### [SRC] (SOURCE)

selects a source.

### (POWER)

toggles power on/off.

### [MENU] (SEL: Select)

selects the items in the audio menu.

### [VOL] (volume)

adjusts the volume, and selects the value in the audio menu, etc.

### [MUTE]

toggles mute on/off.

### [DISP] (Display)

switches the information on display, and exits the audio menu.



## Direct Access

A track (CD mode), file, folder (MP3/WMA mode) can be directly selected.

**Example:** Track number 5

- 1 Press [#] (NUMBER).
- 2 Press [5].
- 3 Press [BAND] (SET).

### Notes:

- To suspend direct selection, press [DISP].
- For folder selection, enter a number after pressing [#] (NUMBER) twice.

## Functions only on Main unit

The following functions are not available on remote control unit.

- SQ selection
- Scroll
- Disc eject

## Battery Replacement

- 1 Remove the battery holder with the remote control unit placed on a flat surface.
  - 1 Stick your thumbnail into the groove, and push the holder in the direction of the arrow, and at the same time.
  - 2 Pull it out in the direction of the arrow using a tough pointed object.

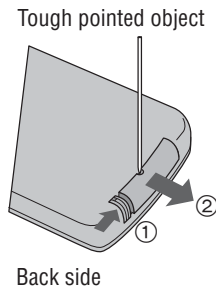

- 2 Put a battery in the case with (+) side facing up.
- 3 Put the case back.

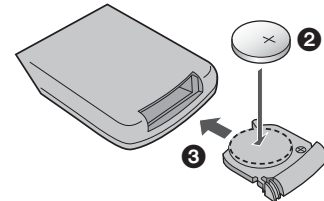

## Warning

- Keep batteries away from children to avoid the risk of accidents. If an infant ingests a battery, please seek immediate medical attention.

## Caution

- Remove and dispose of an old battery immediately.
- Do not disassemble, heat or short a battery. Do not throw a battery into a fire or water.
- Follow local regulations when disposing of a battery.
- Improper use of batteries may cause overheating, an explosion or ignition, resulting in injury or a fire.

## Notice

This product contains a CR Coin Cell Lithium Battery which contains Perchlorate Material - special handling may apply.  
See [www.dtsc.ca.gov/hazardouswaste/perchlorate](http://www.dtsc.ca.gov/hazardouswaste/perchlorate).

### Notes: Battery Information:

Battery Type: Panasonic lithium battery (CR2025) (Included in the remote control)

Battery Life: Approximately 6 months under normal use (at room temperature)

# General

**[SOURCE]** (Source)  
selects a source.  
**[PWR]** (Power)  
toggles power on/off.

**[VOL]** (Volume)

**[SQ]** (Sound Quality)  
selects a sound type  
(SQ).

**[MUTE]**  
toggles mute on/off.

Remote Control Sensor



### Caution

• Set the volume level to low enough before the AUX connection is completed. Failure to observe this, the loud noise may come out and damage your speakers and your hearing.

**\*[AUX] (AUX IN)** (3.5 mm  $\phi$  stereo)  
From line output of external sound/audio device (ex. Silicon-audio player, HDD player, etc.)

**\*AUX IN:**

**<AUX IN>**

## General Operations

### Power On/Off

Set your car's ignition switch to the ACC or ON position.

**Power on:** Press **[SOURCE]** (**PWR**).

**Power off:** Hold down **[SOURCE]** (**PWR**) for more than 1 second.

### Source Selection

Press **[SOURCE]** to change the source. \*

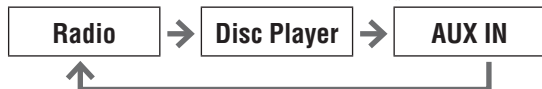

### Volume Adjustment

(Setting Range: 0 to 40, Default: 18)

Turn **[VOL]**.

### Mute

**ON:** Press **[MUTE]**. (**[MUTE]** lights.)

**OFF:** Press **[MUTE]** again.

### SQ (Sound Quality)

SQ is a function that can call up various sound types at the touch of button in accordance with your listening music type. Press **[SQ]** to select the sound type (SQ) as follows:



(FLAT) flat frequency response: does not emphasize any part. (Default)



(ROCK) speedy and heavy sound: exaggerates bass and treble.



(POP) wide-ranged and deep sound: slightly emphasizes bass and treble.



(VOCAL) clear sound: emphasizes middle tone and slightly emphasizes treble.

### Notes:

- If no operation takes place for more than 5 seconds in the SQ selection mode, the display returns to the regular mode.
- Settings of SQ, bass and treble are influenced one another. If such an influence causes distortion to the audio signal, readjust bass/treble or volume.
- For further information on Bass, Treble, Balance and Fader settings, refer to Audio Settings.

# Radio (AM/FM)

**[SOURCE]** (Source)  
selects a source.

**[BAND]**  
selects a band in the radio source.  
**[APM]** (Auto Preset Memory)  
executes APM in the radio source. (Hold it down for more than 2 seconds.)

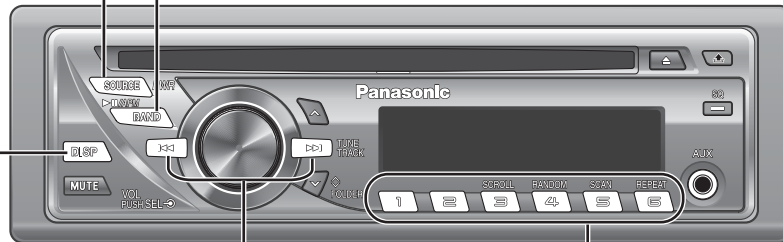

**[DISP]** (Display)  
switches the information on the display.

**[TUNE <<<]** **[TUNE >>>]**  
down/up the frequency. (Hold it down for more than 0.5 seconds and release it for seek tuning.)

**Preset buttons [1] to [6]**  
selects a preset station in the radio source, and presets the current station. (Hold it down for more than 2 seconds.)

## Operation Flow

**1** Press **[SOURCE]** to select the radio source.

**2** Press **[BAND]** to select a band.

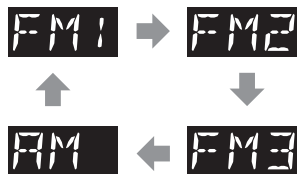

**3** Select a station.

### Frequency adjustment

**[TUNE <<<]**: Lower  
**[TUNE >>>]**: Higher

**Note:** Hold down for 0.5 sec. or more and release for station search.

### Preset station selection

Press the corresponding preset button from **[1]** to **[6]** to tune in a preset station.

Radio Source Display

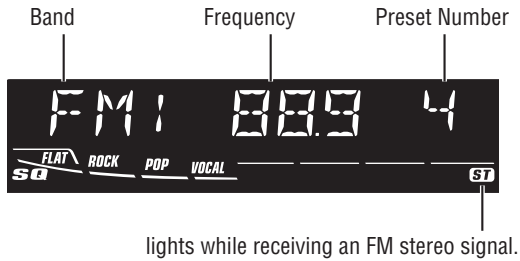

Display change

Press **[DISP]** to change the display.

Radio mode display (Default)

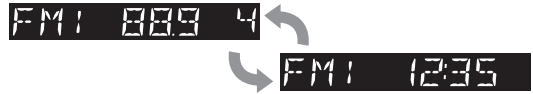

Clock display

Station Preset

Up to 6 stations can be preset in AM, FM1, FM2, and FM3 respectively. Preset stations can be simply called up by pressing **[1]** to **[6]**.

Auto Preset Memory (APM)

With this operation, stations with good receiving conditions can be automatically stored in the preset memory.

- 1 Select a band.
- 2 Hold down **[BAND] (APM)** for more than 2 seconds.  
The preset stations under best receiving conditions are received for 5 seconds each after presetting the stations (SCAN). To stop scanning, press one of the buttons from **[1]** to **[6]**.

**Note:** New stations overwrite existing saved stations.

Manual station preset

- 1 Tune into a station.
- 2 Hold down one of the preset buttons from **[1]** to **[6]** for more than 2 seconds.



**Note:** New stations overwrite existing saved stations.



# Audio Settings

**[VOL]** selects a value in the audio menu.  
**(PUSH SEL)** (Push to select) selects items in the audio menu.

**[DISP]** (Display) exits from the audio menu.



**1** Press **[VOL] (PUSH SEL)** to display the audio menu display.  
**Note:** If no operation takes place for more than 5 seconds in the audio menu (2 seconds in Main volume adjustment), the display returns to the regular mode.

**2** Press **[VOL] (PUSH SEL)** to select a mode to be adjusted.

**3** Turn **[VOL]** clockwise or counterclockwise to adjust.

Audio menu

**VOL 18** Volume  
 (Setting Range: 0 to 40, Default: 18)

**VOL 18**

①: Up  
 ②: Down

**BASS** Bass  
 (Setting Range: -12 dB to +12 dB by 2 dB, Default: 0 dB)

**BASS+ 6dB**

①: Increased  
 ②: Decreased

**TREBLE** Treble  
 (Setting Range: -12 dB to +12 dB by 2 dB, Default: 0 dB)

**TRE+ 6dB**

①: Increased  
 ②: Decreased

**BALANCE** Balance  
 (Setting Range: 15 levels each, Default CNT (center))

**BAL L 15**

①: Right enhanced  
 ②: Left enhanced

**FADER** Fader  
 (Setting Range: 15 levels each, Default CNT (center))

**FAD F 15**

①: Front enhanced  
 ②: Rear enhanced

**Notes:**

- If the fader is set to front, the pre-amp. output (rear) is decreased.
- For further information on SQ (Sound Quality) settings, refer to General.
- Settings of SQ, bass and treble are influenced one another. If such an influence causes distortion to the audio signal, readjust bass/treble or volume.

# Player (Disc Player)

## Disc slot

takes a disc in with the printed side facing up.

### Notes:

- The power will be turned on automatically when a disc is loaded.
- A disc which has both CD-DA data and MP3/WMA data on it may not be reproduced normally.

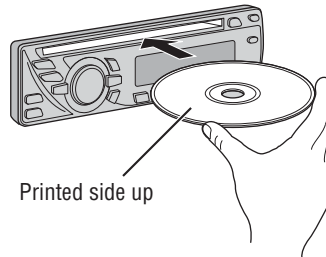

Printed side up

[▲] (Eject)  
ejects the disc.

[SOURCE] (Source)  
selects a source.

(▶||) (Play/Pause)  
toggles pause/play in the player source.

[DISP] (Display)  
switches the information on the display.

[◀◀] [▶▶]  
skip to the previous/next track/file in the player mode. Hold down either of them for fast reverse/fast forward.

[∨] [∧]  
skip to the previous/next folder.

[4] (RANDOM)/[5] (SCAN)/[6] (REPEAT)  
toggles on/off each play mode.  
[3] (SCROLL)  
scrolls the information on display.

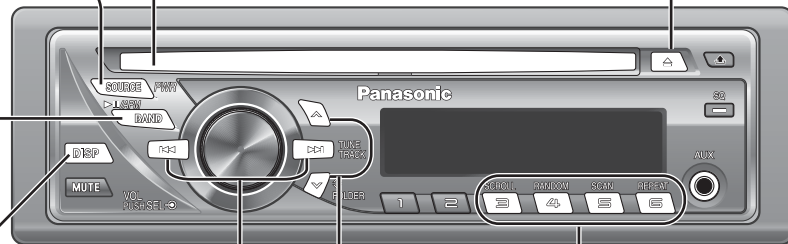

## ⚠ Caution

- Do not insert a disc when the **DISC** indicator lights.
- Refer to the section of "Notes on Discs" and "Notes on MP3/WMA".
- This unit does not support 8 cm {3"} discs.
- If you insert an 8 cm {3"} disc and cannot eject it, turn ACC of your car off once and turn it on again, then press [▲] (Eject).

- Do not insert foreign matter into the disc slot.

## Operation Flow

**1** Press [SOURCE] to select the Disc Player source.

**2** Select a desired portion.

### Track/file selection

Press [◀◀] / [▶▶].

**Note:** To perform fast forward/reverse, hold down either of them.

### Disc Player (CD-DA disc):

Previous/next track

### Disc Player (MP3/WMA disc):

Previous/next file

### Folder selection (MP3/WMA)

Press [∨] / [∧].

## Pause

Press [BAND] (▶||).

Press again to cancel.

### CD-DA mode display

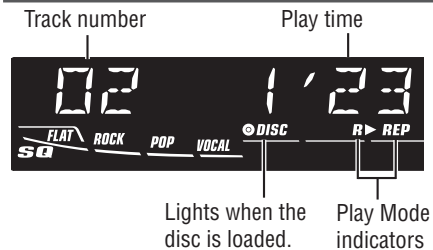

### MP3/WMA mode display

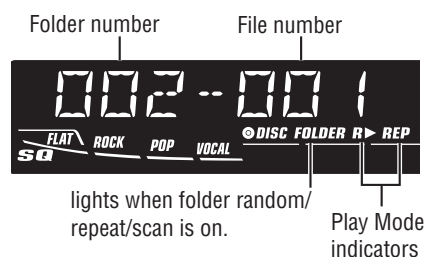

### Display change

Press **[DISP]** to change the display.

#### Disc Player (CD-DA disc):



#### Disc Player (MP3/WMA disc):

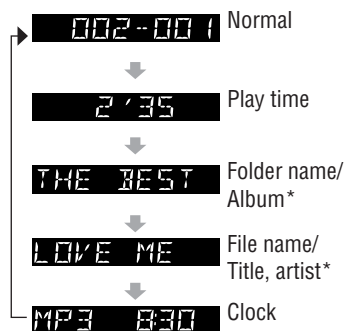

#### \*ID3/WMA Tag On/Off

Hold down **[3]** for more than 2 seconds.



↕ album title and song title/artist name are displayed.



folder name/file name are displayed.

#### Notes:

- For scrolling text, press **[3]** (**SCROLL**).
- "NO TEXT" is displayed when there is no information on the disc.

### Random play

All the available songs (tracks/files) are played in a random sequence.

Press **[4]** (**RANDOM**).  
Press again to cancel.

### Folder random play (MP3/WMA)

All the available files in current folder are played in a random sequence.

Hold down **[4]** (**RANDOM**) for more than 2 seconds.  
Hold down again to cancel.

### Repeat play

The current song (track/file) is repeated.

Press **[6]** (**REPEAT**).  
Press again to cancel.

### Folder repeat play (MP3/WMA)

The current folder is repeated.

Hold down **[6]** (**REPEAT**) for more than 2 seconds.  
Hold down again to cancel.

### Scan play

The first 10 seconds of each songs (tracks/files) is played in sequence.

Press **[5]** (**SCAN**).  
Press again to cancel.

### Folder scan play (MP3/WMA)

From the next folder, the first 10 seconds of the first file in each folder is played in sequence.

Hold down **[5]** (**SCAN**) for more than 2 seconds.  
Hold down again to cancel.

# Troubleshooting

## If You Suspect Something Wrong

Check and take steps as described below.

If the described suggestions do not solve the problem, it is recommended to take the unit to your nearest authorized Panasonic Servicenter. The product should be serviced only by qualified personnel. Please refer the checking and the repair to professionals. Panasonic shall not be liable for any accidents arising out of neglect of checking the unit or your own repair after your checking.

**Never take measures especially those other than indicated by *italic* letters in "Possible Solution" described below because those are too dangerous for users to handle themselves.**

Trouble	Possible Solution
<b>Common</b>	
<b>No power</b>	<ul style="list-style-type: none"> <li>• <i>Start the engine. (Or turn the ignition switch to the ACC position.)</i></li> <li>• Verify the wiring. (battery lead, power lead, ground lead, etc.)</li> <li>• Fuse blown (Contact the nearest Panasonic Servicenter.)</li> <li>• Ask a professional for fuse replacement.</li> <li>• Be sure to use the same rated fuse.</li> </ul>
<b>No sound</b>	<ul style="list-style-type: none"> <li>• <i>Disable the mute function.</i></li> <li>• Verify the wiring.</li> <li>• <i>Wait until the dew disappears before turning on the unit.</i></li> </ul>
<b>Noise</b>	<ul style="list-style-type: none"> <li>• Make sure that grounding is established properly.</li> </ul>
<b>No sound from left, right, front, or rear speaker</b>	<ul style="list-style-type: none"> <li>• <i>Adjust the balance and fader.</i></li> <li>• Verify the wiring.</li> </ul>
<b>Left and right sounds are reversed</b>	<ul style="list-style-type: none"> <li>• Connect the speaker lead correctly.</li> </ul>

<b>Disc Player</b>	
<b>No sound, or disc is automatically ejected</b>	<ul style="list-style-type: none"> <li>• <i>Load the disc correctly.</i></li> <li>• <i>Clean the disc.</i></li> </ul>
<b>Sound skip, poor sound quality</b>	<ul style="list-style-type: none"> <li>• <i>Clean the disc.</i></li> </ul>
<b>Sound skip due to vibration</b>	<ul style="list-style-type: none"> <li>• The maximum permissible tilt angle is 30°.</li> <li>• Secure the unit.</li> </ul>
<b>Disc not ejectable</b>	<ul style="list-style-type: none"> <li>• <i>Press [▲]. If the disc is still not ejected, contact the nearest Panasonic Servicenter.</i></li> </ul>

## ⚠ Warning

- Do not use the unit in an irregular condition, for example, without sound, or with smoke or a foul smell, which can cause ignition or electric shock. Immediately stop using the unit and consult your dealer.
- Never try to repair the unit by yourself because it is dangerous to do so.

Trouble	Possible Solution
<b>Radio</b>	
<b>Frequent noise</b>	<ul style="list-style-type: none"> <li>• <i>Tune in to another station of high-intensity waves.</i></li> <li>• Make sure that the antenna mounted point is grounded properly.</li> </ul>
<b>Preset data deleted</b>	<ul style="list-style-type: none"> <li>• <i>The preset memory is cleared to return to the original factory setting when the power connector or battery is disconnected.</i></li> </ul>

## Error Display Messages

<b>--E1--</b>	(The disc is ejected automatically.) The disc is dirty or upside down. • Check the disc.
<b>--E2--</b>	(The disc is ejected automatically.) The disc has scratches. • Check the disc.
<b>--E3--</b>	No operation by some cause. • If normal operation is not restored, consult your dealer or the nearest Servicenter to ask for repairs.
<b>--E4--</b>	Cannot read the file • Check the disc.
<b>--E5--</b>	A WMA file can be copyrighted. • The file protected by copyright is not playable.

# Specifications

## General

Power supply	: DC 12 V (11 V – 16 V DC), test voltage 14.4 V, negative ground
Current consumption	: Less than 2.1 A (CD mode; 0.5 W x 4 channels)
Maximum power output	: 50 W x 4 channels (at 1 kHz), volume control maximum
Tone adjustment range	: Bass: $\pm 12$ dB at 100 Hz, Treble: $\pm 12$ dB at 10 kHz
Speaker impedance	: 4 – 8 $\Omega$
Pre-amp output voltage	: 2.5 V (CD mode, 1 kHz, 0 dB)
Pre-amp output impedance	: 200 $\Omega$
Dimensions (W x H x D)	: 178 x 50 x 160 mm (7" x 1 15/16" x 6 2/16")
Weight	: 1.3 kg (2 lbs. 14 oz)
Front AUX input	
Input impedance	: 10 k $\Omega$
Allowable external input Connector	: 2.0 V 3.5 mm $\phi$ Stereo mini-pin

## Disc Player

Sampling frequency	: 8 times oversampling
DA converter	: 1 bit DAC System
Pick-up type	: Astigma 3-beam
Light source	: Semiconductor laser
Wave length	: 790 nm
Frequency response	: 20 Hz – 20 kHz ( $\pm 1$ dB)
Signal to noise ratio	: 96 dB
Total harmonic distortion	: 0.01 % (1 kHz)
Wow and flutter	: Below measurable limits
Channel separation	: 75 dB

## FM Stereo Radio

Frequency range	: 87.9 MHz – 107.9 MHz
Usable sensitivity	: 10.2 dBf. (0.9 $\mu$ V, 75 $\Omega$ )
50 dB quieting sensitivity	: 15.2 dBf. (1.6 $\mu$ V, 75 $\Omega$ )
Frequency response	: 30 Hz – 15 kHz ( $\pm 3$ dB)
Alternate channel selectivity	: 75 dB
Stereo separation	: 35 dB (1 kHz)
Image rejection ratio	: 55 dB
IF rejection ratio	: 100 dB
Signal/noise ratio	: 62 dB

## AM Radio

Frequency range	: 530 kHz – 1 710 kHz
Usable sensitivity	: 27 dB/ $\mu$ V (22 $\mu$ V, S/N 20 dB)

Above specifications comply with EIA standards.

Power Output:  
18 W RMS x 4 Channels at 4  $\Omega$  and  $\leq 1\%$  THD+N  
Signal to Noise Ratio:  
85 dBA (reference: 1 W into 4  $\Omega$ )



## Notes:

- Specifications and design are subject to modification without notice due to improvements.
- Some figures and illustrations in this manual may be different from your product.





## A WARNING/AVERTISSEMENT/ADVERTENCIA

This installation information is designed for professional installers with knowledge of automobile electrical safety systems and is not intended for non-technical, do-it-yourself individuals. It does not contain instructions on the electrical installation and avoidance of potential harm to air bag, anti-theft and ABS tracking or other systems necessary to install this product. Any attempt to install this product in a motor vehicle by anyone other than a professional installer could cause damage to the electrical safety system and could result in serious personal injury or death.

If your car is equipped with air bag and/or anti-theft systems, specific procedures may be required for connection and disconnection of the battery to install this product. Before attempting installation of this electronic component against the manufacturer's recommendation, you must contact your car dealer or manufacturer to determine the required procedure and strictly follow their instructions.

**FAILURE TO FOLLOW THE PROCEDURE MAY RESULT IN THE UNINTENDED DEPLOYMENT OF AIR BAGS OR ACTIVATION OF THE ANTI-THEFT SYSTEM RESULTING IN DAMAGE TO THE VEHICLE AND PERSONAL INJURY OR DEATH.**

Les informations concernant cette installation sont destinées aux techniciens professionnels, compétents dans le domaine des systèmes de sécurité pour automobiles et ne sont pas destinées aux bricoleurs ou aux dangers non professionnels. Elles ne contiennent pas d'instructions sur les installations électriques ni d'avertissements sur les dangers potentiels des coussins gonflables, des systèmes anti-vol et du système de freinage ABS ou autres systèmes, d'avertissement qui sont indispensables pour installer cet appareil. Toute tentative d'installer cet appareil dans un véhicule par une personne autre qu'un installateur professionnel pourrait endommager le système de sécurité électrique, et pourrait provoquer des blessures physiques graves, voire la mort.

Si votre voiture est équipée de coussins gonflables et/ou d'un système anti-vol, des procédures spécifiques sont parfois requises pour la connexion et la déconnexion de la batterie pour installer cet appareil. Avant de tenter malgré tout l'installation de ce composant électronique contraire aux recommandations du fabricant, vous devez prendre contact avec votre revendeur ou votre constructeur automobile pour déterminer la procédure requise et vous conformer strictement à leurs instructions.

**LE FAIT DE NE PAS SUIVRE CETTE PROCÉDURE PEUT PROVOQUER UN DÉPLOIEMENT DES COUSSINS GONFLABLES OU L'ACTIVATION DU SYSTÈME ANTI-VOL POUVANT ENDOMMAGER LE VÉHICULE OU PROVOQUER DES BLESSURES PHYSIQUES, VOIRE LA MORT.**

La información de instalación va dirigida a instaladores profesionales con conocimientos de los sistemas de seguridad eléctricos de los automóviles y no se ha preparado para individuos sin conocimientos técnicos. No contiene instrucciones sobre la instalación eléctrica ni advertencias relacionadas con los posibles daños en los airbag, sistema anti-robo y de frenos ABS, ni otros sistemas, que pueden causarse al intentar instalar este producto. Cualquier intento de instalar este producto en un vehículo motorizado por parte de una persona que no sea un instalador cualificado podrá causar daños en los sistemas eléctricos de seguridad, pudiendo causar heridas graves o incluso la muerte.

Si su automóvil está provisto de sistemas de airbags y/o anti-robo, pueden resultar necesarios unos procedimientos específicos para conectar y desconectar la batería a fin de instalar este producto. Antes de intentar instalar este componente electrónico en contra a las recomendaciones del fabricante, deberá ponerse en contacto con el concesionario o fabricante de su automóvil para determinar el procedimiento requerido y deberá seguir estrictamente sus instrucciones.

**SI NO SIGUE EL PROCEDIMIENTO INDICADO PUEDE RESULTAR EN QUE SE INFLIEN ACCIDENTALMENTE LOS AIRBAG O SE ACTIVE EL SISTEMA ANTI-ROBO, RESULTANDO EN DAÑOS EN EL VEHÍCULO Y HACIÉNDOLE CORRER EL PELIGRO DE HERIDAS PERSONALES O DE MUERTE.**

## Before Installation/Avant l'installation/ Antes de la Instalación

### Consult a professional for installation.

- Verify the radio using the antenna and speakers before installation.

**Prenez contact avec un spécialiste pour le montage.**  
Vérifiez l'autoradio avant de procéder au montage.

### Para realizar la instalación consulte a un profesional.

- Verifique el funcionamiento de la radio empleando la antena y los altavoces antes de realizar la instalación.

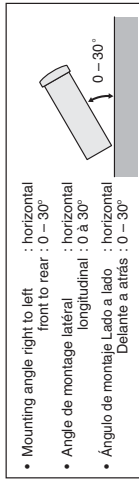

## Dashboard/Tableau de bord/Tableiro de instrument

**THICKNESS/ÉPAISSEUR/GROSOR**  
MIN. 4.75 mm (3/16") (3/16 po) (3/16")  
MAX. 5.56 mm (7/32") (7/32 po) (7/32")

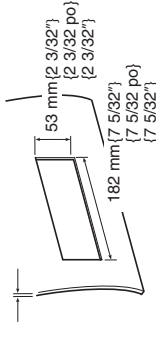

# Panasonic®

WMA MP3 CD Player/Receiver  
Récepteur/lecteur CD avec lecture WMA/MP3  
Reproductor de CD, WMA y MP3/receptor

Model: **CQ-C1335U/C1305U**  
**CQ-C1335L/C1305L**



(CQ-C1335U)



WMA

MP3

- Please read these instructions carefully before using this product and keep this manual for future reference.
- Prière de lire ces instructions attentivement avant d'utiliser le produit et garder ce manuel pour l'utilisation ultérieure.
- Lea con atención estas instrucciones antes de utilizar el producto y guarde este manual para poderlo consultar en el futuro.

## Supplied Hardware/Matériel d'installation/Accesorios suministrados

No.	Item	Diagram	Qty	No.	Item	Diagram	Qty
①	Mounting Collar Cadre de montage Collar de montaje		1	④	Lock Cancel Plate Plaque antibloqueo Placa de cancelación de bloqueo		2
②	Power Connector Connecteur d'alimentation Conector de alimentación		1	⑤	Mounting Bolt (5 mm φ) Boulon de fixation (5 mm φ) Perno de montaje (5 mm φ)		1
③	Trim Plate Plaque de garniture Placa de guarnición		1	⑥	Rubber Bushing Bague en caoutchouc Buje de goma		1

- Notes:**
- The number in parentheses underneath each accessory part name is the part number for maintenance and service.
  - Los números que aparecen entre paréntesis debajo del nombre de cada accesorio son los números de pieza para fines de mantenimiento y servicio técnico.
  - Los accesorios y sus números de pieza están sujetos a modificaciones, sin previo aviso por razones de mejora del producto.
  - Le coller de montage y la plaque de garniture se montan en la unidad principal al salir de fábrica.
- Remarks:**
- Le nombre entre parenthèses au-dessous du nom de chaque accessoire représente la référence de la pièce pour l'entretien et la réparation.
  - Les accessoires et leurs références sont sujets à changement sans préavis en vue de l'amélioration.
  - Le cadre de montage et la plaque de garniture sont montés sur l'appareil principal lors de l'expédition.

**Notes:**

- The number in parentheses underneath each accessory part name is the part number for maintenance and service.
- Los números que aparecen entre paréntesis debajo del nombre de cada accesorio son los números de pieza para fines de mantenimiento y servicio técnico.
- Los accesorios y sus números de pieza están sujetos a modificaciones, sin previo aviso por razones de mejora del producto.
- El collar de montaje y la placa de guarnición se montan en la unidad principal al salir de fábrica.

**Panasonic Consumer Electronics Company, Division of Panasonic Corporation of North America**  
New Jersey 07094  
http://www.panasonic.com

**Panasonic Sales Company, Division of Panasonic Rico, Inc. (PSC)**  
Ave. 65 de Ingeniería, Km. 9.5  
San Gabriel Industrial Park,  
Carolina, Puerto Rico 00985  
http://www.panasonic.com

YEFM294287 FT1006-0

Printed in China  
Imprimé en Chine  
Impreso en China

## Matsushita Electric Industrial Co., Ltd.

Web Site: http://panasonic.net

©2006 Matsushita Electric Industrial Co., Ltd. All Rights Reserved.

# Installation/Montage/Instalación

## How to install the unit/Mode de montage de l'appareil/Instalación de la unidad

- ⚠ Caution**
  - Wear gloves for safety.
  - Make sure that wiring is completed before installation.
- ⚠ Précaution**
  - Portez des gants à des fins de sécurité.
  - Assurez-vous que le câblage est terminé avant l'installation.
- ⚠ Precaución**
  - Utilice guantes para mayor seguridad.
  - Asegúrese de haber completado todas las conexiones eléctricas antes de realizar la instalación.

- Remove the cable from the battery negative terminal.  
Retirez le câble de la borne négative de la batterie.  
Extraiga el cable del terminal negativo de la batería.
- Mounting collar ① insertion. Bend mounting tabs of fixation.  
Inserción del collar de montaje ①. Doble las lengüetas de montaje.
- Connection of power connector ②.  
Raccordement du connecteur d'alimentation ②.  
Conexión del conector de alimentación ②.

Bend appropriate tabs to secure the unit without backlash.  
Repliez les languettes de fixation appropriées pour immobiliser l'appareil sans contrecoup.  
Doble las lengüetas apropiadas para fijar la unidad sin contragolpe.

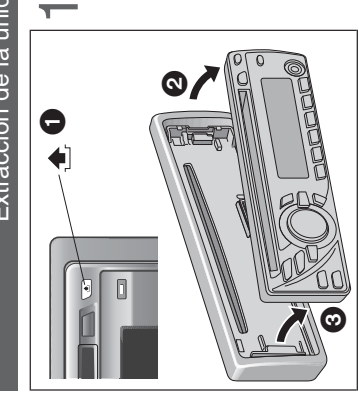

**1** Remove the face plate.  
Retirez le panneau avant.  
Extraiga el panel frontal.

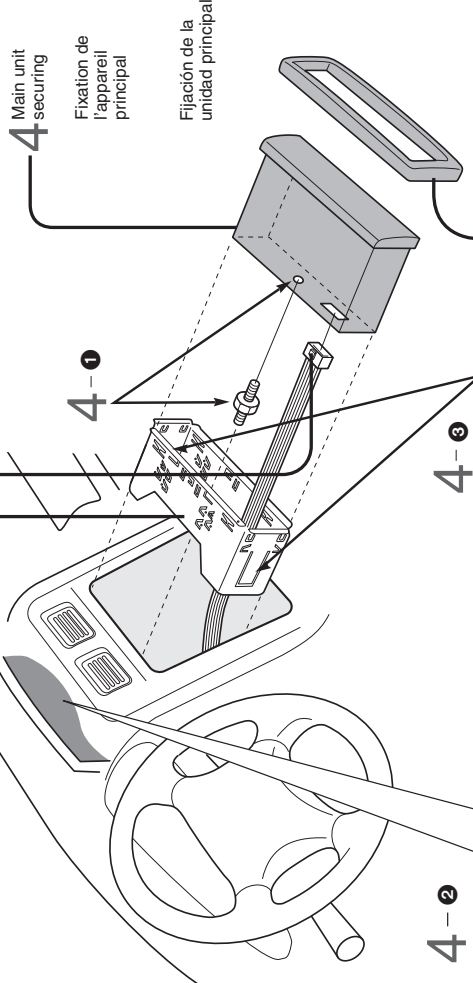

- Screw the mounting bolt ⑤ into the main unit.
- Secure to the fire wall.
- Snap the right and left springs into each hole.
- Visser le boulon de fixation ⑤ dans l'appareil principal.
- Fixez au tablier.
- Engager les ressorts gauche et droit dans chaque trou.
- Encosque el perno de montaje ⑤ en la unidad principal.
- Fijelo a la pantalla cortafuegos.
- Acople los resortes derecho e izquierdo en cada orificio.

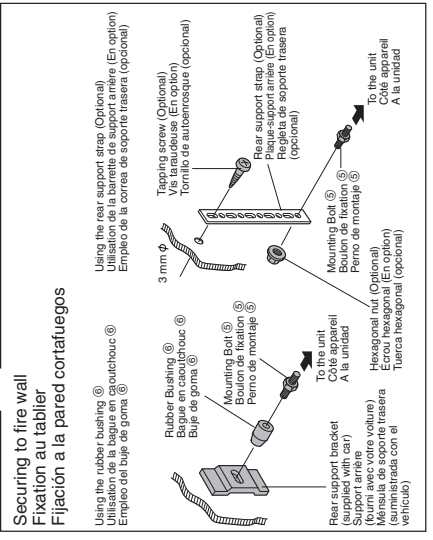

**⚠ Caution**  
When this unit is installed in dashboard, ensure that there is sufficient air flow around the unit to prevent damage from overheating, do not block any ventilation holes on the unit.

**⚠ Précaution**  
Lorsque cet appareil est installé dans le tableau de bord, assurez-vous qu'il y a une circulation d'air suffisante autour de l'appareil afin d'éviter tout endommagement provoqué par une surchauffe et qu'aucun trou d'aération de l'appareil n'est obturé.

**⚠ Precaución**  
Cuando instale esta unidad en el tablero de instrumentos, asegúrese de que haya suficiente ventilación de aire en torno a la unidad para evitar daños debidos al sobrecalentamiento, y no obstruya ningún orificio de ventilación de la unidad.

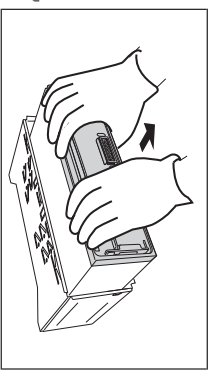
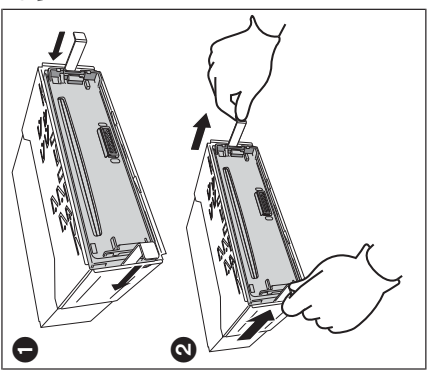
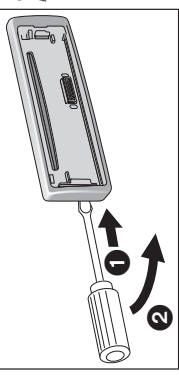

**1** Remove the face plate.  
Retirez le panneau avant.  
Extraiga el panel frontal.

**2** Remove the trim plate ③.  
Enlevez la plaque de garniture ③.  
Extraiga la placa de guarnición ③.

**3** Lock release  
① insert the lock cancel plate  
② until you hear a click.  
③ Pull the main unit.

Liberation du verrouillage  
① Introduisez la plaque antiblocage ① jusqu'à entendre un clic.  
② Dégager l'appareil principal.

**Desbloqueo**  
① Inserte la placa de cancelación de bloqueo ① hasta oír un sonido seco de confirmación.  
② Tire de la unidad principal.

**4** Pull out the unit with both hands.  
Retirez l'appareil à deux mains.  
Extraiga la unidad con ambas manos.

# Wiring/Câblage/Conexiones eléctricas

## ⚠ Caution

To prevent damage to the unit, do not connect the power connector until the whole wiring is completed.

## ⚠ Précaution

Ne raccordez pas le connecteur d'alimentation sur l'appareil avant d'avoir effectué tous les raccordements pour éviter d'endommager l'appareil.

## ⚠ Precaución

Para evitar daños en la unidad, no conecte el conector de alimentación hasta haber completado todas las conexiones.

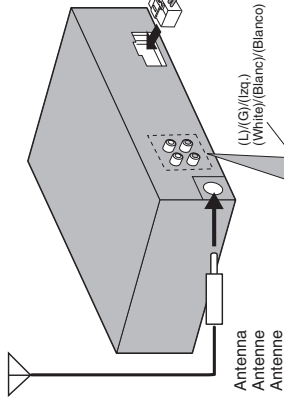

**Fuse (15 A)** Refer fuse replacement to your nearest authorized Panasonic Servicenter. Do not try fuse replacement by yourself.  
**Fusible (15 A)** Consultez le remplacement de fusible au centre de service après-vente Panasonic agréé le plus proche. N'essayez pas de remplacer le fusible tout(e) seul(e).  
**Fusible (15 A)** Consulte el remplazo del fusible al centro de servicio Panasonic autorizado que le quede más cerca. No trate de reemplazar usted mismo el fusible.

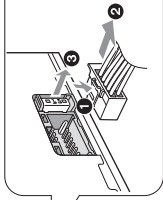

(Red)/(Rouge)/(Rojo)

**Power Lead** (ACC or IGN) To ACC power, +12V DC.  
**Fil de mise à la masse** A la batterie A l'alimentation ACC, +12 V CC.  
**Cable de la alimentación** (ACC o IGN) A la alimentación de ACC, +12 V CC.

(Black)/(Noir)/(Negro)

**Ground Lead** To a clean, bare metallic part of the car chassis.  
**Fil de mise à la masse** A une partie métallique propre découverte du châssis de voiture.  
**Cable de toma de tierra** A una parte metálica limpia y desnuda del chasis del vehículo.

(Yellow)/(Jaune)/(Amarillo)

**Battery Lead** To the car battery, continuous +12 V DC.  
**Fil de batterie** A la batterie de voiture, alimentation continue de +12 V CC.  
**Cable de la batería** A la batería del vehículo, +12 V CC continuo.

(Blue w/white stripe)/(Bleu rayé blanc)/(Azul con franja blanca)

**External Amplifier Control Lead** To an external amplifier. (Max 100 mA) (synchronized with the power on/off of amplifier)  
**Motor Antenna Relay Control Lead** To Motor Antenna. (Max 100 mA) (This lead is not intended for use with a switch actuated power antenna).  
**Fil de commandes de l'amplificateur externe A** l'amplificateur de puissance Panasonic. (100 mA max.) (synchronisé avec l'application ou la coupure d'alimentation de l'amplificateur)  
**Fil de commandes de l'antenne A** l'antenne motorisée. (100 mA max.) (Ce fil n'est pas conçu pour l'usage avec une antenne commandée par interrupteur).  
**Cable de control del amplificador externo A** amplificador de potencia Panasonic. (Máx. 100 mA) (sincronizado con la conmutación de conexión del amplificador)  
**Cable de control de la antena A** la antena de motor. (Máx. 100 mA) (Este cable no está diseñado para ser utilizado con una antena de alimentación accionada mediante interruptor).

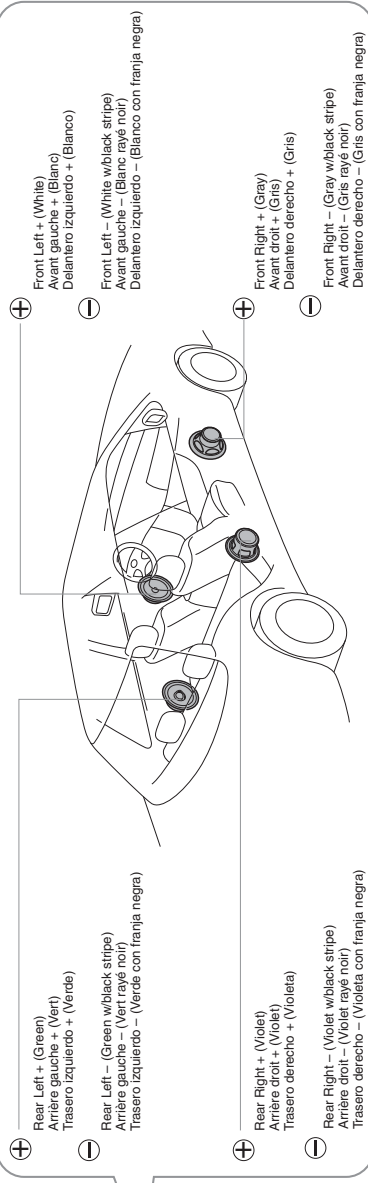

**CC-C1335U CC-C1335L**  
 Preamp Out Connector (Front)  
 Connecteur de sortie de préamplificateur (Avant)  
 Conector de salida de preamplificador (Frontal)

## Final Installation/Installation finale/ Instalación final

### Lead Connections

Connect all wires, making sure that each connection is insulated and secure. Bundle all loose wires and fasten them with tape so they will not fall down later. Now insert the unit into the mounting collar. Congratulations! After making a few final checks, you're ready to enjoy your new auto stereo system.

**Câblage**  
Raccordez tous les fils en prenant soin qu'ils soient tous bien isolés et solidement connectés. Enroulez toute longueur excessive de fil et fixez-la en place avec une ruban adhésive. Installez l'appareil dans son collier de montage.  
Félicitations! Après avoir effectué quelques vérifications finales, vous êtes prêt à profiter pleinement de votre nouveau système autoradio.

**Conexiones de cables**  
Conecte todos los cables, asegurándose de que cada conexión queda aislada y segura. Agrupe todos los cables sueltos y fíjelos con cinta para que no queden colgando. Inserte entonces la unidad en el collier de montaje.  
¡Enhorabuena! Después de realizar algunas comprobaciones finales, estará preparado para disfrutar de su nuevo sistema estéreo para automóvil.

## Final Check/Vérifications finales/ Comprobación final

1. Make sure that all wires are properly connected and insulated.
2. Make sure that the main unit is securely held in the mounting collar.
3. Turn on the ignition to check the unit for proper operation.

If you have difficulties, consult your nearest authorized professional installer for assistance.

1. Assurez-vous que tous les fils sont bien raccordés et isolés.
2. Assurez-vous que l'appareil est solidement en place dans son collier de montage.
3. Faites démarrer la voiture et vérifiez le fonctionnement de l'appareil.

En cas de difficulté, consultez un installateur professionnel.

1. Asegúrese de que todos los cables estén correctamente conectados y aislados.
2. Asegúrese de que la unidad principal quede fijada con seguridad en el collier de montaje.
3. Conecte el encendido para comprobar el correcto funcionamiento de la unidad.

Si tiene alguna dificultad, consulte al instalador profesional que le quede más cerca para que le ayude.

## Speaker Connection/Raccordement avec les haut-parleurs/Conexión de los altavoces

Connect as follows.

Raccordez les haut-parleurs comme suit.  
Conecte de la forma siguiente.

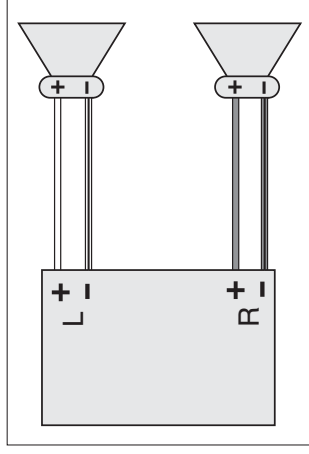

- Use ungrounded speakers only.  
Allowable input: 50 W or more  
Impedance: 4 – 8  $\Omega$
- Use of speakers which do not match the specifications can cause burning, smoking or damage of the speakers.
- Distance between speaker and amplifier: 30 cm {12"} or more
- Utilisez uniquement des haut-parleurs non reliés à la masse.  
Puissance d'entrée admissible: 50 W ou davantage  
Impédance: 4 – 8  $\Omega$
- L'utilisation de haut-parleurs qui ne correspondent pas aux caractéristiques techniques adéquates peut provoquer un dégagement de fumée, l'inflammation ou l'endommagement des haut-parleurs.
- Distance entre le haut-parleur et l'amplificateur: 30 cm {12 po} ou davantage

- Emplee solamente altavoces sin toma de tierra.  
Entrada permisible: 50 W o más  
Impedancia: 4 – 8  $\Omega$

**La utilización de altavoces que no cumplan con las especificaciones indicadas puede hacer que los altavoces se quemen, echen humo o sufran daños.**

- Distancia entre el altavoz y el amplificador: 30 cm {12"} o más

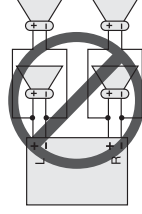

### ⚠ Caution

- Do not connect more than one speaker to one set of speaker leads, (except for connecting to a tweeter)

### ⚠ Précaution

- Ne raccordez pas plus d'un haut-parleur à un ensemble de fils de haut-parleur. (Sauf lors du raccordement à un haut-parleur d'aigus)

### ⚠ Precaución

- No conecte más de un altavoz a un juego de cables de altavoz. (excepto para la conexión a un altavoz de agudos)

- Do not use a 3-wire type speaker system having a common earth lead.

- N'utilisez pas de système de haut-parleur de type à 3 fils ayant un fil de mise à la masse commun.

- No emplee sistemas de altavoz del tipo de 3 cables con cable de masa común.