

JVC

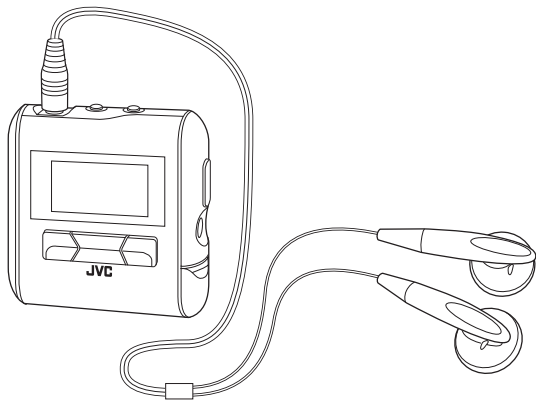

DIGITAL AUDIO PLAYER

XA-MP52B/R **XA-MP102A/W**



INSTRUCTIONS

Thank you for purchasing this JVC product.

Please read these instructions carefully before starting operation to be sure to obtain optimum performance and a longer service life from the unit.

LVT1510-002A
[B, US]

CAUTIONS

CAUTION:

- Do not place any naked flame sources, such as lighted candles, on the apparatus.
- When discarding batteries, environmental problems must be considered and local rules or laws governing the disposal of these batteries must be followed strictly.
- Do not expose this apparatus to rain, moisture, dripping or splashing.

Dry cell batteries

To prevent damage to the batteries and electrolyte leakage, heed the following points.

- Align the \oplus and \ominus polarities properly when inserting the battery.
- Remove the battery if you do not plan to use the player for a long period of time.
- Do not throw batteries into a fire, and do not short-circuit, disassemble or subject them to excessive heat.
- Do not attempt to recharge dry cell batteries.

Carrying dry cell batteries around

When putting dry cell batteries in a pocket or bag, ensure that no other metal objects such as a necklace are placed together with them. Contact with any metal may cause short-circuiting which may cause a fire.

Listening precautions

- Do not play your Headphones at a high volume.
- Hearing experts advise against continuous extended play.
- If you experience a ringing in your ears, reduce volume or discontinue use.
- Do not use while operating a motorized vehicle. It may create traffic hazard and is illegal in many areas.
- You should use extreme caution or temporarily discontinue use in potentially hazardous situations.
- Even if your Headphones are an open-air type designed to let you hear outside sounds, do not turn up the volume so high that you cannot hear what is around you.
- Once you have established a comfortable sound level, leave the level there.

Player

- **No altering or remodeling**

This can cause malfunctioning.

- **No dropping or strong impacts**

This may damage the player.

- **Locations to be avoided**

Avoid using the player in the following locations since they can cause malfunctioning.

1. Bathrooms and other moisture-prone places
2. Warehouses and other dusty places
3. Very hot places near heating appliances, etc.

CAUTIONS

Do not leave the player exposed to direct sunlight for long periods of time

This may deform or discolor the player and may also cause malfunctioning.

- **We have no responsibility for any improper recording or playback incurred by equipment malfunction.**
- **It is recommended to store backup copy of your important data in your PC or the like.**

TABLE OF CONTENTS

CAUTIONS	2
TABLE OF CONTENTS	5
GETTING STARTED	6
INSTALLING BATTERY	6
INSTALLING USB DRIVER (FOR WINDOWS 98SE ONLY)	7
CONNECTING TO PC	8
PARTS OF THE DIGITAL AUDIO PLAYER	10
TURNING POWER ON/OFF	11
DISPLAY OVERVIEW	12
BASIC OPERATIONS	13
USING THE MAIN MENU	13
PLAYING MUSIC	14
RECORDING MUSIC FROM EXTERNAL AUDIO EQUIPMENT IN LINE-IN MODE	16
DELETING FILES	18
ADVANCED FEATURES	19
SET MENU ITEMS	19
EQUALIZER	20
PLAYMODE	22
SLEEP TIMER	23
AUTO POWER OFF	24
BACKLIGHT	25
CONTRAST	26
RECORD SET	27
MENU LANGUAGES	29
FONTS	30
ABOUT	31
RESETTING THE UNIT	32
NAVIGATE	33
LOCKING BUTTONS (HOLD)	35
TROUBLESHOOTING	36
SPECIFICATIONS	37
ACCESSORIES	38

GETTING STARTED

INSTALLING BATTERY

Remove the battery compartment cover and insert one LR03 (AAA) alkaline battery (not supplied) matching the polarities (+ and -) indicated on the rear side of the player, then replace the compartment cover.

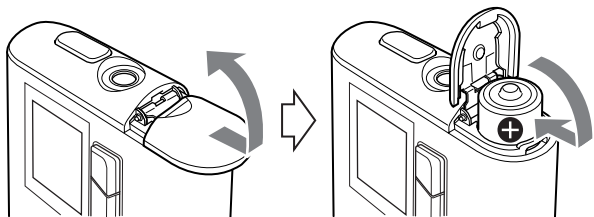

Battery indicator

The battery indicator shows the remaining battery level. When the battery level becomes low, “Low Battery” appears on the display. In this case, you need to replace the battery with a new one.

Low Battery

Important Battery Information

- Dispose of batteries in the proper manner, according to federal, state, and local regulations.
- Discard leaky batteries immediately. They can cause skin burn or other personal injury.
- Use only alkaline batteries. Do not use manganese dioxide batteries or a charger since the battery life becomes extremely short or the player may malfunction.

INSTALLING USB DRIVER (FOR WINDOWS 98SE ONLY)

Follow these instructions to load software that enables a computer to recognize the Digital Audio Player.

Make sure that no programs, such as games or anti-virus software, are running on the PC. If programs are open, close and exit from the programs before proceeding.

- 1.** Insert the CD-ROM into the CD-ROM drive of your PC.
- 2.** Turn off the Digital Audio Player and connect it to your PC with the USB connector.
- 3.** Follow the on-screen instructions to install the driver from the CD-ROM.
On a screen to search for the location of the Digital Audio Player's driver, click the [Browse] button and select the CD-ROM drive and then proceed to the next screen:
- 4.** Be sure that the installation completion screen appears.
- 5.** Reboot the PC.

CONNECTING TO PC

You can transfer MP3 and WMA format music files from the PC to your Digital Audio Player through USB port.

For Windows 98SE user:

Before connecting your player to the computer for the first time, you need to install the USB driver from the supplied CD-ROM into your computer. For details, see "INSTALLING USB DRIVER" on page 7.

Connecting Digital Audio Player to PC

1. Open the rubber cap of the USB connector.
2. Connect the player to the USB port on your PC using USB cable.

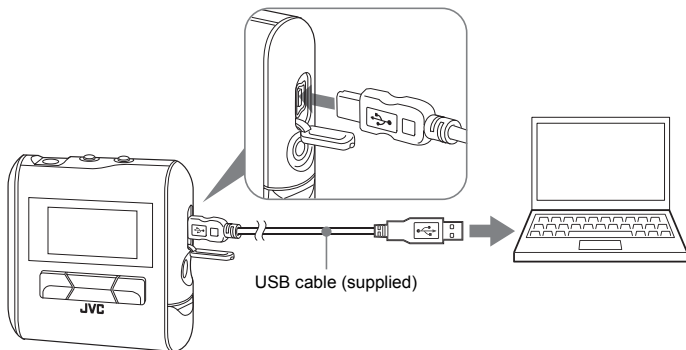

Transferring music files from PC to Digital Audio Player

1. Open the player's folder (removable disk or device) from My Computer or Explorer.
2. Copy and paste or drag and drop the music files from the PC to the player's folder. During copying files, "WRITING" appears on the player's display. After completion, "READY" continuously appears.

NOTE

- When you transfer a WMA-DRM file from the PC, use Windows Media® Player 9 or later. If you transfer it by drag and drop, it cannot be played with the player.

Disconnecting from PC**For Windows 2000/Me/XP users:**

Left-click the  icon in the task bar, and follow the on-screen instructions.

For Windows 98SE users

Open “My Computer” and select “Removable Disk”, then right-click to select “EJECT”.

- Microsoft, Windows and Windows Media are either trademarks or registered trademarks of Microsoft Corporation in the United States and other countries.
- Other names of systems and products mentioned in these instructions are usually registered trademarks of the manufacturers who developed the system or product concerned.

NOTES

- The player supports MP3 ID3 V1.0, 1.1 tags, ID3 V2.3 tags and WMA tags. ID3 tags and WMA tags are the data including music names and artist names recorded in MP3 files and WMA files.
- When the player is connected to the PC, it is recognized as an external USB memory (removal disk) and shown on the PC. You can treat the player as an external USB memory.

PARTS OF THE DIGITAL AUDIO PLAYER

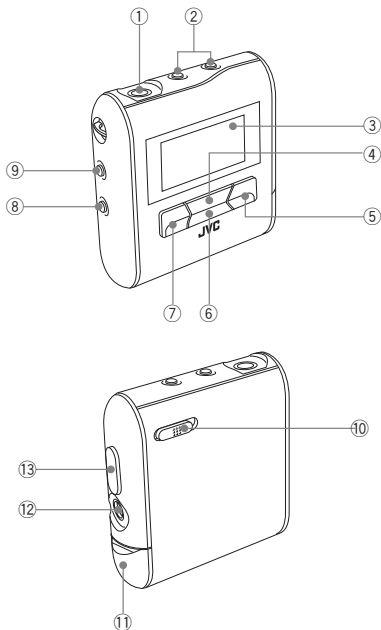

- | | |
|----------------------------------|-----------------------------|
| ① Headphone jack | ⑧ REC button |
| ② VOL+/- (Volume) buttons | ⑨ MENU button |
| ③ Display | ⑩ Hold switch |
| ④ ▶/ (Play/Pause) button | ⑪ Battery compartment cover |
| ⑤ ▶▶ (Forward) button | ⑫ Line input jack |
| ⑥ ■ (Stop) button | ⑬ USB connector |
| ⑦ ◀◀ (Reverse) button | |

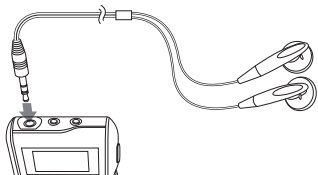

Connect the headphones to the  (headphones) jack on the player.

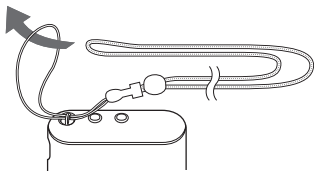

You can use the neck strap for easy carrying.

TURNING POWER ON/OFF

To turn power ON

Press and hold  button till “welcome” appears. After a while, the following screen appears.

DIGITAL
AUDIO
PLAYER

To turn power OFF

Press and hold  (Stop) button.

SEE YOU

NOTES

- When the player is turned on, it resumes the mode it was in when it was last turned off.
- The settings you have made are stored in the player when you turn off the player. (If you remove the battery before turning off the player, these settings are not stored.) It is recommended to turn off the player once when you change the setting.

DISPLAY OVERVIEW

MUSIC mode

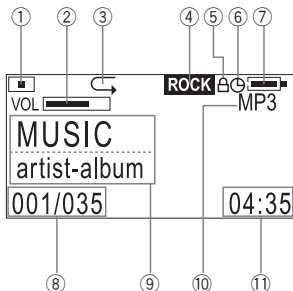

- ① Play indicator
- ② Volume level
- ③ Play mode indicator
- ④ EQ (sound mode)
- ⑤ Lock icon
- ⑥ Sleep Timer icon
- ⑦ Battery indicator
- ⑧ Track number/Total number of tracks
- ⑨ File information*
- ⑩ Mode indicator
- ⑪ Track time

* If the file information is long and displayed over two lines, it scrolls. During scrolling, the file name may not be correctly displayed.

BASIC OPERATIONS

USING THE MAIN MENU

There are number of modes you can operate using MAIN MENU.



Types of modes



MUSIC mode

Select to play music. (See page 14.)



LINE IN mode

Select to record music (MP3 file) from external audio equipment. (See page 16.)



SET mode

Select to set advanced settings. (See pages 19 to 30.)



DELETE mode

Select to delete files. (See page 18.)



ABOUT mode

Select to display about the player. (See page 31.)



RESET mode

Select to reset the settings you have made. (See page 32.)



NAVIGATE mode

Select to easily search for the desired music. (See page 33.)

PLAYING MUSIC

You can play the music files.

Before playing music, adjust the volume level with the volume +/- buttons.

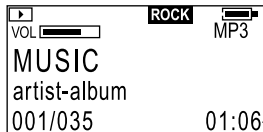

Track time (in stop mode)
Playback time (during playing)

To play music

1. After turning on the player, press **MENU** button and **▶▶| / |◀◀** button to select **MUSIC** mode from Main Menu, and then press **▶/||** button to enter that mode.
2. Press **▶/||** button
To stop: Press **■** button.
To pause: Press **▶/||** button.

To select track:

During playback or in stop mode, press **▶▶| / |◀◀** button.

To fast-forward/reverse track:

During playback, press and hold **▶▶| / |◀◀** button.

To exit MUSIC mode: Press **MENU** button.

NOTES

- If no audio files are stored, “NO FILES” appears.
- When the player is turned off in stop mode or during playback and then turned on again, it will resume playback from the beginning of the track lastly played when you start playback.
- The menu mode returns to the previous display before this menu is displayed if no operation is made for approx. 10 seconds.
- When the track reaches the WMA-DRM file which was transferred using the Copy & Paste during playback, “DRM PROTECTED” appears and the file is skipped over to the next track.

RECORDING MUSIC FROM EXTERNAL AUDIO EQUIPMENT IN LINE-IN MODE

You can record the music played back on external audio equipment. Make sure that the audio cable is connected between the LINE IN terminal of this audio player and the external audio equipment.

RECORD:REC
CANCEL:MENU

To record music from external audio equipment

1. After turning on the player, press **MENU** button and **▶▶| / |◀◀** button to select **LINE IN** mode from Main menu, and then press **▶/||** button to enter that mode.
2. Press and hold **REC** button until "Recording" appears.
The player is paused (the counter is stopped).
3. Play the music source on the external audio equipment.
The player automatically detects the sound, starts recording of the music and numbers each track.
The default recording setting is as follows. Bit rate: 128kbps, A.TRK: ON. For details, See pages 27 to 28.

To stop: Press **■** button.

To exit LINE IN mode: Press **MENU** button.

NOTES

- The “LINE” folder is automatically generated, the recorded music files are stored in it as MP3 files. The “LINE” folder can be displayed using NAVIGATE mode. (See page 33.)
- If “LOW BATTERY” appears when you press and hold **REC** button, it is recommended to replace the battery with a new one.
- The player consumes an enormous amount of power for recording the music stored in the external audio equipment. To prevent malfunction due to low battery, the player is designed to stop faster in this mode. It is recommended to use a new battery if you continue to record the music for many hours in this mode.
- **AUTO LEVEL CONTROL (ALC)**
 - The player is equipped with Auto Level Control (ALC) to control distortion during recording. When the output level from external audio equipment is too high, the ALC automatically activates to control the recording level, which can reduce distortion.
 - When you perform test recording beforehand or check and control the output level by inserting the headphone to the jack of the player during recording, more proper level setting can be obtained.
- The recorded files can be copied to the computer connected to the player by USB.

DELETING FILES



(DELETE submenu)

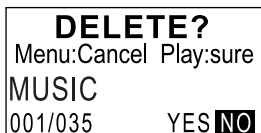

(File deletion)

To delete files

1. After turning on the player, press **MENU** button and **▶▶/◀◀** button to select **DELETE** mode from Main Menu, and then press **▶/||** button to enter that mode.
2. Press **▶▶/◀◀** button to select types of files you want to delete from the DELETE menu.
3. Press **▶/||** button.
4. Press **▶▶/◀◀** button to select a file you want to delete.
5. Press **■** button to select "YES".
To cancel the operation, select "NO".
6. Press **▶/||** button to delete the file.
"File Deleted" appears. If you try to delete a read-only file, "Operation Failed" appears.
(Each time you press **■** button, the status switches between "YES" and "NO".)

To return to DELETE menu: Press **MENU** button once.

To exit DELETE mode:

Press **MENU** button again (or select "EXIT" and press **▶/||** button in DELETE submenu).

NOTE

- When all files in a folder are deleted, the folder disappears from the player. However, it is not erased and remains in the player. You can erase this folder by PC through USB.

ADVANCED FEATURES

SET MENU ITEMS

In **SET** mode, you can set the following SET MENU items:
EQ SET (Equalization Set), PLAYMODE, SLEEP TIMER, A.POWER OFF (Auto Power OFF), BACKLIGHT, CONTRAST, RECORD SET, MENU LANG (Menu Language) and FONTS
To set each item, see the relevant later page.

EQUALIZER

You can select from one of 6 different preset sound modes or one customized sound mode.

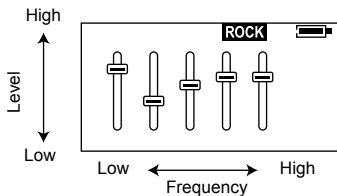

Types of sound modes

NORM**NORMAL**

No sound effect applies.

CLASS**CLASSICAL**

Good for classical music

JAZZ**JAZZ**

Good for jazz music

ROCK**ROCK**

Boosts low and high frequency.

POP**POP**

Good for vocal music

BASS**BASS**

Empowers bass sound.

CUST**CUSTOMIZED**

You can create your own sound mode.

To select sound mode

1. After turning on the player, press **MENU** button and ►► / ◀◀ button to select **SET** mode from Main Menu, and then press ► / || button to enter that mode.
2. Press ►► / ◀◀ button to select "EQ SET".
3. Press ► / || button.
4. Press ►► / ◀◀ button to select the sound mode.
5. Press ► / || button to return to SET MENU.

To create sound mode (CUST)

1. After turning on the player, press **MENU** button and ►► / ◀◀ button to select **SET** mode from Main Menu, and then press ► / || button to enter that mode.
2. Press ►► / ◀◀ button to select "EQ SET".
3. Press ► / || button.
4. Press ►► / ◀◀ button to select "CUST".
5. Press **MENU** button briefly to start editing.
The indicator of the lowest frequency is highlighted.
6. Press ►► / ◀◀ button to select the frequency you want to edit.
7. Press ► / || button.
The indicator starts to blink.
8. Press ►► / ◀◀ button to set the level up or down and then press ► / || button to store it.
9. Repeat Steps 6 through 8 to edit for other frequencies.
10. Press **MENU** button briefly. The highlight disappears and the setting is completed.
11. Press ► / || button to return to SET MENU.

To exit SET mode:





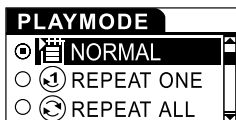

Press **MENU** button (or select "EXIT" and press ► / || button) in the SET MENU.

PLAYMODE













You can select various play modes. However, for voice file playback, only NORMAL, REPEAT ONE and REPEAT ALL are selectable.





Types of playback modes

-  **NORMAL**
Normal play
-  **REPEAT ONE**
Repeats one track.
-  **REPEAT ALL**
Repeats all tracks.
-  **RANDOM**
Plays all tracks in random order.
-  **RANDOM RPT**
Repeats all tracks in random order.
-  **INTRO**
Plays first 10 seconds for each tracks.

To select play mode

1. After turning on the player, press **MENU** button and  /  button to select **SET** mode from Main Menu, and then press  /  button to enter that mode.
2. Press  /  button to select "PLAYMODE".
3. Press  /  button.
4. Press  /  button to select the play mode.
5. Press  /  button to return to SET MENU.

To exit SET mode:

Press **MENU** button (or select "EXIT" and press  /  button) in the SET MENU.

SLEEP TIMER

Use the sleep timer to turn off the player after a certain period of time during playback. You can set the period of time to 15, 30, 45, 60 minutes, or OFF (default). The sleep timer works temporarily. Once it has worked, it is canceled. When the sleep timer is set, the sleep timer icon () appears on the upper right of the display.

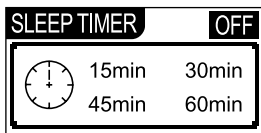

To set sleep timer

1. After turning on the player, press **MENU** button and **▶▶/|◀◀** button to select **SET** mode from Main Menu, and then press **▶/||** button to enter that mode.
2. Press **▶▶/|◀◀** button to select "SLEEP TIMER".
3. Press **▶/||** button.
4. Press **▶▶/|◀◀** button to select the time.
5. Press **▶/||** button to return to SET MENU.

To exit SET mode:

Press **MENU** button (or select "EXIT" and press **▶/||** button) in the SET MENU.

AUTO POWER OFF

Use the auto power off to turn off the player after a certain period of time when no operation is made. You can set the period of time to 2, 5, or 10 minutes, or OFF (default).

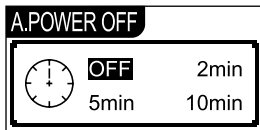

To set auto power off

1. After turning on the player, press **MENU** button and **▶▶|/|◀◀** button to select **SET** mode from Main Menu, and then press **▶/||** button to enter that mode.
2. Press **▶▶|/|◀◀** button to select "A.POWER OFF".
3. Press **▶/||** button.
4. Press **▶▶|/|◀◀** button to select the time.
5. Press **▶/||** button to return to SET MENU.

To exit SET mode:

Press **MENU** button (or select "EXIT" and press **▶/||** button) in the SET MENU.

BACKLIGHT

Use to adjust the backlighting extension time (0 to Max) after finishing the last operation. (Default: 5 seconds) When “Max” is set, the backlighting remains on for approx. two hours.



To set back light

1. After turning on the player, press **MENU** button and **▶▶|/|◀◀** button to select **SET** mode from Main Menu, and then press **▶/||** button to enter that mode.
2. Press **▶▶|/|◀◀** button to select “BACKLIGHT”.
3. Press **▶/||** button.
4. Press **▶▶|/|◀◀** button to select the time.
5. Press **▶/||** button to return to SET MENU.

To exit SET mode:

Press **MENU** button (or select “EXIT” and press **▶/||** button) in the SET MENU.

NOTE

- When “Low Battery” appears, backlighting goes out and, after that, it does not light again.

CONTRAST

Use to adjust the contrast of the display.



To set contrast

1. After turning on the player, press **MENU** button and **▶▶| / |◀◀** button to select **SET** mode from Main Menu, and then press **▶/||** button to enter that mode.
2. Press **▶▶| / |◀◀** button to select “CONTRAST”.
3. Press **▶/||** button.
4. Press **▶▶| / |◀◀** button to select the level.
5. Press **▶/||** button to return to SET MENU.

To exit SET mode:

Press **MENU** button (or select “EXIT” and press **▶/||** button) in the SET MENU.

RECORD SET

For external equipment input (LINE), set bit rate, A.TRK, etc. during recording.

Source	LINE
Encode	(MP3 Stereo)
Bit Rate	96kbps, 128kbps, 160kbps
A. TRK	ON, OFF

Source : LINE
Encode : MP3 Stereo
BitRate : 128kbps
A.TRK : ON

To set recording

1. After turning on the player, press **MENU** button and **▶▶| / |◀◀** button to select **SET** mode from Main menu, and then press **▶/||** button to enter that mode.
2. Press **▶▶| / |◀◀** button to select "RECORD SET".
3. Press **▶/||** button.
4. Press **▶▶| / |◀◀** button to select item (Bit Rate or A.TRK).
5. Press **▶/||** button to select the desired content from the selected item.
6. Repeat the steps from 4 to 5, as necessary.
7. Press **MENU** button to return to the **SET** mode.

To exit SET mode:

Press **MENU** button (or select "EXIT" and press ►/|| button) in the SET MENU.

Bit Rate:

Indicates information content of the compressed data per second. As the bit rate is higher, the audio quality becomes higher, but the data amount increases.

Auto Track (A.TRK):

You can select ON or OFF of the A. TRK when you record music from the input of the external audio equipment. When ON is selected, the A. TRK detects each track automatically and numbers each track. When the music starts, the A. TRK starts recording and when the music stops, the A. TRK detects silence and the player pauses. When OFF is selected, no track is detected and recording doesn't stop if the player is in silent state. When silent state continues for 3 seconds or more in LINE-IN mode, the A. TRK judges this state as a turn of the track and the track is divided. The track, therefore, is not divided in this mode if the interval of two tracks is too short, or noise continuously occurs in the interval. In addition, if a track has very low sound or silent part, the track is divided.

In such cases, select OFF for A. TRK from "RECORD SET" in the SET mode and record each track manually.

MENU LANGUAGES

Use to set the language for the menu. You can select English (default), simplified Chinese or traditional Chinese.



To set menu language

1. After turning on the player, press **MENU** button and **▶▶| / |◀◀** button to select **SET** mode from Main Menu, and then press **▶/||** button to enter that mode.
2. Press **▶▶| / |◀◀** button to select "MENU LANG".
3. Press **▶/||** button.
4. Press **▶▶| / |◀◀** button to select the language.
5. Press **▶/||** button to return to SET MENU.

To exit SET mode:

Press **MENU** button (or select "EXIT" and press **▶/||** button) in the SET MENU.

FONTS

Use to set the language for the file name and ID3 tags. You can select one of 27 languages (default: English).



To set fonts

1. After turning on the player, press **MENU** button and **▶▶| / |◀◀** button to select **SET** mode from Main Menu, and then press **▶/||** button to enter that mode.
2. Press **▶▶| / |◀◀** button to select "FONTS".
3. Press **▶/||** button.
4. Press **▶▶| / |◀◀** button to select the fonts.
5. Press **▶/||** button to return to SET MENU.

To exit SET mode:

Press **MENU** button (or select "EXIT" and press **▶/||** button) in the SET MENU.

NOTE

- For details of ID3 tags, see page 9.

ABOUT

Use to display firmware version and status of the player.

About

VER: X.XXXX

INT: 1 GB

FREE: 52 MB

Amount of memory installed

Available memory space to store further music files

To display:

After turning on the player, press **MENU** button and **▶▶ / ◀◀** button to select **ABOUT** mode from Main Menu, and then press **▶/||** button to enter that mode.

To exit ABOUT mode: Press **MENU** button.

Upgrading firmware version:

To upgrade the firmware of your player, please visit our website.

RESETTING THE UNIT

Use to reset all the settings you have made to default.

RESET?

Menu:Cancel Play:sure

To reset the unit

1. After turning on the player, press **MENU** button and **▶▶/◀◀** button to select **RESET** mode from Main Menu, and then press **▶/||** button to enter that mode.
2. Press **▶/||** button to reset the unit.
All the settings are reset and “RESET OK!” appears.

To cancel and exit RESET mode: Press **MENU** button.

Default value of each SET MENU item:

EQ SET	Normal
PLAYMODE	Normal
SLEEP TIMER	OFF
A.POWER OFF	OFF
BACKLIGHT	5 Sec
CONTRAST	Factory-set level
RECORD SET	Bit Rate : 128kbps A.TRK : ON
MENU LANG	ENGLISH
FONTS	ENGLISH

NAVIGATE

Use to display the hierarchical tree structure of music folders and files (🎵). From this tree structure, you can easily locate a desired music file and play it back.



To locate a music file

1. After turning on the player, press **MENU** button and **▶▶| / |◀◀** button to select **NAVIGATE** mode from Main Menu, and then press **▶/||** button to enter that mode.
2. Press **▶▶| / |◀◀**, **▶/|| / ■** buttons to locate the desired file.
 - ▶▶| / |◀◀ : Moves the cursor (highlight) vertically. The cursor scrolls through the files and folders in the selected folder.
 - ▶/|| / ■ : 1) Move the cursor to the desired folder and press **▶/||** button to open it. Then, the files in the folder can be selected.
 - 2) When the cursor is inside the folder, press **■** button to close the folder. Then, the hierarchical structure appears including that folder.
3. Press **▶/||** button to play it back.
(Press **▶/||** button to pause and **■** button to stop.)

To exit NAVIGATE mode: Press **MENU** button.

NOTE

- When you search the WMA-DRM file which was transferred using the Explorer in NAVIGATE mode, the track names appear. But when you try to playback the music, "DRM PROTECTED" appears, and then the file is skipped over to the next track.

Music file playing order in Music mode:

From the hierarchical tree structure, you can easily understand the playing order of music files when you normally play them in Music mode. You will see that the music files are played back in the order from the higher hierarchy to the lower one.

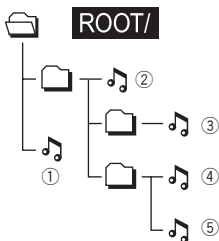

NOTES

- Maximum number of folders that can be recognized by the player is 50.
- Maximum number of hierarchies that can be recognized by the player is 8, including the highest-order folders.
- You can change the playback order of music files by adding numbers at the head of folder names or file names on PC.
(For example, add numbers like 01xxxx, 02yyyy, ...)
- The maximum number of files (WMA, MP3 and WAV files) that can be displayed or operated is 550. On a file exceeding 550, its operation is not guaranteed.

LOCKING BUTTONS (HOLD)

Slide the HOLD switch to the right to lock all controls.

When the hold function is activated, the  appears in the upper right of the display.



To unlock: Slide the HOLD switch to the left.

NOTE

- When the player is turned on with the HOLD switch set to ON position, “HOLD” appears after the initial message “DIGITAL AUDIO PLAYER”. Then, the player automatically shuts off. To use the player, set the HOLD switch to OFF position and turn on the player again.

TROUBLESHOOTING

Problem	Solution
The player does not function.	<ul style="list-style-type: none">• Make sure the HOLD switch is off.• This player provides versatile operations under microcomputer control. If the player cannot be properly operated by pressing any button, remove the battery and insert it again after a while.• Battery may be drained. Replace the battery.
There is no sound or a lot of noise.	<ul style="list-style-type: none">• Make sure the Headphone is correctly connected to the player.• Wipe the Headphone plug with a clean cloth.• Keep the player away from other equipment, such as mobile phones or televisions.• Turn the volume up.
The player suddenly stops working.	<ul style="list-style-type: none">• Take the battery out for about 10 seconds and re-insert it.
The display is too dark or too bright.	<ul style="list-style-type: none">• Adjust the contrast.
The player automatically shuts off.	<ul style="list-style-type: none">• Auto power off function is set in effect. See page 24. (This is not a malfunction.)
Your computer does not recognize the player.	<ul style="list-style-type: none">• If your operating system is Windows 98SE, be sure to install the USB driver from the supplied CD-ROM in your computer.

SPECIFICATIONS

Model Name	XA-MP102	XA-MP52
Type	Digital audio player	
Built-in memory size	1 GB	512 MB
Display	LCD with backlighting (4-line display)	
Music playback format	MP3/WMA/WMA-DRM*1	
Bit rate	MP3: 8 kbps to 320 kbps, WMA: 32 kbps to 192 kbps	
Maximum number of tracks*2	Approx. 500	Approx. 250
Frequency response	60 Hz to 20 kHz, +0 dB to -3 dB (Audio)	
Output terminal	Headphone	
Input terminal	Line in (stereo mini jack)	
Power supply	DC 1.5V "LR03" or "AAA" size battery × 1	
Continuous playback time	Approx. 17 hours (Audio playback)*3	
Dimensions (Approx.)	50 (L) × 15 (W) × 50 (H) mm (excluding protruding parts)	
Mass (Approx.)	30 g (without battery), 42 g (with battery)	

*1 WMA-DRM: A WMA file with reproduction restriction for copyright protection of digital data.

*2 Condition: WMA: 64 kbps, 1 track: 4 minutes.

*3 Condition: MP3 (128 kbs, fs=44.1 kHz) file playback, backlighting OFF, Equalization: normal

Design and specifications are subject to change without notice.

- OS supported: Microsoft® Windows® XP (Home Edition/Professional), Windows® Me, Windows® 2000 Professional, Windows® 98SE*
(* Installation of USB driver is necessary using CD-ROM supplied)

ACCESSORIES

Headphones

USB CABLE

CD-ROM (USB Driver for Windows 98SE)

NECK STRAP

AUDIO CABLE

Information for Users on Disposal of Old Equipment

[European Union]



This symbol indicates that the electrical and electronic equipment should not be disposed of as general household waste at its end-of-life. Instead, the product should be handed over to the applicable collection point for the recycling of electrical and electronic equipment for proper treatment, recovery and recycling in accordance with your national legislation.

By disposing of this product correctly, you will help to conserve natural resources and will help prevent potential negative effects on the environment and human health which could otherwise be caused by inappropriate waste handling of this product. For more information about collection point and recycling of this product, please contact your local municipal office, your household waste disposal service or the shop where you purchased the product.

Attention:

This symbol is only valid in the European Union.

Penalties may be applicable for incorrect disposal of this waste, in accordance with national legislation.

(Business users)

If you wish to dispose of this product, please visit our web page www.jvc-europe.com to obtain information about the take-back of the product.

[Other Countries outside the European Union]

If you wish to dispose of this product, please do so in accordance with applicable national legislation or other rules in your country for the treatment of old electrical and electronic equipment.

JVC



EN

© 2005 Victor Company of Japan, Limited

1005KMMCREBET